

Singer 44-90

Form 19013  
(936)  
Printed in U.S.A.

**LIST**  
OF  
**PARTS**



**MACHINE No. 44-90**

---

**THE SINGER MANUFACTURING COMPANY**

## INSTRUCTIONS FOR OILING

To ensure easy running and prevent unnecessary wear of the parts which are in movable contact, the machine requires oiling and when in continuous use, it should be oiled at least twice each day with Singer Manufacturing Sewing Machine Oil (Cloth and Leather).

Copyright, U. S. A., 1917, 1921, 1933, 1935 and 1936  
by The Singer Manufacturing Co.  
All Rights Reserved for all Countries

## INDEX

	Page
Accessories.....	13
Belt Guard.....	13
Bobbin Winders.....	14
Foot Lifter Parts.....	15
Knee Lifter Parts.....	17
Machine Base.....	13
Machine No. 44-90.....	5
Numerical List of Parts.....	19
Obsolete Parts.....	18
Thread Unwinder.....	18

## INSTRUCTIONS FOR ORDERING

In ordering from this list, use **ONLY** the part **NUMBER** in the **FIRST** column.

The number stamped on a Sewing Machine Part is in every case the number of the single part only.

Every combination of parts sent out as such has its specific number, which, although not stamped on the parts, must be used when ordering the combination.

Each number always indicates the **SAME PART** in whatever list it appears, or for whatever machine.

The letters after some of the numbers indicate the style of finish only, as follows:

A-Hardened, Polished, Nickel Plated and Buffed

B-Polished, Nickel Plated and Buffed

C-Hardened Only

D-Polished Only

E-Soft, Not Polished

F-Hardened and Polished

F.J-Hardened, Polished and Nickel Plated

G-Bright Rumbled and Nickel Plated

H-Blued

J-Nickel Plated Only

K-Hardened and Nickel Plated

L-Brass Plated

M-Oxidized

N-Japanned, Dull

P-Japanned, Bright

R-Merlized

T-Copper Plated

T.A-Hardened, Polished, Copper and Nickel Plated and Buffed

T.B-Copper and Nickel Plated and Polished

T.J-Copper and Nickel Plated Only

T.K-Hardened, Copper and Nickel Plated

T.M-Copper Plated and Oxidized

T.L-Copper and Brass Plated

U-Zinc Plated

V-Silver Plated

W-Polished and Nickel Plated

Y-Black Nickel Plated Only

Z-Chromium Plated

Z.B-Polished, Nickel Plated, Buffed and Chromium Plated

Z.J-Nickel and Chromium Plated

These letters **MUST BE USED** when they appear in the list; and **AFTER** the number as in the list.

In this series:

1 to 1500, 50001 to 51500 and 140001 to 142000 are Screw Numbers

1501 to 1800 and 51501 to 51800 are Nut Numbers

1801 to 2000 and 51801 to 52000 are Roller Numbers

2001 to 50000 and 52001 to 140000 and 142001 to

190000 are Sewing Machine Parts, 190001 and upward

are numbers of Electrical Parts.

The figures in the second column refer only to the plates, illustrating the parts, and are **NOT TO BE USED** in ordering.

Parts marked with an asterisk (\*) are furnished only when repairs are made at factory.

## LIST OF PARTS COMPLETE

FOR

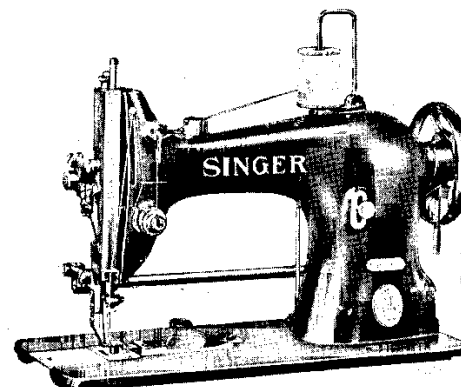

### MACHINE No. 44-90

FOR SEWING GAUGE GLOVES OF LIGHT, MEDIUM AND HEAVY LEATHER. HAS POSITIVE UPPER AND UNDER FEEDING MECHANISM AND ALTERNATING PRESSERS. SPEED 2200 R. P. M.

No.	Plate	Name
*62881	-----	Arm with 11104, 15404 and two 15405.....
8562	8387	" Dowel Pin.....
15783	8387	" Oil Tube.....
12453	8387	" " " for oiling intermediate bearing.....
12454	8387	Arm Oil Tube with 132590, for oiling Thread Take-up Lever Link.....
24131	8387	Arm Oil Tube with 52045, for oiling Feed and Feed Lifting Eccentric...
11119	8387	Arm Oil Tube 15783 with 52045, for oiling Thread Take-up Lever and Needle Bar Crank.....
52045	8387	Arm Oil Tube Packing (wick).....
132590	8387	" " " (wick).....
748E	8387	" Screw (back).....
868E	8387	" " (front).....
18511	22476	" Shaft.....
*11104	-----	" Bushing (front).....
12357	22466	" " Flanged Bushing (back).....
448C	2552	" " " " " Set Screw

## PARTS FOR MACHINE NO. 44-90

No.	Plate	Name
144D	8387	Arm Shaft Screw.....
12193	22466	" Side Cover.....
51224J	8387	" " Thumb Screw.....
24296	22476	Balance Wheel (power) light rim, 2 3/16 in. pulley with two 448C.....
24297	22466	Balance Wheel Oil Cover.....
210D	8387	" " Screw.....
448C	2552	" " Set Screw.....
*62882	-----	Bed.....
20197	22466	Crank Connecting Rod with two 896E.....
896E	8387	" " Cap Screw.....
908C	8387	" " Hinge Screw.....
1619J	8387	" " Nut...
26803	22466	Edge Guide Bed with 2362.....
220J	22467	" " Leveling Screw.....
121148	22466	" " Slide with 26809, 51918 and two 12152.....
26805	22466	Edge Guide Slide Cap (left).....
207J	22467	" " Screw.....
2362	22467	" " Steady Pin..
26806	22466	" " (right).....
207J	22467	" " Screw (large)
233J	22467	" " (small)
26807	22466	" " Lever.....
94D	22467	" " Hinge Screw.....
51916	22467	" " Roller and Screw Stud.
26808	22466	" " Spring.....
26809	22466	" " Cover.....
12152	8387	" " Rivet....
26810	22466	Edge Guide (roller) complete, Nos. 94D, 233J, 26803, 26805 to 26808, 121146, two 207J and four 220J.....
190J	8387	Edge Guide Screw.....
19354	-----	Face Plate.....
*44181	-----	" " Thread Guard (lower).....
12150	8387	" " " " 44181 with 12152.....
12152	8387	Face Plate Thread Guard (lower) Rivet..
45720	22467	" " (upper) with 125373.....
125373	22467	Face Plate Thread Guard (upper) Rivet..
19355	22391	Face Plate complete, Nos. 12150, 19354 and 45720.....
219J	8387	Face Plate Screw.....
12368	22391	Feed Bar.....
313C	8387	" " Screw Center.....
56813	-----	" " " " 313C with 1519J...
1519J	8387	" " Nut.....
3033	22472	" " Connecting Link.....
375C	22467	" " Hinge Screw.....
1518J	22467	" " Nut....

## PARTS FOR MACHINE NO. 44-90

No.	Plate	Name
24952	22473	Feed Dog, 11 teeth (18 teeth to the inch) for 24959.....
208E	22473	Feed Dog Screw.....
20283	22466	" and Feed Lifting Eccentric with 448C.....
446C	8387	Feed and Feed Lifting Eccentric Set Screw.....
127152	22466	Feed and Feed Lifting Eccentric Sleeve.
20284	22391	" Forked Connection.....
375C	22467	" " Hinge Screw.....
1518J	22467	" " Nut..
24969	22476	" Lifting Rock Shaft.....
12376	22466	" " Crank with 157J and 1813.....
157J	22467	Feed Lifting Rock Shaft Crank Clamping Screw.....
1813	22467	Feed Lifting Rock Shaft Crank Roller and Stud.....
24970	-----	Feed Lifting Rock Shaft complete, Nos. 12376 and 24969.....
43976	22391	Feed Lifting Rock Shaft Crank Connect- ing Rod with two 966E.....
966E	22467	Feed Lifting Rock Shaft Crank Connect- ing Rod Cap Screw.....
375C	22467	Feed Lifting Rock Shaft Crank Connect- ing Rod Hinge Screw.....
1518J	22467	Feed Lifting Rock Shaft Crank Connect- ing Rod Hinge Screw Nut.....
307C	22467	Feed Lifting Rock Shaft Screw Center...
56814	-----	" " " " 307C with 1513J.....
1513J	22467	Feed Lifting Rock Shaft Screw Center Nut.....
3039	22466	Feed Regulator.....
1128E	22467	" " Hinge Screw.....
818D	22467	" " Thumb Screw.....
16508	22476	" Rock Shaft.....
62883	-----	" " 16506 with 62884.....
62884	22466	" " Crank with two 172J....
172J	22467	" " Clamping Screw...
307C	22467	" " Screw Center.....
56814	-----	" " " " 307C with 1513J.....
1513J	22467	Feed Rock Shaft Screw Center Nut.....
62885	22476	" (upper) Shaft.....
62886	-----	" " 62885 with 2049 and 62796.....
20249	22468	Feed (upper) Shaft Bracket (back).....
134E	22469	" " " " Screw
24475	22468	" " " " (front).....
171E	22469	" " " " Screw

## PARTS FOR MACHINE NO. 44-90

No.	Plate	Name
20251	22469	Feed (upper) Shaft Collar with 456C....
456C	22469	" " " " Set Screw....
62887	22468	" " " Crank (back) with two 172J.....
172J	22467	Feed (upper) Shaft Crank (back) Clamping Screw.....
62888	22468	Feed (upper) Shaft Crank (back) Connecting Link.....
50582C	22469	Feed (upper) Shaft Crank (back) Connecting Link Hinge Screw.....
1520J	22469	Feed (upper) Shaft Crank (back) Connecting Link Hinge Screw Nut.....
62796	22468	Feed (upper) Shaft Crank (front) with 462C.....
62797	22468	Feed (upper) Shaft Crank (front) Connecting Link.....
62814	-----	Feed (upper) Shaft Crank (front) Connecting Link 62797 with 199D and 62798.....
62798	22468	Feed (upper) Shaft Crank (front) Connecting Link Bracket.....
207J	22467	Feed (upper) Shaft Crank (front) Connecting Link Bracket Screw.....
199D	22469	Feed (upper) Shaft Crank (front) Connecting Link Cap Screw.....
50582C	22469	Feed (upper) Shaft Crank (front) Connecting Link Hinge Screw.....
1520J	22469	Feed (upper) Shaft Crank (front) Connecting Link Hinge Screw Nut.....
2049	22469	Feed (upper) Shaft Crank (front) Pin...
462C	22469	" " " " " Set Screw
12391	22468	Lifting Presser Bar.....
19356	22468	" " " Bell Crank.....
199D	22469	" " " " " Cap Screw
19357	22468	" " " " " Connecting Link.....
199D	22469	Lifting Presser Bar Bell Crank Connecting Link Cap Screw.....
19358	22468	Lifting Presser Bar Bell Crank Driving Arm.....
19362	22468	Lifting Presser Bar Bell Crank Driving Arm Eccentric Connection.....
375C	22467	Lifting Presser Bar Bell Crank Driving Arm Eccentric Connection Hinge Screw.....
1518J	22467	Lifting Presser Bar Bell Crank Driving Arm Eccentric Connection Hinge Screw Nut.....
2049	22469	Lifting Presser Bar Bell Crank Driving Arm Pin.....
19359	22468	Lifting Presser Bar Bell Crank Driving Arm Shaft.....

## PARTS FOR MACHINE NO. 44-90

No.	Plate	Name
19360	22468	Lifting Presser Bar Bell Crank Driving Arm Shaft Bracket.....
19361	-----	Lifting Presser Bar Bell Crank Driving Arm Shaft Bracket complete, Nos. 2049 and 19358 to 19360.....
965D	22469	Lifting Presser Bar Bell Crank Driving Arm Shaft Bracket Screw.....
62799	22468	Lifting Presser Bar Guide Bracket with 453C.....
453C	22469	Lifting Presser Bar Guide Bracket Set Screw.....
62800	-----	Lifting Presser Bar Guide Bracket complete, Nos. 19356, 19357, 62799, 62805 and three 199D.....
24590	22468	Lifting Presser Bar Guide Bracket Support.....
175J	22469	Lifting Presser Bar Guide Bracket Support Screw.....
20240	22468	Lifting Presser Bar Lifter.....
689C	22469	" " " " " Hinge Screw.
1520J	22469	" " " " " " Nut.....
12327	22470	Lifting Presser Bar Lifting and Releasing Lever Bracket.....
11167	22470	Lifting Presser Bar Spring (light) .051 wire.....
Note: No. 11167 is sent with this machine unless another spring is specified on order.		
12139	22470	Lifting Presser Bar Spring (medium) .055 wire.....
20023	22470	Lifting Presser Bar Spring (heavy) .063 wire.....
11170	22469	Lifting Presser Bar Spring Washer.....
62894	22473	" " " Foot.....
190J	8387	" " " Screw.....
19229	22470	Needle Bar (hollow).....
*12382	2552	" " " Connecting Link with 794E...
43997	-----	" " " " 12382 with 12384.....
794E	2552	Needle Bar Connecting Link Adjusting Screw.....
*12383	-----	Needle Bar Connecting Stud.....
1904	2552	" " " " Roller (roller only).....
453C	22469	Needle Bar Connecting Stud Set Screw...
12384	2552	Needle Bar Connecting Stud complete, Nos. 453C, 1904 and 12383.....
62802	22466	Needle Bar Crank and Lifting Eccentric with 448C and 743C.....
62811	-----	Needle Bar Crank and Lifting Eccentric 62802 with 19362.....

No.	Plate	Name
743C	2552	Needle Bar Crank and Lifting Eccentric Position Screw.....
448C	2552	Needle Bar Crank and Lifting Eccentric Set Screw.....
936E	22469	Needle Bar Screw Bushing.....
24101	-----	" Clamp Body.....
808F	22469	" " Screw.....
24102	22469	" " Thread Guide.....
651J	22469	" " " " Screw.....
24103	22469	Needle Clamp (high lift) complete, Nos. 651J, 808F, 24101 and 24102.....
44222	22391	Oil Cup.....
44223	-----	" " 44222 with 44005.....
44214	22391	" " Extension.....
44005	-----	" " " 44214 with 24075.....
24075	22391	" " " Post.....
44006	22391	" " Packing (felt).....
44224	22391	" " Thread Retainer.....
44225	22391	Oil Cup complete, Nos. 44006, 44223 and 44224.....
*24104	22470	Oscillating Rock Shaft.....
12388	22470	" " " Hinge Pin.....
448C	2552	" " " " Set Screw
4784	22487	" " " Oil Pad.....
24105	-----	Oscillating Rock Shaft complete, Nos. 4784, 12388 and 24104.....
62813	22476	Oscillating Shaft.....
62803	-----	" " Crank.....
453C	22469	" " " Set Screw.....
2049	22469	" " " Pin.....
19448	22467	" " " Slide Block....
226J	22487	" " " " Cap Screw.....
12424	22487	Oscillating Shaft Crank Slide Block Cap Screw Washer.....
988C	22467	Oscillating Shaft Crank Slide Block Screw Stud.....
1518J	22467	Oscillating Shaft Crank Slide Block Screw Stud Nut.....
19449	22467	Oscillating Shaft Crank Slide Block complete, Nos. 226J, 988C, 12424 and 19448.....
62804	22467	Oscillating Shaft Crank complete, Nos. 1518J, 19449, 62803 and two 453C....
688J	22391	Pressure Regulating Thumb Screw.....
2996	22471	Shuttle Bobbin.....
15140	22471	" " Case Latch.....
2973	22471	" " " " Lever.....
2974	22471	" " " " Fulcrum Pin.....
2975	22471	Shuttle Bobbin Case Latch Spring.....
592E	22471	" " " " Stop Screw...

No.	Plate	Name
15141	22471	Shuttle Bobbin Case Hinge, Nos. 2973, 2974 and 15140.....
*7553	-----	Shuttle Bobbin Case Position Finger....
2523	22471	" " " " Rivet.....
24412	22470	" " " " Plate.....
391J	22471	" " " " Screw
24074	22471	Shuttle Bobbin Case complete, Nos. 591F, 592E, 2523, 2975, 7553, 15098 and 15141.....
12488	22471	Shuttle Body.....
591F	22471	" Tension Regulating Screw.....
15098	22471	" " Spring.....
62808	22471	" 1 11/16 in. diam., Nos. 2996, 12488 and 24074.....
*24551	-----	Shuttle Driver.....
24552	22470	" " 24551 with two 1266C....
2049	22469	" " Pin.....
1266C	22471	" " Set Screw.....
2531	22470	" Race Back.....
2532	22471	" " Position Pin.....
2533	22470	" " Spring.....
907D	22471	" " " Screw.....
24553	-----	" " Body.....
62511	-----	" " 24553 with 24418 and two 1053J.....
62520	-----	Shuttle Race Body 62511 with two 2532..
24418	22470	" " Cap.....
1053J	22471	" " Screw.....
24554	22470	Shuttle Race complete, Nos. 907D, 2531, 2533, 24412, 62520 and two 391J....
145E	22471	Shuttle Race Screw.....
12431	-----	" " Slide.....
4307	22470	" " " Spring.....
725E	22471	" " " " Screw.....
12432	22470	Shuttle Race Slide complete, Nos. 4307, 12431 and two 725E.....
52046	22478	Spool Holder Base.....
399J	22469	" " " Screw.....
204296	22478	" " Wire.....
200079H	22469	" " Hinge Screw.....
52047	22478	Spool Holder complete, Nos. 52046, 200079H and 204296.....
2102	3471	Tension Disc.....
1580C	22472	" Regulating Thumb Nut.....
32572	22472	" Releasing Disc.....
43944	22478	" " Lever.....
12398	22472	" " " Hinge Pin.....
12329	22472	" " " Spring.....
32574	22472	" " Pin.....
50327C	22472	" Screw Stud.....
44141	-----	" " 50327C with 1580C...
43945	22472	" Spring.....

## PARTS FOR MACHINE NO. 44-90

No.	Plate	Name
12149	2552	Tension Thread Guard.....
44118	-----	Tension complete, Nos. 7338, 32572, 32574, 43945, 43946, 44141 and two 2102....
52027	22472	Thread Guard (side of arm).....
52454	22472	" Retainer.....
624C	22472	" " Set Screw.....
12404	2552	" Take-up Crank.....
3094	2552	" " Wedge.....
890E	2552	" " " Screw.....
12408	2552	" " Lever.....
775E	22472	" " Cap Screw.....
12166	22472	" " Hinge Pin.....
12409	2552	" " Link.....
11204	22478	" " " Hinge Pin....
435C	22472	" " " " " Set Screw.....
12410	-----	Thread Take-up Lever complete, Nos. 12166 12408 and 12409.....
43946	2552	Thread Take-up Spring.....
7338	22472	" " " Regulator.....
448C	2552	" " " Set Screw
24959	22473	Throat Plate for 24952.....
691F	22473	" " Screw.....
62805	22478	Vibrating Presser Bar.....
19367	22472	" " Cap.....
199D	22469	" " " Screw for 62805.....
219J	8387	Vibrating Presser Bar Cap Screw for 19367.....
50385C	22472	Vibrating Presser Bar Tension Screw....
62806	22472	" " " Bracket et.....
335J	22472	Vibrating Presser Bar Tension Screw Bracket Screw.....
1695J	22472	Vibrating Presser Bar Tension Screw Lock Nut.....
62895	22473	Vibrating Presser Foot.....
217J	22473	" " " Screw.....
*15404	-----	Trade Mark.....
15405	-----	" Rivet.....
24079	8407	Drip Pan.....

## MACHINE BASE

No.	Plate	Name
24106	22474	Bed Frame Cushion (felt).....
158E	22474	" " " Screw.....
24107	22474	" " Hinge Connection.....
9281	22474	" " " Pin.....
970D	22474	" " Thumb Screw.....
24108	8408	Bed Frame complete, Nos. 970D, two each 9281, 24107, four each 158E, 24106 and six wood screws 1 1/4 in. No. 12.....
24908	8407	Drip Pan with two wood screws 1/2 in. No. 5 R.H.B., for 24108.....

## ACCESSORIES

No.	Plate	Name
51075E	22474	Machine Hinge Bolt with 51581E.....
51581E	22474	" " " Nut.....
6055	22474	" " " Washer.....
12361	22474	" " Connection.....
44139	22474	" " Plate.....
44140	-----	Machine Hinge complete, Nos. 12361, 44139 and merlized wood screw 1 1/4 in. No. 14.....
44160	-----	Machine Hinge complete, Nos. 6055, 12361, 44139 and 51075E.....
12405	22474	Machine Rest (felt).....
41400	22477	" Pin (wood) 3 1/8 in. long.
120342	22477	Oiler (copper plated) with 120343.....
120343	22477	" Spout, 3 1/2 in. long.....
26026	22477	Screw Driver (machine).....
26485	22477	" " (shuttle tension).....
4822	22477	Wrench for 1521.....
8908	22477	" " 1519 and 1520.....
8909	22477	" " 1513, 1518 and 51581.....
19221	22477	" " 936 and 1619.....

## BELT GUARD

No.	Plate	Name
41929	8408	Belt Guard.....
8418	22474	" " Button.....
8419	22474	" " " Washer (leather).....



## BELT GUARD

No.	Plate	Name
8420	-----	Belt Guard Button 8418 with 8419 and wood screw 1 1/4 in. No. 9 R.H.B....
41930	22474	Belt Guard Hinge.....
41931	-----	Belt Guard complete, Nos. 8420, 41929, two 41930 and four wood screws 3/4 in. No. 9.....

## BOBBIN WINDERS

## BOBBIN WINDER

(SWINGING AUTOMATIC, RIGHT HAND)

FOR 2996

FOR POWER TABLE

No.	Plate	Name
225433	8406	Bobbin Winder and Tension Bracket Base.
225453	22395	Frame with 202277 and 225438.....
225454	3471	" Hinge Pin.....
202277	3471	" Oil Packing (wick).....
225438	3471	" " Well Cap.....
225455	3471	" Spring.....
225456	3471	" Plunger.....
202473	8406	Pulley with 200380C.....
200380C	3471	" Set Screw.....
225381	22395	Spindle.....
225444	3471	Stop Latch.....
200056E	3471	" " Screw.....
225458	3471	" " Thumb Lever.....
225459	3471	" " " " Hinge Stud.....
225459	3471	" " " " Joint Stud.....
202478	3471	" " Trip Lever.....
200299H	3471	" " " " Hinge Screw.....
225461	3471	Tension Bracket with 201499B.....
200082D	3471	" " Screw.....
228026	22475	" " Washer.....
2102	3471	" Disc.....
202407	3471	" Spring.....
201499B	3471	" Stud.....
201572B	3471	" " Thumb Nut.....
225462	-----	Tension Bracket complete, Nos. 201572B, 202407, 225461 and two 2102.....
225382	8406	Bobbin Winder (swinging automatic, right hand) complete, Nos. 200056E, 200082D, 200299H, 202473, 202478, 225381, 225433, 225444, 225453 to 225456, 225458, 225462, 228026, two each 225459 and wood screws 3/4 in. No. 12 R.H.B.....

## BOBBIN WINDER

(SWINGING AUTOMATIC, RIGHT HAND)

FOR 2996

FOR STAND

No.	Plate	Name
27540	22395	Base.....
15072	22475	Bobbin Position Pin.....
27302	22395	Frame.....
50356D	22475	" Hinge Screw.....
1620J	22475	" " Nut.....
27303	22475	" Spring.....
27541	22395	Pulley.....
*27849	-----	Spindle.....
27538	22395	" 27849 with 15072, 27850 and 41828
*27850	-----	" Collar.....
41828	22475	" " Pin.....
27306	22395	Spool Pin.....
27307	22395	" Stand.....
27308	22395	Spool Stand complete, Nos. 418E, 1562J, 2106, 10141, 11241, 27306, 27307, two each 2455 and wood screws 1 in. No. 10.....
11241	22395	Spool Washer (cloth).....
27312	22395	Stop Latch.....
35D	22475	" " Hinge Screw.....
2455	22475	Tension Disc.....
1562J	22475	" Regulating Thumb Nut.....
418E	22475	" Screw Stud.....
10141	22475	" Spring.....
2106	22475	" Thread Guide.....
27647	22395	Bobbin Winder, Nos. 35D, 1620J, 27302, 27303, 27312, 27538, 27540, 27541, 50356D and two wood screws 1 in. No. 7.....
27544	-----	Bobbin Winder (swinging automatic, right hand) complete, Nos. 27308 and 27647

## FOOT LIFTER PARTS

No.	Plate	Name
5596	22478	Bell Crank.....
56848	-----	" " 5596 with 5599 and 5801.....
5599	22478	" " Bracket.....
178E	22475	" " Screw.....
5801	22475	" " Hinge Pin.....
5735	22478	" " Spring.....

## FOOT LIFTER PARTS

No.	Plate	Name
5598	22478	Bell Crank complete, Nos. 5735 and 58848.
5870	-----	Chain, length 28 in. to 35 in. with 58864 and 58865.....
Note: When ordering No. 5870, state length required.		
4879	22478	Chain Connecting Link.....
58864	22478	" Hook (large).....
58865	22478	" " (small).....
19371	22478	Lifting Lever with 448C.....
20255	22478	" " Connecting Rod.....
12416	22478	" " " " Joint.....
76D	22475	" " " " " Hinge Screw.....
1521J	22475	Lifting Lever Connecting Rod Lock Nut..
802D	22475	" " Hinge Screw.....
21301	22478	" " Link.....
766D	22475	" " Hinge Screw.....
19372	22478	" " Pin.....
448C	2552	" " Set Screw.....
2763	8406	Rock Shaft.....
12242	22476	" " Hanger with two wood screws 1 in. No. 10.....
8337	8406	Rock Shaft Lifting Bracket with two 356C.....
12243	8406	Rock Shaft Lifting Bracket Hook for 5598.....
7125	8406	Rock Shaft Lifting Bracket Hook for 5870.....
356C	22475	Rock Shaft Lifting Bracket Hook Set Screw.....
356C	22475	Rock Shaft Lifting Bracket Set Screw...
2770	8406	" " Stop Dog with 356C.....
356C	22475	" " " " Set Screw.....
4880	8406	Rock Shaft complete, Nos. 2763, 2770, 7125, 12243 and two each 8337 and 12242.
4881	8406	Treadle.....
4882	22478	" Shaft.....
4883	22478	" Spring.....
4884	8406	" Stand.....
4885	8406	Treadle complete, Nos. 4879, 4881 to 4884 and two wood screws 1 in. No. 16..
62897	-----	Foot Lifter complete, Nos. 76D, 766D, 802D, 1521J, 4880, 4885, 5598, 5870, 12416, 19371, 19372, 20255, 21301 and two 178E.....

## KNEE LIFTER PARTS

No.	Plate	Name
5598	22478	Bell Crank.....
58848	-----	" " 5598 with 5599 and 5801.....
5599	22478	" " Bracket.....
178E	22475	" " " Screw.....
5801	22475	" " Hinge Pin.....
5735	22478	" " Spring.....
5598	22478	Bell Crank complete, Nos. 5735 and 58848.
19371	22478	Lifting Lever with 448C.....
20255	22478	" " Connecting Rod.....
12416	22478	" " " " Joint.....
76D	22475	" " " " " Hinge Screw.....
1521J	22475	Lifting Lever Connecting Rod Lock Nut..
802D	22475	" " Hinge Screw.....
21301	22478	" " Link.....
766D	22475	" " Hinge Screw.....
19372	22478	" " Pin.....
448C	2552	" " Set Screw.....
2763	8406	Rock Shaft.....
12242	22476	" " Hanger with two wood screws 1 in. No. 10.....
2765	8406	Rock Shaft Knee Arm.....
2766	8406	" " " " Hub with 356C.....
356C	22475	" " " " Set Screw.....
2768	-----	" " " " 2765 with 2766 and 2767.....
2767	8406	Rock Shaft Knee Plate with 356C.....
356C	22475	" " " " Set Screw.....
8337	8406	" " Lifting Bracket with two 356C.....
2778	8406	Rock Shaft Lifting Bracket Hook.....
356C	22475	" " " " Set Screw.....
356C	22475	" " " " Set Screw...
2770	8406	" " Stop Dog with 356C.....
356C	22475	" " " " Set Screw.....
2777	8406	Rock Shaft complete, Nos. 2763, 2768, 2770, 2778, 8337 and two 12242.....
24482	-----	Knee Lifter complete (power table) Nos. 76D, 766D, 802D, 1521J, 2777, 5598, 12416, 19371, 19372, 20255, 21301 and two 178E.....

## THREAD UNWINDER

FOR ONE LARGE SPOOL OR ONE LARGE CONE OF THREAD

No.	Plate	Name
225259	8405	Spool Rest with 201018C.....
150203	8405	" " Cushion (felt).....
225388	8405	" " Rod.....
200383C	22475	" " Set Screw.....
201018C	22475	" " Set Screw.....
202490	8405	" Stand with 200383C.....
225391	8405	Thread Guide.....
201696J	22475	" " Lock Nut.....
225326	22475	" " Position Cup.....
225324	8405	" " Rod with 208E and 225322..
208E	22473	" " Screw.....
225322	22475	" " Washer.....
225260	8405	Thread Unwinder complete, Nos. 150203, 201696J, 202490, 225259, 225324, 225326, 225388, 225391 and three wood screws 7/8 in. No. 12.....
27739	8405	Thread Cone (wood) for large cones.....
225390	8405	" " Holder, for inverted cones.

Note: Nos. 27739 and 225390 are used with, but not included in 225260.

## OBSOLETE PARTS

No.	Plate	Name
288D	-----	Arm Side Cover Thumb Screw, use 51224J..
36760	-----	Edge Guide Slide with 26809, 51809 and two 12152, use 121146.....
51809	-----	Edge Guide Slide Roller and Stud for 36760.....
2827	8387	Face Plate Thread Guard (upper) with 8505, use 45720.....
8505	8387	Face Plate Thread Guard (upper) Rivet for 2827.....
24038	-----	Feed and Feed Lifting Eccentric Sleeve, use 127152.....
62801	-----	Lifting Presser Foot, use 62894.....
62807	-----	Vibrating Presser Foot, use 62895.....

## NUMERICAL LIST OF PARTS

No.	Plate	Name
35D	22475	Bobbin Winder Stop Latch Hinge Screw for 27647.....
76D	22475	Lifting Lever Connecting Rod Joint Hinge Screw for 24482 and 62897...
94D	22467	Edge Guide Slide Lever Hinge Screw for 26810.....
134E	22469	Feed (upper) Shaft Bracket (back), Screw.....
144D	8387	Arm Shaft Screw.....
145E	22471	Shuttle Race Screw.....
157J	22487	Feed Lifting Rock Shaft Crank Clamping Screw for 12376.....
158E	22474	Bed Frame Cushion Screw for 24108.....
171E	22469	Feed (upper) Shaft Bracket (front) Screw.....
172J	22467	Feed Rock Shaft Crank Clamping Screw for 62884.....
172J	22467	Feed (upper) Shaft Crank (back) Clamp- ing Screw for 62887.....
175J	22469	Lifting Presser Bar Guide Bracket Sup- port Screw.....
178E	22475	Bell Crank Bracket Screw for 24482 and 62697.....
190J	8387	Edge Guide Screw.....
190J	8387	Lifting Presser Foot Screw.....
199D	22469	Feed (upper) Shaft Crank (front) Con- necting Link Cap Screw for 62814..
199D	22469	Lifting Presser Bar Bell Crank Cap Screw for 62800.....
199D	22469	Lifting Presser Bar Bell Crank Connect- ing Link Cap Screw for 62800.....
199D	22469	Vibrating Presser Bar Cap Screw for 62800 and 62805.....
207J	22467	Edge Guide Slide Cap (left) Screw for 26810.....
207J	22467	Edge Guide Slide Cap (right) Screw (large) for 26810.....
207J	22467	Feed (upper) Shaft Crank (front) Con- necting Link Bracket Screw.....
208E	22473	Feed Dog Screw.....
208E	22473	Thread Unwinder Thread Guide Rod Screw for 225324.....
210D	8387	Balance Wheel Oil Cover Screw.....
217J	22473	Vibrating Presser Foot Screw.....
219J	8387	Face Plate Screw.....
219J	8387	Vibrating Presser Bar Cap Screw for 19367.....
220J	22467	Edge Guide Leveling Screw for 26810....

## NUMERICAL LIST OF PARTS

No.	Plate	Name
226J	22467	Oscillating Shaft Crank Slide Block Cap Screw for 19449.....
233J	22467	Edge Guide Slide Cap (right) Screw (small) for 26810.....
288D	-----	Arm Side Cover Thumb Screw, obsolete, use 51224J.....
307C	22467	Feed Lifting Rock Shaft Screw Center for 56814.....
307C	22467	Feed Rock Shaft Screw Center for 56814.
313C	8387	" Bar Screw Center for 56813.....
335J	22472	Vibrating Presser Bar Tension Screw Bracket Screw.....
356C	22475	Rock Shaft Knee Arm Hub Set Screw for 2786.....
356C	22475	Rock Shaft Knee Plate Set Screw for 2787.....
356C	22475	Rock Shaft Lifting Bracket Hook Set Screw for 6337.....
356C	22475	Rock Shaft Lifting Bracket Set Screw for 6337.....
356C	22475	Rock Shaft Stop Dog Set Screw for 2770.
375C	22467	Feed Connecting Link Hinge Screw.....
375C	22467	" Forked Connection Hinge Screw.....
375C	22467	" Lifting Rock Shaft Crank Connecting Rod Hinge Screw.....
375C	22467	Lifting Presser Bar Bell Crank Driving Arm Eccentric Connection Hinge Screw.....
389J	22469	Spool Holder Base Screw.....
391J	22471	Shuttle Bobbin Case Position Plate Screw for 24554.....
418E	22475	Bobbin Winder Tension Screw Stud for 27308.....
435C	22472	Thread Take-up Lever Link Hinge Pin Set Screw.....
446C	8387	Feed and Feed Lifting Eccentric Set Screw for 20283.....
448C	2552	Arm Shaft Flanged Bushing (back) Set Screw.....
448C	2552	Balance Wheel Set Screw for 24296.....
448C	2552	Lifting Lever Pin Set Screw for 19371..
448C	2552	Needle Bar Crank and Lifting Eccentric Set Screw for 62802.....
448C	2552	Oscillating Rock Shaft Hinge Pin Set Screw.....
448C	2552	Thread Take-up Spring Regulator Set Screw.....
453C	22469	Lifting Presser Bar Guide Bracket Set Screw for 62799.....
453C	22469	Needle Bar Connecting Stud Set Screw for 12384.....

## NUMERICAL LIST OF PARTS

No.	Plate	Name
453C	22469	Oscillating Shaft Crank Set Screw for 62804.....
456C	22469	Feed (upper) Shaft Collar Set Screw for 20251.....
462C	22469	Feed (upper) Shaft Crank (front) Set Screw for 62796.....
591F	22471	Shuttle Tension Regulating Screw for 24074.....
592E	22471	Shuttle Bobbin Case Latch Stop Screw for 24074.....
624C	22472	Thread Retainer Set Screw.....
651J	22469	Needle Clamp Thread Guide Screw for 24103.....
688J	22391	Pressure Regulating Thumb Screw.....
689C	22469	Lifting Presser Bar Lifter Hinge Screw.
690E	2552	Thread Take-up Crank Wedge Screw.....
691F	22473	Throat Plate Screw.....
725E	22471	Shuttle Race Slide Spring Screw for 12432.....
743C	2552	Needle Bar Crank and Lifting Eccentric Position Screw for 62802.....
748E	8387	Arm Screw (back).....
766D	22475	Lifting Lever Link Hinge Screw for 24482 and 62697.....
775E	22472	Thread Take-up Lever Cap Screw.....
794E	2552	Needle Bar Connecting Link Adjusting Screw for 12382.....
802D	22475	Lifting Lever Hinge Screw for 24482 and 62697.....
808F	22469	Needle Clamp Screw for 24103.....
818D	22467	Feed Regulator Thumb Screw.....
868E	8387	Arm Screw (front).....
896E	8387	Crank Connecting Rod Cap Screw for 20197.....
907D	22471	Shuttle Race Back Spring Screw for 24554.....
908C	8387	Crank Connecting Rod Hinge Screw.....
936E	22469	Needle Bar Screw Bushing.....
965D	22469	Lifting Presser Bar Bell Crank Driving Arm Shaft Bracket Screw.....
966E	22467	Feed Lifting Rock Shaft Crank Connecting Rod Cap Screw for 43976.....
970D	22474	Bed Frame Thumb Screw for 24108.....
989C	22467	Oscillating Shaft Crank Slide Block Screw Stud for 19449.....
1053J	22471	Shuttle Race Cap Screw for 62511.....
1128E	22467	Feed Regulator Hinge Screw.....
1266C	22471	Shuttle Driver Set Screw for 24552.....
1513J	22467	Feed Lifting Rock Shaft Screw Center Nut for 56814.....
1513J	22467	Feed Rock Shaft Screw Center Nut for 56814.....

## NUMERICAL LIST OF PARTS

No.	Plate	Name
1518J	22467	Feed Connecting Link Hinge Screw Nut....
1518J	22467	" Forked Connection Hinge Screw Nut..
1518J	22467	" Lifting Rock Shaft Crank Connecting Rod Hinge Screw Nut.....
1518J	22467	Lifting Presser Bar Bell Crank Driving Arm Eccentric Connection Hinge Screw Nut.....
1518J	22467	Oscillating Shaft Crank Slide Block Screw Stud Nut for 62804.....
1519J	8387	Feed Bar Screw Center Nut for 56813.....
1520J	22469	" (upper) Shaft Crank (back) Connecting Link Hinge Screw Nut.....
1520J	22469	Feed (upper) Shaft Crank (front) Connecting Link Hinge Screw Nut.....
1520J	22469	Lifting Presser Bar Lifter Hinge Screw Nut.....
1521J	22475	Lifting Lever Connecting Rod Lock Nut for 24482 and 62697.....
1560C	22472	Tension Regulating Thumb Nut for 44141..
1562J	22475	Bobbin Winder Tension Regulating Thumb Nut for 27308.....
1619J	8387	Crank Connecting Rod Hinge Screw Nut....
1620J	22475	Bobbin Winder Frame Hinge Screw Nut for 27647.....
1695J	22472	Vibrating Presser Bar Tension Screw Lock Nut.....
1813	22467	Feed Lifting Rock Shaft Crank Roller and Stud for 12376.....
1904	2552	Needle Bar Connecting Stud Roller (roller only) for 12384.....
2049	22469	Feed (upper) Shaft Crank (front) Pin for 62886.....
2049	22469	Lifting Presser Bar Bell Crank Driving Arm Pin for 19361.....
2049	22469	Oscillating Shaft Crank Pin.....
2049	22469	Shuttle Driver Pin.....
2102	3471	Bobbin Winder Tension Disc for 225462...
2102	3471	Tension Disc for 44118.....
2106	22475	Bobbin Winder Tension Thread Guide for 27308.....
2362	22467	Edge Guide Slide Cap (left) Steady Pin for 26803.....
2455	22475	Bobbin Winder Tension Disc for 27308....
2523	22471	Shuttle Bobbin Case Position Finger Rivet for 24074.....
2531	22470	Shuttle Race Back for 24554.....
2532	22471	" " " Position Pin for 62520
2533	22470	" " " Spring for 24554.....
2763	8406	Rock Shaft for 2777 and 4880.....
2765	8406	" " " Knee Arm for 2768.....
2766	8406	" " " Hub with 356C for 2768.....

## NUMERICAL LIST OF PARTS

No.	Plate	Name
2767	8406	Rock Shaft Knee Plate with 356C, for 2768.....
2768	-----	Rock Shaft Knee Arm 2765 with 2766 and 2767, for 2777.....
2770	8406	Rock Shaft Stop Dog with 356C, for 2777 and 4880.....
2777	8406	Rock Shaft complete for 24482, Nos. 2763, 2768, 2770, 2778, 6337 and two 12242.
2778	8406	Rock Shaft Lifting Bracket Hook for 2777.....
2827	8387	Face Plate Thread Guard (upper) with 8505, obsolete, use 45720.....
2973	22471	Shuttle Bobbin Case Latch Lever for 15141.....
2974	22471	Shuttle Bobbin Case Latch Lever Fulcrum Pin for 15141.....
2975	22471	Shuttle Bobbin Case Latch Spring for 24074.....
2998	22471	Shuttle Bobbin for 62808.....
3033	22472	Feed Connecting Link.....
3039	22466	" Regulator.....
3094	2552	Thread Take-up Crank Wedge.....
4307	22470	Shuttle Race Slide Spring for 12432....
4784	22467	Oscillating Rock Shaft Oil Pad for 24105.....
4822	22477	Wrench for 1521 (Accessories).....
4879	22478	Chain Connecting Link for 4885.....
4880	8406	Rock Shaft complete for 62697, Nos. 2763, 2770, 7125, 12243 and two each 6337 and 12242.....
4881	8406	Treadle for 4885.....
4882	22478	" Shaft for 4885.....
4883	22478	" Spring for 4885.....
4884	8406	" Stand for 4885.....
4885	8406	Treadle complete for 62697, Nos. 4879, 4881 to 4884 and two wood screws 1 in. No. 16.....
5596	22478	Bell Crank for 56848.....
5598	22478	Bell Crank complete for 24482 and 62697 Nos. 5735 and 56848.....
5599	22478	Bell Crank Bracket for 56848.....
5601	22475	" " " Hinge Pin for 56848.....
5670	-----	Chain, length 26 in. to 35 in. with 56864 and 56865, for 62697.....
5735	22478	Bell Crank Spring for 5598.....
6055	22474	Machine Hinge Bolt Nut Washer for 44180 (Accessories).....
6337	8406	Rock Shaft Lifting Bracket with two 356C, for 2777 and 4880.....
7125	8406	Rock Shaft Lifting Bracket Hook for 4880 and 5670.....

## NUMERICAL LIST OF PARTS

No.	Plate	Name
7336	22472	Thread Take-up Spring Regulator for 44118.....
*7553	----	Shuttle Bobbin Case Position Finger for 24074.....
8418	22474	Belt Guard Button for 8420.....
8419	22474	" " " Washer (leather) for 8420.....
8420	----	Belt Guard Button 8418 with 8419 and wood screw 1 1/4 in.No.9 R.H.B., for 41931.....
8505	8387	Face Plate Thread Guard (upper) Rivet for 2827, obsolete.....
8582	8387	Arm Dowel Pin.....
8908	22477	Wrench for 1519 and 1520 (Accessories).
8909	22477	" " 1513,1518 and 51581 (Accessories).....
9261	22474	Bed Frame Hinge Connection Pin for 24108.....
10141	22475	Bobbin Winder Tension Spring for 27308.
*11104	----	Arm Shaft Bushing (front) for 62881....
11119	8387	" Oil Tube 15783 with 52045, for oiling Thread Take-up Lever and Needle Bar Crank.....
11167	22470	Lifting Presser Bar Spring (light) .051 wire.....
11170	22469	Lifting Presser Bar Spring Washer.....
11204	22478	Thread Take-up Lever Link Hinge Pin....
11241	22395	Bobbin Winder Spool Washer (cloth) for 27308.....
12139	22470	Lifting Presser Bar Spring (medium).055 wire.....
12149	2552	Tension Thread Guard.....
12150	8387	Face Plate Thread Guard (lower) 44181 with 12152, for 19355.....
12152	8387	Edge Guide Slide Spring Cover Rivet for 38760 and 121148.....
12152	8387	Face Plate Thread Guard (lower) Rivet for 12150.....
12186	22472	Thread Take-up Lever Hinge Pin for 12410.....
12193	22466	Arm Side Cover.....
12242	22478	Rock Shaft Hanger with two wood screws 1 in.No.10, for 2777 and 4880.....
12243	8406	Rock Shaft Lifting Bracket Hook for 4880 and 5598.....
12327	22470	Lifting Presser Bar Lifting and Releasing Lever Bracket.....
12329	22472	Tension Releasing Lever Spring.....
12357	22466	Arm Shaft Flanged Bushing (back).....
12361	22474	Machine Hinge Connection for 44140 and 44180 (Accessories).....
12368	22391	Feed Bar.....

## NUMERICAL LIST OF PARTS

No.	Plate	Name
12376	22466	Feed Lifting Rock Shaft Crank with 157J and 1813, for 24970.....
*12382	2552	Needle Bar Connecting Link with 794E, for 43997.....
*12383	----	Needle Bar Connecting Stud for 12384....
12384	2552	Needle Bar Connecting Stud complete for 43997,Nos.453C,1904 and 12383.....
12388	22470	Oscillating Rock Shaft Hinge Pin for 24105.....
12391	22468	Lifting Presser Bar.....
12398	22472	Tension Releasing Lever Hinge Pin.....
12404	2552	Thread Take-up Crank.....
12405	22474	Machine Rest (felt) Accessories.....
12408	2552	Thread Take-up Lever for 12410.....
12409	2552	" " " Link for 12410....
12410	----	Thread Take-up Lever complete,Nos.12166 12408 and 12409.....
12416	22478	Lifting Lever Connecting Rod Joint for 24482 and 62697.....
12424	22467	Oscillating Shaft Crank Slide Block Cap Screw Washer for 19449.....
12431	----	Shuttle Race Slide for 12432.....
12432	22470	Shuttle Race Slide complete,Nos.4307, 12431 and two 725E.....
12453	8387	Arm Oil Tube, for oiling intermediate bearing.....
12454	8387	Arm Oil Tube with 132590,for oiling Thread Take-up Lever Link.....
12488	22471	Shuttle Body for 62808.....
15072	22475	Bobbin Winder Bobbin Position Pin for 27538.....
15098	22471	Shuttle Tension Spring for 24074.....
15140	22471	" Bobbin Case Latch for 15141....
15141	22471	" " " Hinge Nos.2973,2974 and 15140, for 24074.....
*15404	----	Trade Mark for 62881.....
15405	----	" " Rivet for 62881.....
15783	8387	Arm Oil Tube for 11119.....
16506	22476	Feed Rock Shaft for 62883.....
18511	22476	Arm Shaft.....
19221	22477	Wrench for 936 and 1619 (Accessories)..
19229	22470	Needle Bar (hollow).....
19354	----	Face Plate for 19355.....
19355	22391	Face Plate complete,Nos.12150,19354 and 45720.....
19356	22468	Lifting Presser Bar Bell Crank for 62800.....
19357	22468	Lifting Presser Bar Bell Crank Connecting Link for 62800.....
19358	22468	Lifting Presser Bar Bell Crank Driving Arm for 19361.....

## NUMERICAL LIST OF PARTS

No.	Plate	Name
19359	22468	Lifting Presser Bar Bell Crank Driving Arm Shaft for 19361.....
19360	22468	Lifting Presser Bar Bell Crank Driving Arm Shaft Bracket for 19361.....
19361	-----	Lifting Presser Bar Bell Crank Driving Arm Shaft Bracket complete, Nos. 2049 and 19358 to 19360.....
19362	22468	Lifting Presser Bar Bell Crank Driving Arm Eccentric Connection for 62811
19367	22472	Vibrating Presser Bar Cap.....
19371	22478	Lifting Lever with 448C, for 24482 and 62697.....
19372	22478	Lifting Lever Pin for 24482 and 62697..
19448	22467	Oscillating Shaft Crank Slide Block for 19449.....
19449	22467	Oscillating Shaft Crank Slide Block complete for 62804, Nos. 228J, 988C, 12424 and 19448.....
20023	22470	Lifting Presser Bar Spring (heavy) .063 wire.....
20197	22466	Crank Connecting Rod with two 896E.....
20240	22468	Lifting Presser Bar Lifter.....
20249	22468	Feed (upper) Shaft Bracket (back).....
20251	22469	" " " Collar with 456C.....
20255	22478	Lifting Lever Connecting Rod for 24482 and 62697.....
20283	22466	Feed and Feed Lifting Eccentric with 446C.....
20284	22391	Feed Forked Connection.....
21301	22478	Lifting Lever Link for 24482 and 62697.
24036	-----	Feed and Feed Lifting Eccentric Sleeve, obsolete, use 127152.....
24074	22471	Shuttle Bobbin Case complete for 62808, Nos. 591F, 592E, 2523, 2975, 7553, 15098 and 15141.....
24075	22391	Oil Cup Extension Post for 44005.....
24079	8407	Drip Pan.....
24101	-----	Needle Clamp Body for 24103.....
24102	22469	" " Thread Guide for 24103....
24103	22469	Needle Clamp (high lift) complete, Nos. 651J, 808F, 24101 and 24102.....
24104	22470	Oscillating Rock Shaft for 24105.....
24105	-----	Oscillating Rock Shaft complete, Nos. 4784, 12388 and 24104.....
24106	22474	Bed Frame Cushion (felt) for 24108.....
24107	22474	" " Hinge Connection for 24108...
24108	8408	Bed Frame complete, Nos. 970D, two each 9261, 24107, four each 158E, 24106 and six wood screws 1 1/4 in. No. 12.....
24131	6387	Arm Oil Tube with 52045, for oiling Feed and Feed Lifting Eccentric.....

## NUMERICAL LIST OF PARTS

No.	Plate	Name
24296	22476	Balance Wheel (power) light rim, 2 3/16 in pulley with two 448C.....
24297	22466	Balance Wheel Oil Cover.....
24412	22470	Shuttle Bobbin Case Position Plate for 24554.....
24418	22470	Shuttle Race Cap for 62511.....
24475	22468	Feed (upper) Shaft Bracket (front).....
24482	-----	Knee Lifter complete (power table) Nos. 76D, 766D, 802D, 1521J, 2777, 5598, 12416, 19371, 19372, 20255, 21301 and two 178E.....
*24551	-----	Shuttle Driver for 24552.....
24552	22470	" " 24551 with two 1286C....
24553	-----	" Race Body for 62511.....
24554	22470	Shuttle Race complete, Nos. 907D, 2531, 2533, 24412, 62520 and two 391J....
24590	22468	Lifting Presser Bar Guide Bracket Support.....
24908	8407	Drip Pan with two wood screws 1/2 in. No. 5 R.H.B., for 24108.....
24952	22473	Feed Dog, 11 teeth (18 teeth to the inch) for 24959.....
24959	22473	Throat Plate for 24952.....
24969	22476	Feed Lifting Rock Shaft for 24970.....
24970	-----	Feed Lifting Rock Shaft complete, Nos. 12376 and 24969.....
26026	22477	Screw Driver (machine) Accessories....
26485	22477	" " (shuttle tension) Accessories.....
26803	22466	Edge Guide Bed with 2362, for 26810....
26805	22466	" " Slide Cap (left) for 26810..
26806	22466	" " " " (right) for 26810....
26807	22466	" " " Lever for 26810.....
26808	22466	" " " Spring for 26810.....
26809	22466	" " " Cover for 36780 and 121146.....
26810	22466	Edge Guide (roller) complete, Nos. 94D, 233J, 26803, 26805 to 26808, 121146, two 207J and four 220J.....
27302	22395	Bobbin Winder Frame for 27847.....
27303	22475	" " Spring for 27847....
27306	22395	" " Spool Pin for 27308.....
27307	22395	" " Stand for 27308....
27308	22395	Bobbin Winder Spool Stand complete for 27544, Nos. 418E, 1582J, 2106, 10141, 11241, 27306, 27307, two each 2455 and wood screws 1 in. No. 10.....
27312	22395	Bobbin Winder Stop Latch for 27847....
27538	22395	" " Spindle 27849 with 15072, 27850 and 41828, for 27847.....
27540	22395	Bobbin Winder Base for 27847.....
27541	22395	" " Pulley for 27847.....

## NUMERICAL LIST OF PARTS

No.	Plate	Name
27544	-----	Bobbin Winder (swinging automatic, right hand) complete, for 2996, for stand, Nos. 27308 and 27647.....
27647	22395	Bobbin Winder-Nos. 35D, 1620J, 27302, 27303, 27312, 27538, 27540, 27541, 50358D and two wood screws 1 in. No. 7, for 27544.....
27739	8405	Thread Unwinder Thread Cone (wood) for large cones, for 225260.....
*27849	-----	Bobbin Winder Spindle for 27538.....
*27850	-----	" " Collar for 27538.....
32572	22472	Tension Releasing Disc for 44118.....
32574	22472	" " Pin for 44118.....
36760	-----	Edge Guide Slide with 26809, 51809 and two 12152, obsolete, use 121146....
41400	22477	Machine Rest Pin (wood) 3 1/8 in. long (Accessories).....
41828	22475	Bobbin Winder Spindle Collar Pin for 27538.....
41929	8408	Belt Guard for 41931.....
41930	22474	" " Hinge for 41931.....
41931	-----	Belt Guard complete, Nos. 8420, 41929, two 41930 and four wood screws 3/4 in. No. 9.....
43944	22478	Tension Releasing Lever.....
43945	22472	" Spring for 44118.....
43946	2552	Thread Take-up Spring for 44118.....
43976	22391	Feed Lifting Rock Shaft Crank Connecting Rod with two 966E.....
43997	-----	Needle Bar Connecting Link 12382 with 12384.....
44005	-----	Oil Cup Extension 44214 with 24075, for 44223.....
44006	22391	Oil Cup Packing (felt) for 44225.....
44118	-----	Tension complete, Nos. 7336, 32572, 32574, 43945, 43946, 44141 and two 2102....
44139	22474	Machine Hinge Plate for 44140 and 44180 (Accessories).....
44140	-----	Machine Hinge complete, Nos. 12361, 44139 and merlized wood screw 1 1/4 in. No. 14 (Accessories).....
44141	-----	Tension Screw Stud 50327C with 1560C, for 44118.....
44180	-----	Machine Hinge complete, Nos. 6055, 12361, 44139 and 51075E (Accessories)....
*44181	-----	Face Plate Thread Guard (lower) for 12150.....
44214	22391	Oil Cup Extension for 44005.....
44222	22391	" " for 44223.....
44223	-----	" " 44222 with 44005, for 44225....
44224	22391	" " Thread Retainer for 44225.....

## NUMERICAL LIST OF PARTS

No.	Plate	Name
44225	22391	Oil Cup complete, Nos. 44006, 44223 and 44224.....
45720	22467	Face Plate Thread Guard (upper) with 125373, for 19355.....
50327C	22472	Tension Screw Stud for 44141.....
50356D	22475	Bobbin Winder Frame Hinge Screw for 27647.....
50385C	22472	Vibrating Presser Bar Tension Screw....
50562C	22469	Feed (upper) Shaft Crank (back) Connecting Link Hinge Screw.....
50562C	22469	Feed (upper) Shaft Crank (front) Connecting Link Hinge Screw.....
51075E	22474	Machine Hinge Bolt with 51581E, for 44180 (Accessories).....
51224J	8387	Arm Side Cover Thumb Screw.....
51581E	22474	Machine Hinge Bolt Nut for 51075 (Accessories).....
51809	-----	Edge Guide Slide Roller and Stud for 36760, obsolete.....
51916	22467	Edge Guide Slide Roller and Screw Stud for 121146.....
52027	22472	Thread Guard (side of arm).....
52045	8387	Arm Oil Tube Packing (wick) for 11119 and 24131.....
52046	22478	Spool Holder Base for 52047.....
52047	22478	Spool Holder complete, Nos. 52046, 200079H and 204296.....
52454	22472	Thread Retainer.....
56813	-----	Feed Bar Screw Center 313C with 1519J..
56814	-----	" Lifting Rock Shaft Screw Center 307C with 1513J.....
56814	-----	Feed Rock Shaft Screw Center 307C with 1513J.....
56848	-----	Bell Crank 5596 with 5599 and 5601, for 5598.....
56864	22478	Chain Hook (large) for 5670.....
56865	22478	" " (small) for 5670.....
62511	-----	Shuttle Race Body 24553 with 24418 and two 1053J, for 62520.....
62520	-----	Shuttle Race Body 62511 with two 2532, for 24554.....
62697	-----	Foot Lifter complete, Nos. 76D, 766D, 902D, 1521J, 4880, 4885, 5598, 5670, 12416, 19371, 19372, 20255, 21301 and two 178E.....
62796	22468	Feed (upper) Shaft Crank (front) with 462C, for 62886.....
62797	22468	Feed (upper) Shaft Crank (front) Connecting Link for 62814.....
62798	22468	Feed (upper) Shaft Crank (front) Connecting Link Bracket for 62814....



## NUMERICAL LIST OF PARTS

No.	Plate	Name
62799	22468	Lifting Presser Bar Guide Bracket with 453C, for 62800.....
62800	-----	Lifting Presser Bar Guide Bracket complete, Nos. 19356, 19357, 62799, 62805 and three 199D.....
62801	-----	Lifting Presser Foot, obsolete, use 62894
62802	22466	Needle Bar Crank and Lifting Eccentric with 448C and 743C, for 62811.....
62803	-----	Oscillating Shaft Crank for 62804.....
62804	22467	Oscillating Shaft Crank complete, Nos. 1518J, 19449, 62803 and two 453C....
62805	22478	Vibrating Presser Bar for 62800.....
62806	22472	" " " " Tension Screw Bracket.....
62807	-----	Vibrating Presser Foot, obsolete, use 62895.....
62808	22471	Shuttle, 1 11/16 in. diam., Nos. 2996, 12488 and 24074.....
62811	-----	Needle Bar Crank and Lifting Eccentric 62802 with 19362.....
62813	22476	Oscillating Shaft.....
62814	-----	Feed (upper) Shaft Crank (front) Connecting Link 62797 with 199D and 62798.....
*62881	-----	Arm with 11104, 15404 and two 15405....
*62882	-----	Bed.....
62883	-----	Feed Rock Shaft 16508 with 62884....
62884	22466	" " " " Crank with two 172J, for 62883.....
62885	22476	Feed (upper) Shaft for 62886.....
62886	-----	" " " " 62885 with 2049 and 62796.....
62887	22468	Feed (upper) Shaft Crank (back) with two 172J.....
62888	22468	Feed (upper) Shaft Crank (back) Connecting Link.....
62894	22473	Lifting Presser Foot.....
62895	22473	Vibrating Presser Foot.....
120342	22477	Oiler (copper plated) with 120343 (Accessories).....
120343	22477	Oiler Spout, 3 1/2 in. long, for 120342 (Accessories).....
121146	22486	Edge Guide Slide with 26809, 51916 and two 12152, for 26810.....
125373	22487	Face Plate Thread Guard (upper) Rivet for 45720.....
127152	22486	Feed and Feed Lifting Eccentric Sleeve.
132590	8387	Arm Oil Tube Packing (wick) for 12454..
150203	8405	Thread Unwinder Spool Rest Cushion (felt) for 225260.....
200058E	3471	Bobbin Winder Stop Latch Screw for 225382.....

## NUMERICAL LIST OF PARTS

No.	Plate	Name
200079H	22469	Spool Holder Wire Hinge Screw for 52047
200082D	3471	Bobbin Winder Tension Bracket Screw for 225382.....
200299H	3471	Bobbin Winder Stop Latch Trip Lever Hinge Screw for 225382.....
200380C	3471	Bobbin Winder Pulley Set Screw for 202473.....
200383C	22475	Thread Unwinder Spool Rest Rod Set Screw for 202490.....
201018C	22475	Thread Unwinder Spool Rest Set Screw for 225259.....
201499B	3471	Bobbin Winder Tension Stud for 225461..
201572B	3471	" " " " Thumb Nut for 225462.....
201696J	22475	Thread Unwinder Thread Guide Lock Nut for 225280.....
202277	3471	Bobbin Winder Frame Oil Packing (wick) for 225453.....
202407	3471	Bobbin Winder Tension Spring for 225462
202473	8406	" " Pulley with 200380C, for 225382.....
202478	3471	Bobbin Winder Stop Latch Trip Lever for 225382.....
202490	8405	Thread Unwinder Spool Stand with 200383C, for 225260.....
204396	22478	Spool Holder Wire for 52047.....
225259	8405	Thread Unwinder Spool Rest with 201018C for 225260.....
225260	8405	Thread Unwinder complete, for one large spool or one large cone of thread, Nos. 150203, 201696J, 202490, 225259, 225324, 225326, 225388, 225391 and three wood screws 7/8 in. No. 12...
225322	22475	Thread Unwinder Thread Guide Rod Washer for 225324.....
225324	8405	Thread Unwinder Thread Guide Rod with 208E and 225322, for 225260.....
225326	22475	Thread Unwinder Thread Guide Position Cup for 225260.....
225381	22395	Bobbin Winder Spindle for 225382.....
225382	8406	Bobbin Winder (swinging automatic, right hand) complete for 2996, for power table, Nos. 200058E, 200082D, 200299H, 202473, 202478, 225381, 225433, 225444, 225453 to 225456, 225458, 225462, 228026, two each 225459 and wood screws 3/4 in. No. 12 R.H.B.....
225388	8405	Thread Unwinder Spool Rest Rod for 225260.....
225390	8405	Thread Unwinder Thread Cone Holder, for inverted cones, for 225260.....

## NUMERICAL LIST OF PARTS

No.	Plate	Name
225391	8405	Thread Unwinder Thread Guide for 225380
225433	8406	Bobbin Winder and Tension Bracket Base for 225382.....
225438	3471	Bobbin Winder Frame Oil Well Cap for 225453.....
225444	3471	Bobbin Winder Stop Latch for 225382....
225453	22395	" " Frame with 202277 and 225438, for 225382.....
225454	3471	Bobbin Winder Frame Hinge Pin for 225382.....
225455	3471	Bobbin Winder Frame Spring for 225382..
225456	3471	" " " " Plunger for 225382.....
225458	3471	Bobbin Winder Stop Latch Thumb Lever for 225382.....
225459	3471	Bobbin Winder Stop Latch Thumb Lever Hinge Stud for 225382.....
225459	3471	Bobbin Winder Stop Latch Thumb Lever Joint Stud for 225382.....
225461	3471	Bobbin Winder Tension Bracket with 201499B, for 225462.....
225462	-----	Bobbin Winder Tension Bracket complete for 225382, Nos. 201572B, 202407, 225461 and two 2102.....
228026	22475	Bobbin Winder Tension Bracket Screw Washer for 225382.....

Genuine Singer Needles should be used  
in Singer Machines.  
These Needles and their Containers  
are marked with the  
Company's Trade Mark "SIMANCO." 1

Needles in Containers marked  
"For Singer Machines"  
are not Singer made needles. 2

PLATE 2552—FULL SIZE

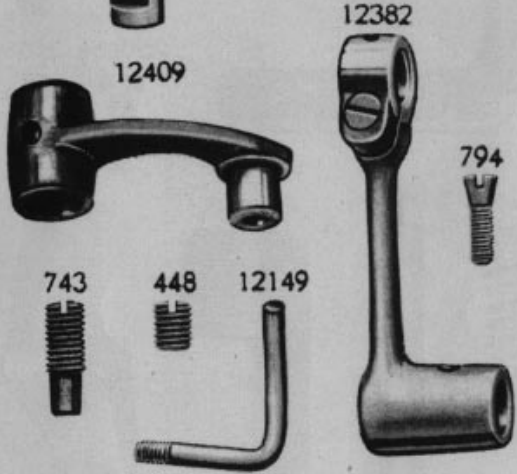
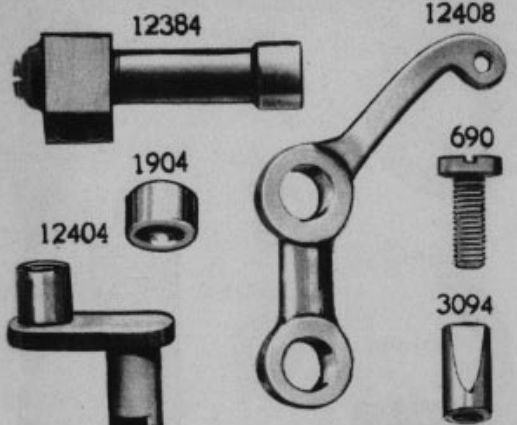

PLATE 3471—FULL SIZE

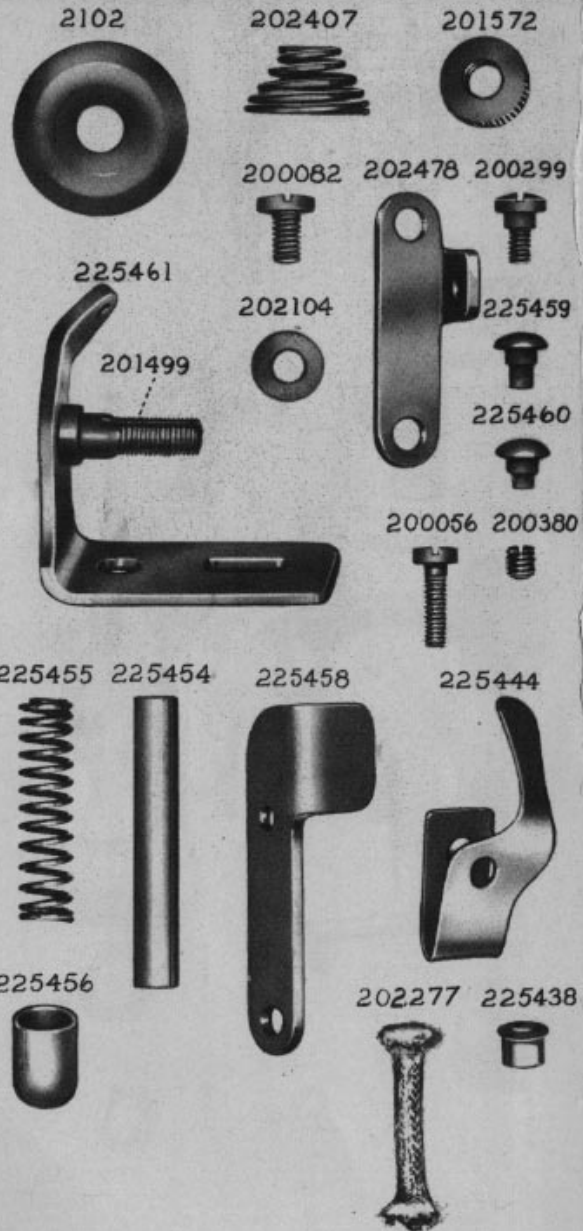

PLATE 8387—FULL SIZE

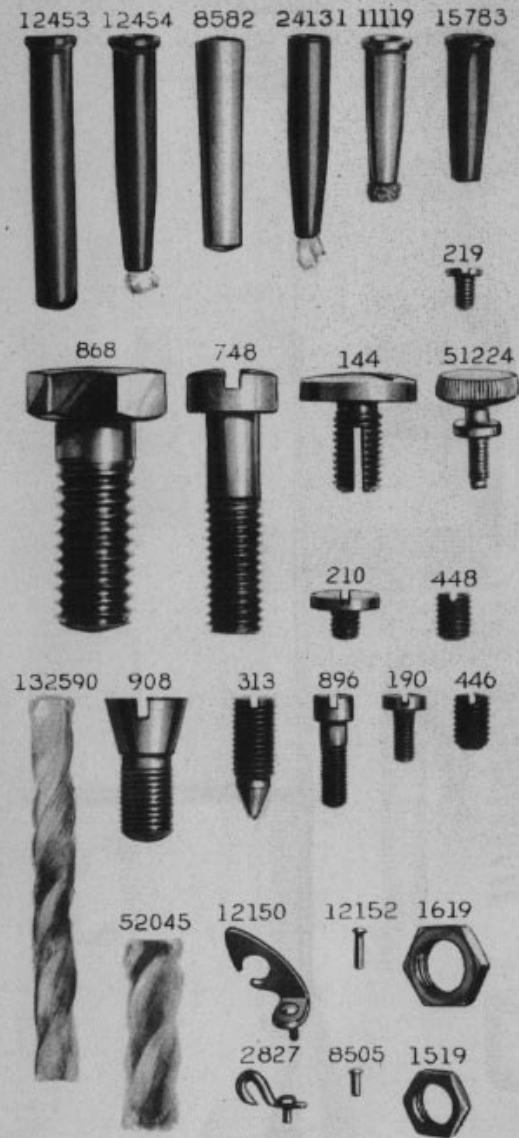

PLATE 8405—ONE-FOURTH SIZE

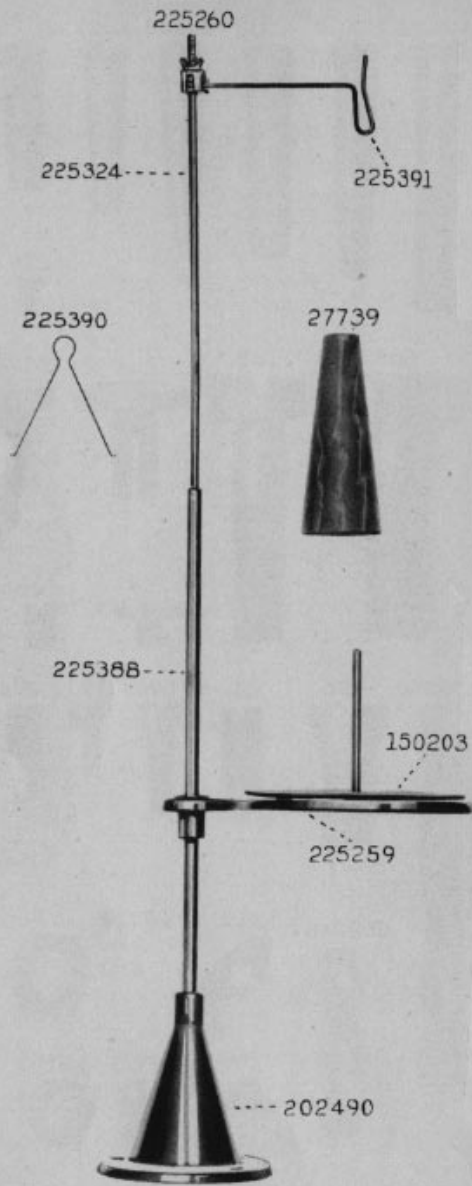

PLATE 8406—ONE-FOURTH SIZE

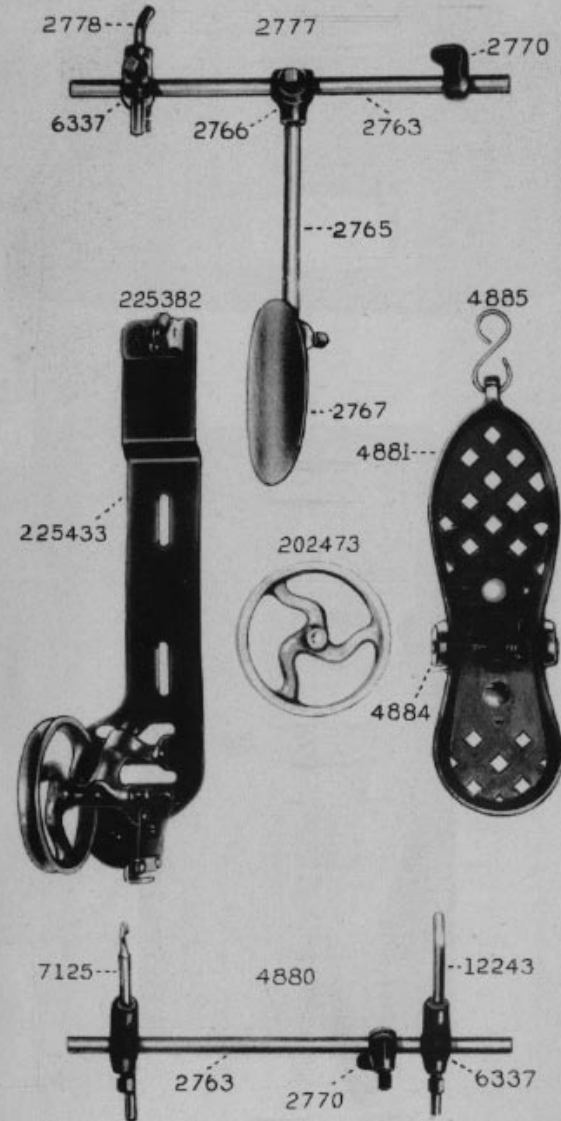

PLATE 8407—ONE-FOURTH SIZE

24079



24908

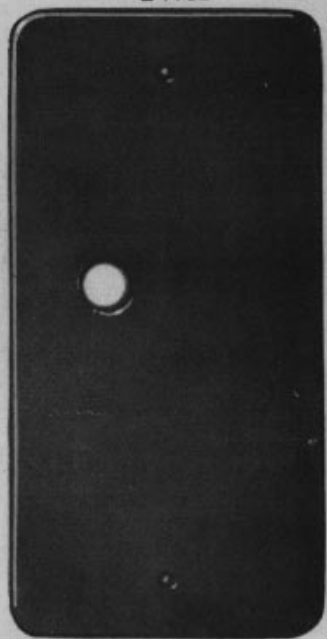
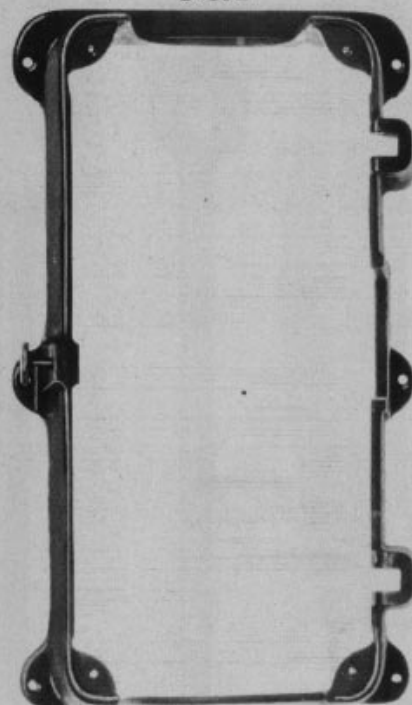

PLATE 8408—ONE-FOURTH SIZE

24108



41929

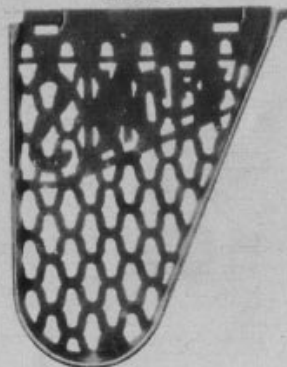

PLATE 22391 - ONE - HALF SIZE

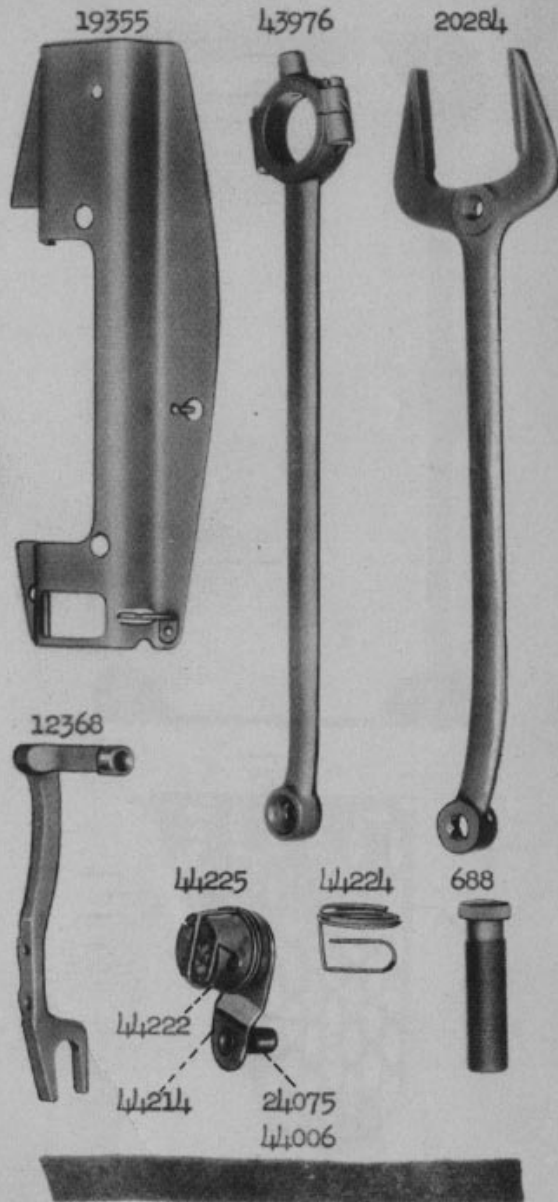

PLATE 22395 - ONE - HALF SIZE

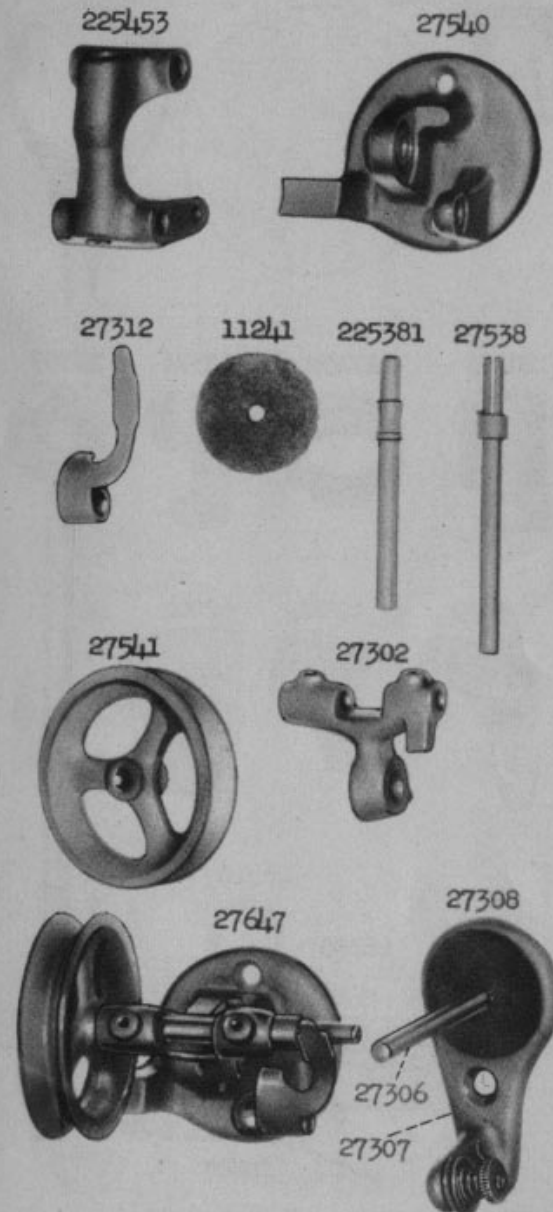

PLATE 22466 - ONE - HALF SIZE

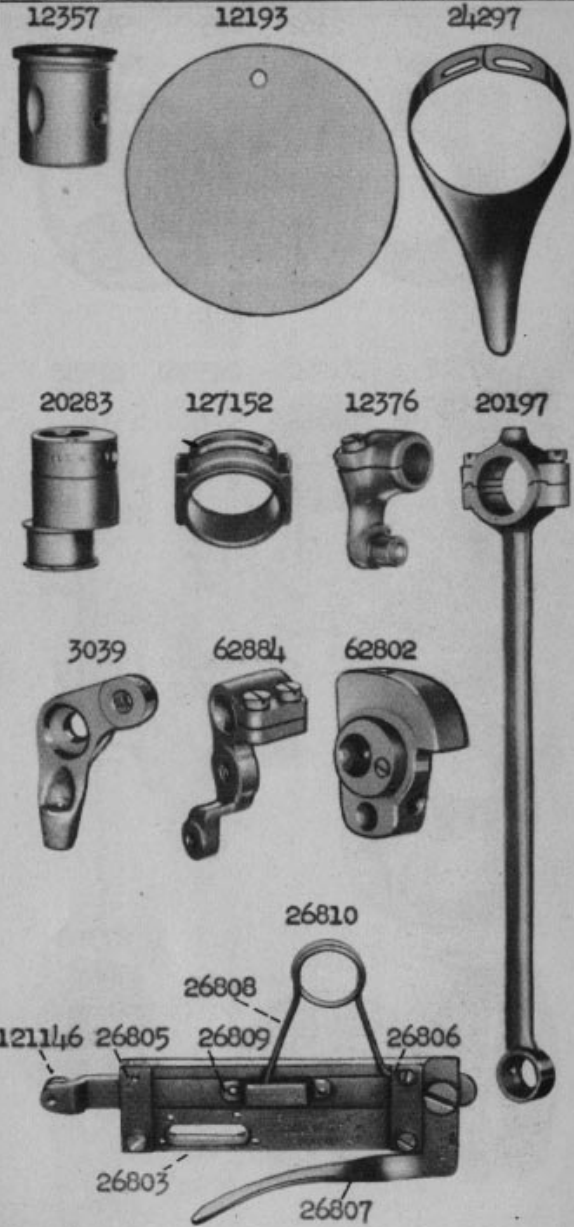

PLATE 22467 - FULL SIZE

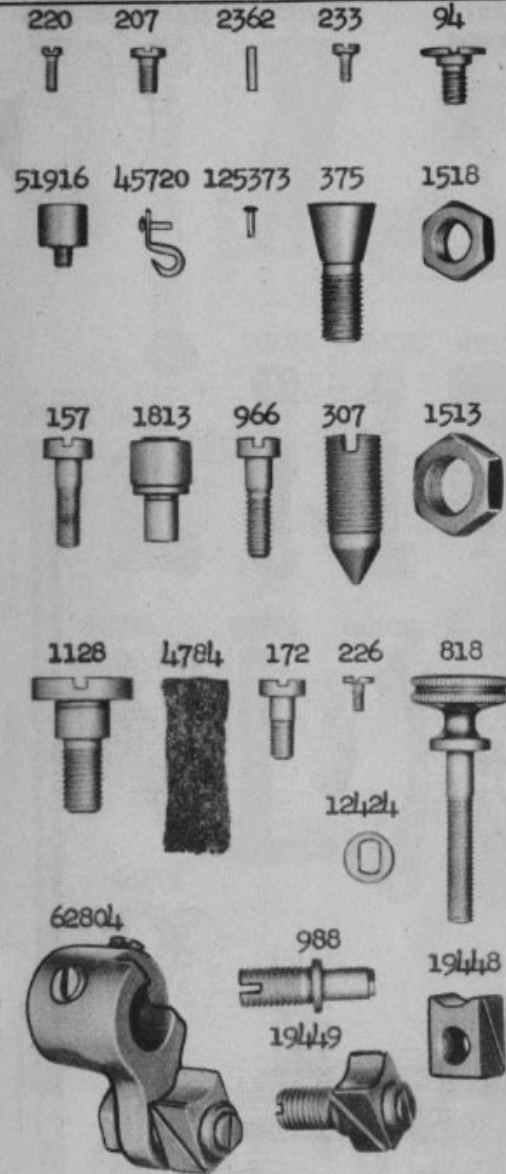



PLATE 22468 - ONE - HALF SIZE

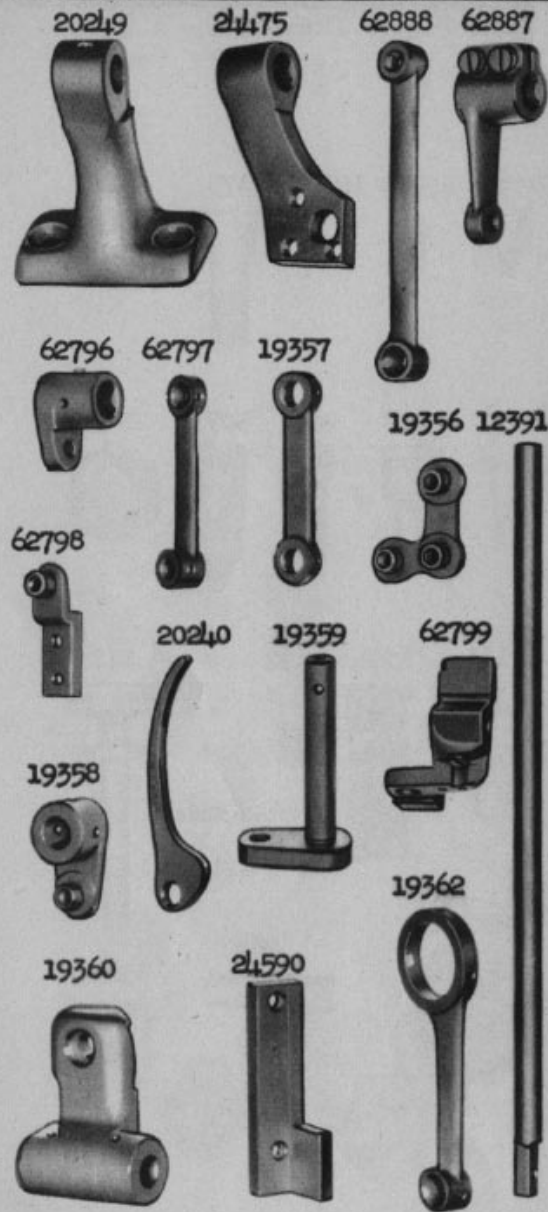

PLATE 22469 - FULL SIZE

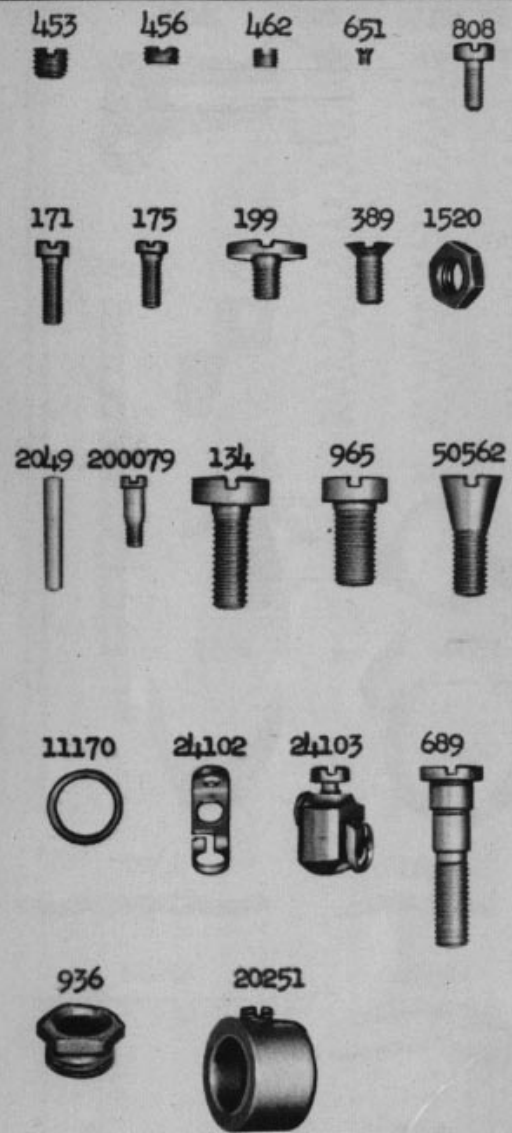

PLATE 22470 - ONE - HALF SIZE

11167 12139 20023 24104 19229

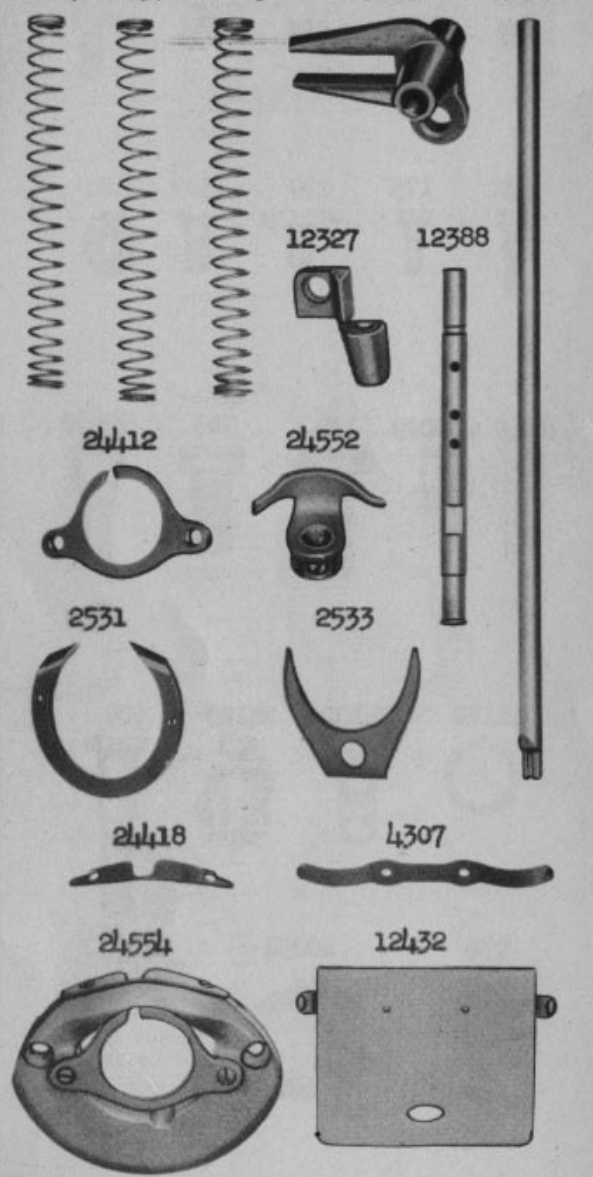

PLATE 22471 - FULL SIZE

2996 15140 2973 2974 2975

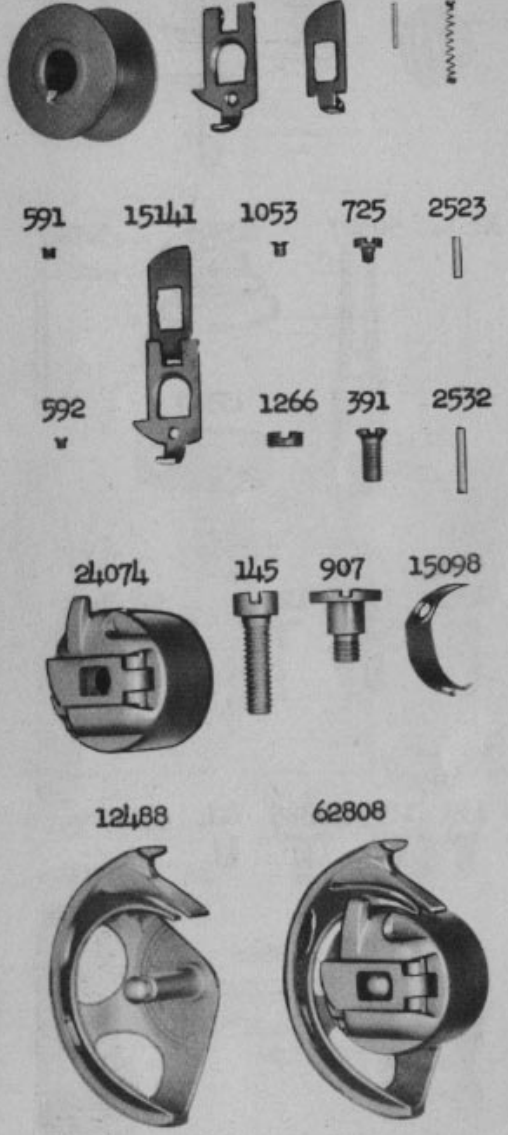

PLATE 22472 - FULL SIZE

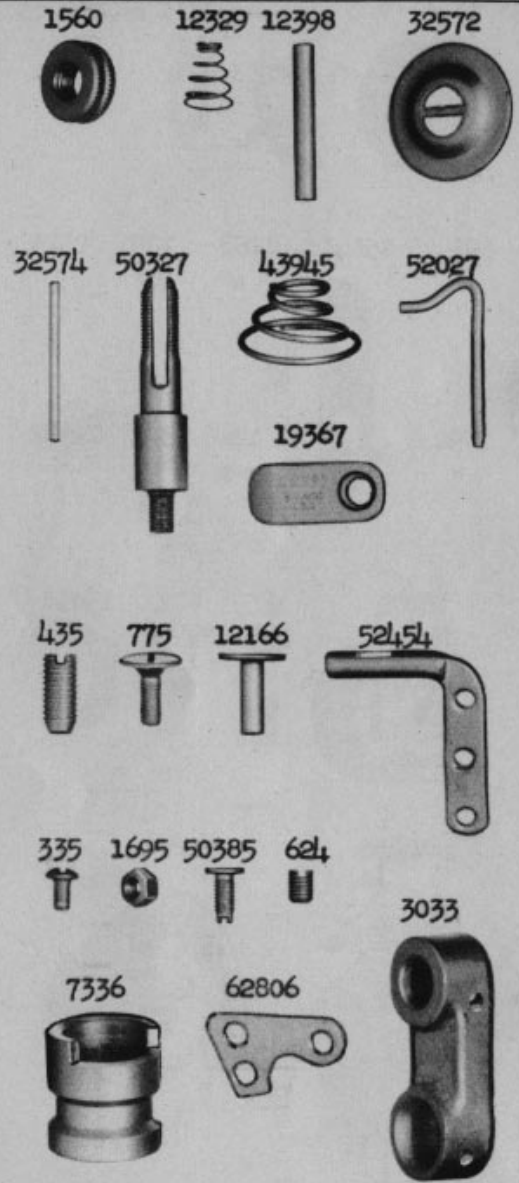

PLATE 22473 - FULL SIZE

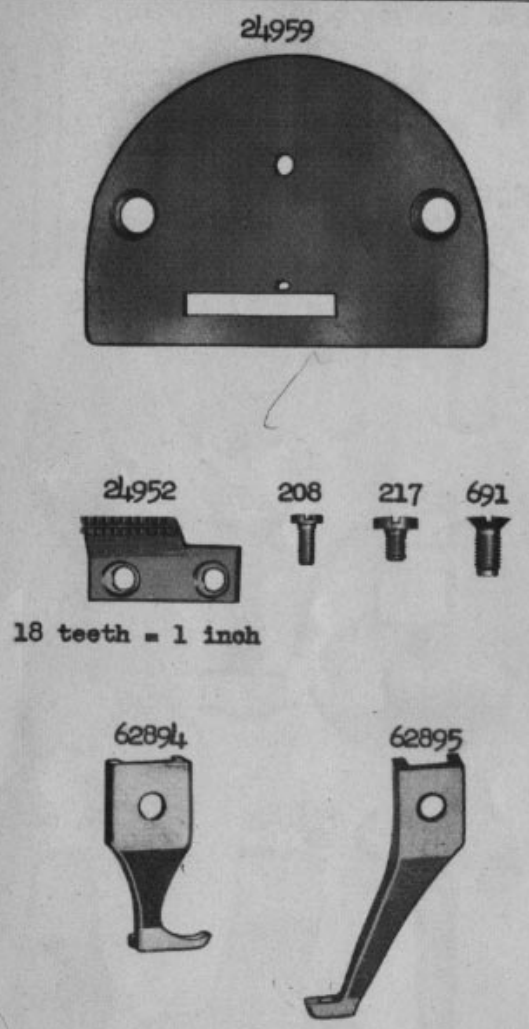
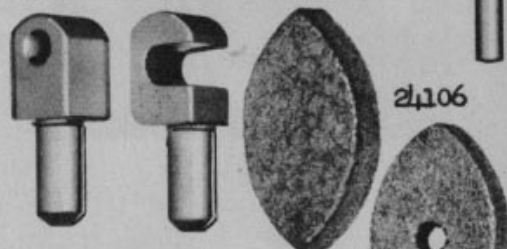

PLATE 22474 - FULL SIZE

158 27878 51581 8419 9261



24107 12361 12405



24106

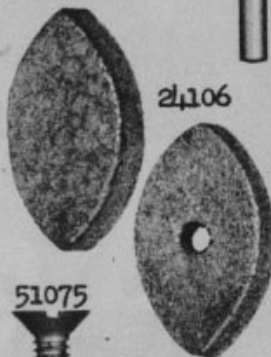

44139

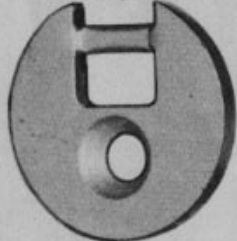

51075



6055

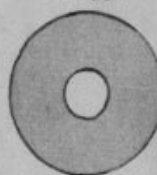

970

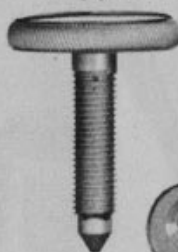

41930

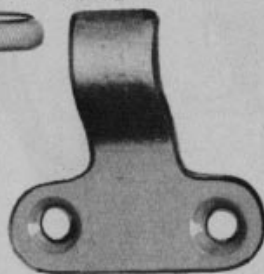

8418



PLATE 22475 - FULL SIZE

50356 1620 27303 41828 35



2455



1562



418

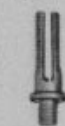

10141



2106



15072



228026



178



766



1521



76



356



5601



201696



225322



802



200383



201018



225326



PLATE 22476 - ONE - FOURTH SIZE

16506 16511 24969 62813 62885

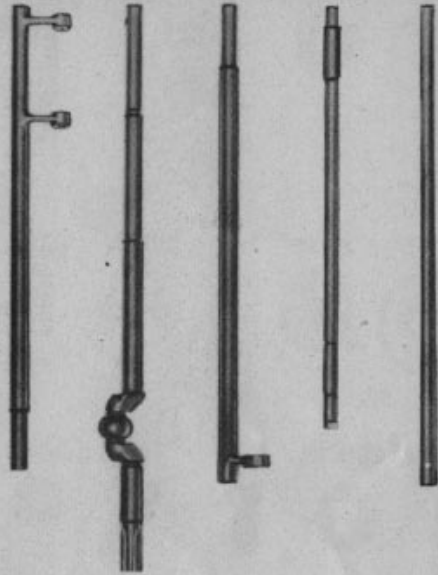

24296



PLATE 22477 - ONE - HALF SIZE

42400 120342 26026

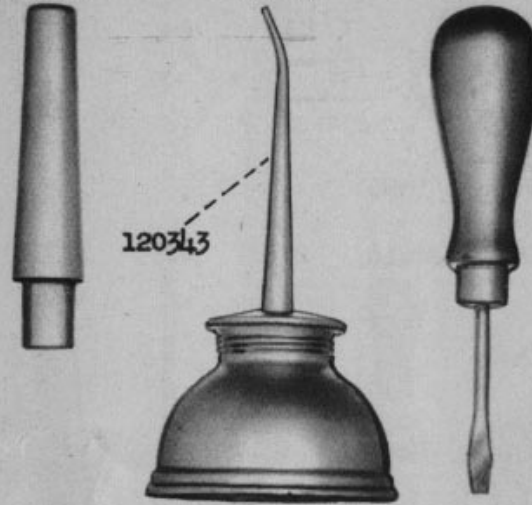

26485 4822 8908 8909 19221

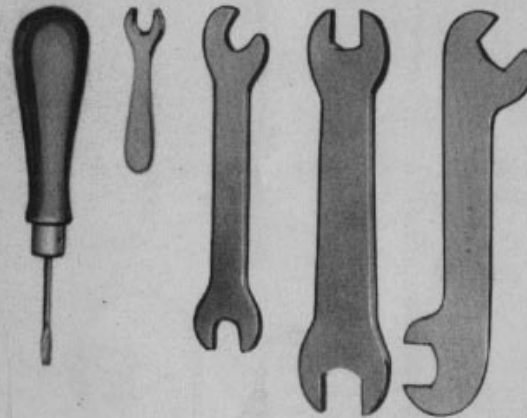

PLATE 22478 - ONE - HALF SIZE

