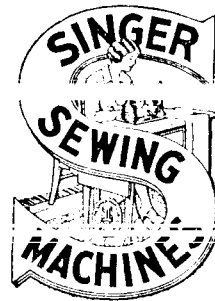


LIST OF PARTS



MACHINE No. 114-27

THE SINGER MANUFACTURING COMPANY

List of Parts for Machine No. 114SV64

Same as Machine No. 114-27 with the following exceptions:-

Less Parts

124799	Clamp Complete
124801	Feed Cam
18415	" " Driving Worm
17797	" " " " Wheel
124802	" plate
124955	Throat Plate

Add Parts

Ser.177732	Buckle Clamp Complete Nos. 1656J, 62259 and Ser. 177731
Ser.177871	Feed Cam
	190J, 17874, Ser.177872, Ser.177373 and eight 335J
Ser.170765	Feed Cam Driving worm
" 170766	" " " " wheel
" 177733	Feed Plate
124877	Throat Plate 124789 with 1547J, 50018F, 62128, 62129, 124778, 124876 and two each 206D and 236F

INSTRUCTIONS FOR ORDERING

In ordering from this list, use **ONLY** the part **NUMBER** in the **FIRST** column.

The number stamped on a Sewing Machine part is in every case the number of the single part only.

Every combination of parts sent out as such has its specific number, which, although not stamped on the parts, must be used when ordering the combination.

Each number always indicates the **SAME PART** in whatever list it appears, or for whatever machine.

The letters after some of the numbers indicate the style of finish only, as follows:

- A—Hardened, Polished, Nickel Plated and Buffed
- B—Polished, Nickel Plated and Buffed
- C—Hardened Only
- D—Polished Only
- E—Soft, Not Polished
- F—Hardened and Polished
- H—Blued
- J—Nickel Plated Only
- K—Hardened and Nickel Plated
- L—Brass Plated

- P—Japanned
- R—Merlized
- T—Copper Plated
- T. A.—Hardened, Polished, Copper and Nickel Plated and Buffed.
- T. B.—Copper and Nickel Plated and Polished.
- T. J.—Copper and Nickel Plated Only.
- T. K.—Hardened, Copper and Nickel Plated.
- T. M.—Copper Plated and Oxidized.
- T. L.—Copper and Brass Plated.
- U—Zinc Plated
- V—Silver Plated
- W—Polished and Nickel Plated
- Z—Chromium Plated

These letters **MUST BE USED** when they appear in the list; and **AFTER** the number **as** in the list.

In this series:

- 1 to 1500 and 50001 to 51500 are Screw Numbers.
- 1501 to 1800 and 51501 to 51800 are Nut Numbers.
- 1801 to 2000 and 51801 to 52000 are Roller Numbers.
- 2001 to 50000 and 52001 and upward are numbers of Machine Parts.

The figures in the second column refer only to the plates, illustrating the parts, and are **NOT TO BE USED** in ordering.

Parts marked with an asterisk (*) are furnished only when repairs are made at factory.

PARTS FOR MACHINE No. 114-27

NO.	PLATE	NAME
1520j	9080	Arm Shaft (horizontal) Bushing (back) Adjusting Screw Nut.....
*4449	—	Arm Shaft (horizontal) Bushing (front).
59703	6976	“ “ “ Gear with two 1036c.....
1036c	6976	Arm Shaft (horizontal) Gear Set Screw
59704	6976	“ “ (upright).....
59705	6976	“ “ “ Bushing (lower)...
446c	9052	“ “ “ “ “ Set Screw.....
59706	6976	Arm Shaft (upright) Bushing (upper)...
446c	9052	“ “ “ “ “ Set Screw.....
59707	6976	Arm Shaft (upright) Gear (lower) with two 1253c.....
1253c	6976	Arm Shaft (upright) Gear (lower) Set Screw.....
59708	6976	Arm Shaft (upright) Gear (upper) with two 1253c.....
1253c	6976	Arm Shaft (upright) Gear (upper) Set Screw.....
124674	7036	Arm Side Cover.....
190b	9052	“ “ “ Screw.....
18498	6976	Belt Cover.....
59795	7036	“ “ Bracket with 181E and 59796
184E	6998	“ “ “ Screw Stud.....
59796	9080	“ “ “ Stud.....
217d	6998	“ “ Screw.....
59222	7036	Ben Snapper.....
63976	9080	“ “ Clamp.....
1255d	6976	“ “ “ Screw.....
124712	—	Brake.....
124713	9080	“ 124712 with four 56493.....
124714	9080	“ Adjusting Plate.....
124715	9080	“ “ “ Handle.....
124716	—	“ “ “ “ “ 124715 with 124717.....
50435d	9053	Brake Adjusting Plate Handle Hinge Screw.....
124717	9080	Brake Adjusting Plate Handle Shaft
124718	9080	“ “ “ “ “ “ Crank with 1253c.....
1253c	9052	Brake Adjusting Plate Handle Shaft Crank Set Screw.....
286j	9053	Brake Adjusting Plate Thumb Screw
124719	9080	“ “ “ “ “ “ Bushings.....
124720	7036	Brake Arm.....

NO.	PLATE	NAME
62103	9091	Cloth Plate Guide Block (right).....
3021	9091	“ “ “ “ “ Rivet..
190D	9052	“ “ Screw.....
62104	9091	“ “ Stop.....
26770	9091	“ “ “ Rivet.....
62105	6975	Cloth Plate complete, Nos. 742F, 1547D, 26770, 62101 to 62104 and two 3021.
*124800	—	Cylinder.....
62189	7036	“ Bottom Cover.....
124742	7036	“ End Cover.....
124743	—	“ “ “ 124742 with 1034D, 62111, 62113, 62185, 62189, 124744 and four 1477D.....
62185	7037	Cylinder End Cover Bracket.....
62111	7037	“ “ “ “ Hinge Pin
1477D	9052	“ “ “ “ Screw.....
124744	7037	“ “ “ Hinge.....
1477D	9052	“ “ “ “ Screw.....
62113	7037	“ “ “ Spring.....
1034D	9052	“ “ “ “ Screw.....
124745	9092	“ Oil Well Cover.....
236D	9052	“ “ “ “ Screw.....
59712	—	Face Plate complete, Nos. 208D, 9544, 9545, 59711 and two each 229D, 2107 and 9543.....
164D	9052	Face Plate Screw.....
2107	7041	“ “ Thread Guard.....
229D	9052	“ “ “ “ Screw.....
9543	7041	“ “ “ Nipper Disc.....
9544	7041	“ “ “ “ “ Cover
208D	9052	“ “ “ “ “ “ Screw.....
9545	7041	Face Plate Thread Nipper Disc Spring
63940	7041	Feed Across Connection (lever end) with 42076 and two 896E.....
63941	—	Feed Across Connection (lever end) 63940 with 55381.....
55381	7041	Feed Across Connection (lever end) Ball Stud.....
1185c	9052	Feed Across Connection (lever end) Ball Stud Set Screw.....
63942	7041	Feed Across Connection (regulator end) with 42076 and two 896E.....
63943	—	Feed Across Connection (regulator end) 63942 with 63944.....
63944	7041	Feed Across Connection (regulator end) Ball Stud.....

NO.	PLATE	NAME
1449H	9053	Needle Bar Thread Retainer Screw.....
124821	7043	“ “ “ “ Spring.....
42639	7043	“ “ “ “ Steady Pin.....
124795	—	Needle Bar Thread Retainer complete, Nos. 1449H, 124794, 124796 and 124821
124766	7043	Needle Guard.....
124601	7043	“ “ Cam with two 465c.....
465c	9052	“ “ “ Set Screw.....
2273	7043	“ “ Pin.....
124767	7047	“ “ Shaft.....
124792	—	“ “ “ 124767 with 2273 and 124766.....
59761	7048	Needle Guard Shaft Collar with two 465c.....
465c	9052	Needle Guard Shaft Collar Set Screw...
124602	7048	“ “ “ Crank with 51857, 124698, 124699 and two 465c.....
51857	7048	Needle Guard Shaft Crank Roller.....
124698	7048	“ “ “ “ “ Bushing
124699	7048	“ “ “ “ “ “ Stud.....
465c	9052	Needle Guard Shaft Crank Set Screw...
59766	7048	“ “ “ “ Collar with 624c.....
624c	9052	Needle Guard Shaft Spring Collar Set Screw.....
233b	6995	Needle Guard Shaft Spring Screw.....
124768	7048	“ “ Spreader.....
233j	6995	“ “ “ Screw.....
1072f	9053	“ Set Screw.....
2058	7047	Presser Bar.....
124769	7047	“ “ Collar and Thread Pull-off Bracket with two 196c.....
196c	6992	Presser Bar Collar Set Screw.....
17842	6992	“ “ Guide Bracket with 453c...
453c	9052	“ “ “ “ Set Screw...
124790	9552	“ “ Lifting Lever.....
124793	9096	“ “ “ “ Bracket.....
164E	9052	“ “ “ “ “ Screw
1201D	7006	“ “ “ “ Hinge Screw..
32675	7048	“ “ Spring.....
63975	9095	Pulley (loose) 2¾ in. diam.....
17848	7048	“ “ Bushing.....
2269	7048	“ “ “ Position Pin....
1202R	6998	“ “ Cap Screw.....
17942	9095	“ (tight) 2⅞ in. diam. with 2269..
2022	7048	“ “ Pin.....

N.O.	PLATE	NAME
17863	7048	Stop Cam Interlocking Rod Spring.....
17864	7048	“ “ “ “ Stop.....
1318b	9052	“ “ “ “ “ Screw.....
3012	9093	“ “ Pin.....
1206c	9053	“ “ Screw.....
2102	6995	Tension Disc.....
1560c	6995	“ Regulating Thumb Nut.....
50148c	6995	“ Screw Stud.....
124687	—	“ “ “ 50148c with 1560c
42336	6995	“ Spring.....
13915	6995	“ “ Bushing.....
124805	9096	“ Thread Guide.....
124609	7050	Thread Controller Sleeve.....
124607	7050	“ “ Spring.....
124608	7050	“ “ “ Collar with 1477F.....
1177F	9052	Thread Controller Spring Collar Set Screw
124892	9084	“ “ Stud.....
124900	—	“ “ “ 124892 with 124893.....
457C	9052	Thread Controller Stud Set Screw.....
124893	9084	“ “ Thread Guide.....
124894	—	Thread Controller complete, Nos. 124607 to 124609 and 124900.....
*124612	—	Thread Nipper (lower) Blade.....
124613	—	“ “ “ “ Carrier with 124619.....
124614	7050	Thread Nipper (lower) Blade Carrier 124613 with 124612 and two 6037.....
665j	9052	Thread Nipper (lower) Blade Carrier Cap Screw.....
124615	7050	Thread Nipper (lower) Blade Carrier Hinge Stud.....
6037	7050	Thread Nipper (lower) Blade Rivet.....
124616	7047	“ “ “ Cam.....
335j	9053	“ “ “ “ Screw.....
124653	7047	“ “ “ Connection.....
124618	7050	“ “ “ “ Extension
99k	9053	“ “ “ “ “
		Hinge Screw.....
206j	9052	Thread Nipper (lower) Connection Extension Screw.....
124619	7050	Thread Nipper (lower) Connection Hinge Stud.....
124620	9095	Thread Nipper (lower) Driving Arm.....
8554	7050	“ “ “ “ “ Pin
124621	9096	“ “ “ Lever with 237k

NO.	PLATE	NAME
51591J	9093	Thread (lower) Pull-off Bar Check Regulating Screw Lock Nut.....
50152b	9096	Thread (lower) Pull-off Bar Check Screw
124936	---	Thread (lower) Pull-off Bar Check complete, Nos. 51120J, 51591J, 124933 to 124935, 124938 and two 1722b.....
62126	6990	Thread (lower) Pull-off Bar Connection with 17917.....
190b	6990	Thread (lower) Pull-off Bar Connection Screw.....
17915	6990	Thread (lower) Pull-off Bar Connection Slide Block.....
17917	---	Thread (lower) Pull-off Bar Connection Slide Block 17915 with 17916.....
17916	6990	Thread (lower) Pull-off Bar Connection Slide Block Stud.....
59734	6990	Thread (lower) Pull-off Bar Driving Lever with 223F and 59735.....
1382F	6998	Thread (lower) Pull-off Bar Driving Lever Hinge Screw.....
1681c	9092	Thread (lower) Pull-off Bar Driving Lever Hinge Screw Nut.....
22199	9099	Lock Stud.....
223F	6990	Thread (lower) Pull-off Bar Driving Lever Lock Stud Screw.....
124788	9096	Thread (lower) Pull-off Bar Guide and Knife Holder.....
1235F	6990	Thread (lower) Pull-off Bar Guide Screw
62128	6990	" " " Holder with 59739.....
62129	6990	Thread (lower) Pull-off Holder Cap with 59739.....
50018F	9052	Thread (lower) Pull-off Holder Cap Screw.....
1547J	9091	Thread (lower) Pull-off Holder Cap Screw Nut.....
59739	6990	Thread (lower) Pull-off Holder Cap Stud
62130	6990	" " " " Connection.....
3021	9091	Thread (lower) Pull-off Holder Connection Rivet.....
59739	6990	Thread (lower) Pull-off Holder Stud
236F	6990	" " " Screw.....
124803	9096	Thread (upper) Pull-off (double).....
202b	9052	" " " Screw.....
7071	6990	" " " " Washer..
121625	---	" Take-up Body with 62172.....

ATTACHMENTS AND ACCESSORIES

NO.	PLATE	NAME
18419	—	Cylinder Base Plate with two 453c.....
18420	7006	“ “ “ Hinge Connection...
18423	7006	“ “ “ “ “ Hinge Pin.....
453c	9052	Cylinder Base Plate Hinge Connection Hinge Pin Set Screw.....
18424	7005	Cylinder Base Plate (hinged) complete, Nos. 18419, two each 18420, 18423, three wood screws 1¼ in. No. 12 and four 134b.....
134b	7006	Cylinder Base Plate Screw.....
120346	7007	Oiler (copper plated) with 120347.....
120347	7007	Oiler Spout, 9 in. long.....
11831	7007	Screw Driver (large).....
26026	7007	“ “ (small).....
4822	7007	Wrench for 1547.....
10875	7007	“ “ 1518, 1520 and 1662.....
17905	7007	“ “ 1681.....
25200	7007	“ “ 1527.....
27902	7007	“ “ 1254 and 1508.....

FOOT LIFTER PARTS

NO.	PLATE	NAME
17876	7005	Treadle with 443c.....
17877	7005	“ Pitman Rod (lower).....
17878	7005	“ “ “ (upper).....
17879	7005	“ “ “ Clamp with two 161b.....
161b	6998	Treadle Pitman Rod Clamp Screw.....
17880	7005	Treadle Pitman complete, Nos. 17877 to 17879.....
17881	7006	Treadle Shaft.....
443c	9052	“ “ Set Screw.....
17882	7006	“ Spring.....
17883	7005	“ Stand.....
17884	—	Treadle complete, Nos. 17876, 17881 to 17883 and two wood screws 1 in. No. 10
17885	—	Treadle and Pitman complete, Nos. 17880 and 17884.....

STAND No. 25295

OBSOLETE, USE 25298

NO.	PLATE	NAME
46673	7241	Brace.....
51009R	9098	“ Bolt with 51571R.....
51571R	9098	“ “ Nut.....
9281R	9098	“ “ “ Washer.....
46674	7247	Leg.....
46675	7241	“ Brace.....
51074R	9098	“ “ Bolt (lower) with 51581R....
51581R	9098	“ “ “ “ Nut.....
9842R	9098	“ “ “ “ “ Washer....
51083R	9098	“ “ “ (upper) with 51581R....
51581R	9098	“ “ “ “ Nut.....
46676	9551	“ “ Bracket (left).....
46677	9551	“ “ “ (right).....
51009R	9098	“ “ “ Bolt with 51571R....
51571R	9098	“ “ “ “ Nut.....
9281R	9098	“ “ “ “ “ Washer....
63925	---	Presser Bar Lifting Lever Treadle with 443c.....
51074R	9098	Presser Bar Lifting Lever Treadle Bolt
51581R	9098	Presser Bar Lifting Lever Treadle Bolt Nut.....
23250R	9098	Presser Bar Lifting Lever Treadle Bolt Nut Washer.....
46699	9100	Presser Bar Lifting Lever Treadle Rest
51083R	9098	“ “ “ “ “ “ Bolt with 51581R.....
51581R	9098	Presser Bar Lifting Lever Treadle Rest Bolt Nut.....
23250R	9098	Presser Bar Lifting Lever Treadle Rest Bolt Nut Washer.....
17881	9098	Presser Bar Lifting Lever Treadle Shaft
443C	9096	“ “ “ “ “ “ Set Screw.....
17882	9098	Presser Bar Lifting Lever Treadle Spring
17883	7005	“ “ “ “ “ Stand
46700	9552	Presser Bar Lifting Lever Treadle com- plete, Nos. 17881 to 17883 and 63925
63925	---	Starting Lever Treadle with 443c.....
51074R	9098	“ “ “ Bolt with 51581R
51581R	9098	“ “ “ “ Nut.....
23250R	9098	“ “ “ “ “ Washer
46699	9100	“ “ “ Rest.....
51083R	9098	“ “ “ “ Bolt with 51581R.....

STANDS

NO.	PLATE	NAME
23250R	9098	Presser Bar Lifting Lever Treadle Bolt Nut Washer.....
46699	9100	Presser Bar Lifting Lever Treadle Rest
51083R	9098	" " " " " "
		Bolt with 51581R.....
51581R	9098	Presser Bar Lifting Lever Treadle Rest Bolt Nut.....
23250R	9098	Presser Bar Lifting Lever Treadle Rest Bolt Nut Washer.....
17881	9098	Presser Bar Lifting Lever Treadle Shaft
443C	9096	" " " " " "
		Set Screw.....
17882	9098	Presser Bar Lifting Lever Treadle Spring
17883	7005	" " " " " Stand
46700	9552	Presser Bar Lifting Lever Treadle complete, Nos. 17881 to 17883 and 63925
126532	9090	Rail, 16 in. long.....
51057R	9099	" Bolt with 1522R.....
1522R	9099	" " Nut.....
126509	9099	" " " Socket Washer.....
12620	9099	" " Washer.....
63925	—	Starting Lever Treadle with 443C.....
51581R	9098	" " " Rest with 51581R
51581R	9098	" " " " Nut.....
23250	9098	" " " " Washer
46699	9100	" " " Rest.....
51083R	9098	" " " " Bolt with 51581R.....
51581R	9098	Starting Lever Treadle Rest Bolt Nut
23250R	9098	" " " " " "
		Washer.....
17881	9098	Starting Lever Treadle Shaft.....
443C	9096	" " " " Set Screw
17882	9098	" " " Spring.....
17883	7005	" " " Stand.....
46700	9552	Starting Lever Treadle complete, Nos. 17881 to 17883 and 63925.....
46711	9090	Treadle Support.....
50297R	9099	" " Bolt with 1522R.....
46712	—	" " " 50297R with 12620 and 46713.....
1522R	9099	Treadle Support Bolt Nut.....
46713	9100	" " " Packing.....
12620	9099	" " " Washer.....
25298	—	Stand (steel work) complete, Nos. 46711, two each 46699, 46700, 46707, 46712, 126758, four 51088R, eight 51083R and twenty 23250R.....

NO.	PLATE	NAME
51581E	9098	Machine Hinge (right) Bracket Bolt Nut
23250	9098	“ “ “ “ “ “ Washer.....
24620	9099	Machine Hinge (right) Hinge Pin.....
124811	—	Machine Hinge (right) complete, Nos. 24620, 124808 and 124810.....
5670	—	Presser Bar Lifting Lever Chain, length 26 in. to 35 in., with 56864 and 56865..
6439	—	Starting Lever Chain, length 36 in. to 45 in., with 56864 and 56865.....
NOTE: When ordering Nos. 5670 and 6439 give length required.		
56864	7007	Chain Hook (large).....
56865	7006	“ “ (small).....
124813	9097	Starting Lever Chain Guard.....
62164	9097	“ “ “ Pulley.....
729F	9097	“ “ “ “ Hinge Screw
1608C	9099	“ “ “ “ “ “ Nut.....
124814	9097	Table Sliding Section Retaining Washer with two wood screws $\frac{5}{8}$ in. No. 7....
124815	9552	Table Support with three wood screws $1\frac{1}{2}$ in. No. 14
124816	9552	Table Work Clamp.....
124817	9100	“ “ “ Hanger (back) with two wood screws 1 in. No. 10.....
20093	9100	Table Work Clamp Hanger (front) with two wood screws 1 in. No. 10
124818	9551	Table Work Clamp Spring.....
124819	9097	“ “ “ “ Arm with 361C
361C	9097	“ “ “ “ “ Set Screw
124820	9097	“ “ “ “ Stop Collar with 362F
362F	9097	“ “ “ “ “ Set Screw

Genuine Singer Needles and their Containers are marked with the Company's Trade Mark "SIMANCO."
1

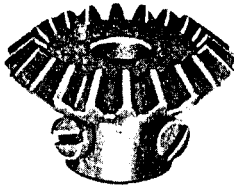
Needles in Containers marked "For Singer Machines" are not Singer made needles.
2

PLATE 6976—FULL SIZE

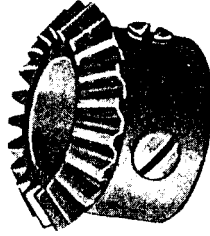
59704



59708



59703



59706



1036



39223



1253



4448



1255



59705



56015



59707



16532

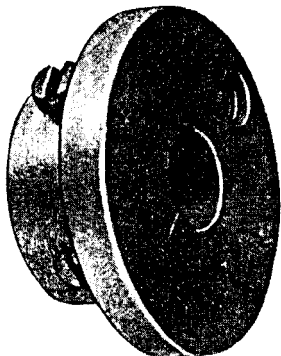


21828



PLATE 6992—FULL SIZE

59757



1293



17841



448



196



377



39203



2052



15372



103



1536



59747

52045

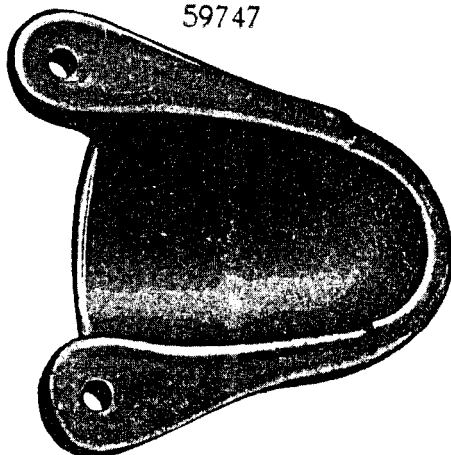


PLATE 6998—FULL SIZE

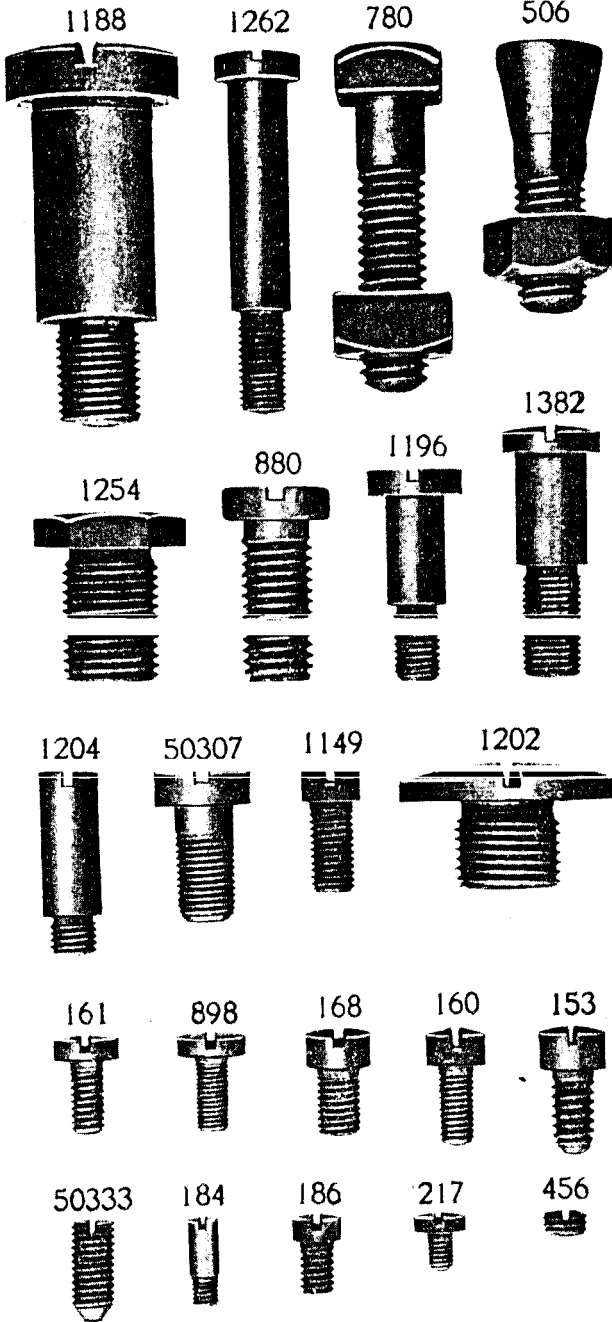


PLATE 7006—FULL SIZE

60771



17881



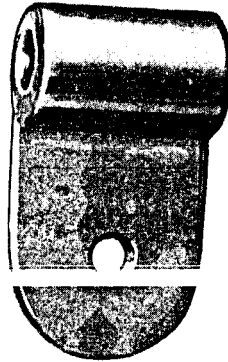
18423



17882



18420



41515

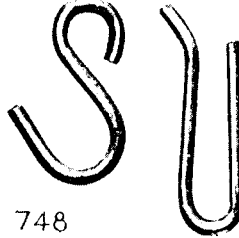


17896



50805

41500



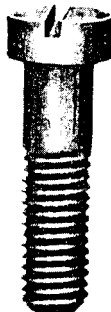
175



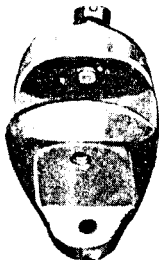
25127



748



4-1635



134



1201

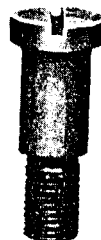


PLATE 7008—ONE-HALF SIZE

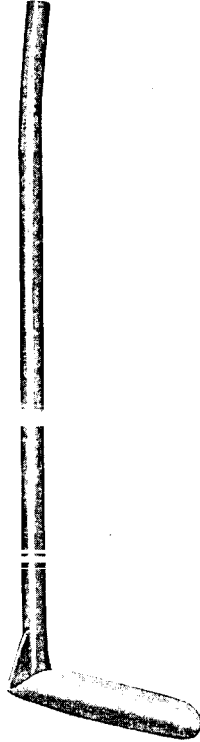
39494



39496



39489



39491

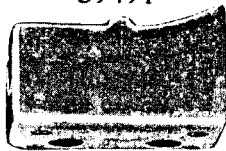
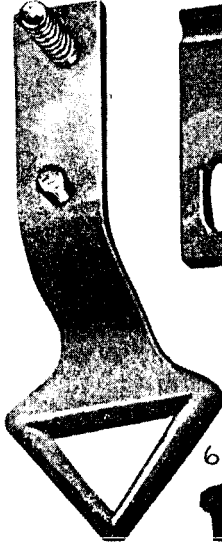


PLATE 7026—FULL SIZE

1178



62174



17710



62258



1176



17714



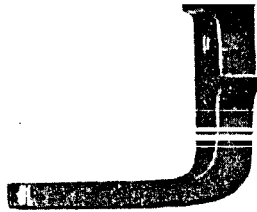
62261



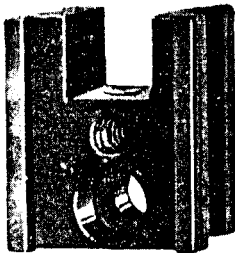
1177



201



17713



62260

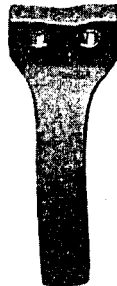
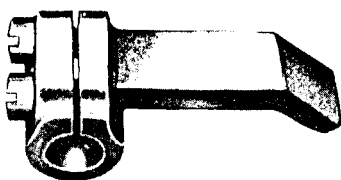
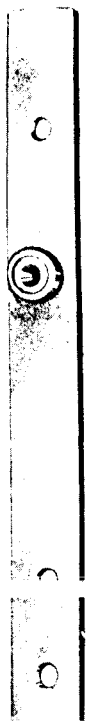


PLATE 7037-FULL SIZE

124729

11622

124711



17710

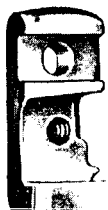
1695



59710

19694

124780



124679

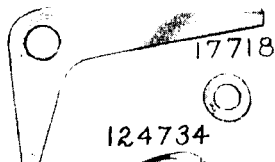
124823



124680



124733

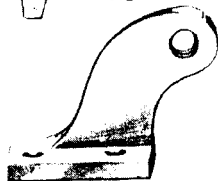


17718

124734

124735

124736



62111

124744

62185



62113

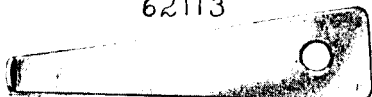


PLATE 7041—FULL SIZE

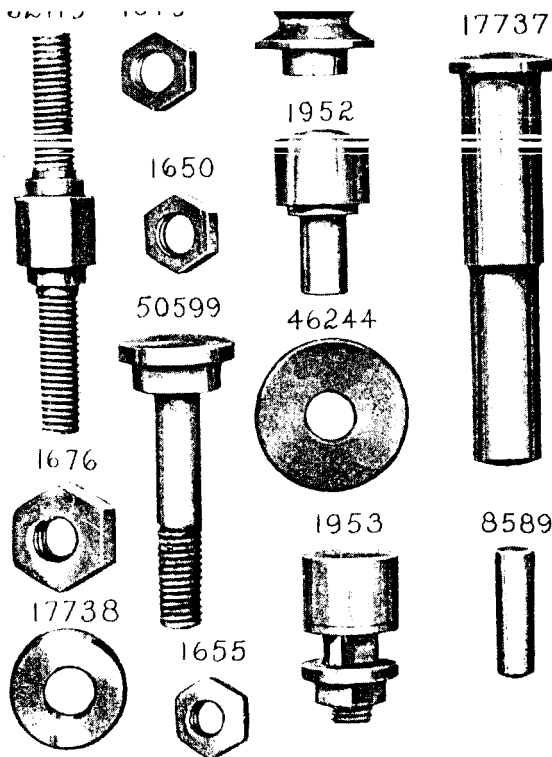
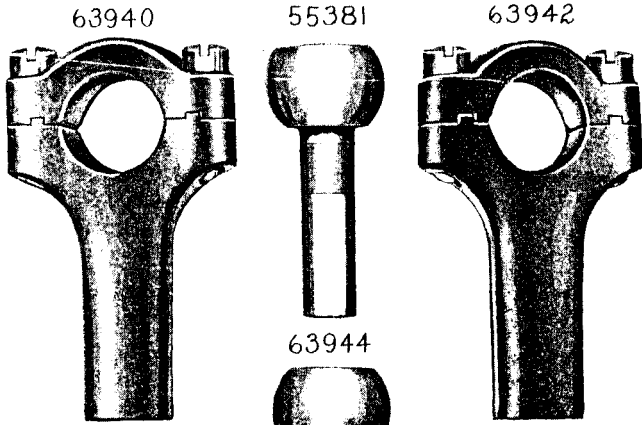
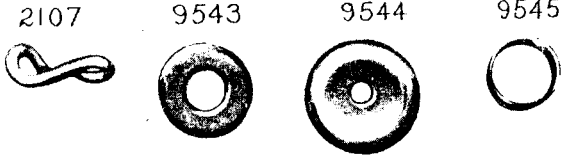


PLATE 7047—ONE-HALF SIZE

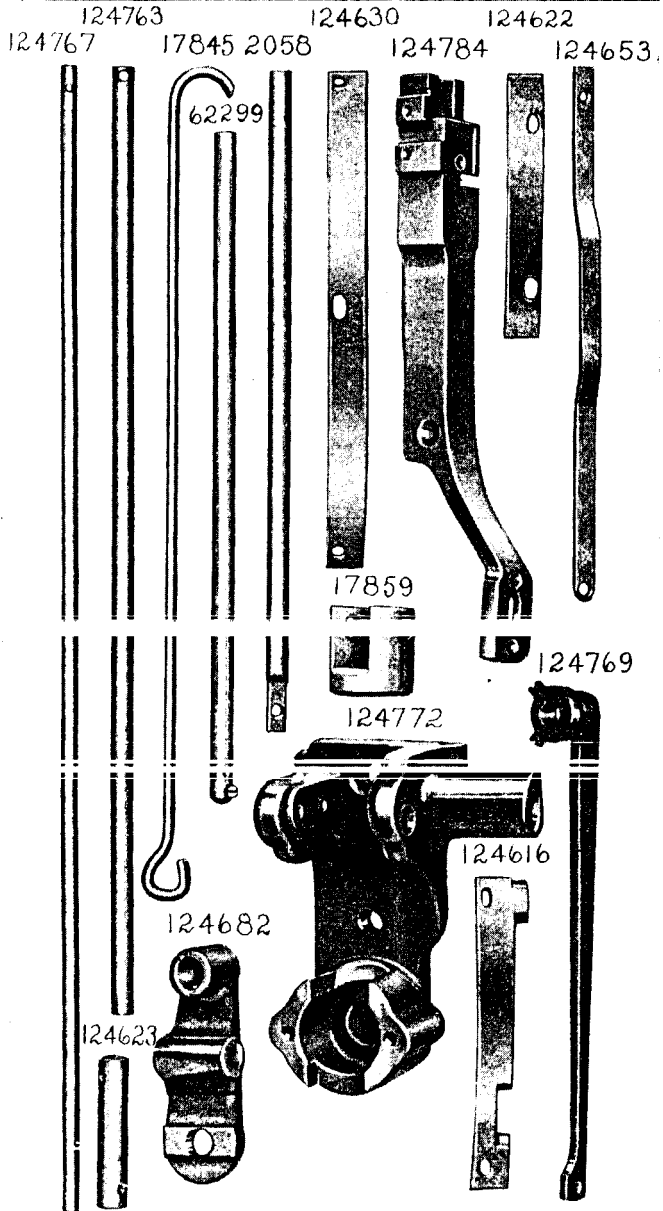


PLATE 7050—FULL SIZE

124610 124607 124609 124608 124615 6037

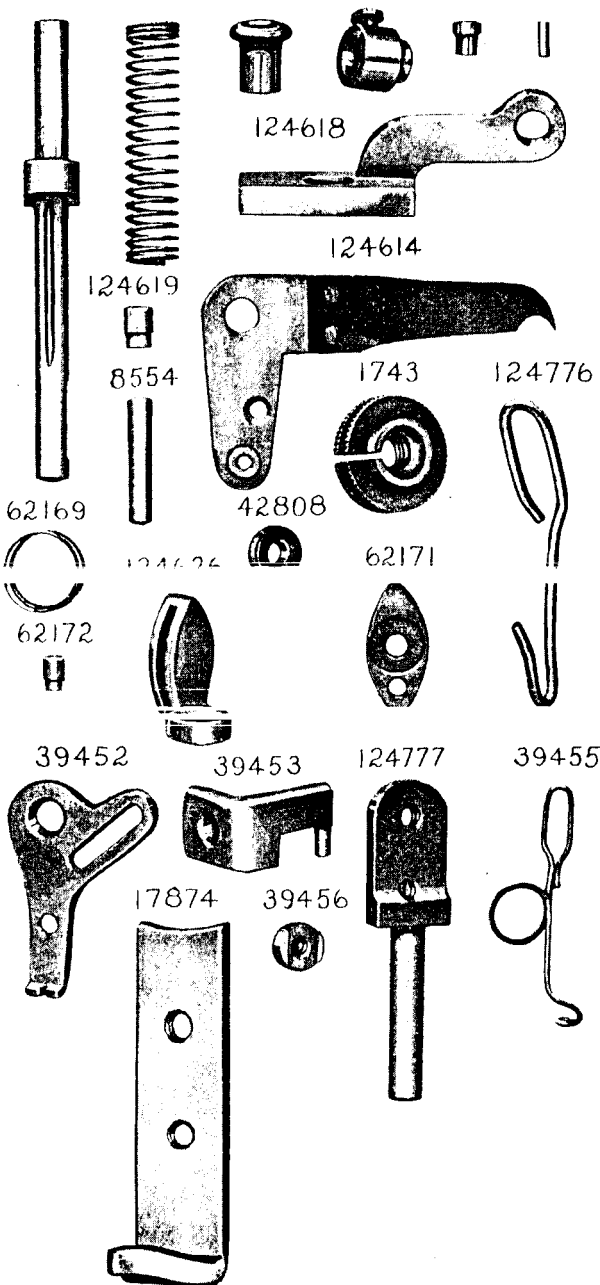


PLATE 7241—ONE-NINTH SIZE

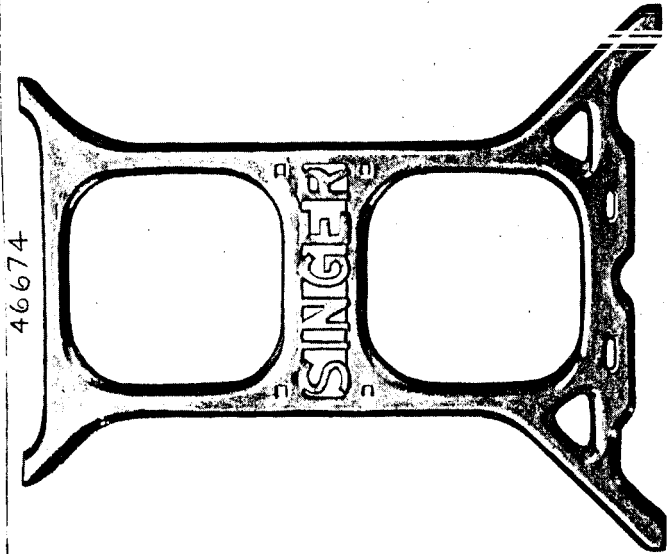
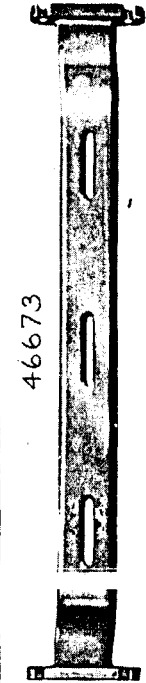
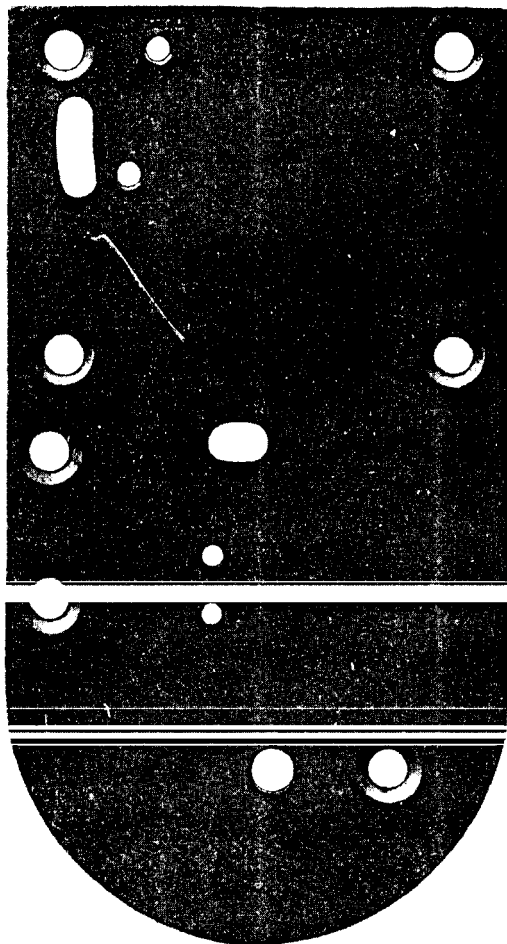


PLATE 9051—FULL SIZE

124789



124778



PLATE 9053—FULL SIZE

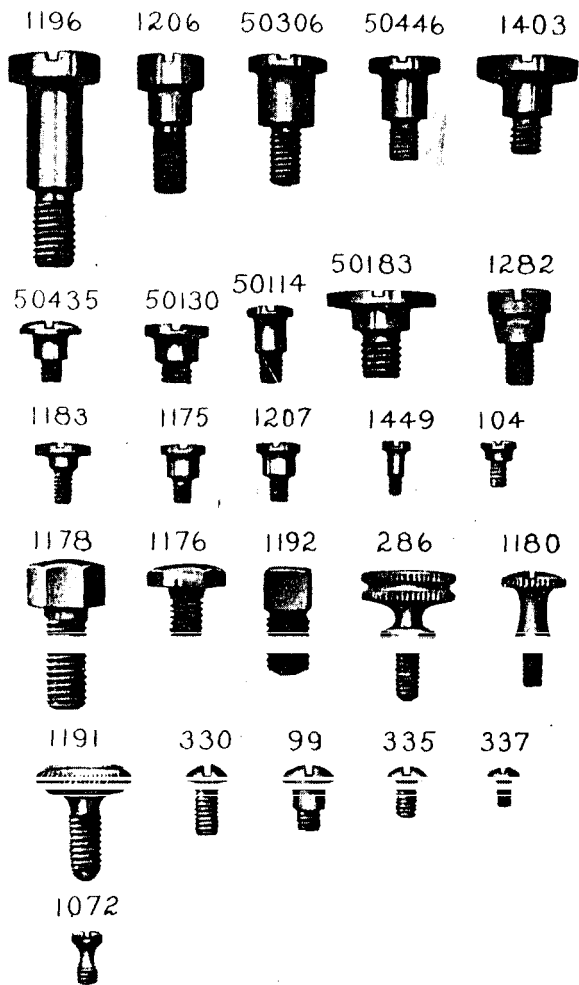
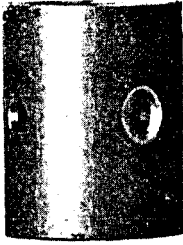
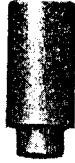


PLATE 9080—FULL SIZE

17703



59796



63976



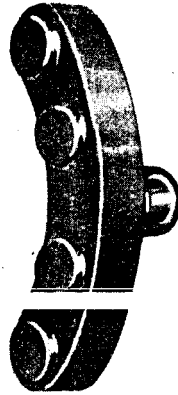
1520



1293



124713



124714



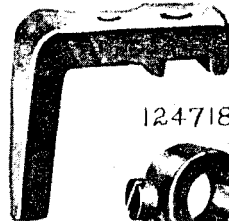
124715



124717



124906



124718



56493



20437



124719

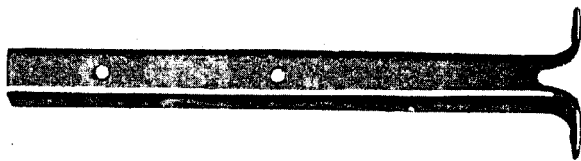


792

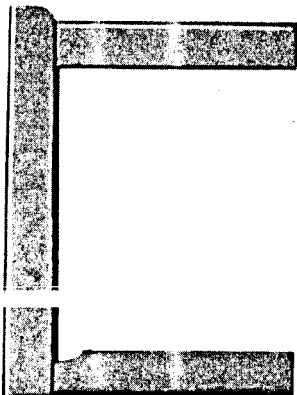


PLATE 9090—ONE-EIGHTH SIZE

126508



126532



126530



4671

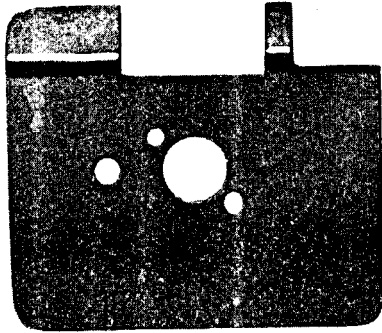


46707

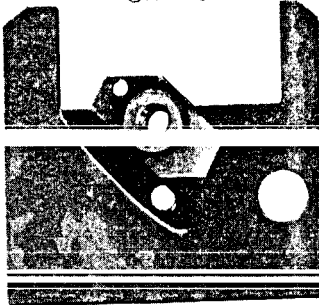


PLATE 9092—FULL SIZE

124660



62149



124745



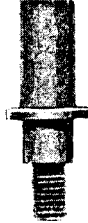
1094



55300



50324



62152



62153



18384



14017



17806



1195



1681



1655

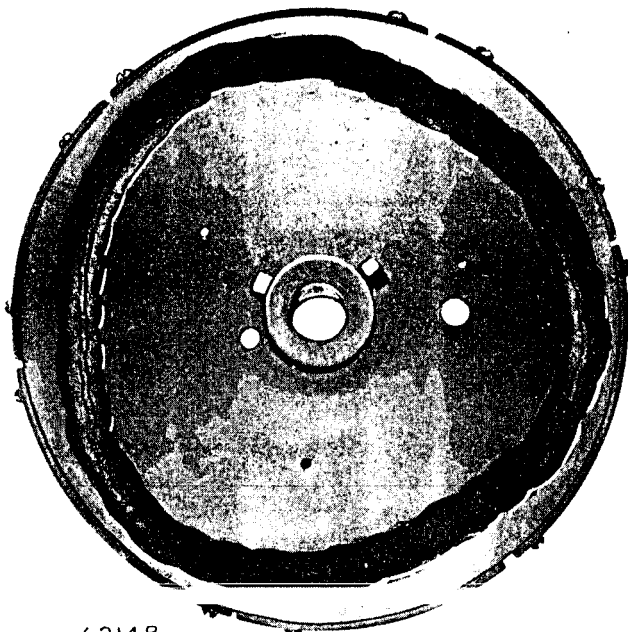


1654

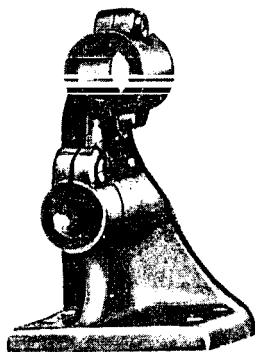


PLATE 9094—ONE-HALF SIZE

124801



62148



124847

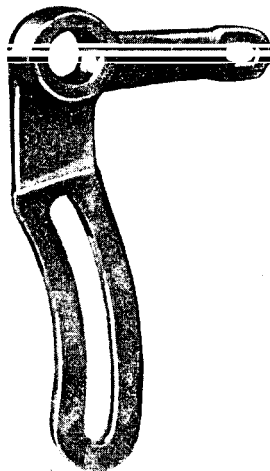
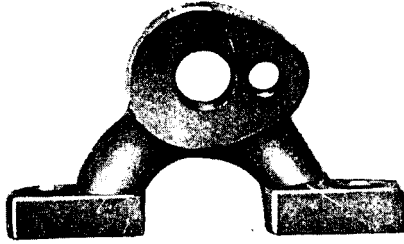
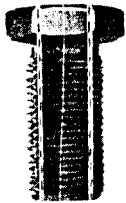


PLATE 9096—FULL SIZE

124793



51120



124805



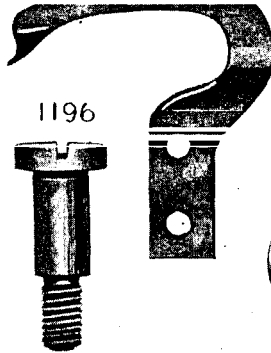
124803



17872



124804



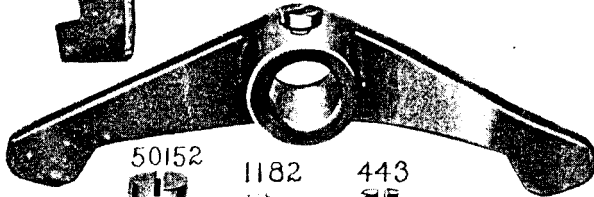
1196



124788



124621



50152



1182

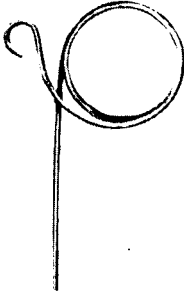


443

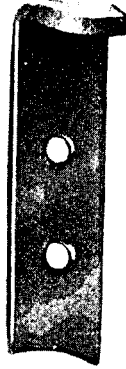


PLATE 9098—FULL SIZE

17873



17874



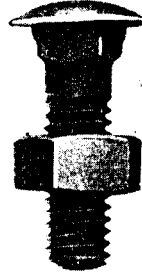
51571



17881



51009



51083



51074



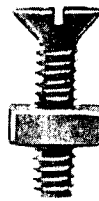
17882



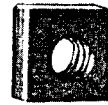
51082



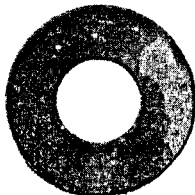
51088



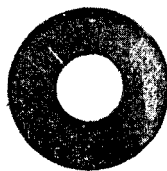
51581



9281



9842

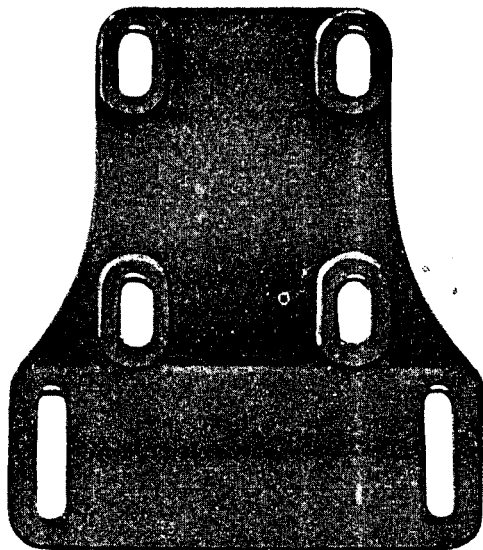


23250

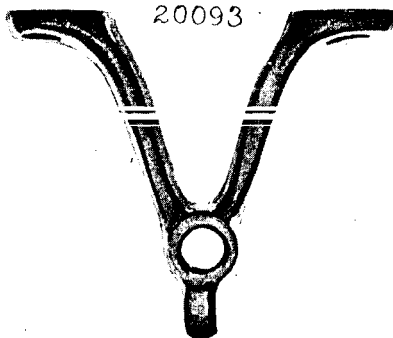


PLATE 9100—ONE-HALF SIZE

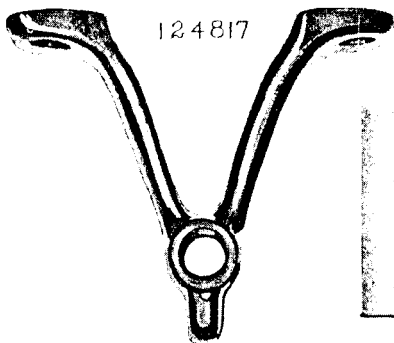
46699



20093



124817



46713

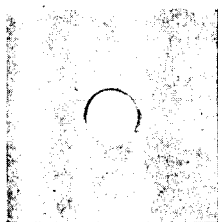
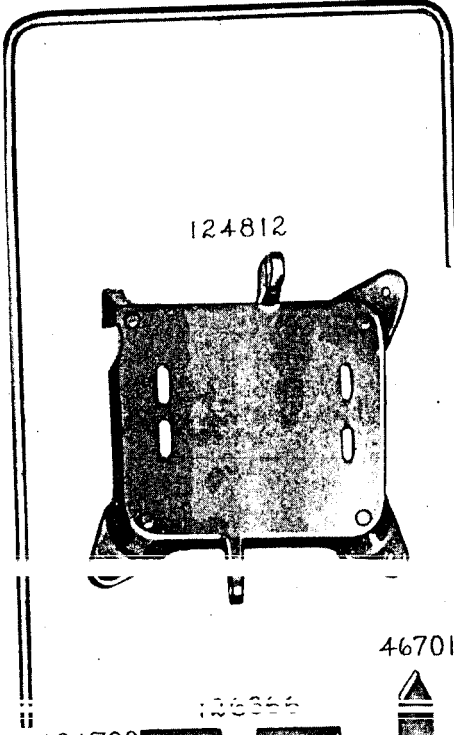


PLATE 9552—ONE-SIXTH SIZE

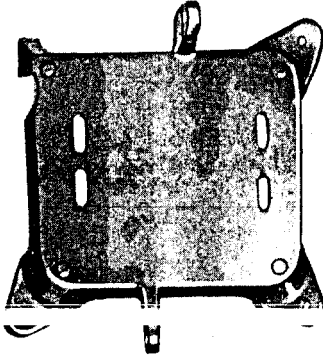
124816



124815



124812



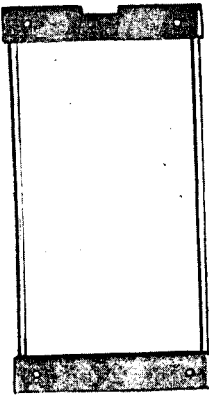
46701



124790



126856



46700

