

# PRICE LIST

OF

# PARTS



**MACHINES Nos. 6-11, 6-12,  
6-14 AND 6-15**

---

**THE SINGER MANUFACTURING COMPANY**

COPYRIGHT  
U. S. A.,  
1916 and 1918  
BY  
THE SINGER MANUFACTURING CO.  
ALL RIGHTS RESERVED FOR ALL COUNTRIES.

## INDEX

---

	PAGE
ACCESSORIES.....	27
BELT SHIFTER PARTS.....	25
BOBBIN WINDERS.....	27
DRIVING ATTACHMENT PARTS.....	26
MACHINE No. 6-11.....	7
"    "    6-12.....	14
"    "    6-14.....	15
"    "    6-15.....	25
NUMERICAL LIST OF PARTS.....	33
OBSOLETE PARTS.....	29

## INSTRUCTIONS FOR ORDERING

In ordering from this list, use **ONLY** the part NUMBER in the **FIRST** column.

The number stamped on a Sewing Machine part is in every case the number of the single part only.

Every combination of parts sent out as such has its specific number, which, although not stamped on the parts, must be used when ordering the combination.

Each number always indicates the **SAME PART** in whatever list it appears, or for whatever machine.

The letters after some of the numbers indicate the style of finish only, as follows:

- A. Hardened, Polished and Plated.
- B. Polished and Plated.
- C. Hardened only.
- D. Polished only.
- E. Soft, not Polished.
- F. Hardened and Polished.
- G.
- H. Blued.
- J. Plated only.
- K. Hardened and Plated.
- L. Brass or Gilt.
- M. Oxidized.
- P. Japanned.

These letters **MUST BE USED** when they appear in the list, and **AFTER** the number *as* in the list.

### In this series

- 1 to 1500 and 50001 to 51500 are Screw Numbers.
- 1501 to 1800 are Nut Numbers.
- 1801 to 2000 are Roller Numbers.
- 2001 to 50000 and 52001 and upward are numbers of Machine Parts.

The figures in the second column refer only to the plates, illustrating the parts, and are **NOT TO BE USED** in ordering.

Parts marked with an asterisk (\*) are furnished only when repairs are made at factory.

## LIST OF PARTS COMPLETE

FOR

## MACHINE NO. 6-11

FOR STITCHING BUFF WHEELS FOR POLISHING. MAKES CIRCULAR ROWS OF STITCHES  $\frac{1}{16}$  IN. BETWEEN ROWS UNLESS OTHERWISE ORDERED AND IN COTTON GOODS UP TO 1 INCH THICK AND 18 INCHES DIAMETER. THE BUFF IS MOVED BY HAND FROM THE FINISHED ROW TO THE BEGINNING OF THE NEXT. HAS DROP FEED, VIBRATING PRESSER AND S. D. A.

NO.	PLATE	NAME	EACH
*64019	—	Arm.....	\$35 00
8702	7250	" Dowel Pin.....	15
9207	7250	" Oil Tube for oiling 9150.....	10
50349e	7274	" Screw.....	15
43263	7270	" " Washer.....	05
9196	7251	" Shaft.....	8 50
9208	7273	" " Bushing.....	1 00
434c	7275	" " " Set Screw.....	04
9105	7252	" Side Cover.....	25
65d	7275	" " " Hinge Screw.....	12
8708	7250	" Spool Pin.....	05
11241	7263	" " " Washer (cloth).....per 100	25
8982	7253	Balance Wheel with two 344c.....	4 00
8983	7250	" " Pin.....	10
344c	7276	" " " Set Screw.....	08
*9223	—	Bed.....	35 00
11054	7251	Crank Connecting Rod with 9141 and two 575e.....	1 75
*9141	—	Crank Connecting Rod Cap.....	75
575e	7276	" " " " Screw.....	05
369c	7276	" " " " Hinge Screw.....	20
1509e	7275	" " " " " Nut.....	06
9047	7259	Feed Bar.....	3 00
304c	7276	" " Screw Centre.....	06
1513j	7263	" " " " Nut.....	05
8994	7255	" Cam with two 432c.....	1 00
432c	7275	" " " Set Screw.....	04
8927	7255	" Connecting Link.....	75
1078c	7276	" " " Hinge Screw for 8930.....	20
369c	7276	Feed Connecting Link Hinge Screw for 9058.....	20

NO.	PLATE	NAME	EACH
1509E	7275	Feed Connecting Link Hinge Screw Nut...	\$ 06
64022	7305	" Dog.....	1 00
166D	7275	" " Screw.....	07
9058	7252	" Forked Connection.....	2 00
369C	7276	" " " Hinge Screw...	20
1509E	7275	" " " " Nut.....	06
64014	7251	" Lifting Rock Shaft with 134D, 2022 and 19967.....	1 75
64015	---	Feed Lifting Rock Shaft complete, Nos. 64014 and 64016.....	4 25
64016	7255	Feed Lifting Rock Shaft Crank with 611D, 1619E and 1926.....	2 50
611D	7276	Feed Lifting Rock Shaft Crank Clamping Screw.....	12
1926	7260	Feed Lifting Rock Shaft Crank Roller with 962C.....	35
962C	7276	Feed Lifting Rock Shaft Crank Roller Screw.....	15
1619E	7275	Feed Lifting Rock Shaft Crank Roller Screw Nut.....	05
1015C	7276	Feed Lifting Rock Shaft Screw Centre (left).....	15
1503E	7275	Feed Lifting Rock Shaft Screw Centre (left) Nut.....	10
294C	7276	Feed Lifting Rock Shaft Screw Centre (right).....	18
1503E	7275	Feed Lifting Rock Shaft Screw Centre (right) Nut.....	10
19967	7263	Feed Lifting Rock Shaft Wearing Block	35
2022	7250	" " " " " " " " Position Pin.....	01
134D	7275	Feed Lifting Rock Shaft Wearing Block Screw.....	05
8930	7255	Feed Regulator.....	75
17E	7276	" " Hinge Screw.....	20
50322D	7274	" " Thumb Screw.....	40
9054	7251	" Rock Shaft.....	3 25
64017	---	Feed Rock Shaft complete, Nos. 9054 and 9211.....	4 25
9211	7255	Feed Rock Shaft Crank with 50124D.....	1 00
50124D	7276	" " " " Clamping Screw.....	12
1015C	7276	" " " " Screw Centre.....	15
1503E	7275	" " " " " " Nut.....	10
19634	7306	Guide Pin, for circular stitching.....	35
9145	7298	Lifting Presser Bar.....	1 25
9146	7299	" " " Bell Crank.....	7 50

NO.	PLATE	NAME	EACH
9147	---	Lifting Presser Bar Bell Crank complete, Nos. 611C, 9146 and 11025.....	\$9 75
11025	7298	Lifting Presser Bar Bell Crank Adjusting Arm with 1513J and 1882.....	2 00
1882	7300	Lifting Presser Bar Bell Crank Adjusting Arm Roller with 604C.....	45
604C	7300	Lifting Presser Bar Bell Crank Adjusting Arm Roller Screw.....	15
1513J	7263	Lifting Presser Bar Bell Crank Adjusting Arm Roller Screw Nut.....	05
611C	7276	Lifting Presser Bar Bell Crank Adjusting Arm Screw.....	12
752D	7300	Lifting Presser Bar Bell Crank Hinge Screw.....	40
1595E	7300	Lifting Presser Bar Bell Crank Hinge Screw Nut.....	08
8715	7300	Lifting Presser Bar Bell Crank Hinge Screw Nut Washer.....	25
9214	7260	Lifting Presser Bar Bushing.....	75
448C	7263	" " " " Set Screw.....	03
9148	7301	" " " " Collar with 453C.....	15
2022	7250	" " " " " Pin.....	01
453C	7263	" " " " " Set Screw.....	02
9108	7301	" " " " Connecting Stud with 523C.....	2 00
523C	7276	Lifting Presser Bar Connecting Stud Set Screw.....	15
11071	7298	Lifting Presser Bar Guide Bracket with 145D, 193E, 434C and 445C.....	3 00
145D	7275	Lifting Presser Bar Guide Bracket Adjusting Screw.....	04
9110	7267	Lifting Presser Bar Guide Bracket Guide	1 00
135D	7275	" " " " " " " " Screw.....	05
434C	7275	Lifting Presser Bar Guide Bracket Set Screw (long).....	04
445C	7275	Lifting Presser Bar Guide Bracket Set Screw (short).....	03
16996	7267	Lifting Presser Bar Lifter with 8761 and 8763.....	1 25
8760	7250	Lifting Presser Bar Lifter Friction Washer	03
16D	7274	" " " " Hinge Screw...	20
8761	7250	" " " " Stop Pin.....	05
64020	7299	" " " " Lifting Link.....	50
64021	7301	" " " " " H i n g e Stud (lower).....	40

NO.	PLATE	NAME	EACH
8973	7250	Lifting Presser Bar Lifting Link Hinge Stud (lower) Pin.....	\$ 05
8765	7250	Lifting Presser Bar Lifting Link Hinge Stud (lower) Washer.....	04
8763	7250	Lifting Presser Bar Lifting Link Hinge Stud (upper).....	25
8973	7250	Lifting Presser Bar Lifting Link Hinge Stud (upper) Pin.....	05
8765	7250	Lifting Presser Bar Lifting Link Hinge Stud (upper) Washer.....	04
9021	7273	Lifting Presser Bar Spring (spiral).....	25
11031	7252	" " " " (flat).....	1 50
58252	7267	" " " " Bracket for 11031.....	25
1177d	7275	Lifting Presser Bar Spring Bracket Screw	04
4389	7250	" " " " Guide Pin for 11031.....	02
50323d	7274	Lifting Presser Bar Spring Regulating Screw.....	10
1606E	7275	Lifting Presser Bar Spring Regulating Screw Lock Nut.....	05
8745	7259	Needle Bar.....	1 50
9214	7260	" " Bushing.....	75
448c	7263	" " " Set Screw.....	03
8746	7259	" " Connecting Link.....	1 25
370c	7276	" " " " Hinge Screw	18
1509E	7275	" " " " " " Nut.....	06
32875	7301	Needle Bar Connecting Stud with two 1149F.....	3 00
1149F	7275	Needle Bar Connecting Stud Clamping Screw.....	04
9060	7260	Needle Clamp with 149F and 8749.....	90
8749	7260	" " Gib.....	25
149F	7260	" " Screw.....	06
16989	7251	Oil Cup.....	80
11917	7251	" " Cover.....	25
9084	7260	" " " Hinge Pin.....	02
2205	7260	" " " Latch Spring.....	04
207F	7260	" " " " " Screw.....	02
11919	7260	" " Thread Eyelet.....	05
8953	7260	" or Wax Stripper (felt).....	03
11918	7260	" " " Washer (steel) for 11917.....	03
8482	7260	Oil or Wax Stripper Washer (steel) for 16989.....	01

NO.	PLATE	NAME	EACH
207F	7260	Oil or Wax Stripper Washer Screw.....	\$ 02
16990	7251	Oil Cup complete, Nos. 2205, 8482, 9084, 11917 to 11919, 16989, two 8953 and three 207F.....	1 25
134D	7275	Oil Cup Screw.....	05
9150	7259	Oscillating Rock Shaft.....	7 50
9151	—	Oscillating Rock Shaft complete, Nos. 654c, 9115, 9150, 11165 and two 1503E.....	9 25
9115	7259	Oscillating Rock Shaft Hinge Pin.....	1 25
1503E	7275	" " " " " Nut.....	10
654c	7276	" " " " " Screw	25
1503E	7275	Bearing.....	25
1503E	7275	Oscillating Rock Shaft Hinge Pin Screw Bearing Nut.....	10
11165	7263	Oscillating Rock Shaft Oil Pad.....	01
9116	7252	" Shaft.....	2 00
9152	7263	" " Collar with two 448c.....	30
448c	7263	" " " Set Screw.....	03
9153	—	" " Crank.....	2 00
9154	7255	Oscillating Shaft Crank complete, Nos. 445c, 1513J, 9120 and 9153.....	2 70
9216	7263	Oscillating Shaft Crank Pin.....	05
445c	7275	" " " Set Screw.....	03
9119	7263	" " " Slide Block.....	35
9120	7263	Oscillating Shaft Crank Slide Block complete, Nos. 190D, 1016c, 5968 and 9119.....	60
190D	7263	Oscillating Shaft Crank Slide Block Cap Screw.....	03
5968	7263	Oscillating Shaft Crank Slide Block Cap Screw Washer.....	02
1016c	7263	Oscillating Shaft Crank Slide Block Screw Stud.....	25
1513J	7263	Oscillating Shaft Crank Slide Block Screw Stud Nut.....	05
11910	7268	Shuttle Bobbin.....	25
19977	7268	" Cylinder.....	1 50
8961	7268	" " Hinge Pin.....	02
11853	7268	" " Latch.....	15
12002	7268	" " " Pin.....	01
19869	7268	" " " Spring.....	01
19978	7268	" Frame.....	1 75
773H	7268	" Tension Regulating Screw.....	05
19979	7268	" " Spring.....	40
19980	7268	Shuttle (cylinder) 3 in. diam., complete, Nos. 773H, 8961, 11853, 11910, 12002, 19869 and 19977 to 19979.....	4 00
8965	7259	Shuttle Driver with 445c.....	3 00

NO.	PLATE	NAME	EACH
9216	7263	Shuttle Driver Pin.....	\$ 05
445c	7275	" " Set Screw.....	03
11832	7255	" Race Back.....	1 00
11833	7250	" " " Position Pin.....	01
11834	7255	" " " Spring.....	25
32d	7275	" " " Screw.....	10
9098	7252	" " Body.....	2 75
9100	—	Shuttle Race (flexible back) complete, Nos. 32d, 9098, 11832, 11834 and two 11833.....	4 00
134d	7275	Shuttle Race Screw.....	05
9099	7252	" " Frame with 11838.....	2 00
123e	7276	" " " Clamping Screw.....	06
11838	7250	" " " Position Pin.....	03
8786	7270	Tension Disc.....	15
1535e	7270	" Regulating Thumb Nut.....	10
8787	7270	" " " " Washer.....	01
406e	7270	" Screw Stud.....	25
8788	7270	" Spring.....	25
8785	—	Tension complete, Nos. 406e, 1535e, 8787, 8788 and two 8786.....	90
11950	7301	Thread Eyelet (side of arm).....	05
9123	7302	" Take-up Cam with two 432c.....	8 50
8714	7250	" " " Pin.....	15
432c	7275	" " " Set Screw.....	04
9218	7259	" " Lever with 1513j, 1883 and 9219.....	2 25
10b	7274	Thread Take-up Lever Hinge Screw.....	25
1883	7275	" " " Roller and Screw Stud.....	35
1513j	7263	Thread Take-up Lever Roller and Screw Stud Nut.....	05
9219	7250	Thread Take-up Lever Thread Eyelet Bushing.....	25
9124	7263	Thread Take-up Spring.....	15
8799	7260	" " " Regulator.....	15
164d	7275	" " " " Screw.....	04
41544	7250	" " " " " Washer.....	05
9186	7301	Thread Take-up Staple.....	20
690d	7275	" " " Screw.....	05
41544	7250	" " " " Washer.....	05
64023	7307	Throat Plate with 225f and 64021, for 64022.....	7 00
64024	7305	Throat Plate Needle Plate.....	75
225f	7275	" " " " Screw.....	03
381d	7275	" " " Screw.....	06

NO.	PLATE	NAME	EACH
9127	7299	Vibrating Presser Bar with 9131 and two 9291.....	\$2 00
11509	7301	Vibrating Presser Bar Cushion (rawhide)	01
233d	7301	" " " " Screw.....	02
9128	7299	" " " Guide Bracket with 451c.....	1 25
9129	—	Vibrating Presser Bar Guide Bracket complete, Nos. 9128, 9130 and two 164d	1 50
9130	7299	Vibrating Presser Bar Guide Bracket Cap with 19614.....	20
164d	7275	Vibrating Presser Bar Guide Bracket Cap Screw.....	04
2117	7250	Vibrating Presser Bar Guide Bracket Pin.	01
451c	7300	" " " " " Set Screw.....	03
11072	7301	Vibrating Presser Bar Hinge Stud.....	25
193f	7301	" " " " " S e t Screw.....	03
8734	7270	Vibrating Presser Bar Spring.....	08
9131	7299	" " " " B r a c k e t with 19614.....	50
9291	7250	Vibrating Presser Bar Spring Bracket Rivet.....	01
19614	7250	Vibrating Presser Bar Spring Hook.....	05
9089	7301	" " Foot.....	2 50
690d	7275	" " " Screw.....	05
1654c	7301	" " " " Nut.....	04

For Driving Attachment see Page 28.

## MACHINE NO. 6-12

HAS BELT SHIFTER FOR FLAT BELT, OTHERWISE SAME AS  
MACHINE NO. 6-11

NO.	PLATE	NAME	EACH
9144	7251	Arm Shaft, in place of 9196.	\$8 50

For Belt Shifter Parts see Page 27.

## LIST OF PARTS COMPLETE

FOR

## MACHINE NO. 6-14

FOR BUFF WHEELS UP TO  $\frac{5}{8}$  INCH THICK AND 18 INCHES DIAMETER.  
MAKES CIRCULAR ROWS OF STITCHING FROM  $\frac{1}{16}$  TO  $\frac{1}{2}$  INCH  
BETWEEN THE LINES OF STITCHING AS ORDERED, AND  
AUTOMATICALLY CHANGES FROM ONE FINISHED LINE  
OF STITCHING TO THE OTHER, THE BUFF BEING  
COMPLETELY STITCHED BEFORE STOPPING  
THE MACHINE. DROP FEED, VIBRATING  
PRESSER AND S. D. A.

NO.	PLATE	NAME	EACH
*64019	—	Arm.....	\$35 00
8702	7250	" Dowel Pin.....	15
9207	7250	" Oil Tube for oiling 9150.....	10
50349E	7274	" Screw.....	15
43263	7270	" " Washer.....	05
9196	7251	" Shaft.....	8 50
9208	7273	" " Bushing.....	1 00
434c	7275	" " " Set Screw.....	04
9105	7252	" Side Cover.....	25
65D	7275	" " " Hinge Screw.....	12
8708	7250	" Spool Pin.....	05
11241	7263	" " " Washer (cloth)..... per 100	25
8982	7253	Balance Wheel with two 344c.....	4 00
8983	7250	" " " Pin.....	10
344c	7276	" " " Set Screw.....	08
*9157	—	Bed.....	30 00
*9158	—	" Extension with 19633.....	6 00
8873	7250	" " Dowel Pin.....	05
123E	7276	" " Screw.....	06
9159	4442	Buff Wheel Clamp Carrier with 19614....	2 00
9160	4442	" " " " Cap.....	75
691F	7308	" " " " " Screw.....	04
19614	7250	" " " " Hook.....	05
9161	4442	" " " " Locking Rack with 9164 and two 1804.....	3 50
NOTE. When ordering No. 9161 state distance between rows of stitching.			
19602	7309	Buff Wheel Clamp Carrier Locking Rack Bracket with two 453c.....	1 50
19603	7310	Buff Wheel Clamp Carrier Locking Rack Bracket Hinge Pin.....	25

NO.	PLATE	NAME	EACH
2022	7250	Buff Wheel Clamp Carrier Locking Rack Bracket Hinge Pin Dowel Pin.....	\$ 01
453c	7263	Buff Wheel Clamp Carrier Locking Rack Bracket Hinge Pin Set Screw.....	02
19604	—	Buff Wheel Clamp Carrier Locking Rack Bracket Latch complete, Nos. 19605 to 19608.....	1 35
19605	7310	Buff Wheel Clamp Carrier Locking Rack Bracket Latch Body with 453c.....	75
2022	7250	Buff Wheel Clamp Carrier Locking Rack Bracket Latch Body Pin.....	01
453c	7263	Buff Wheel Clamp Carrier Locking Rack Bracket Latch Body Set Screw.....	02
19606	7306	Buff Wheel Clamp Carrier Locking Rack Bracket Latch Pin.....	30
19607	7306	Buff Wheel Clamp Carrier Locking Rack Bracket Latch Pin Head.....	25
19608	7308	Buff Wheel Clamp Carrier Locking Rack Bracket Latch Spring.....	05
381d	7275	Buff Wheel Clamp Carrier Locking Rack Screw.....	06
19609	7305	Buff Wheel Clamp Carrier Sliding Flange with 453c.....	75
19611	7306	Buff Wheel Clamp Carrier Sliding Flange Gear with 462c.....	75
2049	7261	Buff Wheel Clamp Carrier Sliding Flange Gear Pin.....	01
462c	7306	Buff Wheel Clamp Carrier Sliding Flange Gear Set Screw.....	02
2049	7261	Buff Wheel Clamp Carrier Sliding Flange Pin.....	01
453c	7263	Buff Wheel Clamp Carrier Sliding Flange Set Screw.....	02
7585	4442	Buff Wheel Clamp Carrier Sliding Flange Shaft.....	05
9162	4442	Buff Wheel Clamp Carrier Sliding Rack with 9164.....	2 00
NOTE: When ordering No. 9162 state distance between rows of stitching.			
9163	4442	Buff Wheel Clamp Carrier Sliding Rack Cap.....	60
1885	7308	Buff Wheel Clamp Carrier Sliding Rack Cap Roller with 190b, 1054c and 5968.	40
190b	7263	Buff Wheel Clamp Carrier Sliding Rack Cap Roller Cap Screw.....	03

NO.	PLATE	NAME	EACH
5968	7263	Buff Wheel Clamp Carrier Sliding Rack Cap Roller Cap Screw Washer.....	\$ 02
1054c	7308	Buff Wheel Clamp Carrier Sliding Rack Cap Roller Screw Stud.....	20
1513j	7263	Buff Wheel Clamp Carrier Sliding Rack Cap Roller Screw Stud Nut.....	05
166b	7275	Buff Wheel Clamp Carrier Sliding Rack Cap Screw.....	07
1804	7308	Buff Wheel Clamp Carrier Sliding Rack Roller and Stud.....	25
8734	7270	Buff Wheel Clamp Carrier Sliding Rack Spring.....	08
9164	7308	Buff Wheel Clamp Carrier Sliding Rack Spring Hook.....	05
657E	7308	Buff Wheel Clamp Carrier Sliding Rack Stop Screw.....	10
9165	7305	Buff Wheel Clamp Carrier Stop.....	30
9166	7310	“ “ “ “ “ Plate....	35
691F	7308	“ “ “ “ “ Screw....	04
164E	7275	“ “ “ “ “ Screw....	04
19617	7311	“ “ “ “ “ Weight (3¼ lbs.) with 19624 and 19625.....	30
19618	7311	Buff Wheel Clamp Carrier Weight (4½ lbs.) with 19624 and 19625.....	35
19619	—	Buff Wheel Clamp Carrier Weight Con- nection (belt) with 19621.....	10
19620	7312	Buff Wheel Clamp Carrier Weight Con- nection Guide Pin for 9187.....	03
19621	7308	Buff Wheel Clamp Carrier Weight Con- nection Hook.....	02
9167	4442	Buff Wheel Clamp Carrier Weight Con- nection Pulley.....	60
19623	7306	Buff Wheel Clamp Carrier Weight Con- nection Pulley Bracket.....	30
164E	7275	Buff Wheel Clamp Carrier Weight Con- nection Pulley Bracket Screw.....	04
917D	7308	Buff Wheel Clamp Carrier Weight Con- nection Pulley Screw.....	12
19624	7305	Buff Wheel Clamp Carrier Weight Eyelet	05
19625	7305	“ “ “ “ “ “ Hook.....	05
9168	7306	Buff Wheel Clamp Spindle.....	1 25
9169	—	“ “ “ “ “ 9168 with 9170 and three 401b.....	2 30
19611	7306	Buff Wheel Clamp Spindle Gear with 462c.....	75
2049	7261	Buff Wheel Clamp Spindle Gear Pin.....	01



NO.	PLATE	NAME	EACH
462c	7306	Buff Wheel Clamp Spindle Gear Set Screw	\$ 02
9170	7306	" " " " Plate with three 9199.....	1 00
401d	7275	Buff Wheel Clamp Spindle Plate Screw	02
9199	7306	" " " " " Spur	05
50201F	7306	" " Thumb Screw	30
19628	7306	" " " " Washer	15
9171	7311	Cloth Plate	2 00
389F	7308	" " Screw	04
11054	7251	Crank Connecting Rod with 9141 and two 575E.....	1 75
*9141	—	Crank Connecting Rod Cap	75
575E	7276	" " " " Screw	05
369c	7276	" " " " Hinge Screw	20
1509E	7275	" " " " " Nut	06
9172	7311	Feed Bar	6 00
300c	7261	" " Screw Centre	08
1513j	7263	" " " " Nut	05
8994	7255	" Cam with two 432c.....	1 00
432c	7275	" " Set Screw	04
8927	7255	" Connecting Link	75
369c	7276	" " " Hinge Screw for 8929.....	20
1078c	7276	Feed Connecting Link Hinge Screw for 8930.....	20
1509E	7275	Feed Connecting Link Hinge Screw Nut	06
9173	7312	" Dog	2 00
19632	7309	" " Carrier with 8077.....	2 00
568c	7308	" " " Hinge Screw	15
13175	7308	" " " Spring	01
19633	7308	" " " Hook for 9158	05
8077	7261	" " " " " " 19632	01
166d	7275	" " Screw	07
8929	7256	" Forked Connection	2 00
369c	7276	" " " Hinge Screw	20
1509E	7275	" " " " " Nut	06
9225	7256	" Lifting Rock Shaft with 134d, 2022 and 19967.....	1 75
64025	—	Feed Lifting Rock Shaft complete, Nos. 9176 and 9225.....	4 25
9176	7310	Feed Lifting Rock Shaft Crank with 692d, 1619E and 1925.....	2 50
692d	7308	Feed Lifting Rock Shaft Crank Clamping Screw	10
1925	7261	Feed Lifting Rock Shaft Crank Roller with 961c.....	25

NO.	PLATE	NAME	EACH
961c	7261	Feed Lifting Rock Shaft Crank Roller Screw.....	\$ 12
1619E	7275	Feed Lifting Rock Shaft Crank Roller Screw Nut.....	05
1015c	7276	Feed Lifting Rock Shaft Screw Centre (left).....	15
1503E	7275	Feed Lifting Rock Shaft Screw Centre (left) Nut.....	10
294c	7276	Feed Lifting Rock Shaft Screw Centre (right).....	18
1503E	7275	Feed Lifting Rock Shaft Screw Centre (right) Nut.....	10
19967	7263	Feed Lifting Rock Shaft Wearing Block	35
2022	7250	" " " " " " " Position Pin.....	01
134d	7275	Feed Lifting Rock Shaft Wearing Block Screw.....	05
8930	7255	Feed Regulator.....	75
17E	7276	" " Hinge Screw	20
50322D	7274	" " Thumb Screw	40
9177	7311	" Rock Shaft	2 00
64026	—	Feed Rock Shaft complete, Nos. 9177 and 9229.....	3 00
9229	7281	Feed Rock Shaft Crank with 50124d.....	1 00
50124d	7276	" " " Clamping Screw	12
1015c	7276	" " " Screw Centre (left).....	15
1503E	7275	" " " " " " Nut	10
294c	7276	" " " " " (right).....	18
1503E	7275	" " " " " " Nut	10
19634	7306	Guide Pin, for circular stitching.....	35
9179	7310	" Plate, for circular stitching.....	1 50
NOTE: When ordering No. 9179 state distance between rows of stitching.			
691F	7308	Guide Plate Screw	04
9145	7298	Lifting Presser Bar	1 25
9180	7309	" " " Bell Crank	7 50
9181	—	Lifting Presser Bar Bell Crank complete, Nos. 611c, 9180 and 11025.....	9 75
11025	7298	Lifting Presser Bar Bell Crank Adjusting Arm with 1513j and 1882.....	2 00
1882	7300	Lifting Presser Bar Bell Crank Adjusting Arm Roller with 604c.....	45
604c	7300	Lifting Presser Bar Bell Crank Adjusting Arm Roller Screw	15
1513j	7263	Lifting Presser Bar Bell Crank Adjusting Arm Roller Screw Nut.....	05

NO.	PLATE	NAME	EACH
611c	7276	Lifting Presser Bar Bell Crank Adjusting Arm Screw.....	\$ 12
752d	7300	Lifting Presser Bar Bell Crank Hinge Screw.....	40
1595E	7300	Lifting Presser Bar Bell Crank Hinge Screw Nut.....	08
8715	7300	Lifting Presser Bar Bell Crank Hinge Screw Nut Washer.....	25
9214	7260	Lifting Presser Bar Bushing.....	75
448c	7263	" " " " Set Screw....	03
19682	7305	" " " Connecting Stud with 445c and 523c.....	1 25
523c	7276	Lifting Presser Bar Connecting Stud Set Screw (large).....	15
445c	7275	Lifting Presser Bar Connecting Stud Set Screw (small).....	03
19674	7309	Lifting Presser Bar Guide Bracket with 145d and two 445c.....	5 00
145d	7275	Lifting Presser Bar Guide Bracket Adjusting Screw.....	04
9110	7267	Lifting Presser Bar Guide Bracket Guide	1 00
135d	7275	" " " " " " " Screw.....	05
445c	7275	Lifting Presser Bar Guide Bracket Set Screw.....	03
448c	7263	Lifting Presser Bar Guide Bracket Support Screw.....	03
1520E	7263	Lifting Presser Bar Guide Bracket Support Screw Nut.....	03
16996	7267	Lifting Presser Bar Lifter with 8761 and 8763.....	1 25
8760	7250	Lifting Presser Bar Lifter Friction Washer	03
16d	7274	" " " " Hinge Screw....	20
8761	7250	" " " " Stop Pin.....	05
9232	7310	" " " Lifting Link.....	50
8763	7250	" " " " " " " H i n g e Stud.....	25
8973	7250	Lifting Presser Bar Lifting Link Hinge Stud Pin.....	05
8765	7250	Lifting Presser Bar Lifting Link Hinge Stud Washer.....	04
11031	7252	Lifting Presser Bar Spring (flat).....	1 50
58252	7267	" " " " Bracket f o r 11031.....	25
1177d	7275	Lifting Presser Bar Spring Bracket Screw	04
4389	7250	" " " " Guide Pin for 11031.....	02

NO.	PLATE	NAME	EACH
50323d	7274	Lifting Presser Bar Spring Regulating Screw.....	\$ 10
1606E	7275	Lifting Presser Bar Spring Regulating Screw Lock Nut.....	05
8745	7259	Needle Bar.....	1 50
9214	7260	" " Bushing.....	75
448c	7263	" " " Set Screw.....	03
8746	7259	" " Connecting Link.....	1 25
370c	7276	" " " " Hinge Screw	18
1509E	7275	" " " " " " " Nut.....	06
16987	7261	Needle Bar Connecting Stud with two 129d.....	2 00
129d	7275	Needle Bar Connecting Stud Clamping Screw.....	04
16988	7261	Needle Clamp with 149F and 8749.....	1 25
8749	7260	" " Gib.....	25
149F	7260	" " Screw.....	06
16989	7251	Oil Cup.....	80
11917	7251	" " Cover.....	25
9084	7260	" " " Hinge Pin.....	02
2205	7260	" " " Latch Spring.....	04
207F	7260	" " " " " " Screw.....	02
11919	7260	" " Thread Eyelet.....	05
8953	7260	" or Wax Stripper (felt).....	03
11918	7260	" " " " Washer (steel) for 11917.....	03
8482	7260	Oil or Wax Stripper Washer (steel) for 16989.....	01
207F	7260	Oil or Wax Stripper Washer Screw.....	02
16990	7251	Oil Cup complete, Nos. 2205, 8482, 9084, 11917 to 11919, 16989, two 8953 and three 207F.....	1 25
134d	7275	Oil Cup Screw.....	05
9150	7259	Oscillating Rock Shaft.....	7 50
9151	---	Oscillating Rock Shaft complete, Nos. 654c, 9115, 9150, 11165 and two 1503E.....	9 25
9115	7259	Oscillating Rock Shaft Hinge Pin.....	1 25
1503E	7275	" " " " " Nut....	10
654c	7276	" " " " " Screw	25
1503E	7275	Bearing.....	10
11165	7263	Oscillating Rock Shaft Hinge Pin Screw Bearing Nut.....	01
9116	7252	" Shaft.....	2 00
9152	7263	" " Collar with two 418c....	30
448c	7263	" " " Set Screw.....	03

NO.	PLATE	NAME	EACH
9153	—	Oscillating Shaft Crank .....	\$2 00
9154	7255	Oscillating Shaft Crank complete, Nos. 445c, 1513j, 9120 and 9153.....	2 70
9216	7263	Oscillating Shaft Crank Pin .....	05
445c	7275	" " " Set Screw .....	03
9119	7263	" " " Slide Block .....	35
9120	7263	Oscillating Shaft Crank Slide Block com- plete, Nos. 190b, 1016c, 5968 and 9119.	60
190b	7263	Oscillating Shaft Crank Slide Block Cap Screw.....	03
5968	7263	Oscillating Shaft Crank Slide Block Cap Screw Washer.....	02
1016c	7263	Oscillating Shaft Crank Slide Block Screw Stud.....	25
1513j	7263	Oscillating Shaft Crank Slide Block Screw Stud Nut .....	05
11910	7268	Shuttle Bobbin .....	25
19977	7268	" Cylinder .....	1 50
8961	7268	" " Hinge Pin .....	02
11853	7268	" " Latch .....	15
12002	7268	" " " Pin .....	01
19869	7268	" " " Spring .....	01
19978	7268	" Frame .....	1 75
773H	7268	" Tension Regulating Screw .....	05
19979	7268	" " Spring .....	40
19980	7268	Shuttle (cylinder) 3 in. diam., complete, Nos. 773H, 8961, 11853, 11910, 12002, 19869 and 19977 to 19979.....	4 00
8965	7259	Shuttle Driver with 445c.....	3 00
9216	7263	" " Pin .....	05
445c	7275	" " Set Screw .....	03
9183	7309	" Race Back .....	1 00
11833	7250	" " " Position Pin .....	01
11834	7255	" " " Spring .....	25
32D	7275	" " " " Screw .....	10
9184	7311	" " Body .....	3 00
9185	—	Shuttle Race complete, Nos. 32D, 9183, 9184, 11834 and two 11833.....	4 35
134D	7275	Shuttle Race Screw .....	05
9099	7252	" " Frame with 11838.....	2 00
123E	7276	" " " Clamping Screw .....	06
11838	7250	" " " Position Pin .....	03
8786	7270	Tension Disc .....	15
1535E	7270	" Regulating Thumb Nut .....	10
8787	7270	" " " Washer .....	01
406E	7270	" Screw Stud .....	25
8788	7270	" Spring .....	25

NO.	PLATE	NAME	EACH
8785	—	Tension complete, Nos. 406E, 1535E, 8787, 8788 and two 8786 .....	\$ 90
11424	7308	Thread Eyelet (front of arm).....	03
11950	7301	" " (side of arm) .....	05
9123	7302	" Take-up Cam with two 432c.....	8 50
8714	7250	" " " Pin .....	15
432c	7275	" " " Set Screw .....	04
64002	7281	" " Lever with 1513j, 1865 and 9219.....	3 00
10b	7274	Thread Take-up Lever Hinge Screw .....	25
1865	7261	" " " Roller and Screw Stud.....	45
1513j	7263	Thread Take-up Lever Roller and Screw Stud Nut .....	05
9219	7250	Thread Take-up Lever Thread Eyelet Bushing.....	25
9124	7263	Thread Take-up Spring .....	15
8799	7260	" " " Regulator .....	15
164D	7275	" " " " Screw .....	04
41544	7250	" " " " " " Washer .....	05
9186	7301	Thread Take-up Staple .....	20
690D	7275	" " " Screw .....	05
41544	7250	" " " " Washer .....	05
9187	—	Throat Plate Body with 19620.....	1 00
9188	7312	" " Needle Hole Strip .....	50
401D	7275	" " " " " Screw .....	02
9189	7312	Throat Plate complete for 9173, Nos. 9187, 9188 and two 401D.....	1 50
381D	7275	Throat Plate Screw .....	06
9190	7310	Vibrating Presser Bar with 9194 and two 9291.....	3 50
9191	7310	Vibrating Presser Bar Guide Bracket with 453c.....	1 25
9192	—	Vibrating Presser Bar Guide Bracket com- plete, Nos. 9191, 9193 and two 164D...	1 60
9193	7310	Vibrating Presser Bar Guide Bracket Cap with 19614.....	25
164D	7275	Vibrating Presser Bar Guide Bracket Cap Screw.....	04
2117	7250	Vibrating Presser Bar Guide Bracket Pin. " " " " " Set	01
453c	7263	Screw.....	02
23F	7308	Vibrating Presser Bar Hinge Screw .....	15
8734	7270	" " " Spring .....	08
9194	7310	" " " " Bracket with 19614.....	40

NO.	PLATE	NAME	EACH
9291	7250	Vibrating Presser Bar Spring Bracket Rivet.....	\$ 01
19614	7250	Vibrating Presser Bar Spring Hook.....	05
9195	7305	" " and Stretching Foot	3 50
657c	7308	" " " " " "	
		Hinge Screw.....	10
1520E	7263	Vibrating Presser and Stretching Foot Hinge Screw Nut.....	03
25837	7308	Vibrating Presser and Stretching Foot Spring.....	02
19647	7308	Vibrating Presser and Stretching Foot Spring Stud.....	05
212c	7308	Vibrating Presser and Stretching Foot Stop Screw.....	04

For Driving Attachment see Page 28.

## MACHINE NO. 6-15

HAS BELT SHIFTER FOR FLAT BELT. OTHERWISE SAME AS  
MACHINE NO. 6-14.

NO.	PLATE	NAME	EACH
9144	7251	Arm Shaft, in place of 9196.....	\$8 50

## BELT SHIFTER PARTS

NO.	PLATE	NAME	EACH
61504	7253	Balance Wheel and Pulley (tight) with two 341c, in place of 8982.....	\$6 00
341c	7276	Balance Wheel and Pulley (tight) Set Screw.....	08
6439	---	Chain, length 36 in. to 45 in.....	20
NOTE: When ordering No. 6439 give length required.			
4879	7273	Chain Connecting Link for 4885.....	03
11446	7250	" Eyelet.....	01
9137	7273	" Pulley.....	35
10b	7274	" " Screw.....	25
8805	7253	Fork.....	75
432c	7275	" Set Screw.....	01
8803	7253	Frame with 8804 and two 432c.....	1 75
8804	7253	" Handle.....	30
11451	7253	Guide Rod.....	75
11453	7263	" " Collar with two 448c.....	15
448c	7263	" " " Set Screw.....	03
3012	7250	" " Pin.....	01
11454	7273	" " Spring.....	15
8705	7253	Pulley (loose).....	1 50
9104	7273	" " Collar.....	25
9135	7273	" " Flanged Bushing with two 434c.....	1 00
434c	7275	Pulley (loose) Flanged Bushing Set Screw	01
9138	7253	Slide Rod.....	1 50
8873	7250	" " Pin.....	05
4881	7252	Treadle.....	30
4882	7273	" Shaft.....	05
4883	7273	" Spring.....	10
4884	7252	" Stand.....	25

## BELT SHIFTER PARTS

NO.	PLATE	NAME	EACH
4885	7252	Treadle complete, Nos. 4879, 4881 to 4884 and two wood screws 1 in. No. 16.....	\$ 75
9139	—	Belt Shifter complete, Nos. 10b, 3012, 4885, 6439, 8705, 8803, 8805, 8873, 9104, 9135, 9137, 9138, 11446, 11451, 11453, 11454 and 61504.....	13 50

## DRIVING ATTACHMENT PARTS

NO.	PLATE	NAME	EACH
8982	7253	Balance Wheel with two 344c.....	\$4 00
8983	7250	" " Pin.....	10
	344c	" " Set Screw.....	08
8984	7273	Brake Block (wood).....	05
	9D	" " Screw.....	20
8985	7253	Friction Pulley with 8986.....	2 75
8986	7273	" " Centre Bearing.....	25
8987	7253	" Washer (paper).....	10
	401E	" " Screw.....	02
8988	7253	Lever.....	1 00
9197	7253	" Bracket.....	2 00
	497E	" " Bolt with 1522E.....	05
	1522E	" " Nut.....	02
	134D	" Screw.....	05
8991	7273	" " Washer.....	06
8992	7273	" Spring.....	20
9222	7267	" " Hook.....	15
	1520E	" " Nut.....	03
	6055	" " " " Washer.....	01
9091	7253	Shaft Driving Pulley, 10 in. diam., 1½ in. face, 1⅜ in. bore (sectional) with two 597c.....	80
	597c	Shaft Driving Pulley Clamping Screw.....	08
27636	7253	Treadle.....	30
	9082	" Bearing Cotter Pin.....	01
27637	7251	" Pitman Rod (lower).....	05
27638	7260	" " " " Spring.....	03
27639	7251	" " " (upper).....	05
	9079	" " " Clamp with 354c.....	12
	354c	" " " Screw.....	06
27640	7251	Treadle Pitman complete, Nos. 2762, 9079 and 27637 to 27639.....	35
2878	7253	Treadle Stand.....	15
2762	7260	" Stop Collar with 362F.....	10
	362F	" " " Set Screw.....	05

## DRIVING ATTACHMENT PARTS

NO.	PLATE	NAME	EACH
27642	—	Treadle complete, Nos. 2878, 9082, 27636 and four wood screws 1 in. No. 16.....	\$ 45
27643	—	Treadle and Pitman complete, Nos. 27640 and 27642.....	80
9198	—	Driving Attachment complete, Nos. 9b, 134b, 1520E, 6055, 8982 to 8985, 8987, 8988, 8991, 8992, 9091, 9197, 9222, 27643, two 497E and four 401E.....	12 50

## ACCESSORIES

NO.	PLATE	NAME	EACH
11361	7298	Bed Bracket (left) with wood screw 1 in. No. 16.....	\$ 10
11360	7298	Bed Bracket (right) with wood screw 1 in. No. 16.....	10
	507E	Bed Bracket Bolt with 1515E.....	02
	1515E	" " " Nut.....	02
36565	6047	Oiler (copper plated) with 36566.....	15
36566	6047	" Spout, 9 in. long.....	08
11831	6047	Screw Driver (large).....	20
26026	6047	" " (small).....	10
	8908	Wrench for 1520 and 1654.....	08
	8909	" " 523, 692, 1513 and 50323.....	10
	8910	" " 344, 611, 1509 and 1619.....	25
	8911	" " 1503 and 50124.....	15
	9155	" " 1595.....	50
43184	7284	" " 1606.....	50

## BOBBIN WINDERS

## BOBBIN WINDER

(SWINGING AUTOMATIC, LEFT HAND)

NO.	PLATE	NAME	EACH
41894	6781	Base with 449c.....	\$ 50
	894D	" Screw.....	05
41895	7270	Bobbin Carrier Key.....	01
41896	6782	Frame.....	35
41441	6782	" Hinge Pin.....	10
	449c	" " " Set Screw.....	02
	4784	" Oil Pad.....	01
41897	6782	" Spring.....	05

## BOBBIN WINDERS

NO.	PLATE	NAME	EACH
43176	6782	Pulley (leather).....	\$ 75
43177	6782	" Flange with two 448c.....	35
448c	7263	" " Set Screw.....	03
131b	7275	" Screw.....	04
43178	6782	" Washer.....	50
41898	6781	Spindle with 41895.....	25
41557	6781	Stop Latch.....	15
41446	6781	" " Hinge Pin.....	10
2269	7250	" " Pin.....	01
41899	6782	Tripping Arm with 176b.....	20
176b	7275	" " Clamping Screw.....	03
41900	6781	Bobbin Winder, Nos. 2269, 41441, 41446, 41557, 41894, 41896 to 41899, 43176 to 43178, two 4784 and three 131b.....	3 45
41901	7252	Bracket for 41903.....	75
41902	7252	" " 41901.....	75
523b	7276	" Screw.....	15

## THREAD UNWINDER PARTS

27555	7285	Spool Pin.....	08
27583	7285	" Rest.....	20
27556	—	" " 27583 with 138b and two 27555.....	40
138b	7275	Spool Rest Set Screw.....	05
27557	7285	" Stand with 138b.....	25
41514	7285	" Weight, 4 in. diam., with 41515.....	15
41515	7250	" " Centre Pin.....	05
2102	7270	Tension Disc.....	05
1560c	7270	" Regulating Thumb Nut.....	04
637c	7270	" Screw Stud.....	08
2103	7270	" Spring.....	03
5769	7270	" Thread Eyelet.....	03
41452	7285	Thread Guard.....	40
27560	7285	" " Rod, 26 in. long.....	30
138b	7275	" " Set Screw.....	05
330b	7275	" " Set Screw.....	02
41453	—	Thread Guard complete, Nos. 330b, 637c, 1560c, 2103, 5769, 41452 and two 2102.....	70
41823	7285	Thread Unwinder complete, for two large spools, Nos. 27556, 27557, 27560, 41453, two 41514 and three wood screws 1¼ in. No. 12.....	1 95
41904	—	Bobbin Winder (swinging automatic, left hand) complete for 6-11 and 6-14 Machines, Nos. 523b, 41823, 41900, 41902 and three 894b.....	6 45

## BOBBIN WINDERS

NO.	PLATE	NAME	EACH
41903	—	Bobbin Winder (swinging automatic, left hand) complete for 6-12 and 6-15 Machines, Nos. 523b, 41823, 41900, 41901 and three 894b.....	\$6 45

## BOBBIN WINDER (HAND)

FOR MACHINE BED  
OBSOLETE

NO.	PLATE	NAME	EACH
11756	—	Belt with 25028.....	\$ 05
25028	7270	" Hook.....	01
11758	6054	Frame.....	50
11759	6054	Pulley.....	25
11760	6054	" Driving Wheel.....	50
8380	6054	" " " Handle (wood).....	03
11762	6054	" " " " Stud.....	10
8382	7270	" " " " Washer.....	01
11761	—	Pulley Driving Wheel Handle complete, Nos. 8380, 8382 and 11762.....	10
11763	6054	Pulley Driving Wheel Stud.....	10
2269	7250	" " " " Pin.....	01
11764	7270	" " " " Washer.....	01
11765	6054	Spindle.....	40
11754	7252	Bobbin Winder complete, Nos. 2269, 11756, 11758 to 11761 and 11763 to 11765.....	2 00
135b	7275	Bobbin Winder Screw.....	05

## OBSOLETE PARTS

NO.	PLATE	NAME	EACH
*9101	—	Arm.....	\$30 00
496E	7274	" Screw.....	15
9102	7302	" Shaft for 6-12 Machine.....	8 50
9103	7299	" " Bushing.....	1 00
9136	7253	Balance Wheel and Pulley (tight) with two 344c, for 6-12 and 6-15 Machines..	5 00
*9106	—	Bed for 6-11 and 6-12 Machines.....	30 00
19627	7306	Buff Wheel Clamp Spindle Plate Spur for 9170.....	05
14785	7298	Driving Attachment Lever Spring Hook for 9198.....	10

## OBSOLETE PARTS

NO.	PLATE	NAME	EACH
129E	7275	Crank Connecting Rod Cap Screw for 11054.....	\$ 04
9093	7251	Feed Lifting Rock Shaft for 9097.....	2 00
9174	7311	" " " " " 9175.....	2 00
9097	—	Feed Lifting Rock Shaft complete for 6-11 and 6-12 Machines, Nos. 9093 and 9096	3 10
9175	—	Feed Lifting Rock Shaft complete for 6-14 and 6-15 Machines, Nos. 9174 and 9176	4 50
9096	7255	Feed Lifting Rock Shaft Crank with 1619E, 1926 and two 445c, for 9097.....	1 10
8873	7250	Feed Lifting Rock Shaft Crank Pin for 6-11 and 6-12 Machines.....	05
445c	7275	Feed Lifting Rock Shaft Crank Set Screw for 9096.....	03
254D	7274	Feed Regulator Thumb Screw.....	40
9053	—	Feed Rock Shaft complete for 6-11 and 6-12 Machines, Nos. 9054 and 9055.....	4 00
9178	—	Feed Rock Shaft complete for 6-14 and 6-15 Machines, Nos. 9002 and 9177.....	2 75
9055	7267	Feed Rock Shaft Crank with two 445c, for 9053.....	75
9002	7281	Feed Rock Shaft Crank with two 445c, for 9178.....	75
8873	7250	Feed Rock Shaft Crank Pin.....	05
445c	7275	" " " " " Set Screw.....	03
9107	7298	Lifting Presser Bar Bell Crank with 1882, for 6-11 and 6-12 Machines.....	3 50
1882	7300	Lifting Presser Bar Bell Crank Roller with 604c, for 9107.....	45
604c	7300	Lifting Presser Bar Bell Crank Roller Screw for 1882.....	15
11048	7304	Lifting Presser Bar Guide Bracket with 145D, 434c and 445c, for 9109.....	2 50
9109	—	Lifting Presser Bar Guide Bracket 11048 with 9140, for 6-11 and 6-12 Machines.....	2 75
16960	7304	Lifting Presser Bar Lifter with 8761 and 8763.....	1 25
9111	7304	Lifting Presser Bar Lifting Link for 6-11 and 6-12 Machines.....	50
9149	7304	Lifting Presser Bar Lifting Link for 6-11 and 6-12 Machines.....	50
9182	7309	Lifting Presser Bar Lifting Link for 6-14 and 6-15 Machines.....	75
9140	7300	Lifting Presser Bar Lifting Link Hinge Stud (lower) for 9109.....	40
257E	7275	Lifting Presser Bar Screw Bushing for 6-11 and 6-12 Machines.....	20

## OBSOLETE PARTS

NO.	PLATE	NAME	EACH
257E	7275	Lifting Presser Bar Screw Bushing (lower) for 6-14 and 6-15 Machines.....	\$ 20
572E	7261	Lifting Presser Bar Screw Bushing (upper) for 6-14 and 6-15 Machines.....	50
8792	7267	Lifting Presser Bar Spring (spiral) for 6-11 and 6-12 Machines.....	15
11032	7304	Lifting Presser Bar Spring Bracket for 11031.....	25
381D	7275	Lifting Presser Bar Spring Bracket Screw	06
609D	7274	" " " " Regulating Thumb Screw.....	45
9057	7260	Needle Bar Connecting Stud with two 437c, for 6-11 and 6-12 Machines.....	2 00
437c	7275	Needle Bar Connecting Stud Set Screw for 9057.....	04
257E	7275	Needle Bar Screw Bushing.....	20
11497	7302	Oil Cup for 11921.....	80
11921	7302	Oil Cup complete, Nos. 2205, 8482, 9084, 11497, 11917 to 11919, two 8953 and three 207E.....	1 25
9113	7304	Oscillating Rock Shaft for 9114.....	7 50
9114	—	Oscillating Rock Shaft complete for 6-11 and 6-12 Machines, Nos. 654c, 9113, 9115, 11165 and two 1503E.....	9 00
9117	—	Oscillating Shaft Crank with 445c, for 9118	1 25
9118	7300	Oscillating Shaft Crank complete for 6-11 and 6-12 Machines, Nos. 1513a, 9117 and 9120.....	1 85
913E	7300	Pressure Regulating Thumb Screw for 6-11 and 6-12 Machines.....	40
11852	833	Shuttle Cylinder for 11851 and 19871.....	1 50
11854	833	" " Latch Spring for 11851.....	03
590E	7275	" " " " Screw for 11851.....	02
19870	3555	Shuttle Frame with 19869, for 19871.....	1 75
11855	833	" " for 11851, use 19870.....	1 75
8964	833	" Tension Spring for 11851 and 19871.....	40
11851	833	Shuttle (cylinder) 3 in. diam., complete, Nos. 590E, 773E, 8961, 8964, 11852 to 11855, 11910 and 12002, use 19871.....	4 00
19871	3555	Shuttle (cylinder) 3 in. diam., complete, Nos. 773E, 8961, 8964, 11852, 11853, 11910, 12002 and 19870, use 19980.....	4 00
8797	7309	Thread Take-up Lever with 1513J and 1865, for 6-14 and 6-15 Machines.....	2 00

## OBSOLETE PARTS

NO.	PLATE	NAME	EACH
8968	7267	Thread Take-up Lever with 1513i and 1883, for 6-11 and 6-12 Machines.....	\$2 00
8801	7260	Thread Take-up Staple for 6-11 and 6-12 Machines.....	20

**NUMERICAL LIST OF PARTS****FOR****MACHINES Nos.****6-11, 6-12, 6-14 and 6-15**



## NUMERICAL LIST OF PARTS

NO.	PLATE	NAME	EACH
9D	7276	Driving Attachment Brake Block Screw for 9198.....	\$ 20
10D	7274	Belt Shifter Chain Pulley Screw for 9139.....	25
10D	7274	Thread Take-up Lever Hinge Screw.....	25
16D	7274	Lifting Presser Bar Lifter Hinge Screw....	20
17E	7276	Feed Regulator Hinge Screw.....	20
23F	7308	Vibrating Presser Bar Hinge Screw for 6-14 and 6-15 Machines.....	15
32D	7275	Shuttle Race Back Spring Screw for 9100 and 9185.....	10
65D	7275	Arm Side Cover Hinge Screw.....	12
123E	7276	Bed Extension Screw for 6-14 and 6-15 Machines.....	06
123E	7276	Shuttle Race Frame Clamping Screw....	06
129E	7275	Crank Connecting Rod Cap Screw for 11054, obsolete.....	04
129D	7275	Needle Bar Connecting Stud Clamping Screw for 16987.....	04
131D	7275	Bobbin Winder Pulley Screw for 41900... ..	04
134D	7275	Driving Attachment Lever Screw for 9198	05
134D	7275	Feed Lifting Rock Shaft Wearing Block Screw for 9225 and 64014.....	05
134D	7275	Oil Cup Screw.....	05
134D	7275	Shuttle Race Screw.....	05
135D	7275	Bobbin Winder Screw for 11754, obsolete.	05
135D	7275	Lifting Presser Bar Guide Bracket Guide Screw.....	05
138B	7275	Bobbin Winder Thread Unwinder Spool Rest Set Screw for 27556.....	05
138B	7275	Bobbin Winder Thread Unwinder Thread Guard Set Screw for 27557.....	05
145D	7275	Lifting Presser Bar Guide Bracket Adjusting Screw for 11018, 11071 and 19674..	01
149F	7260	Needle Clamp Screw for 9060 and 16988..	06
164E	7275	Buff Wheel Clamp Carrier Stop Screw for 6-14 and 6-15 Machines.....	04
164E	7275	Buff Wheel Clamp Carrier Weight Connection Pulley Bracket Screw for 6-14 and 6-15 Machines.....	04
164D	7275	Thread Take-up Spring Regulator Screw.	04
164D	7275	Vibrating Presser Bar Guide Bracket Cap Screw for 9129 and 9192.....	04

NO.	PLATE	NAME	EACH
166D	7275	Buff Wheel Clamp Carrier Sliding Rack Cap Screw for 6-14 and 6-15 Machines.	\$ 07
166D	7275	Feed Dog Screw	07
176D	7275	Bobbin Winder Tripping Arm Clamping Screw for 41899.	03
190D	7263	Buff Wheel Clamp Carrier Sliding Rack Cap Roller Cap Screw for 1885.	03
190D	7263	Oscillating Shaft Crank Slide Block Cap Screw for 9120.	03
193F	7301	Vibrating Presser Bar Hinge Stud Set Screw for 11071.	03
207F	7260	Oil Cup Cover Latch Spring Screw for 11921 and 16990.	02
207F	7260	Oil or Wax Stripper Washer Screw for 11921 and 16990.	02
212C	7308	Vibrating Presser and Stretching Foot Stop Screw for 6-14 and 6-15 Machines.	04
225F	7275	Throat Plate Needle Plate Screw for 61023	03
233D	7301	Vibrating Presser Bar Cushion Screw for 6-11 and 6-12 Machines.	02
254D	7274	Feed Regulator Thumb Screw, obsolete.	40
257E	7275	Lifting Presser Bar Screw Bushing for 6-11 and 6-12 Machines, obsolete.	20
257E	7275	Lifting Presser Bar Screw Bushing (lower) for 6-14 and 6-15 Machines, obsolete.	20
257E	7275	Needle Bar Screw Bushing, obsolete.	20
294C	7276	Feed Lifting Rock Shaft Screw Centre (right).	18
294C	7276	Feed Rock Shaft Screw Centre (right) for 6-14 and 6-15 Machines.	18
300C	7261	Feed Bar Screw Centre for 6-14 and 6-15 Machines.	08
304C	7276	Feed Bar Screw Centre for 6-11 and 6-12 Machines.	06
330D	7275	Bobbin Winder Thread Unwinder Thread Guard Set Screw for 41453.	02
344C	7276	Balance Wheel and Pulley (tight) Set Screw for 9136 and 61504.	08
344C	7276	Balance Wheel Set Screw for 8982.	08
354C	7275	Driving Attachment Treadle Pitman Rod Clamp Screw for 9079.	06
362F	7275	Driving Attachment Treadle Stop Collar Set Screw for 2762.	05
369C	7276	Crank Connecting Rod Hinge Screw.	20
369C	7276	Feed Connecting Link Hinge Screw for 8929 for 6-14 and 6-15 Machines and for 9058 for 6-11 and 6-12 Machines.	20

NO.	PLATE	NAME	EACH
369C	7276	Feed Forked Connection Hinge Screw...	\$ 20
370C	7276	Needle Bar Connecting Link Hinge Screw	18
381D	7275	Buff Wheel Clamp Carrier Locking Rack Screw for 6-14 and 6-15 Machines.	06
381D	7275	Lifting Presser Bar Spring Bracket Screw, obsolete.	06
381D	7275	Throat Plate Screw.	06
389F	7308	Cloth Plate Screw for 6-14 and 6-15 Machines.	04
401D	7275	Buff Wheel Clamp Spindle Plate Screw for 9169.	02
401E	7275	Driving Attachment Friction Washer Screw for 9198.	02
401D	7275	Throat Plate Needle Hole Strip Screw for 9189.	02
406E	7270	Tension Screw Stud for 8785.	25
432C	7275	Belt Shifter Fork Set Screw for 8803.	04
432C	7275	Feed Cam Set Screw for 8994.	04
432C	7275	Thread Take-up Cam Set Screw for 9123.	04
434C	7275	Arm Shaft Bushing Set Screw.	04
434C	7275	Belt Shifter Pulley (loose) Flanged Bush- ing Set Screw for 9135.	01
434C	7275	Lifting Presser Bar Guide Bracket Set Screw (long) for 11048 and 11071.	04
437C	7275	Needle Bar Connecting Stud Set Screw for 9057, obsolete.	04
445C	7275	Feed Lifting Rock Shaft Crank Set Screw for 9096, obsolete.	03
445C	7275	Feed Rock Shaft Crank Set Screw for 9002 and 9055, obsolete.	03
445C	7275	Lifting Presser Bar Connecting Stud Set Screw (small) for 19682.	03
445C	7275	Lifting Presser Bar Guide Bracket Set Screw for 19674.	03
445C	7275	Lifting Presser Bar Guide Bracket Set Screw (short) for 11048 and 11071.	03
445C	7275	Oscillating Shaft Crank Set Screw for 9117 and 9154.	03
445C	7275	Shuttle Driver Set Screw for 8965.	03
448C	7263	Belt Shifter Guide Rod Collar Set Screw for 11453.	03
448C	7263	Bobbin Winder Pulley Flange Set Screw for 43177.	03
448C	7263	Lifting Presser Bar Bushing Set Screw.	03
448C	7263	" " " Guide Bracket Sup- port Screw for 6-14 and 6-15 Machines.	03
448C	7263	Needle Bar Bushing Set Screw.	03

NO.	PLATE	NAME	EACH
448c	7263	Oscillating Shaft Collar Set Screw for 9152	\$ 03
449c	7275	Bobbin Winder Frame Hinge Pin Set Screw for 41894	02
451c	7300	Vibrating Presser Bar Guide Bracket Set Screw for 9128	03
453c	7263	Buff Wheel Clamp Carrier Locking Rack Bracket Hinge Pin Set Screw for 19602	02
453c	7263	Buff Wheel Clamp Carrier Locking Rack Bracket Latch Body Set Screw for 19605	02
453c	7263	Buff Wheel Clamp Carrier Sliding Flange Set Screw for 19609	02
453c	7263	Lifting Presser Bar Collar Set Screw for 9148	02
453c	7263	Vibrating Presser Bar Guide Bracket Set Screw for 9191	02
462c	7306	Buff Wheel Clamp Carrier Sliding Flange Gear Set Screw for 19611	02
462c	7306	Buff Wheel Clamp Spindle Gear Set Screw for 19611	02
496E	7274	Arm Screw, obsolete	15
497E	7274	Driving Attachment Lever Bracket Bolt with 1522E, for 9198	05
507E	7275	Bed Bracket Bolt with 1515E (Accessories)	02
523D	7276	Bobbin Winder Bracket Screw for 41903 and 41904	15
523c	7276	Lifting Presser Bar Connecting Stud Set Screw for 9108	15
523c	7276	Lifting Presser Bar Connecting Stud Set Screw (large) for 19682	15
568c	7308	Feed Dog Carrier Hinge Screw for 6-14 and 6-15 Machines	15
572E	7261	Lifting Presser Bar Screw Bushing (upper) for 6-14 and 6-15 Machines, obsolete	50
575E	7276	Crank Connecting Red Cap Screw for 11054	05
590E	7275	Shuttle Cylinder Latch Spring Screw for 11851, obsolete	02
597c	7276	Driving Attachment Shaft Driving Pulley Clamping Screw for 9091	08
604c	7300	Lifting Presser Bar Bell Crank Adjusting Arm Roller Screw for 1882	15
604c	7300	Lifting Presser Bar Bell Crank Roller Screw for 1882, obsolete	15
609D	7274	Lifting Presser Bar Spring Regulating Thumb Screw, obsolete	45
611D	7276	Feed Lifting Rock Shaft Crank Clamping Screw for 64016	12

NO.	PLATE	NAME	EACH
611c	7276	Lifting Presser Bar Bell Crank Adjusting Arm Screw for 9147 and 9181	\$ 12
637c	7270	Bobbin Winder Thread Unwinder Tension Screw Stud for 41453	08
654c	7276	Oscillating Rock Shaft Hinge Pin Screw Bearing for 9114 and 9151	25
657E	7308	Buff Wheel Clamp Carrier Sliding Rack Stop Screw for 6-14 and 6-15 Machines	10
657c	7308	Vibrating Presser and Stretching Foot Hinge Screw for 6-14 and 6-15 Machines	10
690D	7275	Thread Take-up Staple Screw	05
690D	7275	Vibrating Presser Foot Screw for 6-11 and 6-12 Machines	05
691F	7308	Buff Wheel Clamp Carrier Cap Screw for 6-14 and 6-15 Machines	04
691F	7308	Buff Wheel Clamp Carrier Stop Plate Screw for 6-14 and 6-15 Machines	04
691F	7308	Guide Plate Screw for 6-14 and 6-15 Machines	04
692D	7308	Feed Lifting Rock Shaft Crank Clamping Screw for 9176	10
752D	7300	Lifting Presser Bar Bell Crank Hinge Screw	40
773H	7268	Shuttle Tension Regulating Screw for 11851, 19871 and 19980	05
894D	7275	Bobbin Winder Base Screw for 41903 and 41904	05
913E	7300	Pressure Regulating Thumb Screw for 6-11 and 6-12 Machines, obsolete	40
917D	7308	Buff Wheel Clamp Carrier Weight Connection Pulley Screw for 6-14 and 6-15 Machines	12
961c	7261	Feed Lifting Rock Shaft Crank Roller Screw for 1925	12
962c	7276	Feed Lifting Rock Shaft Crank Roller Screw for 1926	15
1015c	7276	Feed Lifting Rock Shaft Screw Centre (left)	15
1015c	7276	Feed Rock Shaft Screw Centre for 6-11 and 6-12 Machines	15
1015c	7276	Feed Rock Shaft Screw Centre (left) for 6-14 and 6-15 Machines	15
1016c	7263	Oscillating Shaft Crank Slide Block Screw Stud for 9120	25
1054c	7308	Buff Wheel Clamp Carrier Sliding Rack Cap Roller Screw Stud for 1885	20

## NUMERICAL LIST OF PARTS

NO.	PLATE	NAME	EACH
1078c	7276	Feed Connecting Link Hinge Screw for 8930.....	\$ 20
1149F	7275	Needle Bar Connecting Stud Clamping Screw for 32875.....	04
1177D	7275	Lifting Presser Bar Spring Bracket Screw	04
1503E	7275	Feed Lifting Rock Shaft Screw Centre (left) Nut.....	10
1503E	7275	Feed Lifting Rock Shaft Screw Centre (right) Nut.....	10
1503E	7275	Feed Rock Shaft Screw Centre Nut for 6-11 and 6-12 Machines.....	10
1503E	7275	Feed Rock Shaft Screw Centre (left) Nut for 6-14 and 6-15 Machines.....	10
1503E	7275	Feed Rock Shaft Screw Centre (right) Nut for 6-14 and 6-15 Machines.....	10
1503E	7275	Oscillating Rock Shaft Hinge Pin Nut for 9114 and 9151.....	10
1503E	7275	Oscillating Rock Shaft Hinge Pin Screw Bearing Nut for 9114 and 9151.....	10
1509E	7275	Crank Connecting Rod Hinge Screw Nut	06
1509E	7275	Feed Connecting Link Hinge Screw Nut	06
1509E	7275	" Forked Connection Hinge Screw Nut	06
1509E	7275	Needle Bar Connecting Link Hinge Screw Nut.....	06
1513J	7263	Buff Wheel Clamp Carrier Sliding Rack Cap Roller Screw Stud Nut for 6-14 and 6-15 Machines.....	05
1513J	7263	Feed Bar Screw Centre Nut.....	05
1513J	7263	Lifting Presser Bar Bell Crank Adjusting Arm Roller Screw Nut for 11025.....	05
1513J	7263	Oscillating Shaft Crank Slide Block Screw Stud Nut for 9118 and 9154.....	05
1513J	7263	Thread Take-up Lever Roller and Screw Stud Nut for 8797, 8968, 9218 and 64002	05
1515E	7275	Bed Bracket Bolt Nut for 507.....	02
1520E	7263	Driving Attachment Lever Spring Hook Nut for 9198.....	03
1520E	7263	Lifting Presser Bar Guide Bracket Support Screw Nut for 6-14 and 6-15 Machines.	03
1520E	7263	Vibrating Presser and Stretching Foot Hinge Screw Nut for 6-14 and 6-15 Machines.....	03
1522E	7275	Driving Attachment Lever Bracket Bolt Nut for 497.....	02
1535E	7270	Tension Regulating Thumb Nut for 8785	10
1560c	7270	Bobbin Winder Thread Unwinder Tension Regulating Thumb Nut for 41453.....	04

## NUMERICAL LIST OF PARTS

NO.	PLATE	NAME	EACH
1595E	7300	Lifting Presser Bar Bell Crank Hinge Screw Nut.....	\$ 08
1606E	7275	Lifting Presser Bar Spring Regulating Screw Lock Nut.....	05
1619E	7275	Feed Lifting Rock Shaft Crank Roller Screw Nut for 9096, 9176 and 64016....	05
1654c	7301	Vibrating Presser Foot Screw Nut for 6-11 and 6-12 Machines.....	04
1804	7308	Buff Wheel Clamp Carrier Sliding Rack Roller and Stud for 9161.....	25
1865	7261	Thread Take-up Lever Roller and Screw Stud for 8797 and 64002.....	45
1882	7300	Lifting Presser Bar Bell Crank Adjusting Arm Roller with 604c, for 11025.....	45
1882	7300	Lifting Presser Bar Bell Crank Roller with 604c, for 9107, obsolete.....	45
1883	7275	Thread Take-up Lever Roller and Screw Stud for 8968 and 9218.....	35
1885	7308	Buff Wheel Clamp Carrier Sliding Rack Cap Roller with 190b, 1054c and 5968, for 6-14 and 6-15 Machines.....	40
1925	7261	Feed Lifting Rock Shaft Crank Roller with 961c, for 9176.....	25
1926	7260	Feed Lifting Rock Shaft Crank Roller with 962c, for 9096 and 64016.....	35
2022	7250	Buff Wheel Clamp Carrier Locking Rack Bracket Hinge Pin Dowel Pin for 6-14 and 6-15 Machines.....	01
2022	7250	Buff Wheel Clamp Carrier Locking Rack Bracket Latch Body Pin for 6-14 and 6-15 Machines.....	01
2022	7250	Feed Lifting Rock Shaft Wearing Block Position Pin for 9225 and 64014.....	01
2022	7250	Lifting Presser Bar Collar Pin for 6-11 and 6-12 Machines.....	01
2049	7261	Buff Wheel Clamp Carrier Sliding Flange Gear Pin for 6-14 and 6-15 Machines...	01
2049	7261	Buff Wheel Clamp Carrier Sliding Flange Pin for 6-14 and 6-15 Machines.....	01
2049	7261	Buff Wheel Clamp Spindle Gear Pin for 6-14 and 6-15 Machines.....	01
2102	7270	Bobbin Winder Thread Unwinder Tension Disc for 41453.....	05
2103	7270	Bobbin Winder Thread Unwinder Tension Spring for 41453.....	03
2117	7250	Vibrating Presser Bar Guide Bracket Pin	01

## NUMERICAL LIST OF PARTS

NO.	PLATE	NAME	EACH
2205	7260	Oil Cup Cover Latch Spring for 11921 and 16990.....	\$ 04
2269	7250	Bobbin Winder Pulley Driving Wheel Stud Pin for 11754, obsolete.....	01
2269	7250	Bobbin Winder Stop Latch Pin for 41900.....	01
2762	7260	Driving Attachment Treadle Stop Collar with 362F, for 27640.....	10
2878	7253	Driving Attachment Treadle Stand for 27642.....	15
3012	7250	Belt Shifter Guide Rod Pin for 9139.....	01
4389	7250	Lifting Presser Bar Spring Guide Pin for 11031.....	02
4784	7270	Bobbin Winder Frame Oil Pad for 41900.....	01
4879	7273	Belt Shifter Chain Connecting Link for 4885.....	03
Nos. 4881 to 4884 for 4885.			
4881	7252	Belt Shifter Treadle.....	30
4882	7273	" " " Shaft.....	05
4883	7273	" " " Spring.....	10
4884	7252	" " " Stand.....	25
4885	7252	Belt Shifter Treadle complete for 9139, Nos. 4879, 4881 to 4884 and two wood screws 1 in. No. 16.....	75
5769	7270	Bobbin Winder Thread Unwinder Tension Thread Eyelet for 41453.....	03
5968	7263	Buff Wheel Clamp Carrier Sliding Rack Cap Roller Cap Screw Washer for 1885.....	02
5968	7263	Oscillating Shaft Crank Slide Block Cap Screw Washer for 9120.....	02
6055	7263	Driving Attachment Lever Spring Hook Nut Washer for 9198.....	01
6439	—	Belt Shifter Chain, length 36 in. to 45 in., for 9139.....	20
7585	4442	Buff Wheel Clamp Carrier Sliding Flange Shaft for 6-14 and 6-15 Machines.....	05
8077	7261	Feed Dog Carrier Spring Hook for 19632.....	01
8380	6054	Bobbin Winder Pulley Driving Wheel Handle (wood) for 11761, obsolete.....	03
8382	7270	Bobbin Winder Pulley Driving Wheel Handle Stud Washer for 11761, obsolete.....	01
8482	7260	Oil or Wax Stripper Washer (steel) for 11497 for 11921 and for 16989 for 16990.....	01
8702	7250	Arm Dowel Pin.....	15
8705	7253	Belt Shifter Pulley (loose) for 9139.....	1 50
8708	7250	Arm Spool Pin.....	05
8714	7250	Thread Take-up Cam Pin.....	15

## NUMERICAL LIST OF PARTS

NO.	PLATE	NAME	EACH
8715	7300	Lifting Presser Bar Bell Crank Hinge Screw Nut Washer.....	\$ 25
8734	7270	Buff Wheel Clamp Carrier Sliding Rack Spring for 6-14 and 6-15 Machines.....	08
8734	7270	Vibrating Presser Bar Spring.....	08
8745	7259	Needle Bar.....	1 50
8746	7259	" " Connecting Link.....	1 25
8749	7260	" " Clamp Gib for 9060 and 16988.....	25
8760	7250	Lifting Presser Bar Lifter Friction Washer.....	03
8761	7250	" " " " Stop Pin for 16960 and 16996.....	05
8763	7250	Lifting Presser Bar Lifting Link Hinge Stud for 16960 and 16996.....	25
8763	7250	Lifting Presser Bar Lifting Link Hinge Stud (upper) for 16960 and 16996.....	25
8765	7250	Lifting Presser Bar Lifting Link Hinge Stud Washer for 6-14 and 6-15 Machines.....	04
8765	7250	Lifting Presser Bar Lifting Link Hinge Stud (lower) Washer for 6-11 and 6-12 Machines.....	04
8765	7250	Lifting Presser Bar Lifting Link Hinge Stud (upper) Washer for 6-11 and 6-12 Machines.....	04
8785	—	Tension complete, Nos. 406E, 1535E, 8787, 8788 and two 8786.....	90
Nos. 8786 to 8788 for 8785.			
8786	7270	Tension Disc.....	15
8787	7270	" Regulating Thumb Nut Washer.....	01
8788	7270	" Spring.....	25
8792	7267	Lifting Presser Bar Spring (spiral) for 6-11 and 6-12 Machines, obsolete.....	15
8797	7309	Thread Take-up Lever with 1513r and 1865, for 6-14 and 6-15 Machines, obsolete.....	2 00
8799	7260	Thread Take-up Spring Regulator.....	15
8801	7260	" " Staple for 6-11 and 6-12 Machines, obsolete.....	20
8803	7253	Belt Shifter Frame with 8804 and two 432c, for 9139.....	1 75
8804	7253	Belt Shifter Frame Handle for 8803.....	30
8805	7253	" " Fork for 9139.....	75
8873	7250	Bed Extension Dowel Pin for 6-14 and 6-15 Machines.....	05
8873	7250	Belt Shifter Slide Rod Pin for 9139.....	05
8873	7250	Feed Lifting Rock Shaft Crank Pin for 6-11 and 6-12 Machines, obsolete.....	05

NO.	PLATE	NAME	EACH
8873	7250	Feed Rock Shaft Crank Pin, obsolete....	\$ 05
8908	7284	Wrench for 1520 and 1654 (Accessories)...	08
8909	7284	“ “ 523, 692, 1513 and 50323 (Accessories) .....	10
8910	7284	Wrench for 344, 611, 1509 and 1619 (Accessories) .....	25
8911	7284	Wrench for 1503 and 50124 (Accessories)...	15
8927	7255	Feed Connecting Link .....	75
8929	7256	“ Forked Connection for 6-14 and 6-15 Machines .....	2 00
8930	7255	Feed Regulator .....	75
8953	7260	Oil or Wax Stripper (felt) for 11921 and 16990 .....	03
8961	7268	Shuttle Cylinder Hinge Pin for 11851, 19871 and 19980 .....	02
8964	833	Shuttle Tension Spring for 11851 and 19871, obsolete .....	40
8965	7259	Shuttle Driver with 445c .....	3 00
8968	7267	Thread Take-up Lever with 1513a and 1883, for 6-11 and 6-12 Machines, obsolete .....	2 00
8973	7250	Lifting Presser Bar Lifting Link Hinge Stud Pin for 6-14 and 6-15 Machines...	05
8973	7250	Lifting Presser Bar Lifting Link Hinge Stud (lower) Pin for 6-11 and 6-12 Machines .....	05
8973	7250	Lifting Presser Bar Lifting Link Hinge Stud (upper) Pin for 6-11 and 6-12 Machines .....	05
8982	7253	Balance Wheel with two 344c, for 6-11 and 6-14 Machines .....	4 00
8983	7250	Balance Wheel Pin for 6-11 and 6-14 Machines .....	10
8984	7273	Driving Attachment Brake Block (wood) for 9198 .....	05
8985	7253	Driving Attachment Friction Pulley with 8986, for 9198 .....	2 75
8986	7273	Driving Attachment Friction Pulley Centre Bearing for 8985 .....	25
8987	7253	Driving Attachment Friction Washer (paper) for 9198 .....	10
8988	7253	Driving Attachment Lever for 9198 .....	1 00
8991	7273	“ “ “ Screw Washer for 9198 .....	06
8992	7273	Driving Attachment Lever Spring for 9198	20
8994	7255	Feed Cam with two 432c .....	1 00

NO.	PLATE	NAME	EACH
9002	7281	Feed Rock Shaft Crank with two 445c, for 9178, obsolete .....	\$ 75
9021	7273	Lifting Presser Bar Spring (spiral) for 6-11 and 6-12 Machines .....	25
9047	7259	Feed Bar for 6-11 and 6-12 Machines .....	3 00
9053	—	Feed Rock Shaft complete for 6-11 and 6-12 Machines, Nos. 9054 and 9055, obsolete .....	4 00
9054	7251	Feed Rock Shaft for 9053 and 64017 .....	3 25
9055	7267	“ “ “ Crank with two 445c, for 9053, obsolete .....	75
9057	7260	Needle Bar Connecting Stud with two 437c, for 6-11 and 6-12 Machines, obsolete .....	2 00
9058	7252	Feed Forked Connection for 6-11 and 6-12 Machines .....	2 00
9060	7260	Needle Clamp with 149e and 8749, for 6-11 and 6-12 Machines .....	90
9079	7251	Driving Attachment Treadle Pitman Rod Clamp with 354c, for 27640 .....	12
9082	7250	Driving Attachment Treadle Bearing Cotter Pin for 27642 .....	01
9084	7260	Oil Cup Cover Hinge Pin for 11921 and 16990 .....	02
9089	7301	Vibrating Presser Foot for 6-11 and 6-12 Machines .....	2 50
9091	7253	Driving Attachment Shaft Driving Pulley 10 in. diam., 1½ in. face, 1¾ in. bore (sectional) with two 597c, for 9198 .....	80
9093	7251	Feed Lifting Rock Shaft for 9097, obsolete	2 00
9096	7255	“ “ “ “ Crank with 1619e, 1926 and two 445c, for 9097, obsolete ..	1 10
9097	—	Feed Lifting Rock Shaft complete for 6-11 and 6-12 Machines, Nos. 9093 and 9096, obsolete .....	3 10
9098	7252	Shuttle Race Body for 9100 .....	2 75
9099	7252	“ “ Frame with 11838 .....	2 00
9100	—	Shuttle Race (flexible back) complete for 6-11 and 6-12 Machines, Nos. 32b, 9098, 11832, 11834 and two 11833 .....	4 00
*9101	—	Arm, obsolete .....	30 00
9102	7302	“ Shaft for 6-12 Machine, obsolete ..	8 50
9103	7299	“ “ Bushing, obsolete .....	1 00
9104	7273	Belt Shifter Pulley (loose) Collar for 9139	25
9105	7252	Arm Side Cover .....	25
*9106	—	Bed for 6-11 and 6-12 Machines, obsolete.	30 00

## NUMERICAL LIST OF PARTS

NO.	PLATE	NAME	EACH
9107	7298	Lifting Presser Bar Bell Crank with 1882, for 6-11 and 6-12 Machines, obsolete...	\$3 50
9108	7301	Lifting Presser Bar Connecting Stud with 523c, for 6-11 and 6-12 Machines.....	2 00
9109	—	Lifting Presser Bar Guide Bracket 11048 with 9140, for 6-11 and 6-12 Machines, obsolete.....	2 75
9110	7267	Lifting Presser Bar Guide Bracket Guide	1 00
9111	7304	" " " Lifting Link for 6-11 and 6-12 Machines, obsolete.....	50
9112	—	No. cancelled, order 9060.	
9113	7304	Oscillating Rock Shaft for 9114, obsolete.	7 50
9114	—	Oscillating Rock Shaft complete for 6-11 and 6-12 Machines, Nos. 654c, 9113, 9115, 11165 and two 1503e, obsolete...	9 00
9115	7259	Oscillating Rock Shaft Hinge Pin for 9114 and 9151.....	1 25
9116	7252	Oscillating Shaft.....	2 00
9117	—	" " Crank with 445c, for 9118, obsolete.....	1 25
9118	7300	Oscillating Shaft Crank complete for 6-11 and 6-12 Machines, Nos. 1513r, 9117 and 9120, obsolete.....	1 85
9119	7263	Oscillating Shaft Crank Slide Block for 9120.....	35
9120	7263	Oscillating Shaft Crank Slide Block complete for 9118 and 9154, Nos. 190b, 1016c, 5968 and 9119.....	60
9123	7302	Thread Take-up Cam with two 432c....	8 50
9124	7263	" " Spring.....	15
9127	7299	Vibrating Presser Bar with 9131 and two 9291, for 6-11 and 6-12 Machines.....	2 00
9128	7299	Vibrating Presser Bar Guide Bracket with 451c, for 9129.....	1 25
9129	—	Vibrating Presser Bar Guide Bracket complete for 6-11 and 6-12 Machines, Nos. 9128, 9130 and two 164b.....	1 50
9130	7299	Vibrating Presser Bar Guide Bracket Cap with 19614, for 9129.....	20
9131	7299	Vibrating Presser Bar Spring Bracket with 19614, for 9127.....	50
9135	7273	Belt Shifter Pulley (loose) Flange Bushing with two 434c, for 9139.....	1 00
9136	7253	Balance Wheel and Pulley (tight) with two 344c, for 6-12 and 6-15 Machines, obsolete.....	5 00
9137	7273	Belt Shifter Chain Pulley for 9139.....	35

## NUMERICAL LIST OF PARTS

NO.	PLATE	NAME	EACH
9138	7253	Belt Shifter Slide Rod for 9139.....	\$1 50
9139	—	Belt Shifter complete for 6-12 and 6-15 Machines. Nos. 10b, 3012, 4885, 6439, 8705, 8803, 8805, 8873, 9104, 9135, 9137, 9138, 11446, 11451, 11453, 11454 and 61504.....	13 50
9140	7300	Lifting Presser Bar Lifting Link Hinge Stud (lower) for 9109, obsolete.....	40
*9141	—	Crank Connecting Rod Cap for 11054....	75
9144	7251	Arm Shaft for 6-12 and 6-15 Machines....	8 50
9145	7298	Lifting Presser Bar.....	1 25
9146	7299	" " " Bell Crank for 9147..	7 50
9147	—	Lifting Presser Bar Bell Crank complete for 6-11 and 6-12 Machines, Nos. 611c, 9146 and 11025.....	9 75
9148	7301	Lifting Presser Bar Collar with 453c, for 6-11 and 6-12 Machines.....	15
9149	7304	Lifting Presser Bar Lifting Link for 6-11 and 6-12 Machines, obsolete.....	50
9150	7259	Oscillating Rock Shaft for 9151.....	7 50
9151	—	Oscillating Rock Shaft complete, Nos. 654c, 9115, 9150, 11165 and two 1503e.	9 25
9152	7263	Oscillating Shaft Collar with two 448c....	30
9153	—	" " Crank for 9154.....	2 00
9154	7255	Oscillating Shaft Crank complete, Nos. 445c, 1513r, 9120 and 9153.....	2 70
9155	7284	Wrench for 1595 (Accessories).....	50
Nos. 9157 TO 9185 FOR 6-14 AND 6-15 MACHINES			
*9157	—	Bed.....	30 00
*9158	—	" Extension with 19633.....	6 00
9159	4442	Buff Wheel Clamp Carrier with 19614....	2 00
9160	4442	" " " " Cap.....	75
9161	4442	" " " " Locking Rack with 9164 and two 1804.....	3 50
9162	4442	Buff Wheel Clamp Carrier Sliding Rack with 9164.....	2 00
9163	4442	Buff Wheel Clamp Carrier Sliding Rack Cap.....	60
9164	7308	Buff Wheel Clamp Carrier Sliding Rack Spring Hook for 9161 and 9162.....	05
9165	7305	Buff Wheel Clamp Carrier Stop.....	30
9166	7310	" " " " Plate.....	35
9167	4442	" " " " Weight Connection Pulley.....	60
9168	7306	Buff Wheel Clamp Spindle for 9169.....	1 25

NO.	PLATE	NAME	EACH
9169	—	Buff Wheel Clamp Spindle 9168 with 9170 and three 401d.....	\$2 30
9170	7306	Buff Wheel Clamp Spindle Plate with three 9199, for 9169.....	1 00
9171	7311	Cloth Plate.....	2 00
9172	7311	Feed Bar.....	6 00
9173	7312	“ Dog.....	2 00
9174	7311	“ Lifting Rock Shaft for 9175, obsolete.....	2 00
9175	—	Feed Lifting Rock Shaft complete, Nos. 9174 and 9176, obsolete.....	4 50
9176	7310	Feed Lifting Rock Shaft Crank with 692d, 1619e and 1925, for 9175 and 64025....	2 50
9177	7311	Feed Rock Shaft for 9178 and 64026.....	2 00
9178	—	Feed Rock Shaft complete, Nos. 9002 and 9177, obsolete.....	2 75
9179	7310	Guide Plate, for circular stitching.....	1 50
9180	7309	Lifting Presser Bar Bell Crank for 9181.....	7 50
9181	—	Lifting Presser Bar Bell Crank complete, Nos. 611c, 9180 and 11025.....	9 75
9182	7309	Lifting Presser Bar Lifting Link, obsolete.....	75
9183	7309	Shuttle Race Back for 9185.....	1 00
9184	7311	“ “ Body for 9185.....	3 00
9185	—	Shuttle Race complete, Nos. 32d, 9183, 9184, 11834 and two 11833.....	4 35
9186	7301	Thread Take-up Staple.....	20
Nos 9187 TO 9195 FOR 6-14 AND 6-15 MACHINES			
9187	—	Throat Plate Body with 19620, for 9189.....	1 00
9188	7312	“ “ Needle Hole Strip for 9189.....	50
9189	7312	Throat Plate complete for 9173, Nos. 9187, 9188 and two 401d.....	1 50
9190	7310	Vibrating Presser Bar with 9194 and two 9291.....	3 50
9191	7310	Vibrating Presser Bar Guide Bracket with 453c, for 9192.....	1 25
9192	—	Vibrating Presser Bar Guide Bracket complete, Nos. 9191, 9193 and two 164d....	1 60
9193	7310	Vibrating Presser Bar Guide Bracket Cap with 19614, for 9192.....	25
9194	7310	Vibrating Presser Bar Spring Bracket with 19614, for 9190.....	40
9195	7305	Vibrating Presser and Stretching Foot....	3 50
9196	7251	Arm Shaft for 6-11 and 6-14 Machines....	8 50
9197	7253	Driving Attachment Lever Bracket for 9198.....	2 00

NO.	PLATE	NAME	EACH
9198	—	Driving Attachment complete for 6-11 and 6-14 Machines, Nos. 9d, 134d, 1520e, 6055, 8982 to 8985, 8987, 8988, 8991, 8992, 9091, 9197, 9222, 27643, two 497e and four 401e.....	\$12 50
9199	7306	Buff Wheel Clamp Spindle Plate Spur for 9170.....	05
9207	7250	Arm Oil Tube for oiling 9150.....	10
9208	7273	“ Shaft Bushing.....	1 00
9211	7255	Feed Rock Shaft Crank with 50124d, for 64017.....	1 00
9214	7260	Lifting Presser Bar Bushing.....	75
9214	7260	Needle Bar Bushing.....	75
9216	7263	Oscillating Shaft Crank Pin.....	05
9216	7263	Shuttle Driver Pin.....	05
9218	7259	Thread Take-up Lever with 1513j, 1883 and 9219, for 6-11 and 6-12 Machines..	2 25
9219	7250	Thread Take-up Lever Thread Eyelet Bushing for 9218 and 64002.....	25
9222	7267	Driving Attachment Lever Spring Hook for 9198.....	15
*9223	—	Bed for 6-11 and 6-12 Machines.....	35 00
9225	7256	Feed Lifting Rock Shaft with 134d, 2022 and 19967, for 64025.....	1 75
9229	7281	Feed Rock Shaft Crank with 50124d, for 64026.....	1 00
9232	7310	Lifting Presser Bar Lifting Link for 6-14 and 6-15 Machines.....	50
9291	7250	Vibrating Presser Bar Spring Bracket Rivet for 9127 and 9190.....	01
11025	7298	Lifting Presser Bar Bell Crank Adjusting Arm with 1513j and 1882, for 9147 and 9181.....	2 00
11031	7252	Lifting Presser Bar Spring (flat).....	1 50
11032	7304	“ “ “ “ Bracket for 11031, obsolete.....	25
11048	7304	Lifting Presser Bar Guide Bracket with 145b, 434c and 445c, for 9109, obsolete.	2 50
11054	7251	Crank Connecting Rod with 9141 and two 575e.....	1 75
11071	7298	Lifting Presser Bar Guide Bracket with 145b, 193e, 434c and 445c, for 6-11 and 6-12 Machines.....	3 00
11072	7301	Vibrating Presser Bar Hinge Stud for 6-11 and 6-12 Machines.....	25
11165	7263	Oscillating Rock Shaft Oil Pad for 9114 and 9151.....	01



## NUMERICAL LIST OF PARTS

NO.	PLATE	NAME	EACH
11241	7263	Arm Spool Pin Washer (cloth) . . . per 100	\$ 25
11360	7298	Bed Bracket (right) with wood screw 1 in. No. 16 (Accessories) . . . . .	10
11361	7298	Bed Bracket (left) with wood screw 1 in. No. 16 (Accessories) . . . . .	10
11424	7308	Thread Eyelet (front of arm) for 6-14 and 6-15 Machines . . . . .	03
11446	7250	Belt Shifter Chain Eyelet for 9139 . . . . .	04
11451	7253	" " Guide Rod for 9139 . . . . .	75
11453	7263	" " " " Collar with two 448c, for 9139 . . . . .	15
11454	7273	Belt Shifter Guide Rod Spring for 9139 . . . . .	15
11497	7302	Oil Cup for 11921, obsolete . . . . .	80
11509	7301	Vibrating Presser Bar Cushion (rawhide) for 6-11 and 6-12 Machines . . . . .	01
11754	7252	Bobbin Winder (hand, for machine bed) complete, Nos. 2269, 11756, 11758 to 11761 and 11763 to 11765, obsolete . . . . .	2 00
11756	—	Bobbin Winder Belt with 25028, for 11754, obsolete . . . . .	05
Nos. 11758 TO 11761 FOR 11754, OBSOLETE.			
11758	6054	Bobbin Winder Frame . . . . .	50
11759	6054	" " Pulley . . . . .	25
11760	6054	" " " Driving Wheel . . . . .	50
11761	—	Bobbin Winder Pulley Driving Wheel Handle complete, Nos. 8380, 8382 and 11762 . . . . .	10
11762	6054	Bobbin Winder I lley Driving Wheel Handle Stud for 11761, obsolete . . . . .	10
Nos. 11763 TO 11765 FOR 11754, OBSOLETE.			
11763	6054	Bobbin Winder Pulley Driving Wheel Stud . . . . .	10
11764	7270	Bobbin Winder Pulley Driving Wheel Stud Washer . . . . .	01
11765	6054	Bobbin Winder Spindle . . . . .	40
11831	6047	Screw Driver, large (Accessories) . . . . .	20
11832	7255	Shuttle Race Back for 9100 . . . . .	1 00
11833	7250	" " " Position Pin for 9100 and 9185 . . . . .	01
11834	7255	Shuttle Race Back Spring for 9100 and 9185 . . . . .	25
11838	7250	Shuttle Race Frame Position Pin for 9099 . . . . .	03

## NUMERICAL LIST OF PARTS

NO.	PLATE	NAME	EACH
11851	833	Shuttle (cylinder) 3 in. diam., complete, Nos. 590E, 773U, 8961, 8964, 11852 to 11855, 11910 and 12002, obsolete, use 19871 . . . . .	\$4 00
11852	833	Shuttle Cylinder for 11851 and 19871, obsolete . . . . .	1 50
11853	7268	Shuttle Cylinder Latch for 11851, 19871 and 19980 . . . . .	15
11854	833	Shuttle Cylinder Latch Spring for 11851, obsolete . . . . .	03
11855	833	Shuttle Frame for 11851, obsolete, use 19870 . . . . .	1 75
11910	7268	Shuttle Bobbin for 11851, 19871 and 19980 Nos. 11917 TO 11919 FOR 11921 AND 16990.	25
11917	7251	Oil Cup Cover . . . . .	25
11918	7260	" or Wax Stripper Washer (steel) for 11917 . . . . .	03
11919	7260	Oil Cup Thread Eyelet . . . . .	05
11921	7302	Oil Cup complete, Nos. 2205, 8482, 9084, 11497, 11917 to 11919, two 8953 and three 207E, obsolete . . . . .	1 25
11950	7301	Thread Eyelet (side of arm) . . . . .	05
12002	7268	Shuttle Cylinder Latch Pin for 11851, 19871 and 19980 . . . . .	01
13175	7308	Feed Dog Carrier Spring for 6-14 and 6-15 Machines . . . . .	01
14785	7298	Driving Attachment Lever Spring Hook for 9198, obsolete . . . . .	10
16960	7304	Lifting Presser Bar Lifter with 8761 and 8763, obsolete . . . . .	1 25
16987	7261	Needle Bar Connecting Stud with two 129D, for 6-14 and 6-15 Machines . . . . .	2 00
16988	7261	Needle Clamp with 149E and 8749, for 6-14 and 6-15 Machines . . . . .	1 25
16989	7251	Oil Cup for 16990 . . . . .	80
16990	7251	Oil Cup complete, Nos. 2205, 8482, 9084, 11917 to 11919, 16989, two 8953 and three 207E . . . . .	1 25
16996	7267	Lifting Presser Bar Lifter with 8761 and 8763 . . . . .	1 25
Nos. 19602 TO 19604 FOR 6-14 AND 6-15 MACHINES.			
19602	7309	Buff Wheel Clamp Carrier Locking Rack Bracket with two 453c . . . . .	1 50

NO.	PLATE	NAME	EACH
19603	7310	Buff Wheel Clamp Carrier Locking Rack Bracket Hinge Pin	\$ 25
19604	—	Buff Wheel Clamp Carrier Locking Rack Bracket Latch complete, Nos. 19605 to 19608	1 35
Nos. 19605 TO 19608 FOR 19604.			
19605	7310	Buff Wheel Clamp Carrier Locking Rack Bracket Latch Body with 453c	75
19606	7306	Buff Wheel Clamp Carrier Locking Rack Bracket Latch Pin	30
19607	7306	Buff Wheel Clamp Carrier Locking Rack Bracket Latch Pin Head	25
19608	7308	Buff Wheel Clamp Carrier Locking Rack Bracket Latch Spring	05
19609	7305	Buff Wheel Clamp Carrier Sliding Flange with 453c, for 6-14 and 6-15 Machines.	75
19611	7306	Buff Wheel Clamp Carrier Sliding Flange Gear with 462c, for 6-14 and 6-15 Machines	75
19611	7306	Buff Wheel Clamp Spindle Gear with 462c, for 6-14 and 6-15 Machines	75
19614	7250	Buff Wheel Clamp Carrier Hook for 9159.	05
19614	7250	Vibrating Presser Bar Spring Hook for 9130, 9131, 9193 and 9194	05
Nos. 19617 TO 19621 FOR 6-14 AND 6-15 MACHINES.			
19617	7311	Buff Wheel Clamp Carrier Weight (3¼ lbs.) with 19624 and 19625	30
19618	7311	Buff Wheel Clamp Carrier Weight (4½ lbs.) with 19624 and 19625	35
19619	—	Buff Wheel Clamp Carrier Weight Con- nection (belt) with 19621	10
19620	7312	Buff Wheel Clamp Carrier Weight Con- nection Guide Pin for 9187	03
19621	7308	Buff Wheel Clamp Carrier Weight Con- nection Hook for 19619	02
19623	7306	Buff Wheel Clamp Carrier Weight Con- nection Pulley Bracket for 6-14 and 6-15 Machines	30
19624	7305	Buff Wheel Clamp Carrier Weight Eyelet for 19617 and 19618	05
19625	7305	Buff Wheel Clamp Carrier Weight Eyelet Hook for 19617 and 19618	05
19627	7306	Buff Wheel Clamp Spindle Plate Spur for 9170, obsolete	05

NO.	PLATE	NAME	EACH
19628	7306	Buff Wheel Thumb Screw Washer for 6-14 and 6-15 Machines	\$ 15
19632	7309	Feed Dog Carrier with 8077, for 6-14 and 6-15 Machines	2 00
19633	7308	Feed Dog Carrier Spring Hook for 9158	05
19634	7306	Guide Pin, for circular stitching	35
19647	7308	Vibrating Presser and Stretching Foot Spring Stud for 6-14 and 6-15 Machines	05
19674	7309	Lifting Presser Bar Guide Bracket with 145b and two 445c, for 6-14 and 6-15 Machines	5 00
19682	7305	Lifting Presser Bar Connecting Stud with 445c and 523c, for 6-14 and 6-15 Machines	1 25
19869	7268	Shuttle Cylinder Latch Spring for 19870 and 19980	01
19870	3555	Shuttle Frame with 19869, for 19871, obsolete	1 75
19871	3555	Shuttle (cylinder) 3 in. diam., complete, Nos. 773H, 8961, 8961, 11852, 11853, 11910, 12002 and 19870, obsolete, use 19980	4 00
19967	7263	Feed Lifting Rock Shaft Wearing Block for 9225 and 64014	35
Nos. 19977 TO 19979 FOR 19980.			
19977	7268	Shuttle Cylinder	1 50
19978	7268	" Frame	1 75
19979	7268	" Tension Spring	40
19980	7268	Shuttle (cylinder) 3 in. diam., complete, Nos. 773H, 8961, 11853, 11910, 12002, 19869 and 19977 to 19979	4 00
25028	7270	Bobbin Winder Belt Hook for 11756, obsolete	01
25837	7308	Vibrating Presser and Stretching Foot Spring for 6-14 and 6-15 Machines	02
26026	6047	Screw Driver, small (Accessories)	10
27555	7285	Bobbin Winder Thread Unwinder Spool Pin for 27556	08
27556	—	Bobbin Winder Thread Unwinder Spool Rest 27583 with 138B and two 27555, for 41823	40
27557	7285	Bobbin Winder Thread Unwinder Spool Stand with 138B, for 41823	25
27560	7285	Bobbin Winder Thread Unwinder Thread Guard Rod, 26 in. long, for 41823	30

## NUMERICAL LIST OF PARTS

NO.	PLATE	NAME	EACH
27583	7285	Bobbin Winder Thread Unwinder Spool Rest for 27556.....	\$ 20
27636	7253	Driving Attachment Treadle for 27642..	30
Nos. 27637 to 27639 FOR 27640.			
27637	7251	Driving Attachment Treadle Pitman Rod (lower).....	05
27638	7260	Driving Attachment Treadle Pitman Rod (lower) Spring.....	03
27639	7251	Driving Attachment Treadle Pitman Rod (upper).....	05
27640	7251	Driving Attachment Treadle Pitman com- plete for 27645, Nos. 2762, 9079 and 27637 to 27639.....	35
27642	—	Driving Attachment Treadle complete for 27643, Nos. 2878, 9082, 27636 and four wood screws 1 in. No. 16.....	45
27643	—	Driving Attachment Treadle and Pitman complete for 9198, Nos. 27640 and 27642	80
32875	7301	Needle Bar Connecting Stud with two 1149F, for 6-11 and 6-12 Machines.....	3 00
36565	6047	Oiler (copper plated) with 36566 (Ac- cessories).....	15
36566	6047	Oiler Spout, 9 in. long, for 36565.....	08
41441	6782	Bobbin Winder Frame Hinge Pin for 41900	10
41446	6781	Bobbin Winder Stop Latch Hinge Pin for 41900.....	10
41452	7285	Bobbin Winder Thread Unwinder Thread Guard for 51453.....	40
41453	—	Bobbin Winder Thread Unwinder Thread Guard complete for 41823, Nos. 330D, 637c, 1560c, 2103, 5769, 41452 and two 2102.....	70
41514	7285	Bobbin Winder Thread Unwinder Spool Weight, 4 in. diam., with 41515, for 41823.....	15
41515	7250	Bobbin Winder Thread Unwinder Spool Weight Centre Pin for 41514.....	05
41544	7250	Thread Take-up Spring Regulator Screw Washer.....	05
41544	7250	Thread Take-up Staple Screw Washer...	05
41557	6781	Bobbin Winder Stop Latch for 41900....	15
41823	7285	Bobbin Winder Thread Unwinder com- plete, for two large spools, for 41903 and 41904, Nos. 27556, 27557, 27560, 41453, two 41514 and three wood screws 1¼ in. No. 12.....	1 95

## NUMERICAL LIST OF PARTS

NO.	PLATE	NAME	EACH
41894	6781	Bobbin Winder Base with 449c, for 41900	\$ 50
41895	7270	" " Bobbin Carrier Key for 41898.....	01
Nos. 41896 to 41899 FOR 41900.			
41896	6782	Bobbin Winder Frame.....	35
41897	6782	" " " Spring.....	05
41898	6781	" " Spindle with 41895.....	25
41899	6782	" " Tripping Arm with 176D..	20
41900	6781	" " for 41903 and 41904, Nos. 2269, 41441, 41446, 41557, 41894, 41896 to 41899, 43176 to 43178, two 4784 and three 131D.....	3 45
41901	7252	Bobbin Winder Bracket for 41903.....	75
41902	7252	" " " " 41904.....	75
41903	—	Bobbin Winder (swinging automatic, left hand) complete for 6-12 and 6-15 Machines, Nos. 523D, 41823, 41900, 41901 and three 894D.....	6 45
41904	—	Bobbin Winder (swinging automatic, left hand) complete for 6-11 and 6-14 Machines, Nos. 523D, 41823, 41900, 41902 and three 894D.....	6 45
Nos. 43176 to 43178 FOR 41900.			
43176	6782	Bobbin Winder Pulley (leather).....	75
43177	6782	" " " Flange with two 448c.....	35
43178	6782	Bobbin Winder Pulley Washer.....	50
43184	7284	Wrench for 1606 (Accessories).....	50
43263	7270	Arm Screw Washer.....	05
50124D	7276	Feed Rock Shaft Crank Clamping Screw for 9211 and 9229.....	12
50201F	7306	Buff Wheel Thumb Screw for 6-14 and 6-15 Machines.....	30
50322D	7274	Feed Regulator Thumb Screw.....	40
50323D	7274	Lifting Presser Bar Spring Regulating Screw.....	10
50349E	7274	Arm Screw.....	15
58252	7267	Lifting Presser Bar Spring Bracket for 11031.....	25
61504	7253	Balance Wheel and Pulley (tight) with two 344c, for 6-12 and 6-15 Machines.	6 00
64002	7281	Thread Take-up Lever with 1513r, 1865 and 9219, for 6-14 and 6-15 Machines.	3 00
64014	7251	Feed Lifting Rock Shaft with 134D, 2022 and 19967, for 64015.....	1 75

NO.	PLATE	NAME	EACH
64015	—	Feed Lifting Rock Shaft complete for 6-11 and 6-12 Machines, Nos. 64014 and 64016.....	\$4 25
64016	7255	Feed Lifting Rock Shaft Crank with 611b, 1619E and 1926, for 64015.....	2 50
64017	—	Feed Rock Shaft complete for 6-11 and 6-12 Machines, Nos. 9054 and 9211....	4 25
*64019	—	Arm.....	35 00
Nos. 64020 TO 64024 FOR 6-11 AND 6-12 MACHINES.			
64020	7299	Lifting Presser Bar Lifting Link.....	50
64021	7301	“ “ “ “ “ Hinge Stud (lower).....	40
64022	7305	Feed Dog.....	1 00
64023	7307	Throat Plate with 225r and 64024, for 64022.....	7 00
64024	7305	Throat Plate Needle Plate for 64023.....	75
64025	—	Feed Lifting Rock Shaft complete for 6-14 and 6-15 Machines, Nos. 9176 and 9225	4 25
64026	—	Feed Rock Shaft complete for 6-14 and 6-15 Machines, Nos. 9177 and 9229....	3 00

## ILLUSTRATIONS OF PARTS

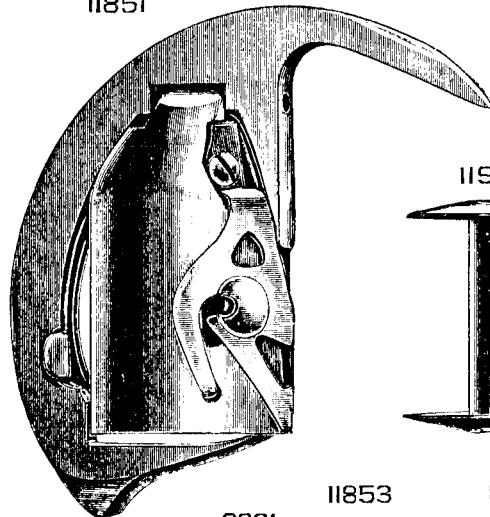
FOR

MACHINES Nos.

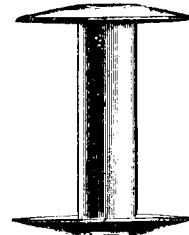
6-11, 6-12, 6-14 and 6-15

PLATE 833—FULL SIZE

11851

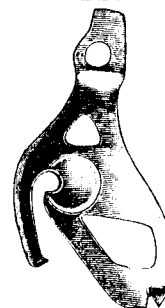
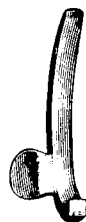


11910



11853

2964



8961

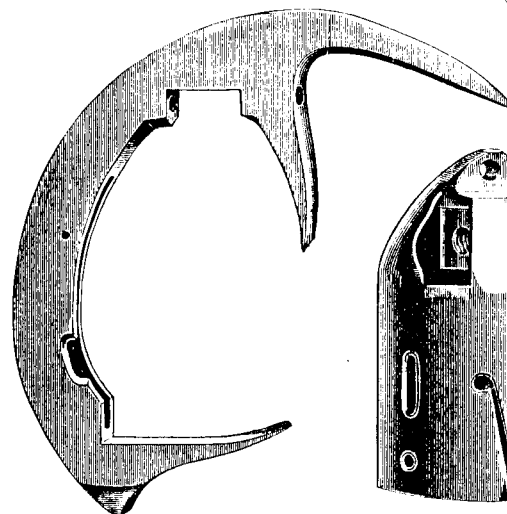
773

12002

11854



11855



11852

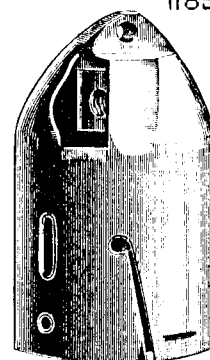


PLATE 3555—FULL SIZE

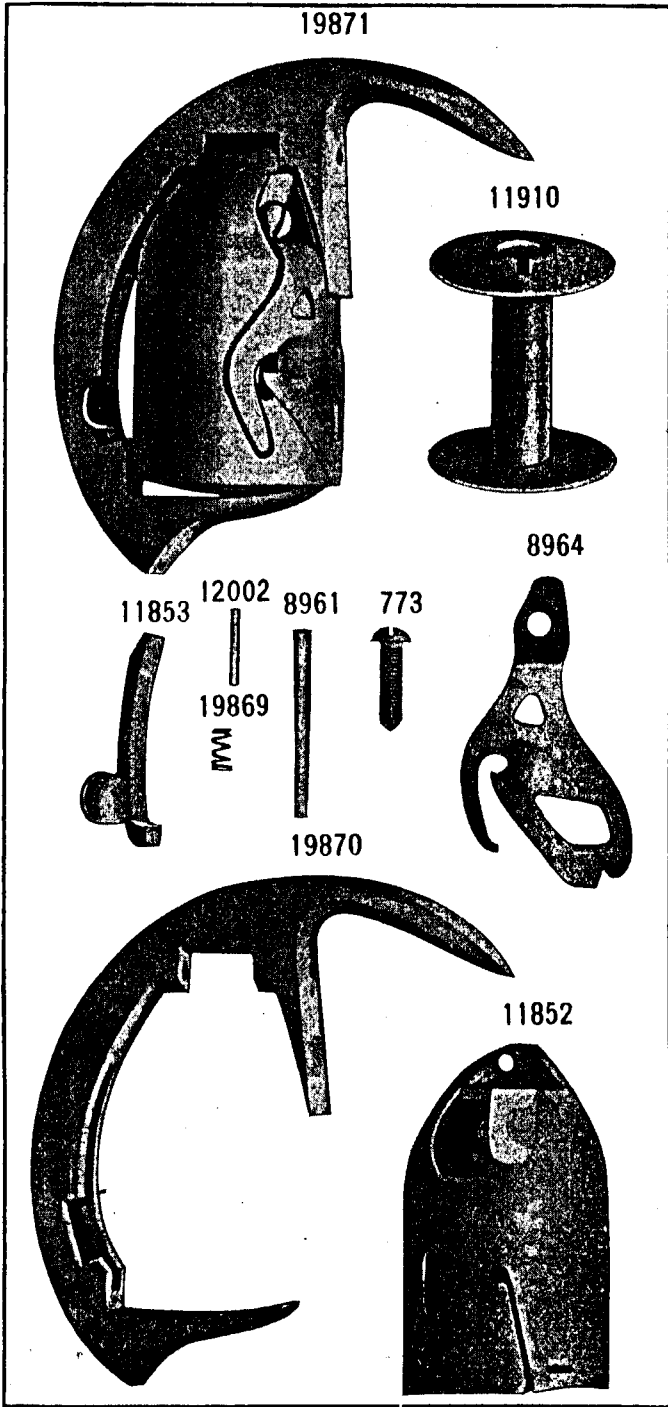


PLATE 4442—ONE-HALF SIZE

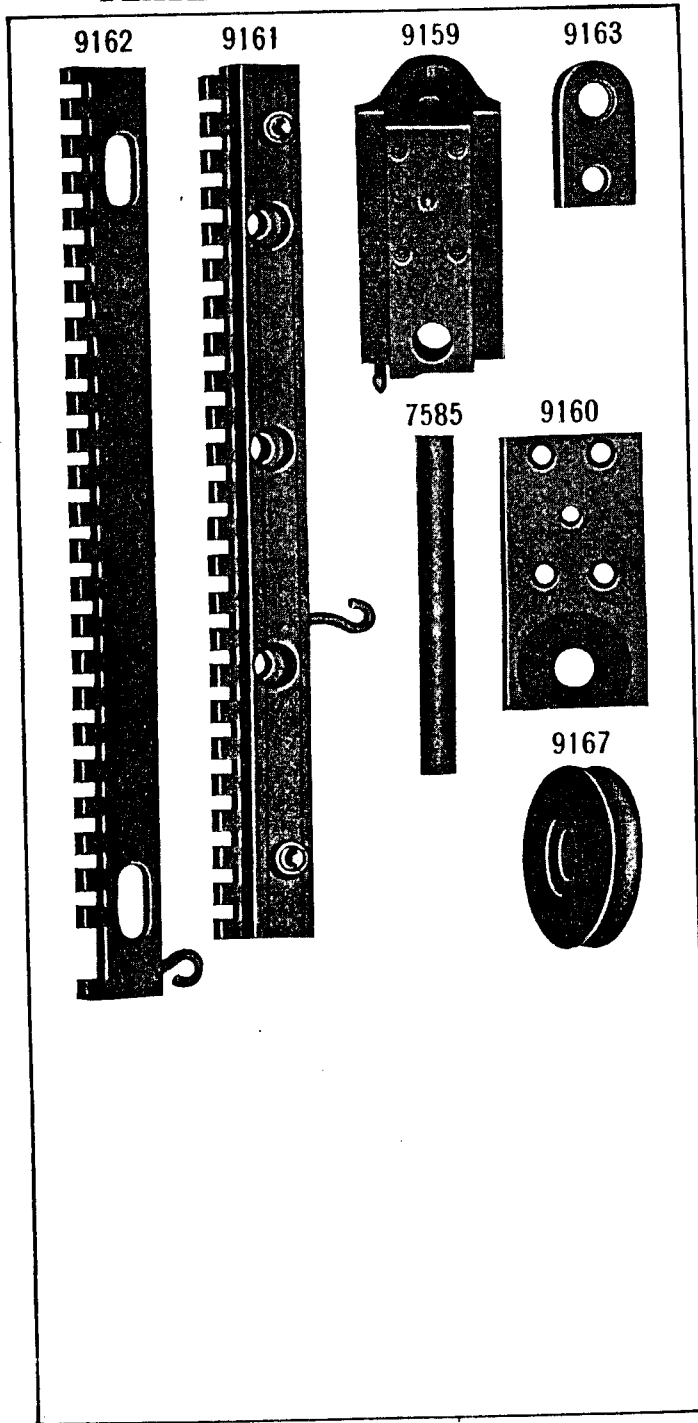


PLATE 6047—ONE-HALF SIZE

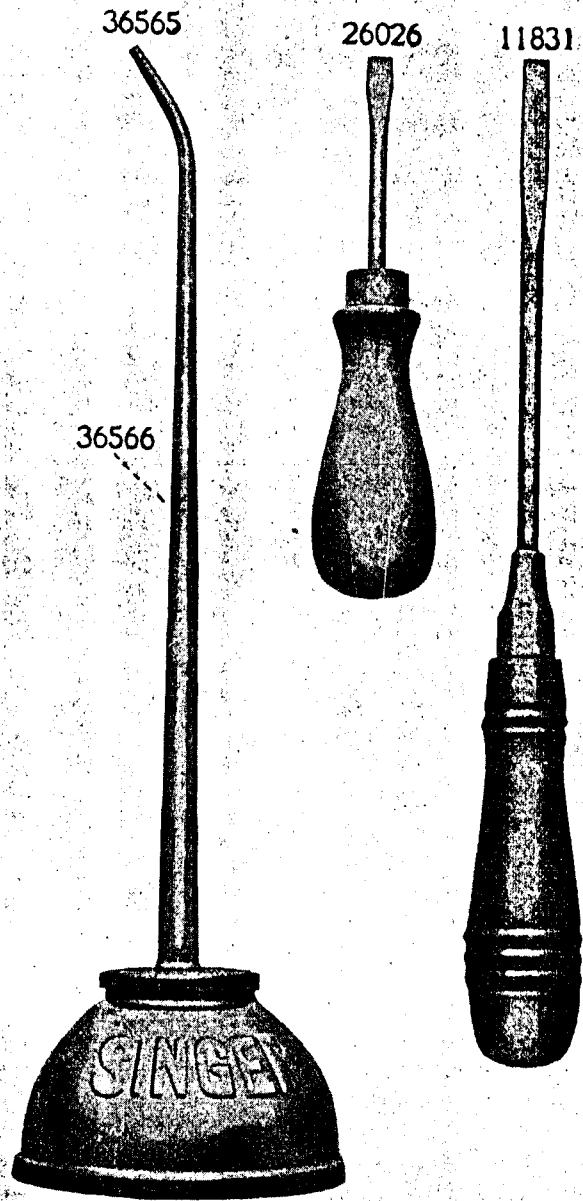


PLATE 6054—ONE-HALF SIZE

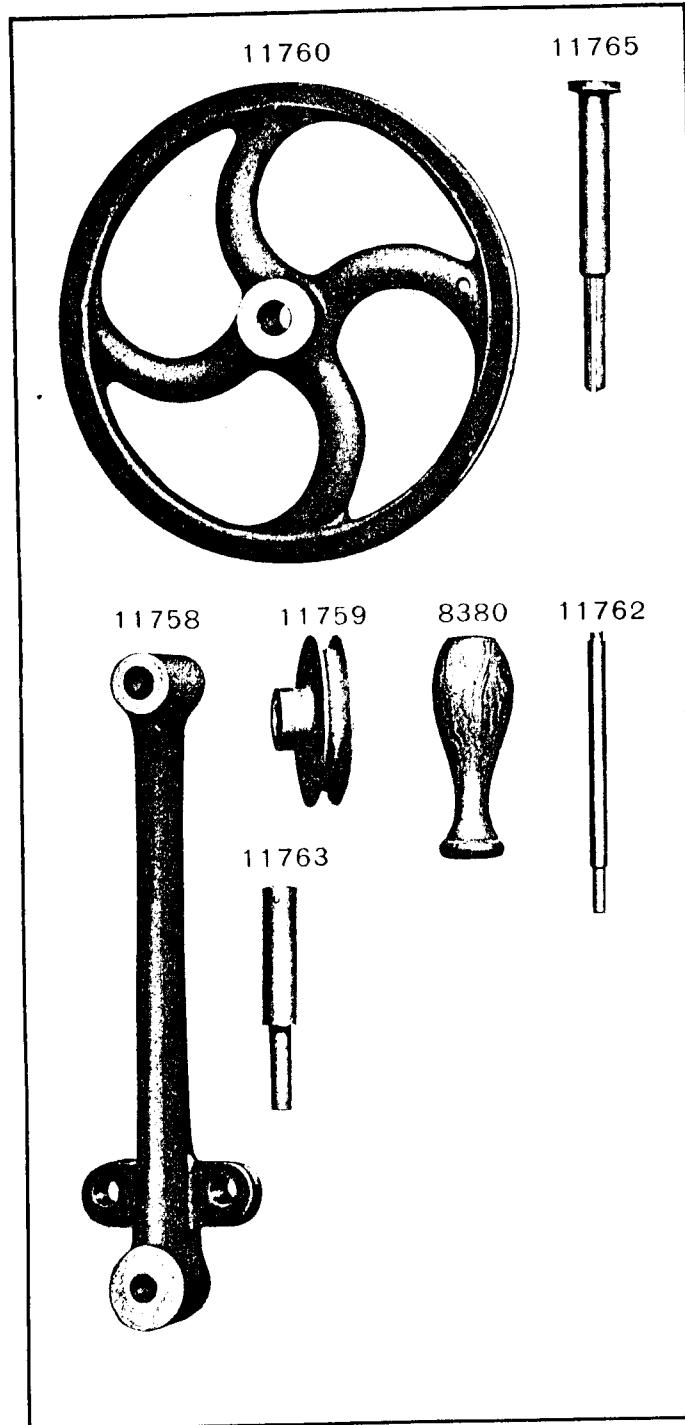
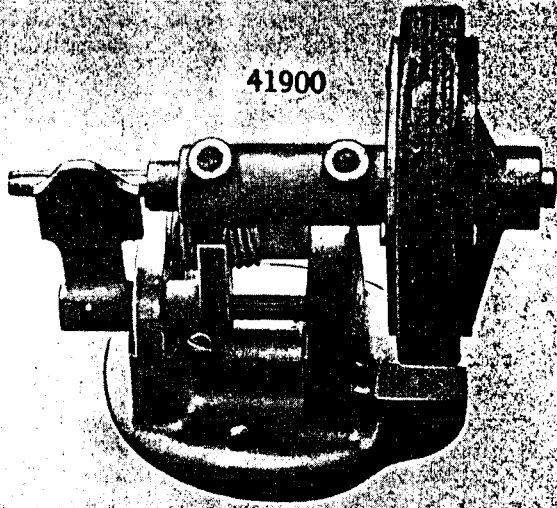
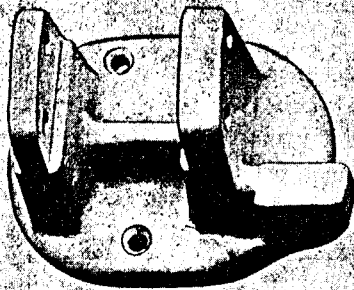


PLATE 6781—ONE-HALF SIZE

41900



41894



41557



41898

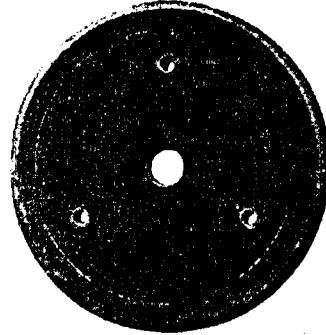


41446

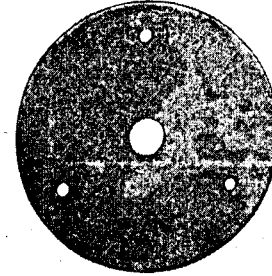


PLATE 6782—ONE-HALF SIZE

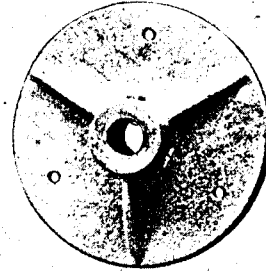
43176



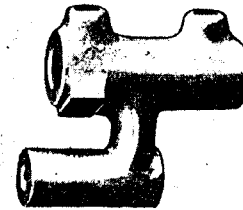
43178



43177



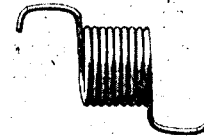
41896



41441



41897



41899





PLATE 7250—FULL SIZE

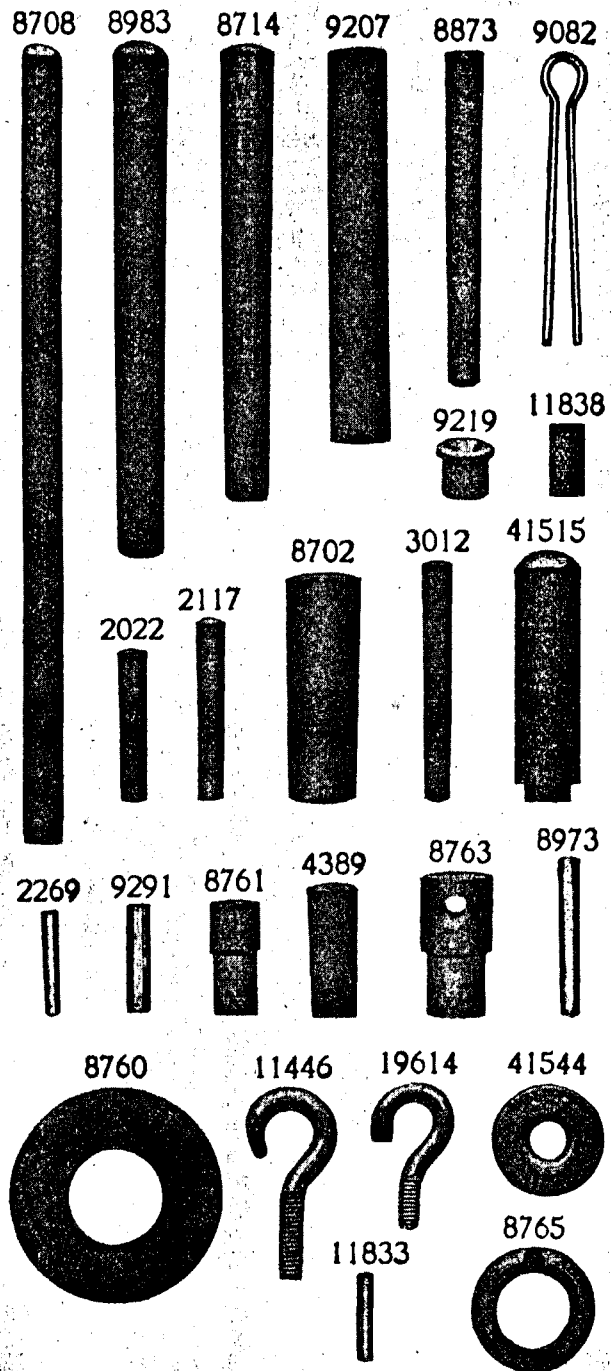


PLATE 7251—ONE-FOURTH SIZE

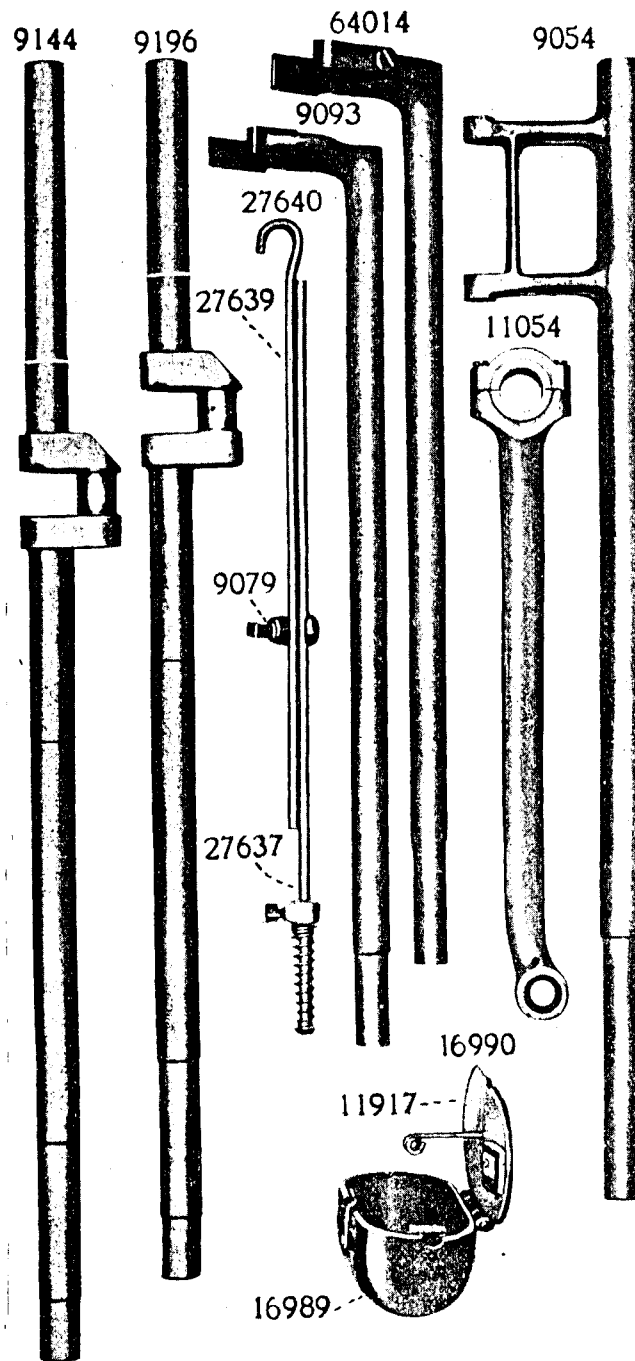


PLATE 7252—ONE-FOURTH SIZE

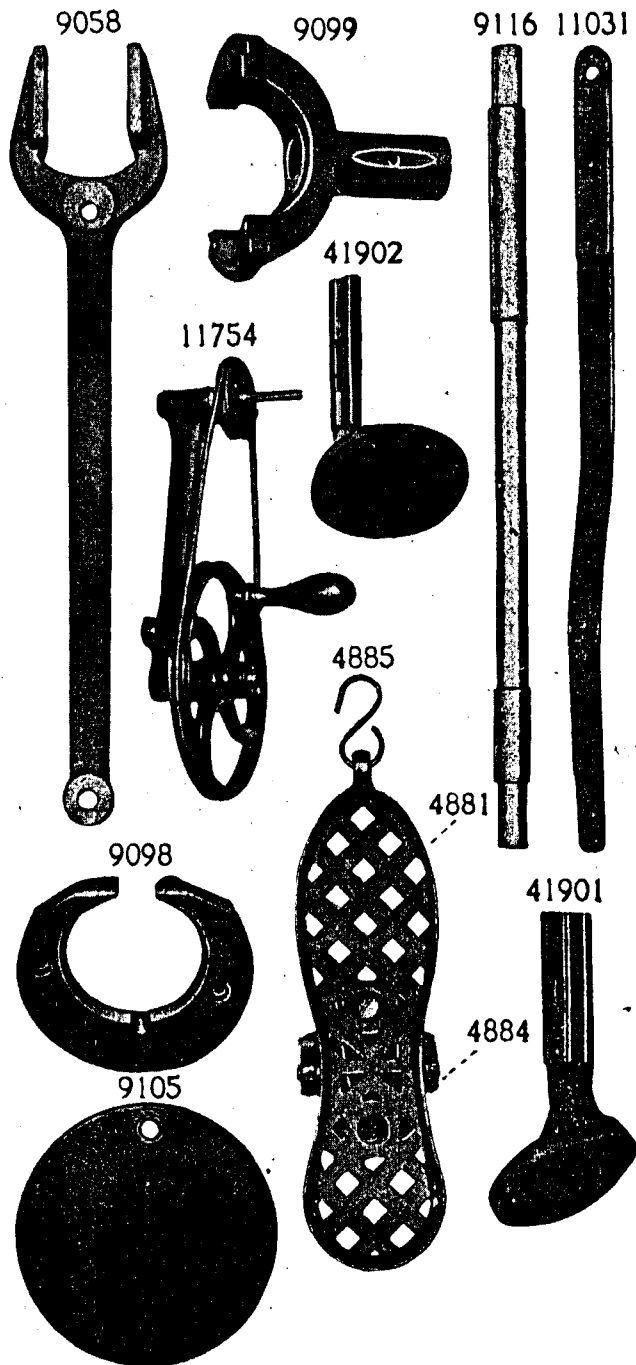


PLATE 7253—ONE-NINTH SIZE

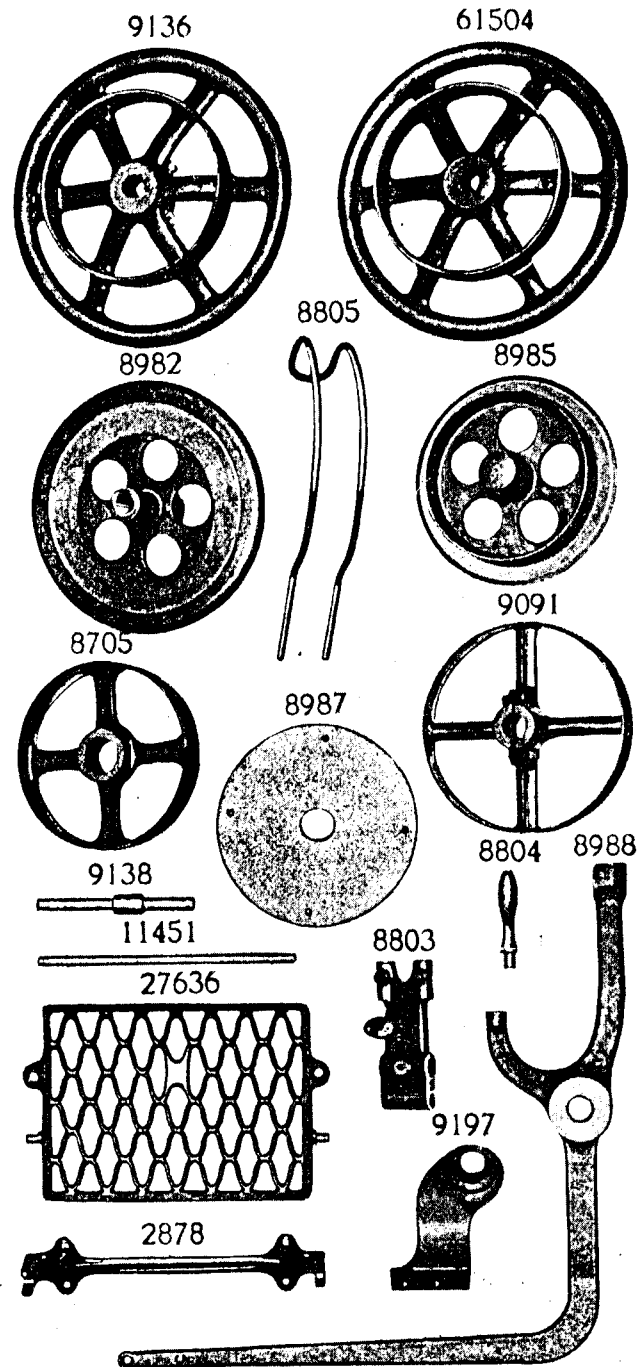
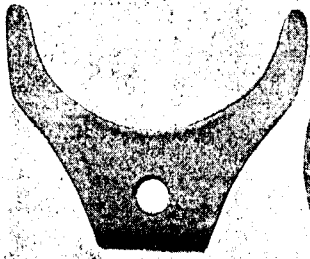
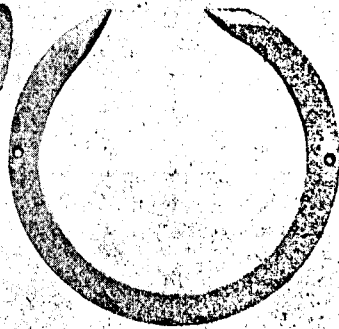


PLATE 7255—ONE-HALF SIZE

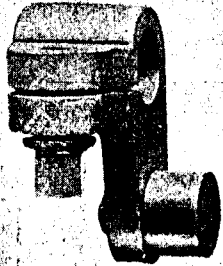
11834



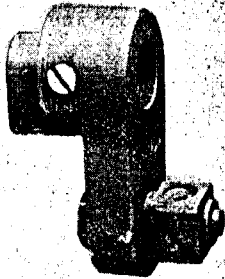
11832



64016



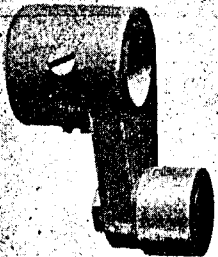
9154



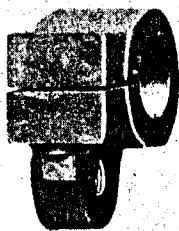
8927



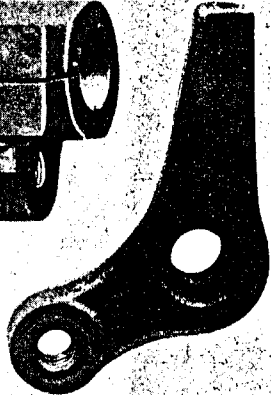
9096



9211



8930



8994

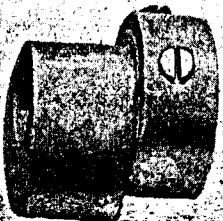
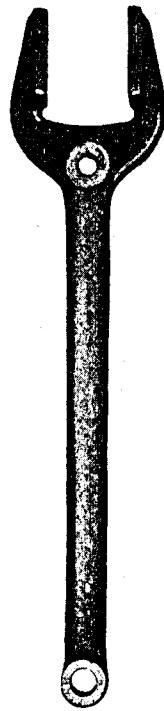


PLATE 7256—ONE-FOURTH SIZE

8929



9225

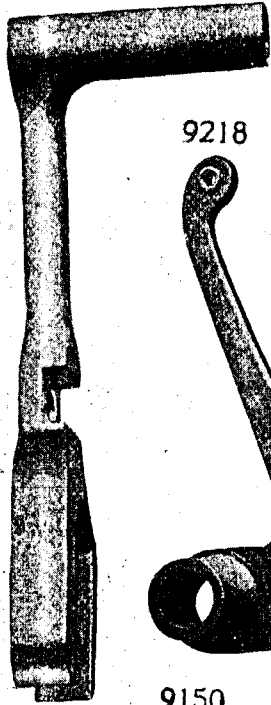


PLATE 7259—ONE-HALF SIZE

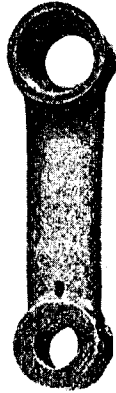
8745



9047



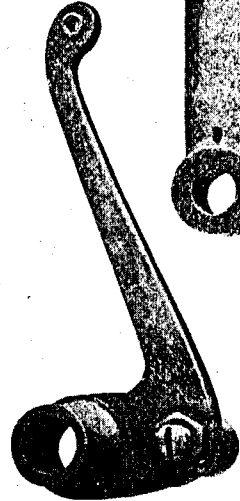
8746



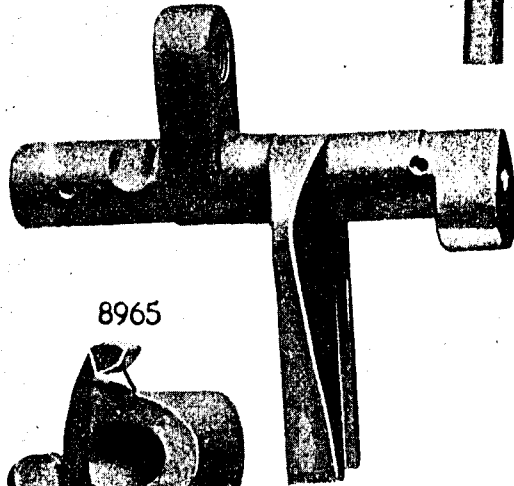
9115



9218



9150



8965

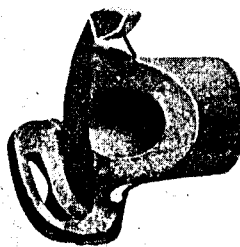
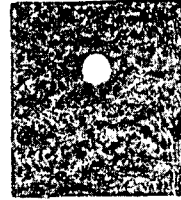


PLATE 7260—FULL SIZE

9084



8953



11919



11918



207



9214



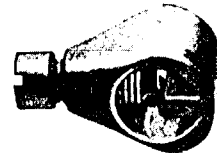
2205



8482



9060



149



8749



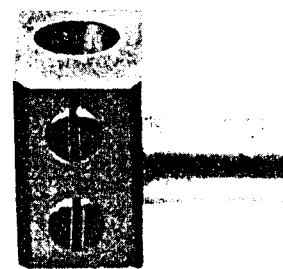
2762



27638



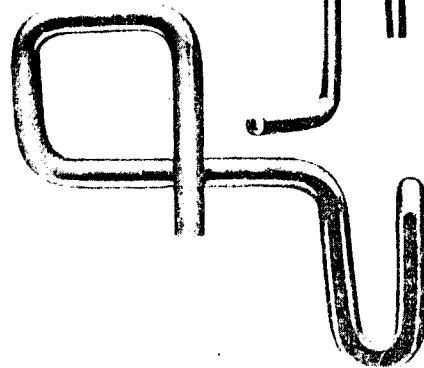
9057



8799



8801



1926

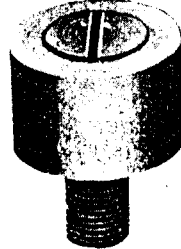


PLATE 7261—FULL SIZE

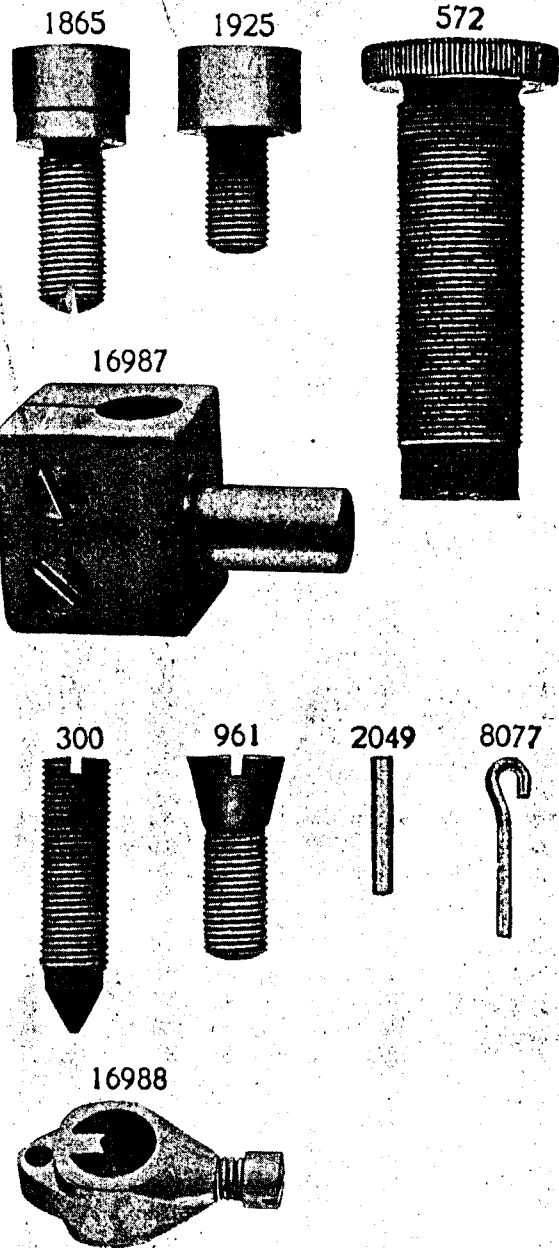


PLATE 7263—FULL SIZE

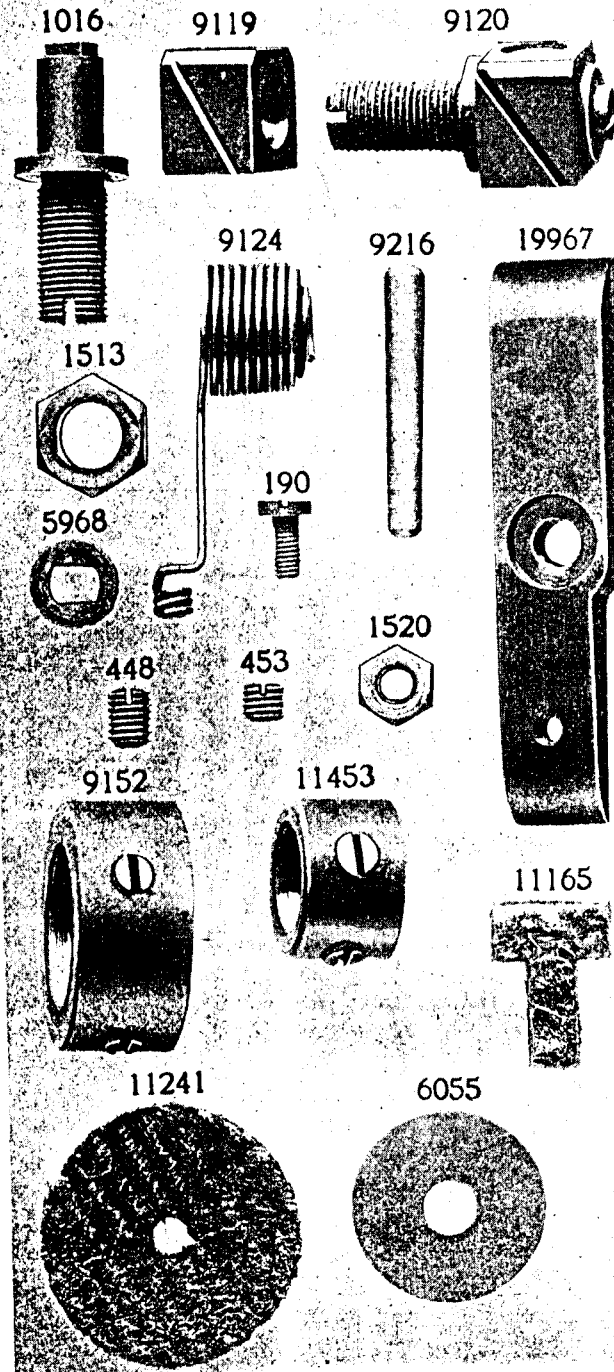


PLATE 7267—ONE-HALF SIZE

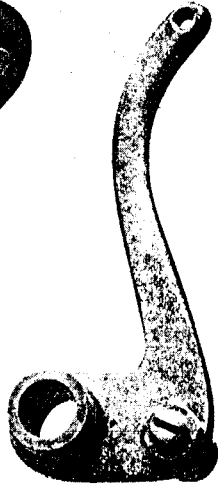
8792



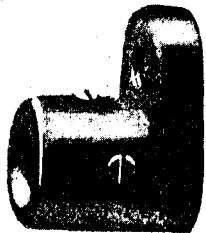
16996



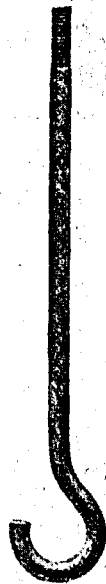
8968



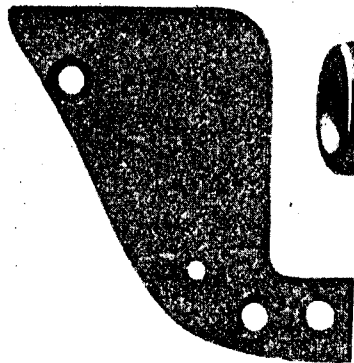
9055



9222



9110



58252

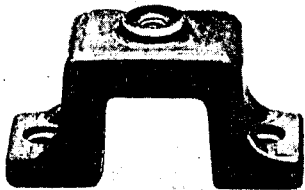
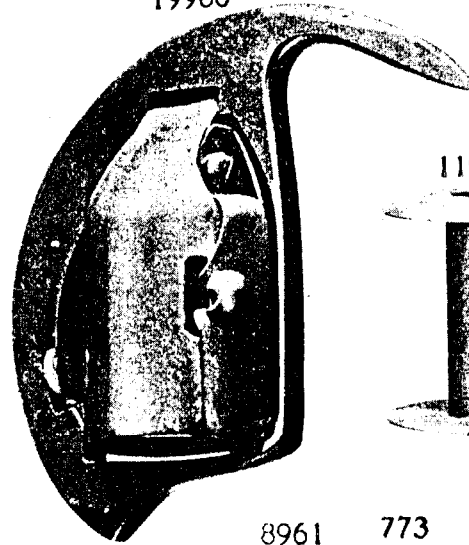
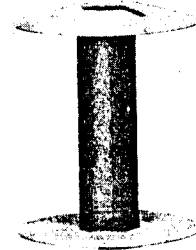


PLATE 7268—FULL SIZE

19980



11910



8961



773



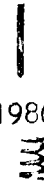
19979



11853



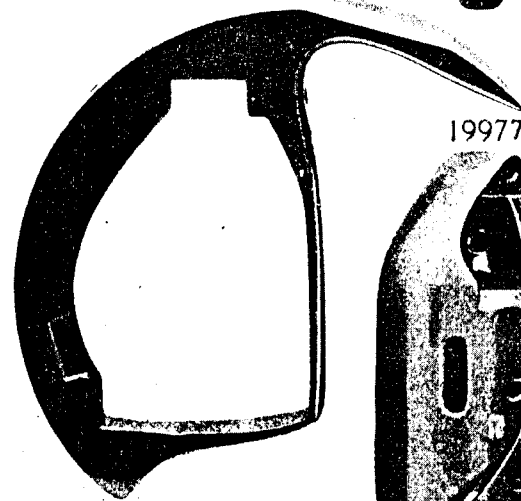
12002



19869



19978



19977



PLATE 7270—FULL SIZE

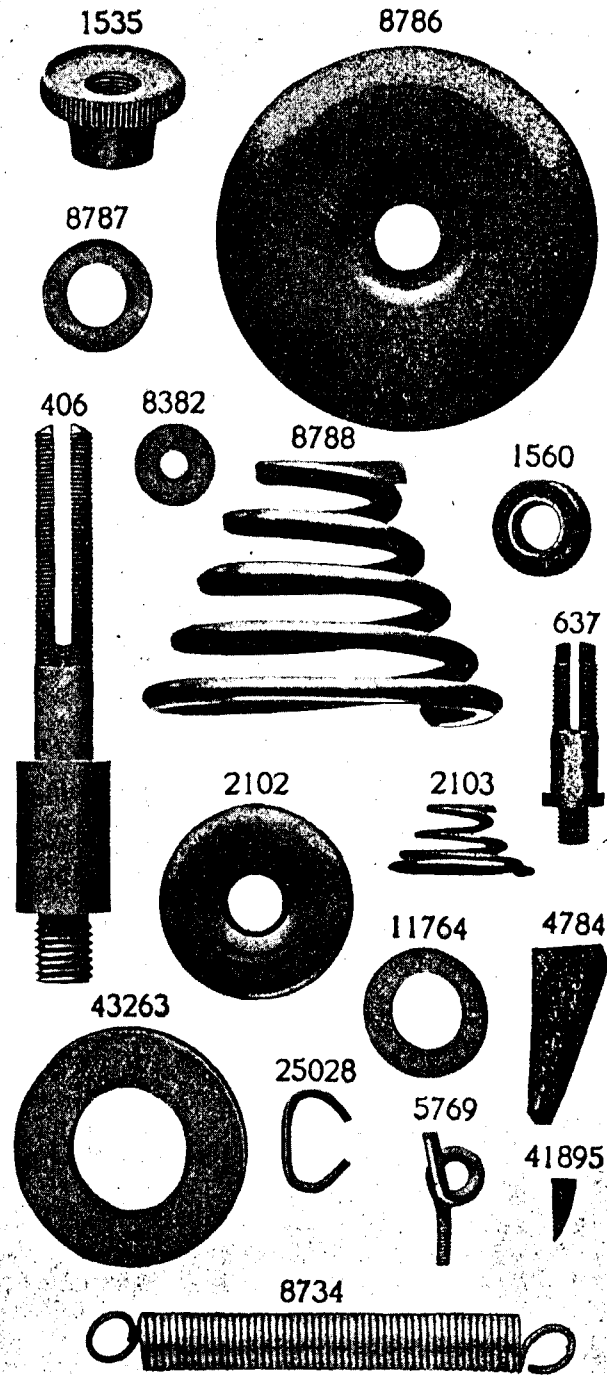


PLATE 7273—ONE-HALF SIZE

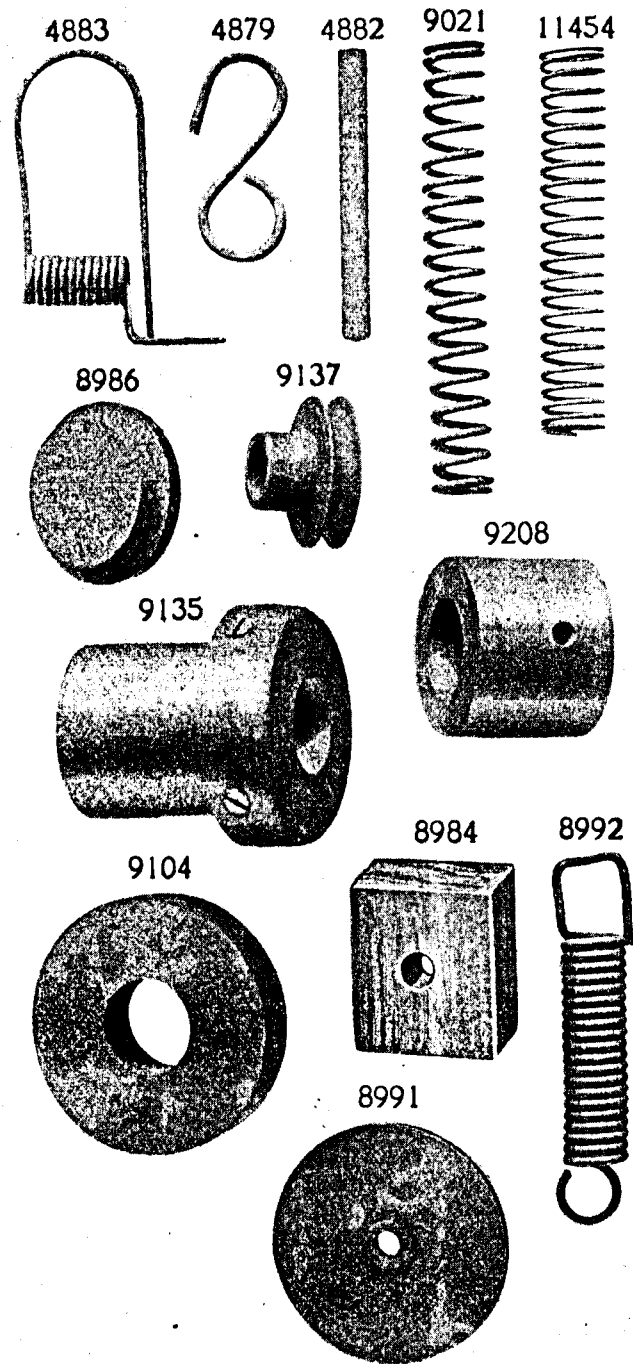


PLATE 7274—FULL SIZE

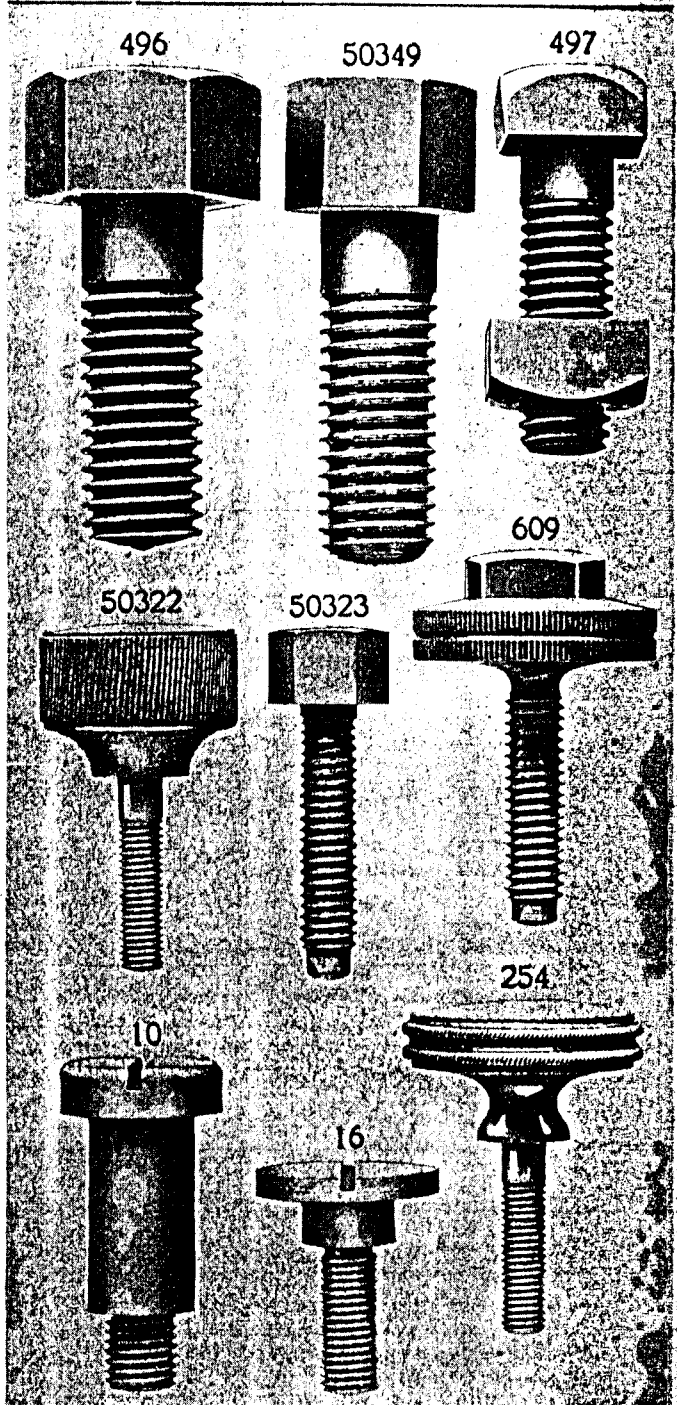


PLATE 7275—FULL SIZE

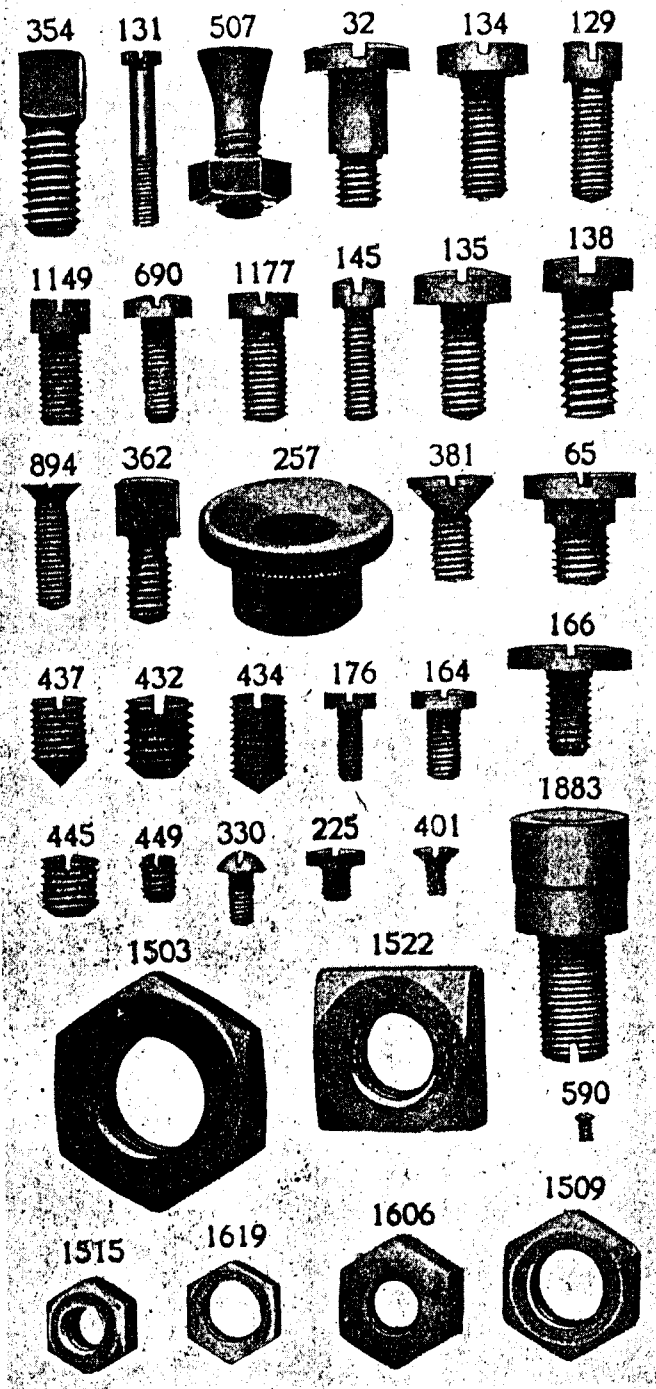




PLATE 7276—FULL SIZE

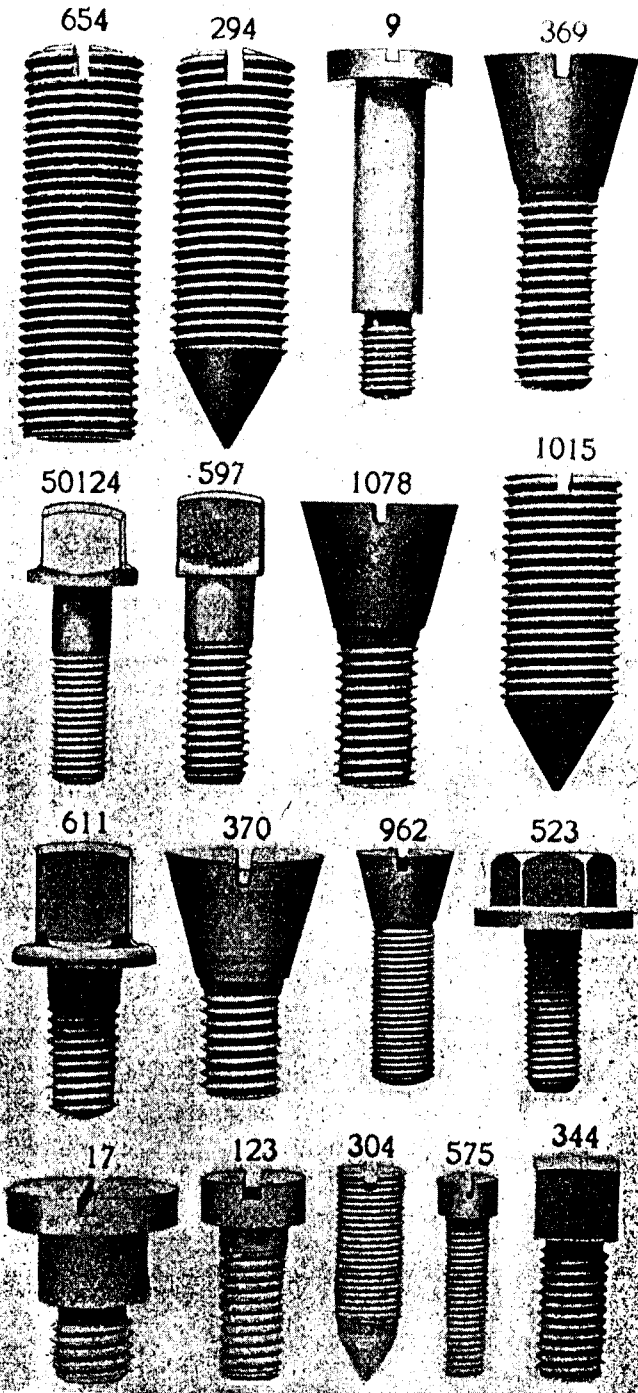


PLATE 7281—ONE-HALF SIZE

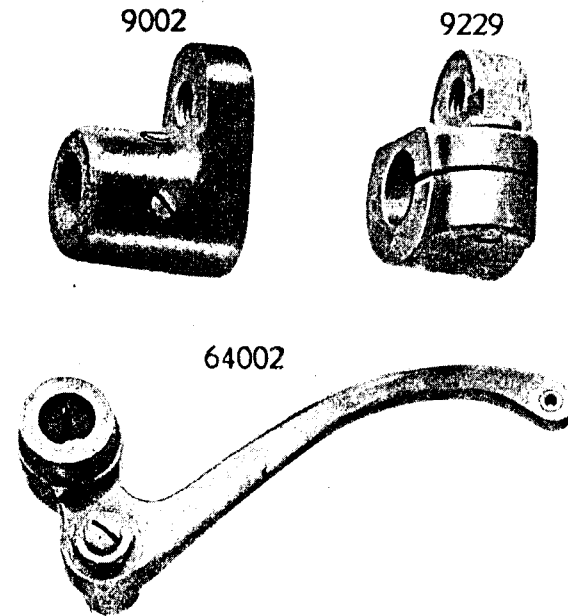


PLATE 7284—ONE-HALF SIZE

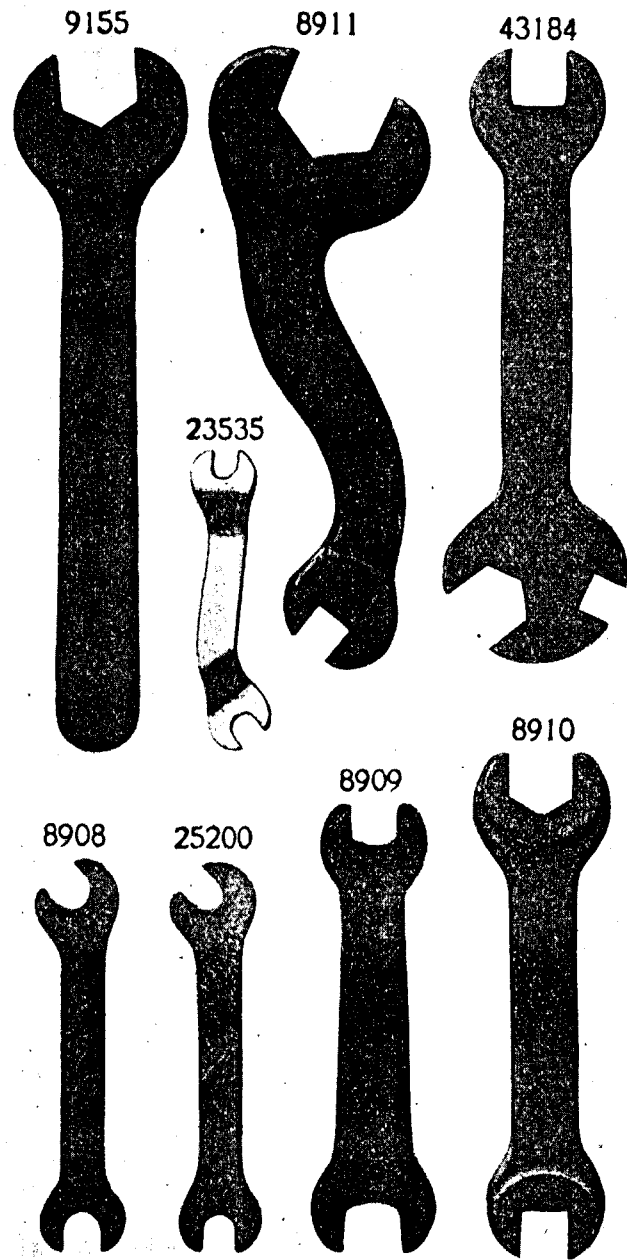


PLATE 7285—ONE-FOURTH SIZE

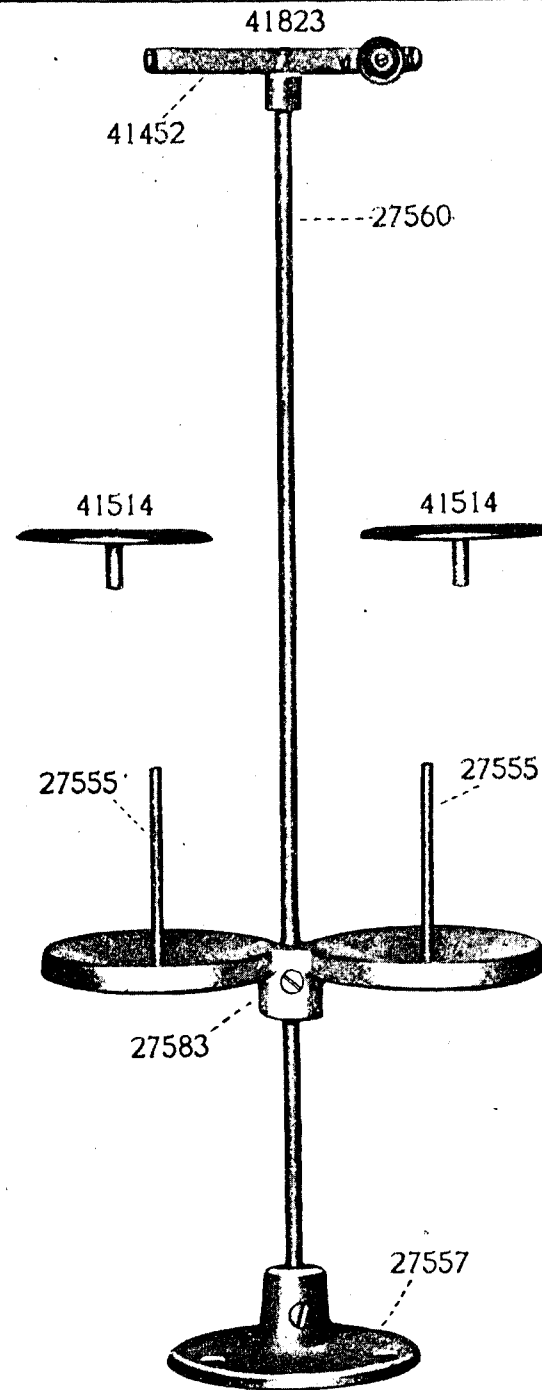
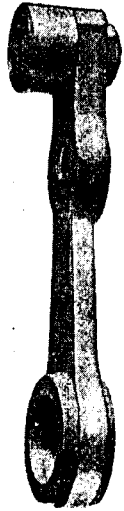


PLATE 7298—ONE-HALF SIZE

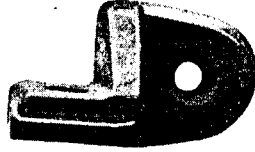
9145



11025



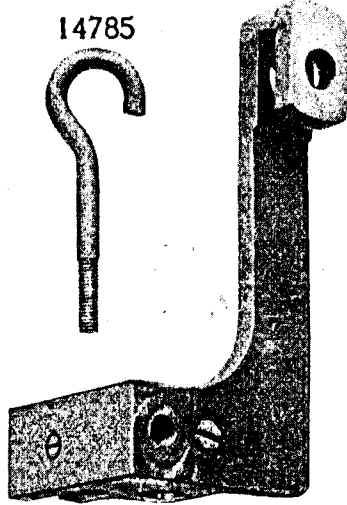
11361



14785



11071



9107



11360

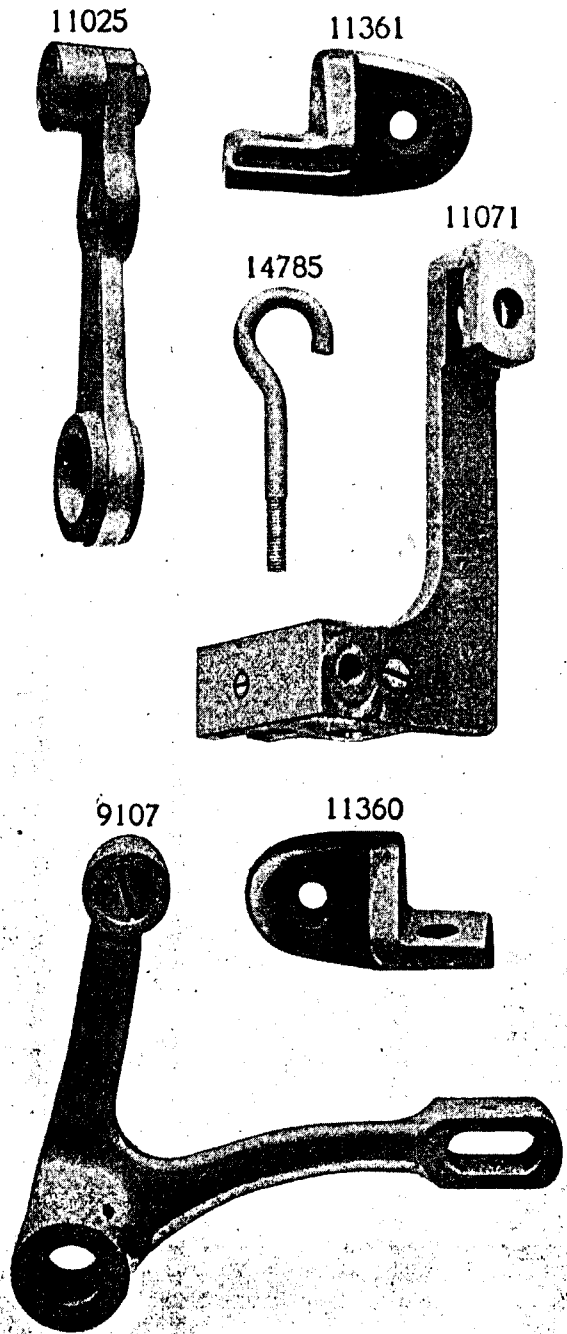
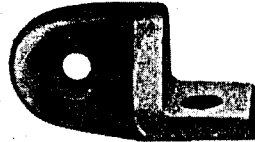
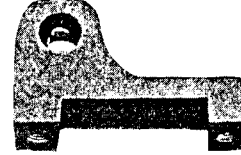


PLATE 7299—ONE-HALF SIZE

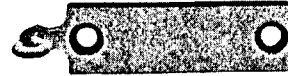
64020



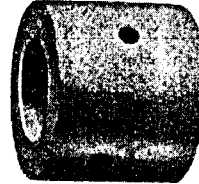
9128



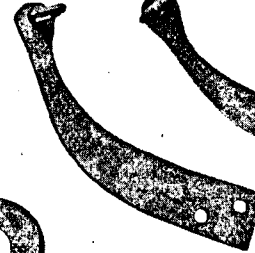
9130



9103



9131



9127



9146

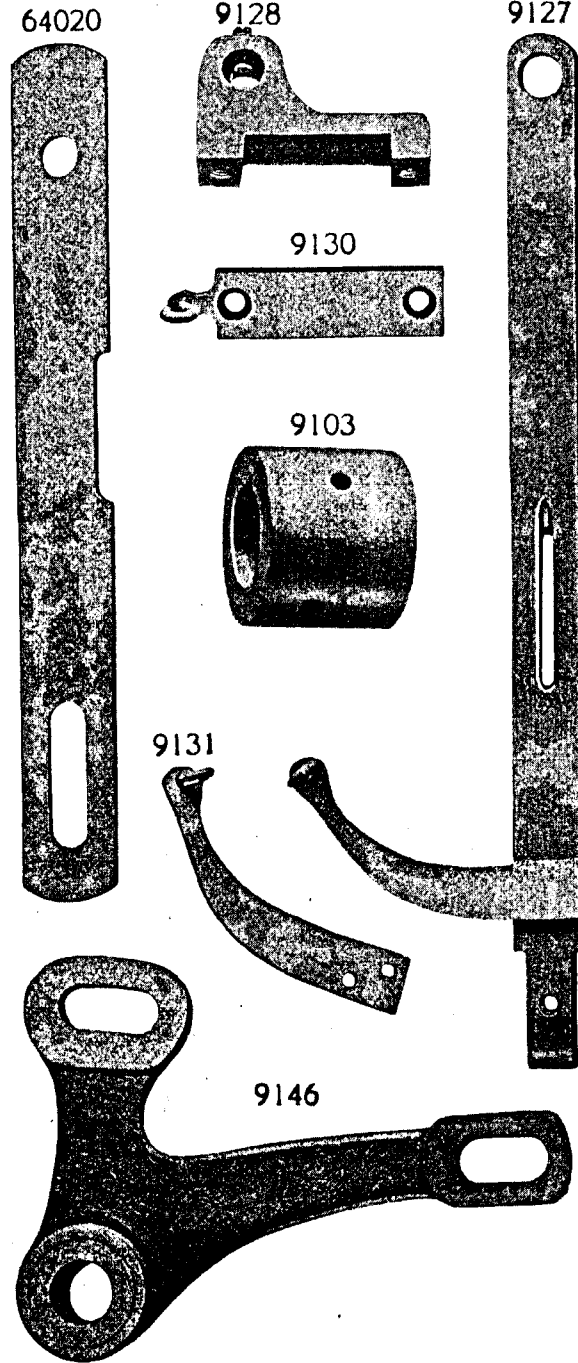
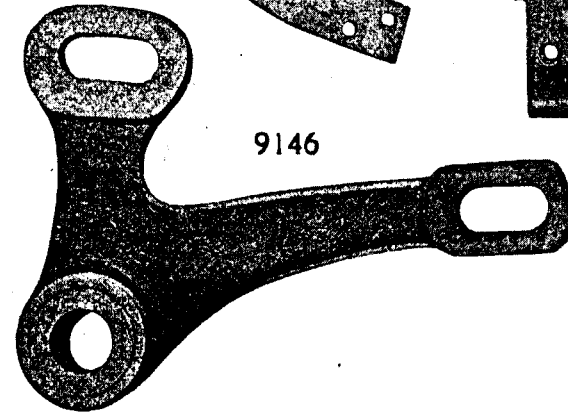


PLATE 7300—FULL SIZE

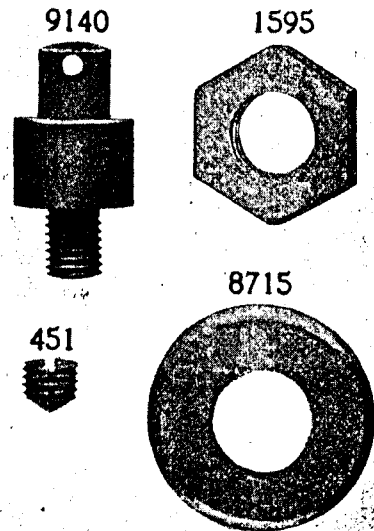
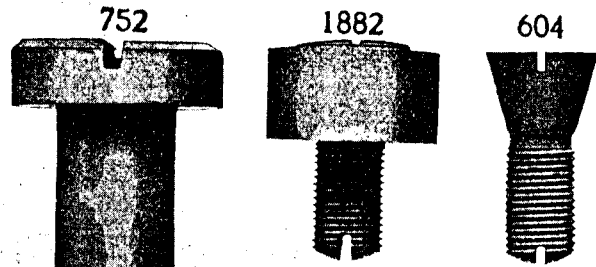
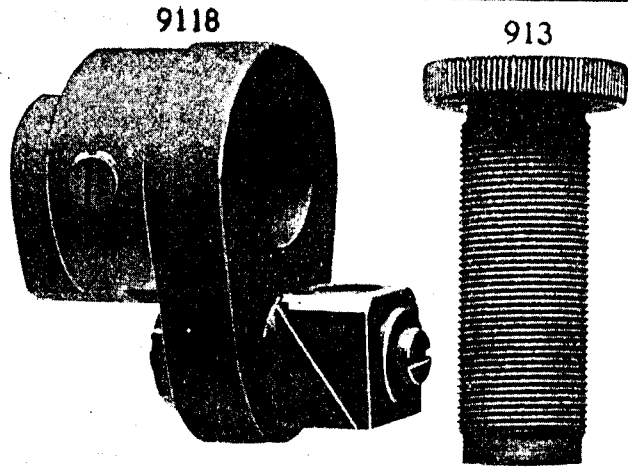


PLATE 7301—FULL SIZE

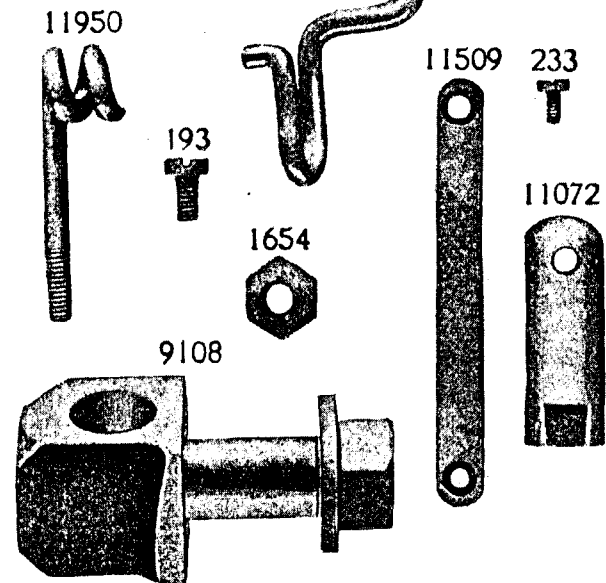
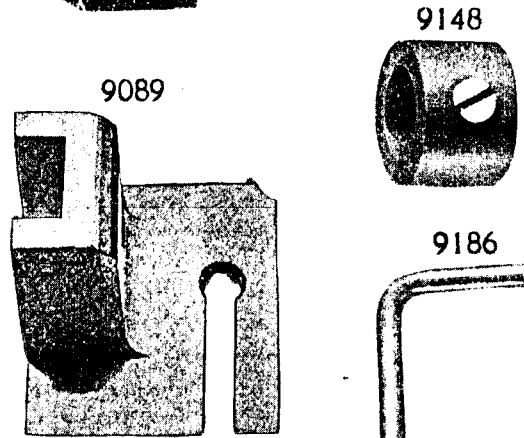
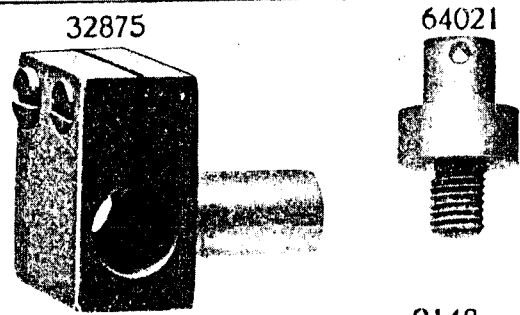
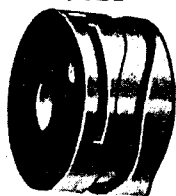


PLATE 7302—ONE-FOURTH SIZE

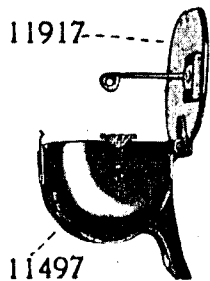
9102



9123



11921



11917

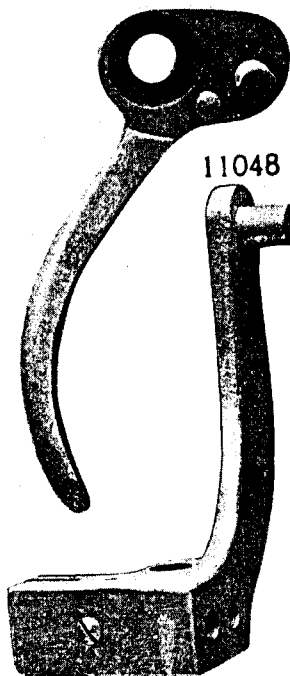
11497

PLATE 7304—ONE-HALF SIZE

9149



16960

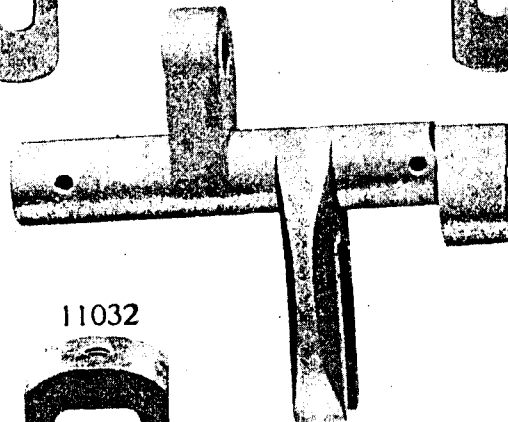


11048

9111



9113



11032

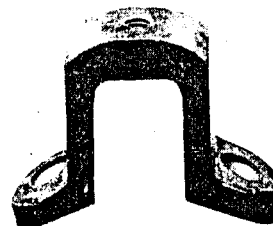
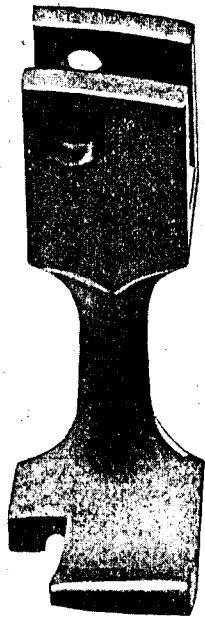
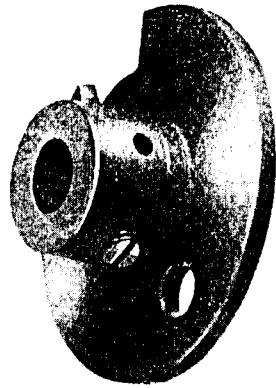


PLATE 7305—FULL SIZE

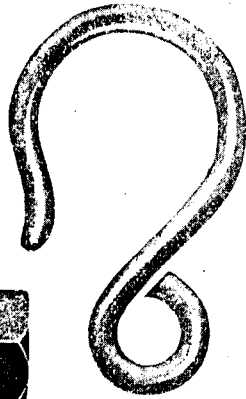
9195



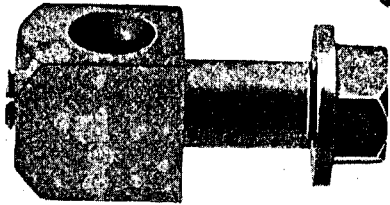
19609



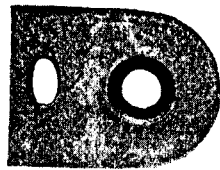
19625



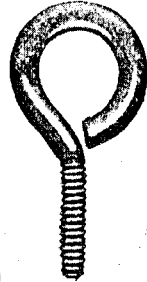
19682



64024



19624



64022



9165

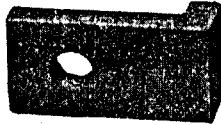


PLATE 7306—FULL SIZE

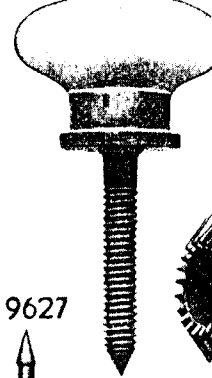
19606



19634



50201



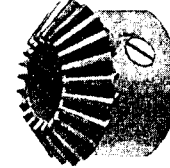
462



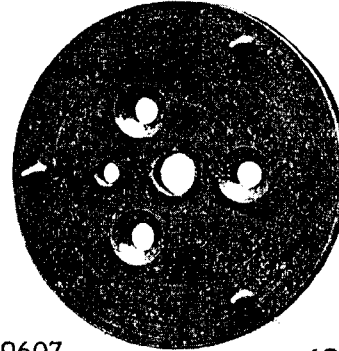
19627



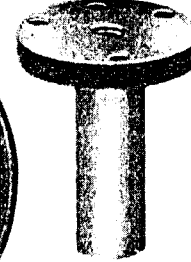
19611



9170



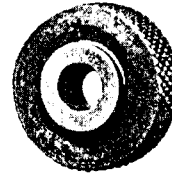
9168



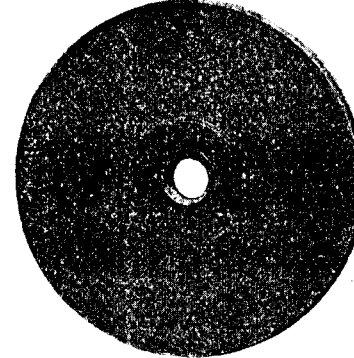
9199



19607



19628



19623

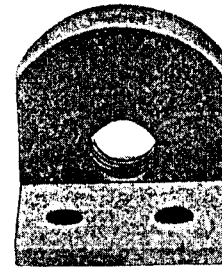


PLATE 7307—ONE-HALF SIZE

64023

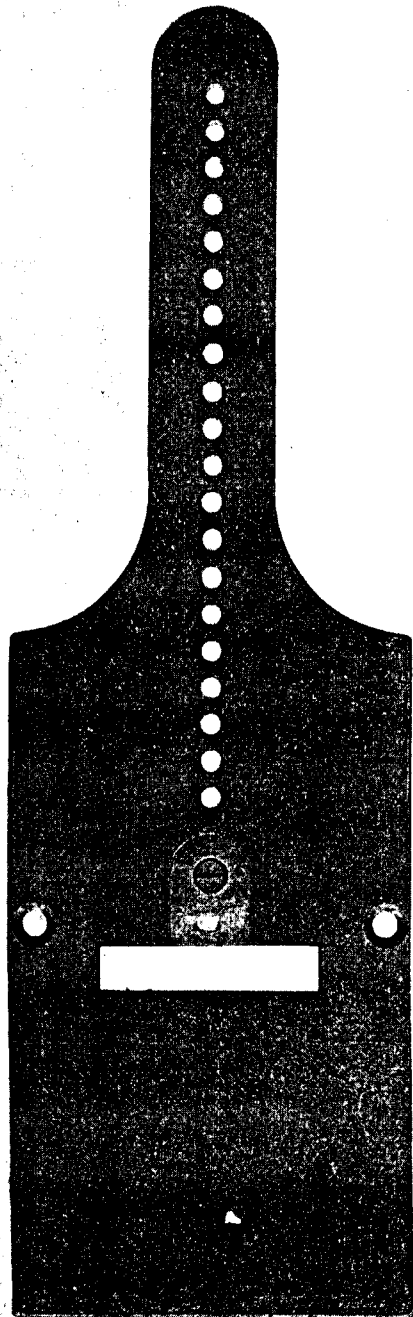


PLATE 7308—FULL SIZE

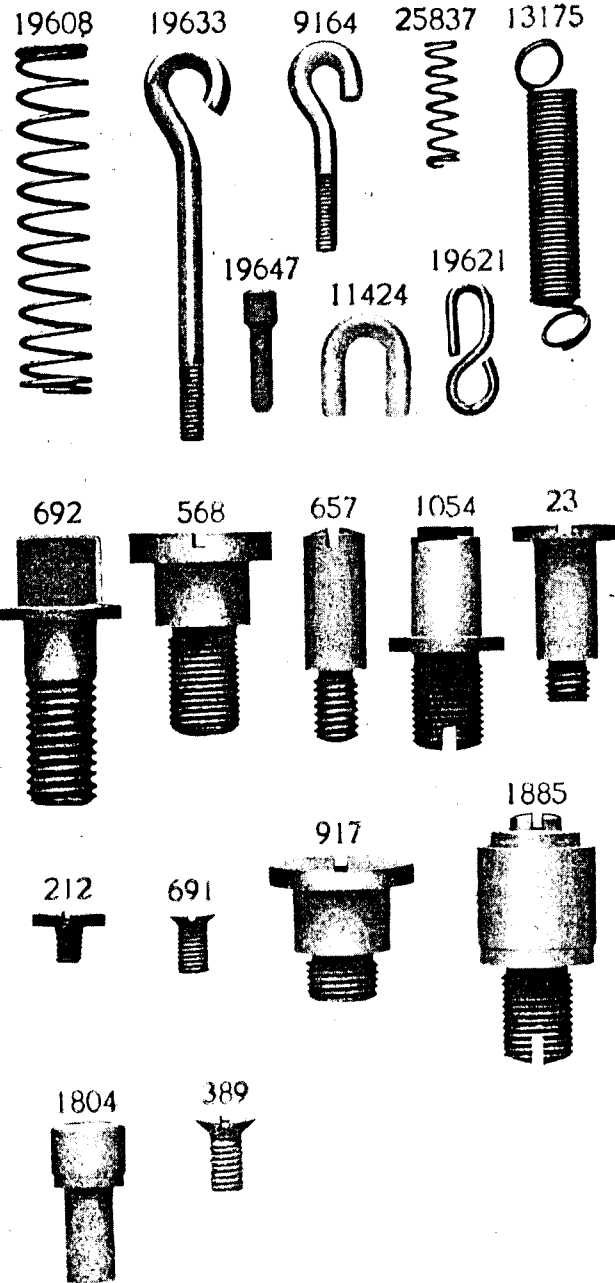


PLATE 7309—ONE-HALF SIZE

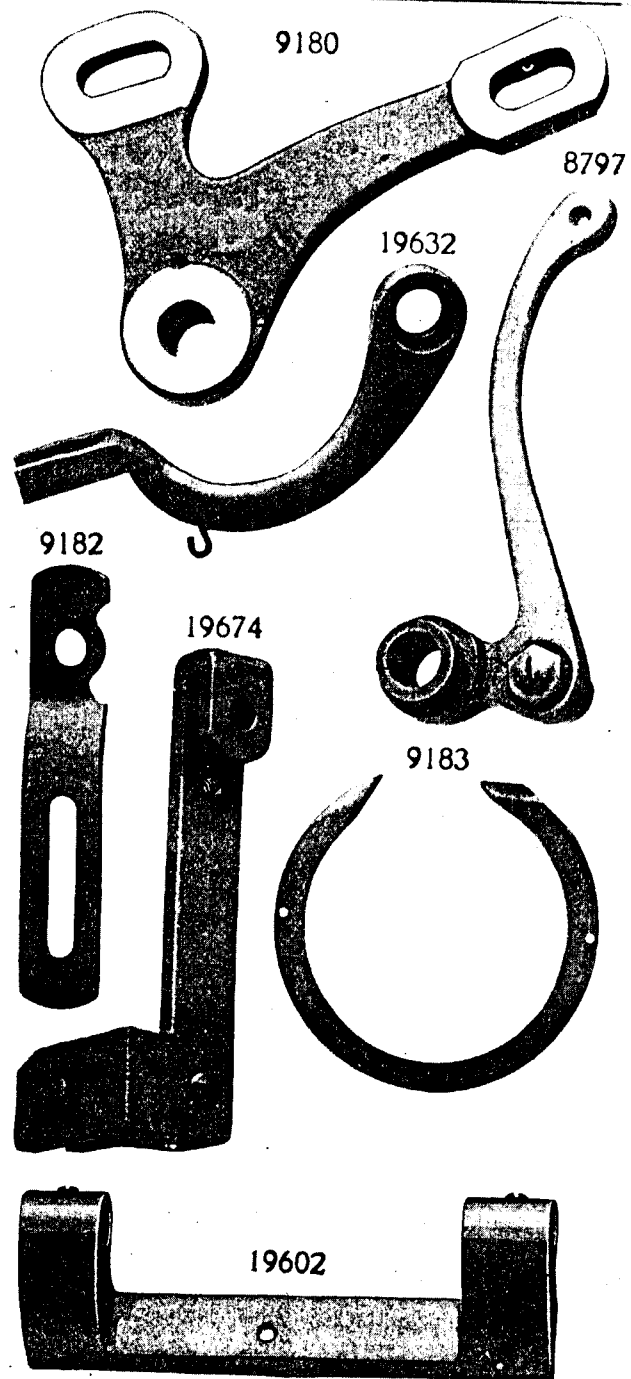


PLATE 7310—ONE-HALF SIZE

