

# PFAFF

## 242

Unterklassen-Ausstattung

Subclass parts

Composition des sous-classes

Composición de las subclases

## Erläuterungen Explanations

## Légende Explicaciones

Die Liste enthält nur Nähwerkzeuge sowie unterklassenabhängige Teile. Beim Umbau in eine andere Unterklasse bzw. Ausführung können auch noch Maschinenteile erforderlich sein. Geben Sie also bei Bestellungen die genaue Bezeichnung der vorhandenen bzw. der gewünschten Ausführung an.

The list contains only gauge parts and subclass-dependent parts. For a conversion into another subclass or version machine parts may be required as well. Please state the exact classification of the existing or required version on your order.

La liste comprend uniquement des organes de couture et des pièces dépendant des sous-classes. En cas de transformation en une autre sous-classe ou une autre version, il se peut que d'autres pièces de machine soient nécessaires. C'est pourquoi nous vous prions d'indiquer, à la commande, la désignation exacte de la version existante ou souhaitée.

La lista contiene solamente órganos de costura y piezas dependientes de la subclase. En el caso de transformación en otra subclase o en otro tipo, es posible que sean necesarias piezas de la máquina. Al hacer los pedidos, indíquese la denominación exacta del tipo existente o del deseado.

- 3/1** Gesichert mit Loctite.  
Secured with Loctite.  
Bloqué par Loctite.  
Asegurado con Loctite.
- 4** Ausführungsart bei Bestellung angeben.  
Model to be stated on order.  
Préciser le modèle à la commande.  
Indíquese el tipo en los pedidos.
- 5** Nähmuster bzw. Material einsenden.  
Submit sewing sample or material.  
Joindre échantillons de couture ou matières.  
Enviense muestras de costura.
- 10** Nadelabstand  
Needle gauge  
Ecartement des aiguilles  
Distancia entre agujas
- 10/1** Je nach Nadelabstand ändert sich die Form (z.B. beim Stoffschieber die Anzahl der Zahnreihen).  
Certain design features change according to the needle gauge (e.g. the number of tooth rows on the feed dog).  
La forme est fonction de l'écartement des aiguilles (par ex. le nombre des rangées de dents de la griffe).  
La forma varia de acuerdo con la distancia entre agujas (p.e. el número de hileras de dientes en el transportador).
- 10/2** Nadelabstand bei Bestellung angeben.  
Needle gauge to be stated on order.  
Ecartement des aiguilles; à préciser à la commande.  
Indíquese en los pedidos la distancia entre agujas.

**Erläuterungen**  
**Explanations**

**Légende**  
**Explicaciones**

**12** Absteppbreite  
Stitching margin  
Relarge de couture  
Margen de costura

**12/2** Absteppbreite bei Bestellung angeben.  
Stitching margin to be stated on order.  
Indiquer le relarge de couture à la commande.  
Indíquese el margen de costura en los pedidos.

**41/2** Nadeldiagonalabstand bei Bestellung angeben.  
Please state diagonal needle distance on order.  
Prière d'indiquer l'espacement diagonal des aiguilles à la commande.  
Indíquese en los pedidos la distancia diagonal entre agujas.

**60** Wahlweise  
Optional  
Au choix  
Opcional

**60/2** Wahlweise für Maschinen mit -900/..  
Optionally for machines with -900/..  
En option pour machines avec -900/..  
Opcionalmente para máquinas con -900/..

**97/1** Die sonstigen Nähwerkzeuge wie bei der Unterklasse -6/01.  
Other gauge parts as on subclass -6/01.  
Les autres organes de couture comme pour la sous-classe -6/01.  
Los demás órganos de costura como en la subclase -6/01.

- Mit -900/.. lieferbar (bis max. 8 mm Nadelabstand).  
Can be supplied with -900/.. (up to a needle gauge of 8 mm).  
Livvable avec -900/.. (jusqu'à écartement des aiguilles de 8 mm).  
Se puede suministrar con -900/.. (hasta distancias máx. entre agujas de 8 mm).
- Mit -900/.. lieferbar (bis max. Nadelabstand des angegebenen Bereichs, sofern dieser 44 mm nicht übersteigt).  
Can be supplied with -900/.. (up to the maximum needle gauge of the range indicated, provided this does not exceed 44 mm).  
Livvable avec -900/.. (jusqu'à écartement max. des aiguilles, sans que celui-ci puisse dépasser 44 mm).  
Se puede suministrar con -900/.. (hasta la distancia entre agujas máxima indicada como posible, siempre que ésta no pase de 44 mm).
- ▲ Stichplatte bei -900/...: 91-058 871-04.  
Needle plate for -900/...: 91-058 871-04.  
Plaque à aiguille pour -900/...: 91-058 871-04.  
Placa de aguja para -900/...: 91-058 871-04.

**Unterklassen-Übersicht**  
**Table of subclasses**

**Table des sous-classes**  
**Tabla de subclasses**

Unterklasse Subclass Sous-classe Subclase	-6/01 (-900/..) <sup>■</sup>	-6/03 (-900/..) <sup>■</sup>	-6/07	-19/01 (-900/..) <sup>■</sup>
Arbeitsgang Operation Opération Operación	Für allgemeine Näharbeiten. Standardform des Teilesatzes. For ordinary sewing operations. Standard parts set. Travaux d'utilité courante. Jeu de pièces standard. Para trabajos de costura en general. Juego de piezas estándar.	Wie -6/01, jedoch mit 2-teiligem Fuß. Same as -6/01, but with two-part foot.	Wie -6/01, jedoch mit verkleinerter Teilesatzform. Same as -6/01, but with small-size parts set.	
Ausführung Model Version Tipo de máquina	BN	BN	A; B	BN
Nadelabstand in mm Needle gauge in mm Ecartement des aiguilles en mm Distancia entre agujas en mm	1,2 - 2,2 2,4 - 3,2 4,0 - 5,6 6,0 - 34,0 36,0 38,0 - 72,0	4,0 - 72,0	3,2 - 8,0	4,0 - 10,0
Nadelhalter <sup>10/2</sup> Needle holder Pince-aiguille Portaagujas	91-118 195-93 x 3,2 <sup>41/2</sup> <sup>10</sup> = 1,2 - 2,2 mm 91-710 004-93 <sup>10</sup> = 2,4 - 3,2 mm 4,0 - 5,6 mm 6,0 - 34,0 mm 91-710 234-93 <sup>10</sup> = 36,0 mm 38,0 - 72,0 mm	<sup>97/1</sup>	91-710 004-93	91-710 004-93
Stoffschieber <sup>4</sup> <sup>10/2</sup> Feed dog Griffe Transportador inferior	91-040 340-04 <sup>10</sup> = 1,2 - 2,2 mm 91-046 714-04 <sup>10/1</sup> <sup>10</sup> = 2,4 - 3,2 mm 6,0 - 34,0 mm 36,0 mm 91-046 734-04 <sup>10</sup> = 4,0 - 5,6 mm 91-047 261-93 <sup>10/1</sup> <sup>10</sup> = 38,0 - 72,0 mm	<sup>97/1</sup>	91-045 492-04	91-046 734-04 <sup>10</sup> = 4,0 - 5,6 mm 91-046 714-04 <sup>10</sup> = 6,0 - 10,0 mm
Stichplatte <sup>4</sup> <sup>10/2</sup> Needle plate Plaque à aiguille Placa de aguja	91-040 341-04 ▲ <sup>10</sup> = 1,2 - 2,2 mm 91-046 715-04 <sup>10/1</sup> ▲ <sup>10</sup> = 2,4 - 3,2 mm 6,0 - 34,0 mm 36,0 mm 38,0 - 72,0 mm 91-046 735-04 ▲ <sup>10</sup> = 4,0 - 5,6 mm	<sup>97/1</sup> ▲	91-045 493-04	91-046 735-04 ▲ <sup>10</sup> = 4,0 - 5,6 mm 91-046 715-04 ▲ <sup>10</sup> = 6,0 - 10,0 mm
Nähfuß <sup>4</sup> <sup>10/2</sup> Presser foot Pied presseur Pie prensatelas	91-051 642-03 <sup>10</sup> = 1,2 - 2,2 mm 91-040 811-03 <sup>10</sup> = 2,4 - 3,2 mm 4,0 - 5,6 mm 6,0 - 34,0 mm 36,0 mm 38,0 - 72,0 mm	91-046 895-93 <sup>10</sup> = 4,0 - 11,2 mm 91-046 900-93 <sup>10</sup> = 12,0 - 22,0 mm 91-046 905-93 <sup>10</sup> = 24,0 - 66,8 mm 91-046 875-93 <sup>10</sup> = 68,0 - 72,0 mm	91-040 811-03	91-040 811-03
Apparat <sup>5</sup> <sup>10/2</sup> Attachment Appareil Aparato				91-044 079-23
Träger Bracket Support Soporte				91-040 528-90
Fingerschutz <sup>10/2</sup> Finger guard Protège-doigts Salvadedos	91-046 864-25 <sup>10</sup> = 1,2 - 2,2 mm			





**Unterklassen-Übersicht**  
**Table of subclasses**

**Table des sous-classes**  
**Tabla de subclasses**

Unterklasse Subclass Sous-classe Subclase	-57/01 (-900/..) <sup>■</sup>	-58/01 (-900/..) <sup>■</sup>	-61/01 (900/..) <sup>■</sup>	-61/02 (-900/..) <sup>■</sup>	-63/03 (-900/..) <sup>■</sup>	-69/01 (-900/..) <sup>■</sup>
Arbeitsgang Operation Opération Operación						
Ausführung Model Version Tipo de máquina	BN	BN	BN	BN	BN	BN
Nadelabstand in mm Needle gauge in mm Ecartement des aiguilles en mm Distancia entre agujas en mm	4,0 - 20,0	4,0 - 20,0	2,4 - 24,0	6,0 - 72,0	2,4 - 24,0	2,4 - 20,0
Nadelhalter <sup>10/2</sup> Needle holder Pince-aiguille Portaagujas	[97/1]	[97/1]	[97/1]	[97/1]	[97/1]	[97/1]
Stoffschieber <sup>4</sup> <sup>10/2</sup> Feed dog Griffe Transportador inferior	[97/1]	[97/1]	[97/1]	[97/1]	[97/1]	[97/1]
Stichplatte <sup>4</sup> <sup>10/2</sup> Needle plate Plaque à aiguille Placa de aguja	[97/1] ▲	[97/1] ▲	[97/1] ▲	[97/1] ▲	[97/1] ▲	[97/1] ▲
Nähfuß <sup>4</sup> <sup>10/2</sup> Presser foot Pied presseur Pie prensatejas	91-040 811-03	91-040 811-03	91-026-578-03 <sup>5</sup>	91-040 811-03	91-040 845-03	91-026 758-03 <sup>5</sup>
Apparat <sup>5</sup> <sup>10/2</sup> Attachment Appareil Aparato	91-040 317-93 <sup>10</sup> = 4,0 - 10,0 mm	91-040 316-93 <sup>10</sup> = 4,0 - 10,0 mm			91-042 359- <del>2</del>	
Träger Bracket Support Soporte				91-040 862-90		
Kopfplatte Face plate Plaque frontale Placa frontal				91-140 383-71/993		
Bandtrommel Tape reel Tambour-dérouleur Tambor portacintas			91-040 207-70/995	91-040 207-70/995	91-041 644-70/995	91-040 207-70/995
Bandführung Tape guide Guide-ruban Guiacintas				91-043 408-23 <sup>5</sup> <sup>10/2</sup>	91-044 419-25	
Fingerschutz <sup>10/2</sup> Finger guard Protège-doigts Salvadedos			91-055 261-91 <sup>10</sup> = 2,4 - 8,0 mm 91-055 259-91 <sup>10</sup> = 9,2 - 24,0 mm			91-055 261-91 <sup>10</sup> = 2,4 - 8,0 mm 91-055 259-91 <sup>10</sup> = 9,2 - 20,0 mm

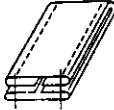
Unterklassen-Übersicht  
Table of subclasses

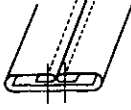
Table des sous-classes  
Tabla de subclasses

Unterklasse Subclass Sous-classe Subclase	-89/11 (-900/..) <sup>■</sup>	-113/01 (-900/..) <sup>■</sup>	-189/02 (900/..) <sup>■</sup>	-720/02-6/01	-720/02-6/01 (-900/..) <sup>●</sup>
Arbeitsgang Operation Opération Operación					
Ausführung Model Version Tipo de máquina	BN	BN	BN	A	AN; BN
Nadelabstand in mm Needle gauge in mm Ecartement des aiguilles en mm Distancia entre agujas en mm	14,0 - 20,0	4,8 - 10,0	2,4 - 3,2	1,6 - 2,4	2,0 - 2,8
Nadelhalter <sup>10/2</sup> Needle holder Pince-aiguille Portaagujas	<sup>97/1</sup>	<sup>97/1</sup>	91-710 004-93	91-018 165-13	91-018 165-13
Stoffschieber <sup>4</sup> <sup>10/2</sup> Feed dog Griffe Transportador inferior	<sup>97/1</sup>	<sup>97/1</sup>	91-046 714-04	91-046 714-04 <sup>10</sup> = 1,6 - 2,4 mm	91-046 714-04 <sup>10</sup> = 2,0 - 2,8 mm 91-059 456-04 <sup>60/2</sup> <sup>10</sup> = 2,4; 2,8 mm
Stichplatte <sup>4</sup> <sup>10/2</sup> Needle plate Plaque à aiguille Placa de aguja	<sup>97/1</sup> ▲	<sup>97/1</sup> ▲	91-046 715-04 ▲	91-046 715-04	91-046 715-04 ▲
Nähfuß <sup>4</sup> <sup>10/2</sup> Presser foot Pied presseur Pie prensateelas	91-489 707-03	91-026 804-03 91-026 805-03	91-051 080-03	91-040 811-03	91-040 811-03
Apparat <sup>5</sup> <sup>10/2</sup> Attachment Appareil Aparato	91-491 284-23		91-053 065-23		
Träger Bracket Support Soporte			91-040 528-90		
Bandtrommel Tape reel Tambour-dérouleur Tambor portacintas			91-042 742-71/995		
Bandführung Tape guide Guide-ruban Guiacintas			91-044 419-25		
Fingerschutz <sup>10/2</sup> Finger guard Protège-doigts Salvadedos	91-046 868-25 <sup>10</sup> = 14,0 - 20,0 mm	91-046 864-25 <sup>10</sup> = 4,8 - 6,8 mm 91-046 866-25 <sup>10</sup> = 7,2 - 10,0 mm	91-046 864-25 <sup>10</sup> = 2,4 - 3,2 mm		
Lineal Edge guide Guide-droit Guía recta	91-489 708-21 91-489 709-21				

**Unterklassen-Übersicht**  
Table of subclasses

**Table des sous-classes**  
Tabla de subclasses

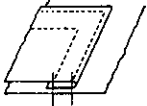
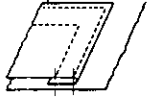
Unterklasse Subclass Sous-classe Subclase	-720/02-6/01 (-900/..)*	-720/02-6/07	-720/02-113/01 (-900/..)*	-720/02-113/02 (-900/..)*
Arbeitsgang Operation Opération Operación		Wie -720/02-6/01; jedoch verkleinerte Form des Teilesatzes. Same as -720/02-6/01, but with small-size parts set. Comme la -720/02-6/01, mais jeu de pièces aux dimensions réduites. Como la -720/02-6/01, pero con juego de piezas reducido.		
Ausführung Model Version Tipo de máquina	AN; BN	A; B	AN; BN	A; B
Nadelabstand in mm Needle gauge in mm Ecartement des aiguilles en mm Distancia entre agujas en mm	3,2 - 30,0	4,0 - 8,0	4,0 - 10,0	4,8 - 10,0
Nadelhalter <sup>10/2</sup> Needle holder Pince-aiguille Portaagujas	91-018 166-13	91-018 166-13	91-018 166-13	91-018 166-13
Stoffschieber <sup>4</sup> <sup>10/2</sup> Feed dog Griffe Transportador interior	<sup>97/1</sup>	91-045 492-04	<sup>97/1</sup>	<sup>97/1</sup>
Stichplatte <sup>4</sup> <sup>10/2</sup> Needle plate Plaque à aiguille Placa de aguja	<sup>97/1</sup> ▲	91-045 493-04	<sup>97/1</sup> ▲	<sup>97/1</sup> ▲
Nähfuß <sup>4</sup> <sup>10/2</sup> <sup>12/2</sup> Presser foot Pied presseur Pie prensateelas	91-040 811-03	91-040 811-03	91-026 804-03 91-026 805-03	91-155 502-03 <sup>60</sup> <sup>12</sup> = 1,0; 1,5 mm 91-155 505-03 <sup>60</sup> <sup>12</sup> = 2,0; 2,5; 3,0; 3,5 mm
Fingerschutz <sup>10/2</sup> Finger guard Protège-doigts Salvabedós			91-046 864-25 <sup>10</sup> = 4,0 - 6,8 mm 91-046 866-25 <sup>10</sup> = 7,2 - 10,0 mm	

**Nähwerkzeuge  
Gauge parts**

**Organes de couture  
Organos de costura**

91-018 165-13 <sup>10/2</sup>

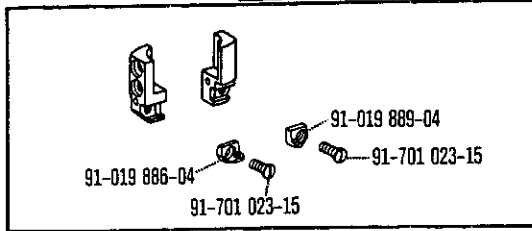

91-019 886-04  
91-701 023-15  
91-019 889-04  
91-701 023-15

-720/02-6/01 (-900/..)

91-018 166-13 <sup>10/2</sup>

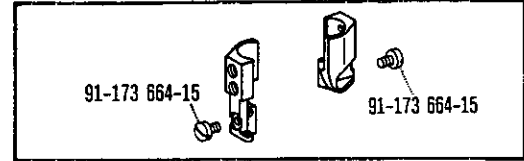

91-173 664-15  
91-173 664-15

-720/02-6/01 (-900/..)  
-720/02-6/07  
-720/02-113/01 (-900/..)  
-720/02-113/02 (-900/..)

91-118 195-93 x 3,2 <sup>10/2</sup> <sup>41/2</sup>

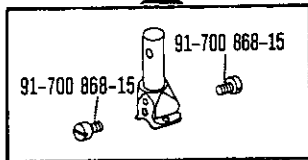

91-700 868-15  
91-700 868-15

-6/01 (-900/..)

91-710 004-93 <sup>10/2</sup>

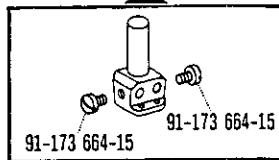

91-173 664-15  
91-173 664-15

-6/01 (-900/..)  
-6/03 (-900/..)  
-6/07  
-19/01 (-900/..)  
-57/01 (-900/..)  
-58/01 (-900/..)  
-61/01 (-900/..)  
-61/02 (-900/..)  
-63/03 (-900/..)  
-69/01 (-900/..)  
-89/11 (-900/..)  
-113/01 (-900/..)  
-189/02 (-900/..)

91-710 234-93 <sup>10/2</sup>

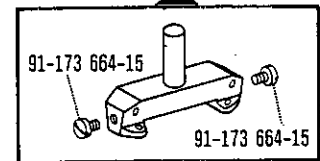

91-173 664-15  
91-173 664-15

-6/01 (-900/..)  
-6/03 (-900/..)  
-61/02 (-900/..)

91-040 340-04 <sup>4</sup> <sup>10/2</sup>

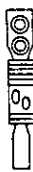

-6/01 (-900/..)

91-045 492-04 <sup>4</sup> <sup>10/2</sup>



-6/07  
-720/02-6/07

91-046 714-04 <sup>4</sup> <sup>10/2</sup>

<sup>10</sup> = 1,5 - 3,2 mm



-6/01 (-900/..)  
-61/01 (-900/..)  
-63/03 (-900/..)  
-69/01 (-900/..)  
-189/02 (-900/..)  
-720/02-6/01 (-900/..)

91-046 714-04 <sup>4</sup> <sup>10/1</sup> <sup>10/2</sup>

<sup>10</sup> = 6,0 - 36,0 mm



-6/01 (-900/..)  
-6/03 (-900/..)  
-19/01 (-900/..)  
-57/01 (-900/..)  
-58/01 (-900/..)  
-61/01 (-900/..)  
-61/02 (-900/..)  
-63/03 (-900/..)  
-69/01 (-900/..)  
-89/11 (-900/..)  
-113/01 (-900/..)  
-720/02-6/01 (-900/..)  
-720/02-113/01 (-900/..)  
-720/02-113/02 (-900/..)

91-046 734-04 <sup>4</sup> <sup>10/2</sup>



-6/01 (-900/..)  
-6/03 (-900/..)  
-19/01 (-900/..)  
-57/01 (-900/..)  
-58/01 (-900/..)  
-61/01 (-900/..)  
-63/03 (-900/..)  
-69/01 (-900/..)  
-113/01 (-900/..)  
-720/02-6/01 (-900/..)  
-720/02-113/01 (-900/..)  
-720/02-113/02 (-900/..)

91-047 261-93 <sup>4</sup> <sup>10/1</sup> <sup>10/2</sup>

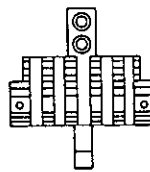

-6/01 (-900/..)  
-6/03 (-900/..)  
-61/02 (-900/..)

91-059 456-04 <sup>4</sup> <sup>10/2</sup>

<sup>10</sup> = 2,4 mm; 2,8 mm















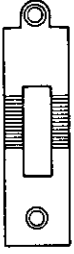



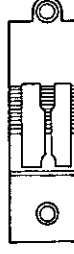















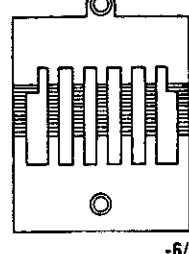



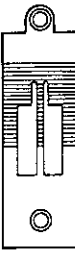







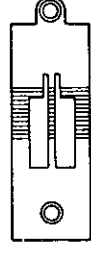



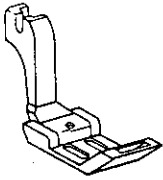





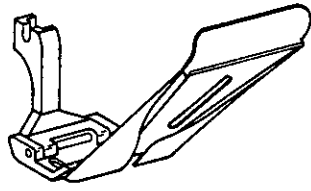



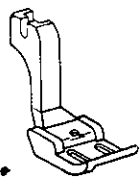



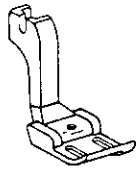



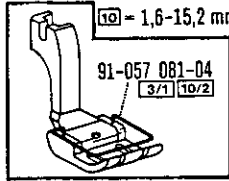





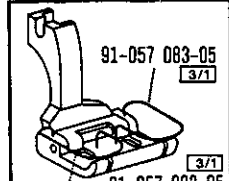







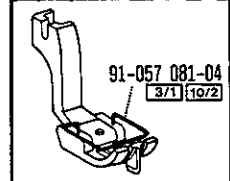







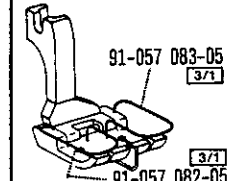







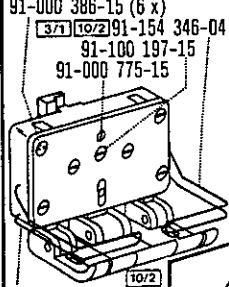





















-720/02-6/01-900/..





Nähwerkzeuge  
Gauge parts

Organes de couture  
Organos de costura

<p>91-040 341-04    </p>  <p>-6/01</p>	<p>91-045 493-04   </p>  <p>-6/07 -720/02-6/07</p>	<p>91-046 715-04    </p> <p><math>\overline{10}</math> = 1,6 - 3,2 mm</p>  <p>-6/01 -61/01 -63/03 -69/01 -189/02 -720/02-6/01</p>	<p>91-046 715-04     </p> <p><math>\overline{10}</math> = 6,0 - 38,0 mm</p>  <p>-6/01 -6/03 -19/01 -57/01 -58/01 -61/01 -61/02 -63/03 -69/01 -89/11 -113/01 -720/02-6/01 -720/02-113/01 -720/02-113/02</p>	<p>91-046 715-04     </p> <p><math>\overline{10}</math> = 38,0 - 72,0 mm</p>  <p>-6/01 -6/03 -61/02</p>
<p>91-046 735-04   </p>  <p>-6/01 -6/03 -19/01 -57/01 -58/01 -61/01 -63/03 -69/01 -113/01 -720/02-6/01 -720/02-113/01 -720/02-113/02</p>	<p>91-058 871-04   </p> <p><math>\overline{10}</math> = 1,2 - 3,2 mm</p>  <p>-6/01-900/.. -61/01-900/.. -63/03-900/.. -69/01-900/.. -189/02-900/.. -720/02-6/01-900/..</p>	<p>91-058 871-04    </p> <p><math>\overline{10}</math> = 4,0 - 44,0 mm</p>  <p>-6/01-900/.. -6/03-900/.. -19/01-900/.. -57/01-900/.. -58/01-900/.. -61/01-900/.. -61/02-900/.. -63/03-900/.. -69/01-900/.. -89/11-900/.. -113/01-900/.. -720/02-6/01-900/.. -720/02-113/01-900/.. -720/02-113/02-900/..</p>		
<p>91-026 578-03    </p>  <p>-61/01 (-900/..)</p>	<p>91-026 758-03     </p>  <p>-69/01 (-900/..)</p>	<p>91-026 804-03    </p>  <p>-113/01(-900/..) -720/02-113/01 (-900/..)</p>	<p>91-026 805-03    </p>  <p>-113/01(-900/..) -720/02-113/01 (-900/..)</p>	
<p>91-040 811-03   </p>  <p><math>\overline{10}</math> = 1,6 - 15,2 mm</p> <p>91-057 081-04   </p> <p>-6/01 (-900/..) -6/07 -19/01 (-900/..) -57/01 (-900/..) -58/01 (-900/..) -61/02 (-900/..) -720/02-6/01 (-900/..) -720/02-6/07</p>	<p>91-040 811-03   </p>  <p>91-057 083-05  </p> <p>91-057 082-05  </p> <p><math>\overline{10}</math> = 15,6 - 72,0 mm</p> <p>-6/01 (-900/..) -57/01 (-900/..) -58/01 (-900/..) -61/02 (-900/..) -720/02-6/01 (-900/..)</p>	<p>91-040 845-03   </p>  <p>91-057 081-04   </p> <p><math>\overline{10}</math> = 2,4 - 15,2 mm</p> <p>-63/03 (-900/..)</p>	<p>91-040 845-03    </p>  <p>91-057 083-05  </p> <p>91-057 082-05  </p> <p><math>\overline{10}</math> = 15,6 - 24,0 mm</p> <p>-63/03 (-900/..)</p>	<p>91-046 875-93   </p>  <p>91-000 386-15 (6 x)      </p> <p>91-154 346-04      </p> <p>91-100 197-15      </p> <p>91-000 775-15      </p> <p>91-154 345-04      </p> <p>-6/03 (-900/..)</p>

**Nähwerkzeuge  
Gauge parts**

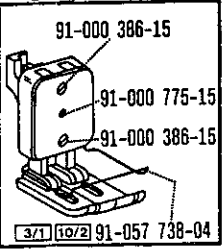
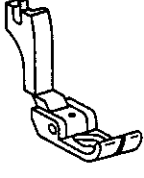
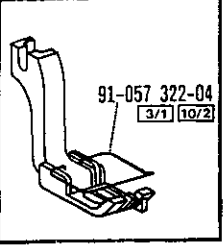
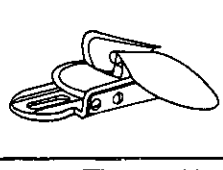
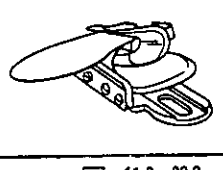
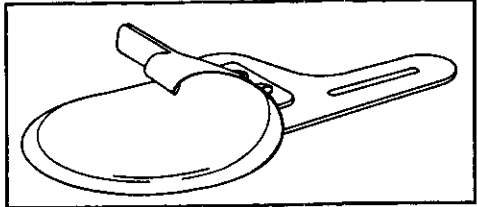
**Organes de couture  
Organos de costura**

<p>91-046 895-93 [4] [10/2]</p>  <p>91-000 386-15 91-000 775-15 91-000 386-15 91-057 738-04 [3/1] [10/2]</p> <p>-6/03 (-900/..)</p>	<p>91-046 900-93 [4] [10/2]</p>  <p>91-000 386-15 91-000 775-15 91-000 386-15 91-057 738-04 [3/1] [10/2]</p> <p>-6/03 (-900/..)</p>	<p>91-046 905-93 [4] [10/2]</p>  <p>91-000 775-15 91-000 386-15 (4 x) 91-057 740-05 [3/1] 91-057 739-05 [3/1]</p> <p>-6/03 (-900/..)</p>	<p>91-051 080-03 [4] [10/2]</p>  <p>-189/02 (-900/..)</p>	<p>91-051 642-03 [4] [10/2]</p>  <p>-6/01 (-900/..)</p>
<p>91-155 502-03 [4] [10/2] [12/2]</p>  <p>91-057 322-04 [3/1] [10/2]</p> <p>-720/02-113/02 (-900/..)</p>	<p>91-155 505-03 [4] [10/2] [12/2]</p>  <p>91-057 322-04 [3/1] [10/2]</p> <p>-720/02-113/02 (-900/..)</p>	<p>91-489 707-03 [4] [10/2]</p>  <p>-89/11 (-900/..)</p>		
<p>91-000 521-25 [5] [10/2]</p>  <p>91-040 316-93 [5] [10/2]</p> <p>[10] = 4,0 - 10,0 mm</p> <p>-58/01 (-900/..)</p>	<p>91-000 521-25 [5] [10/2]</p>  <p>91-040 317-93 [5] [10/2]</p> <p>[10] = 4,0 - 10,0 mm</p> <p>-57/01 (-900/..)</p>	<p>91-000 521-25 [5] [10/2]</p>  <p>91-040 814-24 [5] [10/2]</p> <p>[10] = 11,2 - 20,0 mm</p> <p>-58/01 (-900/..)</p>	<p>91-000 521-25 [5] [10/2]</p>  <p>91-042 068-24 [5] [10/2]</p> <p>[10] = 11,2 - 20,0 mm</p> <p>-57/01 (-900/..)</p>	<p>91-000 521-25 (2 x) [5] [10/2]</p>  <p>91-042 369-21 [5] [10/2]</p> <p>-63/03 (-900/..)</p>
<p>91-000 521-25 [5] [10/2]</p>  <p>91-044 079-23 [5] [10/2]</p> <p>-19/01 (-900/..)</p>	 <p>[5] [10/2] 91-053 065-23</p>		<p>91-000 521-25 [5] [10/2]</p>  <p>-189/02 (-900/..)</p>	

**Nähwerkzeuge**  
Gauge parts

**Organes de couture**  
Organos de costura

91-491 284-23 5 10/2

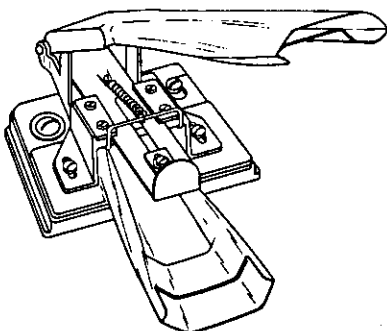

-89/11 (-900/..)

91-043 408-23 5 10/2

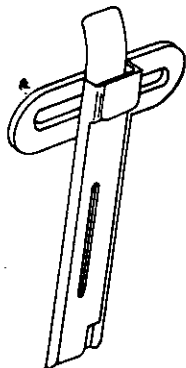

-61/02 (-900/..)

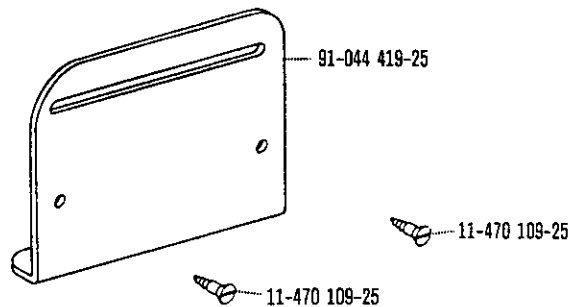

-63/03 (-900/..)  
-189/02 (-900/..)

91-040 528-90

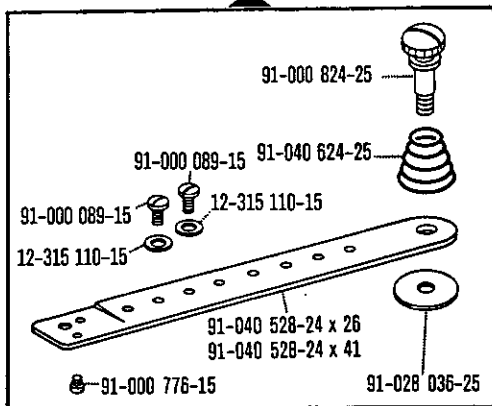

-19/01 (-900/..)  
-189/02 (-900/..)

91-040 862-90

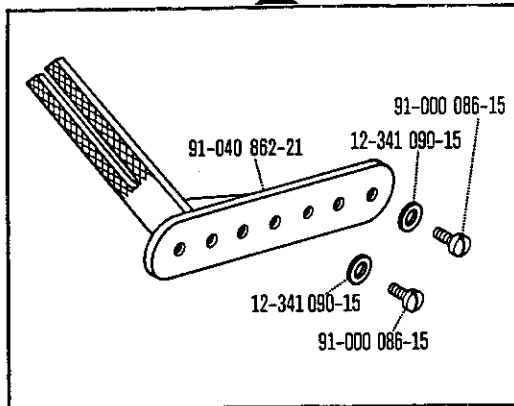

-61/02 (-900/..)

**Nähwerkzeuge  
Gauge parts**

**Organes de couture  
Organos de costura**

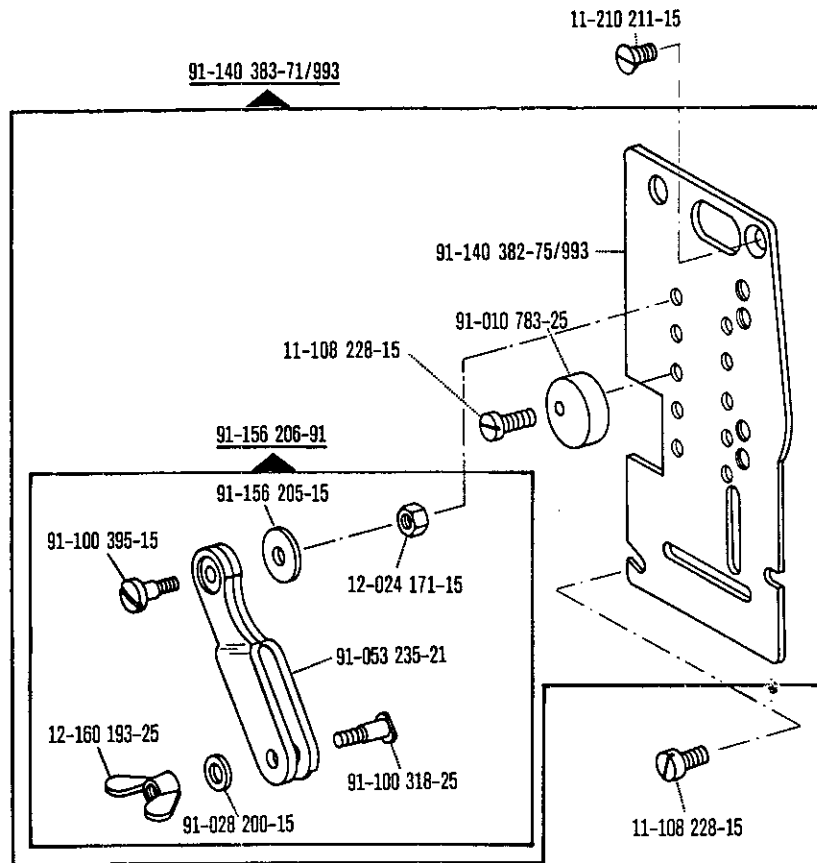

-61/02 (-900/..)

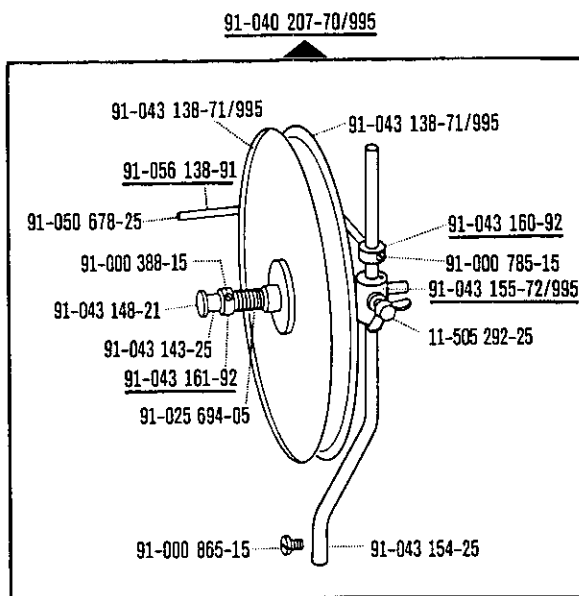

-61/01 (-900/..)  
-61/02 (-900/..)  
-69/01 (-900/..)

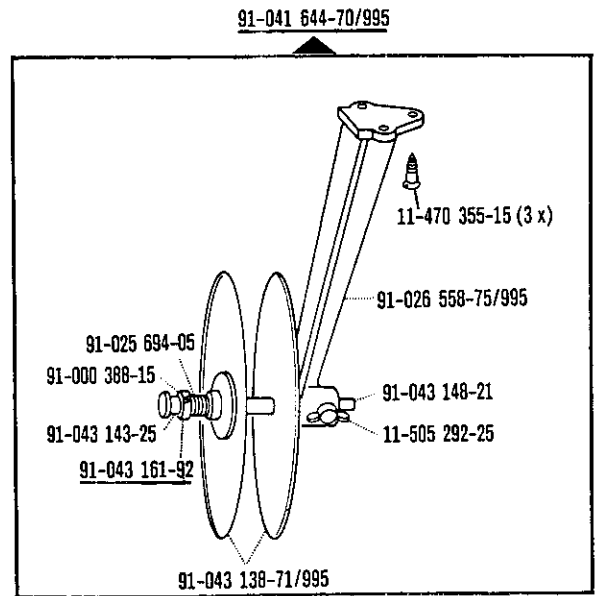

-63/03 (-900/..)

Nähwerkzeuge  
Gauge parts

Organes de couture  
Organos de costura

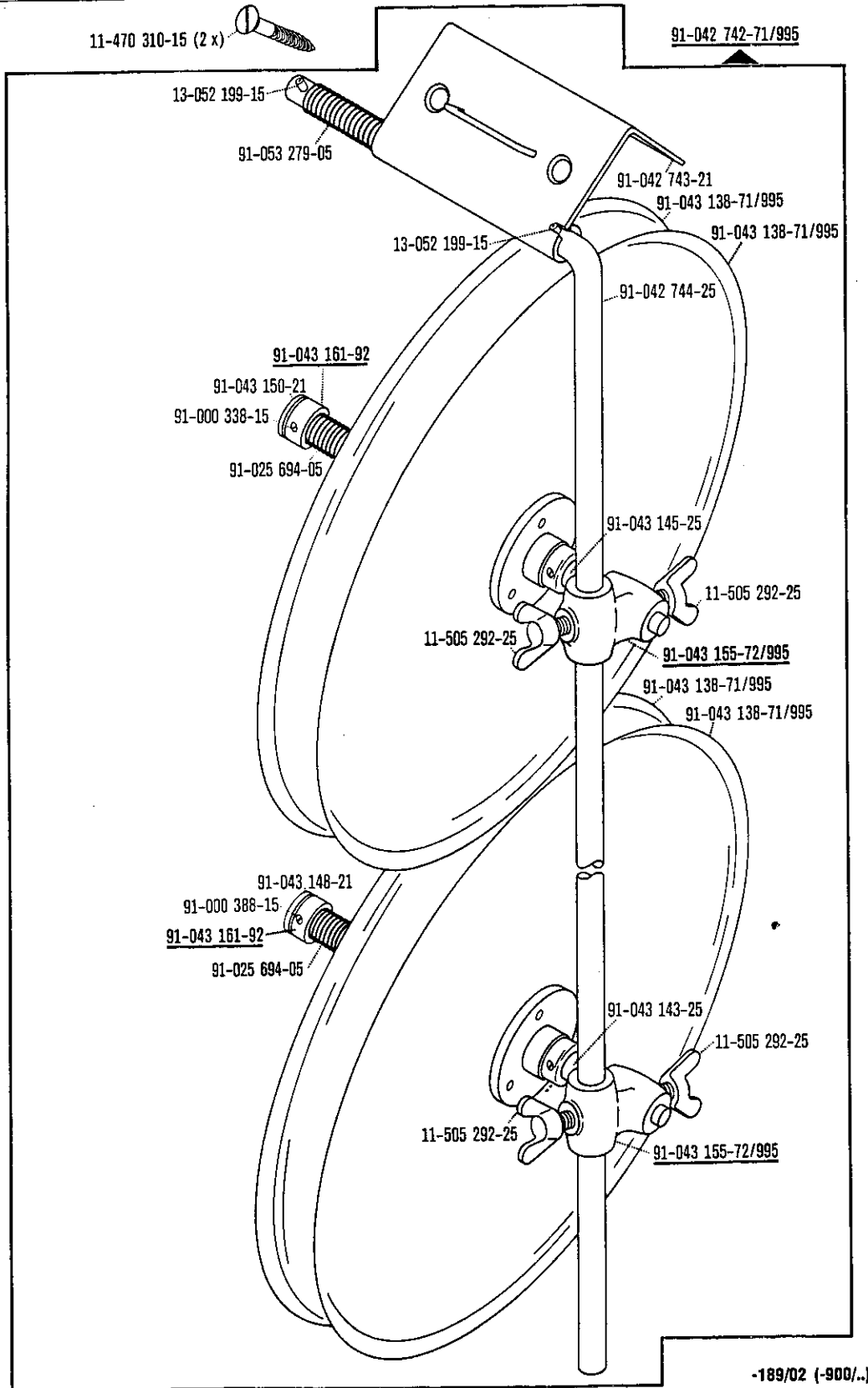

**Nähwerkzeuge**  
Gauge parts

**Organes de couture**  
Organos de costura

91-046 864-25  $\frac{10}{2}$   
 $\frac{10}{2}$  = 1,2 - 6,8 mm

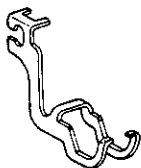

-6/01 (-900/..)  
-113/01 (-900/..)  
-189/02 (-900/..)  
-720/02-113/01 (-900/..)

91-046 866-25  $\frac{10}{2}$   
 $\frac{10}{2}$  = 7,2 - 10,0 mm

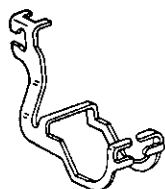

-113/01 (-900/..)  
-720/02-113/01 (-900/..)

91-046 868-25  $\frac{10}{2}$   
 $\frac{10}{2}$  = 14,0 - 20,0 mm

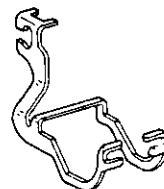

-89/11 (-900/..)

91-055 259-91  $\frac{10}{2}$   
 $\frac{10}{2}$  = 9,2 - 24,0 mm

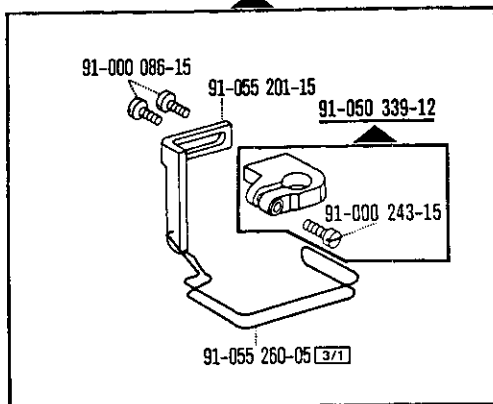

-61/01 (-900/..)  
-69/01 (-900/..)

91-055 261-91  $\frac{10}{2}$   
 $\frac{10}{2}$  = 2,4 - 8,0 mm

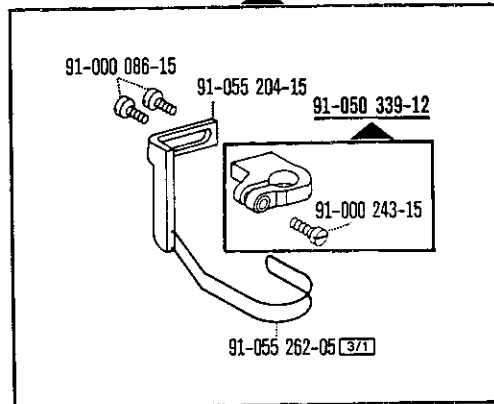

-61/01 (-900/..)  
-69/01 (-900/..)

91-489 708-21

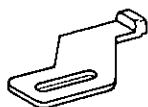

-89/11 (-900/..)

91-489 709-21

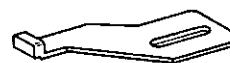

-89/11 (-900/..)