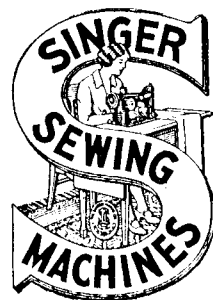


Form 18686  
September, 1933  
PRINTED IN U. S. A.

# LIST OF PARTS



**MACHINE No. 105-20**

---

**THE SINGER MANUFACTURING COMPANY**

COPYRIGHT, U. S. A., 1932 AND 1933,  
BY THE SINGER MANUFACTURING CO.  
ALL RIGHTS RESERVED FOR ALL COUNTRIES

## INSTRUCTIONS FOR OILING

---

Before starting the machine apply Singer Cloth and Leather Oil to all oil holes and bearings. Particular care should be taken to see that a sufficient quantity of oil is poured into the oil hole leading to the oil reservoir at the back of the machine. The main bearings of the machine are lubricated by means of this oil reservoir which should be kept filled with oil. When the machine is in continuous use, it should be oiled frequently.

Genuine Singer Needles should be used  
in Singer Machines.  
These Needles and their Containers  
are marked with the  
Company's Trade Mark "SIMANCO." 1

Needles in Containers marked  
"For Singer Machines"  
are not Singer made needles. 2

# INDEX

---

	PAGE
ACCESSORIES.....	14
EDGE FOLDER.....	14
KNEE LIFTER PARTS.....	14
MACHINE BASE.....	15
MACHINE NO. 105-20.....	7
NUMERICAL LIST OF PARTS.....	17
THREAD UNWINDER.....	15

## INSTRUCTIONS FOR ORDERING

In ordering from this list, use **ONLY** the part **NUMBER** in the **FIRST** column.

The number stamped on a Sewing Machine Part is in every case the number of the single part only.

Every combination of parts sent out as such has its specific number, which, although not stamped on the parts, must be used when ordering the combination.

Each number always indicates the **SAME PART** in whatever list it appears, or for whatever machine.

The letters after some of the numbers indicate the style of finish only, as follows:

- A—Hardened, Polished, Nickel Plated and Buffed
- B—Polished, Nickel Plated and Buffed
- C—Hardened Only
- D—Polished Only
- E—Soft, Not Polished
- F—Hardened and Polished
- H—Blued
- J—Nickel Plated Only
- K—Hardened and Nickel Plated
- L—Brass Plated
- M—Oxidized
- N—Japanned, Dull
- P—Japanned, Bright
- R—Merlized
- T—Copper Plated
- T. A.—Hardened, Polished, Copper and Nickel Plated and Buffed
- T. B.—Copper and Nickel Plated and Polished
- T. J.—Copper and Nickel Plated Only
- T. K.—Hardened, Copper and Nickel Plated
- T. M.—Copper Plated and Oxidized
- T. L.—Copper and Brass Plated
- U—Zinc Plated
- V—Silver Plated
- W—Polished and Nickel Plated
- Y—Black Nickel Plated Only
- Z—Chromium Plated
- Z. B.—Polished, Nickel Plated, Buffed and Chromium Plated
- Z. J.—Nickel and Chromium Plated

These letters **MUST BE USED** when they appear in the list; and **AFTER** the number **as** in the list.

In this series:

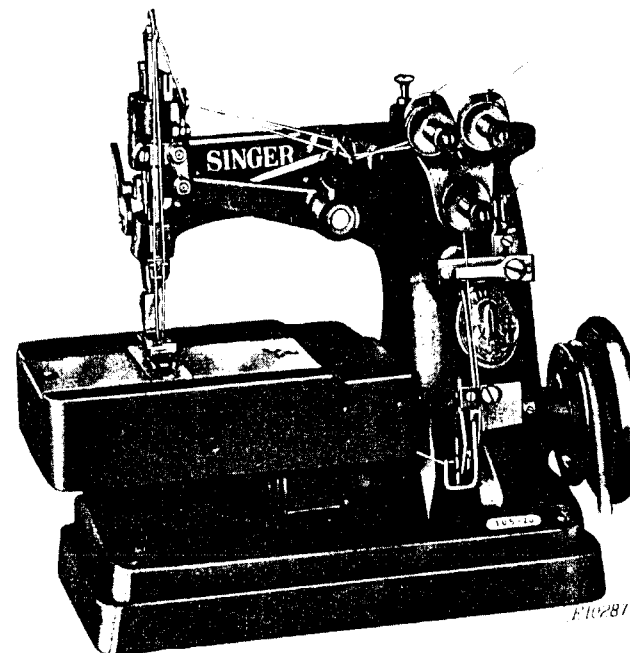
- 1 to 1500 and 50001 to 51500 are Screw Numbers
- 1501 to 1800 and 51501 to 51800 are Nut Numbers
- 1801 to 2000 and 51801 to 52000 are Roller Numbers
- 2001 to 50000 and 52001 and upward are numbers of Machine Parts

The figures in the second column refer only to the plates, illustrating the parts, and are **NOT TO BE USED** in ordering.

Parts marked with an asterisk (\*) are furnished only when repairs are made at factory.

When ordering parts which differ as to **Gauge** (the distance between seams) the Gauge, as well as the **Number must be given** on order.

## LIST OF PARTS COMPLETE FOR



## MACHINE No. 105-20

FOR HEMMING SILK GLOVES AND SIMILAR WORK IN LIGHT MATERIAL. TWO NEEDLES, ONE LOOPER. GAUGES  $\frac{3}{64}$  AND  $\frac{1}{8}$  INCH. BALANCE WHEEL No. 59208. DIAMETER OF BELT GROOVE  $2\frac{3}{16}$  INCHES. SPEED 3500.

NO.	PLATE	NAME
*59399	---	Arm, upper and lower (solid) with 15404 and two 15405.....
59491	7365	Arm Rotary Shaft.....
59523	7355	" " " Bushing (back) with 52045.....
52045	7355	Arm Rotary Shaft Bushing (back) Packing (cotton).....
1285c	7364	Arm Rotary Shaft Bushing (back) Set Screw.....

NO.	PLATE	NAME
59524	7355	Arm Rotary Shaft Bushing (front) with 52045.....
52045	7355	Arm Rotary Shaft Bushing (front) Packing (cotton).....
448c	7364	Arm Rotary Shaft Bushing (front) Set Screw.....
59525	7355	Arm Rotary Shaft Bushing (intermediate) with 52045.....
52045	7355	Arm Rotary Shaft Bushing (intermediate) Packing (cotton).....
1285c	7364	Arm Rotary Shaft Bushing (intermediate) Set Screw.....
59207	7365	Arm Side Cover.....
1423j	7364	" " " Screw.....
59208	7365	Balance Wheel, 2 $\frac{3}{16}$ in. diam., with 424c and 1354c.....
1354c	7364	Balance Wheel Position Screw.....
424c	7364	" " Set Screw.....
59401	7367	Cloth Plate with 59292.....
59307	7365	" " Slide (left).....
59308	7365	" " " (right).....
59292	7364	" " Steady Pin.....
59402	—	Cloth Plate complete, Nos. 59307, 59308 and 59401.....
1149c	7364	Cloth Plate Screw.....
59209	7365	Feed Bar with two each 458c and 882c....
59440	—	" " 59209 with 59210 and 59211....
59210	7365	" " Carrier with two each 449c and 458c.....
57234	7355	Feed Bar Carrier Hinge Pin.....
57235	7355	" " " " " Bushing.....
457c	7364	" " " " " " Set Screw.....
458c	7364	Feed Bar Carrier Hinge Pin Set Screw....
59211	7355	" " Hinge Pin.....
882c	7364	" " " " Set Screw.....
59403	7363	" Dog, 19 teeth (18 teeth to the inch) for 59431.....
176j	7364	Feed Dog Screw.....
*59213	—	" Eccentric.....
*59494	—	" " Body with 42727.....
51061c	7364	" " " Set Screw.....
7071	7357	" " Clamping Washer.....
217E	7364	" " " " Screw....
59495	7355	Feed Eccentric (adjustable) complete, Nos. 217E, 7071, 50328c, 59213, 59494 and two 51061c.....

NO.	PLATE	NAME
59216	7355	Feed Eccentric Connection.....
59217	7355	" " " " Bar with 59218
59218	7355	" " " " Plug.....
449c	7361	" " " " Set Screw
59518	7357	" Lifting Eccentric with two 50150c...
59519	—	" " " 59518 with 59220..
59220	7357	" " " Connection.....
59221	7357	" " " " Bar with 59218.....
59218	7355	Feed Lifting Eccentric Connection Bar Plug.....
458c	7364	Feed Lifting Eccentric Connection Bar Set Screw.....
42727	7364	Feed Lifting Eccentric Position Pin.....
50150c	7364	" " " Set Screw.....
50328c	7364	" Regulating Screw.....
59405	7357	Looper with 590j and 59408.....
59381	7357	" Carrier with 50395c.....
59406	7357	" " Driver with two 1186E....
1186E	7357	" " " Clamping Screw...
207J	7364	" " " Timing Screw.....
59225	7357	" " Hole Plug.....
59226	7357	" " Shaft.....
59227	7357	" " " Crank with 1143E...
1143E	7357	" " " " Clamping Screw
59407	7356	" Needle Guard with 54707.....
51707	7356	" " " Pin.....
590j	7357	" " " Screw.....
50395c	7357	" Set Screw.....
59408	7357	" Thread Guard.....
590j	7357	" " " Screw.....
59409	7356	Needle Bar (hollow) with 906c.....
59410	7356	" " Bushing (lower).....
462c	7364	" " " " Set Screw....
42253	7356	" " " (upper).....
462c	7364	" " " " Set Screw...
59236	7356	" " Connecting Bracket with 175j and 460c.....
175j	7364	Needle Bar Connecting Bracket Clamping Screw.....
59237	7356	Needle Bar Connecting Link.....
40247	7356	" " " " Hinge Pin (lower).....
208E	7364	Needle Bar Connecting Link Hinge Pin (lower) Set Screw.....
40247	7356	Needle Bar Connecting Link Hinge Pin (upper).....

NO.	PLATE	NAME
460c	7364	Needle Bar Connecting Link Hinge Pin (upper) Set Screw.....
59238	7356	Needle Bar Lever with 208F, 448c and 1036c.....
59607	7365	Needle Bar Lever Connecting Rod with 55515, 59242, 59503, 128835 and two each 141E and 647E.....
59608	---	Needle Bar Lever Connecting Rod 59607 with 59240 and 59605.....
59240	7357	Needle Bar Lever Connecting Rod Ball Stud.....
1036c	7357	Needle Bar Lever Connecting Rod Ball Stud Set Screw.....
*59503	7365	Needle Bar Lever Connecting Rod Cap (lower).....
141E	7364	Needle Bar Lever Connecting Rod Cap (lower) Screw.....
*59242	7365	Needle Bar Lever Connecting Rod Cap (upper).....
647E	7364	Needle Bar Lever Connecting Rod Cap (upper) Screw.....
59605	7356	Needle Bar Lever Connecting Rod Eccentric with 448c, 1299c and two 59606....
59606	7356	Needle Bar Lever Connecting Rod Eccentric Lubricating Pad (wood).....
128835	7356	Needle Bar Lever Connecting Rod Eccentric Oil Cup.....
1299c	7356	Needle Bar Lever Connecting Rod Eccentric Position Screw.....
448c	7364	Needle Bar Lever Connecting Rod Eccentric Set Screw.....
42077	7356	Needle Bar Lever Connecting Rod Guide
187J	7361	" " " " " "
		Screw.....
59245	7356	Needle Bar Lever Connecting Rod Guide Stud.....
59246	7356	Needle Bar Lever Connecting Rod Guide Stud Bracket with 59245.....
193J	7357	Needle Bar Lever Connecting Rod Guide Stud Bracket Screw.....
55515	7356	Needle Bar Lever Connecting Rod Oil Pad (braided cotton).....
59247	7358	Needle Bar Lever Hinge Pin.....
59248	7358	" " " " " Bushing (back).....
624c	7364	Needle Bar Lever Hinge Pin Bushing (back) Set Screw.....

NO.	PLATE	NAME
59249	7358	Needle Bar Lever Hinge Pin Bushing (front).....
465c	7357	Needle Bar Lever Hinge Pin Bushing (front) Set Screw.....
448c	7364	Needle Bar Lever Hinge Pin Set Screw...
59412	7358	" Clamp with 46478 and two 50505F
46478	7358	" " Thread Guide.....
59321	7358	" Guard.....
171F	7364	" " Screw.....
50505F	7358	" Set Screw.....
59544	7358	Presser Bar.....
59252	7358	" " Bushing (lower).....
465c	7357	" " " " Set Screw....
42253	7356	" " " (upper).....
465c	7357	" " " " Set Screw....
59253	7358	" " Lifter.....
51815	7358	" " " Roller and Stud.....
89F	7358	" " " Hinge Screw.....
50138E	7364	" " " Stop Screw.....
59505	7358	" " Lifting Bracket with 391J, 1143c, 51810, 51811 and 51815.....
391J	7358	Presser Bar Lifting Bracket Adjusting Screw.....
59506	7358	Presser Bar Lifting Bracket Guide.....
624c	7364	" " " " " Set Screw
1143c	7357	" " " " " Set Screw....
59257	7359	" " Spring.....
59258	7358	" " " Block.....
51810	7358	" " " Roller and Stud.....
59413	7363	" Foot Hinge Pin.....
59414	---	" " Plate.....
59415	---	" " Shank.....
59416	7363	Presser Foot (hinged) complete, Nos. 59413 to 59415.....
185H	7364	Presser Foot Screw.....
1317D	7364	Pressure Regulating Thumb Screw.....
1547J	7364	" " " " Lock Nut
59264	7358	Slack Thread Controller.....
95c	7358	" " " Hinge Screw....
59265	7358	" " " Link.....
87c	7358	" " " " Hinge Screw
59417	7361	" " Pull-off.....
59418	7359	" " " Eyelet.....
59419	7359	" " " " Plate with 63767.....
63767	7362	Slack Thread Pull-off Eyelet Plate Pin...
63767	7362	" " " " Position Pin.



## ACCESSORIES

NO.	PLATE	NAME
120344	7366	Oiler (copper plated) with 120345.....
120345	7366	" Spout, 5 in. long.....
26026	7366	Screw Driver (large).....
26485	7366	" " (small).....
120341	7366	Tweezers (curved).....
4822	7366	Wrench for 1547.....
22003	7366	" " 1575.....

## EDGE FOLDER

NO.	PLATE	NAME
120265	7360	Edge Folder (adjustable) on Shank.....
1443D	7360	" " Screw.....

## KNEE LIFTER PARTS

NO.	PLATE	NAME
32040	---	Chain, 12 $\frac{3}{4}$ in. long, with 56864 and 56865
56864	7361	" Hook (large).....
56865	7361	" " (small).....
59509	7361	Lifting Lever.....
21D	7364	" " Hinge Screw.....
59510	7361	" " Spring.....
59511	7361	" " Stop.....
219J	7364	" " " Screw.....
7124	7367	Rock Shaft.....
2764	7367	" " Hanger (back) with two wood screws 1 in. No. 10.....
16128	7367	Rock Shaft Hanger (front) with two wood screws 1 in. No. 10.....
16646	7367	Rock Shaft Knee Arm.....
16647	---	Rock Shaft Knee Arm complete, Nos. 2766, 2767 and 16646.....
2766	7367	Rock Shaft Knee Arm Hub with 356c.....
356c	7364	" " " " " Set Screw.....
2767	7367	" " " " Plate with 356c.....
356c	7364	" " " " " Set Screw.....
6337	7367	" " Lifting Bracket with two 356c.....
6338	7367	" " " " Hook.....
356c	7364	" " " " " Set Screw.....
356c	7364	" " " " " Set Screw.....
32134	7367	" " Spring.....

## KNEE LIFTER PARTS

NO.	PLATE	NAME
2770	7367	Rock Shaft Spring Adjusting Dog with 356c
356c	7364	" " " " " Set Screw
2770	7367	" " Stop Dog with 356c.....
356c	7364	" " " " " Set Screw.....
32135	7367	Rock Shaft complete, Nos. 2764, 6337, 6338, 7124, 16128, 16647, 32134 and three 2770.....
59512	---	Knee Lifter complete (power table) Nos. 21D, 219J, 32040, 32135 and 59509 to 59511.....

## MACHINE BASE

NO.	PLATE	NAME
59295	7367	Machine Base with 100D, 36006, 59296 and four each 840E, 59297 and wood screws 1 $\frac{1}{2}$ in. No. 14.....
59296	7360	Machine Base Cover.....
36006	7360	" " " Friction Washer.....
100D	7364	" " " Hinge Screw.....
840E	7364	" " Screw.....
59297	7360	" Cushion (felt).....

## THREAD UNWINDER

### FOR THREE SPOOLS

NO.	PLATE	NAME
225259	20778	Spool Rest (for one spool) with 201018c...
225257	20778	" " (for two spools) with 201018c..
150203	---	" " Cushion (felt).....
225388	20778	" " Rod.....
200383c	7364	" " " Set Screw.....
201018c	7364	" " " Stand with 200383c.....
202490	20778	Thread Guide.....
225391	20778	" " " Lock Nut.....
201696J	7361	" " " Position Cup.....
225326	7361	" " " Rod with 208E and 225322
225324	20778	" " " " Screw.....
208E	7364	" " " " Washer.....
225322	7361	" " " " " Separator.....
*150057	---	" " " 150057 with 150059...
150058	20778	" " " Bracket.....
*150059	---	" " " " Arm with 164J
150060	20778	" " " " and 9525.....



NO.	PLATE	NAME
164j	7364	Thread Separator Bracket Arm Clamping Screw.....
9525	7361	Thread Separator Bracket Arm Clamping Screw Washer.....
164j	7364	Thread Separator Bracket Screw.....
9525	7361	" " " Washer
150061	---	Thread Separator complete, Nos. 164j, 9525, 150058 and 150060.....
150178	20778	Thread Unwinder complete, Nos. 150061, 201696j, 202490, 225257, 225259, 225324, 225326, 225388 and three each 150203, 225391 and wood screws $\frac{7}{8}$ in. No. 12..
27739	7366	Thread Cone (wood) for large cones....
225390	7366	" " Holder, for inverted cones..

Note. Nos. 27739 and 225390 are used with, but not included in 150178.

Genuine Singer Needles should be used in Singer Machines. These Needles and their Containers are marked with the Company's Trade Mark "SIMANCO." 1

Needles in Containers marked "For Singer Machines" are not Singer made needles. 2

## NUMERICAL LIST OF PARTS FOR MACHINE No. 105-20

## NUMERICAL LIST OF PARTS

NO. PLATE	NAME
21D 7364	Lifting Lever Hinge Screw for 59512....
87C 7358	Slack Thread Controller Link Hinge Screw
89F 7358	Presser Bar Lifter Hinge Screw.....
95C 7358	Slack Thread Controller Hinge Screw...
100D 7364	Machine Base Cover Hinge Screw for 59295.....
141E 7364	Needle Bar Lever Connecting Rod Cap (lower) Screw for 59607.....
164J 7364	Thread Unwinder Thread Separator Bracket Arm Clamping Screw for 150060.....
164J 7364	Thread Unwinder Thread Separator Bracket Screw for 150061.....
171F 7364	Needle Guard Screw.....
175J 7364	" Bar Connecting Bracket Clamp- ing Screw for 59236.....
176J 7364	Feed Dog Screw.....
185H 7364	Presser Foot Screw.....
187J 7361	Needle Bar Lever Connecting Rod Guide Screw.....
190J 7361	Thread (under) Nipper Releasing Bracket Screw.....
190J 7361	Thread (under) Take-up Screw.....
193J 7357	Needle Bar Lever Connecting Rod Guide Stud Bracket Screw.....
193J 7357	Slack Thread Pull-off Screw.....
207J 7364	Looper Carrier Driver Timing Screw....
207F 7364	Thread (under) Take-up Stripper Screw..
208F 7364	Needle Bar Connecting Link Hinge Pin (lower) Set Screw for 59238.....
208E 7364	Thread Unwinder Thread Guide Rod Screw for 225324.....
217E 7364	Feed Eccentric Clamping Washer Screw for 59495.....
219J 7364	Lifting Lever Stop Screw for 59512.....
228J 7361	Slack Thread Pull-off Eyelet Screw.....
236F 7364	Thread (under) Take-up Staple Holder Collar Spring Screw.....
240F 7362	Thread (under) Protector Set Screw for 59285.....
356C 7364	Rock Shaft Knee Arm Hub Set Screw for 2766.....
356C 7364	Rock Shaft Knee Plate Set Screw for 2767

NO.	PLATE	NAME
356c	7364	Rock Shaft Lifting Bracket Hook Set Screw for 6337.....
356c	7364	Rock Shaft Lifting Bracket Set Screw for 6337.....
356c	7364	Rock Shaft Spring Adjusting Dog Set Screw for 2770.....
356c	7364	Rock Shaft Stop Dog Set Screw for 2770.....
391J	7358	Presser Bar Lifting Bracket Adjusting Screw for 59505.....
424c	7364	Balance Wheel Set Screw for 59208.....
448c	7364	Arm Rotary Shaft Bushing (front) Set Screw.....
448c	7364	Needle Bar Lever Connecting Rod Eccentric Set Screw for 59605.....
448c	7364	Needle Bar Lever Hinge Pin Set Screw for 59238.....
449c	7361	Feed Eccentric Connection Bar Set Screw for 59210.....
452c	7362	Thread (under) Nipper Bracket Stud Set Screw.....
452c	7362	Thread (upper) Check Spring Bracket Stud Set Screw.....
457c	7364	Feed Bar Carrier Hinge Pin Bushing Set Screw.....
458c	7364	Feed Bar Carrier Hinge Pin Set Screw for 59209.....
458c	7364	Feed Lifting Eccentric Connection Bar Set Screw for 59210.....
460c	7364	Needle Bar Connecting Link Hinge Pin (upper) Set Screw for 59236.....
460c	7364	Thread (under) Take-up Staple Holder Collar Set Screw for 59282.....
462c	7364	Needle Bar Bushing (lower) Set Screw.....
462c	7364	" " " (upper) Set Screw.....
465c	7357	" " Lever Hinge Pin Bushing (front) Set Screw.....
465c	7357	Presser Bar Bushing (lower) Set Screw.....
465c	7357	" " " (upper) Set Screw.....
465c	7357	Slack Thread Regulator Holder Crank Set Screw for 59268.....
465c	7357	Slack Thread Regulator Set Screw for 59267.....
590J	7357	Looper Needle Guard Screw.....
590J	7357	" Thread Guard Screw for 59405.....
596D	7359	Thread (under) Take-up Stripper Bracket Screw.....
624c	7364	Needle Bar Lever Hinge Pin Bushing (back) Set Screw.....

NO.	PLATE	NAME
624c	7364	Presser Bar Lifting Bracket Guide Set Screw.....
647E	7364	Needle Bar Lever Connecting Rod Cap (upper) Screw for 59607.....
691F	7363	Throat Plate Screw.....
840E	7364	Machine Base Screw for 59295.....
882c	7364	Feed Bar Hinge Pin Set Screw for 59209.....
904c	7361	Thread (under) Take-up Staple Set Screw for 59281.....
904c	7361	Thread (upper) Check Spring Regulating Stud Set Screw for 59426.....
904c	7361	Thread (upper) Check Spring Stop Screw.....
906c	7364	" " Take-up Set Screw for 59409.....
1036c	7357	Needle Bar Lever Connecting Rod Ball Stud Set Screw for 59238.....
1143E	7357	Looper Carrier Shaft Crank Clamping Screw for 59227.....
1143c	7357	Presser Bar Lifting Bracket Set Screw for 59505.....
1149c	7364	Cloth Plate Screw.....
1186E	7357	Looper Carrier Driver Clamping Screw for 59406.....
1285c	7364	Arm Rotary Shaft Bushing (back) Set Screw.....
1285c	7364	Arm Rotary Shaft Bushing (intermediate) Set Screw.....
1299c	7356	Needle Bar Lever Connecting Rod Eccentric Position Screw for 59605.....
1317D	7364	Pressure Regulating Thumb Screw.....
1354c	7364	Balance Wheel Position Screw for 59208.....
1423J	7364	Arm Side Cover Screw.....
1423J	7364	Thread (under) Eyelet Screw.....
1423J	7364	" " Nipper Spring Screw.....
1443D	7360	Edge Folder Screw.....
1547J	7364	Pressure Regulating Thumb Screw Lock Nut.....
1517E	7364	Tension (upper thread) Screw Stud Nut.....
2102	7362	" (under thread) Disc.....
2102	7362	" (upper thread) Disc.....
2273	7360	" (upper) Check Spring Bracket Pin for 59426.....
2764	7367	Rock Shaft Hanger (back) with two wood screws 1 in. No. 10, for 32135.....
2766	7367	Rock Shaft Knee Arm Hub with 356c, for 16647.....

NO.	PLATE	NAME
2767	7367	Rock Shaft Knee Plate with 356c, for 16647.....
2770	7367	Rock Shaft Spring Adjusting Dog with 356c, for 32135.....
2770	7367	Rock Shaft Stop Dog with 356c, for 32135.....
4822	7366	Wrench for 1547 (Accessories).....
6337	7367	Rock Shaft Lifting Bracket with two 356c, for 32135.....
6338	7367	Rock Shaft Lifting Bracket Hook for 32135.....
7071	7357	Feed Eccentric Clamping Washer for 59495.....
7124	7367	Rock Shaft for 32135.....
9525	7361	Thread Unwinder Thread Separator Bracket Arm Clamping Screw Washer for 150060.....
9525	7361	Thread Unwinder Thread Separator Bracket Screw Washer for 150061.....
9547	7359	Thread (under) Nipper Spring Steady Pin for 59423.....
*15101	----	Trade Mark.....
15405	---	" " Rivet.....
16128	7367	Rock Shaft Hanger (front) with two wood screws 1 in. No. 10, for 32135.....
16646	7367	Rock Shaft Knee Arm for 16647.....
16647	---	Rock Shaft Knee Arm complete for 32135, Nos. 2766, 2767 and 16646.....
22003	7366	Wrench for 1575 (Accessories).....
26026	7366	Screw Driver (large) Accessories.....
26485	7366	" " (small) Accessories.....
27739	7366	Thread Unwinder Thread Cone (wood) for large cones, for 150178.....
32040	---	Chain, 12 <sup>3</sup> / <sub>4</sub> in. long, with 56864 and 56865, for 59512.....
32134	7367	Rock Shaft Spring for 32135.....
32135	7367	Rock Shaft complete for 59512, Nos. 2764, 6337, 6338, 7124, 16128, 16647, 32134 and three 2770.....
36006	7360	Machine Base Cover Friction Washer for 59295.....
38670	7359	Tension (under thread) Bracket Steady Pin.....
40247	7356	Needle Bar Connecting Link Hinge Pin (lower).....
40247	7356	Needle Bar Connecting Link Hinge Pin (upper).....
42077	7356	Needle Bar Lever Connecting Rod Guide

NO.	PLATE	NAME
42253	7356	Presser Bar Bushing (upper).....
42253	7356	Needle Bar Bushing (upper).....
42727	7364	Feed Lifting Eccentric Position Pin for 59494.....
46478	7358	Needle Clamp Thread Guide for 59412..
50014c	7364	Thread (upper) Eyelet (side of arm) Screw.....
50138E	7364	Presser Bar Lifter Stop Screw.....
50150c	7364	Feed Lifting Eccentric Set Screw for 59518.....
50326c	7362	Tension (under thread) Screw Stud for 59539.....
50326c	7362	Tension (upper thread) Screw Stud for 59539.....
50328c	7364	Feed Regulating Screw for 59495.....
50395c	7357	Looper Set Screw for 59381.....
50505F	7358	Needle Set Screw for 59412.....
51061c	7364	Feed Eccentric Body Set Screw for 59495
51570c	7362	Tension (underthread) Regulating Thumb Nut for 59539.....
51570c	7362	Tension (upper thread) Regulating Thumb Nut for 59539.....
51810	7358	Presser Bar Spring Roller and Stud for 59505.....
51811	7358	Slack Thread Regulator Holder Crank Roller and Stud for 59505.....
51815	7358	Presser Bar Lifter Roller and Stud for 59505.....
52045	7355	Arm Rotary Shaft Bushing (back) Packing (cotton) for 59523.....
52045	7355	Arm Rotary Shaft Bushing (front) Packing (cotton) for 59524.....
52045	7355	Arm Rotary Shaft Bushing (intermediate) Packing (cotton) for 59525.....
54707	7356	Looper Needle Guard Pin for 59407.....
55515	7356	Needle Bar Lever Connecting Rod Oil Pad (braided cotton) for 59607.....
56864	7361	Chain Hook (large) for 32040.....
56865	7361	" " (small) for 32040.....
57234	7355	Feed Bar Carrier Hinge Pin.....
57235	7355	" " " " Bushing.....
59207	7365	Arm Side Cover.....
59208	7365	Balance Wheel, 2 <sup>3</sup> / <sub>16</sub> in. diam., with 424c and 1354c.....
59209	7365	Feed Bar with two each 458c and 882c, for 59440.....

NO.	PLATE	NAME
59210	7365	Feed Bar Carrier with two each 419c and 458c, for 59440.....
59211	7355	Feed Bar Hinge Pin for 59440.....
*59213	-----	" Eccentric for 59495.....
59216	7355	" " Connection.....
59217	7355	" " " Bar with 59218
59218	7355	" " " " Plug for 59217.....
59218	7355	Feed Lifting Eccentric Connection Bar Plug for 59221.....
59220	7357	Feed Lifting Eccentric Connection for 59519.....
59221	7357	Feed Lifting Eccentric Connection Bar with 59218.....
59225	7357	Looper Carrier Hole Plug.....
59226	7357	" " Shaft.....
59227	7357	" " " Crank with 1143E..
59236	7356	Needle Bar Connecting Bracket with 175r and 460c.....
59237	7356	Needle Bar Connecting Link.....
59238	7356	" " Lever with 208F, 448c and 4036c.....
59240	7357	Needle Bar Lever Connecting Rod Ball Stud for 59608.....
*59242	7365	Needle Bar Lever Connecting Rod Cap (upper) for 59607.....
59245	7356	Needle Bar Lever Connecting Rod Guide Stud for 59246.....
59246	7356	Needle Bar Lever Connecting Rod Guide Stud Bracket with 59245.....
59247	7358	Needle Bar Lever Hinge Pin.....
59248	7358	" " " " " Bushing (back).....
59249	7358	Needle Bar Lever Hinge Pin Bushing (front).....
59252	7358	Presser Bar Bushing (lower).....
59253	7358	" " Lifter.....
59257	7359	" " Spring.....
59258	7358	" " " Block.....
59264	7358	Slack Thread Controller.....
59265	7358	" " " Link.....
59267	7359	" " Regulator Holder with 465c
59268	7359	" " " " Crank with two 465c.....
59270	7362	Thread (under) Eyelet.....
59272	7362	" " Nipper Guide Plate.....
59273	7362	" " " Releasing Bracket

NO.	PLATE	NAME
59274	7362	Thread (under) Nipper Releasing Stud...
59275	7362	" " " Spring.....
59276	7362	" " Protector.....
59277	7359	" " Take-up (left).....
59278	7359	" " " (right).....
59280	7359	" " " Staple.....
59281	7359	" " " " Holder with 904c.....
59282	7359	Thread (under) Take-up Staple Holder Collar with 460c.....
59283	7359	Thread (under) Take-up Staple Holder Collar Spring.....
59285	7359	Thread (under) Take-up Stripper Bracket with 240E.....
59292	7364	Cloth Plate Steady Pin for 59401.....
59295	7367	Machine Base with 100D, 36006, 59296 and four each 840E, 59297 and wood screws 1½ in. No. 14.....
59296	7360	Machine Base Cover for 59295.....
59297	7360	" Cushion (felt) for 59295.....
59301	7362	Thread (under) Nipper Bracket Stud for 59423.....
59307	7365	Cloth Plate Slide (left) for 59402.....
59308	7365	" " " (right) for 59402.....
59321	7358	Needle Guard.....
59381	7357	Looper Carrier with 50395c.....
*59399	-----	Arm, upper and lower (solid).....
59401	7367	Cloth Plate with 59292, for 59402.....
59402	-----	Cloth Plate complete, Nos. 59307, 59308 and 59401.....
59403	7363	Feed Dog, 19 teeth (18 teeth to the inch) for 59431.....
59405	7357	Looper with 590r and 59408.....
59406	7357	" Carrier Driver with two 1186E..
59407	7356	" Needle Guard with 54707.....
59408	7357	" Thread Guard for 59405.....
59409	7356	Needle Bar (hollow) with 906c.....
59410	7356	" " Bushing (lower).....
59412	7358	" Clamp with 46478 and two 50505E
59413	7363	Presser Foot Hinge Pin for 59416.....
59414	-----	" " Plate for 59416.....
59415	-----	" " Shank for 59416.....
59416	7363	Presser Foot (hinged) complete, Nos. 59413 to 59415.....
59417	7361	Slack Thread Pull-off.....
59418	7359	" " " Eyelet.....

NO.	PLATE	NAME
59419	7359	Slack Thread Pull-off Eyelet Plate with 63767, for 59423.....
59420	7359	Slack Thread Regulator.....
59421	7362	Tension (under thread) Bracket.....
59422	7362	Thread (under) Nipper Bracket for 59423
59423	—	“ “ “ “ 59422 with 9547, 59301, 59419 and two 63767.....
59424	7359	Thread (under) Take-up Stripper.....
59425	7362	“ (upper) Check Spring.....
59426	7360	“ “ “ “ Bracket with 2273, 59427 and two 904c.....
*59427	7360	Thread (upper) Check Spring Bracket Stud for 59426.....
59428	7360	Thread (upper) Check Spring Regulating Stud.....
59429	7360	Thread (upper) Eyelet (side of arm)....
59430	7360	“ “ Take-up.....
59431	7363	Throat Plate for 59403.....
59440	—	Feed Bar 59209 with 59210 and 59211....
59491	7365	Arm Rotary Shaft.....
*59494	—	Feed Eccentric Body with 42727, for 59495.....
59495	7355	Feed Eccentric (adjustable) complete, Nos. 217E, 7071, 50328c, 59213, 59494 and two 51061c.....
*59503	7365	Needle Bar Lever Connecting Rod Cap (lower) for 59607.....
59505	7358	Presser Bar Lifting Bracket with 3914, 1143c, 51810, 51811 and 51815.....
59506	7358	Presser Bar Lifting Bracket Guide.....
59509	7361	Lifting Lever for 59512.....
59510	7361	“ “ Spring for 59512.....
59511	7361	“ “ Stop for 59512.....
59512	—	Knee Lifter complete (power table), Nos. 21b, 219a, 32010, 32135, 59509 to 59511
59518	7357	Feed Lifting Eccentric with two 50150c, for 59519.....
59519	—	Feed Lifting Eccentric 59518 with 59220
59523	7355	Arm Rotary Shaft Bushing (back) with 52045.....
59524	7355	Arm Rotary Shaft Bushing (front) with 52045.....
59525	7355	Arm Rotary Shaft Bushing (intermediate) with 52045.....
59534	7362	Tension (under thread) Spring.....
59535	7362	“ (upper thread) Spring.....

NO.	PLATE	NAME
59537	7362	Tension (under thread) Spring Bushing (large).....
59537	7362	Tension (upper thread) Spring Bushing (large).....
59538	7362	Tension (under thread) Spring Bushing (small).....
59538	7362	Tension (upper thread) Spring Bushing (small).....
59539	—	Tension (under thread) Screw Stud 50326c with 51570c.....
59539	—	Tension (upper thread) Screw Stud 50326c with 51570c.....
59544	7358	Presser Bar.....
59605	7356	Needle Bar Lever Connecting Rod Eccentric with 448c, 1299c and two 59606, for 59608.....
59606	7356	Needle Bar Lever Connecting Rod Eccentric Lubricating Pad (wood) for 59605
59607	7365	Needle Bar Lever Connecting Rod with 55515, 59242, 59503, 128835 and two each 141E and 647E, for 59608.....
59608	—	Needle Bar Lever Connecting Rod 59607 with 59240 and 59605.....
63767	7362	Slack Thread Pull-off Eyelet Plate Pin for 59419.....
63767	7362	Slack Thread Pull-off Eyelet Position Pin for 59423.....
120265	7360	Edge Folder (adjustable) on Shank.....
120341	7366	Tweezers (curved) Accessories.....
120344	7366	Oiler (copper plated) with 120345 (Accessories).....
120345	7366	Oiler Spout, 5 in. long, for 120344 (Accessories).....
128835	7356	Needle Bar Lever Connecting Rod Eccentric Oil Cup for 59607.....
*150057	—	Thread Unwinder Thread Separator for 150058.....
150058	20778	Thread Unwinder Thread Separator 150057 with 150059, for 150061.....
*150059	—	Thread Unwinder Thread Separator Bracket for 150058.....
150060	20778	Thread Unwinder Thread Separator Bracket Arm with 164j and 9525, for 150061.....
150061	—	Thread Unwinder Thread Separator complete for 150178, Nos. 164j, 9525, 150058 and 150060.....

NO.	PLATE	NAME
150178	20778	Thread Unwinder complete, for three spools, Nos. 150061, 201696j, 202490, 225257, 225259, 225324, 225326, 225388 and three each 150203, 225391 and wood screws $\frac{7}{8}$ in. No. 12.....
150203	----	Thread Unwinder Spool Rest Cushion (felt) for 150178.....
200383c	7364	Thread Unwinder Spool Rest Rod Set Screw for 202490.....
201018c	7364	Thread Unwinder Spool Rest Set Screw for 225257 and 225259.....
201696j	7361	Thread Unwinder Thread Guide Lock Nut for 150178.....
202490	20778	Thread Unwinder Spool Stand with 200383c, for 150178.....
225257	20778	Thread Unwinder Spool Rest (for two spools) with 201018c, for 150178.....
225259	20778	Thread Unwinder Spool Rest (for one spool) with 201018c, for 150178.....
225322	7361	Thread Unwinder Thread Guide Rod Washer for 225324.....
225324	20778	Thread Unwinder Thread Guide Rod with 208e and 225322, for 150178.....
225326	7361	Thread Unwinder Thread Guide Position Cup for 150178.....
225388	20778	Thread Unwinder Spool Rest Rod for 150178.....
225390	7366	Thread Unwinder Thread Cone Holder, for inverted cones, for 150178.....
225391	20778	Thread Unwinder Thread Guide for 150178

Genuine Singer Needles should be used in Singer Machines.  
These Needles and their Containers are marked with the Company's Trade Mark "SIMANCO." 1

Needles in Containers marked "For Singer Machines" are not Singer made needles. 2

## ILLUSTRATIONS OF PARTS FOR MACHINE No. 105-20

PLATE 7355-FULL SIZE

59523



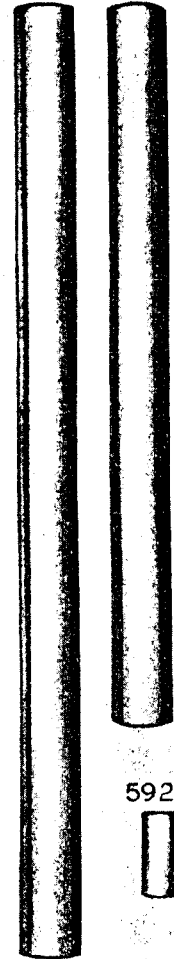
59524



59525



57234 59211



59217



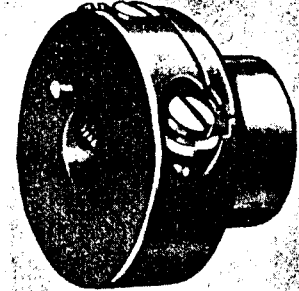
52045



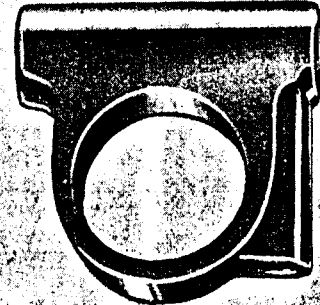
57235



59495



59216



59218





PLATE 7356—FULL SIZE

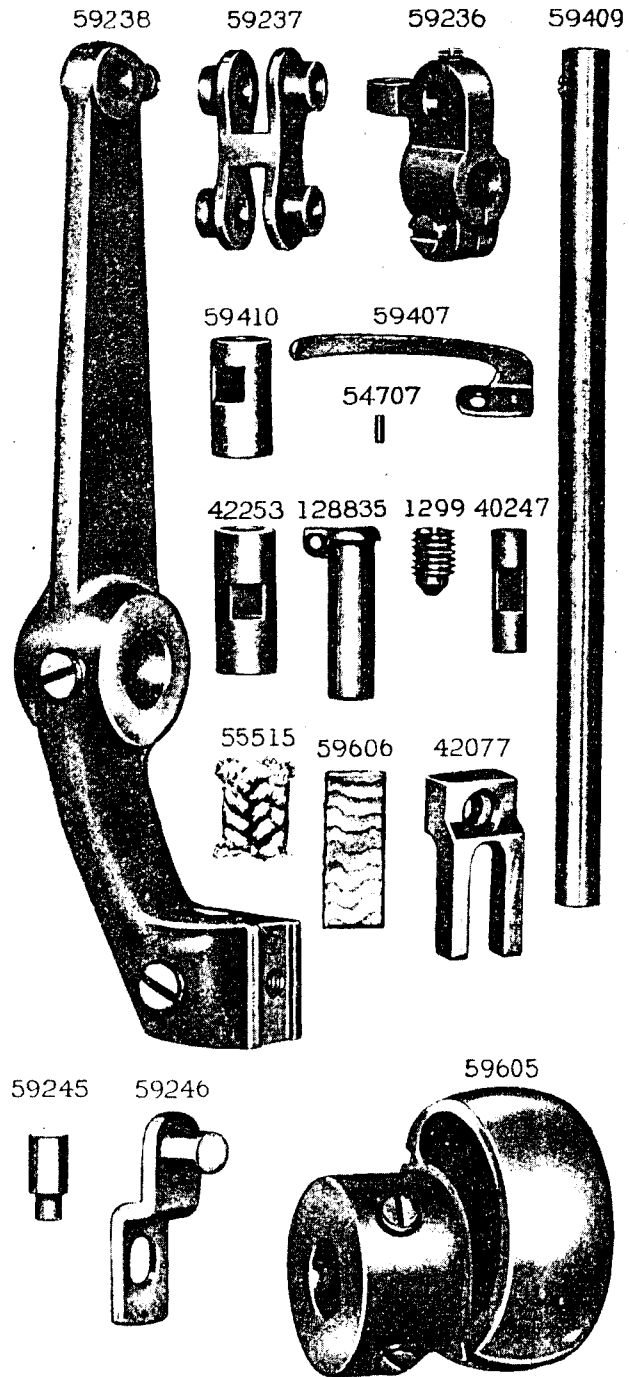


PLATE 7357—FULL SIZE

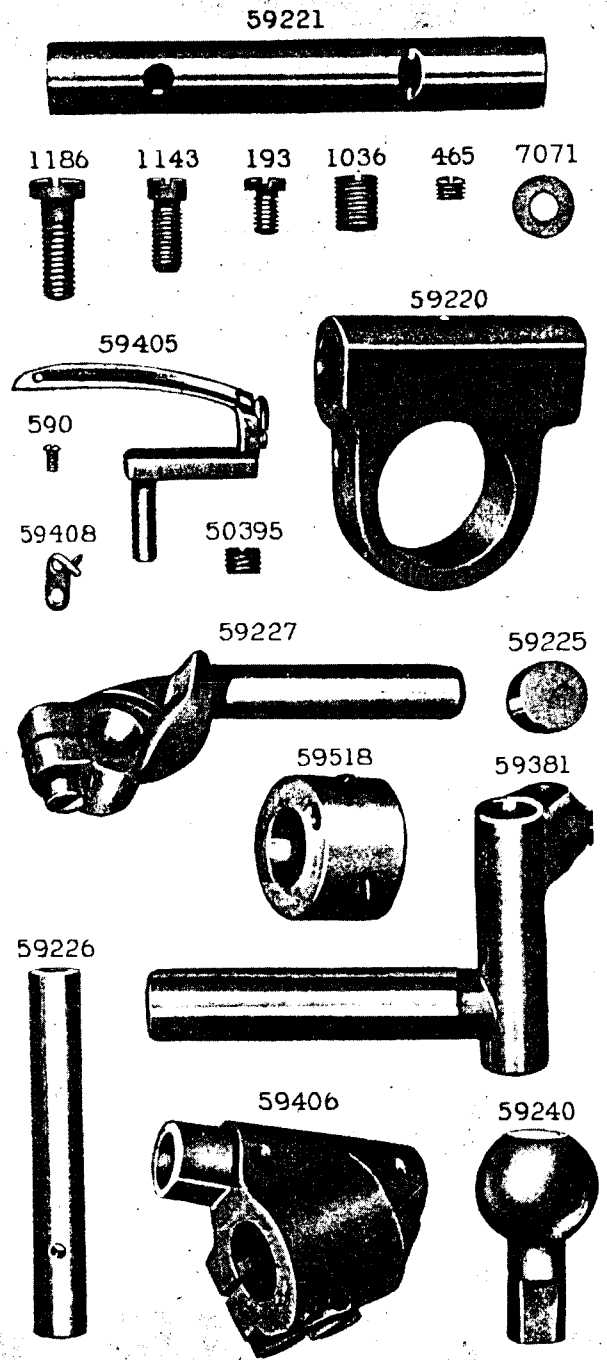


PLATE 7358—FULL SIZE

59544



59247



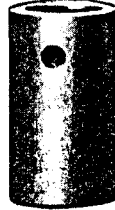
59412



59249



59248



59258



46478



50505

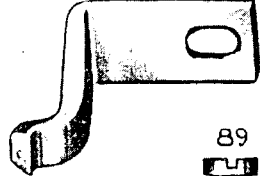
51815



59252



59321



51811



89



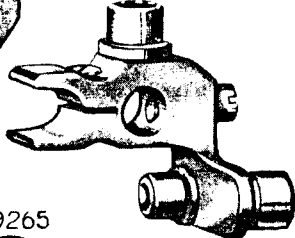
51810



59253



59505



59506



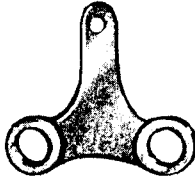
87



59265



59264

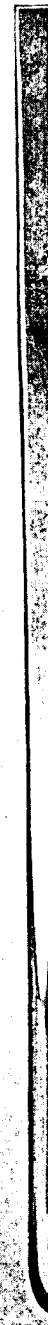


391



PLATE 7359—FULL SIZE

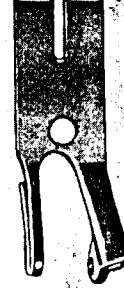
59257



59424



59418



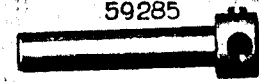
59419



38670 9547



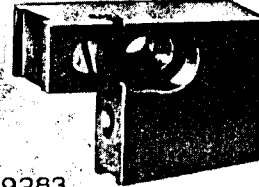
59285



596



59281



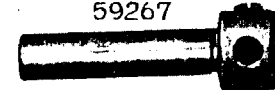
59280



59283

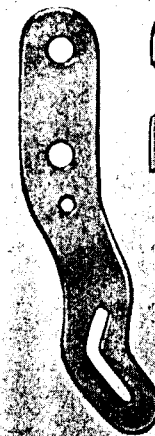


59267



59420

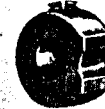
59277



59278



59282



59268



PLATE 7360—FULL SIZE

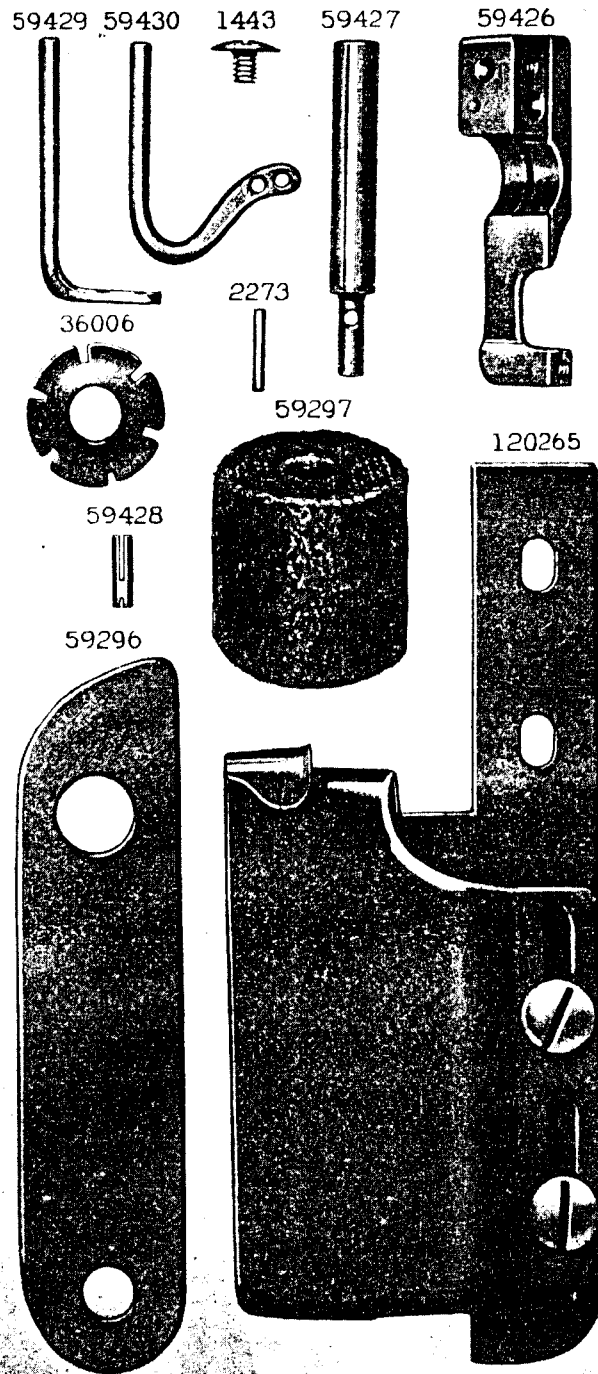


PLATE 7361—FULL SIZE

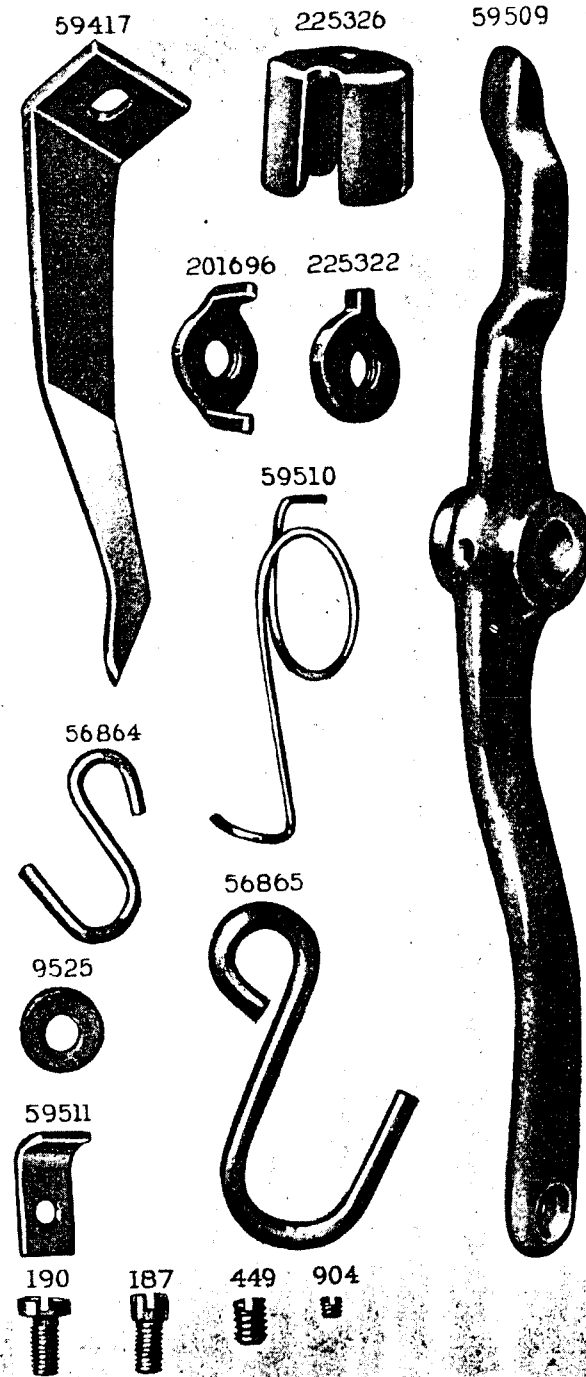
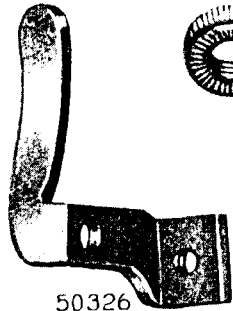


PLATE 7362—FULL SIZE

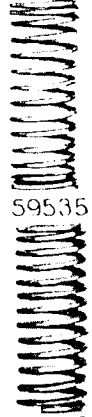
59273



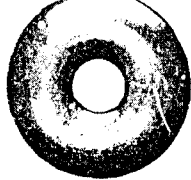
50326



59534



59535

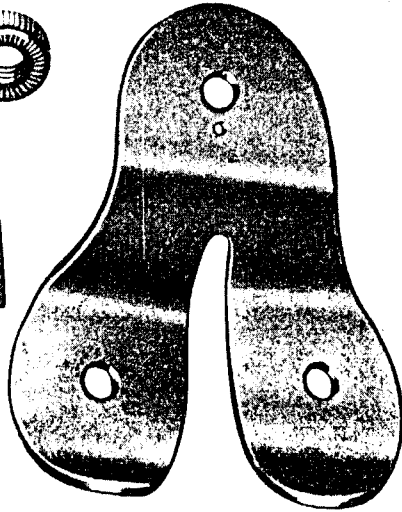


2102

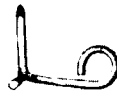
51570



59421



59270



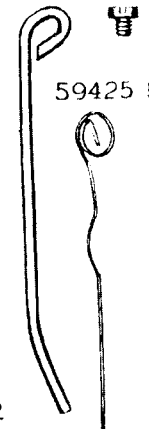
59538



59537



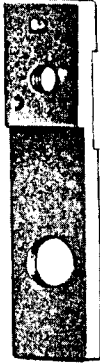
59276 240



452 63767



59422



59425



59274



59301



59275

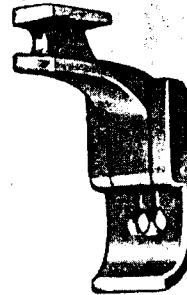


59272

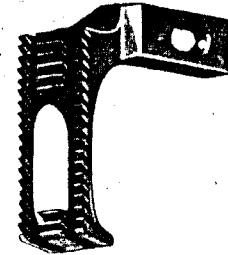


PLATE 7363—FULL SIZE

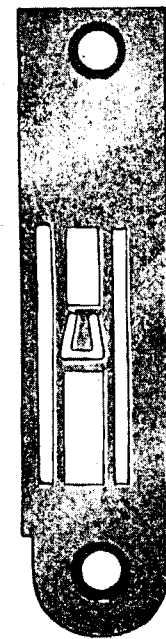
59416



59403



59431



59413



691



PLATE 7364—FULL SIZE

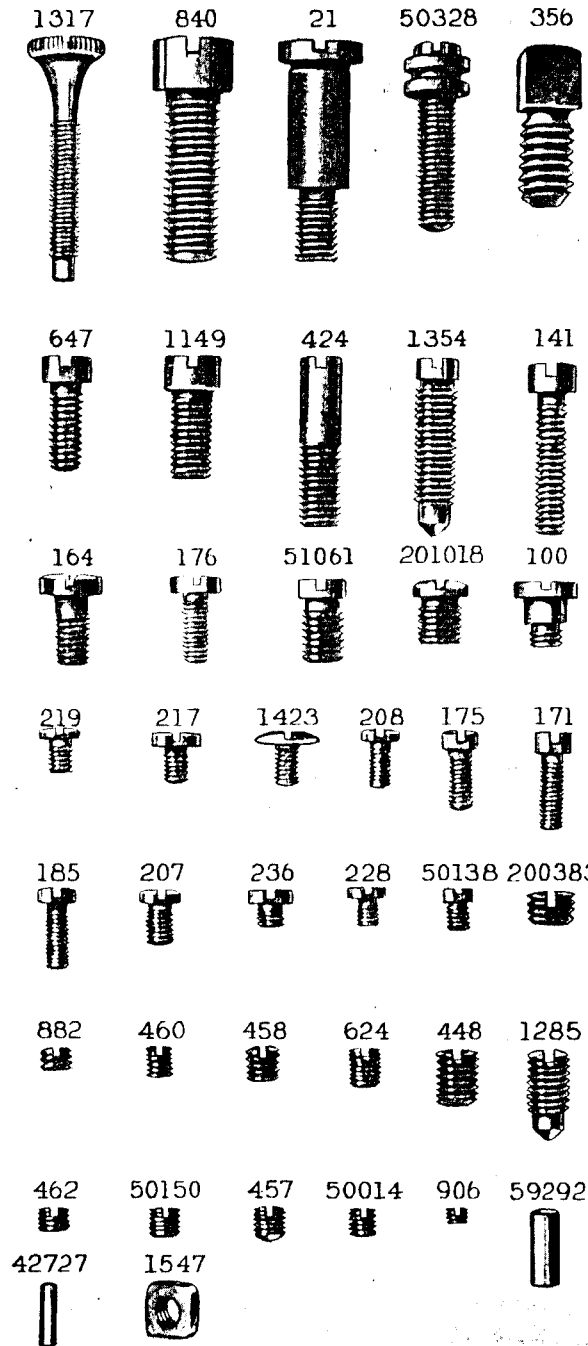


PLATE 7365—ONE-HALF SIZE

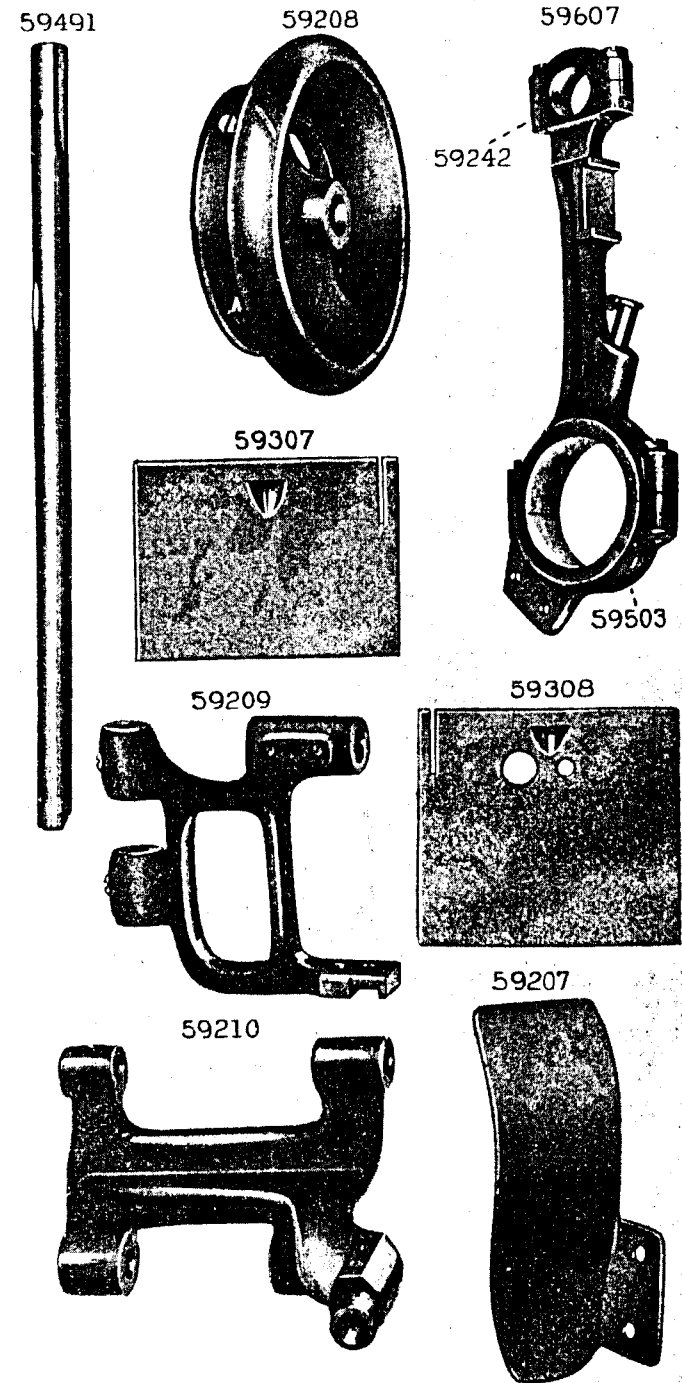


PLATE 7366—ONE-HALF SIZE

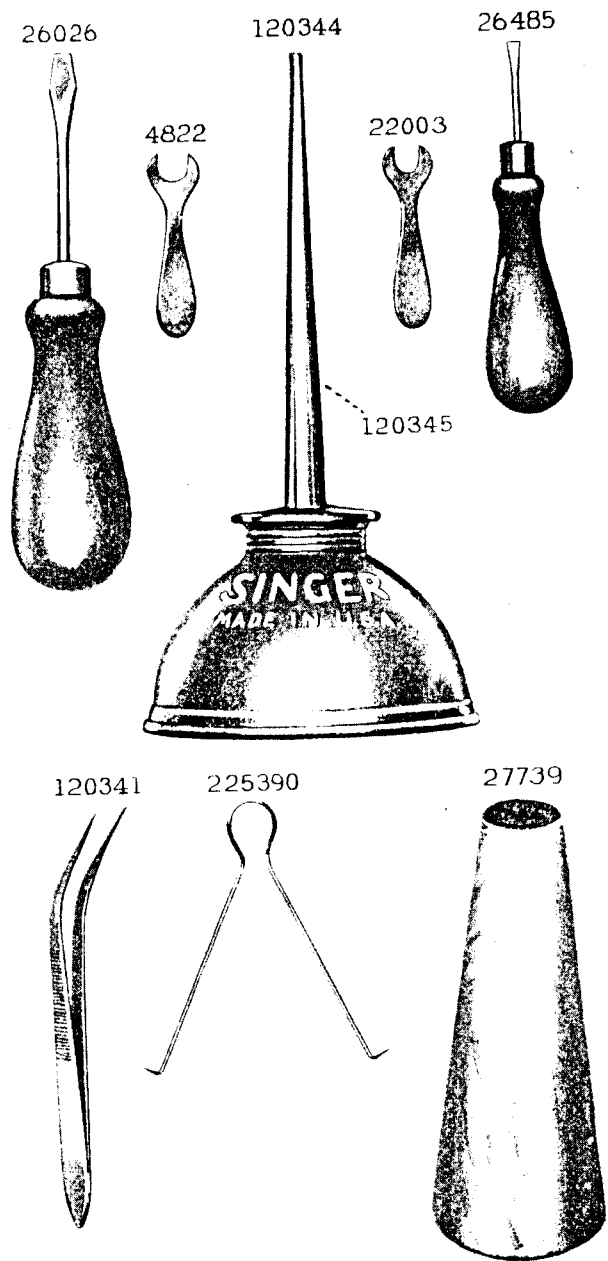


PLATE 7367—ONE-FOURTH SIZE

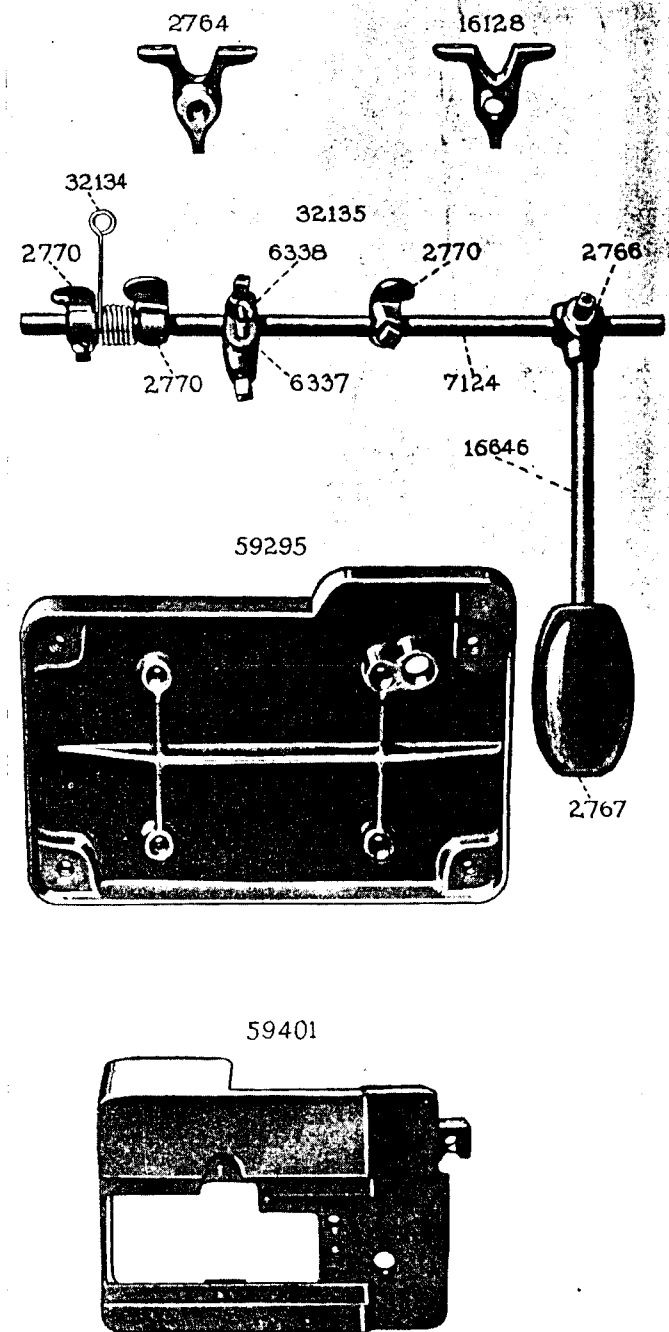


PLATE 20778—ONE-SIXTH SIZE

