

SINGER
47W10,W101

LIST OF PARTS



MACHINES

Nos. 47w10 and 47w101

THE SINGER MANUFACTURING COMPANY

INDEX

	PAGE
ACCESSORIES	16
BOBBIN WINDER	16
FEED DOGS	18
FOOT LIFTER	17
HEMMERS	21
MACHINE No. 47w10	7
" " 47w101	15
NUMERICAL LIST OF PARTS	25
OBSOLETE PARTS	24
PRESSER FEET	19
THROAT PLATES	20
WORK PLATE PLATFORM	23

Instructions for Ordering

In ordering from this list, use **ONLY** the **PART** number in the **FIRST** column.

The number stamped on a Sewing Machine Part is the number of the Single Part only, except when the part includes Set Screws, Clamping Screws, Studs and Rollers Spun on, Small Wires riveted, or Parts soldered together, etc., which it is necessary to furnish in combination.

Every combination of parts sent out has its specific number which, although not stamped on Parts (except in above cases) must be used when ordering the combination.

Each number always indicates the **SAME PART** in whatever list it appears, or for whatever Machine.

The letters after some of the numbers indicate the style of finish only, as follows:

- A. Hardened, Polished and Plated.
- B. Polished and Plated.
- C. Hardened only.
- D. Polished only.
- E. Soft, not polished.
- F. Hardened and Polished.
- H. Blued.

These letters **MUST BE USED** when they appear in the list and **AFTER** the number, as in the list.

In this series

- 200001 to 201500 are Screw Numbers.
- 201501 to 201800 are Nut Numbers.
- 201801 to 202000 are Roller Numbers.
- 202001 and upward are numbers of Machine Parts.

The figures in the second column refer only to the plate in which the illustration of the part is shown and are **NOT TO BE USED** in ordering.

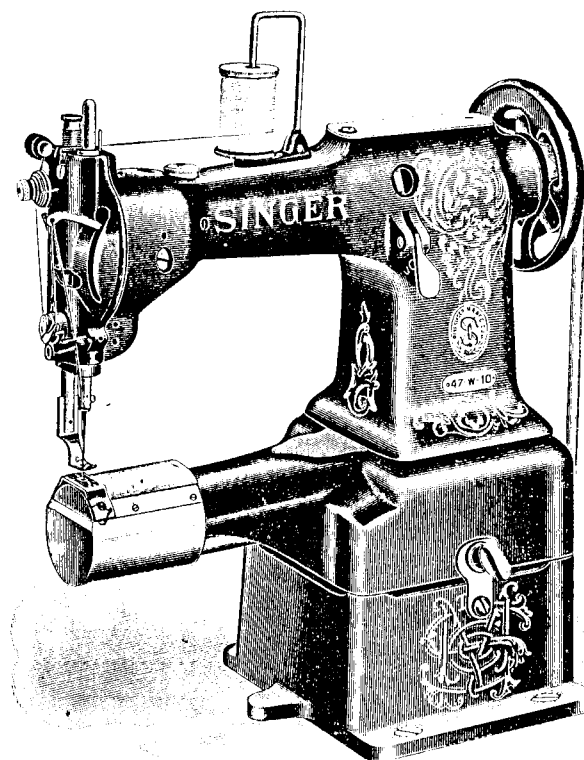
Two or more numbers over a cut indicate that the difference between such parts is not visible in an illustration.

Parts marked with an asterisk (*) are furnished only when repairs are made at the factory.

Counter Copy ⁷

LIST OF PARTS COMPLETE

FOR



MACHINE No. 47w10

DROP FEED. CYLINDER BED.

For Shirts, Underwear, etc.

No.	Plate	Name
*213346	—	Arm
213144	11150	" Cap
200278H	12311	" " Screw
202248	11151	" " Washer
204235	12487	" Position Pin
200963E	12311	" Screw (3)

No.	Plate	Name
202005	11151	Arm Screw Washer (3)
213423	11152	" Shaft
213328	---	" " 213423 with 200244d, 200245d, 213349 to 213351, 213354, 213654, 213655 and two 201528E
204801	11150	Arm Shaft Bushing (back) with 202260
202260	---	Arm Shaft Bushing (back) Oil Packing (wick)
200338c	11151	Arm Shaft Bushing (back) Set Screw
213299	11150	Arm Shaft Bushing (center) with 202260
202260	---	Arm Shaft Bushing (center) Oil Packing (wick)
200341c	11151	Arm Shaft Bushing (center) Set Screw
213781	12488	Arm Shaft Bushing (front) with 202036 and 202260
202260	---	Arm Shaft Bushing (front) Oil Packing (wick)
200502B	11151	Arm Shaft Bushing (front) Oil Packing Thumb Screw
202036	12487	Arm Shaft Bushing (front) Posi- tion Pin
200352c	11151	Arm Shaft Bushing (front) Set Screw
204804	11152	Arm Shaft Connection with four 200054E (2)
200054E	11151	Arm Shaft Connection Screw
204805	12490	Balance Wheel, 5½ in. diam. (belt groove 2¾ in. diam.), with 200328c and 200335c
200062H	12311	Balance Wheel Adjusting Screw ..
200328c	12311	" " Position Screw
200335c	12311	" " Set Screw
*213369	---	Bed (cylinder) with 200439c, 213314, 213380 and two 200516E
213786	11150	Bed (cylinder) Cap
200574D	11061	" " " Screw (2)
213787	11150	" " End Cover
213353	---	" Base (high)
213890	---	" " (low)
Note: High Bed Base 213353 furnished only when ordered.		
203184	11060	Bed Clamp
200262H	11060	" " Hinge Screw
202622	11151	" " Packing Washer
200728B	11060	" " Thumb Screw

No.	Plate	Name
203185	11060	Bed Clamp Washer
202618	12490	" Hinge
200030H	12487	" " Screw (6)
213338	11150	" Slide (back)
213685	11061	" " Clamp Plate
213686	11061	" " " "
200582H	11151	" " " " Screw (4) ..
203208	11228	Bobbin
203210	11228	" Case Base with 202056, 203211 to 203213 and 203216
203211	11151	Bobbin Case Base Latch
*202056	---	" " " " Pin
203212	11151	" " " " Plunger ..
203213	11151	" " " " Spring ..
203209	11228	" " Cap with 200984c, 203214, 203215 and two 200594c
203214	11228	Bobbin Case Tension Spring
200984c	11151	" " " " Regulat- ing Screw
200594c	11228	Bobbin Case Tension Spring Screw
203215	11228	" " Thread Guide
200594c	11228	" " " " Screw
203216	11228	" " Washer (cloth)
203217	11228	Bobbin Case complete, Nos. 203209 and 203210
204184	---	Face Plate with 200355H, 200368H, 200688c, 202090, 204185, 204281 and two 200397H
200053c	12311	Face Plate Screw
204185	11151	" " Thread Guide
200397H	12309	" " " " Set Screw
204186	---	Face Plate complete, Nos. 200135c, 200309E, 200319c, 200577H, 204059, 204184, 204267, 204272 and 204277 to 204280
213295	11060	Feed Bar with 200544E and 213610
213298	11061	" " Connecting Link with two 200072c
200072c	11151	Feed Bar Connecting Link Pinch Screw
200935F	11151	Feed Bar Connecting Link Screw Stud
201532E	11151	Feed Bar Connecting Link Screw Stud Nut
213610	11151	Feed Bar Connecting Link Stud ..
212258	12491	" Dog
200544E	11061	" " Screw
213349	12488	" Driving Eccentric (adjust- able)

No.	Plate	Name
213350	12488	Feed Driving Eccentric Adjusting Disc
213351	12488	Feed Driving Eccentric Flange with 200378c and 200437c
200437c	12311	Feed Driving Eccentric Flange Position Screw
200378c	12311	Feed Driving Eccentric Flange Set Screw
213655	11151	Feed Driving Eccentric Friction Spring Washer
201528E	11151	Feed Driving Eccentric Friction Spring Washer Screw Nut
200245D	11151	Feed Driving Eccentric Friction Spring Washer Screw
200244D	11151	Feed Driving Eccentric Fulcrum Screw
201528E	11151	Feed Driving Eccentric Fulcrum Screw Nut
213300	11152	Feed Driving Rock Shaft
213302	-----	" " " " 213300 with 200583H, 200935F, 201532E, 213295, 213296, 213298 and 213748
203244	11151	Feed Driving Rock Shaft Collar with two 200393c
200393c	11151	Feed Driving Rock Shaft Collar Set Screw
213354	11152	Feed Driving Rock Shaft Connection with 200054E and 202277 ..
213654	11151	Feed Driving Rock Shaft Connection Collar
200919c	11060	Feed Driving Rock Shaft Connection Hinge Screw
201522E	11151	Feed Driving Rock Shaft Connection Hinge Screw Nut
202277	-----	Feed Driving Rock Shaft Connection Oil Packing (wick)
200054E	11151	Feed Driving Rock Shaft Connection Pinch Screw
213301	11060	Feed Driving Rock Shaft Crank with 200050c
200050c	12487	Feed Driving Rock Shaft Crank Pinch Screw
213296	12487	Feed Lifting Cam with 200392c and 200447c
200447c	11151	Feed Lifting Cam Position Screw
213748	12487	" " " Retainer
200583H	11151	" " " " Screw ..

No.	Plate	Name
200392c	11061	Feed Lifting Cam Set Screw
213161	12487	" Regulating Lever with 213657
200665c	11151	" " " Hinge Screw
213656	11151	" " " Spring
213657	- -	" " " " Pin ..
227461	12490	Foot Lifter Lifting Lever
227789	-----	" " " " 227461 with 200262H
200262H	11060	Foot Lifter Lifting Lever Hinge Screw
221145	12487	Foot Lifter Lifting Lever Position Spring (right)
200835D	12487	Foot Lifter Lifting Lever Position Spring Screw
*203239	-----	Hook (sewing)
203240	11228	" 203239 with 201253F, 201376F and 203251
203290	11228	Hook and Bobbin Case complete, Nos. 203217 and 203240
203549	11254	Hook Bevel Gear Socket, 18 teeth
200556H	12487	" " " " Screw ..
213319	12487	" " Pinion with two 200386c
200386c	11151	" " " Set Screw
221171	12490	" Driving Shaft
213314	11150	" " " Bearing
202126	11151	" " " " Position Pin (2)
200516E	12311	Hook Driving Shaft Bearing Screw
213380	11151	" " " Bushing
200439c	12311	" " " " Position Screw
204246	12487	Hook Driving Shaft Collar (back) with two 200383c
200383c	12311	Hook Driving Shaft Collar (back) Set Screw
203244	11151	Hook Driving Shaft Collar (front) with two 200393c
200393c	11151	Hook Driving Shaft Collar (front) Set Screw
203251	11228	Hook Gib
201376F	12487	" " Hinge Screw
201253F	12487	" " Screw
203552	11254	" Saddle (right) with 202299 ..
202299	-----	" " Oil Packing (wick) ..
200541E	12487	" " Screw (2)
225837	11151	" " " Washer (2)
203254	11228	" Washer
203554	11254	Hook Saddle (right) complete, Nos. 200556H, 203254, 203290, 203549 and 203552

No.	Plate	Name
208613	----	Needle Bar (hollow)
204247	11152	" " 208613 with 200125F, 200175D and 204250
204248	12487	Needle Bar Connecting Link
200658c	12487	" " " " Hinge Screw Stud
201519c	----	Needle Bar Connecting Link Hinge Screw Stud Nut
204249	12487	Needle Bar Connecting Stud with 200072c and 202277
202277	----	Needle Bar Connecting Stud Oil Packing (wick)
200072c	11151	Needle Bar Connecting Stud Pinch Screw
204326	----	Needle Bar Packing Cord (2) ...
200504E	12487	" " Screw Bushing (lower)
200503B	12487	" " " " (upper)
204250	12487	" " Thread Guide
200175D	12487	" " " " Screw ..
200125F	12487	" Set Screw
204251	11152	Presser Bar (hollow) with 200074E
204252	10441	" " Lifter
200550c	12311	" " " Hinge Screw ...
204253	10441	" " Lifting Bracket with 200086c
200086c	10441	Presser Bar Lifting Bracket Pinch Screw
204254	10441	Presser Bar Lifting Bracket Posi- tion Guide
200362c	12311	Presser Bar Lifting Bracket Posi- tion Guide Set Screw
204327	----	Presser Bar Packing Washer (felt)
200504E	12487	" " Screw Bushing (lower)
204255	10441	" " Spring
200491B	10441	" " Thumb Screw (pres- sure regulating)
229851	12475	Presser Foot
200074E	10441	" " Screw
202068	12488	Spool Holder Base
200575H	12311	" " " Screw
204296	12488	" " Wire
200079H	12311	" " " Hinge Screw ...
204297	12488	Spool Holder complete, Nos. 200079H, 202068 and 204296
212920	----	Take-up Cam with 200335c and 200430c
203268	----	Take-up Cam 212920 with 200383c, 200658c and 201519c

No.	Plate	Name
203172	10445	Take-up Cam Friction Washer
200430c	12311	" " Position Screw
200383c	12311	" " " " Check Screw
200335c	12311	Take-up Cam Set Screw
204262	10445	" Lever
206556	---	" " 204262 with 204263...
204263	10445	" " Bearing with 204264...
204264	10445	" " Position Pin ...
200042F	12311	" " " Screw
201816	10445	" " Roller
204266	10445	Take-up Lever complete, Nos. 200042F, 201816 and 206556
202402	12309	Tension Disc
202090	12309	" " Position Pin
204267	12489	" Release Lever
200688c	12489	" " Position Screw
200309E	12309	" " " Screw
202075	12309	" " Plunger
215609	----	" " Slide
204268	12489	" " " 215609 with 204269
204269	12489	Tension Release Slide Spring
202407	10881	" Spring
200632B	12309	" Stud
200397H	12309	" " Set Screw
201572B	10881	" Thumb Nut
204271	12309	" Washer
204272	12309	Tension complete, Nos. 200632B, 201572B, 202075, 202407, 204271 and two 202402
204273	12489	Thread Controller Adjusting Col- lar with 200684H (for Presser Bar)
200684H	12489	Thread Controller Adjusting Col- lar Screw
204274	12309	Thread Controller Plate
200577H	12311	" " " Screw ...
202098	12309	" " Roller
204275	12309	" " " Guard
202084	12309	" " " " Washer
200300c	12309	" " " Screw
204276	12309	" " Spring
204333	12309	" " " Guard
200581H	12309	" " " " Screw
204277	12309	" " " Stop
204278	12309	" " " " Driving Gear
200319c	12309	Thread Controller Spring Stop Driving Gear Hinge Screw

No.	Plate	Name
200135c	12309	Thread Controller Spring Stop Screw
204279	12309	Thread Controller Spring Stud with 204925
200355u	12319	Thread Controller Spring Stud Set Screw
204925	12489	Thread Controller Spring Stud Washer
205987	12309	Thread Controller complete, Nos. 200300c, 200581u, 202084, 202098, 204274, 204275 and 204333
204280	12309	Thread Controller and Spring complete, Nos. 204276 and 205987..
202413	- -	Thread Guide
204281	12309	" Retainer Guide Wire
202091	12309	" " Sleeve
202092	12309	" " Spring
204058	12309	" " Stud
200368u	12309	" " " Set Screw
204059	12309	Thread Retainer complete, Nos. 202091, 202092 and 204058
212256	12491	Throat Plate, 50 needle hole, for needle sizes 14 and 15
200577u	12311	Throat Plate Screw (2)

MACHINE No. 47w101

DROP FEED. CYLINDER BED.

For Shirts, Underwear, etc.

The same as Machine No. 47w10 with the following exceptions:

No.	Plate	Name
*213361		Arm, in place of 213346
213341	11152	" Shaft, in place of 213423
213929		" " 213341 with 200244b, 200245b, 213349 to 213351, 213354, 213654, 213655 and two 201528e, in place of 213328
*213377		Bed (cylinder) with 200439c, 213314, 213380 and two 200516e, in place of 213369
213343	11152	Feed Driving Rock Shaft, in place of 213300
213356		Feed Driving Rock Shaft 213343 with 200583u, 200935e, 201532e, 213295, 213296, 213298 and 213748, in place of 213302
202781	12490	Foot Lifter Lifting Lever, in place of 227461
227306	-----	Foot Lifter Lifting Lever 202781 with 200262u, in place of 227789
221172	12490	Hook Driving Shaft, in place of 221171

ACCESSORIES

No.	Plate	Name
203208	11228	Bobbin (5)
*225482	-----	" Case Screw Driver Blade ..
*225483	-----	" " " " Handle ..
225497	11156	Bobbin Case Screw Driver complete, Nos. 225482 and 225483 ..
204033	11150	Wrench
128 x 3	---	Needles, three each, sizes 12 and 14
227104	-----	Drip Pan with one round head wood screw 1½ in., No. 14, R.H.B.
41401	11156	Machine Rest Pin (wood)
36578	11156	Oiler with 36579
36579	11156	" Spout, 3½ in. long, with 120117
120117	---	" " Washer
*225484	---	Screw Driver Blade
*225485	---	" " Handle
225498	11156	Screw Driver complete (7¼ in. long), Nos. 225484 and 225485 ..
225554	11156	Wrench (steel)

BOBBIN WINDER

Swing Automatic, Right Hand.

*225451	-----	Bobbin Holder
225453	10882	Frame with 202277 and 225438 ..
225454	10882	" Hinge Pin
202277	-----	" Oil Packing (wick)
225438	10882	" " Well Cap
225455	10882	" Spring
225456	10882	" " Plunger
202473	10883	Pulley with 200380c
200380c	12319	" Set Screw
*225443	-----	Spindle
225452	10882	" 225443 with 225451
225444	10882	Stop Latch
200056E	10882	" " Screw
225458	10882	" " Thumb Lever
225459	10882	" " " " Hinge Stud
225460	10882	" " " " Joint Stud
202478	10882	" " Trip Lever
200299H	10882	" " " " Hinge Screw
225461	10881	Tension Bracket with 201499n
200082D	10881	" " Screw

No.	Plate	Name
202104	10881	Tension Bracket Screw Washer ..
2102	10881	" Disc
202407	10881	" Spring
201499n	10881	" Stud
201572E	10881	" " Thumb Nut
225462	10881	Bobbin Winder Tension Bracket complete, Nos. 201572E, 202407, 225461 and two 2102
225463	10883	Bobbin Winder and Tension Bracket Base
225436	10883	Universal Bobbin Winder complete, Nos. 200056E, 200082D, 200299H, 202104, 202473, 202478, 225444, 225452 to 225456, 225458 to 225460, 225462, 225463 and two wood screws ¾ in., No. 13, R.H.B.

FOOT LIFTER

227952	11156	Foot Lifter Lever with 227954
227678	11156	" " Chain, 48 in. long, with 202784
227954	12492	Foot Lifter Lever Chain Hook (lower)
202784	12492	Foot Lifter Lever Chain Hook (upper)
225016	12492	Foot Lifter Lever Hinge Pin
227953	11156	" " " Stand with two wood screws 1 in., No. 13
227955	11156	Foot Lifter Lever complete, Nos. 225016, 227678, 227952 and 227953

(Other Foot Lifter parts are listed with parts of machine head).

FEED DOGS

No.	Plate	Name
212285	12491	Feed Dog, for 212286, 212287 and 221183
212258	12491	Feed Dog, for 212256 and 212257 ..
212281	12177	" " " 212279 and 212280 ..
212282	12177	" " " 212279 and 212280 ..
212290	12179	" " " 212288 and 212289 ..
212300	12180	" " " 212299
212220	12491	" " " 212291 to 212296
212221	12491	" " " 212291 to 212296
212298	12180	" " " 212297

PRESSER FEET

No.	Plate	Name
206785	10929	Presser Foot
206788	10929	" "
229851	12475	" "
229857	10929	" "
229858	10929	" "
229856	10929	" "
202418	10929	" "
206791	12475	" " for binding
229080	12489	" " " "
207175	12475	" " " " slippers ..
206794	10929	" " " tailoring work ..
206830	10929	" " " " " ..
206786	10929	" " (split)
202090	12309	" " Hinge Pin
203009	-----	" " Plate, for 229864 ..
203010	-----	" " " " 229863 ..
203011	-----	" " " " 229867 ..
203012	-----	" " " " 229868 ..
203024	-----	" " " " 229865 ..
203033	-----	" " " " 203153 ..
229055	-----	" " " " 202351 ..
202924	-----	" " Shank
202935	-----	" " " "
229864	10927	Presser Foot (hinged) complete, Nos. 202090, 202924 and 203009..
229863	10927	Presser Foot (hinged) complete, Nos. 202090, 202924 and 203010, for overalls and tailoring
229867	10927	Presser Foot (hinged) complete, Nos. 202090, 202924 and 203011, for overalls
229868	10927	Presser Foot (hinged) complete, Nos. 202090, 202924 and 203012..
229865	10927	Presser Foot (hinged) complete, Nos. 202090, 202924 and 203024, for tailoring
203153	10927	Presser Foot (hinged) complete, Nos. 202090, 202935 and 203033..
202351	10927	Presser Foot (hinged) complete, Nos. 202090, 202924 and 229055, for knit goods

THROAT PLATES

No.	Plate	Name
212256	12491	Throat Plate, 50 needle hole, for needle sizes 14 and 15, for 212258
212257	12491	Throat Plate, 46 needle hole, for needle sizes 16 and 18, for 212258
212279	12177	Throat Plate, 50 needle hole, for needle sizes 14 and 15, for 212281 and 212282
212280	12177	Throat Plate, 46 needle hole, for needle sizes 16 and 18, for 212281 and 212282
212288	12179	Throat Plate, 50 needle hole, for needle sizes 14 and 15, for 212290
212289	12179	Throat Plate, 46 needle hole, for needle sizes 16 and 18, for 212290
212299	12180	Throat Plate, 50 needle hole, for needle sizes 14 and 15, for 212300, for Machine No. 47w10
212291	12179	Throat Plate, 50 needle hole, for needle sizes 14 and 15, for 212220 and 212221
212292	12179	Throat Plate, 46 needle hole, for needle sizes 16 and 18, for 212220 and 212221
212293	12179	Throat Plate, 50 needle hole, for needle sizes 14 and 15, for 212220 and 212221
212294	12179	Throat Plate, 46 needle hole, for needle sizes 16 and 18, for 212220 and 212221
212295	12179	Throat Plate, 50 needle hole, for needle sizes 14 and 15, for 212220 and 212221
212296	12179	Throat Plate, 46 needle hole, for needle sizes 16 and 18, for 212220 and 212221
212297	12180	Throat Plate, 50 needle hole, for needle sizes 14 and 15, for 212298
221183	12491	Throat Plate, 50 needle hole, for needle sizes 14 and 15, for 212285

HEMMERS

HEMMER (Switch)

For Folds from $\frac{3}{8}$ to $1\frac{1}{2}$ inches.

No.	Plate	Name
230288	----	Arm Hemmer on Shank
225689	12479	" " Clamp Washer
200160B	12492	" " Screw
226203	12479	" " Switch-up with 226206
230289	12479	" " " Bracket
200268B	12492	" " " " Screw ..
201531E	12492	" " " " " Nut
226205	12492	" " " Latch
200305B	12492	" " " " Screw ..
204389	12492	" " " " Spring..
226206	12492	" " " " " Pin
200355C	12319	" " " Stop Screw ...
201537E	12319	" " " " " Nut
230290	12479	Arm Hemmer (upper curl) and Arm Bracket complete, Nos. 200268B, 200305B, 200355C, 201531E, 201537E, 204389, 225689, 226203, 226205, 230288, 230289 and two 200160B
230861	----	Hemmer on Shank
225689	12479	" " Clamp Washer
200184B	12492	" " Screw
229987	12488	" " Swing Base
200925B	12492	" " " Hinge Screw
201525E	11151	" " " " " Nut
230294	12492	Hemmer Swing Base Hinge Screw Washer (lower)
230293	12492	Hemmer Swing Base Hinge Screw Washer (upper)
230862	----	Hemmer (lower curl) (adjustable) on Base Plate complete, Nos. 200925B, 201525E, 225689, 229987, 230293, 230294, 230861 and two 200184B
230648	12492	Plate Slide Side Plate with two 200137D
230649	12492	Plate Slide Side Plate Catch Plate
200137D	12492	" " " " " " " Screw

No.	Plate	Name
230388	---	Hemmer Combination complete, Nos. 230290, 230648, 230649 and 230862

HEMMER

For Folds from $\frac{1}{2}$ to $1\frac{1}{2}$ inches.

225787	---	Hemmer on Shank
200460B	12479	" Adjusting Thumb Screw
228043	12479	" " " "
		Washer
229987	12488	Hemmer Base Plate
200160B	12492	" " " Screw
230421	---	" Bed Plate with 200460B and 228043
200925B	12492	Hemmer Bed Plate Hinge Screw
201525E	11151	" " " " "
		Nut
226663	12492	Hemmer Plate (Clamp Washer
230294	12492	" Swing Base Hinge Screw Washer (lower)
230293	12492	Hemmer Swing Base Hinge Screw Washer (upper)
229988	---	Base Plate complete, Nos. 200925B, 201525E, 226663, 229987, 230293, 230294 and two 200160B
229989	12488	Hemmer complete, Nos. 225787, 229988 and 230421

WORK PLATE PLATFORMS

No.	Plate	Name
214013	11163	Work Plate
200990C	12489	" " Screw
201518E	11151	" " " Nut
221106	11163	" " Slide (back)
215684	11163	" " " (back or front)
215682	11163	" " Yoke with 200729A ..
200729A	12489	" " " Screw
215683	---	Work Plate complete, Nos. 214013, 215682, 215684, 221106, four 200990C and eight 201518E, for crescent or semi-flat Throat Plate
215685	---	Work Plate complete, Nos. 214013, 215682, two 215684, four 200990C and eight 201518E, for Platform Throat Plate

OBSOLETE PARTS

No.	Plate	Name
202470	12320	Bobbin Winder Base
202471	12320	" " Frame
202472	12319	" " Spring
202480	12320	" " Spool Holder Base with 200355n and 202484
202481	12320	Bobbin Winder Spool Holder Base Spool Pin
202482	12319	Bobbin Winder Spool Holder Ten- sion Disc (lower or upper)
202483	12319	Bobbin Winder Spool Holder Ten- sion Disc Spring (brass)
202484	12319	Bobbin Winder Spool Holder Ten- sion Thread Guide, for 202480 ..
202485	12320	Bobbin Winder Spool Holder com- plete, Nos. 200011r, 202480, 202481, 202483, two 202482 and one wood screw 1 in., No. 13 ..
202474	12320	Bobbin Winder Spindle
227522	12319	" " Stop Latch
202477	12319	" " " " Thumb Lever
227523	12320	Bobbin Winder complete, Nos. 200056e, 200161b, 200221b, 201537n, 202470 to 202474, 202477, 202478, 227522, three 200299n and two round head wood screws 1 in., No. 13
212278	12177	Feed Dog, for 212276 and 212277..
212276	12177	Throat Plate, 50 needle hole, for needle sizes 14 and 15, for 212278
212277	12177	Throat Plate, 46 needle hole, for needle sizes 16 and 18, for 212278
212286	12491	Throat Plate, 50 needle hole, for needle sizes 14 and 15, for 212285
212287	12491	Throat Plate, 46 needle hole, for needle sizes 16 and 18, for 212285

NUMERICAL LIST OF PARTS

FOR

MACHINES

Nos. 47w10 and 47w101

NUMERICAL LIST OF PARTS

No.	Plate	Name
2102	10881	Bobbin Winder Tension Disc, for 225462
36578	11156	Oiler with 36579
36579	11156	" Spout, 3½ in. long, with 120117, for 36578
41401	11156	Machine Rest Pin (wood)
120117	-----	Oiler Spout Washer, for 36579 ...
200011E	12319	Bobbin Winder Spool Holder Ten- sion Disc Screw, for 202485
200030H	12487	Bed Hinge Screw
200042F	12311	Take-up Lever Bearing Screw, for 204266
200050C	12487	Feed Driving Rock Shaft Crank Pinch Screw, for 213301
200053C	12311	Face Plate Screw
200054E	11151	Arm Shaft Connection Screw, for 204804
200054E	11151	Feed Driving Rock Shaft Connec- tion Pinch Screw, for 213354 ...
200056E	10882	Bobbin Winder Stop Latch Screw, for 225436 and 227523
200062H	12311	Balance Wheel Adjusting Screw...
200072C	11151	Feed Bar Connecting Link Pinch Screw, for 213298
200072C	11151	Needle Bar Connecting Stud Pinch Screw, for 204249
200074F	10141	Presser Foot Screw, for 204251 ..
200079H	12311	Spool Holder Wire Hinge Screw, for 204297
200082D	10881	Bobbin Winder Tension Bracket Screw, for 225436
200086C	10441	Presser Bar Lifting Bracket Pinch Screw, for 204253
200125F	12487	Needle Set Screw, for 204247
200135C	12309	Thread Controller Spring Stop Screw, for 204186
200137D	12492	Hemmer Plate Slide Side Plate Catch Plate Screw, for 230648 ..
200160B	12492	Hemmer Base Plate Screw, for 229988
200160R	12492	Arm Hemmer Screw, for 230290..
200161D	12319	Bobbin Winder Frame Spring Screw, for 227523

No.	Plate	Name
200175D	12487	Needle Bar Thread Guide Screw, for 204247
200184B	12492	Hemmer Screw, for 230862
200221D	12319	Bobbin Winder Frame Hinge Screw, for 227523
200244D	11151	Feed Driving Eccentric Fulcrum Screw, for 213328 and 213929 ..
200245D	11151	Feed Driving Eccentric Friction Spring Washer Screw, for 213328 and 213929
200262H	11060	Bed Clamp Hinge Screw
200262H	11060	Foot Lifter Lifting Lever Hinge Screw, for 227306 and 227789 ..
200268B	12492	Arm Hemmer Switch-up Bracket Screw, for 230290
200278H	12311	Arm Cap Screw
200299H	10882	Bobbin Winder Stop Latch Thumb Lever Hinge Screw, for 227523 ..
200299H	10882	Bobbin Winder Stop Latch Thumb Lever Joint Screw, for 227523 ..
200299H	10882	Bobbin Winder Stop Latch Trip Lever Hinge Screw, for 225436 and 227523
200300C	12309	Thread Controller Roller Screw, for 205987
200305B	12492	Arm Hemmer Switch-up Latch Screw, for 230290
200309E	12309	Tension Release Lever Screw, for 204186
200319C	12309	Thread Controller Spring Stop Driving Gear Hinge Screw, for 204186
200328C	12311	Balance Wheel Position Screw, for 204805
200335C	12311	Balance Wheel Set Screw, for 204805
200335C	12311	Take-up Cam Set Screw, for 212920
200338C	11151	Arm Shaft Bushing (back) Set Screw
200341C	11151	Arm Shaft Bushing (center) Set Screw
200352C	11151	Arm Shaft Bushing (front) Set Screw
200355C	12319	Arm Hemmer Switch-up Stop Screw, for 230290
200355C	12319	Bobbin Winder Spool Holder Tension Disc Screw Set Screw, for 202480
200355H	12319	Thread Controller Spring Stud Set Screw, for 204184

No.	Plate	Name
200362C	12311	Presser Bar Lifting Bracket Position Guide Set Screw
200368H	12309	Thread Retainer Stud Set Screw, for 204184
200378C	12311	Feed Driving Eccentric Flange Set Screw, for 213351
200380C	12319	Bobbin Winder Pulley Set Screw, for 202473
200383C	12311	Hook Driving Shaft Collar (back) Set Screw, for 204246
200383C	12311	Take-up Cam Position Screw Check Screw, for 203268
200386C	11151	Hook Bevel Pinion Set Screw, for 213319
200392C	11061	Feed Lifting Cam Set Screw, for 213296
200393C	11151	Feed Driving Rock Shaft Collar Set Screw, for 203244
200393C	11151	Hook Driving Shaft Collar (front) Set Screw, for 203244
200397H	12309	Face Plate Thread Guide Set Screw, for 204184
200397H	12309	Tension Stud Set Screw, for 204184
200430C	12311	Take-up Cam Position Screw, for 212920
200437C	12311	Feed Driving Eccentric Flange Position Screw, for 213351
200439C	12311	Hook Driving Shaft Bushing Position Screw, for 213369 and 213377
200447C	11151	Feed Lifting Cam Position Screw, for 213296
200460A	12479	Hemmer Adjusting Thumb Screw, for 230421
200491B	10441	Presser Bar Thumb Screw (pressure regulating)
200502B	11151	Arm Shaft Bushing (front) Oil Packing Thumb Screw
200503B	12487	Needle Bar Screw Bushing (upper)
200504E	12487	" " " " (lower) ..
200504E	12487	Presser Bar Screw Bushing (lower)
200516E	12311	Hook Driving Shaft Bearing Screw, for 213369 and 213377
200541E	12487	Hook Saddle Screw
200544E	11061	Feed Dog Screw, for 213295
200550C	12311	Presser Bar Lifter Hinge Screw ..
200556H	12487	Hook Bevel Gear Socket Screw, for 203554

28

Numerical List of Parts

No.	Plate	Name
200574b	11061	Bed (cylinder) Cap Screw
200575H	12311	Spool Holder Base Screw
200577H	12311	Thread Controller Plate Screw, for 204186
200577H	12311	Throat Plate Screw
200581H	12309	Thread Controller Spring Guard Screw, for 205987
200582H	11151	Bed Slide Clamp Plate Screw
200583H	11151	Feed Lifting Cam Retainer Screw, for 213302 and 213356
200594c	11228	Bobbin Case Tension Spring Screw, for 203209
200594c	11228	Bobbin Case Thread Guide Screw, for 203209
200632B	12309	Tension Stud, for 204272
200658c	12487	Needle Bar Connecting Link Hinge Screw Stud, for 203268
200665c	11151	Feed Regulating Lever Hinge Screw
200684H	12489	Thread Controller Adjusting Collar Screw, for 204273
200688c	12489	Tension Release Lever Position Screw, for 204184
200728B	11060	Bed Clamp Thumb Screw
200729A	12489	Work Plate Yoke Screw, for 215682
200835b	12487	Foot Lifter Lifting Lever Position Spring Screw
200919c	11060	Feed Driving Rock Shaft Con- nection Hinge Screw
200925B	12492	Hemmer Bed Plate Hinge Screw, for 229988
200925B	12492	Hemmer Swing Base Hinge Screw, for 230862
200935F	11151	Feed Bar Connecting Link Screw Stud, for 213302 and 213356
200963E	12311	Arm Screw
200984c	11151	Bobbin Case Tension Spring Regu- lating Screw, for 203209
200990c	12489	Work Plate Screw, for 215683 and 215685
201253F	12487	Hook Gib Screw, for 203240
201376F	12487	" " Hinge Screw, for 203240
201499B	10881	Bobbin Winder Tension Stud, for 225461
201518E	11151	Work Plate Screw Nut, for 215683 and 215685
201519c	---	Needle Bar Connecting Hinge Screw Stud Nut, for 203268
201522E	11151	Feed Driving Rock Shaft Con- nection Hinge Screw Nut

No.	Plate	Name
201525E	11151	Hemmer Bed Plate Hinge Screw Nut, for 229988
201525E	11151	Hemmer Swing Base Hinge Screw Nut, for 230862
201528E	11151	Feed Driving Eccentric Friction Spring Washer Screw Nut, for 213328 and 213929
201528E	11151	Feed Driving Eccentric Eulerum Screw Nut
201531E	12492	Arm Hemmer Switch-up Bracket Screw Nut, for 230290
201532E	11151	Feed Bar Connecting Link Screw Stud Nut, for 213302 and 213356
201537E	12319	Arm Hemmer Switch-up Stop Screw Nut, for 230290
201537E	12319	Bobbin Winder Stop Latch Thumb Lever Joint Screw Nut, for 227523
201572B	10881	Bobbin Winder Tension Stud Thumb Nut, for 225462
201572B	10881	Tension Thumb Nut, for 204272 ..
201816	10445	Take-up Lever Roller, for 204266..
202005	11151	Arm Screw Washer
202036	12487	" Shaft Bushing (front) Posi- tion Pin, for 213781
*202056	---	Bobbin Case Base Latch Pin, for 203210
202068	12488	Spool Holder Base, for 204297
202075	12309	Tension Release Plunger, for 204272
202084	12309	Thread Controller Roller Guard Washer, for 205987
202090	12309	Presser Foot Hinge Pin, for 202351, 203153, 229863 to 229865, 229867 and 229868
202090	12309	Tension Disc Position Pin, for 204184
202091	12309	Thread Retainer Sleeve, for 204059
202092	12309	" " Spring, for 204059 ..
202098	12309	" Controller Roller, for 205987
202104	10881	Bobbin Winder Tension Bracket Screw Washer, for 225436
202126	11151	Hook Driving Shaft Bearing Posi- tion Pin
202248	11151	Arm Cap Screw Washer
202260	---	" Shaft Bushing (back) Oil Packing (wick), for 204801
202260	---	Arm Shaft Bushing (center) Oil Packing (wick), for 213299
202260	---	Arm Shaft Bushing (front) Oil Packing (wick), for 213781

No.	Plate	Name
202277	—	Bobbin Winder Frame Oil Packing (wick), for 225453
202277	—	Feed Driving Rock Shaft Connection Oil Packing (wick), for 213354
202277	—	Needle Bar Connecting Stud Oil Packing (wick), for 204249
202299	—	Hook Saddle Oil Packing (wick), for 203552
202351	10927	Presser Foot (hinged) complete, Nos. 202090, 202924 and 229055, for knit goods
202402	12309	Tension Disc, for 204272
202407	10881	Bobbin Winder Spring, for 225462
202407	10881	Tension Spring, for 204272
202413	—	Thread Guide
202418	10929	Presser Foot
Nos. 202470 to 202472 (obsolete), for 227523.		
202470	12320	Bobbin Winder Base
202471	12320	" " Frame
202472	12319	" " Spring
202473	10883	" " Pulley with 200380c, for 225436 and 227523
202474	12320	Bobbin Winder Spindle (obsolete), for 227523
202477	12319	Bobbin Winder Stop Latch Thumb Lever (obsolete), for 227523
202478	10882	Bobbin Winder Stop Latch Trip Lever, for 225436 and 227523
Nos. 202480 to 202483 (obsolete), for 202485.		
202480	12320	Bobbin Winder Spool Holder Base with 200355u and 202484
202481	12320	Bobbin Winder Spool Holder Base Spool Pin
202482	12319	Bobbin Winder Spool Holder Tension Disc (lower or upper)
202483	12319	Bobbin Winder Spool Holder Tension Disc Spring (brass)
202484	12319	Bobbin Winder Spool Holder Tension Thread Guide (obsolete), for 202480
202485	12320	Bobbin Winder Spool Holder complete, Nos. 200011e, 202480, 202481, 202483, two 202482 and one wood screw 1 in., No. 13 (obsolete)

No.	Plate	Name
202618	12490	Bed Hinge
202622	11151	" Clamp Packing Washer
202781	12490	Foot Lifter Lifting Lever, for 227306
202784	12492	Foot Lifter Lever Chain Hook (upper), for 227678
202924	—	Presser Foot Shank, for 202351, 229863 to 229865, 229867 and 229868
202935	—	Presser Foot Shank, for 203153
203009	—	" " Plate, for 229864
203010	—	" " " " 229863
203011	—	" " " " 229867
203012	—	" " " " 229868
203024	—	" " " " 229865
203033	—	" " " " 203153
203153	10927	Presser Foot (hinged) complete, Nos. 202090, 202935 and 203033
203172	10445	Take-up Cam Friction Washer
203184	11060	Bed Clamp
203185	11060	" " Washer
203208	11228	Bobbin
203209	11228	" Case Cap with 200984c, 203214, 203215 and two 200594c, for 203217
203210	11228	Bobbin Case Base with 202056, 203211 to 203213 and 203216, for 203217
Nos. 203211 to 203213, for 203210.		
203211	11151	Bobbin Case Base Latch
203212	11151	" " " " Plunger
203213	11151	" " " " Spring
203214	11228	" " Tension Spring, for 203209
203215	11228	Bobbin Case Thread Guide, for 203209
203216	11228	Bobbin Case Washer (cloth), for 203210
203217	11228	Bobbin Case complete, Nos. 203209 and 203210, for 203290
*203239	—	Hook (sewing), for 203240
203240	11228	" 203239 with 201253e, 201376e and 203251, for 203290
203244	11151	Feed Driving Rock Shaft Collar with two 200393c
203244	11151	Hook Driving Shaft Collar (front) with two 200393c
203251	11228	Hook Gib, for 203240

No.	Plate	Name
203254	11228	Hook Washer, for 203554
203268	-----	Take-up Cam 212920 with 200383c, 200658c and 201519c
203290	11228	Hook and Bobbin Case complete, Nos. 203217 and 203240, for 203554
203549	11254	Hook Bevel Gear Socket, 18 teeth, for 203554
203552	11254	Hook Saddle (right) with 202299, for 203554
203554	11254	Hook Saddle (right) complete, Nos. 200556n, 203254, 203290, 203549 and 203552
204033	11150	Wrench
204058	12309	Thread Retainer Stud, for 204059
204059	12309	Thread Retainer complete, Nos. 202091, 202092 and 204058, for 204186
204184	---	Face Plate with 200355n, 200368n, 200688c, 202090, 204185, 204281 and two 200397n, for 204186 ..
204185	11151	Face Plate Thread Guide, for 204184
204186	-----	Face Plate complete, Nos. 200135c, 200309e, 200319c, 200577n, 204059, 204184, 204267, 204272 and 204277 to 204280
204235	12487	Arm Position Pin
204246	12487	Hook Driving Shaft Collar (back) with two 200383c
204247	11152	Needle Bar 208613 with 200125f, 200175d and 204250
204248	12487	Needle Bar Connecting Link
204249	12487	" " " Stud with 200072c and 202277
204250	12487	Needle Bar Thread Guide, for 204247
204251	11152	Presser Bar (hollow) with 200074f
204252	10441	" " Lifter
204253	10441	" " Lifting Bracket with 200086c
204254	10441	Presser Bar Lifting Bracket Posi- tion Guide
204255	10441	Presser Bar Spring
204262	10445	Take-up Lever, for 206556
204263	10445	" " Bearing with 204264, for 206556
204264	10445	Take-up Lever Bearing Position Pin, for 204263

No.	Plate	Name
204266	10445	Take-up Lever complete, Nos. 200042f, 201816 and 206556
204267	12489	Tension Release Lever, for 204186
204268	12489	" " Slide 215609 with 201269
204269	12489	Tension Release Slide Spring, for 204268
204271	12309	Tension Washer, for 204272
204272	12309	Tension complete, Nos. 200632n, 201572n, 202075, 202407, 204271 and two 202402, for 204186
204273	12489	Thread Controller Adjusting Collar with 200684n (for Presser Bar)
204274	12309	Thread Controller Plate, for 205987
204275	12309	" " Roller Guard, for 205987
204276	12309	Thread Controller Spring, for 204280
		Nos. 204277 to 204280, for 204186.
204277	12309	Thread Controller Spring Stop
204278	12309	" " " " Driv- ing Gear
204279	12309	Thread Controller Spring Stud with 204925
204280	12309	Thread Controller and Spring com- plete, Nos. 204276 and 205987..
204281	12309	Thread Retainer Guide Wire, for 204184
204296	12488	Spool Holder Wire, for 204297 ...
204297	12488	Spool Holder complete, Nos. 200079n, 202068 and 204296
204326	-----	Needle Bar Packing Cord
204327	---	Presser Bar Packing Washer (felt)
204333	12309	Thread Controller Spring Guard, for 205987
204389	12492	Arm Hemmer Switch-up Latch Spring, for 230290
204801	11150	Arm Shaft Bushing (back) with 202260
204804	11152	Arm Shaft Connection with four 200054e
204805	12490	Balance Wheel, 5½ in. diam. (belt groove 2¼ in. diam.), with 200328c and 200335c
204925	12489	Thread Controller Spring Stud Washer, for 204279

No.	Plate	Name
205987	12309	Thread Controller complete, Nos. 200300c, 200581H, 202084, 202098, 204274, 204275 and 204333, for 204280
206556	---	Take-up Lever 204262 with 204263, for 204266
206785	10929	Presser Foot
206786	10929	" " (split)
206788	10929	" "
206791	12475	" " for binding
206794	10929	" " " tailoring work ..
206830	10929	" " " " " " ..
207175	12475	" " " binding slippers ..
208613	---	Needle Bar (hollow), for 204247 ..
212220	12491	Feed Dog, for 212291 to 212296 ..
212221	12491	" " " 212291 to 212296 ..
212256	12491	Throat Plate, 50 needle hole, for needle sizes 14 and 15, for 212258 ..
212257	12491	Throat Plate, 46 needle hole, for needle sizes 16 and 18, for 212258 ..
212258	12491	Feed Dog, for 212256 and 212257 ..
		Nos. 212276 to 212278 (obsolete).
212276	12177	Throat Plate, 50 needle hole, for needle sizes 14 and 15, for 212278 ..
212277	12177	Throat Plate, 46 needle hole, for needle sizes 16 and 18, for 212278 ..
212278	12177	Feed Dog, for 212276 and 212277 ..
212279	12177	Throat Plate, 50 needle hole, for needle sizes 14 and 15, for 212281 and 212282
212280	12177	Throat Plate, 46 needle hole, for needle sizes 16 and 18, for 212281 and 212282
212281	12177	Feed Dog, for 212279 and 212280 ..
212282	12177	" " " 212279 and 212280 ..
212285	12491	" " " 212286, 212287 and 221183
212286	12491	Throat Plate, 50 needle hole, for needle sizes 14 and 15 (obsolete), for 212285
212287	12491	Throat Plate, 46 needle hole, for needle sizes 16 and 18 (obsolete), for 212285
212288	12179	Throat Plate, 50 needle hole, for needle sizes 14 and 15, for 212290 ..
212289	12179	Throat Plate, 46 needle hole, for needle sizes 16 and 18, for 212290 ..
212290	12179	Feed Dog, for 212288 and 212289 ..

No.	Plate	Name
212291	12179	Throat Plate, 50 needle hole, for needle sizes 14 and 15, for 212220 and 212221
212292	12179	Throat Plate, 46 needle hole, for needle sizes 16 and 18, for 212220 and 212221
212293	12179	Throat Plate, 50 needle hole, for needle sizes 14 and 15, for 212220 and 212221
212294	12179	Throat Plate, 46 needle hole, for needle sizes 16 and 18, for 212220 and 212221
212295	12179	Throat Plate, 50 needle hole, for needle sizes 14 and 15, for 212220 and 212221
212296	12179	Throat Plate, 46 needle hole, for needle sizes 16 and 18, for 212220 and 212221
212297	12180	Throat Plate, 50 needle hole, for needle sizes 14 and 15, for 212298 ..
212298	12180	Feed Dog, for 212297
212299	12180	Throat Plate, 50 needle hole, for needle sizes 14 and 15, for 212300, for Machine No. 47w10
212300	12180	Feed Dog, for 212299
212920	---	Take-up Cam with 200335c and 200430c, for 203268
213144	11150	Arm Cap
213164	12487	Feed Regulating Lever with 213657 ..
213295	11060	Feed Bar with 200544e and 213610, for 213302 and 213356
213296	12487	Feed Lifting Cam with 200392c and 200447c, for 213302 and 213356 ..
213298	11061	Feed Bar Connecting Link with two 200072c, for 213302 and 213356 ..
213299	11150	Arm Shaft Bushing (center) with 202260
213300	11152	Feed Driving Rock Shaft, for 213302
213301	11060	Feed Driving Rock Shaft Crank with 200050c
213302	---	Feed Driving Rock Shaft 213300 with 200583H, 200935E, 201532E, 213295, 213296, 213298 and 213748, for Machine No. 47w10
213314	11150	Hook Driving Shaft Bearing, for 213369 and 213377
213319	12487	Hook Bevel Pinion with two 200386c

Numerical List of Parts

No.	Plate	Name
213328	---	Arm Shaft 213423 with 200244d, 200245d, 213349 to 213351, 213354, 213654, 213655 and two 201528e, for Machine No. 47w10
213338	11150	Bed Slide (back)
213341	11152	Arm Shaft, for 213929
213343	11152	Feed Driving Rock Shaft, for 213356
*213346	---	Arm, for Machine No. 47w10
Nos. 213349 to 213351, for 213328 and 213929.		
213349	12488	Feed Driving Eccentric (adjustable)
213350	12488	Feed Driving Eccentric Adjusting Disc
213351	12488	Feed Driving Eccentric Flange with 200378c and 200437c
213353	---	Bed Base (high)
213354	11152	Feed Driving Rock Shaft Connection with 200054e and 202277, for 213328 and 213929
213356	---	Feed Driving Rock Shaft 213343 with 200583h, 200935e, 201532e, 213295, 213296, 213298 and 213748, for Machine No. 47w101
*213361	---	Arm, for Machine No. 47w101
*213369	---	Bed (cylinder) with 200439c, 213314, 213380 and two 200516e, for Machine No. 47w10
*213377	---	Bed (cylinder) with 200439c, 213314, 213380 and two 200516e, for Machine No. 47w101
213380	11151	Hook Driving Shaft Bushing, for 213369 and 213377
213423	11152	Arm Shaft, for 213328
213610	11151	Feed Bar Connecting Link Stud, for 213295
213654	11151	Feed Driving Rock Shaft Connection Collar, for 213328 and 213929
213655	11151	Feed Driving Eccentric Friction Spring Washer, for 213328 and 213929
213656	11151	Feed Regulating Lever Spring
213657	----	" " " " Pin, for 213161
213685	11061	Bed Slide Clamp Plate
213686	11061	" " " "
213748	12487	Feed Lifting Cam Retainer, for 213302 and 213356

Numerical List of Parts

No.	Plate	Name
213781	12488	Arm Shaft Bushing (front) with 202036 and 202260
213786	11150	Bed (cylinder) Cap
213787	11150	" " End Cover
213890	---	" Base (low)
213929	---	Arm Shaft 213341 with 200244d, 200245d, 213349 to 213351, 213354, 213654, 213655 and two 201528e, for Machine No. 47w101
214013	11163	Work Plate, for 215683 and 215685
215609	---	Tension Release Slide, for 204268
215682	11163	Work Plate Yoke with 200729A, for 215683 and 215685
215683	----	Work Plate complete, Nos. 214013, 215682, 215684, 221106, four 200990c and eight 201518e, for crescent or semi-flat Throat Plate
215684	11163	Work Plate Slide (back or front), for 215683 and 215685
215685	---	Work Plate complete, Nos. 214013, 215682, two 215684, four 200990c and eight 201518e, for Platform Throat Plate
221106	11163	Work Plate Slide (back), for 215683
221145	12487	Foot Lifter Lifting Lever Position Spring (right)
221171	12490	Hook Driving Shaft, for Machine No. 47w10
221172	12490	Hook Driving Shaft, for Machine No. 47w101
221183	12491	Throat Plate, 50 needle hole, for needle sizes 14 and 15, for 212285
225016	12492	Foot Lifter Lever Hinge Pin, for 227955
225436	10883	Universal Bobbin Winder complete, Nos. 200056e, 200082b, 200299h, 202104, 202473, 202478, 225444, 225452 to 225456, 225458 to 225460, 225462, 225463 and two wood screws $\frac{3}{4}$ in., No. 13, R.H.B.
225438	10882	Bobbin Winder Frame Oil Well Cap, for 225453
*225443	---	Bobbin Winder Spindle, for 225452
225444	10882	" " Stop Latch, for 225436
*225451	----	Bobbin Winder Bobbin Holder, for 225452

Numerical List of Parts

No.	Plate	Name
		Nos. 225452 to 225456, for 225436.
225452	10882	Bobbin Winder Spindle 225443 with 225451
225453	10882	Bobbin Winder Frame with 202277 and 225438
225454	10882	Bobbin Winder Frame Hinge Pin..
225455	10882	" " " Spring
225456	10882	" " " " Plunger
		Nos. 225458 to 225460, for 225436.
225458	10882	Bobbin Winder Stop Latch Thumb Lever
225459	10882	Bobbin Winder Stop Latch Thumb Lever Hinge Stud
225460	10882	Bobbin Winder Stop Latch Thumb Lever Joint Stud
225461	10881	Bobbin Winder Tension Bracket with 201499b, for 225462
225462	10881	Bobbin Winder Tension Bracket complete, Nos. 201572b, 202407, 225461 and two 2102, for 225436
225463	10883	Bobbin Winder and Tension Bracket Base, for 225436
*225482	---	Bobbin Case Screw Driver Blade, for 225497
*225483	---	Bobbin Case Screw Driver Handle, for 225497
*225484	---	Screw Driver Blade, for 225498 ..
*225485	---	" " Handle, for 225498 ..
225497	11156	Bobbin Case Screw Driver complete, Nos. 225482 and 225483 ..
225498	11156	Screw Driver complete (7½ in. long), Nos. 225484 and 225485 ..
225554	11156	Wrench (steel)
225689	12479	Hemmer Clamp Washer, for 230862
225689	12479	Arm Hemmer Clamp Washer, for 230290
225787	---	Hemmer on Shank, for 229989
225837	11151	Hook Saddle Screw Washer
226203	12479	Arm Hemmer Switch-up with 226206, for 230290
226205	12492	Arm Hemmer Switch-up Latch, for 230290
226206	12492	Arm Hemmer Switch-up Latch Spring Pin, for 226203
226663	12492	Hemmer Plate Clamp Washer, for 229988
227104	---	Drip Pan with one round head wood screw 1½ in., No. 14, R.H.B. ..

Numerical List of Parts

No.	Plate	Name
227306	---	Foot Lifter Lifting Lever 202781 with 200262n, for Machine No. 47w101
227461	12490	Foot Lifter Lifting Lever, for 227789
227522	12319	Bobbin Winder Stop Latch (obsolete), for 227523
227523	12320	Bobbin Winder complete, Nos. 200056e, 200161b, 200221b, 201537n, 202470 to 202474, 202477, 202478, 227522, three 200299n and two round head wood screws 1 in., No. 13 (obsolete)
227678	11156	Foot Lifter Lever Chain, 48 in. long, with 202784, for 227955 ..
227789	---	Foot Lifter Lifting Lever 227461 with 200262n, for Machine No. 47w10
227952	11156	Foot Lifter Lever with 227954, for 227955
227953	11156	Foot Lifter Lever Stand with two wood screws 1 in., No. 13, for 227955
227954	12492	Foot Lifter Lever Chain Hook (lower), for 227952
227955	11156	Foot Lifter Lever complete, Nos. 225016, 227678, 227952 and 227953
228043	12479	Hemmer Adjusting Thumb Screw Washer, for 230421
229055	---	Presser Foot Plate, for 202351
229080	12489	" " for binding
229851	12475	" "
229856	10929	" "
229857	10929	" "
229858	10929	" "
229863	10927	Presser Foot (hinged) complete, Nos. 202090, 202924 and 203010, for overalls and tailoring
229864	10927	Presser Foot (hinged) complete, Nos. 202090, 202924 and 203009..
229865	10927	Presser Foot (hinged) complete, Nos. 202090, 202924 and 203024, for tailoring
229867	10927	Presser Foot (hinged) complete, Nos. 202090, 202924 and 203011, for overalls
229868	10927	Presser Foot (hinged) complete, Nos. 202090, 202924 and 203012..
229987	12488	Hemmer Base Plate, for 229988 ..
229987	12488	" Swing Base, for 230862 ..

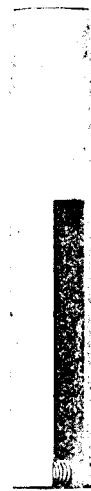
Numerical List of Parts

No.	Plate	Name
229988	----	Base Plate complete, Nos. 200925b, 201525e, 226663, 229987, 230293, 230294 and two 200160b, for 229989
229989	12488	Hemmer complete, Nos. 225787, 229988 and 230421
230288	----	Arm Hemmer on Shank, for 230290
230289	12479	" " Switch-up Bracket, for 230290
230290	12479	Arm Hemmer (upper curl) and Arm Bracket complete, Nos. 200268b, 200305b, 200355c, 201531e, 201537e, 204389, 225689, 226203, 226205, 230288, 230289 and two 200160b, for 230388
230293	12492	Hemmer Swing Base Hinge Screw Washer (upper), for 229988 and 230862
230294	12492	Hemmer Swing Base Hinge Screw Washer (lower), for 229988 and 230862
230388	----	Hemmer Combination complete, Nos. 230290, 230648, 230649 and 230862
230421	---	Hemmer Bed Plate with 200460b and 228043, for 229989
230648	12492	Plate Slide Side Plate with two 200137b, for 230388
230649	12492	Plate Slide Side Plate Catch Plate, for 230388
230861	----	Hemmer on Shank, for 230862
230862	----	Hemmer (lower curl) (adjustable) on Base Plate complete, Nos. 200925b, 201525e, 225689, 229987, 230293, 230294, 230861 and two 200184b, for 230388

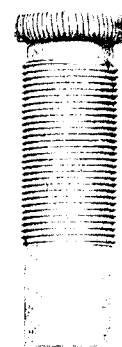
**ILLUSTRATIONS OF PARTS
FOR
MACHINES
Nos. 47w10 and 47w101**

PLATE 10441—FULL SIZE

204254



200491



204252



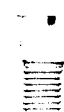
200336



204253



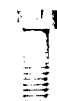
200550



204255



200074



200086



200362



PLATE 10445—FULL SIZE

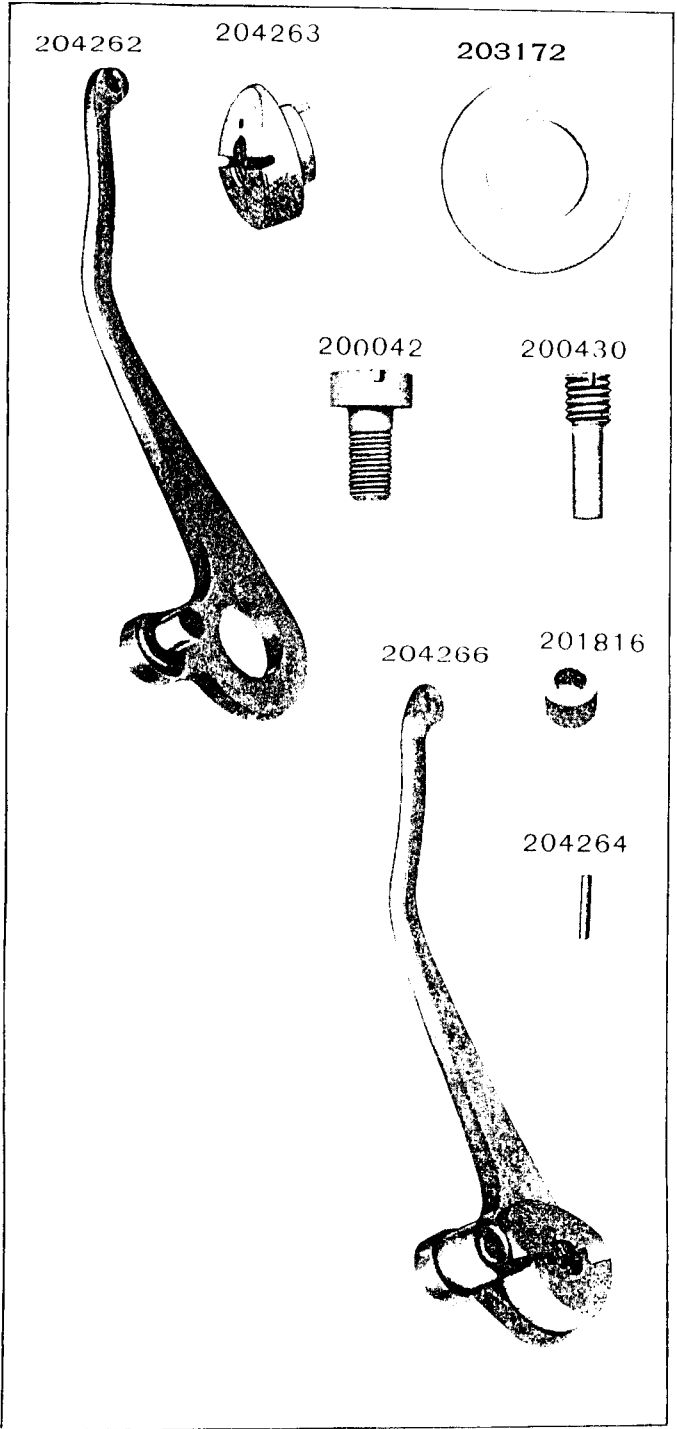


PLATE 10881—FULL SIZE

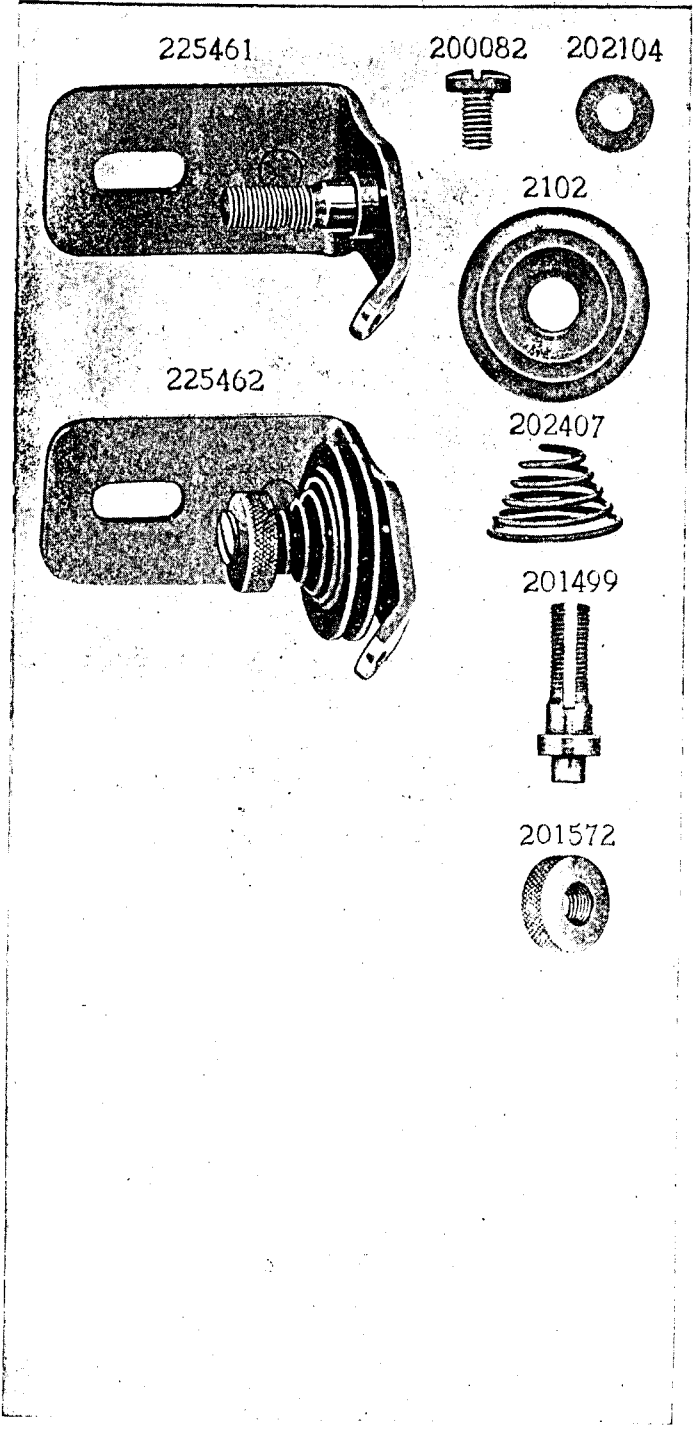


PLATE 10882—FULL SIZE

225453



225455



225438



225457



201052



200056



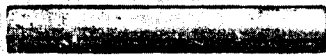
225456



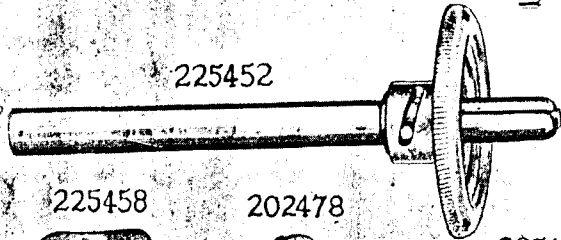
200299



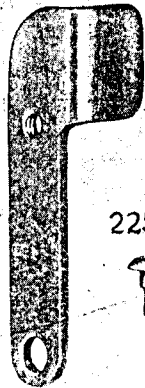
225454



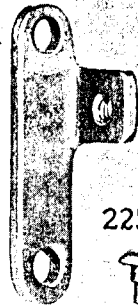
225452



225458



202478



225444



225459



225460

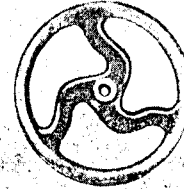


PLATE 10883—ONE-FOURTH SIZE

225463



202473



225436

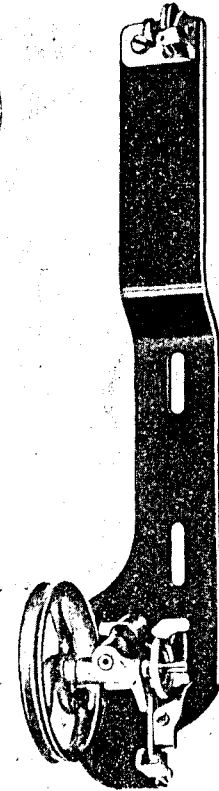
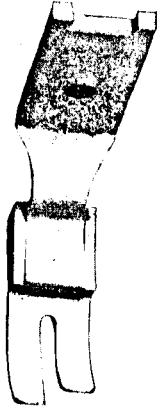


PLATE 10927 -FULL SIZE

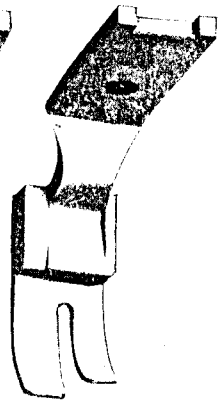
229864



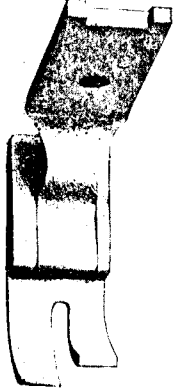
229865



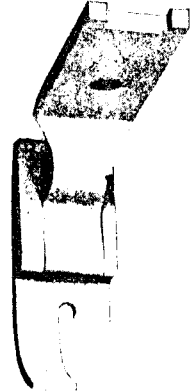
229863



229867



229868



203153



202351

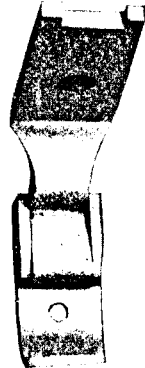


PLATE 10929 -FULL SIZE

206794



229857



229858



206785



206830



229856



202418



206788



206786



PLATE 11060-FULL SIZE

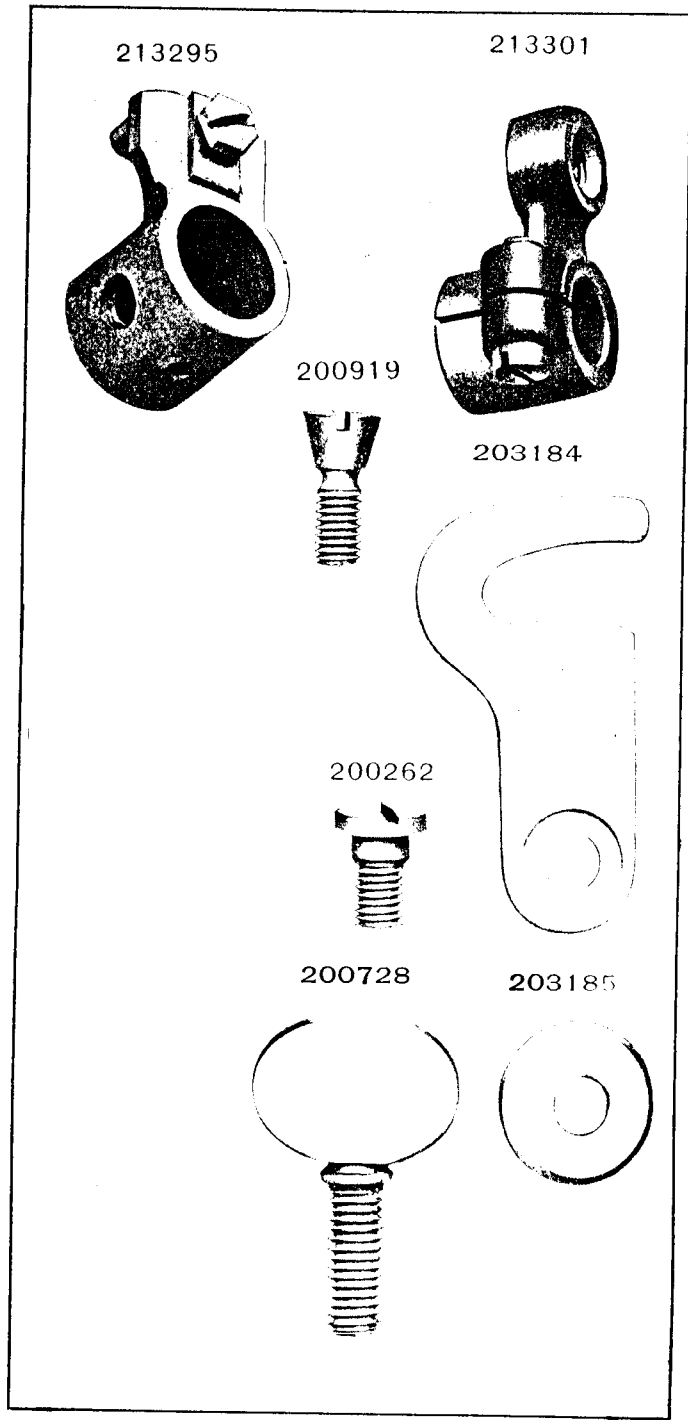


PLATE 11061-FULL SIZE

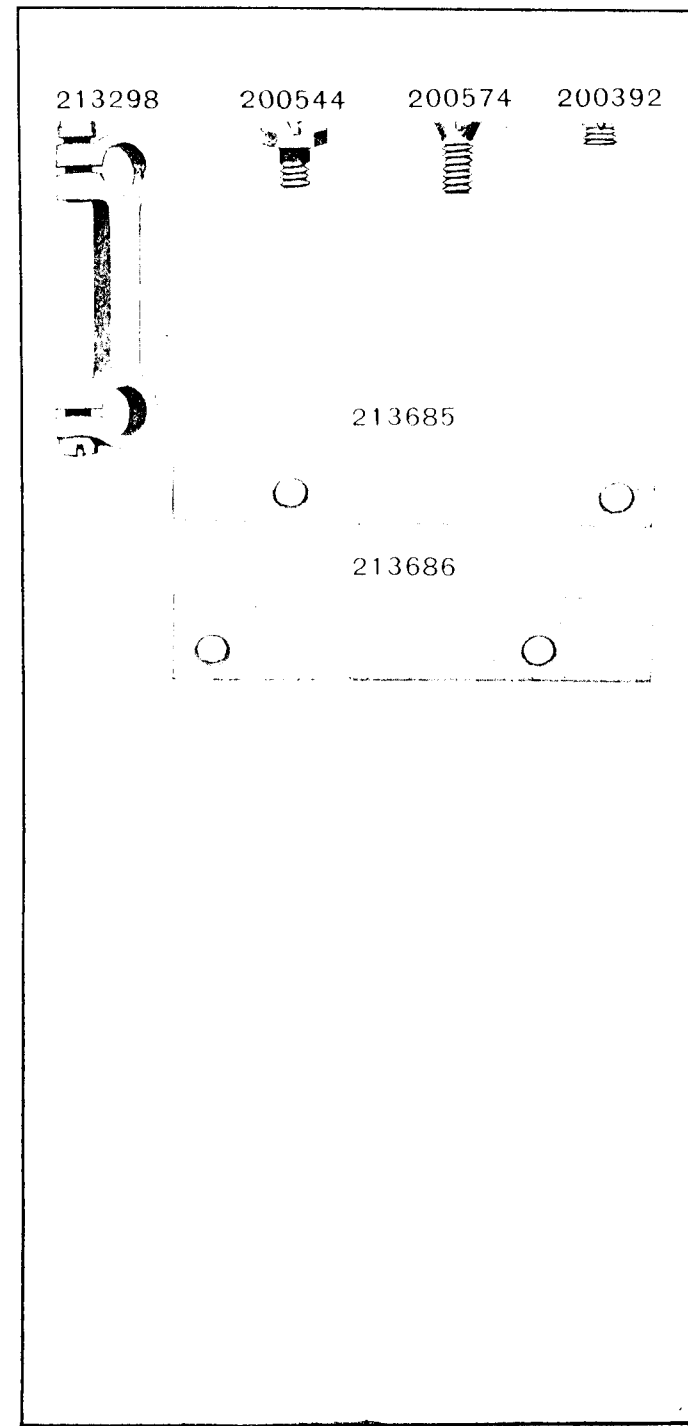


PLATE 11150 - ONE-HALF SIZE

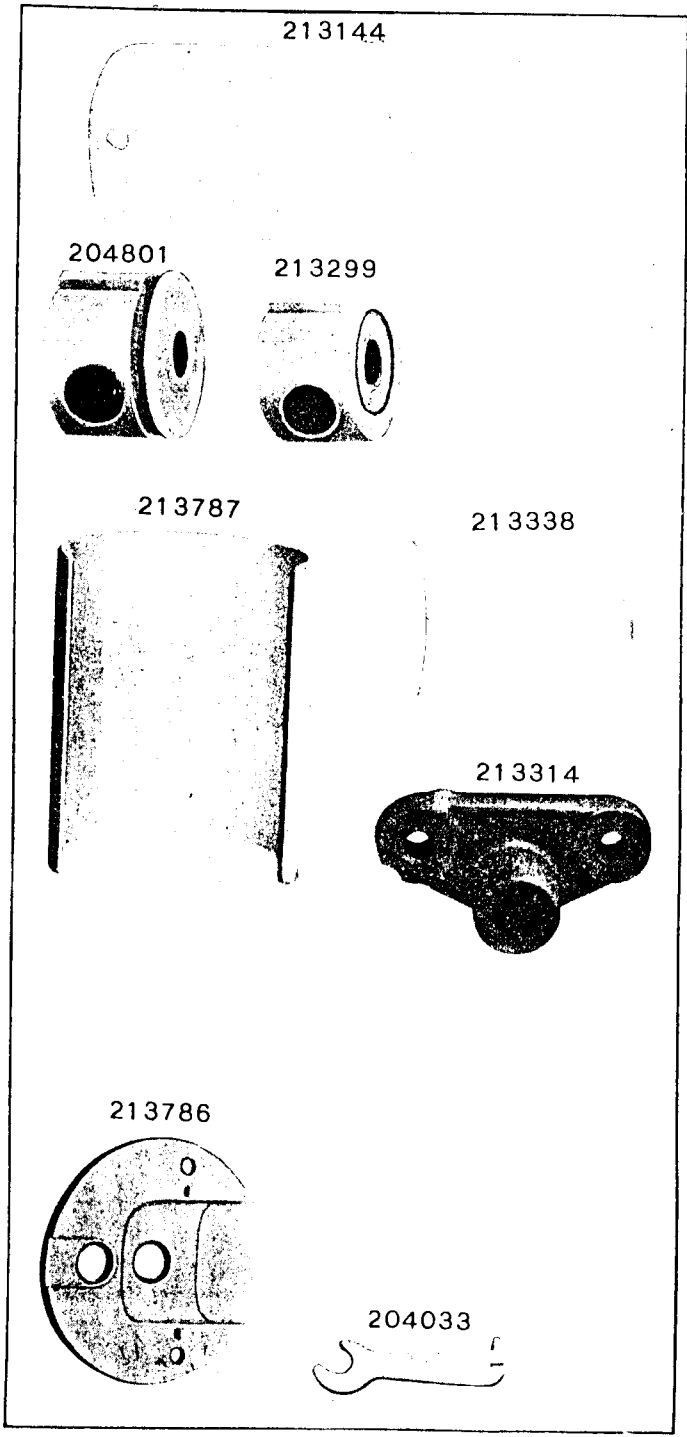


PLATE 11151 - FULL SIZE

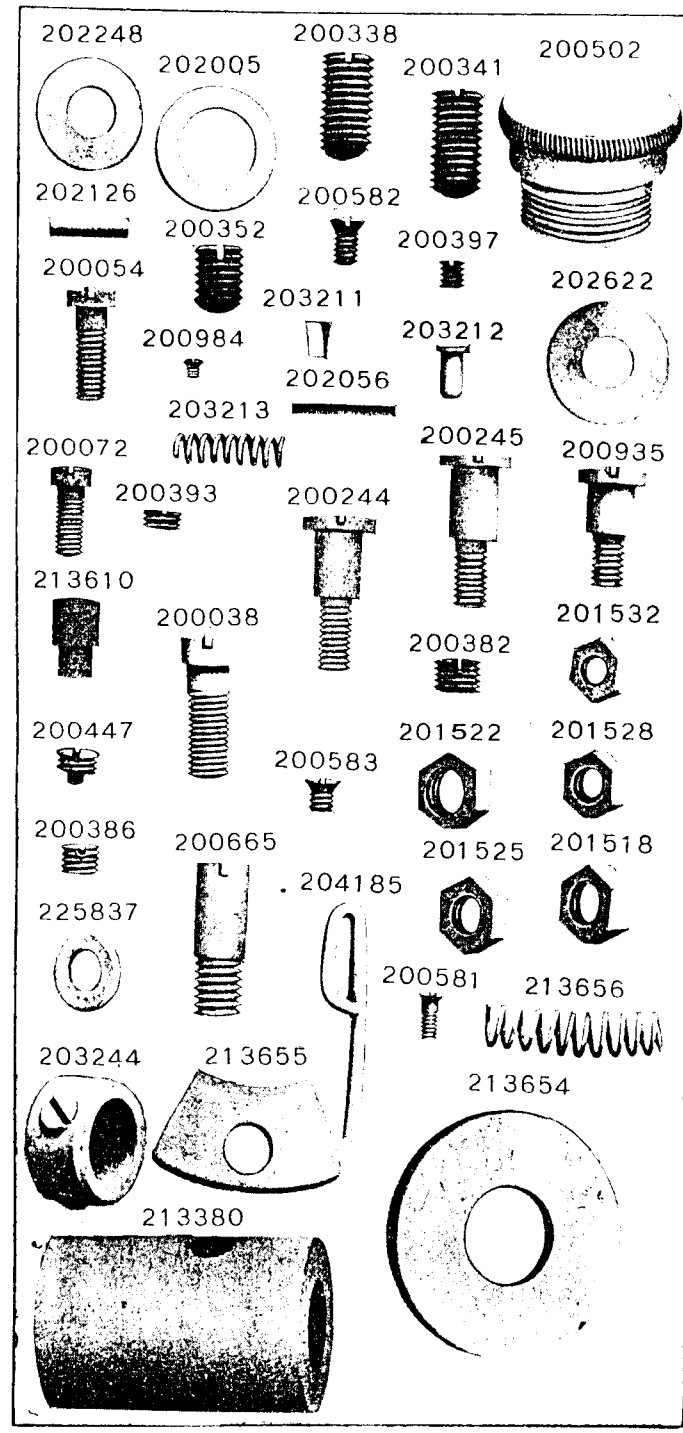


PLATE 11152 - ONE-FOURTH SIZE

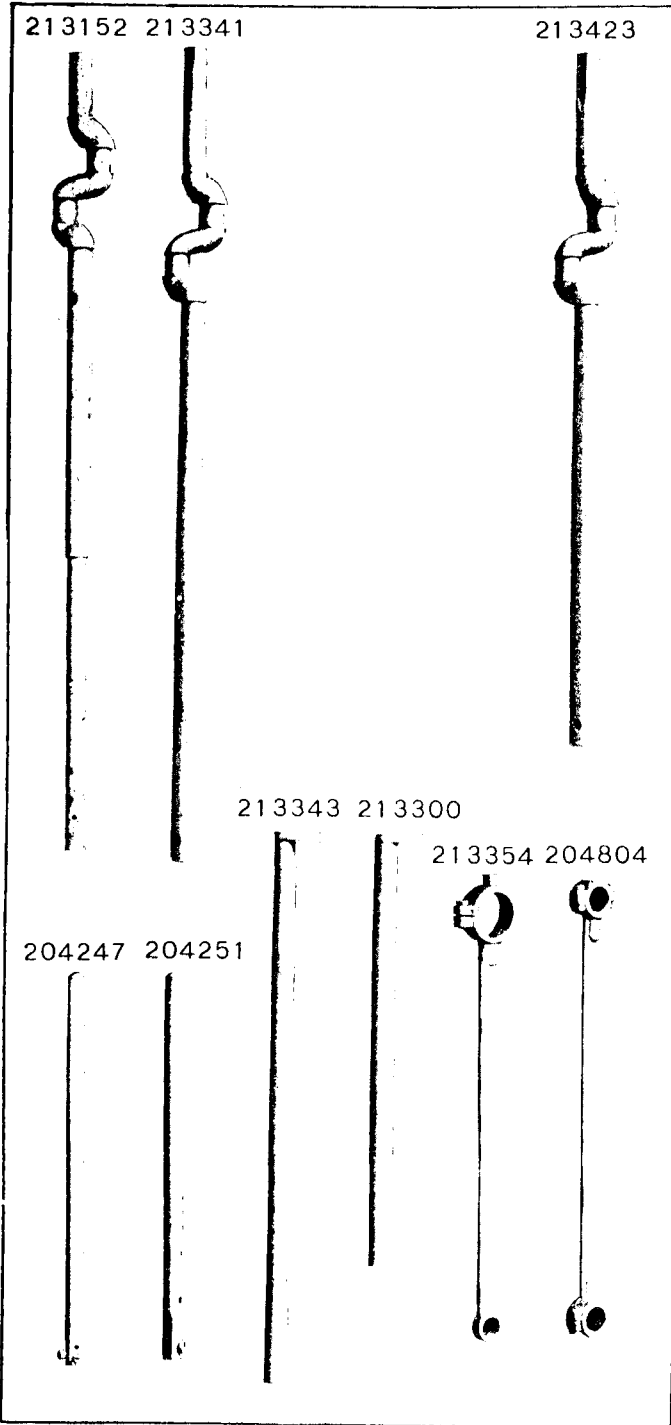


PLATE 11156 - ONE-FOURTH SIZE

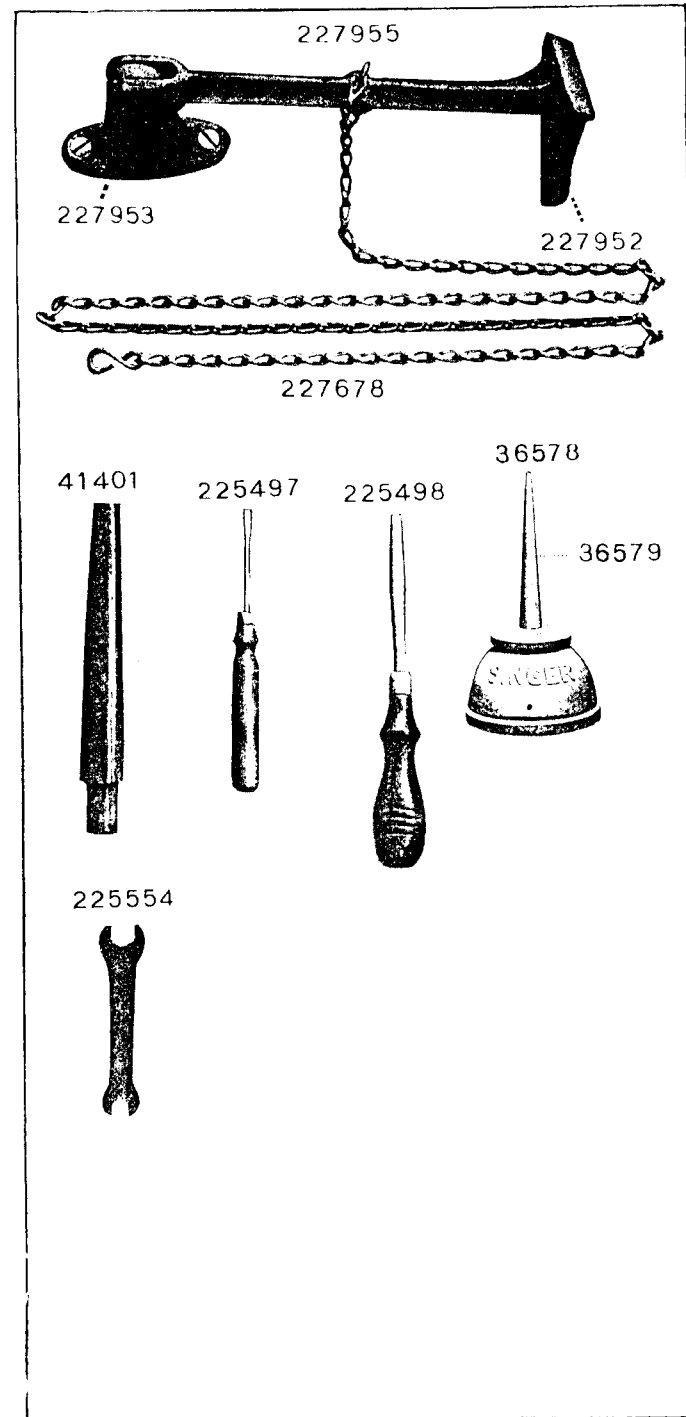


PLATE 11163 - ONE-FOURTH SIZE

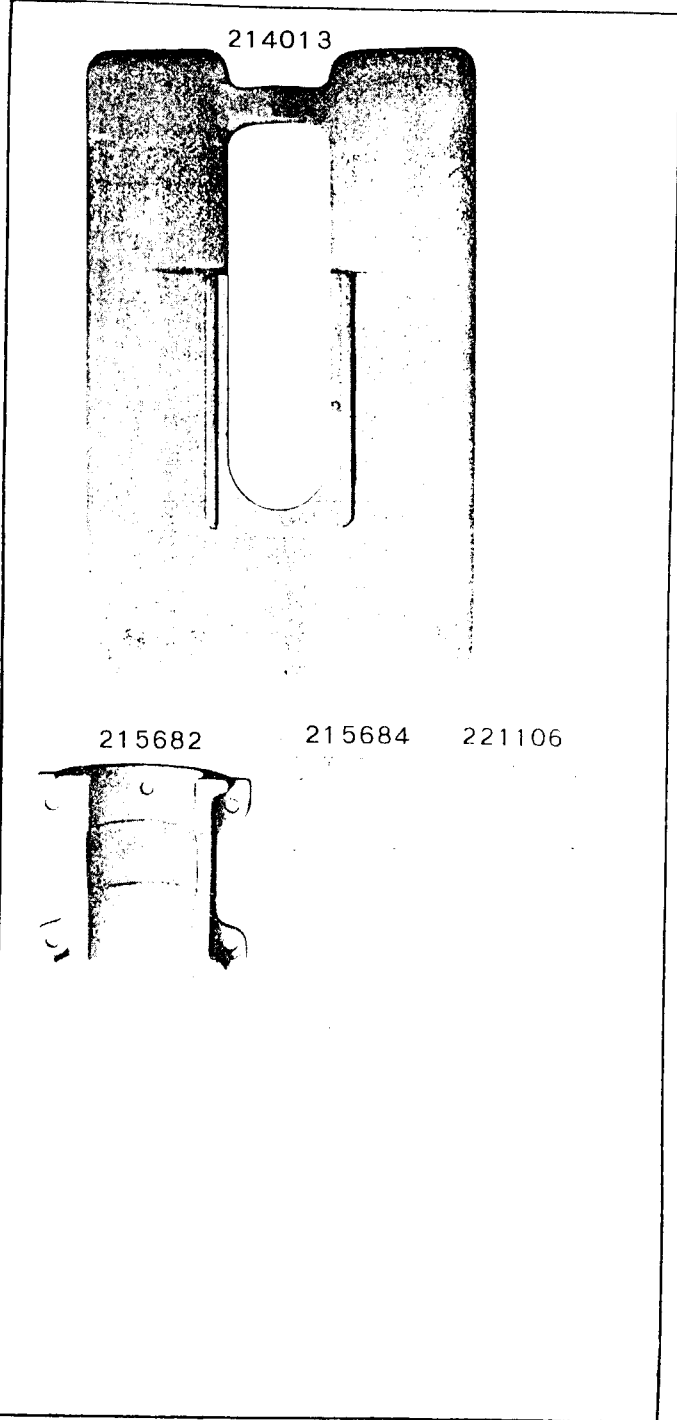


PLATE 11228 - FULL SIZE

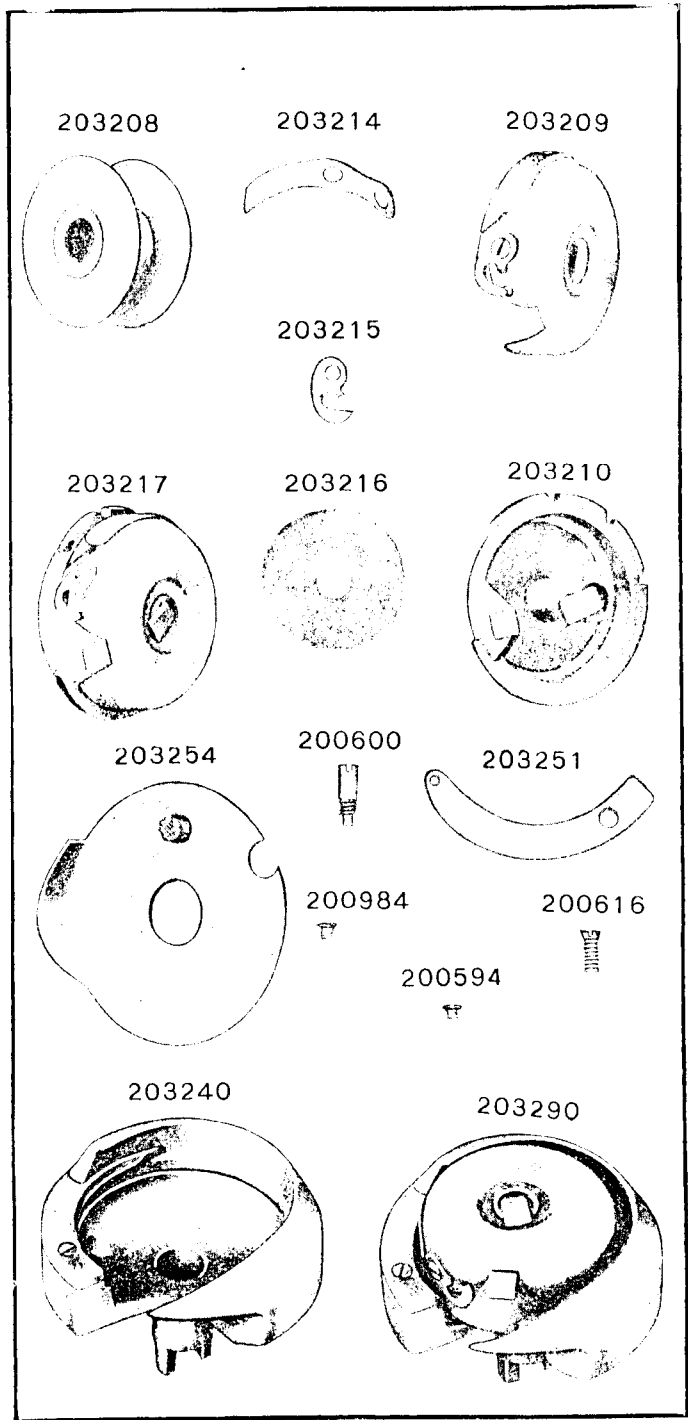


PLATE 11254—ONE-HALF SIZE

203208



203209



203210



203549



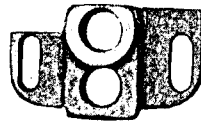
203554

№ 2 OUTFIT

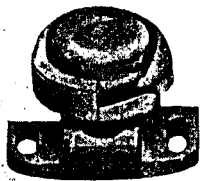
203240



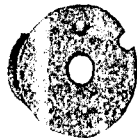
203552



203554



203254



203254



PLATE 12177—FULL SIZE

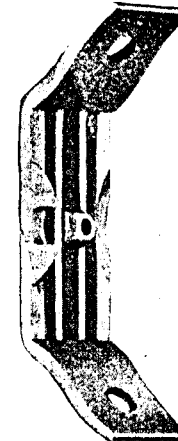
212276

212277

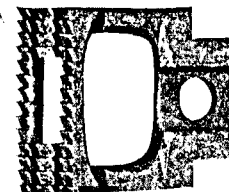


212276

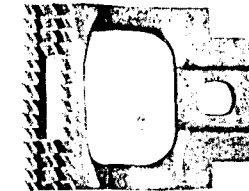
212277



212278



212278

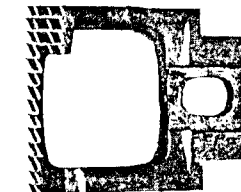


212279

212280



212281



212282

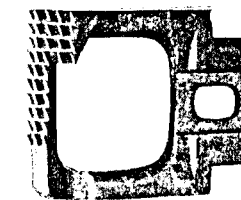
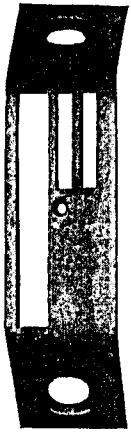
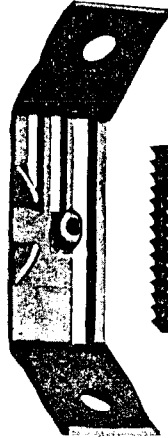


PLATE 12179—FULL SIZE

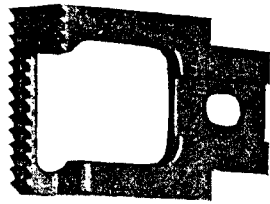
212288
212289



212288
212289



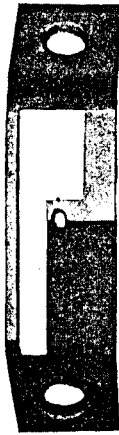
212290



212291
212292



212293
212294



212295
212296

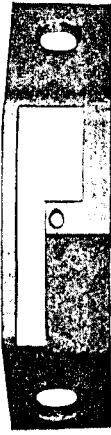
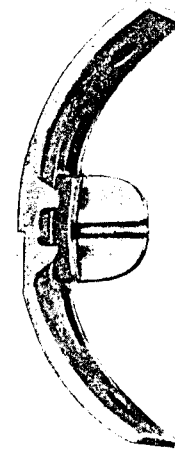


PLATE 12180—FULL SIZE

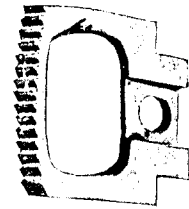
212297



212297



212298



212299



212299



212300

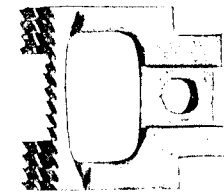


PLATE 12309 - FULL SIZE

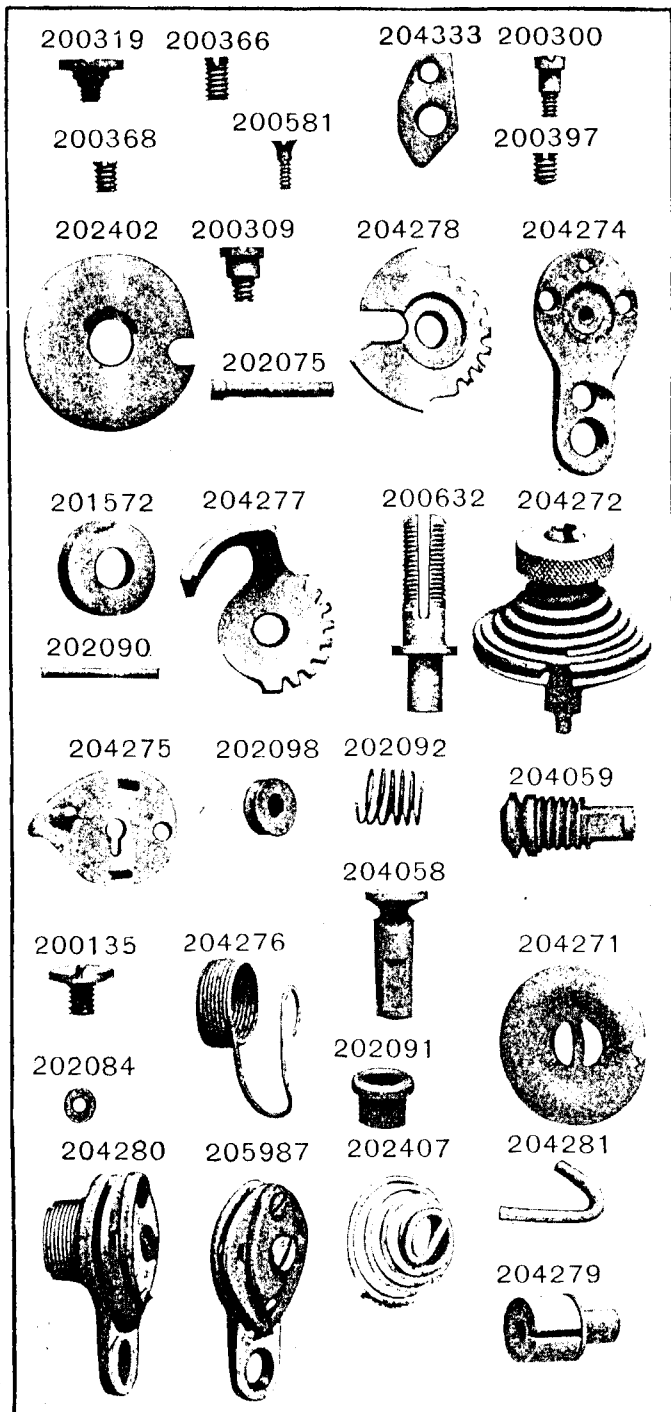


PLATE 12319 - FULL SIZE

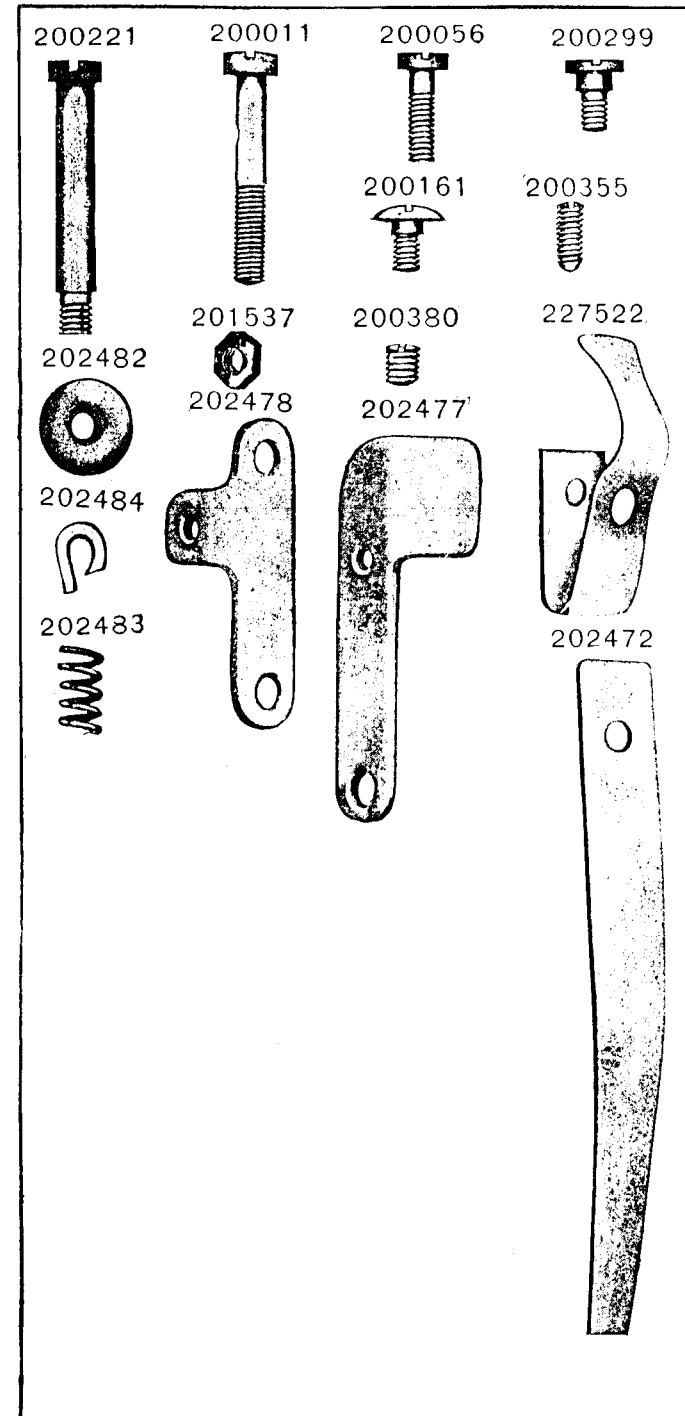


PLATE 12311-FULL SIZE

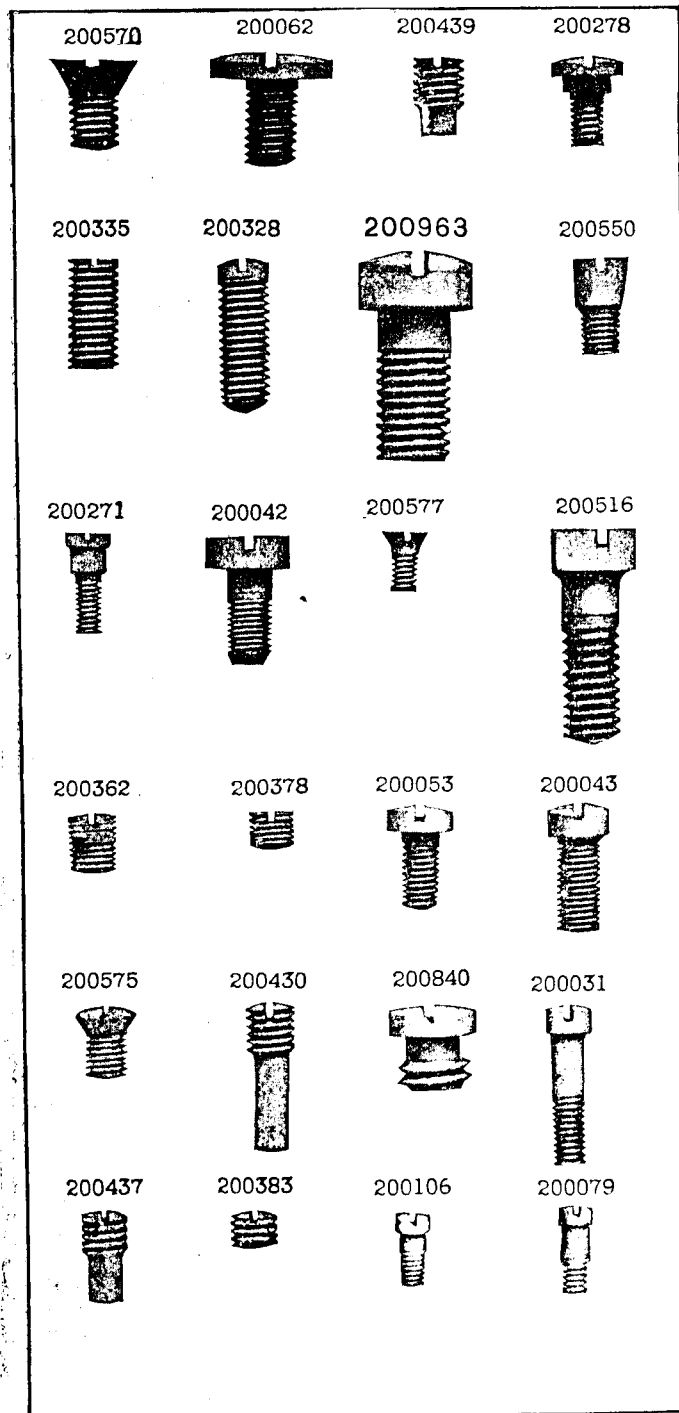


PLATE 12475 -FULL SIZE

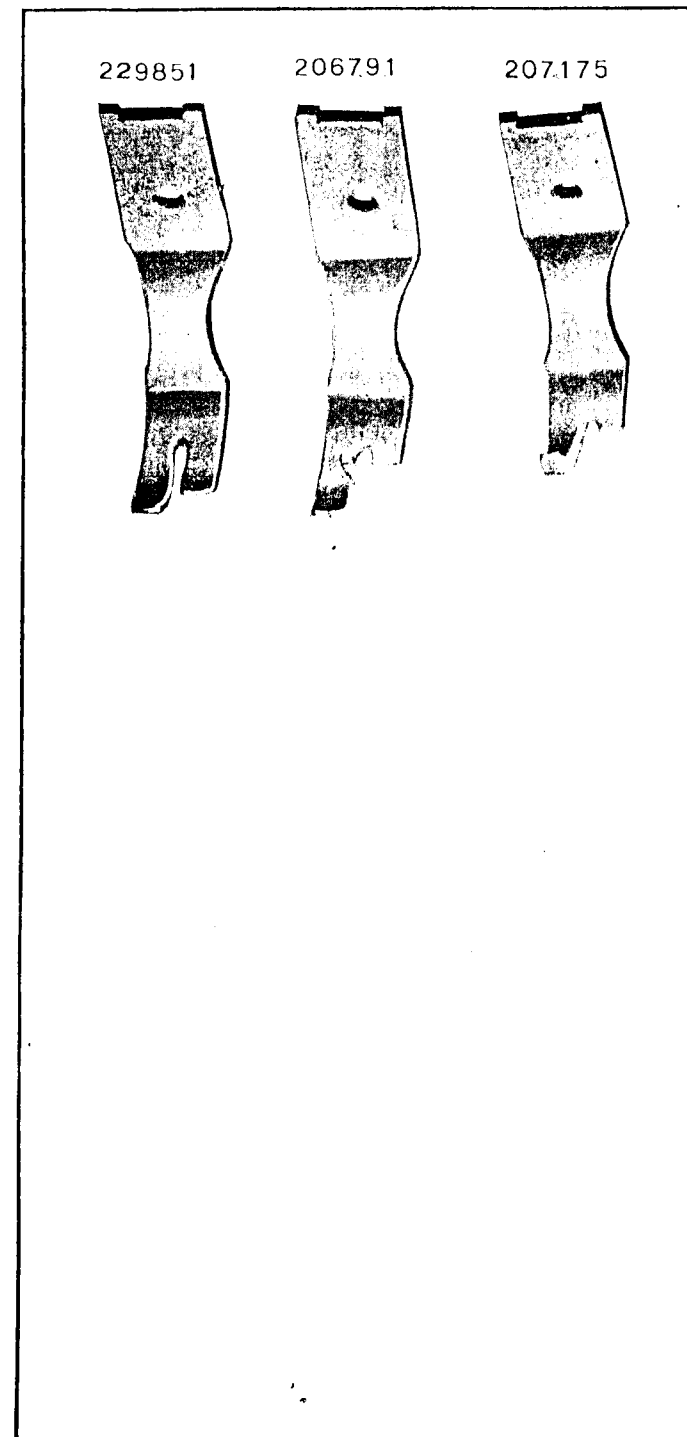


PLATE 12320—ONE-HALF SIZE

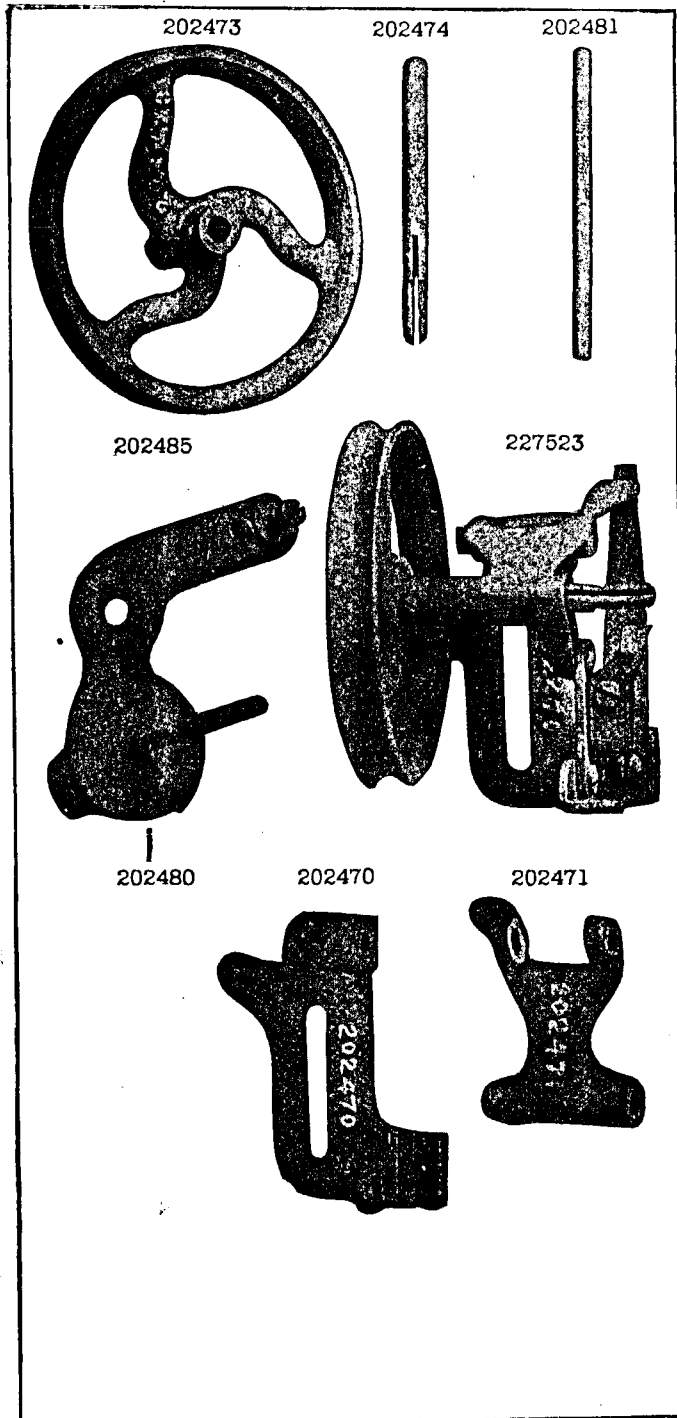


PLATE 12479 —FULL SIZE

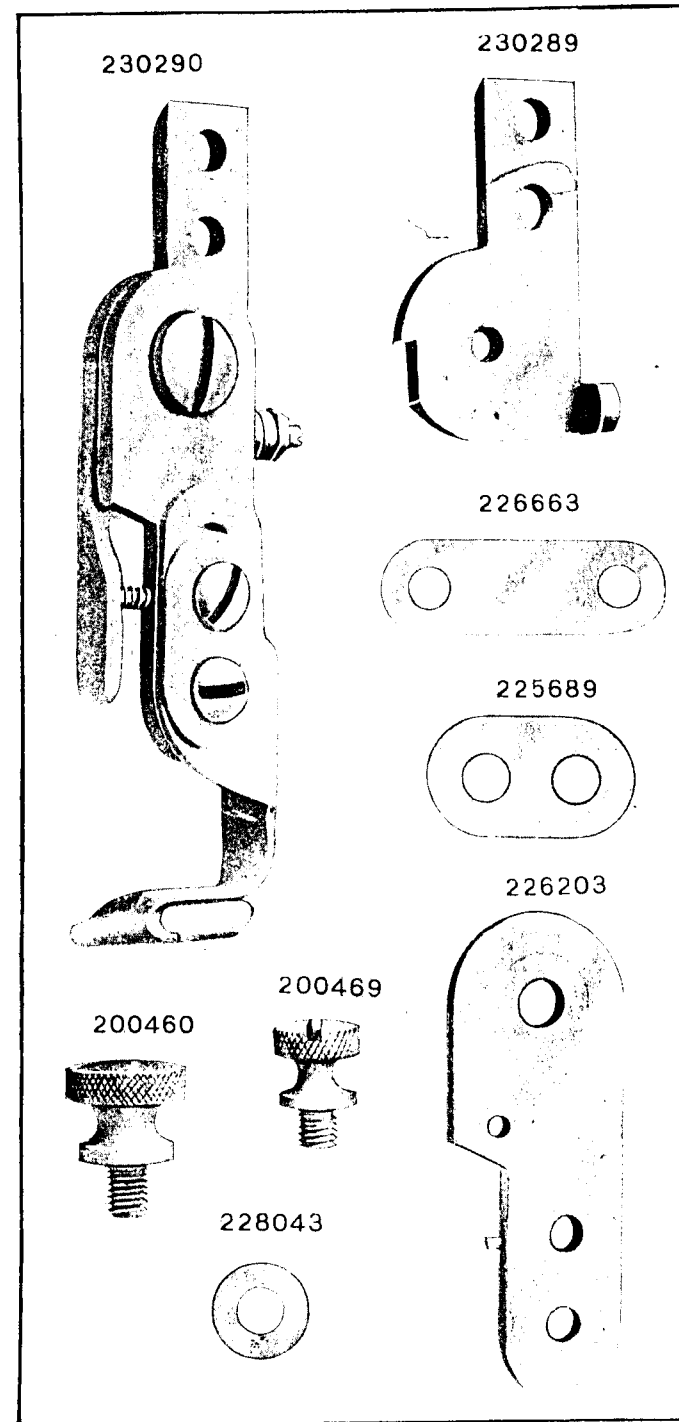


PLATE 12487—FULL SIZE

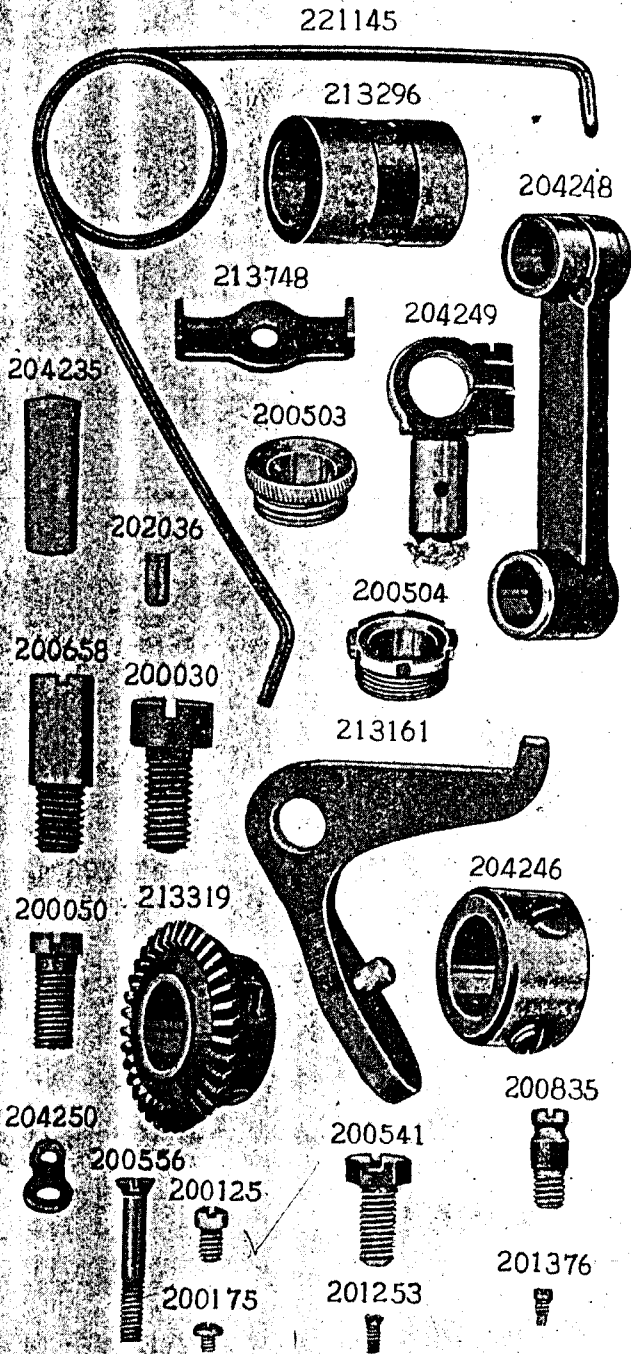


PLATE 12488—ONE-HALF SIZE

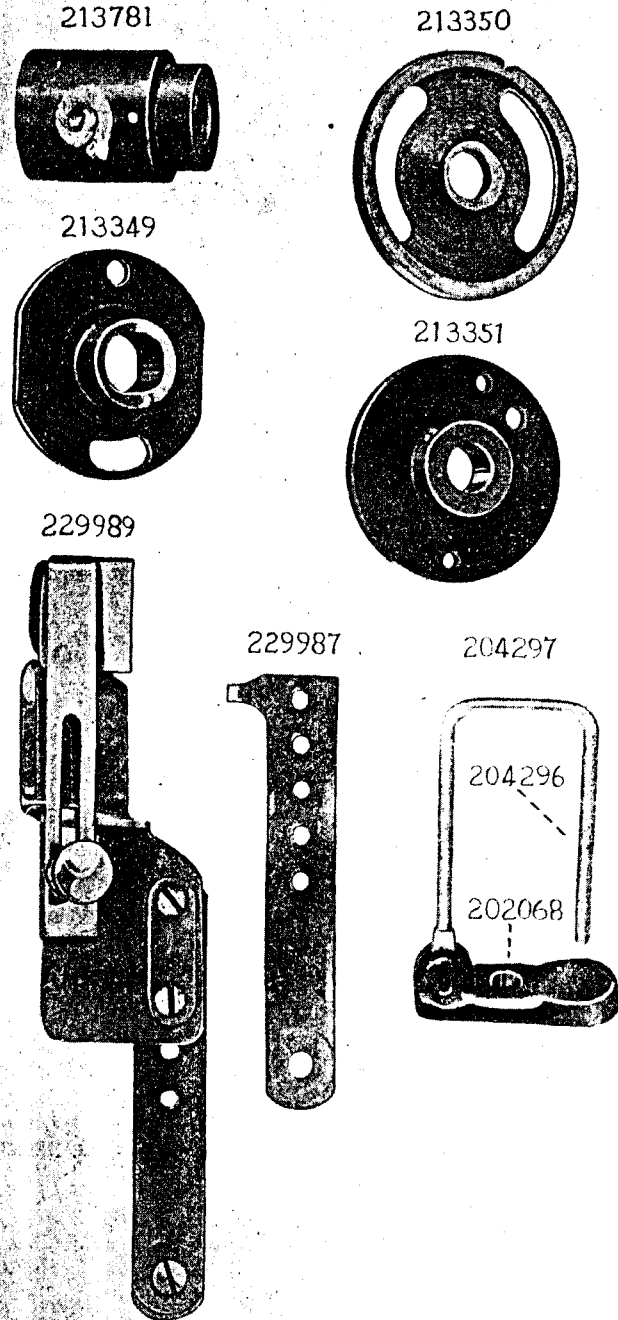


PLATE 12489—FULL SIZE

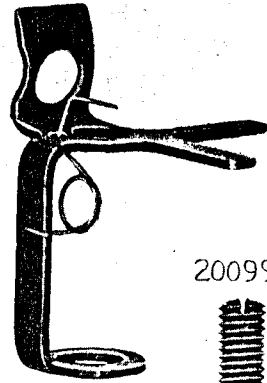
204267



200688



204268



204269



200990



204273



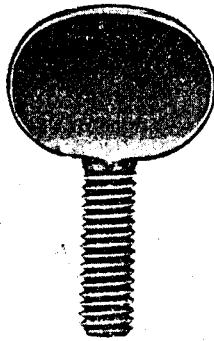
200684



204925



200729

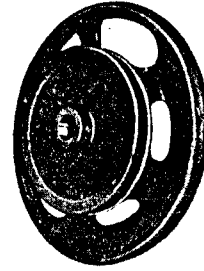


229080



PLATE 12490—ONE-FOURTH SIZE

204805



221172



221171



202618



202781

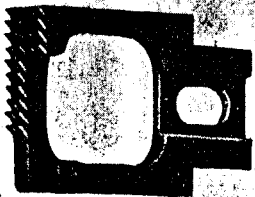


227461

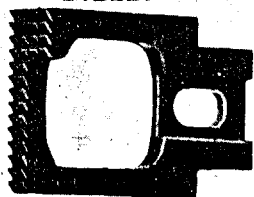


PLATE 12491—FULL SIZE

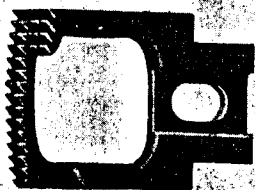
212220



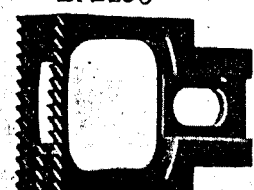
212221



212285



212258



212257



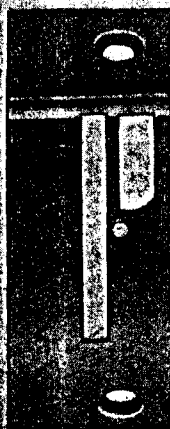
212256



221183



212287



212286

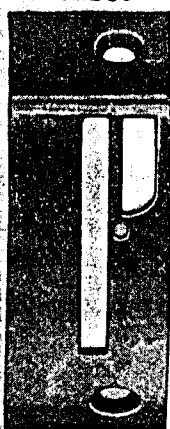
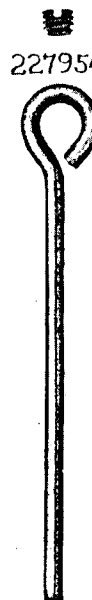


PLATE 12492—FULL SIZE

202472



201052



227954

200160



201531



200305



204389



226206



200184



230640



200268



226205



230648



225016



202784



226663



200925

