

FORM 8853
APRIL, 1922

LIST OF PARTS



MACHINE No. 116-1

THE SINGER MANUFACTURING COMPANY

COPYRIGHT, U.S.A., 1918 and 1922, BY THE SINGER MANUFACTURING CO.
ALL RIGHTS RESERVED FOR ALL COUNTRIES

INDEX

	PAGE
ACCESSORIES	12
BOBBIN WINDER.....	12
FOOT LIFTER PARTS	13
IRON BASE	12
KNEE LIFTER PARTS.....	14
MACHINE NO. 116-1	7
NUMERICAL LIST OF PARTS.....	17
OBSOLETE PARTS.....	15
THREAD UNWINDER.....	14

INSTRUCTIONS FOR ORDERING

In ordering from this list, use **ONLY** the part NUMBER in the **FIRST** column.

The number stamped on a Sewing Machine part is in every case the number of the single part only.

Every combination of parts sent out as such has its specific number, which, although not stamped on the parts, must be used when ordering the combination.

Each number always indicates the **SAME PART** in whatever list it appears, or for whatever machine.

The letters after some of the numbers indicate the style of finish only, as follows:

- A. Hardened, Polished and Plated.
- B. Polished and Plated
- C. Hardened only.
- D. Polished only.
- E. Soft, not Polished.
- F. Hardened and Polished.
- G.
- H. Blued.
- J. Plated only.
- K. Hardened and Plated.
- L. Brass or Gilt.
- M. Oxidized.
- P. Japanned.
- R. Parkerized

These letters **MUST BE USED** when they appear in the list, and **AFTER** the number as in the list.

In this series

- 1 to 1500 and 50001 to 51500 are Screw Numbers.
- 1501 to 1800 are Nut Numbers.
- 1801 to 2000 are Roller Numbers.
- 2001 to 50000 and 52001 and upward are numbers of Machine Parts.

The figures in the second column refer only to the plates, illustrating the parts, and are **NOT TO BE USED** in ordering.

Parts marked with an asterisk (*) are furnished only when repairs are made at factory.

LIST OF PARTS COMPLETE

FOR

MACHINE No. 116-1

FOR SNAPPING THE ENDS OF BINDING, 3/8 TO 1 1/4 INCHES WIDE, ON BRIMS OF SOFT FELT HATS. HAS WORK CLAMP AUTOMATICALLY OPERATED BY A BELL CRANK RECEIVING ITS MOTION FROM A CAM ON THE UNDER SIDE OF THE BED. STITCH ADJUSTABLE FROM SEVEN TO TWENTY TO THE INCH. REGULARLY FITTED WITH AN IRON BASE.

NO.	PLATE	NAME
*125001	---	Arm.....
125002	---	" 125001 with 435c, 448c, 15486 and 15498.....
2002	8534	Arm Dowel Pin.....
138e	8533	" Screw.....
125003	8525	" Shaft.....
15498	8525	" " Bushing.....
435c	8533	" " " Set Screw.....
144d	8533	" " Screw.....
15196	8525	" Side Cover.....
286d	8534	" " " Thumb Screw.....
12403	8529	" Spool Pin and Thread Eyelet.....
8879	8530	" " " Washer (cloth).....
2138	8526	Balance Wheel (power) light rim, 3 in. pulley, with two 448c.....
448c	8533	Balance Wheel Set Screw.....
*63501	---	Bed.....
63502	8527	Clamp Arm.....
63503	8527	" " Bracket.....
63504	8527	" " Hinge Block with 735c.....
63505	8527	" " " " Pin.....
735c	8533	" " " " " Set Screw.....
219d	8533	" " " " Screw.....
203d	8533	" " Screw.....
63506	8525	" Carrier with 51815.....
63507	8527	" " Cap.....
219d	8533	" " " Screw.....
63508	8525	" " Lever.....
660d	8534	" " " Hinge Screw.....

NO.	PLATE	NAME
63509	8527	Clamp Carrier Regulator with 238E and 1877.....
52877F	8527	Clamp Carrier Regulator Hinge Stud.....
448c	8533	" " " " " Set Screw.....
1877	8533	Clamp Carrier Regulator Roller and Screw Stud.....
1236c	8527	Clamp Carrier Regulator Screw Stud.....
7070	8527	" " " " " Sleeve.....
1658J	8527	" " " " " Thumb Nut.....
63510	8527	Clamp Carrier Regulator Slide Block.....
238E	8533	" " " Stop Screw.....
51815	8533	" " Roller and Screw Stud.....
63511	8527	" Check.....
50335D	8533	" " Hinge Screw.....
63512	8527	" Pressure Arm.....
203D	8533	" " " Screw.....
51816	8533	" " Roller and Stud.....
63513	8527	" " " Bracket with 453c and 51816.....
453c	8533	Clamp Pressure Roller Bracket Set Screw.....
63514	8527	" Spring.....
2811	8526	Crank Connecting Rod with 2812 and two 158E.....
*2812	—	Crank Connecting Rod Cap.....
158E	8533	" " " " Screw.....
375c	8534	" " " Hinge Screw.....
1518E	8533	" " " " " Nut.....
2866	8526	Face Plate.....
63515	—	Face Plate complete, Nos. 448c, 460c, 600c, 1560c, 2103, 2105, 2107, 2111, 2127, 2269, 2866, 2870, 55645 and two each 233D and 2102.....
2107	8529	Face Plate Thread Guard.....
233D	8533	" " " " " Screw.....
190D	8533	" " " " " Screw.....
203D	8528	Feed Connecting Link.....
378c	8534	" " " Hinge Screw.....
1520E	8533	" " " " " Nut.....
170E	8528	" Eccentric with 418c.....
448c	8533	" " Set Screw.....
63516	8526	" Forked Connection.....
378c	8534	" " " Hinge Screw.....
1520E	8533	" " " " " Nut.....
63517	8528	" Regulator.....
50353E	8534	" " Hinge Screw.....

NO.	PLATE	NAME
8217	8527	Feed Regulator Hinge Screw Friction Washer.....
747D	8534	Feed Regulator Thumb Screw.....
63518	8528	" Rock Shaft.....
63519	—	Feed Rock Shaft complete, Nos. 63518 and 63520.....
63520	8528	Feed Rock Shaft Crank with 157E.....
157E	8533	" " " " Clamping Screw.....
307c	8534	" " " Screw Centre.....
1513J	8533	" " " " " Nut.....
63521	8525	" Wheel.....
63522	8528	" " Driving Lever.....
63523	8528	" " " " Block.....
63524	8528	" " " " " Cap.....
237D	8533	" " " " " " " Screw.....
63525	8528	Feed Wheel Driving Lever Block Spring.....
234D	8533	" " " " " " " Screw.....
63526	8528	Feed Wheel Driving Lever Link.....
870F	8534	" " " " " Hinge Screw for 63522.....
50336F	8534	Feed Wheel Driving Lever Link Hinge Screw for 63518.....
1521E	8533	Feed Wheel Driving Lever Link Hinge Screw Nut for 50336.....
50337c	8534	Feed Wheel Hinge Screw.....
1518E	8533	" " " " " Nut.....
2718	8533	" " " " " Washer.....
63527	8528	" " Retaining Clutch.....
63528	8528	" " " " Bracket.....
180D	8533	" " " " " " " Screw.....
63529	8528	Feed Wheel Retaining Clutch Cap.....
190D	8533	" " " " " " Screw.....
63530	8528	" " " " " Spring.....
229D	8533	" " " " " " Screw.....
63531	8528	Guide.....
1209c	8533	" Screw.....
23390	8533	" " Washer.....
2050	8525	Needle Bar.....
15248	8529	" " Connecting Link with 930E.....
930E	8534	" " " " Adjusting Screw.....
570c	8533	Needle Bar Connecting Link Hinge Screw.....
1520E	8533	" " " " " " " Nut.....

NO.	PLATE	NAME
2052	8529	Needle Bar Connecting Stud with 155c
155c	8533	" " " " Set Screw
290e	8533	" " Screw Bushing
15068	8529	" " Thread Guard
251f	8533	" " " " Screw
15069	8529	" Clamp with 246f
246f	8533	" " Screw
63532	8525	Oscillating Rock Shaft with 4784
3052	8529	" " " Hinge Pin
1513j	8533	" " " " Nut
635c	8529	" " " " Screw
		Bearing
1513j	8533	Oscillating Rock Shaft Hinge Pin Screw
		Bearing Nut
4784	8532	Oscillating Rock Shaft Oil Pad (felt)
63533	8525	" Shaft
15426	8529	" " Crank
15165	—	Oscillating Shaft Crank complete, Nos. 1519e, 15171, 15426 and two 462c
2049	8529	Oscillating Shaft Crank Pin
462c	8533	" " " Set Screw
15170	8529	" " " Slide Block
229d	8533	" " " " Cap
		Screw
12424	8529	Oscillating Shaft Crank Slide Block Cap
		Screw Washer
1035c	8529	Oscillating Shaft Crank Slide Block Screw
		Stud
1519e	8533	Oscillating Shaft Crank Slide Block Screw
		Stud Nut
15171	—	Oscillating Shaft Crank Slide Block complete, Nos. 229d, 1035c, 12424 and 15170
63534	8525	Presser Bar
2062	8529	" " Lifter
15486	8529	" " " Hinge Stud
448c	8533	" " " " Set Screw
2952	8529	" " Lifting Bracket with 453c
453c	8533	" " " " Set Screw
290e	8533	" " Screw Bushing
2308	8529	" " Spring
2070	8529	" " " Washer
263j	8529	Pressure Regulating Thumb Screw
2996	8530	Shuttle Bobbin
15140	8530	" " Case Latch
2973	8530	" " " " Lever
2974	8530	" " " " Fulcrum
		Pin

NO.	PLATE	NAME
2975	8530	Shuttle Bobbin Case Latch Spring
592e	8530	" " " " Stop Screw
15141	—	" " " Hinge, Nos. 2973, 2974 and 15140
7553	8530	Shuttle Bobbin Case Position Finger
2523	8530	" " " " " Rivet
15727	8530	Shuttle Bobbin Case complete, Nos. 591f, 592e, 2523, 2975, 7553, 15098 and 15141
2515	8530	Shuttle Body
591f	8530	" Tension Regulating Screw
15098	8530	" " Spring
63535	—	Shuttle, 1 $\frac{1}{8}$ in. diam., Nos. 2515, 2996 and 15727
*2542	—	Shuttle Driver
2441	8532	" " 2542 with two 462c
2049	8529	" " Pin
462c	8533	" " Set Screw
63536	8531	" Race Back
2532	8531	" " " Position Pin
2533	8531	" " " Spring
648j	8534	" " " " Screw
63537	8531	" " Body
63538	8531	" " Cap
335d	8531	" " " Screw
63539	—	" " Cover
63540	8530	" " " 63539 with 63541 and two 26092
63541	—	Shuttle Race Cover Bracket
21516	8530	" " " " Hinge Pin
26092	8530	" " " " Rivet
63542	8530	" " " Spring
330d	8530	" " " " Screw
145d	8533	" " " Screw
63543	—	Shuttle Race complete, Nos. 330d, 648j, 2533, 21516, 63536 to 63538, 63540, 63542 and two each 335d and 2532
2102	8532	Tension Disc
1560c	8532	" Regulating Thumb Nut
2870	8532	" Releaser
2269	8532	" " Hinge Pin
600c	8532	" Screw Stud
448c	8533	" " " Set Screw
2103	8532	" Spring
2105	8532	" Thread Guard
2112	8532	Thread Retaining Disc with 2113
2113	8532	" " " Steady Pin
2114	8532	" " Spring

NO.	PLATE	NAME
2115	8532	Thread Retaining Stud.....
460c	8532	“ “ “ Set Screw.....
2111	—	Thread Retainer Guide complete, Nos. 2112, 2114 and 2115.....
15275	8525	Thread Take-up Cam with 1293c.....
1293c	8534	“ “ “ Position Screw....
15491	8532	“ “ Lever with 1822.....
50527c	8534	“ “ “ Hinge Screw.....
1822	8533	“ “ “ Roller and Stud...
55645	8532	“ “ Spring.....
2127	8532	“ “ “ Regulator Plate
233d	8533	“ “ “ “ “
		Adjusting Screw.....

IRON BASE

NO.	PLATE	NAME
24788	8534	Bed Frame Cushion (leather).....
2976	8530	“ “ Hinge Connection.....
448c	8533	“ “ “ “ Set Screw
14008	8534	“ “ “ “ Pin.....
650d	8534	“ “ Thumb Screw.....
63544	8535	Bed Frame with 650d, 63545, two each 2976, 14008 and four each 24788 and wood screws 1¼ in. No. 12.....
63545	8535	Drip Pan.....

ACCESSORIES

NO.	PLATE	NAME
36578	5901	Oiler (copper plated) with 36579.....
36579	5901	“ Spout, 3½ in. long, with 120117....
120117	5901	“ “ Washer (leather).....
26026	5901	Screw Driver (machine).....
26485	5901	“ “ (shuttle tension).....
19079	8526	Wrench for 1209.....
8909	5901	“ “ 1513 and 1518.....
8908	5901	“ “ 1519 and 1520.....

BOBBIN WINDER

SWINGING AUTOMATIC, RIGHT HAND

NO.	PLATE	NAME
27540	1417	Base.....
15072	8530	Bobbin Position Pin.....
27302	1417	Frame.....

NO.	PLATE	NAME
50356d	8534	Frame Hinge Screw.....
1620j	8533	“ “ “ Nut.....
27303	8532	“ Spring.....
27541	1417	Pulley.....
27538	1417	Spindle with 15072.....
27306	1417	Spool Pin.....
27307	1417	“ Stand.....
27308	1417	Spool Stand complete, Nos. 418E, 1562J, 2106, 10141, 11241, 27306, 27307 and two each 2455 and wood screws 1 in. No. 10.....
11241	1417	Spool Washer (cloth).....
27312	1417	Stop Latch.....
35d	8534	“ “ Hinge Screw.....
2455	8532	Tension Disc.....
1562j	8533	“ Regulating Thumb Nut.....
418E	8532	“ Screw Stud.....
10141	8532	“ Spring.....
2106	8532	“ Thread Guide.....
27647	1417	Bobbin Winder, Nos. 35d, 1620j, 27302, 27303, 27312, 27538, 27540, 27541, 50356d and two wood screws 1 in. No. 7
27544	—	Bobbin Winder (swinging automatic, right hand) complete, Nos. 27308 and 27647

FOOT LIFTER PARTS

NO.	PLATE	NAME
5670	—	Chain, length 26 in. to 35 in., with 56864 and 56865.....

NOTE: When ordering No. 5670, give length required.

4879	8536	Chain Connecting Link.....
56864	8526	“ Hook (large).....
56865	8530	“ “ (small).....
2775	8536	Lifting Lever.....
802d	8534	“ “ Hinge Screw.....
2763	8536	Rock Shaft.....
6334	8536	“ “ Hanger with two wood screws 1 in. No. 10.....
6337	8536	Rock Shaft Lifting Bracket with two 356c.
12243	8536	“ “ “ “ Hook for 2775.
63553	8536	“ “ “ “ “ “ 5670.
356c	8533	“ “ “ “ “ Set Screw
356c	8533	“ “ “ “ “ Set Screw.....
2770	8536	“ “ Stop Dog with 356c.....
356c	8533	“ “ “ “ “ Set Screw.....

FOOT LIFTER PARTS

NO.	PLATE	NAME
63554	8536	Rock Shaft complete, Nos. 2763, 2770, 12243, 63553 and two each 6334 and 6337.....
4881	8536	Treadle.....
4882	8526	" Shaft.....
4883	8526	" Spring.....
4884	8536	" Stand.....
4885	8536	Treadle complete, Nos. 4879, 4881 to 4884 and two wood screws 1 in. No. 16.....
63555	—	Foot Lifter complete, Nos. 802b, 2775, 4885, 5670 and 63554.....

KNEE LIFTER PARTS

NO.	PLATE	NAME
2775	8536	Lifting Lever.....
802b	8534	" " Hinge Screw.....
2763	8536	Rock Shaft.....
6334	8536	" " Hanger with two wood screws 1 in. No. 10.....
2765	8536	Rock Shaft Knee Arm.....
2768	—	Rock Shaft Knee Arm complete, Nos. 2765 to 2767.....
2766	8536	Rock Shaft Knee Arm Hub with 356c...
356c	8533	" " " " " Set Screw...
2767	8536	" " " Plate with 356c.....
356c	8533	" " " " " Set Screw.....
6337	8536	" " Lifting Bracket with two 356c.....
12243	8536	" " " " Hook.....
356c	8533	" " " " " Set Screw.....
356c	8533	" " " " " Set Screw.....
2770	8536	" " Stop Dog with 356c.....
356c	8533	" " " " " Set Screw.....
2781	8536	Rock Shaft complete, Nos. 2763, 2768, 2770, 6337, 12243 and two 6334.....
63546	—	Knee Lifter complete, Nos. 802b, 2775 and 2781.....

THREAD UNWINDER

FOR ONE SMALL SPOOL

NO.	PLATE	NAME
27702	7661	Spool Pin.....
27442	7661	" Rest with 27702.....
10243	7661	" Weight.....

THREAD UNWINDER

NO.	PLATE	NAME
41546	8534	Spool Weight Centre Pin.....
41547	7661	Spool Weight complete, Nos. 10243 and 41546.....
27447	7661	Thread Eyelet Rod.....
27446	7661	" " Wire.....
27448	—	Thread Eyelet complete, Nos. 27446 and 27447.....
41541	7661	Thread Guide with 41542.....
41542	8534	" " Centre Pin.....
41807	7661	Thread Unwinder complete, Nos. 27442, 27448, 41541, 41547 and two wood screws $\frac{3}{4}$ in. No. 10.....

OBSOLETE PARTS

NO.	PLATE	NAME
*2860	—	Arm with 450c, 2006 and 2803, use 125002
15268	—	" Shaft.....
2006	—	" " Bushing (back).....
450c	8533	" " " " " Set Screw.....
*2803	—	" " " (front).....
190b	8533	Clamp Arm Screw.....
190d	8533	" Pressure Arm Screw.....
74E	8534	Feed Regulator Hinge Screw.....
1058c	8534	Presser Bar Lifter Screw.....
1520E	8533	" " " " " Nut.....
15071	—	Thread Take-up Lever with 1822.....
79c	8534	" " " Hinge Screw.....

NUMERICAL LIST OF PARTS
FOR
MACHINE No. 116-1

NUMERICAL LIST OF PARTS

NO.	PLATE	NAME
35d	8534	Bobbin Winder Stop Latch Hinge Screw for 27647.....
74f	8534	Feed Regulator Hinge Screw, obsolete...
79c	8534	Thread Take-up Lever Hinge Screw, ob- solete.....
138e	8533	Arm Screw.....
144d	8533	" Shaft Screw.....
145d	8533	Shuttle Race Screw.....
155c	8533	Needle Bar Connecting Stud Set Screw for 2052.....
157e	8533	Feed Rock Shaft Crank Clamping Screw for 63520.....
158e	8533	Crank Connecting Rod Cap Screw for 2811
180b	8533	Feed Wheel Retaining Clutch Bracket Screw.....
190b	8533	Clamp Arm Screw, obsolete.....
190b	8533	" Pressure Arm Screw, obsolete.....
190b	8533	Face Plate Screw.....
190b	8533	Feed Wheel Retaining Clutch Cap Screw
203b	8533	Clamp Arm Screw.....
203b	8533	" Pressure Arm Screw.....
219b	8533	" Arm Hinge Block Screw.....
219b	8533	" Carrier Cap Screw.....
229b	8533	Feed Wheel Retaining Clutch Spring Screw.....
229b	8533	Oscillating Shaft Crank Slide Block Cap Screw for 15171.....
233b	8533	Face Plate Thread Guard Screw for 63515
233b	8533	Thread Take-up Spring Regulator Plate Adjusting Screw for 63515.....
234b	8533	Feed Wheel Driving Lever Block Spring Screw.....
237b	8533	Feed Wheel Driving Lever Block Cap Screw.....
238e	8533	Clamp Carrier Regulator Stop Screw for 63509.....
246f	8533	Needle Clamp Screw for 15069.....
251f	8533	" Bar Thread Guard Screw.....
263i	8529	Pressure Regulating Thumb Screw.....
286b	8534	Arm Side Cover Thumb Screw.....
290e	8533	Needle Bar Screw Bushing.....
290e	8533	Presser Bar Screw Bushing.....

NO.	PLATE	NAME
307c	8534	Feed Rock Shaft Screw Centre.....
330d	8530	Shuttle Race Cover Spring Screw for 63543
335d	8531	“ “ Cap Screw for 63543.....
356c	8533	Rock Shaft Knece Arm Hub Set Screw for 2766.....
356c	8533	Rock Shaft Knee Plate Set Screw for 2767
356c	8533	“ “ Lifting Bracket Hook Set Screw for 6337.....
356c	8533	Rock Shaft Lifting Bracket Set Screw for 6337.....
356c	8533	Rock Shaft Stop Dog Set Screw for 2770.
375c	8534	Crank Connecting Rod Hinge Screw.....
378c	8534	Feed Connecting Link Hinge Screw.....
378c	8534	“ Forked Connection Hinge Screw....
418E	8532	Bobbin Winder Tension Screw Stud for 27308.....
435c	8533	Arm Shaft Bushing Set Screw for 125002
448c	8533	Balance Wheel Set Screw for 2138.....
448c	8533	Bed Frame Hinge Connection Set Screw
448c	8533	Clamp Carrier Regulator Hinge Stud Set Screw.....
448c	8533	Feed Eccentric Set Screw for 17042.....
448c	8533	Presser Bar Lifter Hinge Stud Set Screw for 125002.....
448c	8533	Tension Screw Stud Set Screw for 63515..
450c	8533	Arm Shaft Bushing (back) Set Screw for 2860, obsolete.....
453c	8533	Clamp Pressure Roller Bracket Set Screw for 63513.....
453c	8533	Presser Bar Lifting Bracket Set Screw for 2952.....
460c	8532	Thread Retaining Stud Set Screw for 63515.....
462c	8533	Oscillating Shaft Crank Set Screw for 15165.....
462c	8533	Shuttle Driver Set Screw for 2441.....
570c	8533	Needle Bar Connecting Link Hinge Screw
591F	8530	Shuttle Tension Regulating Screw for 15727.....
592E	8530	Shuttle Bobbin Case Latch Stop Screw for 15727.....
600c	8532	Tension Screw Stud for 63515.....
635c	8529	Oscillating Rock Shaft Hinge Pin Screw Bearing.....
648J	8534	Shuttle Race Back Spring Screw for 63543
650d	8534	Bed Frame Thumb Screw for 63544.....
660d	8534	Clamp Carrier Lever Hinge Screw.....

NO.	PLATE	NAME
735c	8533	Clamp Arm Hinge Block Pin Set Screw for 63504.....
747D	8534	Feed Regulator Thumb Screw.....
802D	8534	Lifting Lever Hinge Screw for 63546 and 63555.....
870F	8534	Feed Wheel Driving Lever Link Hinge Screw for 63522.....
930E	8534	Needle Bar Connecting Link Adjusting Screw for 15248.....
1035c	8529	Oscillating Shaft Crank Slide Block Screw Stud for 15171.....
1058c	8534	Presser Bar Lifter Screw, obsolete.....
1209c	8533	Guide Screw.....
1236c	8527	Clamp Carrier Regulator Screw Stud....
1293c	8534	Thread Take-up Cam Position Screw for 15275.....
1513J	8533	Feed Rock Shaft Screw Centre Nut.....
1513J	8533	Oscillating Rock Shaft Hinge Pin Nut
1513J	8533	“ “ “ “ Screw Bearing Nut.....
1518E	8533	Crank Connecting Rod Hinge Screw Nut
1518E	8533	Feed Wheel Hinge Screw Nut.....
1519E	8533	Oscillating Shaft Crank Slide Block Screw Stud Nut for 15165.....
1520E	8533	Feed Connecting Link Hinge Screw Nut
1520E	8533	“ Forked Connection Hinge Screw Nut
1520E	8533	Needle Bar Connecting Link Hinge Screw Nut.....
1520E	8533	Presser Bar Lifter Screw Nut, obsolete...
1521E	8533	Feed Wheel Driving Lever Link Hinge Screw Nut for 50336.....
1560c	8532	Tension Regulating Thumb Nut for 63515
1562J	8533	Bobbin Winder Tension Regulating Thumb Nut for 27308.....
1620J	8533	Bobbin Winder Frame Hinge Screw Nut for 27647.....
1658J	8527	Clamp Carrier Regulator Screw Stud Thumb Nut.....
1822	8533	Thread Take-up Lever Roller and Stud for 15071 and 15491.....
1877	8533	Clamp Carrier Regulator Roller and Screw Stud for 63509.....
2002	8534	Arm Dowel Pin.....
2006	—	“ Shaft Bushing (back) for 2860, obsolete.....
2039	8528	Feed Connecting Link.....
2049	8529	Oscillating Shaft Crank Pin.....

NO.	PLATE	NAME
2049	8529	Shuttle Driver Pin.....
2050	8525	Needle Bar.....
2052	8529	“ “ Connecting Stud with 155c ..
2062	8529	Presser Bar Lifter.....
2070	8529	“ “ Spring Washer.....
2102	8532	Tension Disc for 63515.....
2103	8532	“ Spring for 63515.....
2105	8532	“ Thread Guard for 63515.....
2106	8532	Bobbin Winder Tension Thread Guide for 27308.....
2107	8529	Face Plate Thread Guard for 63515.....
2111	—	Thread Retainer Guide complete for 63515, Nos. 2112, 2114 and 2115.....
2112	8532	Thread Retaining Disc with 2113, for 2111
2113	8532	“ “ “ Steady Pin for 2112
2114	8532	“ “ Spring for 2111.....
2115	8532	“ “ Stud for 2111.....
2127	8532	“ Take-up Spring Regulator Plate for 63515.....
2138	8526	Balance Wheel (power) light rim, 3 in. pul- ley, with two 448c.....
2269	8532	Tension Releaser Hinge Pin for 63515....
2308	8529	Presser Bar Spring.....
2441	8532	Shuttle Driver 2542 with two 462c.....
2455	8532	Bobbin Winder Tension Disc for 27308....
2515	8530	Shuttle Body for 63535.....
2523	8530	“ Bobbin Case Position Finger Rivet for 15727.....
2532	8531	Shuttle Race Back Position Pin for 63543
2533	8531	“ “ “ Spring for 63543.....
*2542	—	“ Driver for 2441.....
2718	8533	Feed Wheel Hinge Screw Nut Washer....
2763	8536	Rock Shaft for 2781 and 63554.....
		Nos. 2765 TO 2767 FOR 2768
2765	8533	Rock Shaft Knee Arm.....
2766	8536	“ “ “ “ Hub with 356c....
2767	8536	“ “ “ Plate with 356c.....
2768	—	Rock Shaft Knee Arm complete for 2781, Nos. 2765 to 2767.....
2770	8536	Rock Shaft Stop Dog with 356c, for 2781 and 63554.....
2775	8536	Lifting Lever for 63546 and 63555.....
2781	8536	Rock Shaft complete for 63546, Nos. 2763, 2768, 2770, 6337, 12243 and two 6334..
*2803	—	Arm Shaft Bushing (front) for 2860, ob- solete.....

NO.	PLATE	NAME
2811	8526	Crank Connecting Rod with 2812 and two 158E.....
*2812	—	Crank Connecting Rod Cap for 2811.....
*2860	—	Arm with 450c, 2006 and 2803, obsolete, use 125002.....
2866	8526	Face Plate for 63515.....
2870	8532	Tension Releaser for 63515.....
2952	8529	Presser Bar Lifting Bracket with 453c....
2973	8530	Shuttle Bobbin Case Latch Lever for 15141.....
2974	8530	Shuttle Bobbin Case Latch Lever Fulcrum Pin for 15141.....
2975	8530	Shuttle Bobbin Case Latch Spring for 15727.....
2976	8530	Bed Frame Hinge Connection for 63544..
2996	8530	Shuttle Bobbin for 63535.....
3052	8529	Oscillating Rock Shaft Hinge Pin.....
4784	8532	“ “ “ Oil Pad (felt) for 63532.....
4879	8536	Chain Connecting Link for 4885.....
		Nos. 1881 TO 4884 FOR 4885
4881	8536	Treadle.....
4882	8526	“ Shaft.....
4883	8526	“ Spring.....
4884	8536	“ Stand.....
4885	8536	Treadle complete for 63555, Nos. 4879, 4881 to 4884 and two wood screws 1 in. No. 16.....
5670	—	Chain, length 26 in. to 35 in., with 56864 and 56865, for 63555.....
6334	8536	Rock Shaft Hanger with two wood screws 1 in. No. 10, for 2781 and 63554.....
6337	8536	Rock Shaft Lifting Bracket with two 356c, for 2781 and 63554.....
7070	8527	Clamp Carrier Regulator Screw Stud Sleeve.....
7553	8530	Shuttle Bobbin Case Position Finger for 15727.....
8217	8527	Feed Regulator Hinge Screw Friction Washer.....
8879	8530	Arm Spool Pin Washer (cloth).....
8908	5901	Wrench for 1519 and 1520 (Accessories)..
8909	5901	“ “ 1513 and 1518 (Accessories)..
10141	8532	Bobbin Winder Tension Spring for 27308
10243	7661	Thread Unwinder Spool Weight for 41547

NO.	PLATE	NAME
11241	1417	Bobbin Winder Spool Washer (cloth) for 27308.....
12243	8536	Rock Shaft Lifting Bracket Hook for 2775 for 2781 and 63554.....
12403	8529	Arm Spool Pin and Thread Eyelet.....
12424	8529	Oscillating Shaft Crank Slide Block Cap Screw Washer for 15171.....
14008	8534	Bed Frame Hinge Connection Pin for 63544.....
15068	8529	Needle Bar Thread Guard.....
15069	8529	" Clamp with 246e.....
15071	—	Thread Take-up Lever with 1822, obsolete.....
15072	8530	Bobbin Winder Bobbin Position Pin for 27538.....
15098	8530	Shuttle Tension Spring for 15727.....
15140	8530	" Bobbin Case Latch for 15141.....
15141	—	" " " Hinge, Nos. 2973, 2974 and 15140, for 15727.....
15165	—	Oscillating Shaft Crank complete, Nos. 1519e, 15171, 15426 and two 462c.....
15170	8529	Oscillating Shaft Crank Slide Block for 15171.....
15171	—	Oscillating Shaft Crank Slide Block complete for 15165, Nos. 229d, 1035c, 12424 and 15170.....
15196	8525	Arm Side Cover.....
15248	8529	Needle Bar Connecting Link with 930e.....
15268	—	Arm Shaft, obsolete.....
15275	8525	Thread Take-up Cam with 1293c.....
15426	8529	Oscillating Shaft Crank for 15165.....
15486	8529	Presser Bar Lifter Hinge Stud for 125002.....
15491	8532	Thread Take-up Lever with 1822.....
15498	8525	Arm Shaft Bushing for 125002.....
15727	8530	Shuttle Bobbin Case complete for 63535, Nos. 591e, 592e, 2523, 2975, 7553, 15098 and 15141.....
17042	8528	Feed Eccentric with 448c.....
19079	8526	Wrench for 1209 (Accessories).....
21516	8530	Shuttle Race Cover Bracket Hinge Pin for 63543.....
23390	8533	Guide Screw Washer.....
24788	8534	Bed Frame Cushion (leather) for 63544.....
26026	5901	Screw Driver, machine (Accessories).....
26092	8530	Shuttle Race Cover Bracket Rivet for 63540.....
26485	5901	Screw Driver, shuttle tension (Accessories)

NO.	PLATE	NAME
27302	1417	Bobbin Winder Frame for 27647.....
27303	8532	" " " Spring for 27647..
27306	1417	" " Spool Pin for 27308.....
27307	1417	" " " Stand for 27308...
27308	1417	Bobbin Winder Spool Stand complete for 27544, Nos. 418e, 1562j, 2106, 10141, 11241, 27306, 27307 and two each 2455 and wood screws 1 in. No. 10.....
27312	1417	Bobbin Winder Stop Latch for 27647....
27442	7661	Thread Unwinder Spool Rest with 27702, for 41807.....
27446	7661	Thread Unwinder Thread Eyelet Wire for 27448.....
27447	7661	Thread Unwinder Thread Eyelet Rod for 27448.....
27448	—	Thread Unwinder Thread Eyelet complete for 41807, Nos. 27446 and 27447.....
27538	1417	Bobbin Winder Spindle with 15072, for 27647.....
27540	1417	Bobbin Winder Base for 27647.....
27541	1417	" " Pulley for 27647.....
27544	—	Bobbin Winder (swinging automatic, right hand) complete, Nos. 27308 and 27647
27647	1417	Bobbin Winder for 27544, Nos. 35d, 1620j, 27302, 27303, 27312, 27538, 27540, 27541, 50356d and two wood screws 1 in. No. 7.
27702	7661	Thread Unwinder Spool Pin for 27442...
36578	5901	Oiler (copper plated) with 36579 (Accessories).....
36579	5901	Oiler Spout, 3½ in. long, with 120117, for 36578.....
41541	7661	Thread Unwinder Thread Guide with 41542, for 41807.....
41542	8534	Thread Unwinder Thread Guide Centre Pin for 41541.....
41546	8534	Thread Unwinder Spool Weight Centre Pin for 41547.....
41547	7661	Thread Unwinder Spool Weight complete for 41807, Nos. 10243 and 41546.....
41807	7661	Thread Unwinder complete, for one small spool, Nos. 27442, 27448, 41541, 41547 and two wood screws ¾ in. No. 10....
50335d	8533	Clamp Check Hinge Screw.....
50336f	8534	Feed Wheel Driving Lever Link Hinge Screw for 63518.....
50337c	8534	Feed Wheel Hinge Screw.....
50353e	8534	" Regulator Hinge Screw.....

NO.	PLATE	NAME
50356d	8534	Bobbin Winder Frame Hinge Screw for 27647.....
50527c	8534	Thread Take-up Lever Hinge Screw.....
51815	8533	Clamp Carrier Roller and Screw Stud for 63506.....
51816	8533	Clamp Pressure Roller and Stud for 63513
52877f	8527	“ Carrier Regulator Hinge Stud.....
55645	8532	Thread Take-up Spring for 63515.....
56864	8526	Chain Hook (large) for 5670.....
56865	8530	“ “ (small) for 5670.....
*63501	---	Bed.....
63502	8527	Clamp Arm.....
63503	8527	“ “ Bracket.....
63504	8527	“ “ Hinge Block with 735c.....
63505	8527	“ “ “ “ Pin.....
63506	8525	“ Carrier with 51815.....
63507	8527	“ “ Cap.....
63508	8525	“ “ Lever.....
63509	8527	“ “ Regulator with 238E and 1877.....
63510	8527	Clamp Carrier Regulator Slide Block....
63511	8527	“ Cheek.....
63512	8527	“ Pressure Arm.....
63513	8527	“ “ Roller Bracket with 453c and 51816.....
63514	8527	Clamp Spring.....
63515	---	Face Plate complete, Nos. 448c, 460c, 600c, 1560c, 2103, 2105, 2107, 2111, 2127, 2269, 2866, 2870, 55645 and two each 233d and 2102.....
63516	8526	Feed Forked Connection.....
63517	8528	“ Regulator.....
63518	8528	“ Rock Shaft for 63519.....
63519	---	Feed Rock Shaft complete, Nos. 63518 and 63520.....
63520	8528	Feed Rock Shaft Crank with 157E, for 63519.....
63521	8525	Feed Wheel.....
63522	8528	“ “ Driving Lever.....
63523	8528	“ “ “ “ Block.....
63524	8528	“ “ “ “ “ Cap....
63525	8528	“ “ “ “ “ Spring..
63526	8528	“ “ “ “ “ Link.....
63527	8528	“ “ Retaining Clutch.....
63528	8528	“ “ “ “ Bracket..
63529	8528	“ “ “ “ Cap.....
63530	8528	“ “ “ “ Spring...

NO.	PLATE	NAME
63531	8528	Guide.....
63532	8525	Oscillating Rock Shaft with 4784.....
63533	8525	“ Shaft.....
63534	8525	Presser Bar.....
63535	---	Shuttle, 1 $\frac{1}{4}$ in. diam., Nos. 2515, 2996 and 15727.....
Nos. 63536 to 63538 FOR 63543		
63536	8531	Shuttle Race Back.....
63537	8531	“ “ Body.....
63538	8531	“ “ Cap.....
63539	---	“ “ Cover for 63540.....
63540	8530	“ “ “ 63539 with 63541 and two 26092, for 63543.....
63541	---	Shuttle Race Cover Bracket for 63540....
63542	8530	“ “ “ Spring for 63543.....
63543	---	Shuttle Race complete, Nos. 330d, 648J, 2533, 21516, 63536 to 63538, 63540, 63542 and two each 335d and 2532....
63544	8535	Bed Frame with 650d, 63545, two each 2976, 14008 and four each 24788 and wood screws 1 $\frac{1}{4}$ in. No. 12.....
63545	8535	Drip Pan for 63544.....
63546	---	Knee Lifter complete, Nos. 802d, 2775 and 2781.....
63553	8536	Rock Shaft Lifting Bracket Hook for 5670 for 63554.....
63554	8536	Rock Shaft complete for 63555, Nos. 2763, 2770, 12243, 63553 and two each 6334 and 6337.....
63555	---	Foot Lifter complete, Nos. 802d, 2775, 4885, 5670 and 63554.....
120117	5901	Oiler Spout Washer (leather) for 36579...
*125001	---	Arm for 125002.....
125002	---	“ 125001 with 435c, 448c, 15486 and 15498.....
125003	8525	Arm Shaft.....

**ILLUSTRATIONS OF PARTS
FOR
MACHINE No. 116-1**

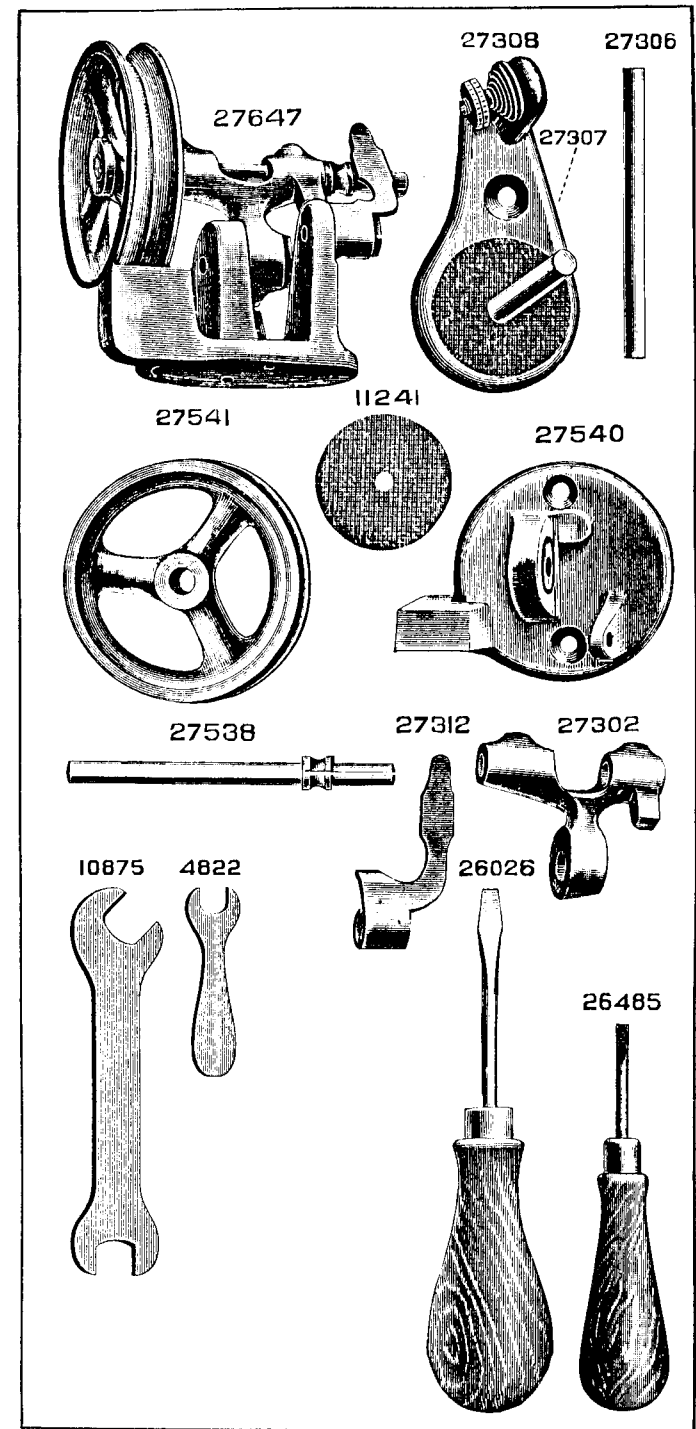

PLATE 5901—ONE-HALF SIZE

26026



26485



8909



8908

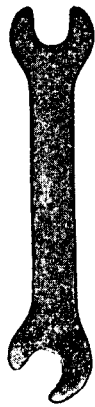

4822



120117

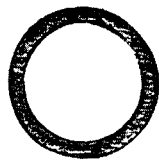

36578

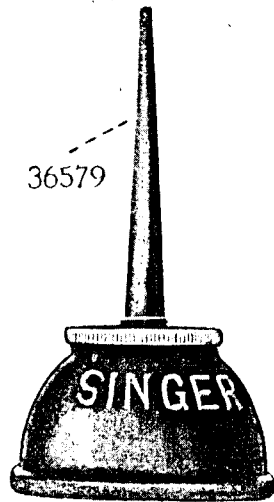

36579

PLATE 7661—ONE-HALF SIZE

41807

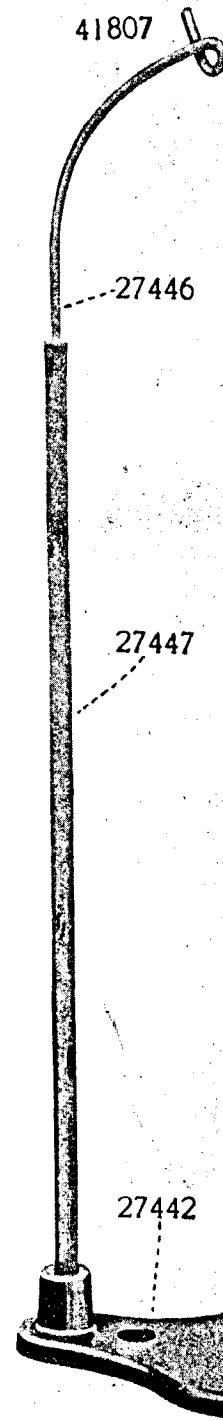

27446

41547



10243

27447

41541

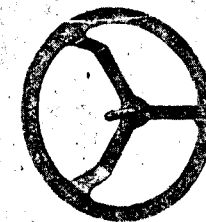

27442

27702

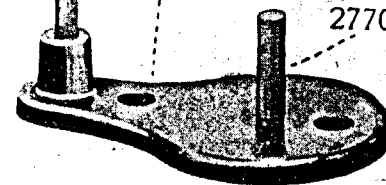

PLATE 8525—ONE-HALF SIZE

125003 63533 2050 63534 15196

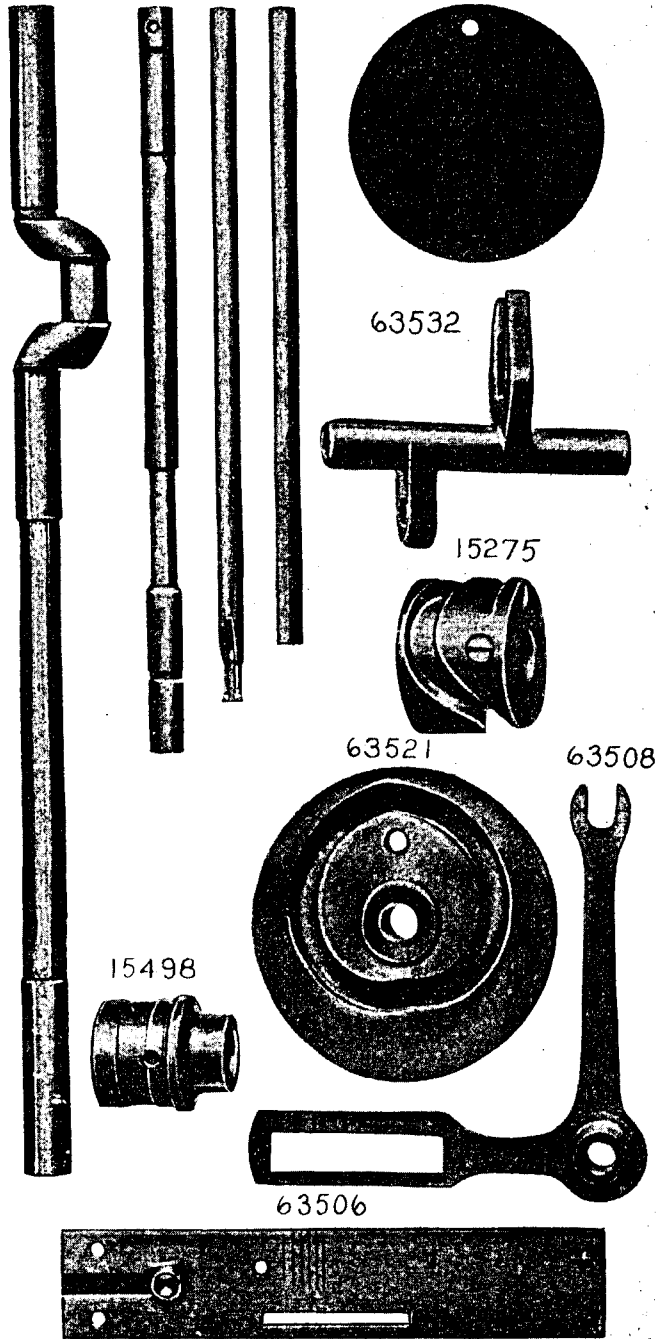

PLATE 8526—ONE-HALF SIZE

2138

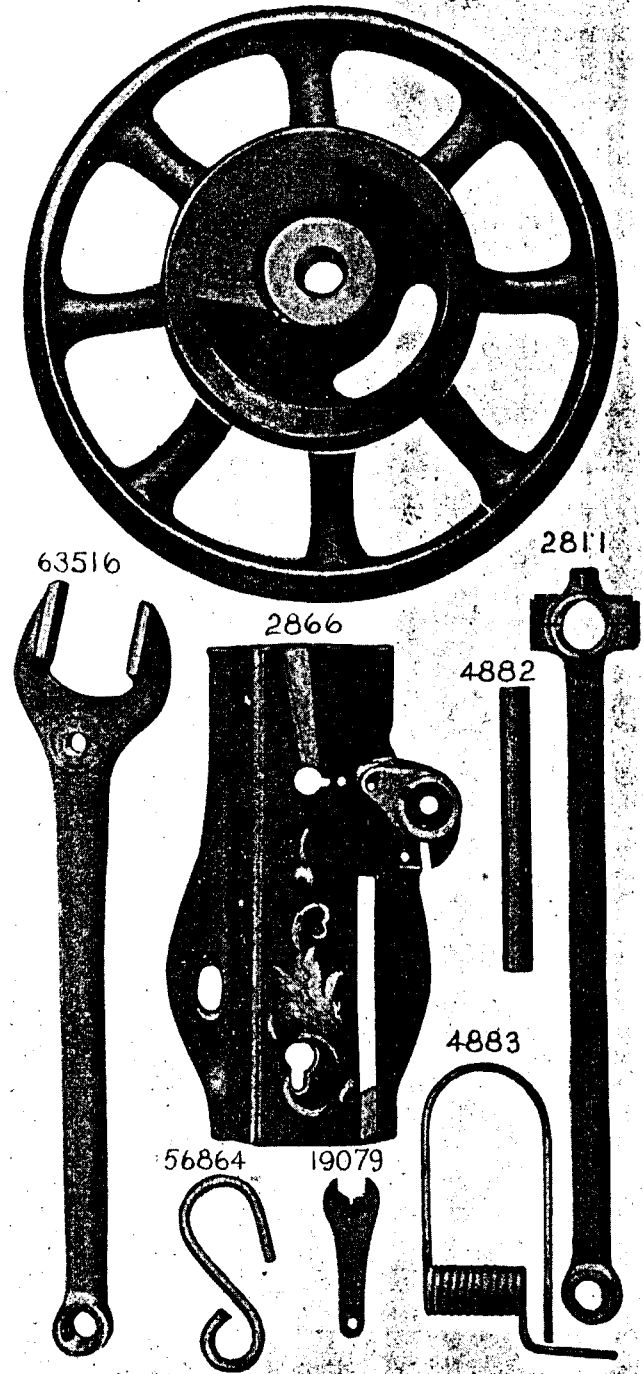

PLATE 8527—FULL SIZE

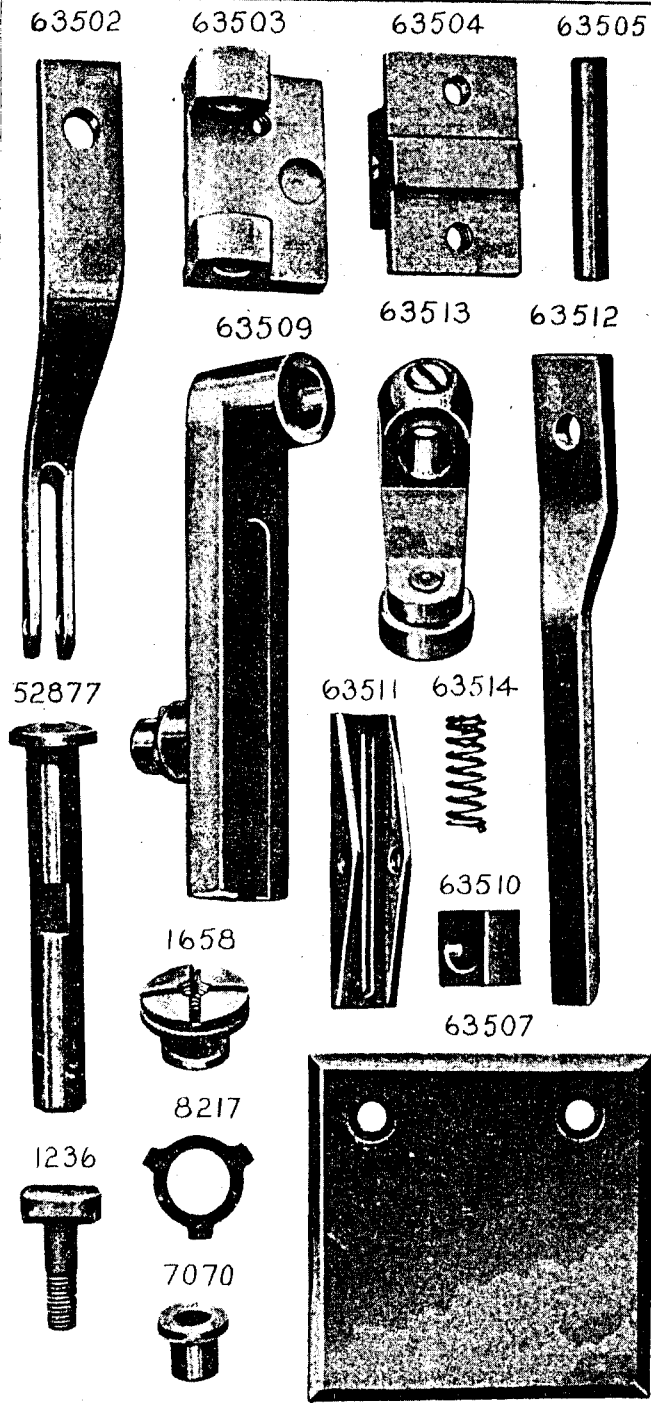

PLATE 8528—FULL SIZE

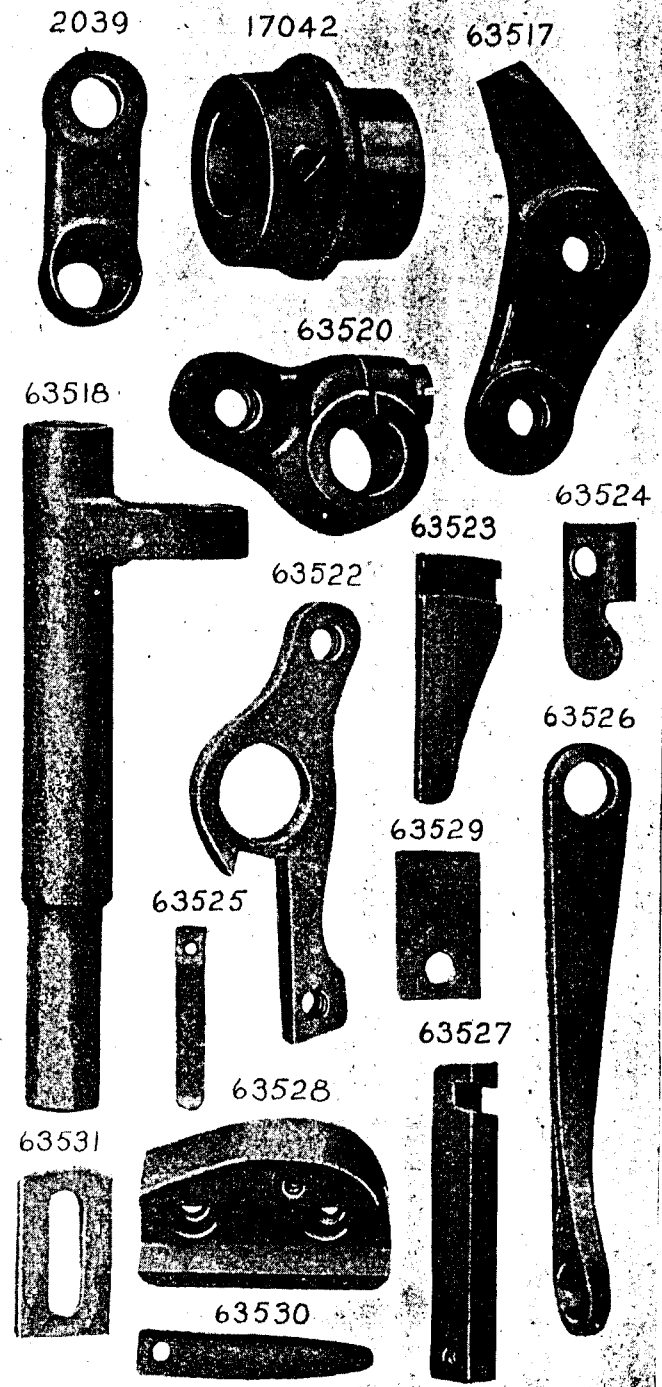

PLATE 8529-FULL SIZE

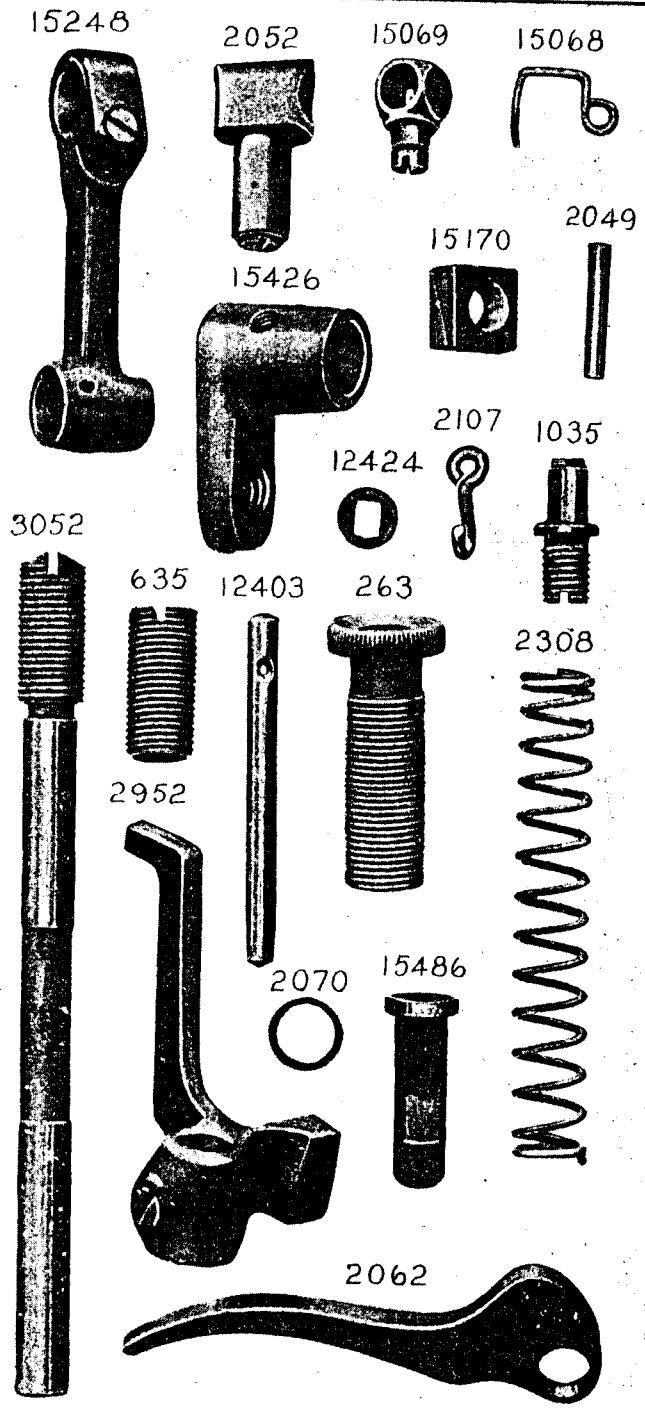

PLATE 8530-FULL SIZE

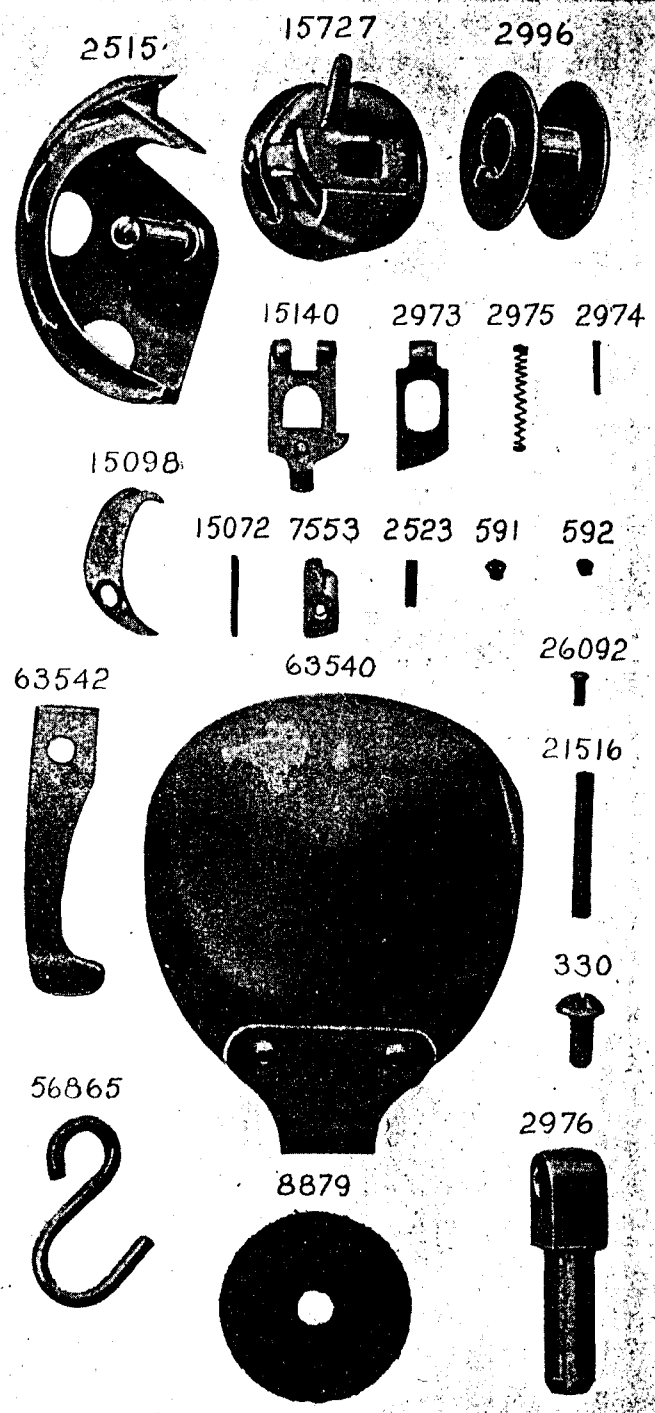
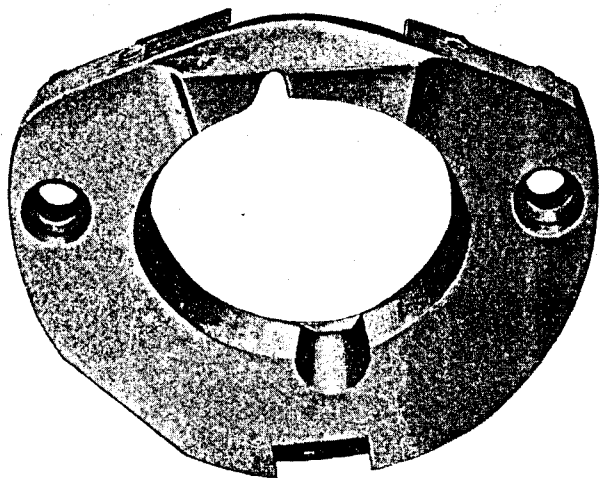

PLATE 8531—FULL SIZE

63537



63538



63536

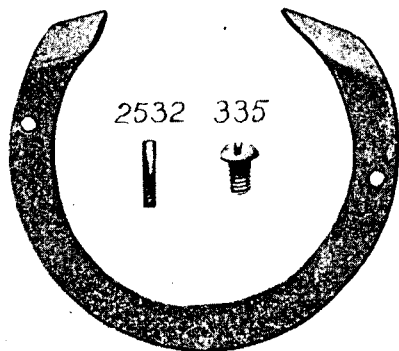

2532 335



2533

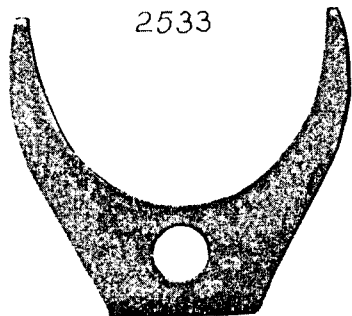
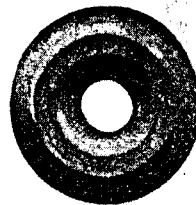

PLATE 8532—FULL SIZE

2102



2870



2105



2103

600



1560



2269



2112



2113



2115



2114 460



2441

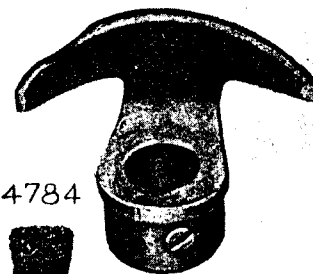

10141



418



2455



2106



4784



2127



27303



55645



15491



PLATE 8533—FULL SIZE

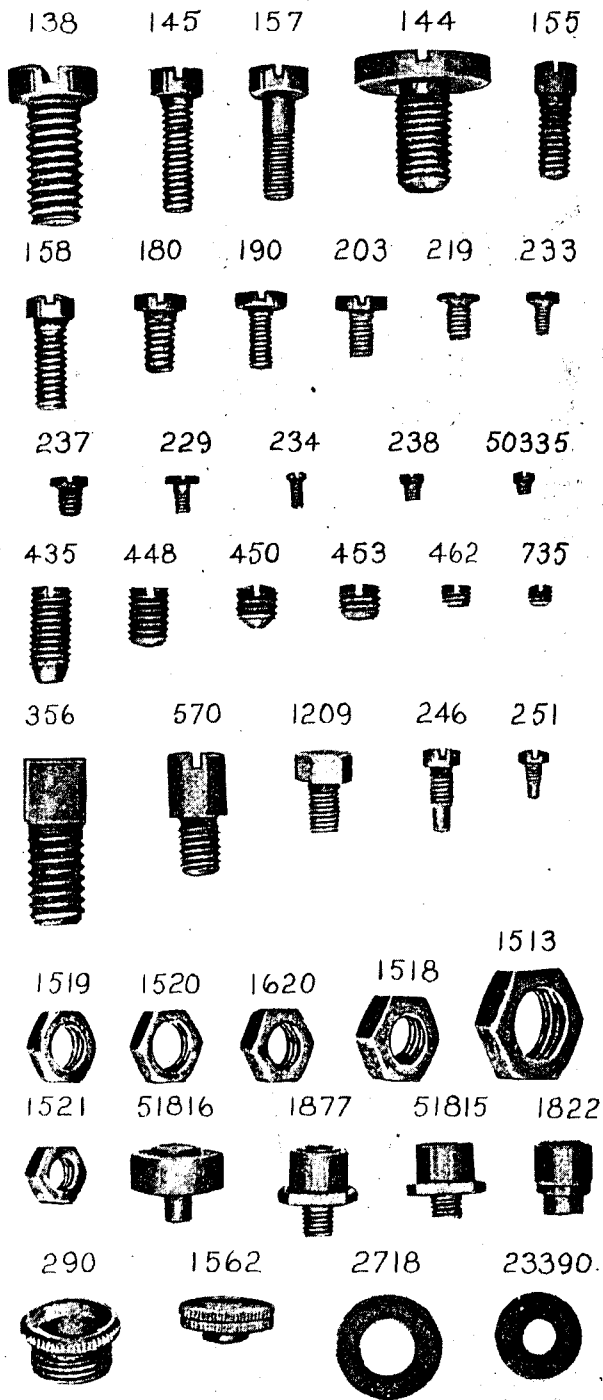

PLATE 8534—FULL SIZE

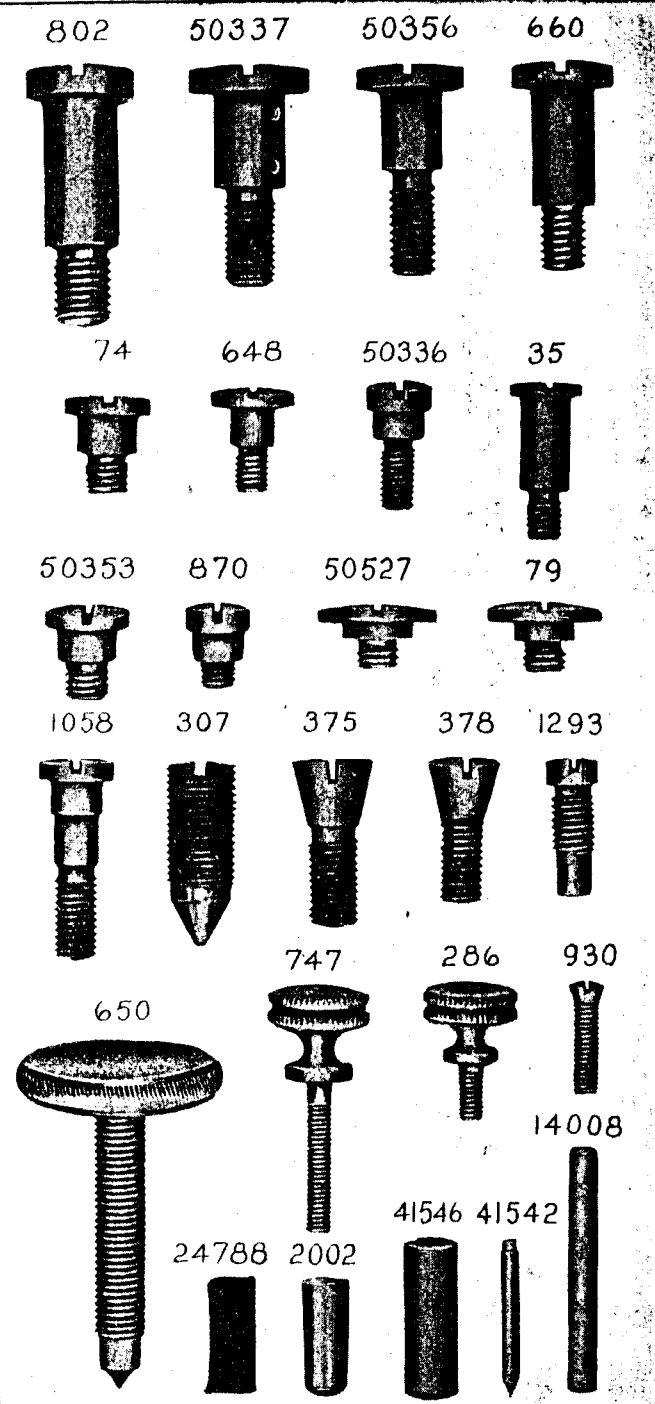
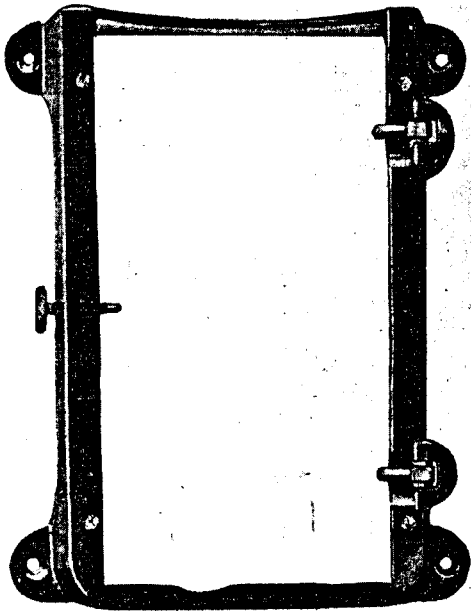

PLATE 8535—ONE-FOURTH SIZE

63544



63545

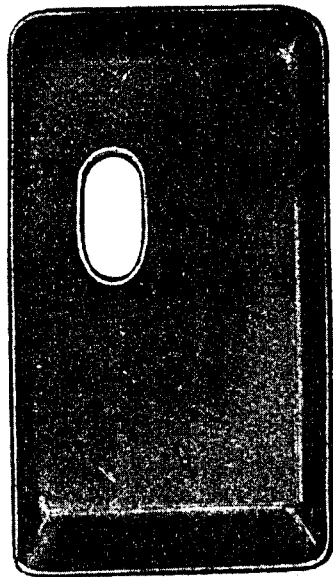

PLATE 8536—ONE-FOURTH SIZE

63554

