

Service Manual and Parts List

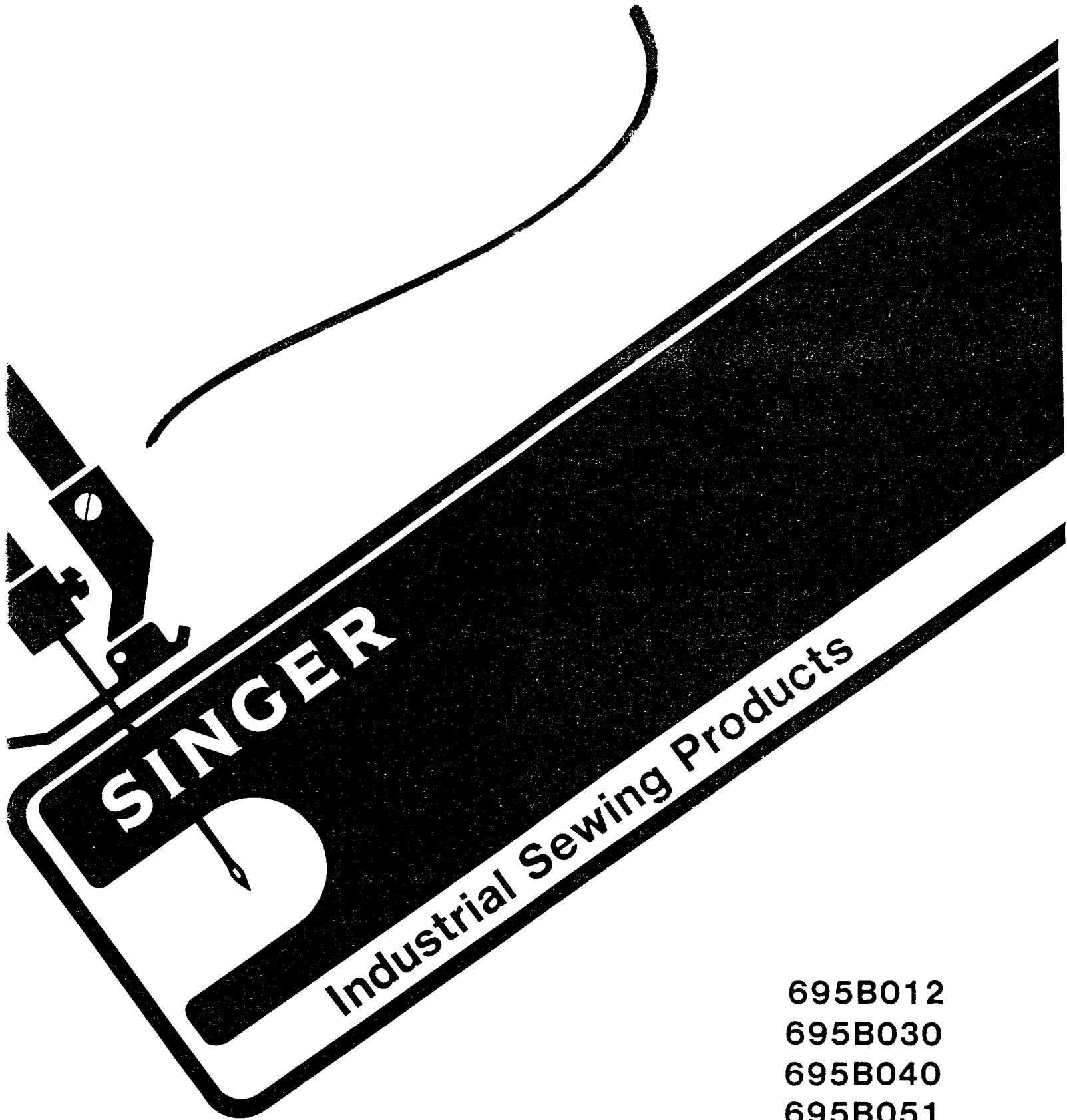

695B012

695B030

695B040

695B051

IDENTIFICATION OF MACHINES

Each 695B machine is identified by a Variety number on a metal plate on the machine.

APPLICATION OF CATALOG

This catalog is a supplement to Form No. IPD659-78 and should be used in conjunction therewith. Only those parts used on 695B012, 030, 040 and 051, but not on 695B010 are illustrated and listed at the back of this catalog. On the page opposite the illustration will be found a listing of the parts with their part numbers, description and the number of pieces required. Numbers in the first column are reference numbers only, and merely indicate the position of that part in the illustration.

This catalog applies specifically to the standard Varieties of machines as listed herein. References to directions, such as right, left, front, back, etc., are given from the operator's position while seated at the machine. Operating direction of handwheel is away from operator.

MACHINES

Ultra High Speed, Single Curved Needle, One Looper - One Spreader Two Thread and Two Looper Three Thread Machines, Differential Feed, Trimming Mechanism with Spring Pressed Lower Knife, Automatic Lubricating System. Improved Air Cooling System.

- 695B012 Light to medium duty, one looper, one spreader, two thread overseaming machine for blind stitch welting or hemming on light weight rayon, silk, cotton, wool and nylon flat, warp and ribbed knit material used on panties, slips, night-gowns, tee, athletic and polo shirts. Equipped with knee press operated retractable hemming guide to assure positive needle penetration of garment body when crossing seams. Seam specification, 503-EFc-1; stitch range, 8-30 per inch; cam adjusted main and differential feeds. Maximum recommended speed 8000 R. P. M.
- 695B030 Same as 695B012, except without the retractable hemming guide, but fitted with a compact hemming guide assembly, a long stitch tongue throat plate and a short stitch tongue presser foot, which allows maximum looper point clearance. Also fitted with an upper looper and a lower spreader, thus the threading of this machine is easier because the looper is threaded from the top. Seam specification, 503-EFc-1; stitch range, 8-30 per inch; cam adjusted main and differential feeds. Maximum recommended speed 8000 R. P. M.
- 695B040 Same as 695B012, except without the retractable hemming guide, but fitted with a compact hemming guide assembly, a long stitch tongue throat plate and a short stitch tongue presser foot, which allows maximum spreader point clearance. Seam specification, 503-EFc-1; stitch range, 8-30 per inch; cam adjusted main and differential feeds. Maximum recommended speed 8000 R. P. M.
- 695B051 Light to medium duty, two way combination machine, for two or three thread blind hemming or serging small diameter light weight rayon, silk, wool, cotton, flat and ribbed knit materials. Seam specifications, 503-EFc-1 or 505-EFd-1; standard seam width for hemming 1/8 inch (3.17 mm) and for serging 3/16 inch (4.76 mm); stitch range, 8-30 per inch; cam adjusted main and differential feeds. Maximum recommended speed 8000 R. P. M.

SPEED RECOMMENDATION

695B class machines have been tested in their complete stitch range at their maximum rated speeds. Varied field conditions, severity and cleanliness of the sewing operation may necessitate operating at a lower speed. When operating from 50-100% machine running cycle and a longer than recommended stitch length, it may be necessary to reduce the machine's speed by 10-15%.

The 695B is a precision manufactured and tested sewing machine. To obtain maximum performance, the machine should be operated at 1000 R. P. M. below maximum recommended speed for the first 20 days of field operation. This will minimize readjustment of precision mechanisms.

OILING

CAUTION! Oil was drained from machine when shipped, so reservoir must be filled before beginning to operate. Oil capacity of 695B machines is eight ounces. Use Singer Type C oil or equivalent.

Machine is filled with oil at spring cap in top cover. Oil level is checked at sight gauge on front of machine. Red bulb on oil level indicator should show between gauge lines when machine is stationary.

Machine is automatically lubricated. No oiling is necessary, other than keeping main reservoir filled. Check oil daily before the morning start; add oil as required.

To maintain maximum recommended speed and serviceability of this equipment when operating continuously, the oil must be changed at least every six months. In no case should oil remain in machine for more than one year.

The oil drain plug screw is located at back of machine near bottom edge of base. It is a magnetic screw designed to accumulate possible foreign materials which may have entered the crank case. It should be removed and cleaned periodically.

NEEDLES

The standard recommended needle is:

Cat. 1431 - set point - sizes 7 to 23

Also available are:

Cat. 1422 - light ball point - sizes 7 to 23

Cat. 1434 - med. ball point - sizes 10 to 18

Cat. 1436 - heavy ball point - sizes 8 to 16

CHANGING NEEDLES

Release pressure on presser foot by turning presser foot release bushing (AG, Fig. 1, 1A or 1B) and swing presser arm (U) out of position. Turn handwheel in operating direction until needle is at its lowest point of travel. Using hexagonal socket wrench No. 21388 AU, furnished with machine, loosen needle clamp nut about 1/4 turn. Again turn handwheel until needle is at high position; withdraw needle.

CHANGING NEEDLES (Continued)

To replace needle, leave needle holder at high position and with the flat to the left, insert needle in holder until it rests against stop pin. Keeping needle in this position, turn handwheel until holder is again at its low point of travel; then tighten nut. Return presser arm (U) to position; re-lock presser foot release bushing (AG).

THREAD STAND

After thread comes from cones on cone support (A, Fig. 1, 1A or 1B) it is brought up through the back hole of thread eyelet (B), then down through the front hole of thread eyelet. Next, the upper looper thread and the needle thread are threaded through the upper hole of tension thread guide (C) from front to back and then through the lower hole from back to front. The lower looper thread is threaded through the upper hole of the tension thread guide (C) from back to front, through the middle hole from front to back and finally through the lower hole from back to front. All threads then continue between the tension discs (J), through tension post slot (K) in tension post (G) and on through front thread guide (M).

THREADING

Only parts involved in threading are shown in threading diagrams (Fig. 1, 1A and 1B). Parts are placed in their relative positions for clarity. Refer to Fig. 1 for threading of 695B012, 040 and 051 when producing the 503 stitch, Fig. 1A for threading of 695B030 and Fig. 1B for 695B051 when producing the 505 stitch.

It will simplify the threading of these machines when producing a 503 stitch using a lower looper to thread the lower looper first and then the needle. When producing a 503 stitch using an upper looper, thread the upper looper first and then the needle. For machines producing a 505 stitch the recommended sequence is the lower looper first, the upper looper second, and the needle third.

Before beginning to thread, swing cloth plate open and turn handwheel in operating direction until needle (X) is at high position. Now release pressure on presser foot by turning presser foot release bushing (AG) and swing presser arm (U) out of position.

Be sure the threads, as they come from the tension thread guide (C), are between tension discs (J) and in tension post slots (K) in tension posts (G). The tension posts should be positioned so the tension post slot will be at the approximate angle for the different threads as indicated in Fig. 1, 1A and 1B.

TO THREAD THE LOWER LOOPER (695B012, 040 and 051)

Double end of thread and lead it through the right eyelet of front thread guide (M, Fig. 1 or 1B). Then lead thread through both eyes of lower looper thread eyelet (R) from right to left. NOTE: Thread must pass in front of looper thread pull-off (AF). Lead thread behind fabric guard (S) and through frame looper thread guide (T). Turn handwheel in operating direction until heel of lower looper (V) is all the way to the left, then thread through both eyes from left to right. Left eye of lower looper can be threaded easily if tweezers are in left hand.

TO THREAD THE UPPER LOOPER (695B030 and 051)

Double end of thread and lead it through the left eyelet of front thread guide (M, Fig. 1A or 1B). Turn handwheel until point of upper looper (W) is all the way to the left. Lead thread through auxiliary looper thread eyelet (P) from back to front, then through both eyes of upper looper thread eyelet (N) from left to right. NOTE: Thread must pass in front of looper thread pull-off (AF).

After pulling up upper looper thread tube assembly (AA), lead thread under neck of top cover casting and down through thread tube assembly (AA). Pull thread out bottom of tube; push tube down and then insert thread through the eye of upper looper from front to back.

TO THREAD THE NEEDLE (ALL VARIETIES)

Double end of needle thread and lead it through middle eyelet of front thread guide (M, Fig. 1, 1A or 1B). Then turn handwheel in operating direction until needle (X) is at its highest position. Insert needle thread from right to left, through both eyes of needle thread eyelet (AD), under neck of top cover casting; then down through hole in top cover needle thread eyelet (AC). Thread needle from front.

THREAD TENSION

The amount of tension on the needle and looper threads is regulated by knurled tension nuts (D, Fig. 1, 1A or 1B). Tension on threads should be only enough to secure proper stitch formation.

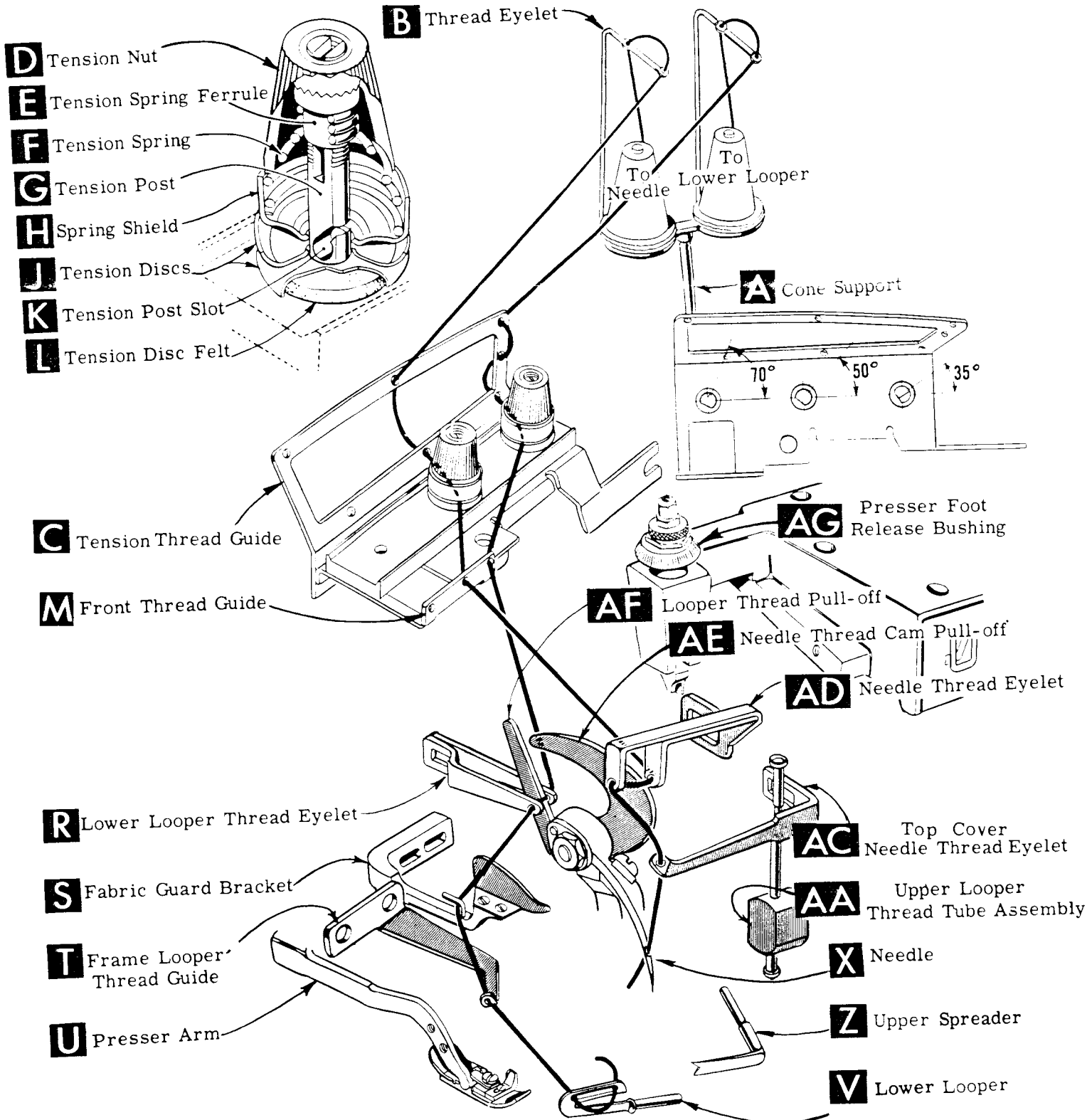

503 STITCH
 FOR 695B012, 040 and 051

Fig. 1

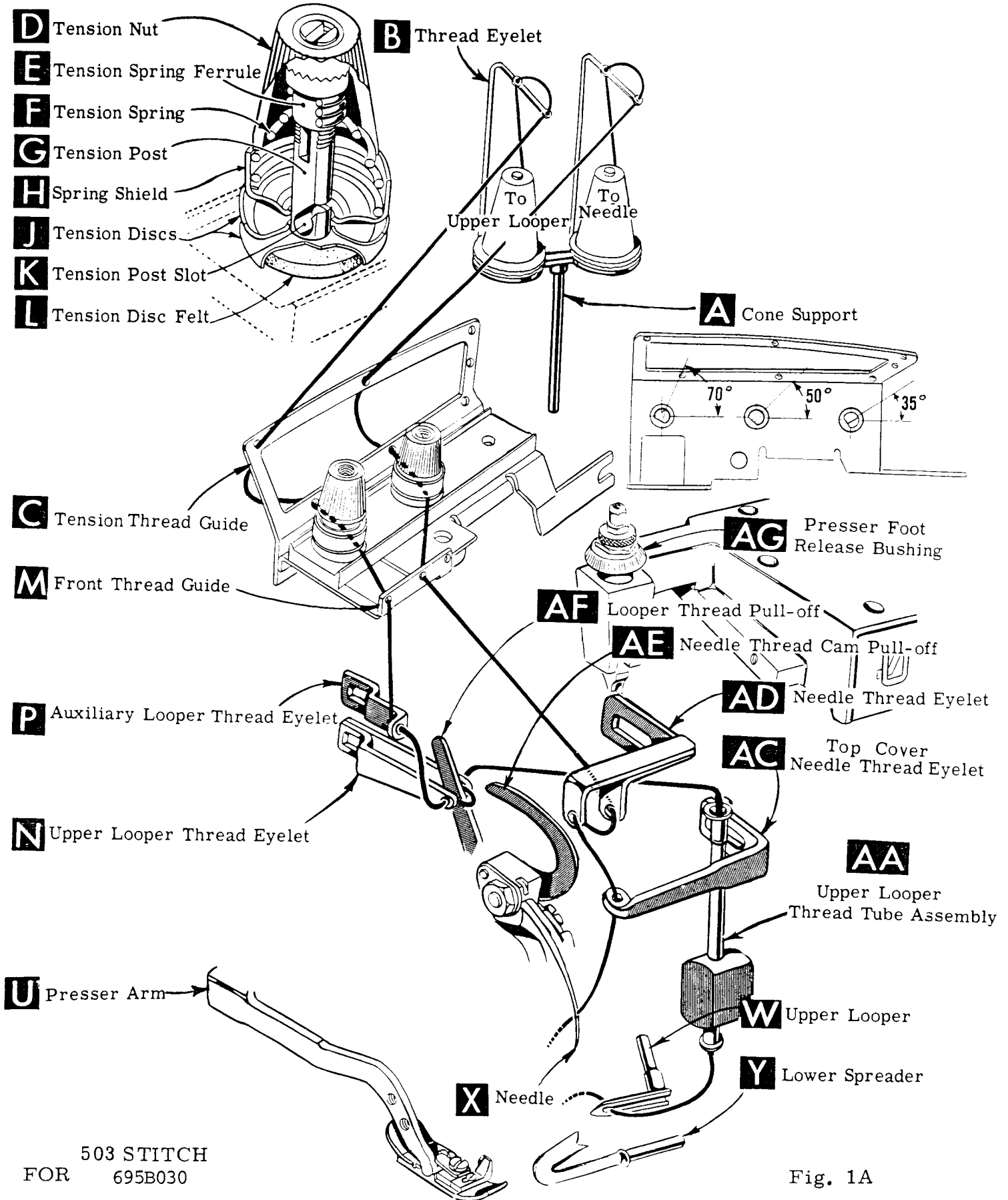
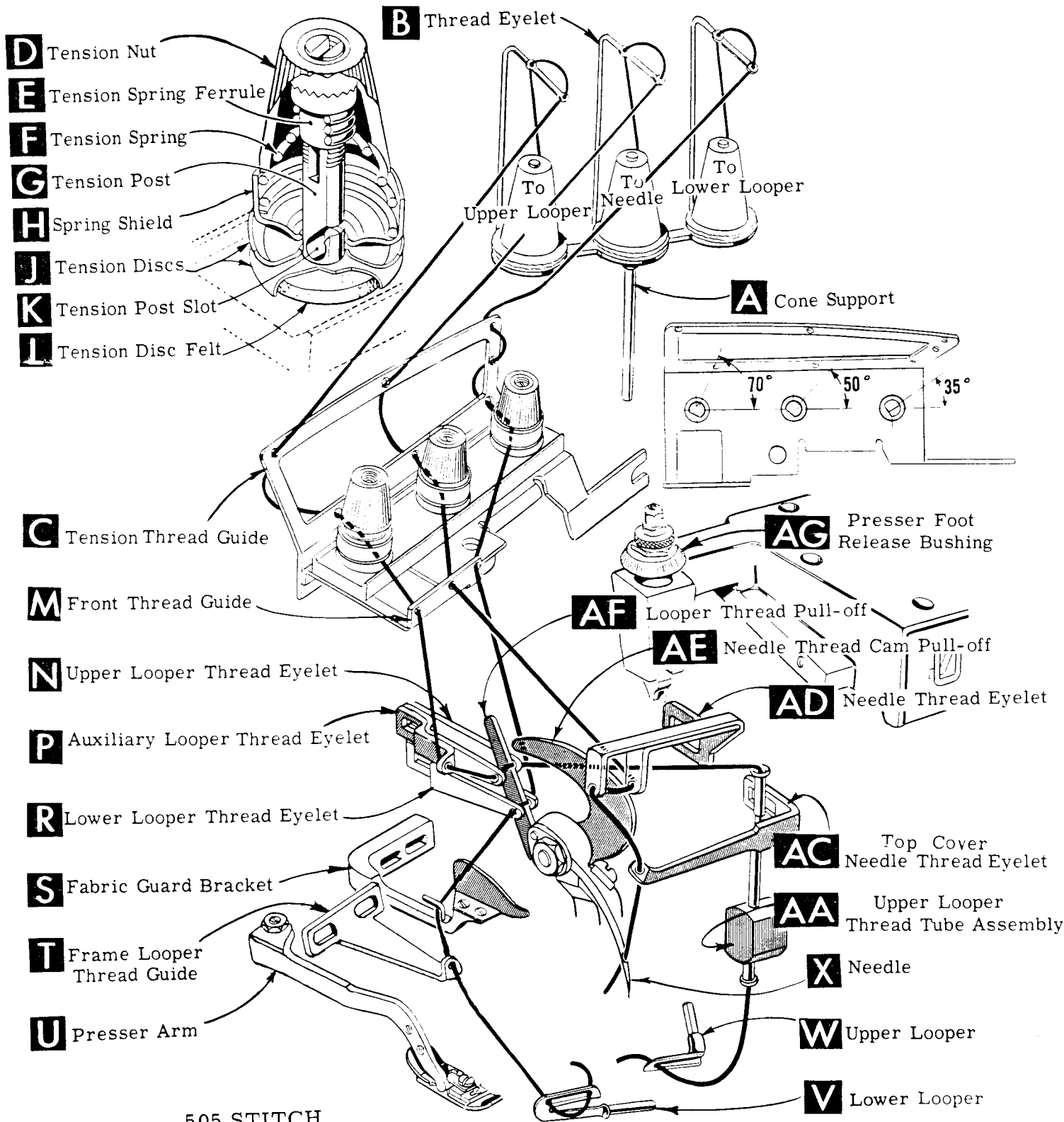

Fig. 1A



505 STITCH
 FOR 695B051

Fig. 1B

PRESSER FOOT PRESSURE

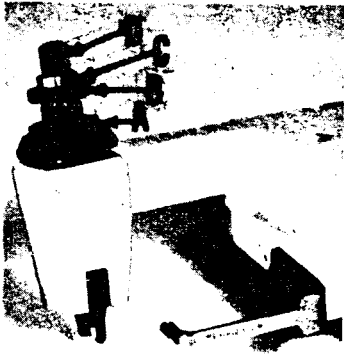

Fig. 2

Sufficient presser foot pressure to feed work uniformly should be maintained. Should it be necessary to increase or decrease amount of pressure on presser foot, loosen lock nut (A, Fig. 2) and turn adjusting screw (B). Adjusting screw has a right hand thread, so tightening increases pressure, loosening decreases pressure. When pressure adjusting screw (B) has been properly set, tighten lock nut (A). With presser foot resting on throat plate, position locking nut (C) so that its under surface is approximately $1/32$ to $1/16$ inch (.79 mm to 1.59 mm) from the top surface of adjusting screw (B). Set cap (D) against locking nut (C).

FEED ECCENTRICS

Feed eccentrics used in these machines have been selected to produce approximately 14 stitches per inch on 695B012, 040 and 051, while on 695B030 the eccentrics have been selected to produce approximately 9 stitches per inch. It will be noted on 695B012, 040 and 051, the part number of the main feed eccentric is No. 39540 B-14, while that of the differential feed eccentric is No. 39540 B-8. On 695B030 the part number of the main feed eccentric is No. 39540 B-9, while that of the differential feed eccentric is No. 39540 B-7. Minor numbers of the part symbol indicate approximately the number of stitches obtainable when using that eccentric. Unless otherwise specified, machines will be shipped with above combinations of eccentrics.

Generally speaking, differential (right hand) feed eccentric determines number of stitches produced; main (left hand) feed eccentric is selected in relation to degree and direction of stretch of material being sewn, or type of operation.

Following stitch number feed eccentrics are available under No. 39540 B-4, 5, 6, 7, 8, 9, 10, 11, 12, 13, 14, 15, 16, 18, 20, 22, 24, 26, 28, 30, 32, 34, 36, 40, 50, 60, 70, 100. Only two eccentrics are supplied with each machine. Additional eccentrics may be ordered separately. To order an eccentric, use No. 39540 B with a minor number suffixed to indicate number of stitches desired. Example: "39540 B-14".

ASSEMBLING AND ADJUSTING SEWING PARTS

Before assembling and adjusting sewing parts, remove cloth plate, fabric guard, chip guard, upper knife assembly, lower knife holder assembly, hemming guide assembly; then follow this suggested sequence.

CLOTH PLATE REMOVAL AND ASSEMBLY

CAUTION: When removing the cloth plate (A, Fig. 3) loosen the cloth plate stud locking screw (B) and lift up cloth plate with the cloth plate stud (C) and cloth plate screw (D) assembled.

In assembly, the cloth plate screw and the cloth plate stud are tightened to the point of removing all play and yet turn in cloth plate. The cloth plate is then assembled to the machine with the flat and "V" slot of the cloth plate stud (C) towards the rear. Stud locking screw (B) is tightened securely which collapses the body of the stud to the screw (D) so that only the cloth plate will turn when opening or closing.

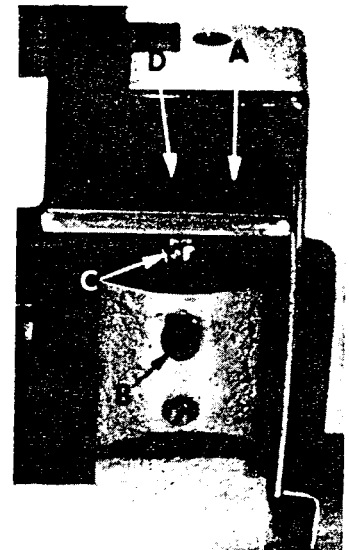

Fig. 3

SETTING THE NEEDLE

With throat plate assembled in position, needle should center in the front end of needle slot. When needle is at high position, needle point should be set $17/32$ inch (13.49 mm) above throat plate (Fig. 4), for 695B012, 030 and 040. This dimension should be $1/2$ inch (12.70 mm) for 695B051. To align needle or set the height above throat plate, move needle driving arm (A, Fig. 4) by loosening clamp screw (B). Remove throat plate, after needle has been set properly and clamp screw (B) has been tightened.



Fig. 4

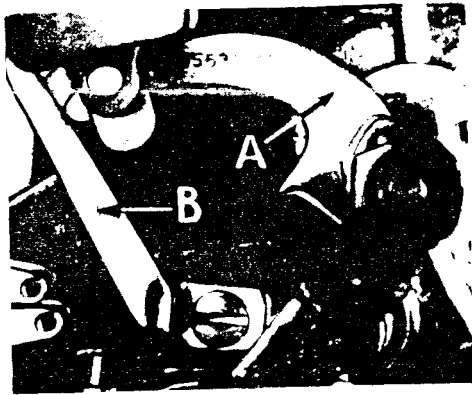

Fig. 5

If needle thread cam pull-off (A, Fig. 5) overlaps looper thread pull-off (B), separate by moving looper thread pull-off back. When re-tightening looper pull-off screw, be sure to take up end play in needle driving arm.

At this point, insert lower looper (A, Fig. 6) on 695B012, 030 and 051 or lower spreader (A, Fig. 6A) on 695B030 into bar (B). With lower looper or spreader at left end of its stroke, set looper or spreader point $3/32$ inch (2.38 mm) from centerline of needle (Fig. 6 or 6A) using looper gauge No. 21225-3/32. Do not have lower looper or spreader deflecting needle. Tighten nut (C). Now assemble differential (front) feed dog.

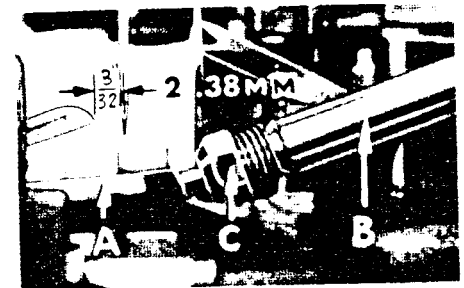

Fig. 6

SETTING THE REAR NEEDLE GUARD

Set rear needle guard (A, Fig. 7) as high as possible, without interfering with either lower looper or spreader or movement of lower knife holder, but still in position to deflect needle forward .002-.004 inch (.051-.102 mm). Screw (B) is used to set rear needle guard. Make sure there is no interference between rear needle guard and lower looper or spreader.

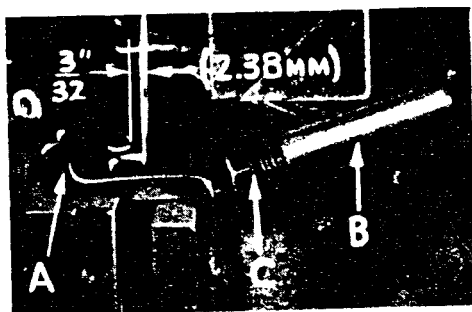

Fig. 6A

SETTING THE LOWER LOOPER OR LOWER SPREADER

Now finish lower looper or spreader adjustment. As lower looper or spreader moves to the right, its point should be set into the needle scarf (A, Fig. 8) until the needle springs forward from rear needle guard surface another .002-.004 inch (.051-.102 mm).

SETTING THE FRONT NEEDLE GUARD

Assemble front needle guard (C, Fig. 7). When lower looper is springing needle off rear guard, set front needle guard as close as possible to needle without touching. Screw (D) is used to adjust and set front needle guard. After this setting, make sure there is no interference between the needle guards and differential feed dog.

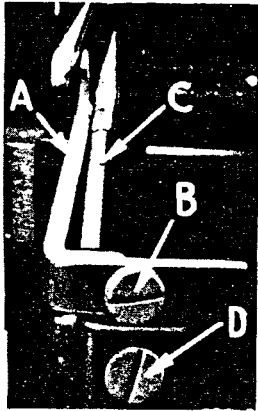

Fig. 7

SETTING THE UPPER LOOPER OR SPREADER

Insert upper looper (A, Fig. 9) or upper spreader in its holder. Screw (B) holds the upper looper or spreader in its holder, and permits the upper looper or spreader to be pushed in or out, or turned around its shank. Insert upper looper or spreader holder into shaft, if not already in place. Screw (C) in clamp collar holds upper looper or spreader holder in the shaft, and allows holder to be rotated or adjusted laterally.



Fig. 8

When the upper looper or spreader is at the right end of its stroke, the upper looper or spreader holder should be set to position the upper looper or spreader shank slightly back of vertical (Fig. 9). Top end of the upper looper or spreader shank should extend $1/32$ to $1/16$ inch (.79 to 1.59 mm) above the upper looper or spreader holder (Fig. 9) on 695B012, 040, and 051. This dimension should be $1/16$ to $3/32$ inch (1.59 to 2.38 mm) on 695B030.

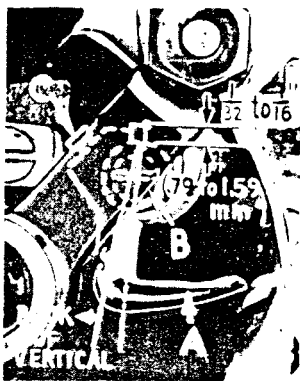

Fig. 9

As the upper looper or spreader moves from right to left, the point of the upper looper or the Vee notch of the spreader should pass just behind the eye of the lower looper, with approximately .002 inch (.051 mm) clearance between the upper looper or spreader and the lower looper (Fig. 10 or 10A).

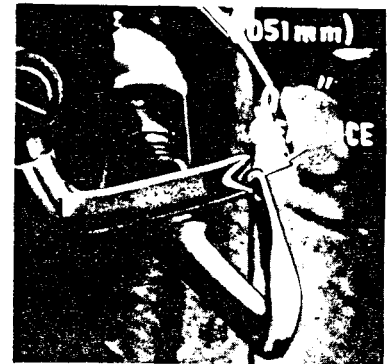

Fig. 10

Turn the handwheel until the upper looper or spreader is at the left end of its travel. At this position, the point of the upper looper or the lower point of the upper spreader should extend about $5/32$ inch (3.07 mm) to the left of centerline of the needle, for all Styles, also $1/2$ inch (12.70 mm) above the top of the throat plate (Fig. 11) for 695B012 and 040; $33/64$ inch (13.10 mm) above the top of the throat plate for 695B030 and $15/32$ inch (11.91 mm) for 695B051 (Fig. 11A).

Now check the setting between upper spreader or upper looper and needle. If needle rubs the back of upper spreader or upper looper, pull spreader or looper out of its holder slightly and rotate holder forward a short distance. These same adjustments, in opposite movement, will reduce the clearance between the upper spreader or upper looper and needle. Reset to maintain dimensions of Fig. 10, 10A, 11 and 11A, as applicable.



Fig. 10A

SETTING FEED DOGS

Now assemble main (back) feed dog (B, Fig. 12) and chaining feed dog (C). Set all feed dogs (A, B, C, Fig. 12) so the top surfaces of the teeth all lie in the same plane. This can be checked by sighting across the teeth with a straight edge. Now assemble throat plate. Feed dogs should now be leveled with throat plate surface by rotating feed tilting adjusting pin (D). This pin raises or lowers the back end of feed bar.

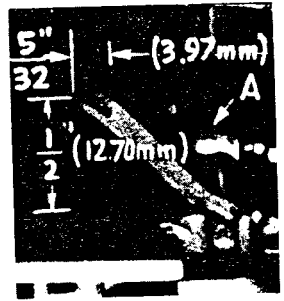

Fig. 11

The feed dogs should be set level at the time the teeth first appear above throat plate. Screw (E) locks feed tilting adjusting pin (D) in place. Now set the main and differential feed dog teeth $\frac{3}{64}$ inch (1.19 mm) above the throat plate, and chaining feed dog teeth flush with surface of throat plate.

SETTING THE LOWER KNIFE

Replace lower knife holder assembly. In replacing the lower knife holder assembly, tighten screw (A, Fig. 13) so that when the face of the flange on sleeve (B) seats against the throat plate mounting bracket (C) a free lateral motion of the lower knife and holder assembly is obtained when the knife is manually pressed at its upper corner. Lower knife (D) should be set with the cutting edge flush with the throat plate surface. Adjustments are made with hexagonal head screw which holds lower knife. Lower knife is spring pressed against upper knife. So no lateral adjustment is necessary when width of trim is changed.

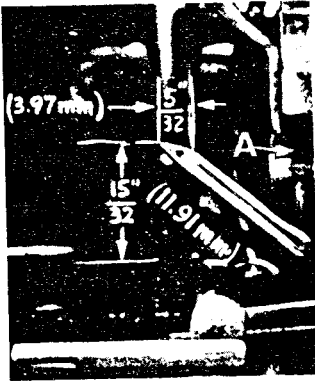

Fig. 11A

Lower knife may be secured in any position by tightening screw (E) against knife holder shaft.

Set the desired width of trim by measuring from the right edge of the lower knife to the needle, lock the lower knife holder shaft with screw (E).

SETTING THE UPPER KNIFE

Replace upper knife assembly. Clamp upper knife (F, Fig. 13) in position, setting nut (G) to hold clamp (H) in its most clockwise position against upper knife. At

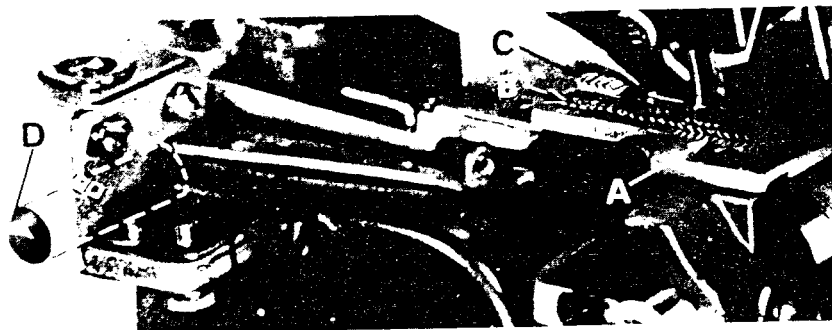

Fig. 12

bottom of its stroke, front cutting edge of upper knife should extend not less than $\frac{1}{64}$ inch (.40 mm) below cutting edge of lower knife. The chain guard should be set down against the upper knife and slightly back from the cutting edge.

SETTING THE UPPER KNIFE (Continued)

After upper knife has been set for proper width of trim, screw (J) should be tightened to lock upper knife holding block (K) in place. This will simplify resetting when upper knife is replaced.

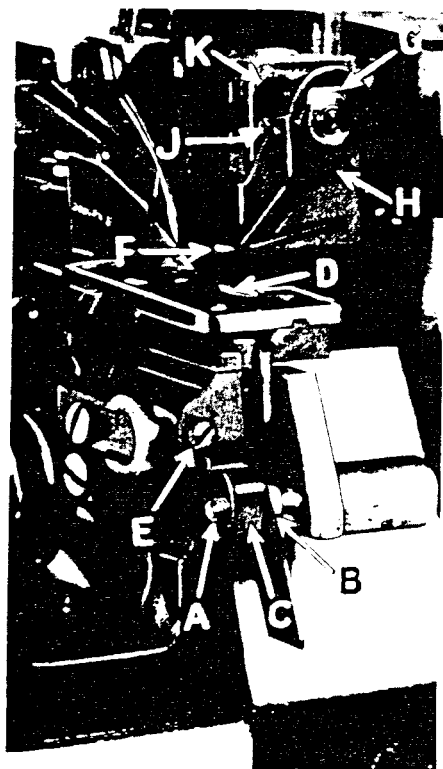

Fig. 13

SETTING THE STITCH LENGTH

Length of stitch is determined by the combination of feed eccentrics used. Outer (left) eccentric (A, Fig. 14) actuates main (rear) feed dog; while the inner (right) eccentric (B) actuates the differential (front) feed dog.

In assembling feed eccentrics, be sure hubs are facing each other. Be careful not to damage shaft or key. Tighten nut (C) securely.

To change feed eccentrics, remove nut (C) and washer (D) from end of shaft (E). Turn handwheel in operating direction until key slot in eccentric is toward the front. Using hooked eccentric extractor (F), supplied with machine, reach behind eccentrics as shown and withdraw eccentrics. It may be necessary to move handwheel back and forth slightly during extraction.

If eccentrics are unusually tight fitting, in addition to removing nut (C, Fig. 15) and washer (D) from shaft (E), it may be helpful to remove nut (G) and feed driving connection (H). Then continue as originally suggested.

SETTING THE PRESSER FOOT

Assemble the presser foot to presser arm. With needle in high position, swing presser arm into sewing position and set the presser foot to align needle holes (front and back) and flat on throat plate. The front edge of needle hole in presser foot must be aligned with front edge of needle hole in throat plate. It is also important that the bottom of the presser foot be flat on the throat plate. If necessary, presser foot can be realigned with throat plate slots by shifting the foot lifter lever shaft (H, Fig. 16). To move the shaft, loosen collar screws (B, Fig. 16) and clamp screw (G) and then shift the foot lifter lever shaft to the left or right as required. Retighten collar screws and clamp screw.

The foot lifter lever arm (A, Fig. 16) and the collar (B) secure the shaft. Be sure the presser arm does not bind and rise when presser foot release bushing is unlocked.

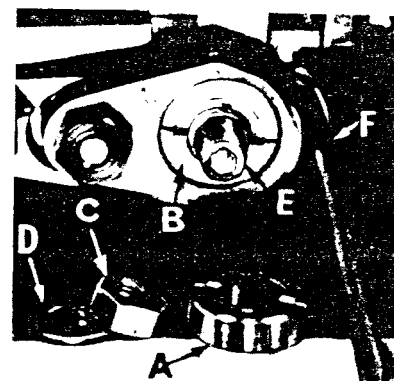

Fig. 14

Adjust lifter lever stop screw (C) so that presser foot can be raised no higher than the upper looper or spreader will permit; then lock the nut (D). There should be from $1/16$ to $1/8$ inch (1.59 to 3.17 mm) free motion of foot lifter lever before the presser foot begins to rise. This adjustment should be made with screw (E) and locked with nut (F). Re-assemble the chip guard, fabric guard and clothplate. To assemble chip guard, turn handwheel until upper knife assembly reaches its highest position.

STARTING TO OPERATE

Be sure machine is threaded according to the threading diagram for your machine (Fig. 1, 1A or 1B).

With thread tensions light, set the lower looper thread eyelet (R, Fig. 1 and 1B) and the upper looper thread eyelet (N, Fig. 1A and 1B) approximately horizontal and in the middle of their front to back locations. Operate machine slowly, with presser foot in place; make sure chain forms and moves off stitch tongue freely.

NEEDLE THREAD CONTROL (503 STITCH)

While sewing on material, check needle thread control as follows: Usually all needle thread is drawn on needle down stroke. At top of needle stroke, thread should be just tight enough to feed chain off stitch tongue. Stitch tends to pull down slightly if excessive thread is pulled on the up stroke. With needle at bottom of stroke, position needle thread eyelet (AD, Fig. 1 or 1A) so that needle thread cam pull-off (AE) just contacts needle thread. To increase thread drawn on downstroke, position needle thread eyelet (AD, Fig. 1 or 1A) farther to the rear.

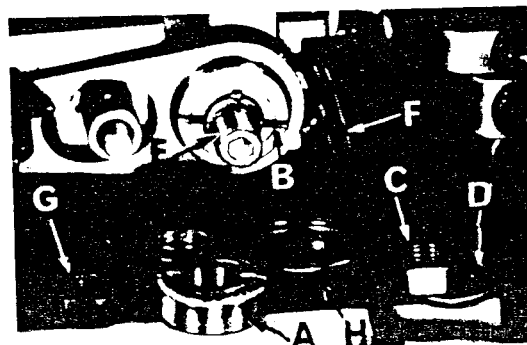

Fig. 15

LOWER LOOPER THREAD CONTROL (503 STITCH, 695B012, 040 and 051)

With material under presser foot, set lower looper thread eyelet (R, Fig. 1) back and down far enough so thread is a little slack when spreader reaches its extreme left position. Lower looper thread eyelet (R) should be about horizontal.

NOTE: If looper thread breakage occurs at high speed, move lower looper thread eyelet (R) upward slightly at an angle away from the needle thread arm binder screw.

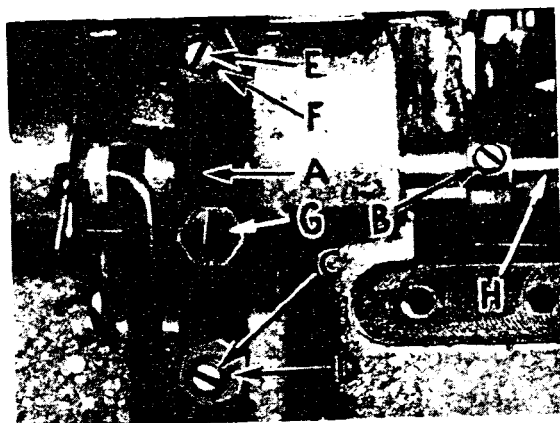

Fig. 16

Frame looper thread guide (T) should be set with its eyelet approximately $\frac{1}{8}$ inch (3.17 mm) to the right of heel eyelet of looper (V) at the time lower looper is at extreme left end of its travel.

THREAD TENSIONS (503 STITCH)

Before proceeding, balance both tensions to give a normal appearing stitch. Moderate change in these tensions will not markedly affect the purl.

UPPER LOOPER THREAD CONTROL (503 STITCH - 695B030)

With material under presser foot, set upper looper thread eyelet (N, Fig. 1A) back and down far enough so thread is a little slack when lower spreader reaches its extreme left position. Looper thread eyelet (N) should be about horizontal.

NEEDLE THREAD CONTROL (505 STITCH)

While sewing on material, check needle thread control as follows: About 60% of needle thread required for the stitch should be drawn on needle downstroke. To increase thread drawn on the downstroke, position needle thread eyelet (AD, Fig. 1B) farther to the rear.

LOWER LOOPER THREAD CONTROL (505 STITCH)

Set lower looper thread eyelet (R, Fig. 1B) about horizontal and all the way forward in its slot.

Frame looper thread guide (T) should be set with its eyelet approximately 1/8 inch (3.17 mm) to the right of lower looper (V) heel eyelet, when lower looper is at the left end of its stroke.

UPPER LOOPER THREAD CONTROL (505 STITCH)

With material under presser foot, set upper looper thread eyelet (N, Fig. 1B) to rest on top of lower looper thread eyelet (R), and back far enough so upper looper thread is a little slack when upper looper reaches the left end of its stroke.

POSITIONING THE SQUARE EDGE (505 STITCH)

Position of lower looper thread at the edge is located by balancing needle and upper looper thread tensions.

To reduce amount of lower thread in the stitch, or close the edge more, increase lower looper thread tension.

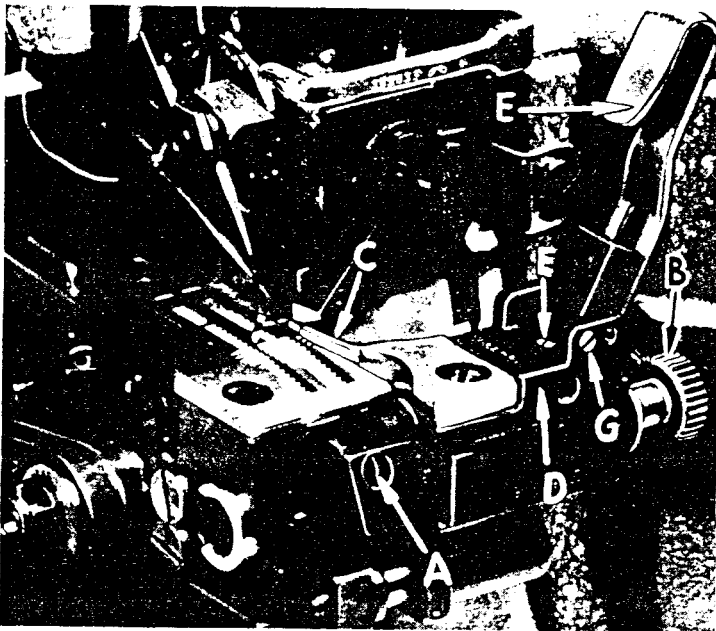

Fig. 17

SETTING THE HEMMING GUIDE SUPPORT BRACKET

(695B012)

Assemble the hemming guide support bracket onto the lower knife support bracket by means of screw (A, Fig. 17). With the knurled adjusting screw (B), set the edge guide (C) so that the left side of its tip is even with and parallel to the right side of the right feed slot in the throat plate.

When the edge guide tip is in this position, the front or leading edge should be slightly to the right of parallel. This adjustment can be made by positioning the stop screw located towards the front of the hinge block and edge guide support bracket (D, Fig. 17).

Under normal conditions, the edge guide is spring pressed to compensate for the differences in material thickness. For example, as in going over seams. The amount of movement and pressure applied to the edge guide tip is controlled by adjusting the screw which presses against the spring located in the hinge block and edge guide support bracket (D, Fig. 17). Removing this spring and turning the screw all the way out against the edge guide prevents movement of the edge guide.

SETTING THE HEMMING GUIDE SUPPORT BRACKET (695B012, Continued)

Mount the retractable edge guide lever bracket (A, Fig. 18) onto the casting with

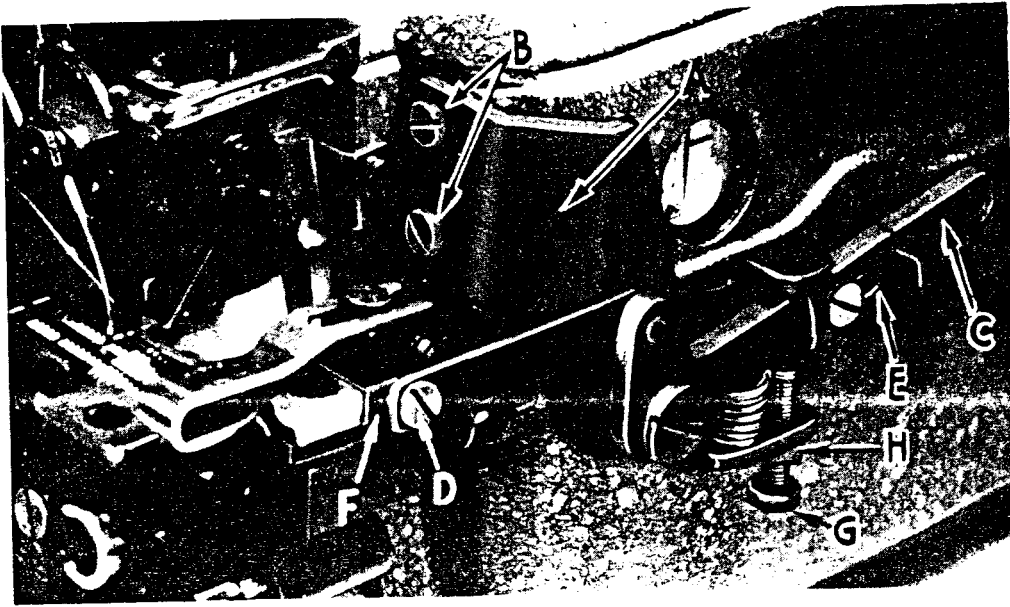

Fig. 18

screws (B). Attach the knee press chain to the lever arm (C) and the lever arm to the hemming guide support bracket with screw (D). The adjustable stop lever slide (E) should be positioned to the extreme left when in normal operation. The slide is moved to the right as shown in the illustration, only when making repairs on garments.

FINAL ADJUSTMENT OF HEMMING GUIDE (695B012)

Adjust the edge guide (C, Fig. 17) by turning the knurled adjusting screw (B) so that the stitches are located in the folded edge, yet do not show on the face of the fabric. Adjust the overhanging guide (E) so that the space between its guiding edge and the edge guide corresponds with the thickness of the material to be hemmed. Adjust the stop screw (F) for the overhanging guide so that the tip of the overhanging guide is located at the center of the edge guide vertically. If desired, the overhanging guide can be locked into position by tightening the locking screw (G) located in the hinge block and edge guide support bracket (D).

Adjust the amount of retraction of the edge guide bracket (F, Fig. 18) by positioning the adjusting stop screw (G). The position of the screw will depend on the thickness of the seam to be crossed. The locking nut (H) should then be tightened into place.

SETTING THE HEMMING GUIDE SUPPORT BRACKET (695B030, 040 and 051)

Make sure that lock screw (A, Fig. 19) is loose, then proceed as follows:

Assemble the hemming guide support bracket onto the lower knife support bracket by means of screw (B, Fig. 19). With the knurled adjusting screw (C), set the edge guide (D) so that the left side of its tip is even with and parallel to the right side of the right feed slot in the throat plate.

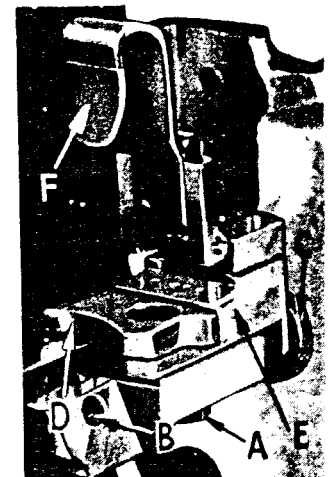

Fig. 19

SETTING THE HEMMING GUIDE SUPPORT BRACKET (695B030, 040 and 051)

When the edge guide tip is in this position, the front or leading edge should be slightly to the right of parallel. This adjustment can be made by positioning the stop screw (A, Fig. 20) located towards the front of the hinge block and edge guide support bracket (E, Fig. 19).

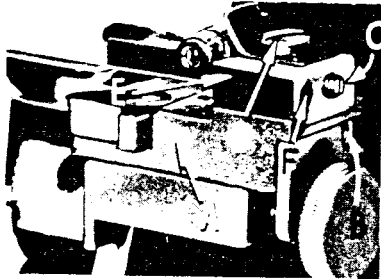

Fig. 20

Under normal conditions, the edge guide is spring loaded to compensate for the differences in the material thickness. For example, as in going over seams. The amount of movement and the pressure applied to the edge guide tip can be set by removing lock screw (B, Fig. 20) and adjusting the screw which presses against the spring and pin, located in the hinge block and edge guide support bracket (E, Fig. 19). Replace lock screw and tighten securely.

If movement of the edge guide is not required, then remove lock screw (B, Fig. 20), set screw and spring; then replace set screw and lock screw. Be sure set screw is tightened against pin and lock screw is tightened against set screw.

FINAL ADJUSTMENT OF HEMMING GUIDE (695B030, 040 and 051)

Adjust the edge guide (D, Fig. 19) by turning the knurled adjusting screw (C) so that the stitches are located in the folded edge, yet do not show on the face of the fabric. At this point re-tighten screw (A, Fig. 19) securely.

Adjust the overhanging guide (F, Fig. 19) so that the space between its guiding edge and the edge guide (D) corresponds with the thickness of the material to be hemmed. Loosen set screw (C, Fig. 20) and holding screw (D), now move the hinge block (E) to obtain the proper distance between the edge guide and the overhanging guide. Re-tighten screws (C) and (D). Remove lock screw (F) and adjust stop screw that is in front of lock screw, so that the tip of the overhanging guide is located at the center of the edge guide vertically. Replace lock screw (F) and tighten against stop screw.

ORDERING REPAIR PARTS

ILLUSTRATIONS

This catalog is arranged to simplify ordering replacement parts. Exploded views of various sections of the mechanism are shown on the left hand pages so that parts may be seen in their actual positions in the machine. On the right hand pages opposite the illustrations, the parts are listed with descriptions and the quantity of parts required in the particular view being shown.

Numbers in the first column are reference numbers only indicating position of a part in the illustration. Do not use the reference numbers in ordering.

ORDERING REPAIR PARTS (Continued)

In the second column in the examples below are the part numbers as listed in this catalog. In the third column is the coded number to be ordered. The prefix "910" must be used. Additionally, letter suffixes generally are transposed as a prefix to the part number.

Components of sub-assemblies which can be furnished as replacements are indented under the description of the main sub-assembly.

The examples below show how to order using parts on Page 21 of this catalog to illustrate the instructions above:

<u>Ref.</u> <u>No.</u>	<u>Part</u> <u>No.</u>	<u>Order</u> <u>As</u>	<u>Description</u>	<u>Qty.</u>
11	39520 G	910-G 39520	Presser Foot for 695B012 -----	1
12	39520 H	910-G 39520	Presser Foot for 695B040 -----	1
13	39520 BH	910-BH 39520	Presser Foot for 695B030 -----	1
14	39520 AX	910-AX 39520	Presser Foot for 695B051 -----	1
15	39530 E	910-E 39530	Chain shield for 39520 G, H, and AX	1
15A	39530 U	910-U 39530	Chain shield for 39520 BH	1

Where the parts for all machine varieties covered in this catalog are not the same, the difference will be shown in the illustrations or mentioned in the descriptions. When a part is used in all machines in this catalog, the variety number is not mentioned.

IDENTIFYING PARTS

Where the construction permits, each part is stamped with its part number. On some of the smaller parts, and on those where construction does not permit, an identification letter is stamped in to distinguish the part from similar ones.

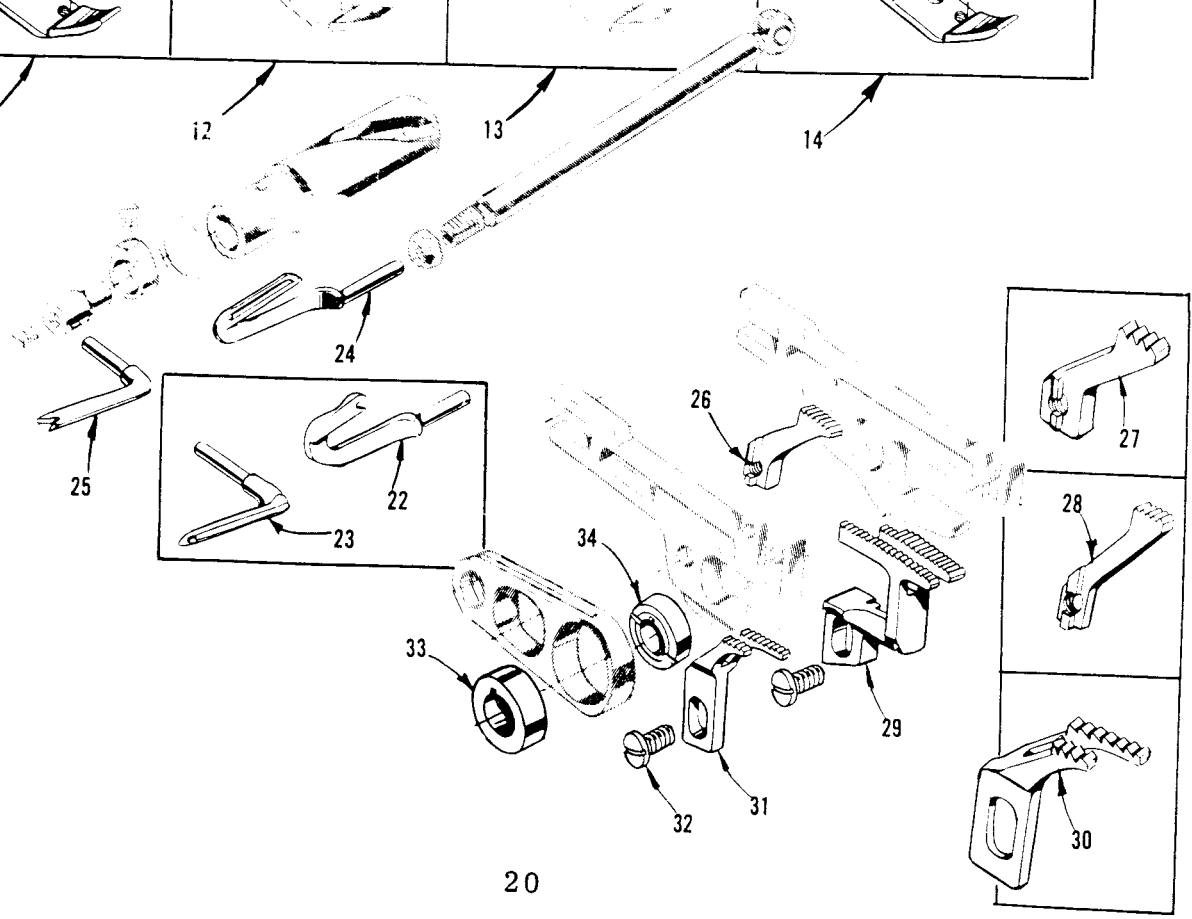
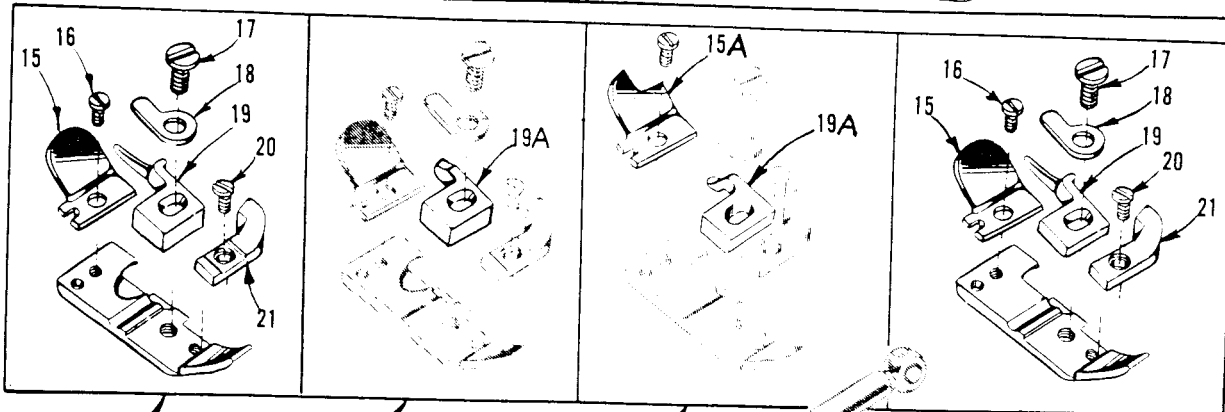
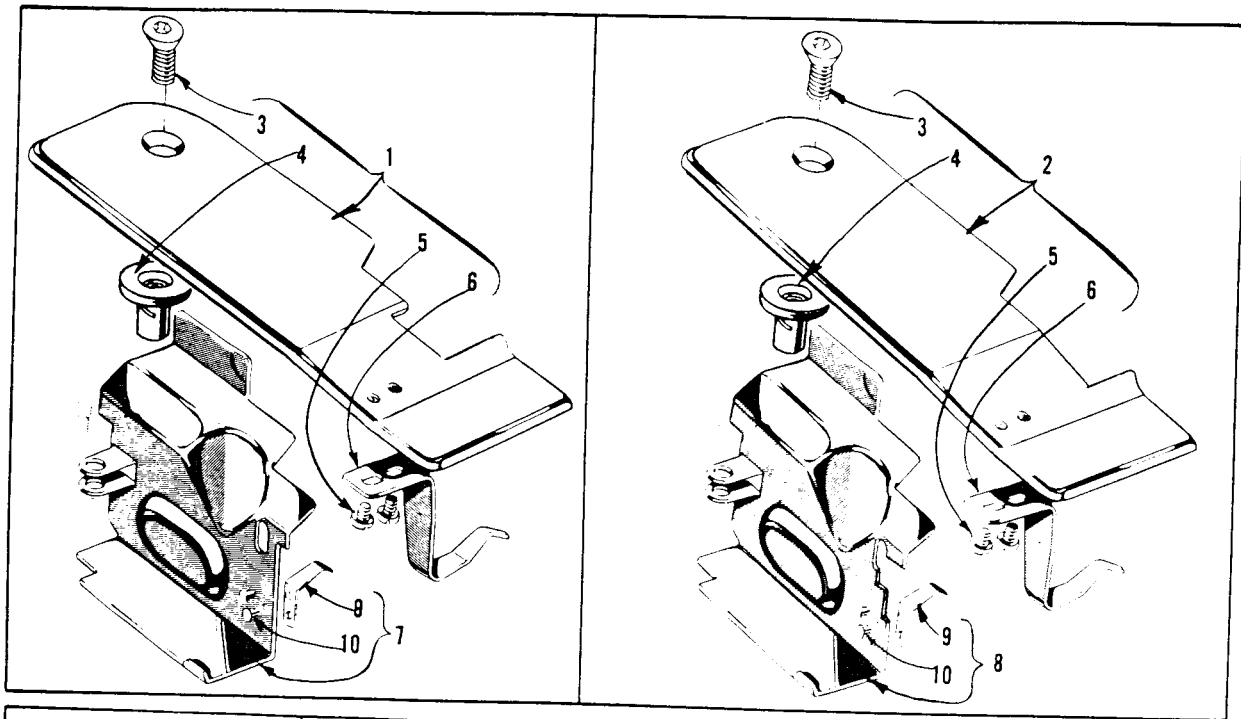

IMPORTANT: BEFORE ORDERING ANY PARTS BELOW, REFER TO THE DETAILED
INSTRUCTIONS ON PAGES 18 AND 19

The parts illustrated on pages 20, 22 and 24 and described on this page, page 23 and page 25 represent the parts that are used on 695B012, 030, 040 and 051, but not used on 695B010.

Unless otherwise specified in the description, the parts are used on all the machine styles covered in this catalog. Those parts shown in phantom views and bearing no reference numbers are common to 695B012, 030, 040 and 051.

Use Form IPD 659-78(695B010) for all parts not illustrated or described in this catalog.

Reference numbers that are inside a bracket on the picture plate and have indented descriptions, indicate they are component parts of a complete part or assembly.

Ref. No.	Part No.		Amt. Req.
1	39501 AP	Cloth Plate, for all varieties except 695B051 -----	1
2	39501 AS	Cloth Plate, for 695B051 -----	1
3	22657 D-12	Screw, for cloth plate -----	1
4	39501 K	Cloth Plate Stud -----	1
5	22513	Screw, for latch spring -----	2
6	39532 D	Latch Spring -----	1
7	39582 G	Side Cover, for all except 695B051 -----	1
8	39582 AR	Side Cover, for 695B051 -----	1
9	39582 H	Spring -----	1
10	39582 J	Rivet -----	2
11	39520 G	Presser Foot, for 695B012 -----	1
12	39520 H	Presser Foot, for 695B040 -----	1
13	39520 BH	Presser Foot, for 695B030 -----	1
14	39520 AX	Presser Foot, for 695B051 -----	1
15	39530 E	Presser Foot Chain Shield, for presser feet Nos. 39520 G, 39520 H and 39520 AX -----	1
15A	39530 U	Presser Foot Chain Shield, for presser foot No. 39520 BH -----	1
16	22738	Screw, for chain shield -----	1
17	22768 B	Screw, for tongue and spring -----	1
18	39520	Presser Foot Hinge Spring -----	1
19	39597 F	Stitch Tongue, marked "DV", for presser feet Nos. 39520 G and 39520 AX -----	1
19A	39597 A	Stitch Tongue, marked "DS", for presser feet Nos. 39520 H and 39520 BH -----	1
20	22738	Screw, for chip guard -----	1
21	39530 B	Chip Guard -----	1
22	39560 B	Lower Spreader, for 695B030 -----	1
23	39508 A	Upper Looper, marked "CC", for 695B030 and 695B051 (505 stitch) -----	1
24	39508 B	Lower Looper, for all except 695B030 -----	1
25	39560 A	Upper Spreader, marked "E", for 695B012, 040 and 051 (503 stitch) -----	1
26	39505 G	Chaining Feed Dog, marked "S", 20 t.p.i., for 695B012 and 051 (503 stitch) -----	1
27	39505 AL	Chaining Feed Dog, marked "CN", 16 t.p.i., for 695B030 ---	1
28	39595 H	Chaining Feed Dog, marked "U", 20 t.p.i., for 695B040 and 051 (505 stitch) -----	1
29	39526 H	Differential Feed Dog, 20 t.p.i., for all varieties except 695B051 -----	1
	39526 AX	Differential Feed Dog, 16 t.p.i., for 695B051 (505 stitch)	1
	39526 AY	Differential Feed Dog, 20 t.p.i., for 695B051 (503 stitch)	1
30	39505 BH	Main Feed Dog, marked "CM", 16 t.p.i., for 695B030 -----	1
31	39505 F	Main Feed Dog, marked "F", 20 t.p.i., for all except 695B030 -----	1
32	22528	Screw, for main feed dog, for 695B030 -----	1
-	93 A	Screw, for main feed dog, for all except 695B030 -----	1
33	39540 B-14	Main Feed Driving Eccentric, for all except 695B030 -----	1
-	39540 B-9	Main Feed Driving Eccentric, for 695B030 -----	1
34	39540 B-8	Differential Feed Driving Eccentric, for all except 695B030 -----	1
-	39540 B-7	Differential Feed Driving Eccentric, for 695B030 -----	1

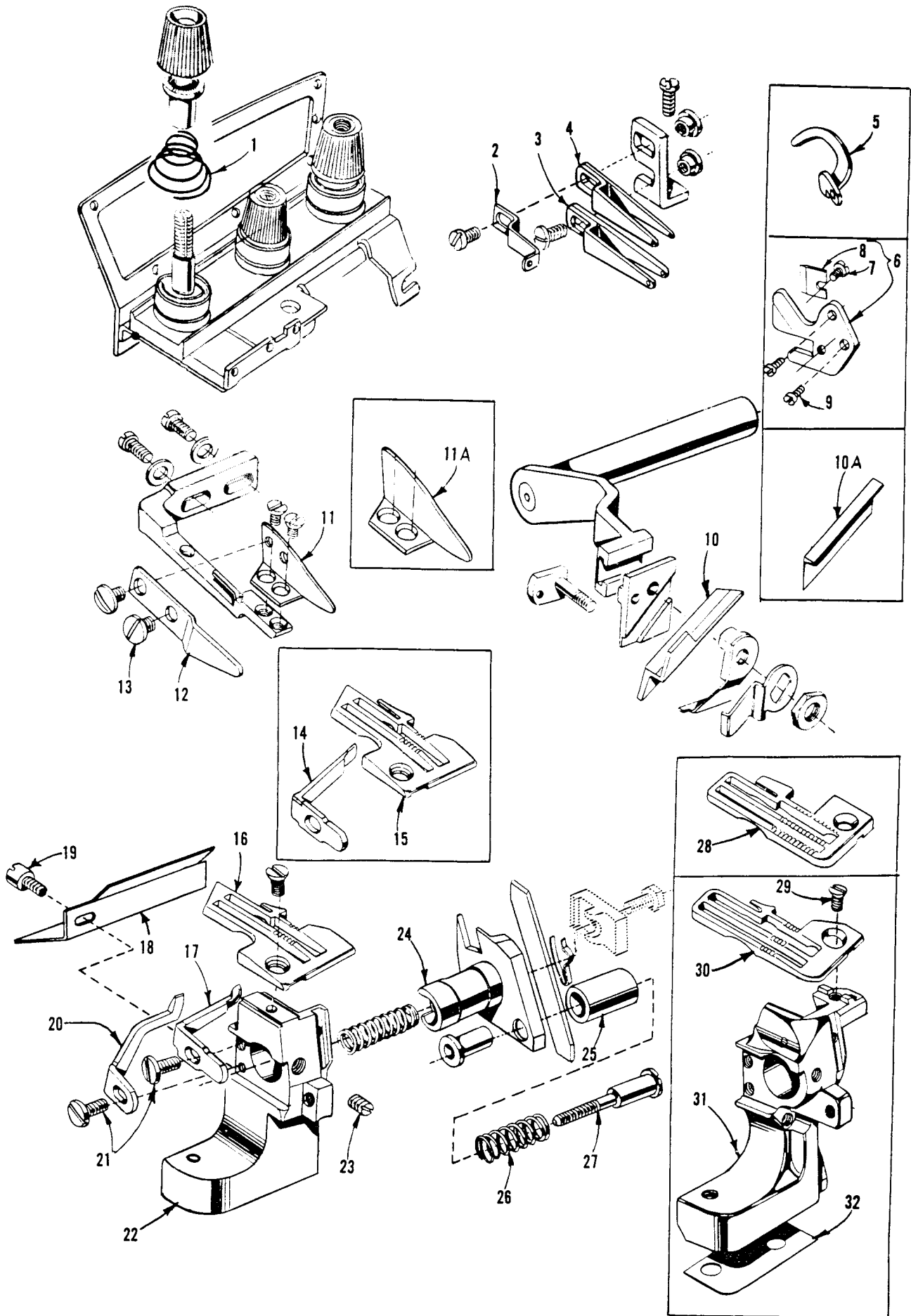

IMPORTANT: BEFORE ORDERING ANY PARTS BELOW, REFER TO THE DETAILED INSTRUCTIONS ON PAGES 18 AND 19

THROAT PLATES, NEEDLE GUARDS, UPPER KNIFE, LOWER KNIFE PARTS AND MISCELLANEOUS PARTS

Ref. No.	Part No.	Description	Amt. Req.
1	39592 AR-4	Needle Thread Tension Spring -----	1
-	39592 AR-4	Looper Thread Tension Spring, for 695B012 and 030 -----	1
-	39592 AR-5	Looper Thread Tension Spring, for 695B040 -----	1
-	39592 AR-4	Looper Thread Tension Spring, for 695B051 (505 stitch)-----	2
2	39568 E	Auxiliary Upper Looper Thread Eyelet, for 695B030 and 051 -----	1
3	39568 B	Upper Looper Thread Eyelet, for 695B030 -----	1
-	39568 B	Lower Looper Thread Eyelet, for all except 695B030 -----	1
4	39568 L	Upper Looper Thread Eyelet, for 695B051 -----	1
5	39563 J	Needle Thread Cam Pull-off-----	1
6	39556 M	Chain Cutting Knife-----	1
7	22798	Screw, for chain cutter blade-----	1
8	39556 L	Chain Cutter Blade -----	1
9	605	Screw, for chain cutting knife-----	2
10	39570 L	Upper Knife, for 695B030 -----	1
10A	39570	Upper Knife, for all except 695B030 -----	1
11	39578 V	Fabric Guard, for 695B030 -----	1
11A	39578 R	Fabric Guard, for all except 695B030 -----	1
12	39556 N	Presser Foot Tilt Lever, for 695B030 -----	1
13	22561	Screw, for presser foot tilt lever, for 695B030 -----	2
14	39525 K	Needle Guard, rear, for 695B030 -----	1
15	39524 D	Throat Plate, marked "AM", 695B030 and 040 -----	1
16	39524 G	Throat Plate, marked "AF", for 695B012 -----	1
17	39525 E	Needle Guard, rear, for all except 695B030 -----	1
18	39582 BS	Oil Shield, for all except 695B051 -----	1
19	22585 G	Screw, for oil shield and locking side cover-----	1
20	39525 D	Needle Guard, front -----	1
21	90	Screw, for needle guards -----	2
22	39580 BA	Throat Plate and Lower Knife Support Bracket, for all except 695B051 -----	1
23	88 B	Screw, for lower knife holder -----	1
24	39550 T	Lower Knife Holder, for all except 695B051 -----	1
-	39550 V	Lower Knife Holder, for 695B051 -----	1
25	39550 K	Spring Cover-----	1
26	39550 J	Knife Pressure Equalizing Spring -----	1
27	22559 H	Adjusting Screw-----	1
28	39524 AX	Throat Plate, marked "CD", for 695B051 (505 stitch)-----	1
29	AS22 D	Screw, for throat plate, for 695B051 -----	1
-	22524	Screw, for throat plate, for all except 695B051 -----	1
30	39524 AY	Throat Plate, marked "CE", for 695B051 (503 stitch)-----	1
31	39580 AG	Throat Plate and Lower Knife Support Bracket, for 695B051 -----	1
32	39580 E	Throat Plate and Lower Knife Support Bracket Shim, for 695B051 -----	1

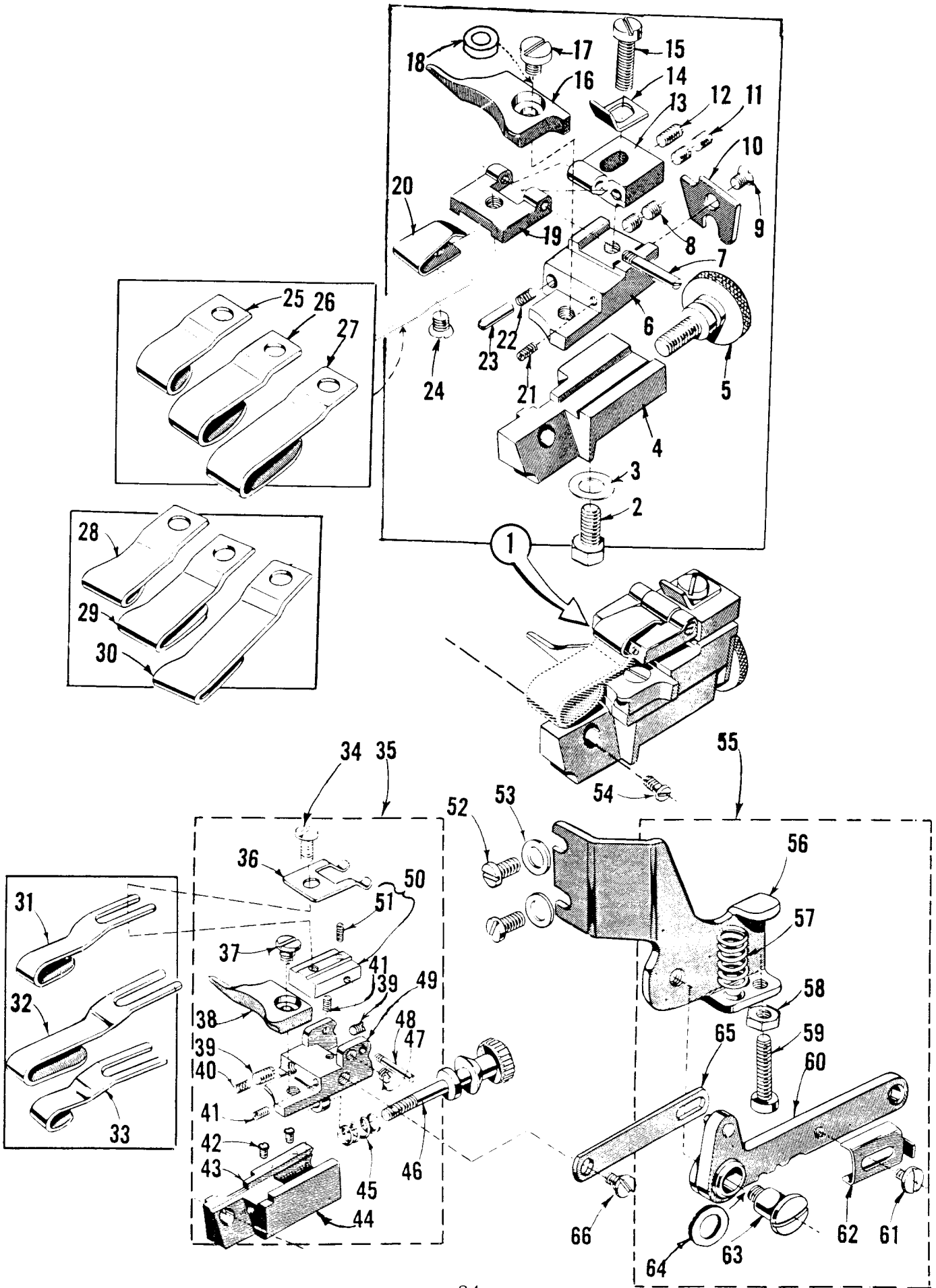

IMPORTANT: BEFORE ORDERING ANY PARTS BELOW, REFER TO THE DETAILED INSTRUCTIONS ON PAGES 18 AND 19

HEMMER GUIDES ASSEMBLIES, OVERHANGING GUIDES AND OPERATING LEVER ASSEMBLY

Ref. No.	Part No.	Description	Amt. Req.
1	29481 L	Hemmer Guide Assembly, for 695B030,040 and 051	1
2	303	Screw, for edge guide support	1
3	61303 D	Cup Washer, for screw No. 303	1
4	39589 AC	Hemming Attachment Base	1
5	22873 C	Adjusting Screw, for edge guide support	1
6	39589 AD	Edge Guide Support	1
7	22799 B	Hinge Screw, for overhanging guide hinge block	1
8	22743	Screw, for edge guide tension spring	2
9	222 D	Screw, for hemmer guide end plate	1
10	39589 AF	Hemmer Guide End Plate	1
11	HA73 B	Stop Screw, for overhanging guide hinge block	2
12	73 C	Set Screw, for No. 22729 A	1
13	39589 AB	Hinge Block	1
14	39589 AJ	Hemmer Guide Stop	1
15	22729 A	Screw, for hemmer guide stop	1
16	39503 L	Edge Guide	1
17	22513 C	Screw, for edge guide	1
18	39589 AG	Sleeve, for edge guide	1
19	39589 AA	Overhanging Guide Hinge Block	1
20	39589 AH	Holding Spring	1
21	79077	Stop Screw, for edge guide	1
22	39568 J	Spring, for edge guide tension	1
23	39589 AL	Pin, for edge guide tension spring	1
24	222 D	Screw, for overhanging guide	1
25	39589 AK-1/2	Overhanging Guide, for 1/2 inch hem, for (695B040 and 051	1
26	39589 AK-3/4	Overhanging Guide, for 3/4 inch hem, for (
27	39589 AK-1	Overhanging Guide, for 1 inch hem, for (
28	39589 AE-1/2	Overhanging Guide, for 1/2 inch hem, for (
29	39589 AE-3/4	Overhanging Guide, for 3/4 inch hem, for (695B030	1
30	39589 AE-1	Overhanging Guide, for 1 inch hem, for (
31	39589 H-3/4	Overhanging Guide, for 3/4 inch hem, for (
32	39589 H-1	Overhanging Guide, for 1 inch hem, for (
33	39589 H-1/2	Overhanging Guide, for 1/2 inch hem, for (695B012	1
34	98 A	Screw, for overhanging guide, for (
35	29481 F	Hemming Guide Assembly, for (
36	39589 U	Hemming Guide Hinge Spring	1
37	22760 A	Screw, for edge guide	1
38	39503 G	Edge Guide	2
39	22565 C	Screw	1
40	39568 J	Edge Guide Tension Spring	2
41	79077	Screw	2
42	22738	Screw	1
43	28-176 Blk.	Adjustable Insert Blank	1
44	39589 E	Overhanging Guide Base	1
45	39589 J	Spring	1
46	22873 B	Adjusting Screw	1
47	22743	Screw	1
48	22799 E	Hinge Screw	1
49	39589 G	Hinge Block and Edge Guide Support	1
50	39589 F	Overhanging Guide Hinge	1
51	77 Q	Screw	2
52	22569 C	Screw, for operating lever assembly, for 695B012	2
53	8372 A	Washer, for screw No. 22569 C	1
54	22593	Screw, for hemming guide assembly	1
55	29481 E	Operating Lever Assembly, for 695B012	1
56	39589 M	Operating Lever Bracket	1
57	36279 B	Spring	1
58	9937	Nut	1
59	22874	Screw	1
60	39589 K	Operating Lever	1
61	22726 A	Screw	1
62	39589 N	Operating Lever Slide Member	1
63	22557 D	Screw	1
64	61256 G	Washer	1
65	39589 L	Operating Lever Link	1
66	22760 A	Screw, for operating lever link, for 695B012	1

