

Singer 18-23

Singer 18-25

Form 19110
(937)
Printed in U. S. A.

**LIST
OF
PARTS**



**MACHINES
Nos. 18-23 and 18-25**

THE SINGER MANUFACTURING COMPANY

INSTRUCTIONS FOR OILING

To ensure easy running and prevent unnecessary wear of the parts which are in movable contact, the machine requires oiling and when in continuous use, it should be oiled at least twice each day with Singer Manufacturing Sewing Machine Oil (Cloth and Leather).

Copyright, U. S. A., 1935 and 1937
by The Singer Manufacturing Co.
All Rights Reserved for all Countries

INDEX

	Page
Attachments and Accessories.....	24
Ball Bearing Roller Pressers with Ratchet Brake.....	13
Ball Bearing Roller Pressers.....	12
Bobbin Winder.....	24
Foot Lifter Parts.....	25
Knee Lifter Parts.....	25
Machine Base.....	24
Machine No. 18-23.....	5
Machine No. 18-25.....	14
Numerical List of Parts.....	29
Plain Roller Pressers.....	11
Thread Lubricators.....	26

INSTRUCTIONS FOR ORDERING

In ordering from this list, use ONLY the part NUMBER in the FIRST column.

The number stamped on a Sewing Machine Part is in every case the number of the single part only.

Every combination of parts sent out as such has its specific number, which, although not stamped on the parts, must be used when ordering the combination.

Each number always indicates the SAME PART in whatever list it appears, or for whatever machine.

The letters after some of the numbers indicate the style of finish only, as follows:

- A-Hardened, Polished, Nickel Plated and Buffed
- B-Polished, Nickel Plated and Buffed
- C-Hardened Only
- D-Polished Only
- E-Soft, Not Polished
- F-Hardened and Polished
- F.J-Hardened, Polished and Nickel Plated
- G-Bright Rumbled and Nickel Plated
- H-Blued
- J-Nickel Plated Only
- K-Hardened and Nickel Plated
- L-Brass Plated
- M-Oxidized
- N-Japanned, Dull
- P-Japanned, Bright
- R-Merlized
- S-Cadmium Plating
- T-Copper Plated
- T.A-Hardened, Polished, Copper and Nickel Plated and Buffed
- T.B-Copper and Nickel Plated and Polished
- T.J-Copper and Nickel Plated Only
- T.K-Hardened, Copper and Nickel Plated
- T.L-Copper and Brass Plated
- T.M-Copper Plated and Oxidized
- U-Zinc Plated
- V-Silver Plated
- W-Polished and Nickel Plated
- X-Black Oxide, for Iron and Steel
- X.C-Hardened and Black Oxide, for Iron or Steel
- Y-Black Nickel Plated Only
- Z-Chromium Plated
- Z.A-Hardened, Polished, Nickel Plated, Buffed and Chromium Plated
- Z.B-Polished, Nickel Plated, Buffed and Chromium Plated
- Z.C-Hardened and Chromium Plated
- Z.J-Nickel and Chromium Plated

These letters MUST BE USED when they appear in the list; and AFTER the number as in the list.

In this series:

1 to 1500, 50001 to 51500 and 140001 to 142000 are Screw Numbers

1501 to 1800 and 51501 to 51800 are Nut Numbers

1801 to 2000 and 51801 to 52000 are Roller Numbers

2001 to 50000 and 52001 to 140000 and 142001 to

190000 are Sewing Machine Parts, 190001 and upward

are numbers of Electrical Parts.

The figures in the second column refer only to the plates, illustrating the parts, and are NOT TO BE USED in ordering.

Parts marked with an asterisk (*) are furnished only when repairs are made at factory.

When ordering parts which differ as to Gauge (the distance between seams) the Gauge, as well as the Number must be given on order.

LIST OF PARTS COMPLETE FOR

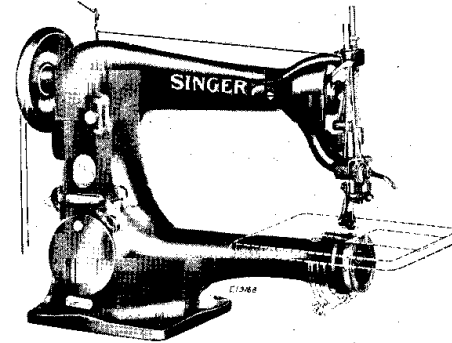

MACHINE No. 18-23

FOR SHOE WORK AND OTHER WORK IN LEATHER.
WHEEL FEED AT LEFT OF NEEDLE. ROLLER
PRESSER. SPEED 1800 R. P. M.

No.	Plate	Name
*16280	----	Arm and Cylinder with 15404 and two 15405
16264	3699	" Shaft.....
*16281	----	" " 16264 with 3074, 16268 and 16269
3005	3698	" " Bushing.....
448C	3698	" " " Set Screw.....
16266	3698	" " Counterbalance with 443C.....
443C	3698	" " " Set Screw.....
144D	3698	" " Screw.....
4288	22701	" Side Cover (back).....
51224W	3698	" " " Thumb Screw.....
16102	22701	" " " (front).....
164J	3698	" " " Screw.....
52239	3698	" Spool Pin and Thread Eyelet.....
8879	3698	" " " Washer (cloth).....

PARTS FOR MACHINE No. 18-23

No.	Plate	Name
16267	3699	Balance Wheel (disc) for Power Table, 2-3/4 in. pulley, with two 448C.....
16278	3699	Balance Wheel (disc) for Stand, 3 in. pulley, for Clamp Stop Motion.....
448C	3698	Balance Wheel Set Screw.....
256J	3698	Clamp Stop Motion Clamp Screw.....
248A	3698	" " " Stop Screw.....
2020	3698	" " " Washer.....
*3023	-----	" " " Flanged Bushing.....
4933	3698	" " " " 3023 with two 462C.....
2022	22702	Clamp Stop Motion Flanged Bushing Pin....
462C	22702	" " " Set Screw
3022	-----	Clamp Stop Motion complete, Nos. 248A, 256J 2020 and 4933.....
6786	3699	Cloth Plate.....
6083	3699	" " Bracket with two 345C.....
345C	22702	" " " Set Screw.....
389F	22702	" " " Screw.....
6496	3699	" " " Slide.....
3286	22702	" " " Spring.....
725J	22702	" " " " Screw.....
6495	3699	Cloth Plate complete, Nos. 3286, 6496, 6786 and two 725J.....
6494	-----	Cloth Plate with Bracket complete, Nos. 6083, 6495 and two 389F.....
4292	3683	Crank Connecting Rod with two 145E.....
145E	3698	" " " Cap Screw.....
375C	22702	" " " Hinge Screw.....
1518J	22702	" " " " Nut.....
18045	22702	Cylinder Oil Tube for oiling Oscillating Shaft.....
18036	22701	Cylinder Side Cover.....
51224W	3698	" " " Thumb Screw.....
52165	22702	Feed Connecting Link.....
375C	22702	" " " Hinge Screw.....
1518J	22702	" " " " Nut.....
3074	22702	" " Eccentric with 446C.....
446C	22702	" " " Set Screw.....
3037	3683	" " Forked Connection.....
375C	22702	" " " Hinge Screw.....
1518J	22702	" " " " Nut.....
16177	-----	Feed Forked Connection complete, Nos. 3037 16241, 52165 and two each 375C and 1518J
6459	22702	Feed Regulator.....
18241	-----	" " " 6459 with 818D.....
58E	22704	" " " Hinge Screw.....
818D	22702	" " " Thumb Screw.....
6488	22703	" " Rock Shaft.....
6018	22704	" " " Crank with 207F.....

PARTS FOR MACHINE No. 18-23

No.	Plate	Name
156F	22704	Feed Rock Shaft Crank Position Screw.....
207F	22704	" " " " Set Screw.....
6497	22701	" " Wheel.....
6498	22701	" " " Driver.....
16168	22702	" " " Spring.....
207F	22704	" " " " Screw.....
16246	22704	" " " Friction Spring.....
207F	22704	" " " " Screw.....
16268	3683	Needle Bar (hollow).....
*3045	22705	" " " Connecting Link.....
16220	-----	" " " " 3045 with 377C 1518J and 6487.....
377C	22705	Needle Bar Connecting Link Hinge Screw...
1518J	22702	" " " " Nut
6487	22705	" " " Stud with 155C....
155C	22705	" " " " Set Screw....
290E	22705	" " " Screw Bushing.....
4302	22705	" " " Thread Guide.....
233J	22705	" " " " Screw.....
4303	22705	" " " Clamp with 808F.....
808F	22705	" " " " Screw.....
*6461	22701	Oscillating Rock Shaft with 4784.....
16176	-----	Oscillating Rock Shaft complete, Nos. 6461 and 16212.....
6489	3683	Oscillating Rock Shaft Hinge Pin.....
*16212	-----	" " " " 6489 with 1513J.....
1513J	22705	Oscillating Rock Shaft Hinge Pin Nut.....
4784	22705	" " " Oil Pad.....
16055	22703	" " Shaft.....
*16184	-----	" " " 16055 with 2049, 6056 and 6499.....
*6056	-----	Oscillating Shaft Crank with 460C and 1813.....
6024	22705	Oscillating Shaft Crank with 1813 and two 462C.....
2049	22705	Oscillating Shaft Crank Pin.....
1813	22705	" " " Roller and Stud..
462C	22702	" " " " Set Screw for 6024.....
460C	22705	Oscillating Shaft Crank Set Screw for 6056.....
3054	3683	Presser Bar.....
6464	3683	" " " Lifter.....
77J	22706	" " " " Screw.....
6465	22706	" " " " Washer.....
16194	3683	" " " Lifting Bracket with 175J and two 457K.....
16195	3683	Presser Bar Lifting Bracket 16194 with 16196 and two 335J.....

PARTS FOR MACHINE No. 18-23

No.	Plate	Name
175J	22706	Presser Bar Lifting Bracket Adjusting Screw.....
6469	3683	Presser Bar Lifting Bracket Guide.....
175J	22706	" " " " " Screw..
457K	22706	" " " " " Set Screw....
16196	3683	" " " " " Wearing Plate
335J	22706	" " " " " Screw.....
290E	22705	Presser Bar Screw Bushing.....
5459	3683	" " " Spring (light) .047" wire...
6466	-----	" " " " (medium) .055" wire...
6467	-----	" " " " (heavy) .063" wire...
2070	22706	" " " " Washer.....
2180	22704	" " " " Foot.....
190J	22704	" " " " Screw.....
262J	3683	Pressure Regulating Thumb Screw.....
1841	3681	Roller, 7/8 in. diam., 9/64 in. face, fine with 652D and 1528J.....
2203	3681	Roller Arm.....
440F	3689	" " " Adjusting Screw.....
1547J	3689	" " " " " Nut.....
2206	3681	" " " Bracket.....
2205	3689	" " " Lock Spring.....
176J	3689	" " " " " Screw.....
1549J	3689	" " " " " Nut.....
316F	3689	" " " " " Screw Center.....
15444	-----	" " " " " 316F with 1547J..
1547J	3689	" " " " " Nut.....
2197	3681	Roller Presser complete, 7/8 in. diam., 9/64 in. face, fine roller, Nos. 176J 440F, 1547J, 1549J, 1841, 2203, 2205, 2206 and two 15444.....
190J	22704	Roller Presser Screw.....
652D	3689	" " " " " Screw.....
1528J	3689	" " " " " Nut.....
2073	3689	Shuttle Bobbin.....
2211	3689	" " " Retaining Spring.....
2212	3689	" " " " " Rivet....
*8058	-----	" " " " " Body with 398E, 2082, 2084, 2211 and two 2212.....
*2075	-----	Shuttle Cover.....
*44001	-----	" " " " " 2075 with 112E, 466H, 2078, 2080, 2086 and 2090.....
2076	3689	Shuttle Cover Hinge Pin.....
2078	3689	" " " Delivery Eye Thread Guard.....
2080	3689	" " " " " Rivet..
2082	3689	" " " Main Spring.....
398E	3689	" " " " " Screw.....
2084	3689	" " " " " Steady Pin.....
466H	3689	" " " Tension Regulating Screw.....

PARTS FOR MACHINE No. 18-23

No.	Plate	Name
2086	3689	Shuttle Tension Spring.....
2090	3689	" " " " " Plate.....
112E	3689	" " " " " Screw.....
6028	3689	Shuttle (high point) complete, Nos. 2073, 2076, 6058 and 44001.....
6499	22710	Shuttle Driver.....
2049	22705	" " " Pin.....
18046	22713	" " " Race Ring.....
6472	22713	" " " " " Latch.....
725J	22702	" " " " " Screw.....
6500	22713	Shuttle Race Ring complete, Nos. 6472, 16046 and two 725J.....
50008J	22710	Shuttle Race Ring Screw.....
2102	3686	Tension Disc.....
1560C	3686	" " " Regulating Thumb Nut.....
16279	3686	" " " Releaser.....
16240	3686	" " " " " Collar with 7393 and two 1253C.....
7393	3686	Tension Releaser Collar Pin.....
1253C	3686	" " " " " Set Screw.....
50116K	3686	" " " " " Screw.....
600C	3686	" " " " " Screw Stud.....
16202	-----	" " " " " 600C with 1560C.....
175J	22706	" " " " " Set Screw.....
2103	3686	" " " " " Spring.....
16022	3686	" " " " " Thread Guard.....
219J	3686	" " " " " Screw.....
16204	-----	Tension complete, Nos. 2103, 16202 and two 2102.....
2106	3686	Thread Eyelet (front of arm).....
*16269	-----	" " " Take-up Cam.....
16270	3692	" " " " " 16269 with 446C.....
3012	22711	" " " " " Pin.....
446C	22702	" " " " " Set Screw.....
*6474	3686	" " " " " Lever with 1819.....
16180	-----	" " " " " 6474 with 76F.....
76F	3686	" " " " " Hinge Screw.....
1819	3686	" " " " " Roller and Stud.....
6768	3686	" " " " " Spring.....
6477	3686	" " " " " Regulator Plate.....
233J	22705	" " " " " " " Ad-justing Screw.....
16243	22713	Throat Ring.....
16244	22713	" " " " " 16243 with 665J and 16262....
16262	22711	" " " " " Needle Plate.....
665J	3689	" " " " " " " Screw.....
399J	22711	" " " " " " " Screw.....
16245	-----	Throat Ring complete, Nos. 6500, 16244 and two 50008J.....

PARTS FOR MACHINE No. 18-23

No.	Plate	Name
18077	3693	Dr-1p Pan.....
*15404	----	Trade Mark.....
15405	----	" " Rivet.....

Genuine Singer Needles should be used
 in Singer Machines.
 These Needles and their Containers
 are marked with the
 Company's Trade Mark "SIMANCO." 1

Needles in Containers marked
 "For Singer Machines"
 are not Singer made needles. 2

PLAIN ROLLER PRESSERS

FOR MACHINE No. 18-23

Diameter of Roller	7/8"		1 1/4"		1 1/4"		1 1/4"		1 1/4"	
	coarse	fine	coarse	fine	coarse	fine	coarse	fine	coarse	fine
Face of Roller	9/64"	9/64"	1/8"	9/64"	9/64"	9/64"	3/16"	3/16"	3/16"	3/16"
Knurrl of Roller	1868	1841	1823	1898	1839	1869	1897	1898	1898	1898
Roller	2205	2205	16098	16098	16098	16098	16098	16098	16098	16098
Roller Arm	440F	440F	440F	440F	440F	440F	440F	440F	440F	440F
Roller Arm Adjusting Screw	1547J	1547J	1547J	1547J	1547J	1547J	1547J	1547J	1547J	1547J
Roller Arm Adjusting Screw Nut	2205	2205	4282	4282	4282	4282	4282	4282	4282	4282
Roller Arm Bracket	2205	2205	2205	2205	2205	2205	2205	2205	2205	2205
Roller Arm Look Spring	176J	176J	176J	176J	176J	176J	176J	176J	176J	176J
Roller Arm Look Spring Screw	1549J	1549J	1549J	1549J	1549J	1549J	1549J	1549J	1549J	1549J
Roller Arm Look Spring Screw Nut	316F	316F	316F	316F	316F	316F	316F	316F	316F	316F
Roller Arm Screw Center	1547J	1547J	1547J	1547J	1547J	1547J	1547J	1547J	1547J	1547J
Roller Arm Screw Center Nut	652D	652D	652D	652D	652D	652D	652D	652D	652D	652D
Roller Screw	1528J	1528J	1528J	1528J	1528J	1528J	1528J	1528J	1528J	1528J
Roller Screw Nut	2196	2197	16228	16228	16228	16228	16228	16228	16228	16228
Roller Presser complete										

BALL BEARING ROLLER PRESSERS
FOR MACHINE No. 18-23

Diameter of Roller	1 1/4"	1 1/4"	1 1/4"	1 1/4"	1 1/4"	1 1/4"
Face of Roller	5/32"	coarse	3/16"	coarse	7/32"	coarse
Knurl of Roller	51841	51949	51851	51860	51860	51832
Roller complete	16230	16230	16230	16230	16230	16230
Roller Arm	440F	440F	440F	440F	440F	440F
Roller Arm Adjusting Screw	1547J	1547J	1547J	1547J	1547J	1547J
Roller Arm Adjusting screw Nut	4282	4282	4282	4282	4282	4282
Roller Arm Bracket	2205	2205	2205	2205	2205	2205
Roller Arm Lock Spring	176J	176J	176J	176J	176J	176J
Roller Arm Lock Spring Screw	1549J	1549J	1549J	1549J	1549J	1549J
Roller Arm Lock Spring Screw Nut	316F	316F	316F	316F	316F	316F
Roller Arm Screw Center	1547J	1547J	1547J	1547J	1547J	1547J
Roller Arm Screw Center Nut	16232	16232	16232	16232	16232	16232
Roller Ball	1766C	1766C	1766C	1766C	1766C	1766C
Roller Ball Retaining Nut	50653C	50653C	50653C	50653C	50653C	50653C
Roller Screw	1528J	1528J	1528J	1528J	1528J	1528J
Roller Presser complete	16226	65086	65047	65041	65041	16223

BALL BEARING ROLLER PRESSERS WITH RATCHET BRAKE

FOR MACHINE No. 18-23

Diameter of Roller	1 1/4"	1 1/4"	1 1/4"	1 1/4"	1 1/4"	1 1/4"	1 1/4"
Face of Roller	1/8"	9/64"	3/16"	7/32"	7/32"	7/32"	7/32"
Knurl of Roller	51892	51906	51922	51915	51921	51915	51904
Roller complete	65095	65095	65125	65095	65095	65095	65095
Roller Arm	440F	440F	440F	440F	440F	440F	440F
Roller Arm Adjusting Screw	1547J	1547J	1547J	1547J	1547J	1547J	1547J
Roller Arm Adjusting screw Nut	4282	4282	4282	4282	4282	4282	4282
Roller Arm Bracket	2205	2205	2205	2205	2205	2205	2205
Roller Arm Lock Spring	176J	176J	176J	176J	176J	176J	176J
Roller Arm Lock Spring Screw	1549J	1549J	1549J	1549J	1549J	1549J	1549J
Roller Arm Lock Spring Screw Nut	316F	316F	316F	316F	316F	316F	316F
Roller Arm Screw Center	1547J	1547J	1547J	1547J	1547J	1547J	1547J
Roller Arm Screw Center Nut	16232	16232	16232	16232	16232	16232	16232
Roller Ball	1766C	1766C	1766C	1766C	1766C	1766C	1766C
Roller Ball Retaining Nut	62853	62853	62853	62853	62853	62853	62853
Roller Ratchet Spring Stop	62851	62851	62851	62851	62851	62851	62851
Roller Ratchet Spring Stop Bracket	62854	62854	62854	62854	62854	62854	62854
Roller Ratchet Spring Stop Bracket complete	230F	230F	230F	230F	230F	230F	230F
Roller Ratchet Spring Stop Bracket Screw	665J	665J	665J	665J	665J	665J	665J
Roller Ratchet Spring Stop Bracket Screw Nut	50653C	50653C	50653C	50653C	50653C	50653C	50653C
Roller Screw	1528J	1528J	1528J	1528J	1528J	1528J	1528J
Roller Presser complete	65099	65100	65125	65101	65123	65097	16258

LIST OF PARTS COMPLETE
FOR

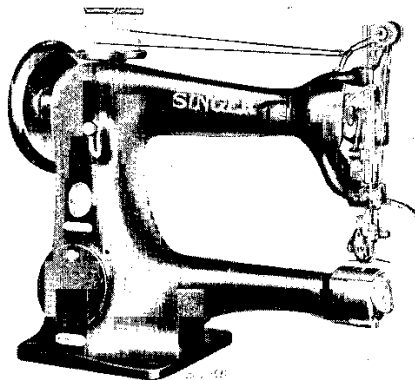

MACHINE No. 18-25

FOR SHOE VAMPING AND OTHER WORK IN LEATHER.
TWO NEEDLES. TWO LONG BEAK SHUTTLES, 1/32
INCH TO 1/4 INCH GAUGES. DROP FEED.
ROLLER PRESSER. SPEED 1800 R. P. M.

No.	Plate	Name
*16274	----	Arm and Cylinder with 15404 and two 15405
16264	3699	" Shaft.....
*16290	----	" " 16264 with 3032, 16266 and 16269
3005	3698	" " Bushing.....
448C	3698	" " " Set Screw.....
16266	3698	" " Counterbalance with 443C.....
443C	3698	" " " Set Screw.....
144D	3698	" " Screw.....
4288	22701	" Side Cover (back).....
51224W	3698	" " " Thumb Screw.....
16102	22701	" " " (front).....
164J	3698	" " " Screw.....

PARTS FOR MACHINE No. 18-25

No.	Plate	Name
2415	22701	Arm Spool Bracket.....
15063	22701	" " " 2415 with two 52239....
145J	3698	" " " Screw.....
52239	3698	" " " Spool Pin and Thread Eyelet.....
11241	3692	Arm Spool Bracket Spool Pin Washer (cloth)
16267	3699	Balance Wheel (disc) for Power Table, 2-3/4 in. pulley, with two 448C.....
16278	3699	Balance Wheel (disc) for Stand, 3 in. pul- ley, for Clamp Stop Motion.....
448C	3698	Balance Wheel Set Screw.....
256J	3698	Clamp Stop Motion Clamp Screw.....
248A	3698	" " " " Stop Screw.....
202C	3698	" " " " Washer.....
*3023	----	" " " Flanged Bushing.....
4933	3698	" " " " 3023 with two 462C.....
2022	22702	Clamp Stop Motion Flanged Bushing Pin....
462C	22702	" " " " " Set Screw
3022	----	Clamp Stop Motion complete, Nos. 248A, 256J 202C and 4933.....
6716	3699	Cloth Plate.....
6719	3699	" " Bracket with 345C.....
345C	22702	" " " Set Screw.....
389F	22702	" " Screw.....
6718	3699	" " Slide.....
3286	22702	" " " Spring.....
725J	22702	" " " " Screw.....
6717	3699	Cloth Plate complete, Nos. 3286, 6716, 6718 and two 725J.....
6702	----	Cloth Plate with Bracket complete, Nos. 6717, 6719 and two 389F.....
4292	3683	Crank Connecting Rod with two 145E.....
145E	3698	" " " Cap Screw.....
375C	22702	" " " " Hinge Screw.....
1518J	22702	" " " " Nut.....
16045	22702	Cylinder Oil Tube for oiling Oscillating Shaft.....
16036	22701	Cylinder Side Cover.....
51224W	3698	" " " Thumb Screw.....
3032	22702	Feed Cam with 446C.....
446C	22702	" " Set Screw.....
52165	22702	" Connecting Link.....
375C	22702	" " " Hinge Screw.....
1518J	22702	" " " " Nut.....
16018	22704	" Dog, for 1/32 in. to 5/64 in. gauges, for 16153.....
6677	22704	Feed Dog, for 3/32 in. to 1/4 in. gauges, for 16153.....
6458	22704	Feed Dog Carrier.....

PARTS FOR MACHINE No. 18-25

No.	Plate	Name
231C	22704	Feed Dog Screw.....
3037	3683	" Forked Connection.....
375C	22702	" " " Hinge Screw.....
1518J	22702	" " " " Nut....
16177	-----	Feed Forked Connection complete, Nos.3037 16241, 52165 and two each 375C and 1518J.....
6459	22702	Feed Regulator.....
16241	-----	" " 6459 with 818D.....
58E	22704	" " Hinge Screw.....
818D	22702	" " Thumb Screw.....
6678	22703	" Rock Shaft.....
16219	-----	" " " 6678 with 6458.....
6018	22704	" " " Crank with 207F.....
156F	22704	" " " Position Screw....
207F	22704	" " " Set Screw.....
16275	22703	Needle Bar (hollow).....
16276	-----	" " 16275 with 2273 and 4783, for 1/32 in. to 5/64 in. gauges.....
16277	-----	Needle Bar 16275 with 2273 and 6524, for 3/32 in. to 1/4 in. gauges.....
*3045	22705	Needle Bar Connecting Link.....
16220	-----	" " " 3045 with 377C, 1518J and 6487.....
377C	22705	Needle Bar Connecting Link Hinge Screw...
1518J	22702	" " " Nut
6487	22705	" " " Stud with 155C....
155C	22705	" " " Set Screw....
3214	22705	" " Guide with 400C and 453C.....
400C	22705	" " Adjusting Screw.....
453C	22705	" " " Set Screw.....
290E	22705	" " Screw Bushing.....
4783	22705	" Clamp with two 336F.....
Note: When ordering No. 4783, state gauge required.		
6524	22705	Needle Clamp with two 50014F, for 3/32 in. to 1/4 in. gauges.....
2273	22705	Needle Clamp Pin.....
336F	22705	" Set Screw, for 4783.....
50014F	22705	" " " 6524.....
*16111	22701	Oscillating Rock Shaft.....
16112	-----	Oscillating Rock Shaft complete, Nos.4784, 16111 and 16212.....
6489	3683	Oscillating Rock Shaft Hinge Pin.....
*16212	-----	" " " 6489 with 1513J.....
1513J	22705	Oscillating Rock Shaft Hinge Pin Nut....
4784	22705	" " " Oil Pad.....
16113	22703	" Shaft.....
*16221	-----	" " 16113 with 2049,16193 and 16213.....
16115	-----	Oscillating Shaft Crank for 16116.....

PARTS FOR MACHINE No. 18-25

No.	Plate	Name
*16192	-----	Oscillating Shaft Crank for 16193.....
16116	22705	Oscillating Shaft Crank complete, Nos. 1518J, 16115, 19390 and two 462C....
*16193	-----	Oscillating Shaft Crank complete, Nos. 462C, 1518J, 16192 and 19390.....
2049	22705	Oscillating Shaft Crank Pin.....
462C	22702	" " " Set Screw.....
19389	22705	" " " Slide Block.....
226J	22705	" " " " Cap Screw.....
12424	22705	Oscillating Shaft Crank Slide Block Cap Screw Washer.....
969C	22705	Oscillating Shaft Crank Slide Block Screw Stud.....
1518J	22702	Oscillating Shaft Crank Slide Block Screw Stud Nut.....
19390	-----	Oscillating Shaft Crank Slide Block com- plete, Nos. 226J, 969C, 12424 and 19389.....
16145	22703	Presser Bar (hollow).....
6464	3683	" " Lifter.....
77J	22706	" " " Screw.....
6465	22706	" " " Washer.....
16197	22706	" " Lifting Bracket with 175J and two 457K.....
16198	-----	Presser Bar Lifting Bracket 16197 with 16196 and two 335J.....
175J	22706	Presser Bar Lifting Bracket Adjusting Screw.....
6469	3683	Presser Bar Lifting Bracket Guide
175J	22706	" " " " Screw..
457K	22706	" " " " Set Screw...
16196	3683	" " " " Wearing Plate
335J	22706	" " " " " "
Screw.....		
921E	22706	Presser Bar Screw Bushing.....
16156	22706	" " Spring (light) .065" wire....
16147	-----	" " " (heavy) .063" wire....
11170	22706	" " " Washer.....
16148	22706	" " Stop Collar with 1019C.....
1019C	22706	" " " Set Screw.....
688J	22706	Pressure Regulating Thumb Screw.....
1958	22707	Roller, 1-1/2 in. diam., 3/16 in. face, coarse, with 1261D and 1528J, for 16071 and 16082.....
1875	22707	Roller, 1-1/2 in. diam., 7/32 in. face, diagonal knurl, with 634D and 1528J, for 16014 and 16017.....

PARTS FOR MACHINE No. 18-25

No.	Plate	Name
51834	22708	Roller, 1-1/2 in. diam., 3/16 in. face, coarse (ball bearing) complete for 16234 and 16235, Nos. 1528J, 1766C, 50553C and twenty-four 16232.....
51855	22708	Roller, 1-1/2 in. diam., 3/16 in. face, coarse (ball bearing) complete for 16237, Nos. 1528J, 1766C, 50553C and twenty-four 16232.....
51905	22708	Roller, 1-1/2 in. diam., 1/4 in. face, medium (ball bearing) with ratchet brake complete for 16260, Nos. 1528J, 1766C, 50553C and twenty-four 16232..
51911	22709	Roller, 1-1/2 in. diam., 3/16 in. face, medium (ball bearing) with ratchet brake complete for 16261, Nos. 1528J, 1766C, 50553C and twenty-four 16232..
6535	22707	Roller Arm for 16014 and 16082.....
16015	22707	" " " 16017 and 16071.....
16231	22708	" " " 16234, 16235 and 16237....
16259	22708	" " " 16260 and 16261.....
440F	3689	" " Adjusting Screw.....
1547J	3689	" " " Nut.....
4785	22707	" " Bracket for 16014, 16082, 16234, 16237, 16260 and 16261.....
19200	22707	Roller Arm Bracket for 16017, 16071 and 16235.....
7556	22709	Roller Arm Lock Spring.....
176J	3689	" " " " Screw.....
1549J	3689	" " " " Nut.....
316F	3689	" " " " Screw Center.....
15444	-----	" " " " 316F with 1547J..
1547J	3689	" " " " Nut.....
16232	3689	" " Ball, size 3/32 in. for 51834, 51855, 51905 and 51911.....
1766C	3689	Roller Ball Retaining Nut for 51834, 51855, 51905 and 51911.....
16010	22709	Roller Needle Guard (flat) for 16014.....
16080	-----	" " " " 16082, 16234, 16237, 16260 and 16261.....
207F	22704	Roller Needle Guard (flat) Screw for 16014, 16082, 16234, 16237, 16260 and 16261.....
16013	22709	Roller Needle Guard (round) for 16014....
16016	22709	" " " " 16017, 16071 and 16235.....
16081	-----	Roller Needle Guard (round) for 16082, 16234, 16237, 16260 and 16261.....
16138	22709	Roller Needle Guard (round) with 242J and 16139, for 16014.....

PARTS FOR MACHINE No. 18-25

No.	Plate	Name
16139	22709	Roller Needle Guard (round) Edge Guide, for 16138.....
242J	22709	Roller Needle Guard (round) Edge Guide Screw.....
171F	22709	Roller Needle Guard (round) Set Screw....
62853	3689	" " Ratchet Spring Stop, for 62854....
62851	3689	" " " " Bracket, for 62854.....
62854	-----	Roller Ratchet Spring Stop Bracket 62851 with 665J and 62853, for 16260 and 16261.....
230F	3689	Roller Ratchet Spring Stop Bracket Screw, for 16260 and 16261.....
665J	3689	Roller Ratchet Spring Stop Screw for 62854.....
634D	22709	Roller Screw, for 1875.....
1261D	22709	" " " 1958.....
50553C	3689	" " " 51834, 51855, 51905 and 51911.....
1528J	3689	Roller Screw Nut.....
16082	22707	Roller Presser complete, 1-1/2 in. diam., 3/16 in. face, for 1/32 in. to 5/64 in. gauges, Nos. 171F, 176J, 207F, 440F, 1547J, 1549J, 1958, 4785, 6535, 7556, 16080, 16081 and two 15444....
16014	22707	Roller Presser complete, 1-1/2 in. diam., 7/32 in. face, for 1/32 in. to 1/16 in. gauges, Nos. 171F, 176J, 207F, 440F, 1547J, 1549J, 1875, 4785, 6535, 7556, 16010, 16013 and two 15444....
16071	22707	Roller Presser complete, 1-1/2 in. diam., 3/16 in. face, for 3/32 in. to 1/4 in. gauges, Nos. 171F, 176J, 440F, 1547J, 1549J, 1958, 7556, 16015, 16016, 19200 and two 15444.....
16017	22707	Roller Presser complete, 1-1/2 in. diam., 7/32 in. face, for 3/32 in. to 1/4 in. gauges, Nos. 171F, 176J, 440F, 1547J, 1549J, 1875, 7556, 16015, 16016, 19200 and two 15444.....
16234	22708	Roller Presser (ball bearing) complete, 1-1/2 in. diam., 3/16 in. face, for 1/32 in. to 5/64 in. gauges, Nos. 171F, 176J, 207F, 440F, 1547J, 1549J, 4785, 7556, 16080, 16081, 16231, 51834 and two 15444.....

No.	Plate	Name
16235	22708	Roller Presser (ball bearing) complete, 1-1/2 in. diam., 3/16 in. face, for 3/32 in. to 1/4 in. gauges, Nos. 171F, 176J, 440F, 1547J, 1549J, 7556, 18016, 16231, 19200, 51834 and two 15444...
16237	22708	Roller Presser (ball bearing) complete, 1-1/2 in. diam., 3/16 in. face, for 1/32 in. to 5/64 in. gauges, Nos. 171F, 176J, 207F, 440F, 1547J, 1549J, 4785, 7556, 16080, 16081, 16231, 51855 and two 15444.....
16260	22708	Roller Presser (ball bearing) complete, 1-1/2 in. diam., 1/4 in. face, with ratchet brake, for 1/32 in. to 5/64 in. gauges, Nos. 171F, 176J, 207F, 230F, 440F, 1547J, 1549J, 4785, 7556, 16080, 16081, 16259, 51905, 62854 and two 15444.....
16261	22709	Roller Presser (ball bearing) complete, 1-1/2 in. diam., 3/16 in. face, with ratchet brake, for 1/32 in. to 5/64 in. gauges, Nos. 171F, 176J, 207F, 230F, 440F, 1547J, 1549J, 4785, 7556, 16080, 16081, 16259, 51911, 62854 and two 15444.....
190J	22704	Roller Presser Screw.....
2210	22706	Shuttle (inside) Bobbin.....
3230	22706	" " " Retaining Spring
2212	3689	" " " " Rivet.....
*3235	-----	Shuttle (inside) Body with 398E, 2084, 3230, 3240 and two 2212.....
*16205	-----	Shuttle (inside) Cover.....
2076	3689	" " " Hinge Pin.....
2078	3689	" " " Delivery Eye Thread Guard.....
2080	3689	Shuttle (inside) Delivery Eye Thread Guard Rivet.....
3240	22706	Shuttle (inside) Main Spring.....
398E	3689	" " " " Screw.....
2084	3689	" " " " Steady Pin.
466H	3689	" " " Tension Regulating Screw.....
2086	3689	Shuttle (inside) Tension Spring.....
2090	3689	" " " " Plate...
112E	3689	" " " " " Screw.....

No.	Plate	Name
16206	22706	Shuttle (inside) closed eye complete, for 1/32 in. to 1/4 in. gauges, Nos. 112E, 466H, 2076, 2078, 2080, 2086, 2090, 2210, 3235 and 16205.....
2210	22706	Shuttle (outside) Bobbin.....
3230	22706	" " " Retaining Spring.
2212	3689	" " " " Rivet.....
*3232	-----	Shuttle (outside) Body with 398E, 2084, 3230, 3239 and two 2212, for 16209...
*3383	-----	Shuttle (outside) Body with 398E, 2084, 3230, 3239 and two 2212, for 16208...
*16207	-----	Shuttle (outside) Cover.....
2076	3689	" " " Hinge Pin.....
3238	22706	" " " Delivery Eye Thread Guard.....
2080	3689	Shuttle (outside) Delivery Eye Thread Guard Rivet.....
3239	22706	Shuttle (outside) Main Spring.....
398E	3689	" " " " Screw.....
2084	3689	" " " " Steady Pin.
466H	3689	" " " Tension Regulating Screw.....
3241	22706	Shuttle (outside) Tension Spring.....
3242	22706	" " " " Plate...
112E	3689	" " " " " Screw
16209	22710	Shuttle (outside) closed eye complete, for 1/32 in. to 5/64 in. gauges, Nos. 112E, 466H, 2076, 2080, 2210, 3232, 3238, 3241, 3242 and 16207.....
16208	22710	Shuttle (outside) closed eye complete, for 3/32 in. to 1/4 in. gauges, Nos. 112E, 466H, 2076, 2080, 2210, 3238, 3241, 3242, 3383 and 16207.....
16213	22710	Shuttle Driver and Feed Lifting Cam.....
2049	22705	" " " " Pin..
16166	-----	" Race Body (two pieces) with either 813D, 814D or 815D, for 6746..
16238	22713	Shuttle Race Body (two pieces) with either 813D, 814D or 815D, for 16239.
16103	22713	Shuttle Race Cap.....
102J	22710	" " " Screw.....
813D	22710	" " " Hinge Screw, for 1/32 in. to 1/8 in. gauges.....
814D	22710	Shuttle Race Hinge Screw, for 9/64 in. to 5/32 in. gauges.....
815D	22710	Shuttle Race Hinge Screw, for 3/16 in. to 1/4 in. gauges.....

PARTS FOR MACHINE No. 18-25

No.	Plate	Name
6709	22710	Shuttle Race Lock Pin.....
Note: When ordering No. 6709, state gauge of Shuttle Race for which it is required.		
16101	22710	Shuttle Race Lock Pin Bushing.....
6758	22713	" " " " Spring.....
102J	22710	" " " " " Screw.....
6746	-----	Shuttle Race complete, for 3/32 in. to 1/4 in. gauges, Nos. 6709, 6758, 16166 and two 102J.....
16239	22713	Shuttle Race complete, for 1/32 in. to 5/64 in. gauges, Nos. 6709, 6758, 16238 and two 102J.....
738D	22710	Shuttle Race Screw.....
16136	22713	Tension and Needle Bar Guide Bracket....
16137	-----	Tension and Needle Bar Guide Bracket complete, Nos. 16136, two each 2103, 33929 and four 2102.....
190J	22704	Tension and Needle Bar Guide Bracket Screw.....
2102	3686	Tension Disc.....
1560C	3686	" Regulating Thumb Nut.....
6600	22711	" Releaser.....
16149	22711	" " Bracket with two 465C....
465C	22711	" " Set Screw.....
207J	22704	" " Screw.....
637C	22711	" Screw Stud.....
33929	-----	" " 637C with 1560C.....
2103	3686	" Spring.....
2413	22711	" Thread Eyelet (double).....
330J	22711	" " " Screw.....
*16269	-----	Thread Take-up Cam.....
16270	3692	" " " 16269 with 446C.....
3012	22711	" " " Pin.....
446C	22702	" " " Set Screw.....
*6704	22711	" " Lever with 1819.....
16181	-----	" " " 6704 with 76F.....
76F	3686	" " " Hinge Screw.....
1819	3686	" " " Roller and Stud.....
2410	22711	" " " Roller.....
86D	22711	" " " Screw.....
2411	22711	" " " Stud.....
175F	22706	" " " Set Screw.....
6603	22711	" " Spring.....
6477	3686	" " Regulator Plate....
233J	22705	" " " " Ad-justing Screw.....
6602	22711	Thread Take-up Spring Thread Guard and Thread Eyelet.....
219J	3686	Thread Take-up Spring Thread Guard and Thread Eyelet Screw.....

PARTS FOR MACHINE No. 18-25

No.	Plate	Name
16151	22704	Throat Plate Body.....
16152	22704	" " Needle Plate.....
228D	22704	" " " " Screw.....
16153	22704	Throat Plate complete for 16018, for 1/32 in. to 5/64 in. gauges, and for 6677, for 3/32 in. to 1/4 in. gauges, Nos. 228D, 16151 and 16152.....
691D	22704	Throat Plate Screw.....
16077	3693	Drip Pan.....
*15404	-----	Trade Mark.....
15405	-----	" " Rivet.....

Genuine Singer Needles should be used in Singer Machines. These Needles and their Containers are marked with the Company's Trade Mark "SIMANCO." 1

Needles in Containers marked "For Singer Machines" are not Singer made needles. 2

MACHINE BASE

No.	Plate	Name
16031	3693	Machine Base with four each 121E and wood screws 1-1/4 in. No. 12.....
121E	22711	Machine Screw, to secure machine to base.

ATTACHMENTS AND ACCESSORIES

No.	Plate	Name
51072E	22712	Machine Bolt with 51581E, to secure machine to table.....
51581E	22712	Machine Bolt Nut.....
6055	22711	" " " Washer.....
120342	22714	Oiler (copper plated) with 120343.....
120343	22714	" Spout, 3-1/2 in. long.....
26026	22714	Screw Driver (machine).....
26485	22714	" " (shuttle tension).....
8908	22714	Wrench for 1520.....
8909	22714	" " 1513, 1518 and 51581.....
4822	22714	" " 1528, 1547 and 1549.....

BOBBIN WINDER

(SWINGING AUTOMATIC, LEFT HAND)

No.	Plate	Name
16271	3692	Base.....
27321	3692	Frame.....
50356D	3686	" Hinge Screw.....
1620J	3686	" " " Nut.....
27322	22712	" Spring.....
27541	3692	Pulley.....
27305	3692	Spindle.....
27306	3692	Spool Pin.....
27307	3692	" Stand.....
27308	3692	Spool Stand complete, Nos. 418E, 1562J, 2106, 10141, 11241, 27306, 27307 and two each 2455 and wood screws 1 in. No. 10.....
11241	3692	Spool Washer (cloth).....
27326	22712	Stop Latch.....
35D	3686	" " Hinge Screw.....
2455	22711	Tension Disc.....
1562J	22712	" Regulating Thumb Nut.....
418E	22712	" Screw Stud.....

BOBBIN WINDER

No.	Plate	Name
10141	22712	Tension Spring.....
2106	3686	" Thread Guide.....
16272	-----	Bobbin Winder, Nos. 35D, 1620J, 16271, 27305, 27321, 27322, 27326, 27541, 50356D and two wood screws 1 in. No. 7 F.H.....
16273	-----	Bobbin Winder complete, Nos. 16272 and 27308.....

FOOT LIFTER PARTS

No.	Plate	Name
6439	-----	Chain, 36 in. to 45 in., with 56864 and 56865.....
Note: When ordering No. 6439, give length required.		
4879	3692	Chain Connecting Link.....
56864	3692	" Hook (large).....
56865	3692	" " (small).....
6692	3691	Lifting Lever.....
802D	22712	" " Hinge Screw.....
16130	3691	" " Spring.....
4881	3691	Treadle.....
4882	3692	" Shaft.....
4883	3692	" Spring.....
4884	3691	" Stand.....
4885	3691	Treadle complete, Nos. 4879, 4881 to 4884 and two wood screws 1 in. No. 16.....
6698	-----	Foot Lifter complete, Nos. 802D, 4885, 6439, 6692 and 16130.....

KNEE LIFTER PARTS

(POWER TABLE OR STAND)

No.	Plate	Name
6692	3691	Lifting Lever.....
802D	22712	" " Hinge Screw.....
16130	3691	" Spring.....
6703	3691	Pitman, length 14-1/8 in. for 6691.....
7898	3691	" " 19 in., for 16154.....
7124	3691	Rock Shaft.....
2764	3691	" " Hanger (back) with two wood screws 1 in. No. 10.....
16128	3691	Rock Shaft Hanger (front) with two wood screws 1 in. No. 10.....
16646	3691	Rock Shaft Knee Arm.....

KNEE LIFTER PARTS

No.	Plate	Name
16647	-----	Rock Shaft Knee Arm complete, Nos. 2766, 2767 and 16646.....
2766	3691	Rock Shaft Knee Arm Hub with 356C.....
356C	22712	" " " " " Set Screw.....
2767	3691	" " " " " Plate with 356C.....
356C	22712	" " " " " Set Screw.....
6337	3691	" " " " " Lifting Bracket with two 356C.
6338	3691	" " " " " Hook.....
356C	22712	" " " " " Set Screw.....
356C	22712	" " " " " Set Screw.....
2770	3691	" " " " " Stop Dog with 356C.....
356C	22712	" " " " " Set Screw.....
16129	3691	Rock Shaft complete, Nos. 2764, 6337, 6338, 7124, 16128, 16647 and two 2770.....
6691	-----	Knee Lifter complete, Nos. 802D, 6692, 6703, 16129 and 16130.....
16154	-----	Knee Lifter complete for Machine on Base, Nos. 802D, 6692, 7898, 16129 and 16130.....

THREAD LUBRICATORS

THREAD LUBRICATOR No. 16248

FOR MACHINE No. 18-23

No.	Plate	Name
16247	3691	Arm Side Cover (front).....
62819	22712	Thread Lubricator Oil Pad (felt).....
62822	-----	Thread Lubricator Oil Pad Holder complete
62824	22712	" " " " " Retainer.....
62827	-----	" " " " " Wick (braided cotton).....
50222J	22712	Thread Lubricator Screw.....
21202	22712	" " " " " Friction Washer..
1529E	22712	" " " " " Nut.....
62828	-----	Thread Lubricator complete.....
62829	3691	" " " " " 62828 with 1529E, 50222J and two 21202.....
16248	3691	Arm Side Cover (front) with Thread Lubricator complete, Nos. 16247 and 62829.

THREAD LUBRICATOR No. 16254

FOR MACHINE No. 18-25

No.	Plate	Name
16249	22712	Thread Lubricator Bracket Extension.....

THREAD LUBRICATOR No. 16254

No.	Plate	Name
50222J	22712	Thread Lubricator Bracket Screw.....
21202	22712	" " " " " Friction Washer.....
1529E	22712	Thread Lubricator Bracket Screw Nut.....
241755	22712	" " " " " Oil Pad (felt).....
16251	-----	Thread Lubricator Oil Pad Holder complete
241757	22712	" " " " " Retainer.....
62827	-----	" " " " " Wick (braided cotton).....
16253	-----	Thread Lubricator complete.....
16254	22713	" " " " " 16253 with 1529E, 16249, 50152J and two 21202.....
50152J	22712	Thread Lubricator Screw.....

Genuine Singer Needles should be used in Singer Machines. These Needles and their Containers are marked with the Company's Trade Mark "SIMANCO." 1

Needles in Containers marked "For Singer Machines" are not Singer made needles. 2

NUMERICAL LIST OF PARTS

No.	Plate	Name
35D	3686	Bobbin Winder Stop Latch Hinge Screw, for 16272.....
58E	22704	Feed Regulator Hinge Screw.....
76F	3686	Thread Take-up Lever Hinge Screw, for 16180 and 16181.....
77J	22706	Presser Bar Lifter Screw.....
86D	22711	Thread Take-up Roller Screw, for 18-25 Machine.....
102J	22710	Shuttle Race Cap Screw, for 18-25 Machine
102J	22710	" " Lock Pin Spring Screw, for 6746 and 16239.....
112E	3689	Shuttle Tension Spring Plate Screw, for 44001.....
112E	3689	Shuttle (inside) Tension Spring Plate Screw, for 16206.....
112E	3689	Shuttle (outside) Tension Spring Plate Screw, for 16208 and 16209.....
121E	22711	Machine Screw, to secure machine to base, for 16031.....
144D	3698	Arm Shaft Screw.....
145J	3698	" Spool Bracket Screw, for 18-25 Machine
145E	3698	Crank Connecting Rod Cap Screw, for 4292..
155C	22705	Needle Bar Connecting Stud Set Screw, for 6487.....
156F	22704	Feed Rock Shaft Crank Position Screw....
164J	3698	Arm Side Cover (front) Screw.....
171F	22709	Roller Needle Guard (round) Set Screw, for 16014, 16017, 16071, 16082, 16234, 16235, 16237, 16260 and 16261.....
175J	22706	Presser Bar Lifting Bracket Adjusting Screw, for 16194 and 16197.....
175J	22706	Presser Bar Lifting Bracket Guide Screw..
175J	22706	Tension Screw Stud Set Screw, for 18-23 Machine.....
175F	22706	Thread Take-up Roller Stud Set Screw, for 18-25 Machine.....
176J	3689	Roller Arm Lock Spring Screw, for 2196, 2197, 16014, 16017, 16071, 16082, 16099, 16100, 16225, 16226, 16228, 16233 to 16237, 16258, 16260, 16261, 65041, 65047, 65086, 65097, 65099 to 65101, 65123 and 65126.....
190J	22704	Presser Foot Screw, for 18-23 Machine....
190J	22704	Roller Presser Screw.....
190J	22704	Tension and Needle Bar Guide Bracket Screw, for 18-25 Machine.....

**Genuine Singer Needles should be used
in Singer Machines.
These Needles and their Containers
are marked with the
Company's Trade Mark "SIMANCO." 1**

**Needles in Containers marked
"For Singer Machines"
are not Singer made needles. 2**

NUMERICAL LIST OF PARTS

No.	Plate	Name
207F	22704	Feed Rock Shaft Crank Set Screw, for 6018
207F	22704	" Wheel Driver Spring Screw, for 18-23 Machine.....
207F	22704	Feed Wheel Friction Spring Screw, for 18-23 Machine.....
207F	22704	Roller Needle Guard (flat) Screw, for 16014, 16082, 16234, 16237, 16260 and 16261.....
207J	22704	Tension Releaser Screw, for 18-25 Machine
219J	3686	" Thread Guard Screw, for 18-23 Machine.....
219J	3686	Thread Take-up Spring Thread Guard and Thread Eyelet Screw, for 18-25 Machine
226J	22705	Oscillating Shaft Crank Slide Block Cap Screw, for 19390.....
228D	22704	Throat Plate Needle Plate Screw, for 16153
230F	3689	Roller Ratchet Spring Stop Bracket Screw, for 16258, 16260, 16261, 65097, 65099 to 65101, 65123 and 65126.....
231C	22704	Feed Dog Screw, for 18-25 Machine.....
233J	22705	Needle Bar Thread Guide Screw, for 18-23 Machine.....
233J	22705	Thread Take-up Spring Regulator Plate Adjusting Screw.....
242J	22709	Roller Needle Guard (round) Edge Guide Screw, for 16138.....
248A	3698	Clamp Stop Motion Clamp Stop Screw, for 3022.....
256J	3698	Clamp Stop Motion Clamp Screw, for 3022..
262J	3683	Pressure Regulating Thumb Screw, for 18-23 Machine.....
290E	22705	Needle Bar Screw Bushing.....
290E	22705	Presser Bar Screw Bushing, for 18-23 Machine.....
316F	3689	Roller Arm Screw Center, for 15444.....
330J	22711	Tension Thread Eyelet Screw, for 18-25 Machine.....
335J	22706	Presser Bar Lifting Bracket Wearing Plate Screw, for 16195 and 16198.....
336F	22705	Needle Set Screw, for 4783.....
345C	22702	Cloth Plate Bracket Set Screw, for 6083 and 6719.....
356C	22712	Rock Shaft Knee Arm Hub Set Screw, for 2766.....
356C	22712	Rock Shaft Knee Plate Set Screw, for 2767
356C	22712	" " Lifting Bracket Hook Set Screw for 6337.....
356C	22712	Rock Shaft Lifting Bracket Set Screw, for 6337.....

NUMERICAL LIST OF PARTS

No.	Plate	Name
356C	22712	Rock Shaft Stop Dog Set Screw, for 2770..
375C	22702	Crank Connecting Rod Hinge Screw.....
375C	22702	Feed Connecting Link Hinge Screw.....
375C	22702	" Forked Connection Hinge Screw, for 16177.....
377C	22705	Needle Bar Connecting Link Hinge Screw, for 16220.....
386D	3689	Roller Screw, for 1839, 1869, 1897 and 1898.....
389F	22702	Cloth Plate Screw, for 6494 and 6702.....
398E	3689	Shuttle Main Spring Screw, for 6058.....
398E	3689	" (inside) Main Spring Screw, for 3235.....
398E	3689	Shuttle (outside) Main Spring Screw, for 3232 and 3383.....
399J	22711	Throat Ring Screw, for 18-23 Machine.....
400C	22705	Needle Bar Guide Adjusting Screw, for 3214.....
418E	22712	Bobbin Winder Tension Screw Stud, for 27308.....
440F	3689	Roller Arm Adjusting Screw, for 2196, 2197 16014, 16017, 16071, 16082, 16099, 16100, 16225, 16226, 16228, 16233 to 16237, 16258, 16260, 16261, 65041, 65047, 65086, 65097, 65099 to 65101, 65123 and 65126.....
443C	3698	Arm Shaft Counterbalance Set Screw, for 16266.....
446C	22702	Feed Cam Set Screw, for 3032.....
446C	22702	" Eccentric Set Screw, for 3074.....
446C	22702	Thread Take-up Cam Set Screw, for 16270..
448C	3698	Arm Shaft Bushing Set Screw.....
448C	3698	Balance Wheel Set Screw, for 16267.....
453C	22705	Needle Bar Guide Set Screw, for 3214.....
457K	22706	Presser Bar Lifting Bracket Set Screw, for 16194 and 16197.....
460C	22705	Oscillating Shaft Crank Set Screw, for 6056.....
462C	22702	Clamp Stop Motion Flanged Bushing Set Screw, for 4933.....
462C	22702	Oscillating Shaft Crank Set Screw, for 6024, 16116 and 16193.....
465C	22711	Tension Releaser Bracket Set Screw, for 16149.....
466H	3689	Shuttle Tension Regulating Screw, for 44001.....
466H	3689	Shuttle (inside) Tension Regulating Screw for 16206.....
466H	3689	Shuttle (outside) Tension Regulating Screw, for 16208 and 16209.....

NUMERICAL LIST OF PARTS

No.	Plate	Name
600C	3686	Tension Screw Stud, for 16202.....
634D	22709	Roller Screw, for 1875.....
637C	22711	Tension Screw Stud, for 33929.....
652D	3689	Roller Screw, for 1841, 1868 and 1923....
665J	3689	" Ratchet Spring Stop Screw, for 62854.....
665J	3689	Throat Ring Needle Plate Screw, for 16244
688J	22706	Pressure Regulating Thumb Screw, for 18-25 Machine.....
691D	22704	Throat Plate Screw, for 18-25 Machine....
725J	22702	Cloth Plate Slide Spring Screw, for 6495 and 6717.....
725J	22702	Shuttle Race Ring Latch Screw, for 6500..
738D	22710	" Screw, for 18-25 Machine....
802D	22712	Lifting Lever Hinge Screw, for 6891, 6898 and 16154.....
808F	22705	Needle Clamp Screw, for 4303.....
813D	22710	Shuttle Race Hinge Screw, for 1/32 in. to 1/8 in. gauges, for 16166 and 16238..
814D	22710	Shuttle Race Hinge Screw, for 9/64 in. to 5/32 in. gauges, for 16166 and 16238..
815D	22710	Shuttle Race Hinge Screw, for 3/16 in. to 1/4 in. gauges, for 16166 and 16238..
818D	22702	Feed Regulator Thumb Screw, for 16241....
921E	22706	Presser Bar Screw Bushing, for 18-25 Machine.....
969C	22705	Oscillating Shaft Crank Slide Block Screw Stud, for 19390.....
1019C	22706	Presser Bar Stop Collar Set Screw, for 16148.....
1253C	3686	Tension Releaser Collar Set Screw, for 16240.....
1261D	22709	Roller Screw, for 1958.....
1513J	22705	Oscillating Rock Shaft Hinge Pin Nut, for 16212.....
1518J	22702	Crank Connecting Rod Hinge Screw Nut....
1518J	22702	Feed Connecting Link Hinge Screw Nut....
1518J	22702	" Forked Connection Hinge Screw Nut, for 16177.....
1518J	22702	Needle Bar Connecting Link Hinge Screw Nut, for 16220.....
1518J	22702	Oscillating Shaft Crank Slide Block Screw Stud Nut, for 16116 and 16193.....
1528J	3689	Roller Screw Nut, for 1839, 1841, 1868, 1869, 1875, 1897, 1898, 1923, 1958, 51832, 51834, 51841, 51849, 51851, 51855, 51860, 51892, 51904 to 51906, 51911, 51913, 51915, 51921 and 51922.
1529E	22712	Thread Lubricator Bracket Screw Nut, for 16254.....

NUMERICAL LIST OF PARTS

No.	Plate	Name
1529E	22712	Thread Lubricator Screw Nut, for 62829...
1547J	3689	Roller Arm Adjusting Screw Nut, for 2196, 2197, 16014, 16017, 16071, 16082, 16099, 16100, 16225, 16226, 16228, 16233 to 16237, 16258, 16260, 16261, 65041, 65047, 65086, 65097, 65099 to 65101, 65123 and 65126.....
1547J	3689	Roller Arm Screw Center Nut, for 15444...
1549J	3689	" " Lock Spring Screw Nut for 2196 2197, 16014, 16017, 16071, 16082, 16099, 16100, 16225, 16226, 16228, 16233 to 16237, 16258, 16260, 16261, 65041, 65047, 65086, 65097, 65099 to 65101, 65123 and 65126.....
1560C	3686	Tension Regulating Thumb Nut, for 16202 and 33929.....
1562J	22712	Bobbin Winder Tension Regulating Thumb Nut, for 27308.....
1620J	3686	Bobbin Winder Frame Hinge Screw Nut, for 16272.....
1766C	3689	Roller Ball Retaining Nut, for 51832, 51834, 51841, 51849, 51851, 51855, 51860, 51892, 51904 to 51906, 51911, 51913, 51915, 51921 and 51922.....
1813	22705	Oscillating Shaft Crank Roller and Stud, for 6024 and 6056.....
1819	3686	Thread Take-up Lever Roller and Stud, for 6474 and 6704.....
1839	3681	Roller, 1-1/4 in. diam., 9/64 in. face, coarse, with 386D and 1528J, for 16099
1841	3681	Roller, 7/8 in. diam., 9/64 in. face, fine with 652D and 1528J, for 2197.....
1868	3681	Roller, 7/8 in. diam., 9/64 in. face, coarse, with 652D and 1528J, for 2196.
1869	3682	Roller, 1-1/4 in. diam., 9/64 in. face, fine, with 386D and 1528J, for 16100.
1875	22707	Roller, 1-1/2 in. diam., 7/32 in. face, diagonal knurl, with 634D and 1528J, for 16014 and 16017.....
1897	3682	Roller, 1-1/4 in. diam., 3/16 in. face, coarse, with 386D and 1528J, for 16225
1898	3682	Roller, 1-1/4 in. diam., 3/16 in. face, fine, with 386D and 1528J, for 16226.
1923	3681	Roller, 1-1/4 in. diam., 1/8 in. face, coarse, with 652D and 1528J, for 16228
1958	22707	Roller, 1-1/2 in. diam., 3/16 in. face, coarse, with 1261D and 1528J, for 16071 and 16082.....
2020	3698	Clamp Stop Motion Clamp Washer, for 3022.

NUMERICAL LIST OF PARTS

No.	Plate	Name
2022	22702	Clamp Stop Motion Flanged Bushing Pin....
2049	22705	Oscillating Shaft Crank Pin, for 16184 and 16221.....
2049	22705	Shuttle Driver and Feed Lifting Cam Pin, for 18-25 Machine.....
2049	22705	Shuttle Driver Pin, for 18-23 Machine....
2070	22706	Presser Bar Spring Washer, for 18-23 Machine.....
2073	3689	Shuttle Bobbin, for 6028.....
*2075	-----	" Cover, for 44001.....
2076	3689	" " Hinge Pin, for 6028.....
2076	3689	" (inside) Cover Hinge Pin, for 16206.....
2076	3689	Shuttle (outside) Cover Hinge Pin, for 16208 and 16209.....
2078	3689	Shuttle Delivery Eye Thread Guard, for 44001.....
2078	3689	Shuttle (inside) Delivery Eye Thread Guard, for 16206.....
2080	3689	Shuttle Delivery Eye Thread Guard Rivet, for 44001.....
2080	3689	Shuttle (inside) Delivery Eye Thread Guard Rivet, for 16206.....
2080	3689	Shuttle (outside) Delivery Eye Thread Guard Rivet, for 16208 and 16209.....
2082	3689	Shuttle Main Spring, for 6058.....
2084	3689	" " Steady Pin, for 6058
2084	3689	" (inside) Main Spring Steady Pin, for 3235.....
2084	3689	Shuttle (outside) Main Spring Steady Pin, for 3232 and 3383.....
2086	3689	Shuttle Tension Spring, for 44001.....
2086	3689	" (inside) Tension Spring, for 16206
2090	3689	" Tension Spring Plate, for 44001..
2090	3689	" (inside) Tension Spring Plate, for 16206.....
2102	3686	Tension Disc, for 16137 and 16204.....
2103	3686	" Spring, for 16137 and 16204.....
2106	3686	Bobbin Winder Tension Thread Guide, for 27308.....
2106	3686	Thread Eyelet (front of arm) for 18-23 Machine.....
2180	22704	Presser Foot, for 18-23 Machine.....
2196	3681	Roller Presser complete, 7/8 in. diam., 9/64 in. face, coarse roller, for 18-23 Machine, Nos. 176J, 440F, 1547J, 1549J, 1868, 2203, 2205, 2206 and two 15444.....

NUMERICAL LIST OF PARTS

No.	Plate	Name
2197	3681	Roller Presser complete, 7/8 in. diam., 9/64 in. face, fine roller, for 18-23 Machine, Nos. 176J, 440F, 1547J, 1549J, 1841, 2203, 2205, 2206 and two 15444.
2203	3681	Roller Arm, for 2196 and 2197.....
2205	3689	" " Lock Spring, for 2196, 2197, 16099, 16100, 16225, 16226, 16228, 16233, 16236, 16258, 65041, 65047, 65086, 65097, 65099 to 65101, 65123 and 65126.....
2206	3681	Roller Arm Bracket, for 2196 and 2197....
2210	22706	Shuttle (inside) Bobbin, for 16206.....
2210	22706	" (outside) Bobbin, for 16208 and 16209.....
2211	3689	Shuttle Bobbin Retaining Spring, for 6058.
2212	3689	" " Rivet, for 6058.....
2212	3689	Shuttle (inside) Bobbin Retaining Spring Rivet, for 3235.....
2212	3689	Shuttle (outside) Bobbin Retaining Spring Rivet, for 3232 and 3383.....
2273	22705	Needle Clamp Pin, for 16276 and 16277....
2410	22711	Thread Take-up Roller, for 18-25 Machine.
2411	22711	" Stud, for 18-25 Machine.....
2413	22711	Tension Thread Eyelet (double) for 18-25 Machine.....
2415	22701	Arm Spool Bracket, for 15063.....
2455	22711	Bobbin Winder Tension Disc, for 27308....
2764	3691	Rock Shaft Hanger (back) with two wood screws 1 in. No. 10, for 16129.....
2766	3691	Rock Shaft Knee Arm Hub with 356C, for 16647.....
2767	3691	Rock Shaft Knee Plate with 356C, for 16647
2770	3691	" " Stop Dog with 356C, for 16129.
3005	3698	Arm Shaft Bushing.....
3012	22711	Thread Take-up Cam Pin.....
3022	-----	Clamp Stop Motion complete, Nos. 248A, 256J, 2020 and 4933.....
*3023	-----	Clamp Stop Motion Flanged Bushing, for 4933.....
3032	22702	Feed Cam with 448C, for 16290.....
3037	3683	" Forked Connection, for 16177.....
*3045	22705	Needle Bar Connecting Link, for 16220....
3054	3683	Presser Bar, for 18-23 Machine.....
3074	22702	Feed Eccentric with 448C, for 16281.....
3214	22705	Needle Bar Guide with 400C and 453C, for 18-25 Machine.....
3230	22706	Shuttle (inside) Bobbin Retaining Spring, for 3235.....

NUMERICAL LIST OF PARTS

No.	Plate	Name
3230	22706	Shuttle (outside) Bobbin Retaining Spring for 3232 and 3383.....
*3232	-----	Shuttle (outside) Body with 398E, 2084, 3230, 3239 and two 2212, for 16209...
*3235	-----	Shuttle (inside) Body with 398E, 2084, 3230, 3240 and two 2212, for 16206...
3238	22706	Shuttle (outside) Delivery Eye Thread Guard, for 16208 and 16209.....
3239	22706	Shuttle (outside) Main Spring, for 3232 and 3383.....
3240	22706	Shuttle (inside) Main Spring, for 3235...
3241	22706	Shuttle (outside) Tension Spring, for 16208 and 16209.....
3242	22706	Shuttle (outside) Tension Spring Plate, for 16208 and 16209.....
3286	22702	Cloth Plate Slide Spring, for 6495 and 6717.....
*3383	-----	Shuttle (outside) Body with 398E, 2084, 3230, 3239 and two 2212, for 16208...
4282	3681	Roller Arm Bracket, for 16099, 16100, 16225, 16226, 16228, 16233, 16236, 16258, 65041, 65047, 65086, 65097, 65099 to 65101, 65123 and 65126.....
4288	22701	Arm Side Cover (back).....
4292	3683	Crank Connecting Rod with two 145E.....
4302	22705	Needle Bar Thread Guide, for 18-23 Machine
4303	22705	" Clamp with 808F, for 18-23 Machine
4783	22705	" " " two 336F, for 16276....
4784	22705	Oscillating Rock Shaft Oil Pad, for 6461 and 16112.....
4785	22707	Roller Arm Bracket, for 16014, 16082, 16234, 16237, 16260 and 16261.....
4822	22714	Wrench for 1528, 1547 and 1549 (Attachments and Accessories).....
4879	3692	Foot Lifter Chain Connecting Link, for 4885.....
4881	3691	Foot Lifter Treadle, for 4885.....
4882	3692	" " " Shaft, for 4885.....
4883	3692	" " " Spring, for 4885.....
4884	3691	" " " Stand, for 4885.....
4885	3691	Foot Lifter Treadle complete for 6698, Nos. 4879, 4881 to 4884 and two wood screws 1 in. No. 16.....
4933	3698	Clamp Stop Motion Flanged Bushing 3023 with two 462C, for 3022.....
5459	3683	Presser Bar Spring (light) .047" wire, for 18-23 Machine.....
6018	22704	Feed Rock Shaft Crank with 207F.....
6024	22705	Oscillating Shaft Crank with 1813 and two 462C, for 18-23 Machine.....

NUMERICAL LIST OF PARTS

No.	Plate	Name
6028	3689	Shuttle (high point) complete, for 18-23 Machine, Nos. 2073, 2076, 6058 and 44001.....
6055	22711	Machine Bolt Nut Washer (Attachments and Accessories).....
*6056	-----	Oscillating Shaft Crank with 460C and 1813, for 16184.....
*6058	-----	Shuttle Body with 398E, 2082, 2084, 2211 and two 2212, for 6028.....
6083	3699	Cloth Plate Bracket with two 345C, for 6494.....
6337	3691	Rock Shaft Lifting Bracket with two 356C, for 16129.....
6338	3691	Rock Shaft Lifting Bracket Hook, for 16129
6439	-----	Foot Lifter Chain, 36 in. to 45 in. with 56864 and 56865, for 6698.....
6458	22704	Feed Dog Carrier, for 16219.....
6459	22702	" Regulator, for 16241.....
*6461	22701	Oscillating Rock Shaft with 4784, for 16176.....
6464	3683	Presser Bar Lifter.....
6465	22706	" " " Washer.....
6466	-----	" " " Spring (medium) .055" wire, for 18-23 Machine.....
6467	-----	Presser Bar Spring (heavy) .063" wire, for 18-23 Machine.....
6469	3683	Presser Bar Lifting Bracket Guide.....
6472	22713	Shuttle Race Ring Latch, for 6500.....
*6474	3686	Thread Take-up Lever with 1819, for 16180.
6477	3686	" " " Spring Regulator Plate....
6487	22705	Needle Bar Connecting Stud with 155C, for 16220.....
6488	22703	Feed Rock Shaft, for 18-23 Machine.....
6489	3683	Oscillating Rock Shaft Hinge Pin, for 16212.....
6494	-----	Cloth Plate with Bracket complete, for 18-23 Machine, Nos. 6083, 6495 and two 389F.....
6495	3699	Cloth Plate complete for 6494, Nos. 3286, 6496, 6786 and two 725J.....
6496	3699	Cloth Plate Slide, for 6495.....
6497	22701	Feed Wheel, for 18-23 Machine.....
6498	22701	" " " Driver, for 18-23 Machine....
6499	22710	Shuttle Driver, for 16184.....
6500	22713	Shuttle Race Ring complete for 16245, Nos. 6472, 16046 and two 725J.....
6524	22705	Needle Clamp with two 50014F, for 3/32 in. to 1/4 in. gauges, for 16277.....
6535	22707	Roller Arm, for 16014 and 16082.....

No.	Plate	Name
6600	22711	Tension Releaser, for 18-25 Machine.....
6602	22711	Thread Take-up Spring Thread Guard and Thread Eyelet, for 18-25 Machine.....
6603	22711	Thread Take-up Spring, for 18-25 Machine.
6677	22704	Feed Dog, for 3/32 in. to 1/4 in. gauges, for 16153, for 18-25 Machine.....
6678	22703	Feed Rock Shaft, for 16219.....
6691	-----	Knee Lifter complete, Nos. 802D, 6692, 6703, 16129 and 16130.....
6692	3691	Lifting Lever, for 6691, 6698 and 16154..
6698	-----	Foot Lifter complete, Nos. 802D, 4885, 6439, 6692 and 16130.....
6702	-----	Cloth Plate with Bracket complete, for 18-25 Machine, Nos. 6717, 6719 and two 389F.....
6703	3691	Pitman, length 14-1/8 in., for 6691.....
*6704	22711	Thread Take-up Lever with 1819, for 16181
6709	22710	Shuttle Race Lock Pin, for 6746 and 16239
6716	3699	Cloth Plate, for 6717.....
6717	3699	Cloth Plate complete for 6702, Nos. 3286, 6716, 6718 and two 725J.....
6718	3699	Cloth Plate Slide, for 6717.....
6719	3699	" " Bracket with 345C, for 6702..
6746	-----	Shuttle Race complete, for 3/32 in. to 1/4 in. gauges, for 18-25 Machine, Nos. 6709, 6758, 16166 and two 102J..
6758	22713	Shuttle Race Lock Pin Spring, for 6746 and 16239.....
6768	3686	Thread Take-up Spring, for 18-23 Machine.
6786	3699	Cloth Plate, for 6495.....
7124	3691	Rock Shaft, for 16129.....
7393	3686	Tension Releaser Collar Pin, for 16240...
7556	22709	Roller Arm Lock Spring for 16014, 16017, 16071, 16082, 16234, 16235, 16237, 16260 and 16261.....
7898	3691	Pitman, length 19 in., for 16154.....
8879	3698	Arm Spool Pin Washer (cloth) for 18-23 Machine.....
8908	22714	Wrench for 1520 (Attachments and Accesso- ries).....
8909	22714	Wrench for 1513, 1518 and 51581 (Attach- ments and Accessories).....
10141	22712	Bobbin Winder Tension Spring, for 27308..
11170	22706	Presser Bar Spring Washer, for 18-25 Ma- chine.....
11241	3692	Arm Spool Bracket Spool Pin Washer(cloth) for 18-25 Machine.....
11241	3692	Bobbin Winder Spool Washer (cloth) for 27308.....

No.	Plate	Name
12424	22705	Oscillating Shaft Crank Slide Block Cap Screw Washer, for 19390.....
15063	22701	Arm Spool Bracket 2415 with two 52239, for 18-25 Machine.....
*15404	-----	Trade Mark, for 16274 and 16280.....
15405	-----	" " Rivet, for 16274 and 16280...
15444	-----	Roller Arm Screw Center 316F with 1547J, for 2196, 2197, 16014, 16017, 16071, 16082, 16099, 16100, 16225, 16226, 16228, 16233 to 16237, 16258, 16260, 16261, 65041, 65047, 65086, 65097, 65099 to 65101, 65123 and 65126.....
16010	22709	Roller Needle Guard (flat) for 16014.....
16013	22709	" " " (round) for 16014....
16014	22707	Roller Presser complete, 1-1/2 in. diam., 7/32 in. face, for 1/32 in. to 1/16 in. gauges, for 18-25 Machine, Nos. 171F, 176J, 207F, 440F, 1547J, 1549J, 1875, 4785, 6535, 7556, 16010, 16013 and two 15444.....
16015	22707	Roller Arm, for 16017 and 16071.....
16016	22709	" Needle Guard (round) for 16017, 16071 and 16235.....
16017	22707	Roller Presser complete, 1-1/2 in. diam., 7/32 in. face, for 3/32 in. to 1/4 in. gauges, for 18-25 Machine, Nos. 171F, 176J, 440F, 1547J, 1549J, 1875, 7556, 16015, 16016, 19200 and two 15444.....
16018	22704	Feed Dog, for 1/32 in. to 5/64 in. gauges for 16153, for 18-25 Machine.....
16022	3686	Tension Thread Guard, for 18-23 Machine..
16031	3693	Machine Base with four each 121E and wood screws 1-1/4 in. No. 12.....
16036	22701	Cylinder Side Cover.....
16045	22702	" Oil Tube, for oiling Oscillating Shaft.....
16046	22713	Shuttle Race Ring, for 6500.....
16055	22703	Oscillating Shaft, for 16184.....
16071	22707	Roller Presser complete, 1-1/2 in. diam., 3/16 in. face, for 3/32 in. to 1/4 in. gauges, for 18-25 Machine, Nos. 171F, 176J, 440F, 1547J, 1549J, 1958, 7556, 16015, 16016, 19200 and two 15444.....
16077	3693	Drip Pan.....
16080	-----	Roller Needle Guard (flat) for 16082, 16234, 16237, 16260 and 16261.....
16081	-----	Roller Needle Guard (round) for 16082, 16234, 16237, 16260 and 16261.....

NUMERICAL LIST OF PARTS

No.	Plate	Name
16082	22707	Roller Presser complete, 1-1/2 in. diam., 3/16 in. face, for 1/32 in. to 5/64 in. gauges, for 18-25 Machine, Nos. 171F, 176J, 207F, 440F, 1547J, 1549J, 1958, 4785, 6535, 7556, 16080, 16081 and two 15444.....
16098	3681	Roller Arm, for 16099, 16100, 16225, 16226 and 16228.....
16099	3681	Roller Presser complete, 1-1/4 in. diam., 9/64 in. face, coarse roller, for 18-23 Machine, Nos. 176J, 440F, 1547J, 1549J, 1839, 2205, 4282, 16098 and two 15444.....
16100	3682	Roller Presser complete, 1-1/4 in. diam., 9/64 in. face, fine roller, for 18-23 Machine, Nos. 176J, 440F, 1547J, 1549J, 1869, 2205, 4282, 16098 and two 15444.....
16101	22710	Shuttle Race Lock Pin Bushing, for 18-25 Machine.....
16102	22701	Arm Side Cover (front).....
16103	22713	Shuttle Race Cap, for 18-25 Machine.....
*16111	22701	Oscillating Rock Shaft, for 16112.....
16112	-----	Oscillating Rock Shaft complete for 18-25 Machine, Nos. 4784, 16111 and 16212..
16113	22703	Oscillating Shaft, for 16221.....
16115	-----	" Crank, for 16116.....
16116	22705	Oscillating Shaft Crank complete for 18-25 Machine, Nos. 1518J, 16115, 19390 and two 462C.....
16128	3691	Rock Shaft Hanger (front) with two wood screws 1 in. No. 10, for 16129.....
16129	3691	Rock Shaft complete for 6691 and 16154, Nos. 2764, 6337, 6338, 7124, 16128, 16647 and two 2770.....
16130	3691	Lifting Lever Spring for 6691, 6698 and 16154.....
16136	22713	Tension and Needle Bar Guide Bracket, for 16137.....
16137	-----	Tension and Needle Bar Guide Bracket complete for 18-25 Machine, Nos. 16136, two each 2103, 33929 and four 2102...
16138	22709	Roller Needle Guard (round) with 242J and 16139, for 16014.....
16139	22709	Roller Needle Guard (round) Edge Guide, for 16138.....
16145	22703	Presser Bar (hollow) for 18-25 Machine...
16147	-----	" Spring (heavy) .063" wire, for 18-25 Machine.....
16148	22706	Presser Bar Stop Collar with 1019C, for 18-25 Machine.....

NUMERICAL LIST OF PARTS

No.	Plate	Name
16149	22711	Tension Releaser Bracket with two 465C, for 18-25 Machine.....
16151	22704	Throat Plate Body, for 16153.....
16152	22704	" Needle Plate, for 16153.....
16153	22704	Throat Plate complete for 16018, for 1/32 in. to 5/64 in. gauges and for 6677, for 3/32 in. to 1/4 in. gauges, for 18-25 Machine, Nos. 228D, 16151 and 16152.....
16154	-----	Knee Lifter complete, for Machine on Base, Nos. 802D, 6692, 7898, 16129 and 16130.....
16156	22706	Presser Bar Spring (light) .055" wire, for 18-25 Machine.....
16166	-----	Shuttle Race Body (two pieces) with either 813D, 814D or 815D, for 6746..
16168	22702	Feed Wheel Driver Spring, for 18-23 Machine.....
16176	-----	Oscillating Rock Shaft complete, for 18-23 Machine, Nos. 6461 and 16212.....
16177	-----	Feed Forked Connection complete, Nos. 3037, 16241, 52165 and two each 375C and 1518J.....
16180	-----	Thread Take-up Lever 6474 with 76F, for 18-23 Machine.....
16181	-----	Thread Take-up Lever 6704 with 76F, for 18-25 Machine.....
*16184	-----	Oscillating Shaft 16055 with 2049, 6056 and 6499, for 18-23 Machine.....
*16192	-----	Oscillating Shaft Crank, for 16193.....
*16193	-----	Oscillating Shaft Crank complete for 16221, Nos. 462C, 1518J, 16192 and 19390.....
16194	3683	Presser Bar Lifting Bracket with 175J and two 457K, for 16195.....
16195	3683	Presser Bar Lifting Bracket 16194 with 16196 and two 335J, for 18-23 Machine
16196	3683	Presser Bar Lifting Bracket Wearing Plate for 16195 and 16198.....
16197	22706	Presser Bar Lifting Bracket with 175J and two 457K, for 16198.....
16198	-----	Presser Bar Lifting Bracket 16197 with 16196 and two 335J, for 18-25 Machine
16202	-----	Tension Screw Stud 600C with 1560C, for 16204.....
16204	-----	Tension complete for 18-23 Machine, Nos. 2103, 16202 and two 2102.....
*16205	-----	Shuttle (inside) Cover, for 16206.....

NUMERICAL LIST OF PARTS

No.	Plate	Name
16206	22706	Shuttle (inside) closed eye complete, for 1/32 in. to 1/4 in. gauges, for 18-25 Machine, Nos. 112E, 466H, 2076, 2078, 2080, 2086, 2090, 2210, 3235 and 16205
*16207	-----	Shuttle (outside) Cover, for 16208 and 16209.....
16208	22710	Shuttle (outside) closed eye complete, for 3/32 in. to 1/4 in. gauges, for 18-25 Machine, Nos. 112E, 466H, 2076, 2080, 2210, 3238, 3241, 3242, 3383 and 16207
16209	22710	Shuttle (outside) closed eye complete, for 1/32 in. to 5/64 in. gauges, for 18-25 Machine, Nos. 112E, 466H, 2076, 2080, 2210, 3232, 3238, 3241, 3242 and 16207
*16212	-----	Oscillating Rock Shaft Hinge Pin 6489 with 1513J, for 16112 and 16176.....
16213	22710	Shuttle Driver and Feed Lifting Cam, for 16221.....
16219	-----	Feed Rock Shaft 6678 with 6458, for 18-25 Machine.....
16220	-----	Needle Bar Connecting Link 3045 with 377C 1518J and 6487.....
*16221	-----	Oscillating Shaft 16113 with 2049, 16193 and 16213, for 18-25 Machine.....
16225	3682	Roller Presser complete, 1-1/4 in. diam., 3/16 in. face, coarse roller, for 18-23 Machine, Nos. 176J, 440F, 1547J 1549J, 1897, 2205, 4282, 16098 and two 15444.....
16226	3682	Roller Presser complete, 1-1/4 in. diam., 3/16 in. face, fine roller, for 18-23 Machine, Nos. 176J, 440F, 1547J, 1549J 1898, 2205, 4282, 16098 and two 15444
16228	3681	Roller Presser complete, 1-1/4 in. diam., 1/8 in. face, coarse roller, for 18-23 Machine, Nos. 176J, 440F, 1547J, 1549J 1923, 2205, 4282, 16098 and two 15444
16230	3682	Roller Arm, for 16233, 16236, 65041, 65047 and 65086.....
16231	22708	Roller Arm, for 16234, 16235 and 16237...
16232	3689	" Ball, size 3/32 in. for 51832, 51834, 51841, 51849, 51851, 51855, 51860, 51892, 51904 to 51906, 51911, 51913, 51915, 51921 and 51922.....
16233	3695	Roller Presser (ball bearing) complete, 1-1/4 in. diam., 7/32 in. face, coarse roller, for 18-23 Machine, Nos. 176J, 440F, 1547J, 1549J, 2205, 4282, 16230 51832 and two 15444.....

NUMERICAL LIST OF PARTS

No.	Plate	Name
16234	22706	Roller Presser (ball bearing) complete, 1-1/2 in. diam., 3/16 in. face, for 1/32 in. to 5/64 in. gauges, for 18-25 Machine, Nos. 171F, 176J, 207F, 440F, 1547J, 1549J, 4785, 7556, 16080, 16081 16231, 51834 and two 15444.....
16235	22706	Roller Presser (ball bearing) complete, 1-1/2 in. diam., 3/16 in. face, for 3/32 in. to 1/4 in. gauges, for 18-25 Machine, Nos. 171F, 176J, 440F, 1547J 1549J, 7556, 16016, 16231, 19200, 51834 and two 15444.....
16236	3682	Roller Presser (ball bearing) complete, 1-1/4 in. diam., 5/32 in. face, coarse roller, for 18-23 Machine, Nos. 176J, 440F, 1547J, 1549J, 2205, 4282, 16230 51841 and two 15444.....
16237	22708	Roller Presser (ball bearing) complete, 1-1/2 in. diam., 3/16 in. face, for 1/32 in. to 5/64 in. gauges, for 18-25 Machine, Nos. 171F, 176J, 207F, 440F, 1547J, 1549J, 4785, 7556, 16080, 16081 16231, 51855 and two 15444.....
16238	22713	Shuttle Race Body (two pieces) with either 813D, 814D or 815D, for 16239.
16239	22713	Shuttle Race complete, for 1/32 in. to 5/64 in. gauges, for 18-25 Machine, Nos. 6709, 6758, 16238 and two 102J..
16240	3686	Tension Releaser Collar with 7393 and two 1253C, for 18-23 Machine.....
16241	-----	Feed Regulator 6459 with 818D, for 16177.
16243	22713	Throat Ring, for 16244.....
16244	22713	" " 16243 with 665J and 16262, for 16245.....
16245	-----	Throat Ring complete for 18-23 Machine, Nos. 6500, 16244 and two 50008J.....
16246	22704	Feed Wheel Friction Spring, for 18-23 Machine.....
16247	3691	Arm Side Cover (front) for 16248.....
16248	3691	Arm Side Cover (front) with Thread Lubricator complete, for 18-23 Machine, Nos. 16247 and 62829.....
16249	22712	Thread Lubricator Bracket Extension, for 16254.....
16251	-----	Thread Lubricator Oil Pad Holder complete for 18-25 Machine.....
16253	-----	Thread Lubricator complete, for 16254....
16254	22713	" " 16253 with 1529E, 16249 50152J and two 21202.....

NUMERICAL LIST OF PARTS

No.	Plate	Name
16258	3697	Roller Presser (ball bearing) complete, 1-1/4 in. diam., 7/32 in. face, grooved coarse, with ratchet brake, for 18-23 Machine, Nos. 176J, 230F, 440F, 1547J, 1549J, 2205, 4282, 51904 62854, 65095 and two 15444.....
16259	22708	Roller Arm, for 16260 and 16261.....
16260	22708	Roller Presser (ball bearing) complete, 1-1/2 in. diam., 1/4 in. face, with ratchet brake, for 1/32 in. to 5/64 in. gauges, for 18-25 Machines, Nos. 171F, 176J, 207F, 230F, 440F, 1547J, 1549J, 4785, 7556, 16080, 16081, 16259 51905, 62854 and two 15444.....
16261	22709	Roller Presser (ball bearing) complete, 1-1/2 in. diam., 3/16 in. face, with ratchet brake, for 1/32 in. to 5/64 in. gauges, for 18-25 Machines, Nos. 171F, 176J, 207F, 230F, 440F, 1547J, 1549J, 4785, 7556, 16080, 16081, 16259 51911, 62854 and two 15444.....
16262	22711	Throat Ring Needle Plate, for 16244.....
16264	3699	Arm Shaft, for 16281 and 16290.....
16266	3698	" Counterbalance with 443C, for 16281 and 16290.....
16267	3699	Balance Wheel (disc) for Power Table, 2-3/4 in. pulley, with two 448C.....
16268	3683	Needle Bar (hollow) for 18-23 Machine....
*16269	-----	Thread Take-up Cam, for 16270, 16281 and 16290.....
16270	3692	Thread Take-up Cam 16269 with 446C.....
16271	3692	Bobbin Winder Base, for 16272.....
16272	-----	" " for 16273, Nos. 35D, 1620J, 16271, 27305, 27321, 27322, 27326, 27541, 50356D and two wood screws 1 in. No. 7 F.H.....
16273	-----	Bobbin Winder (swinging automatic, left hand) complete, Nos. 16272 and 27308.....
*16274	-----	Arm and Cylinder with 15404 and two 15405 for 18-25 Machine.....
16275	22703	Needle Bar (hollow) for 16276 and 16277..
16276	-----	" " 16275 with 2273 and 4783, for 1/32 in. to 5/64 in. gauges, for 18-25 Machine.....
16277	-----	Needle Bar 16275 with 2273 and 6524, for 3/32 in. to 1/4 in. gauges, for 18-25 Machine.....
16278	3699	Balance Wheel (disc) for Stand, 3 in. pulley, for Clamp Stop Motion.....

NUMERICAL LIST OF PARTS

No.	Plate	Name
16279	3686	Tension Releaser, for 18-23 Machine.....
*16280	-----	Arm and Cylinder with 15404 and two 15405 for 18-23 Machine.....
*16281	-----	Arm Shaft 16264 with 3074, 16266 and 16289 for 18-23 Machine.....
*16290	-----	Arm Shaft 16264 with 3032, 16266 and 16289 for 18-25 Machine.....
16646	3691	Rock Shaft Knee Arm, for 16647.....
16647	-----	Rock Shaft Knee Arm complete, for 16129, Nos. 2766, 2767 and 16646.....
19200	22707	Roller Arm Bracket, for 16017, 16071 and 16235.....
19389	22705	Oscillating Shaft Crank Slide Block, for 19390.....
19390	-----	Oscillating Shaft Crank Slide Block complete for 16116 and 16193, Nos. 226J, 969C, 12424 and 19389.....
21202	22712	Thread Lubricator Bracket Screw Friction Washer, for 16254.....
21202	22712	Thread Lubricator Screw Friction Washer, for 62829.....
26026	22714	Screw Driver (machine) Attachments and Accessories.....
26485	22714	Screw Driver (shuttle tension) Attachments and Accessories.....
27305	3692	Bobbin Winder Spindle, for 16272.....
27306	3692	" " Spool Pin, for 27308.....
27307	3692	" " Stand, for 27308....
27308	3692	Bobbin Winder Spool Stand complete for 16273, Nos. 418E, 1562J, 2106, 10141, 11241, 27306, 27307 and two each 2455 and wood screws 1 in. No. 10.....
27321	3692	Bobbin Winder Frame, for 16272.....
27322	22712	" " Spring, for 16272...
27326	22712	" " Stop Latch, for 16272.....
27541	3692	" " Pulley, for 16272.....
33929	-----	Tension Screw Stud 637C with 1560C, for 16137.....
*44001	-----	Shuttle Cover 2075 with 112E, 466H, 2078, 2080, 2086 and 2090, for 6028.....
50008J	22710	Shuttle Race Ring Screw, for 16245.....
50014F	22705	Needle Set Screw, for 6524.....
50116K	3686	Tension Releaser Screw, for 18-23 Machine
50152J	22712	Thread Lubricator Screw, for 16254.....
50222J	22712	" " Bracket Screw, for 18-25 Machine.....
50222J	22712	Thread Lubricator Screw, for 62829.....
50356D	3686	Bobbin Winder Frame Hinge Screw, for 16272

NUMERICAL LIST OF PARTS

No.	Plate	Name
50553C	3689	Roller Screw, for 51832, 51834, 51841, 51849, 51851, 51855, 51860, 51892, 51904 to 51906, 51911, 51913, 51915, 51921 and 51922.....
51072E	22712	Machine Bolt with 51581E, to secure machine to table (Attachments and Accessories).....
51224W	3698	Arm Side Cover (back) Thumb Screw.....
51224W	3698	Cylinder Side Cover Thumb Screw.....
51581E	22712	Machine Bolt Nut, for 51072.....
51832	3695	Roller, 1-1/4 in. diam., 7/32 in. face, coarse (ball bearing) complete for 16233, Nos. 1528J, 1766C, 50553C and twenty-four 16232.....
51834	22708	Roller, 1-1/2 in. diam., 3/16 in. face, coarse (ball bearing) complete for 16234 and 16235, Nos. 1528J, 1766C, 50553C and twenty-four 16232.....
51841	3682	Roller, 1-1/4 in. diam., 5/32 in. face, coarse (ball bearing) complete for 16236, Nos. 1528J, 1766C, 50553C and twenty-four 16232.....
51849	3695	Roller, 1-1/4 in. diam., 3/16 in. face, coarse (ball bearing) complete for 65086, Nos. 1528J, 1766C, 50553C and twenty-four 16232.....
51851	3695	Roller, 1-1/4 in. diam., 3/16 in. face, fine (ball bearing) complete for 65047, Nos. 1528J, 1766C, 50553C and twenty-four 16232.....
51855	22708	Roller, 1-1/2 in. diam., 3/16 in. face, coarse (ball bearing) complete for 16237, Nos. 1528J, 1766C, 50553C and twenty-four 16232.....
51860	3695	Roller, 1-1/4 in. diam., 7/32 in. face, coarse (ball bearing) complete for 65041, Nos. 1528J, 1766C, 50553C and twenty-four 16232.....
51892	3696	Roller, 1-1/4 in. diam., 1/8 in. face, coarse (ball bearing) with ratchet brake complete, for 65099, Nos. 1528J, 1766C, 50553C and twenty-four 16232..
51904	3697	Roller, 1-1/4 in. diam., 7/32 in. face, grooved coarse (ball bearing) with ratchet brake, complete for 16259, Nos. 1528J, 1766C, 50553C and twenty-four 16232.....

NUMERICAL LIST OF PARTS

No.	Plate	Name
51905	22708	Roller, 1-1/2 in. diam., 1/4 in. face, medium (ball bearing) with ratchet brake, complete for 16260, Nos. 1528J, 1766C, 50553C and twenty-four 16232..
51906	3696	Roller, 1-1/4 in. diam., 9/64 in. face, fine (ball bearing) with ratchet brake, complete for 65100, Nos. 1528J, 1766C, 50553C and twenty-four 16232..
51911	22709	Roller, 1-1/2 in. diam., 3/16 in. face, medium (ball bearing) with ratchet brake, complete for 16261, Nos. 1528J, 1766C, 50553C and twenty-four 16232..
51913	3697	Roller, 1-1/4 in. diam., 7/32 in. face, fine (ball bearing) with ratchet brake, complete for 65097, Nos. 1528J, 1766C, 50553C and twenty-four 16232..
51915	3696	Roller, 1-1/4 in. diam., 7/32 in. face, coarse (ball bearing) with ratchet brake, complete for 65101, Nos. 1528J, 1766C, 50553C and twenty-four 16232..
51921	3697	Roller, 1-1/4 in. diam., 7/32 in. face, medium (ball bearing) with ratchet brake, complete for 65123, Nos. 1528J, 1766C, 50553C and twenty-four 16232..
51922	3696	Roller, 1-1/4 in. diam., 3/16 in. face, fine (ball bearing) with ratchet brake, complete for 65126, Nos. 1528J, 1766C, 50553C and twenty-four 16232..
52185	22702	Feed Connecting Link, for 16177.....
52239	3698	Arm Spool Bracket Spool Pin and Thread Eyelet, for 15063.....
52239	3698	Arm Spool Pin and Thread Eyelet, for 18-23 Machine.....
56864	3692	Foot Lifter Chain Hook (large) for 6439..
56865	3692	" " " (small) for 6439..
62819	22712	Thread Lubricator Oil Pad (felt) for 18-23 Machine.....
62822	-----	Thread Lubricator Oil Pad Holder complete for 18-23 Machine.....
62824	22712	Thread Lubricator Oil Pad Retainer, for 18-23 Machine.....
62827	-----	Thread Lubricator Oil Wick (braided cotton).....
62828	-----	Thread Lubricator complete for 62829.....
62829	3691	" " 62828 with 1529E, 50222J and two 21202, for 16248.....
62851	3689	Roller Ratchet Spring Stop Bracket for 62854.....
62853	3689	Roller Ratchet Spring Stop, for 62854....

NUMERICAL LIST OF PARTS

No.	Plate	Name
62854	-----	Roller Ratchet Spring Stop Bracket 62851 with 665J and 62853, for 16258, 16260 16261, 65097, 65099 to 65101, 65123 and 65126.....
65041	3695	Roller Presser (ball bearing) complete, 1-1/4 in. diam., 5/32 in. face, coarse roller, for 18-23 Machine, Nos. 176J, 440F, 1547J, 1549J, 2205, 4282, 16230, 51860 and two 15444.....
65047	3695	Roller Presser (ball bearing) complete, 1-1/4 in. diam., 3/16 in. face, fine roller, for 18-23 Machine, Nos. 176J, 440F, 1547J, 1549J, 2205, 4282, 16230, 51851 and two 15444.....
65086	3695	Roller Presser (ball bearing) complete, 1-1/4 in. diam., 3/16 in. face, fine roller, for 18-23 Machine, Nos. 176J, 440F, 1547J, 1549J, 2205, 4282, 16230, 51849 and two 15444.....
65095	3696	Roller Arm, for 16258, 65097, 65099, 65100 65101 and 65123.....
65097	3697	Roller Presser (ball bearing) complete, 1-1/4 in. diam., 7/32 in. face, fine roller with ratchet brake, for 18-23 Machine, Nos. 176J, 230F, 440F, 1547J 1549J, 2205, 4282, 51913, 62854, 65095 and two 15444.....
65099	3696	Roller Presser (ball bearing) complete, 1-1/4 in. diam., 1/8 in. face, coarse roller with ratchet brake, for 18-23 Machine, Nos. 176J, 230F, 440F, 1547J 1549J, 2205, 4282, 51892, 62854, 65095 and two 15444.....
65100	3696	Roller Presser (ball bearing) complete, 1-1/4 in. diam., 9/64 in. face, fine roller with ratchet brake, for 18-23 Machine, Nos. 176J, 230F, 440F, 1547J 1549J, 2205, 4282, 51906, 62854, 65095 and two 15444.....
65101	3696	Roller Presser (ball bearing) complete, 1-1/4 in. diam., 7/32 in. face, coarse roller with ratchet brake, for 18-23 Machine, Nos. 176J, 230F, 440F, 1547J 1549J, 2205, 4282, 51915, 62854, 65095 and two 15444.....
65123	3697	Roller Presser (ball bearing) complete, 1-1/4 in. diam., 7/32 in. face, medium roller with ratchet brake, for 18-23 Machine, Nos. 176J, 230F, 440F, 1547J 1549J, 2205, 4282, 51921, 62854, 65095 and two 15444.....

NUMERICAL LIST OF PARTS

No.	Plate	Name
65125	3696	Roller Arm, for 65126.....
65126	3696	Roller Presser (ball bearing) complete, 1-1/4 in. diam., 3/16 in. face, fine roller with ratchet brake, for 18-23 Machine, Nos. 176J, 230F, 440F, 1547J 1549J, 2205, 4282, 51922, 62854, 65125 and two 15444.....
120342	22714	Oiler (copper plated) with 120343 (Attachments and Accessories).....
120343	22714	Oiler Spout, 3-1/2 in. long, for 120342..
241755	22712	Thread Lubricator Oil Pad (felt) for 18-25 Machine.....
241757	22712	Thread Lubricator Oil Pad Retainer, for 18-25 Machine.....

Genuine Singer Needles should be used
in Singer Machines.
These Needles and their Containers
are marked with the
Company's Trade Mark "SIMANCO." 1

Needles in Containers marked
"For Singer Machines"
are not Singer made needles. 2

PLATE 3681—FULL SIZE

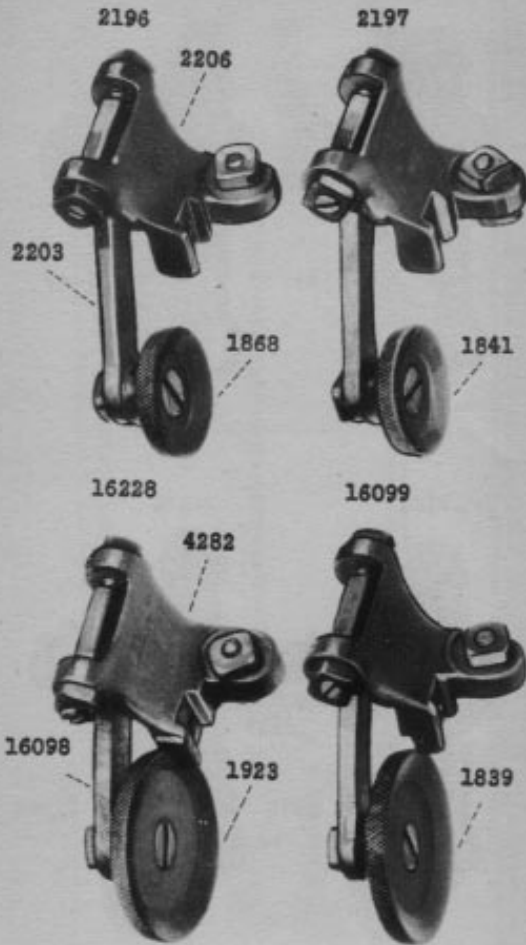
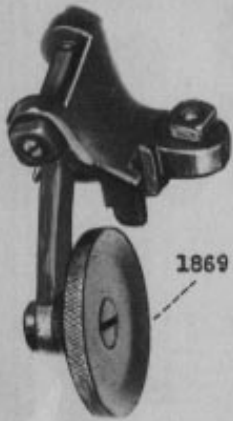

PLATE 3682—FULL SIZE

16100



16225



1869

1897

16226



16236



16230

1898

51841

PLATE 3683—ONE-HALF SIZE

4292



3037



3054



16268



6489



5459



6464



16195



16194

6469



262



16196



PLATE 3686—FULL SIZE

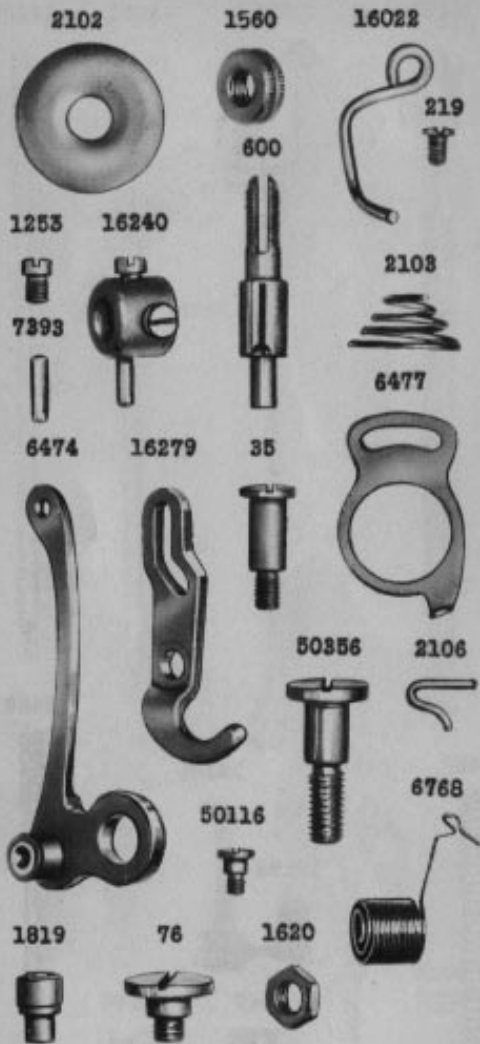

PLATE 3689—FULL SIZE

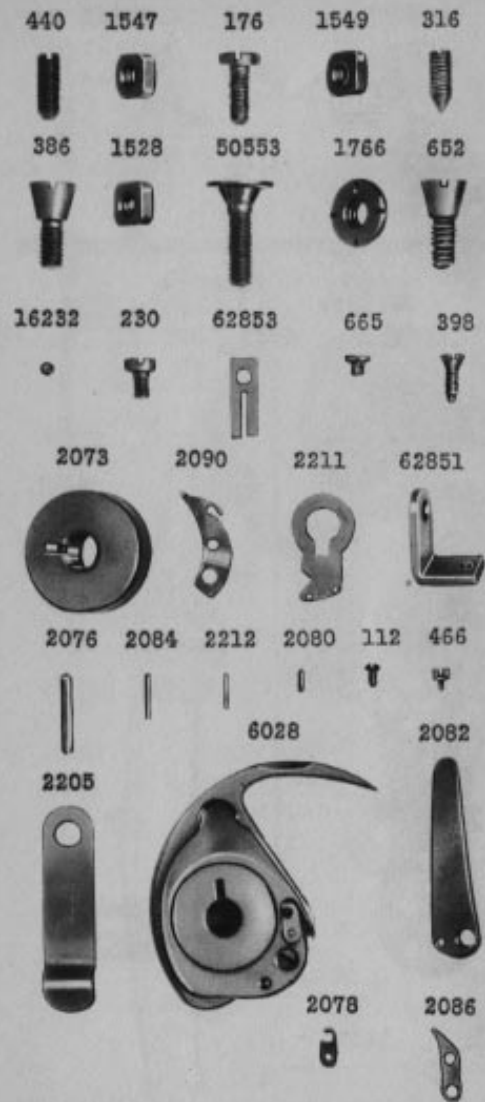

PLATE 3691—ONE-FOURTH SIZE

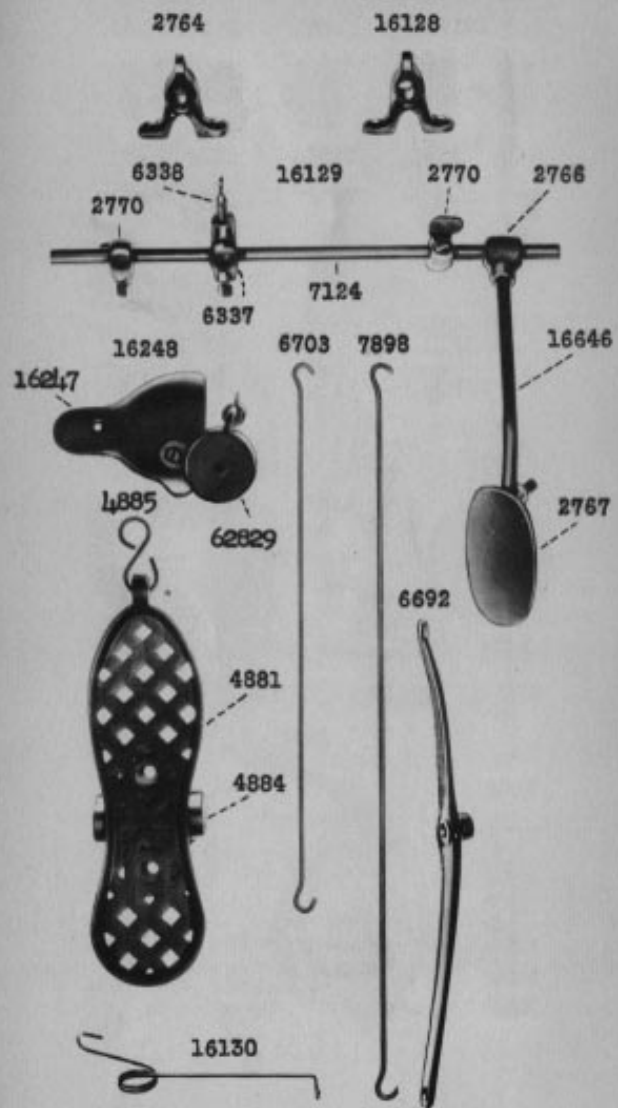

PLATE 3692—ONE-HALF SIZE

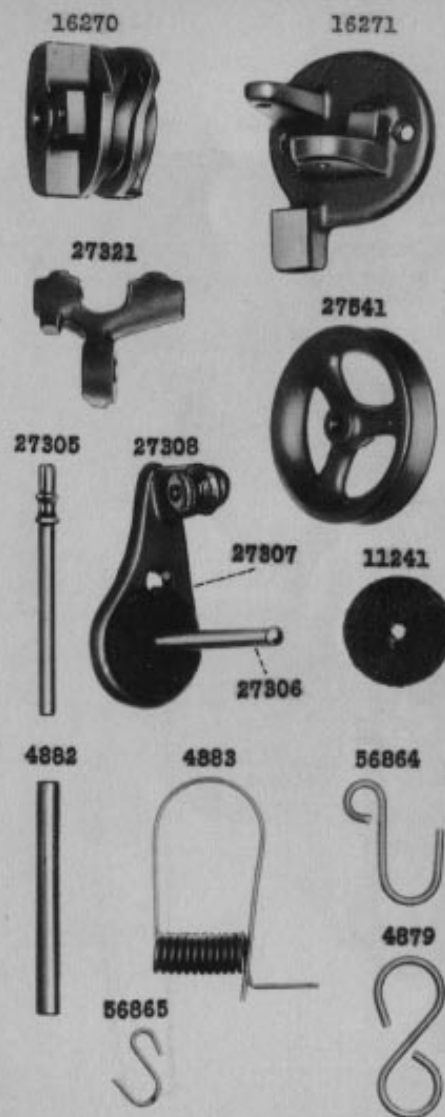
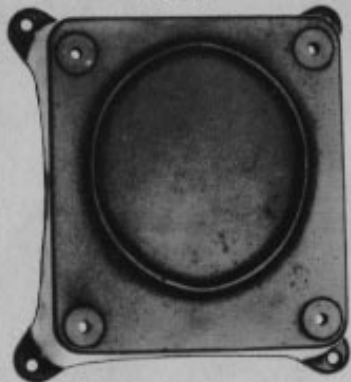

PLATE 3693—ONE-FOURTH SIZE

16031



16077



PLATE 3695—FULL SIZE

65086



65047



65041



16233



PLATE 3696—FULL SIZE

65099



65100



51892

51906

65126



65101



51922

51915

PLATE 3697—FULL SIZE

65123



65097



51921

51913

16258



51904

PLATE 3698 - FULL SIZE

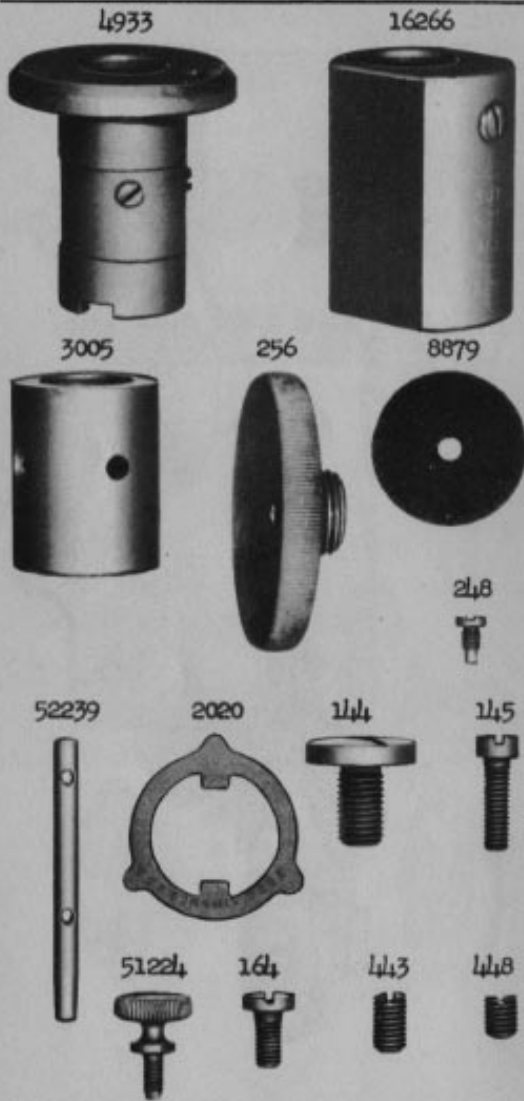

PLATE 3699 - ONE-FOURTH SIZE

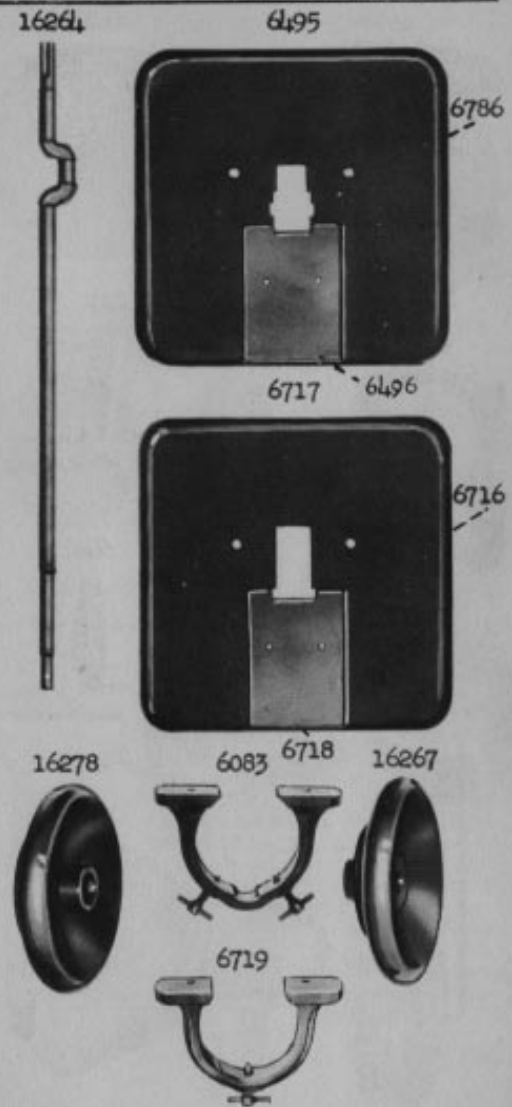
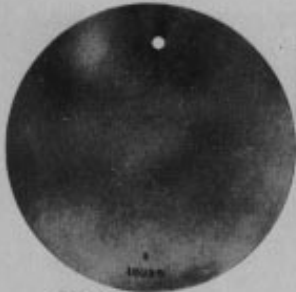
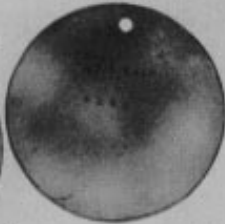

PLATE 22701 - ONE-HALF SIZE

16036



4288



15063



16111

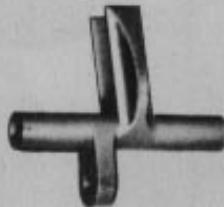

2415

6461

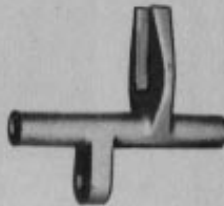

6498



16102

6497

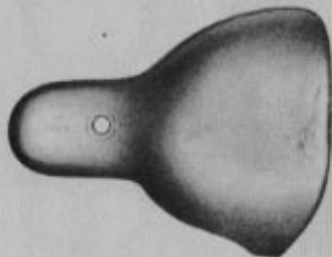

PLATE 22702 - FULL SIZE

3032



3074



3286

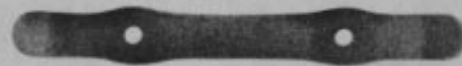

16045



6459

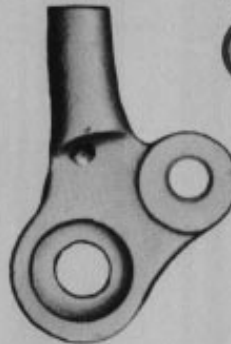

16168



818



1518



52165



345



375



2022



446



389



725



462



PLATE 22703 - ONE-HALF SIZE

6678 16275 6488 16145 16113 16055

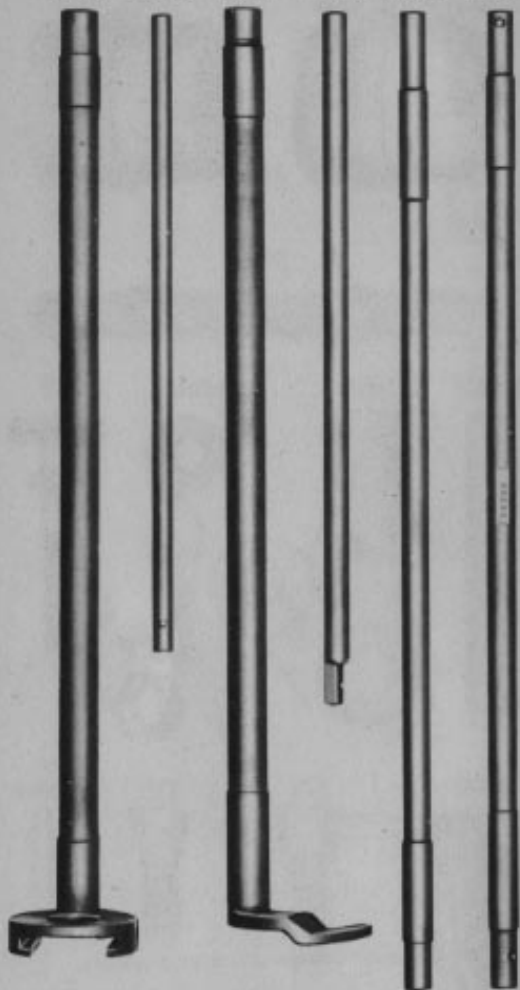

PLATE 22704 - FULL SIZE

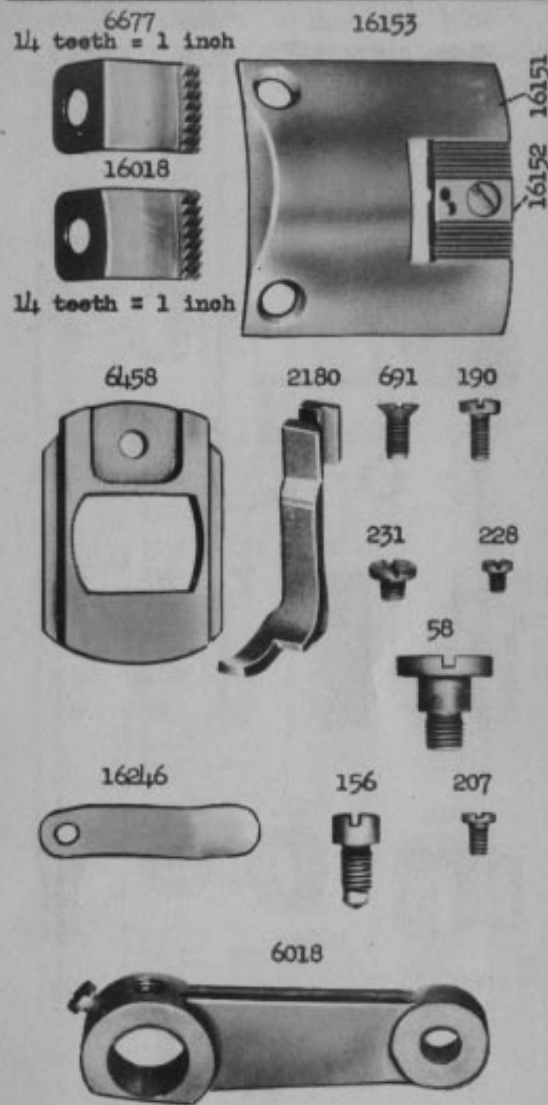

PLATE 22705 - FULL SIZE

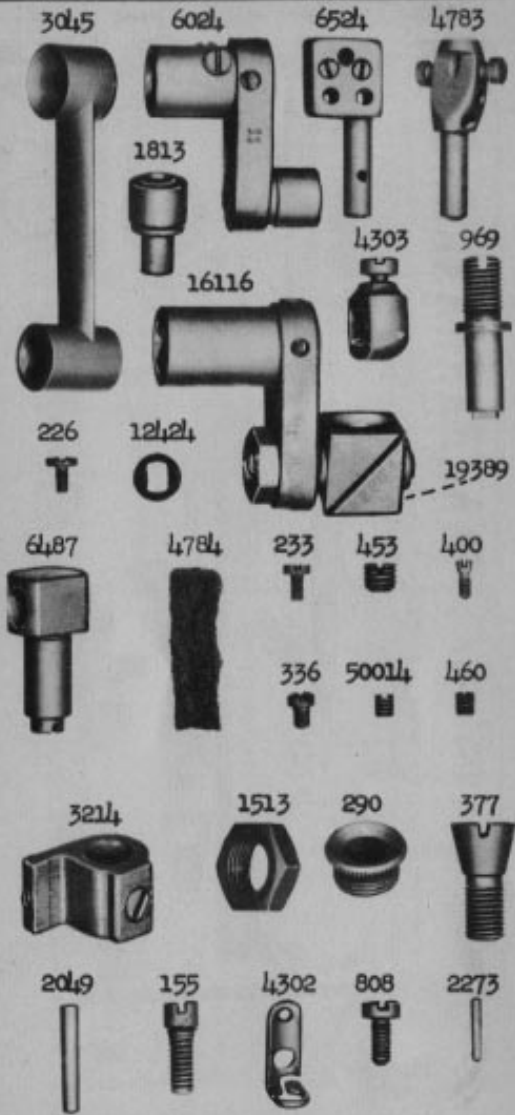

PLATE 22706 - FULL SIZE

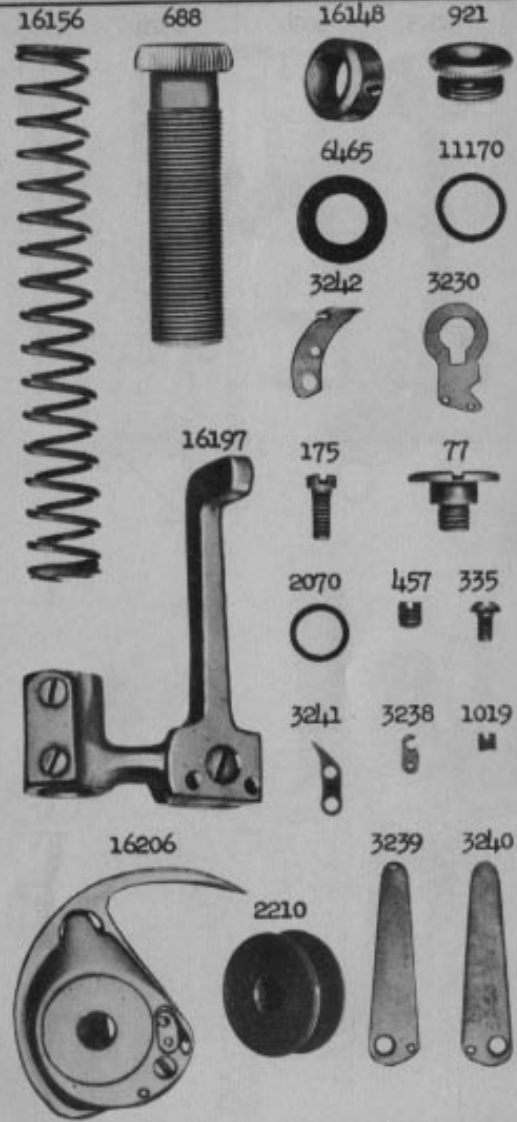
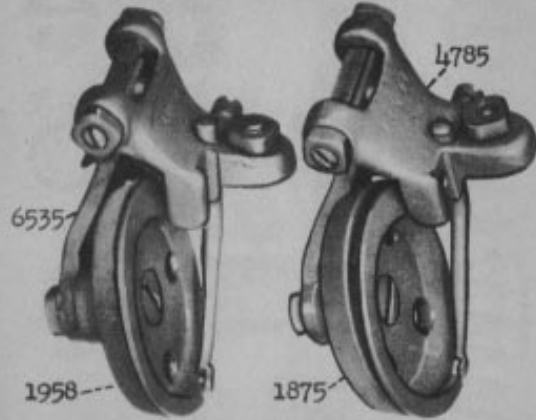

PLATE 22707 - FULL SIZE

16082

16014



16071

16017

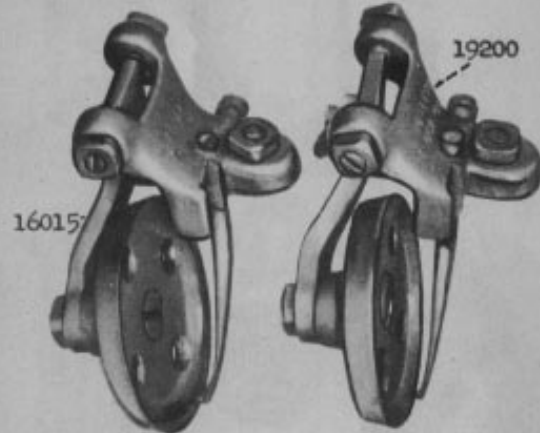
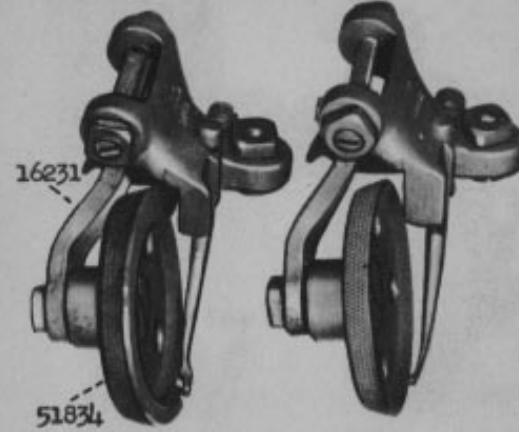

PLATE 22708 - FULL SIZE

16234

16235



16237

16260

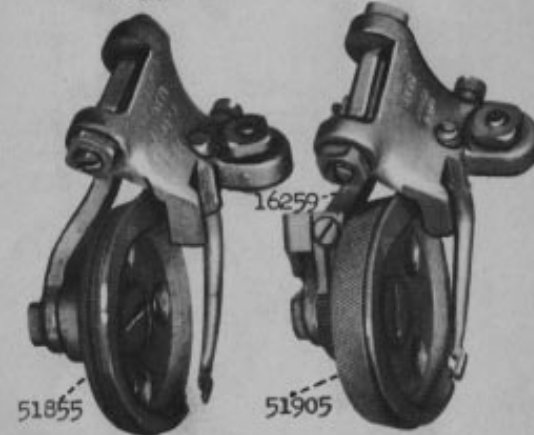

PLATE 22709 - FULL SIZE

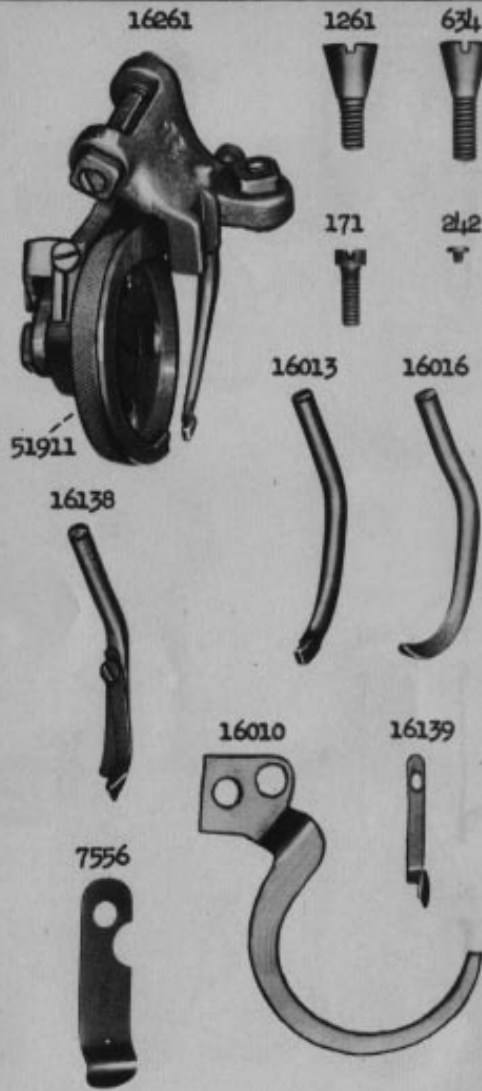

PLATE 22710 - FULL SIZE

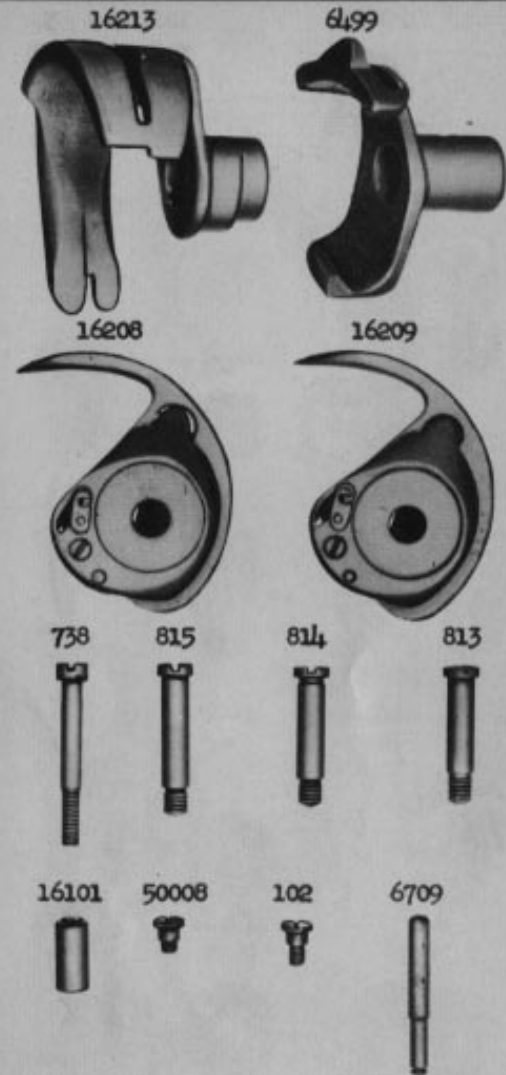

PLATE 22711 - FULL SIZE



PLATE 22712 - FULL SIZE

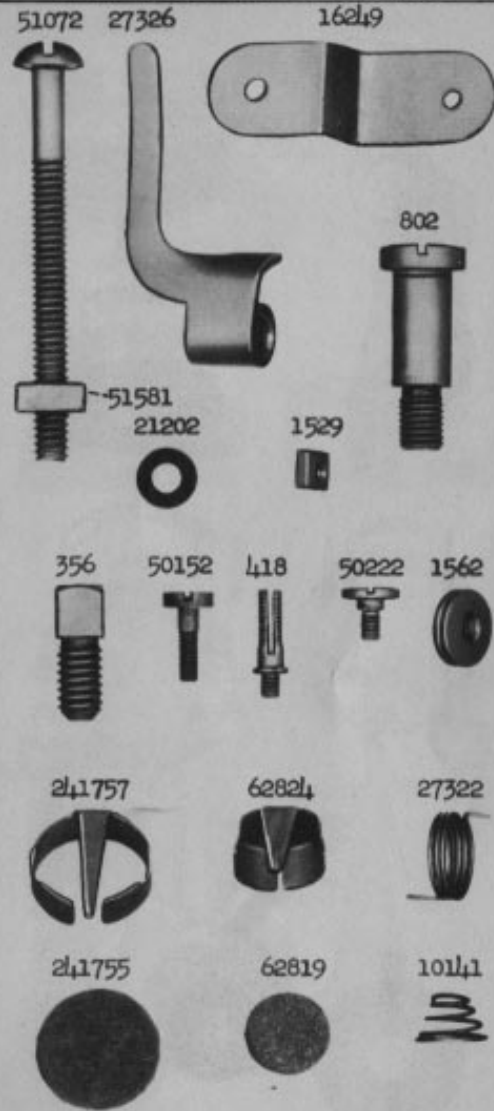

PLATE 22713 - ONE-HALF SIZE

16136



16239



16238

6758



16103



6472



6500

16244



16243

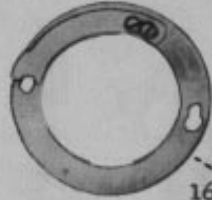

16046

16254



PLATE 22714 - ONE-HALF SIZE

120342



120343

26026



8909



8908



26485



4822

