

Form 20926
(957)
Printed in U.S.A.

HISTORICAL COPY

DO NOT REMOVE

LIST
OF
PARTS
FOR FAMILY SHOPS



SINGER^{**}

MACHINE No. 99-31

THE SINGER MANUFACTURING COMPANY

PROPERTY OF
THE SINGER MANUFACTURING COMPANY

This is a private and confidential communication to and for the use of only the employees of The Singer Manufacturing Company and its affiliated companies. Reproduction, sale, distribution, or publication thereof to the public is forbidden.

INDEX

	Page
Attachment Set.....	13
Bobbin Winder	14
Bias Gauge	14
Binder	14
Braider.....	15
Controller	18
Feed Cover Plate	15
Finger Guard	15
Hemmer (Feet)	15
Hemmer (adjustable).....	15
Hemstitcher	15
Machine No. 99-31	7
Motor Parts.....	17
Numerical List of Parts.....	21
Presser Feet	16
Quilter.....	16
Ruffler.....	16
Ruffler Shirring Plate.....	16
Special Attachments	13
Stiletto.....	17
Spotlight.....	18
Under Braider	17

INSTRUCTIONS FOR ORDERING

In ordering from this list, use ONLY the part NUMBER in the FIRST column.

The number stamped on a Sewing Machine Part is in every case the number of the single part only.

Every combination of parts sent out as such has its specific number, which, although not stamped on the parts, must be used when ordering the combination.

Each number always indicates the SAME PART in whatever list it appears, or for whatever machine.

The letters after some of the numbers indicate the style of finish only, as follows:

- A—Hardened, Polished, Nickel Plated and Buffed
- B—Polished, Nickel Plated and Buffed
- C—Hardened Only
- D—Polished Only
- E—Soft, Not Polished
- F—Hardened and Polished
- G—Bright Rumbled and Nickel Plated
- H—Blued
- J—Nickel Plated Only
- K—Hardened and Nickel Plated
- L—Brass Plated
- M—Oxidized
- R—Phosphate Coating Formed on Surface of Iron or Steel
- S—Chromium Plated
- T—Copper Plated
- U—Zinc Plated
- V—Silver Plated
- W—Polished and Nickel Plated
- X—Black Oxide for Iron and Steel
- Y—Black Nickel Plated Only
- Z—Chromium Plated
- A.A—Buffed and Chromium Plated
- A.B—Hardened, Polished, Buffed and Chromium Plated
- A.E—Hardened, Bright Rumbled and Nickel Plated
- A.F—Hardened, Bright Rumbled, Nickel Plated, Bright Rumbled and Chromium Plated
- A.G—Alumilite (Plain)
- A.H—Alumilite (Dyed) Color Must be Stated
- A.J—Polished, Nickel Plated and Chromium Plated
- A.K—Hardened, Polished, Nickel Plated and Chromium Plated
- A.L—Heat Treated for Toughness
- A.L.D—Heat Treated for Toughness and Polished
- A.L.X—Heat Treated for Toughness and Black Oxide

INSTRUCTIONS FOR ORDERING

- A.S—Black Moulded Phenolic
- A.T—Beige Moulded Phenolic
- A.U—Brown Moulded Phenolic
- A.W—Hardened then Flame Coated with Tungsten Carbide
- B.A—Chrome Nickel Satin Finish
- B.B—Hardened and Chrome Nickel, Satin Finished
- C.R—Hardened and Phosphate Coating Formed on Surface of Steel
- F.J—Hardened, Polished and Nickel Plated
- T.A—Hardened, Polished, Copper and Nickel Plated and Buffed
- T.B—Copper and Nickel Plated and Polished
- T.J—Copper and Nickel Plated Only
- T.K—Hardened, Copper and Nickel Plated
- T.L—Copper and Brass Plated
- T.M—Copper Plated and Oxidized
- X.C—Hardened and Black Oxide for Iron and Steel
- Z.A—Hardened, Polished Nickel Plated, Buffed and Chromium Plated
- Z.B—Polished, Nickel Plated, Buffed and Chromium Plated
- Z.C—Hardened and Chromium Plated
- Z.D—Polished and Chromium Plated
- Z.G—Bright Rumbled, Nickel Plated, Bright Rumbled and Chromium Plated
- Z.J—Nickel and Chromium Plated
- Z.T—Copper and Chromium Plated

These letters MUST BE USED when they appear in the list; and AFTER the number as in the list.

In this series:

1 to 1500, 50001 to 51500 and 140001 to 142,000 are screw numbers
1501 to 1800 and 51500 to 51800 are nut numbers
1801 to 2000 and 51801 to 52000 are roller numbers
2001 to 50000 and 52001 to 140000 and 142001 to 190000 are Sewing Machine Parts, 190001 and upward are numbers of Electrical Parts.

The figures in the second column refer only to the plates, illustrating the parts, and are NOT TO BE USED in ordering.

Parts marked with an asterisk (*) are furnished only when repairs are made at the factory.

LIST OF PARTS COMPLETE
FOR

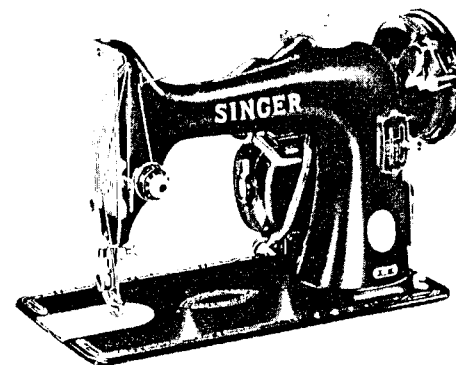

MACHINE NO. 99-31

No.	Plate	Name
*33692	-----	Arm with 448ZA and four 140543L
2002	26202	Arm Dowel Pin (2).....
33602R	26200	Arm Rock Shaft with 140519E
33661	-----	Arm Rock Shaft 33602R with 1216C and 1520R.
140519E	26200	Arm Rock Shaft Adjusting Screw
50046C	26200	Arm Rock Shaft Screw Center (lower).....
33666	-----	Arm Rock Shaft Screw Center (lower) 50046C with 1512R
1512R	26200	Arm Rock Shaft Screw Center (lower) Nut
50047C	26200	Arm Rock Shaft Screw Center (upper).....
138E	26202	Arm Screw (3)
33603	26200	Arm Shaft
33662	-----	Arm Shaft 33603 with 32503 and 33615
32503	26200	Arm Shaft Bushing.....
448ZA	26200	Arm Shaft Bushing Set Screw
2007ZG	26205	Arm Spool Pin.....
8879	26205	Arm Spool Pin Washer (cloth).....
		NOTE: When ordering No. 8879, color required must be stated.
*33681P	-----	Bed
256ZB	26200	Clamp Stop Motion Clamp Screw
248ZA	26200	Clamp Stop Motion Clamp Stop Screw.....
171502	26200	Clamp Stop Motion Clamp Washer
32618	26200	Clamp Stop Motion Flanged Bushing.....

No.	Plate	Name
1148AL	26200	Clamp Stop Motion Flanged Bushing Set Screw
33663ZB	26201	Face Plate
33654ZB	26201	Face Plate 33663ZB with 125423ZB
203ZB	26201	Face Plate Screw
50684ZB	26201	Face Plate Thumb Screw.....
125422ZG	-----	Face Plate Thread Guard
125423ZG	26201	Face Plate Thread Guard 125422ZG with 125424ZG.....
125424ZG	-----	Face Plate Thread Guard Rivet.....
32507R	26202	Feed Bar with 1944
1944	26202	Feed Bar Roller and Stud
315C	26202	Feed Bar Screw Center (2)
15455	-----	Feed Bar Screw Center 315C with 1519R (2).
1519R	26202	Feed Bar Screw Center Nut (2)
32600	26201	Feed Dog
191C	26201	Feed Dog Screw
33609R	26200	Feed Forked Connection
33664	-----	Feed Forked Connection 33609R with 1832..
1381C	26200	Feed Forked Connection Hinge Screw (eccentric)
1520R	26200	Feed Forked Connection Hinge Screw Nut...
1832	26200	Feed Forked Connection Roller with 1085E..
1085E	26200	Feed Forked Connection Roller Screw Stud..
32510R	26202	Feed Raising Bar with 1944
1301C	26202	Feed Raising Bar Hinge Screw
1944	26202	Feed Raising Bar Roller and Stud
33693	26200	Feed Regulator
8217	26200	Feed Regulator Friction Washer.....
51771ZG	26200	Feed Regulator Thumb Nut.....
33694	-----	Feed Regulator Thumb Nut 51771ZG with 33695 and 33701
33695	26200	Feed Regulator Thumb Nut Screw Stud.....
33701	26200	Feed Regulator Thumb Nut Screw Stud Friction Spring
51295C	26200	Feed Regulator Hinge Screw
33611R	26202	Feed Rock Shaft
307C	26202	Feed Rock Shaft Screw Center (2)
56814	-----	Feed Rock Shaft Screw Center 307C with 1513R (2)
1513R	26202	Feed Rock Shaft Screw Center Nut (2).....
32672	26200	Hand Wheel, 3/4 in. pulley
		NOTE: When ordering No. 32672, color required must be stated.
51045AL	26200	Machine Hinge Connection Set Screw (2).....
33655	26204	Needle Bar
33613	26204	Needle Bar Connecting Link
33678	-----	Needle Bar Connecting Link 33613 with 33673.
33673	26204	Needle Bar Connecting Stud with 1353AL

No.	Plate	Name
1353AL	26204	Needle Bar Connecting Stud Set Screw
33615	26200	Needle Bar Crank with 1036AL and 1134AL..
1134AL	26200	Needle Bar Crank Position Screw.....
33657ZB	26204	Needle Bar Hole Plug
2054ZG	26204	Needle Clamp with 140545ZC.....
140545ZC	26204	Needle Clamp Thumb Screw
32520	26203	Oscillating Hook
32626	-----	Oscillating Hook 32520 with 32590.....
32776R	26202	Oscillating Hook Bell Crank
50561C	26202	Oscillating Hook Bell Crank Hinge Screw.....
32522	26203	Oscillating Hook Bobbin
32590	26203	Oscillating Hook Bobbin Case with 1172F, 1173D and 32567
32661	26203	Oscillating Hook Bobbin Case Cushion Spring
662J	26203	Oscillating Hook Bobbin Case Cushion Spring Screw
32659	26203	Oscillating Hook Bobbin Case Position Bracket.....
32660	26203	Oscillating Hook Bobbin Case Position Bracket complete, Nos. 662J, 32528, 32598, 32597, 32057, 32001, 32009, 32007, 32007 and 50580E
32662	26203	Oscillating Hook Bobbin Case Position Bracket Hinge Stud
50611J	26203	Oscillating Hook Bobbin Case Position Bracket Hinge Stud Set Screw
32663	26203	Oscillating Hook Bobbin Case Position Bracket Latch
50579J	26203	Oscillating Hook Bobbin Case Position Bracket Latch Screw
32598	26203	Oscillating Hook Bobbin Case Position Oil Pad (felt).....
32599	26203	Oscillating Hook Bobbin Case Position Bracket Oil Pad Holder
1172F	26203	Oscillating Hook Bobbin Case Tension Regu- lating Screw
32567	26203	Oscillating Hook Bobbin Case Tension Spring.
1173D	26203	Oscillating Hook Bobbin Case Tension Spring Screw
32664	26203	Oscillating Hook Bobbin Ejector.....
50580E	26203	Oscillating Hook Bobbin Ejector Hinge Screw Stud
32528	26203	Oscillating Hook Bobbin Ejector Spring.....
32529R	26203	Oscillating Hook Connecting Link.....
1132C	26203	Oscillating Hook Connecting Link Hinge Screw
32594R	26203	Oscillating Hook Crank with 1485R
1485R	26203	Oscillating Hook Crank Clamping Screw.....
33706	26202	Oscillating Hook Pitman

No.	Plate	Name
44C	26202	Oscillating Hook Pitman Screw Stud (left).....
1216C	26200	Oscillating Hook Pitman Screw Stud (right)...
216C	26200	Oscillating Hook Pitman Screw Stud (right) Cap Screw
1520R	26200	Oscillating Hook Pitman Screw Stud (right) Nut
32569ZB	26201	Oscillating Hook Slide
32570	26201	Oscillating Hook Slide Friction Spring
226J	26201	Oscillating Hook Slide Friction Spring Screw.
33709	26204	Presser Bar (hollow)
33620AF	26204	Presser Bar Lifter
33705	26204	Presser Bar Lifter Hinge Pin
33667E	26204	Presser Bar Lifting Bracket with 50052E
33669E	-----	Presser Bar Lifting Bracket 33667E with 33676
33677	-----	Presser Bar Lifting Bracket 33669 with 240E, 33674 and 33675
50052E	26204	Presser Bar Lifting Bracket Clamping Screw..
170067	26204	Presser Bar Spring
170068	-----	Presser Bar Spring 170067 with 170183.....
51224ZB	26201	Presser Foot Thumb Screw
50054ZB	26204	Pressure Regulating Thumb Screw
170183	26204	Pressure Regulating Thumb Screw Extension Pin
33678AF	26201	Stitch Thread Regulator
33698	26200	Stitch Indicator (red dot)
33699	26200	Stitch Indicator Plate
51384S	26200	Stitch Indicator Plate Screw (2)
33700	26200	Stitch Indicator Spring
2102	26205	Tension Disc (2)
45866	26205	Tension Indicator
45864	26205	Tension Indicator Flange
		NOTE: When ordering No. 45864, color required must be stated.
45865	26205	Tension Indicator Flange Stop Washer
51681 ZB	26205	Tension Regulating Thumb Nut with 45339....
45339	26205	Tension Regulating Thumb Nut Engaging Pin.
33659	26205	Tension Releasing Lever
33707	26205	Tension Releasing Lever Hinge Pin
33660	26205	Tension Releasing Lever Spring
32574	26205	Tension Releasing Pin
140167ZJ	26205	Tension Screw Stud
45870	-----	Tension Screw Stud 140167ZJ with 51681ZB..
50305C	26205	Tension Screw Stud Set Screw
45869	26205	Tension Spring
32757	26205	Tension (Graduated) complete, Nos. 32574, 32758, 32759, 45864, 45865, 45866, 45869, 45870 and two 2102

No.	Plate	Name
26075C	26204	Thread Cutter and Holder
33632ZG	26204	Thread Guard (front of arm)
237ZJ	26204	Thread Guard (front of arm) Set Screw
8422ZG	26205	Thread Guard (head of arm)
33634	26204	Thread Take-up Crank
1036AL	26200	Thread Take-up Crank Set Screw
33635AF	26204	Thread Take-up Lever
33636ZG	-----	Thread Take-up Lever complete, Nos. 33635ZG, 33637 and 33638 (for Agents only).
33702ZG	-----	Thread Take-up Lever 33636 with 1130E, 33634, 33678, 50056E and 173558
50056E	26204	Thread Take-up Lever Cap Screw
33637	26204	Thread Take-up Lever Hinge Stud
33638	26204	Thread Take-up Lever Link
173558	26204	Thread Take-up Lever Link Hinge Stud
33704	-----	Thread Take-up Lever Link Hinge Stud 173558 with 1130E (for Agents only)
1130E	26204	Thread Take-up Lever Link Hinge Stud Cap Screw
44741	26204	Thread Take-up Lever Link Hinge Stud Set Screw
32758	26205	Thread Take-up Spring
32759	26205	Thread Take-up Spring Regulator with 50305C
453AL	26205	Thread Take-up Spring Regulator Set Screw..
32783	26201	Throat Plate
691BB	26201	Throat Plate Screw (2)
33674	26204	Timing Gauge, for setting the height of the Needle Bar and timing the Oscillating Hook ..
240E	26204	Timing Gauge Screw
33675J	26204	Timing Gauge Screw Washer
140543L	-----	Trade Mark Drive Screw (2)
140543L	-----	Number Plate Drive Screw (2)

ATTACHMENT SET

No.	Plate	Name
25527	26207	Seam Guide
32522	26207	Bobbin (4)
32622	26207	Feed Cover Plate (Flat Top)
50053ZB	26207	Seam Guide Thumb Screw
120378	26207	Screw Driver
161127	26207	Presser Foot (adjustable, for sewing either on the right or left side of the needle) complete for cording and slide fasteners.....
161133	26207	Tube of Oil
161208	26207	Box (plastic).....
15 x 1	-----	Needles three each of sizes 11 and 14 (6)...
161119	26207	Attachment Set, packaged in Box (plastic) No. 161208, Nos. 25527, 32622, 50053ZB, 120378, 161127, 161133, four 32522 and six needles (15x1, three each of sizes Nos. 11 and 14) for U.S.A. and Canada only.

SPECIAL ATTACHMENTS

No.	Plate	Name
160506	-----	Buttonholer
35505	-----	Embroidery Attachment for two threads.....
26538	-----	Style-O-Matic Attachment
121634	-----	Needle Threader and Seam Ripper.....
35985	-----	Tubular Trimming Attachment
160720	-----	Darning and Embroidery Attachment
160741	-----	Walking Presser Foot

BOBBIN WINDER (Universal)

No.	Plate	Name
15072	26206	Bobbin Position Pin
33689	26206	Bracket (belt cover)
180ZB	26206	Bracket Screw
66670	26206	Frame
45297	26206	Frame 66670 with 15288ZG and 66671ZG.....
51319R	26206	Frame Hinge Screw
66601	26206	Frame Spring
15287	26206	Friction Ring (rubber).....
NOTE: When ordering No. 15287, color required must be stated.		
15288ZG	26206	Pulley
66671ZG	26206	Spindle with 15072
45268ZG	26206	Stop Latch
51303X	26206	Stop Latch Hinge Screw.....
66775	26206	Stop Latch Spring
125326	26206	Tripping Arm
190ZJ	26206	Tripping Arm Screw
33691	26206	Thread Guide
208ZJ	26206	Thread Guide Screw

BIAS GAUGE

No.	Plate	Name
25525	26209	Bias Gauge

BINDER

No.	Plate	Name
160359	26209	Binder

BRAIDER

No.	Plate	Name
25510	26208	Braider
289B	26208	Braider Thumb Screw.....

FEED COVER PLATE

No.	Plate	Name
32589	26209	Feed Cover Plate (oval top).....

FINGER GUARD

No.	Plate	Name
121725	26208	Finger Guard

HEMMER (Feet)

No.	Plate	Name
120842	26208	Hemmer Foot, 5/64 in. Hem
25893	26208	Hemmer Foot, 1/4 in. Hem
36333	26208	Hemmer Foot, Flanged for chiffon and Silk..

HEMMER (Adjustable)

No.	Plate	Name
35931	26209	Hemmer (adjustable)

HEMSTITCHER

No.	Plate	Name
120687	26209	Hemstitcher with Yielding Presser Plate

PRESSER FEET

No.	Plate	Name
121441	26208	Presser Foot for Gathering
25978	26208	Presser Foot (single toe) for gathering
121614	26208	Presser Foot with 51282J and 121615, for blind stitch braiding, for soutache braid.....
121615	26208	Presser Foot Braid Guide
	NOTE:	When ordering Nos. 121614 or 121615, send sample of braid for which it is to be used.
51282J	26208	Presser Foot Braid Guide Screw.....
36058	26208	Presser Foot with 665B and 36059, for blind stitch cording, to turn small curves
36059	26208	Presser Foot Cord Guide
	NOTE:	When ordering Nos. 36058 or 36059, send sample of cord for which it is to be used.
665B	26208	Presser Foot Cord Guide Screw
36067	26208	Presser Foot for braiding, for art work, for braid 1/16 in. to 3/16 in. wide
	NOTE:	When ordering No. 36067, send sample of the braid for which it is to be used.

QUILTER

No.	Plate	Name
35932	26208	Quilter

RUFFLER

No.	Plate	Name
120598	26209	Ruffler, for one, six and twelve stitch Ruffling

RUFFLER SHIRRING PLATE

No.	Plate	Name
121170	26209	Ruffler Shirring Plate with 51395W
51395W	26209	Ruffler Shirring Plate Thumb Screw.....

STILETTO

No.	Plate	Name
25539	26208	Stiletto

UNDER BRAIDER

No.	Plate	Name
160927	26209	Under Braider with 51395W.....
51395W	26209	Under Braider Thumb Screw
25637	26209	Under Braider Foot

MOTOR PARTS

No.	Plate	Name
197280	-----	Armature complete for RF5-7 Motor
197275	20210	Armature complete for RF5-8 Motor
195540	26210	Armature Shaft Bearing (2).....
195541	26210	Armature Shaft Bearing Retainer (2)
931744	26210	Armature Shaft Thrust Washer (1/64 in.).....
931745	-----	Armature Shaft Thrust Washer (1/32 in.).....
931746	-----	Armature Shaft Thrust Washer (5/64 in.).....
198651	26210	Belt (moulded).....
192457	26210	Brush (carbon) (2).....
197293	26210	Brush Holder
196832	26210	Brush Holder Spacing Bushing (2).....
192458	26210	Brush Spring (2).....
197611	26210	Brush Tube Insulation (2).....
197279	26210	End Cover (commutator end).....
197278	26210	End Cover (pulley end)
140687	26210	End Cover Fastening Screw (2).....
1783	26210	End Cover Fastening Screw Nut (4).....
197282	-----	Field Coils complete for RF5-7 Motor
197277	-----	Field Coils complete for RF5-8 Motor
964514	26210	Field Coils Retainer (2).....
195871	-----	Field Core complete for RF5-7 and RF5-8 Motors
197281	-----	Field Core with Coils and Terminals complete for RF5-7 Motor
197276	26210	Field Core with Coils and Terminals complete for RF5-8 Motor
196903	26211	Lead Cord Complete.....
197613	26211	Lead Cord Plug
888043	26210	Lead Connector (large) (2).....

MOTOR PARTS

No.	Plate	Name
887915	26210	Lead Connector (small)
197612	26211	Lead Strain Relief (3).....
140688	26210	Motor Screw
701734	26210	Motor Screw Washer.....
190087	26210	Pulley
190086	-----	Pulley 190087 with 1019AL.....
1019AL	26210	Pulley Set Screw.....

CONTROLLER (Treadle)

No.	Plate	Name
196819	26211	Controller Back Cover
196824	26211	Controller Back Cover Cushion (4).....
1783	26211	Controller Back Cover Screw Nut
931055		
196826	26211	Controller Housing.....
196849	26211	Controller Insulation.....
196924	26211	Controller Lead with 196881 and 197612.....
196881	26211	Controller Lead Bushing
197612	26211	Controller Lead Strain Relief.....
140686	26211	Controller Resistance Unit and Back Cover Screw
50939	26211	Controller Resistance Unit Screw (short).....
1783	26211	Controller Resistance Unit Screw Nut (2).....
701992	26211	Controller Resistance Unit Screw Nut Washer (2)
196827	26211	Controller Resistance Unit Complete
196906	26211	Controller complete, Nos. 50939, 140686, 196819, 196826, 196827, 196849, 196924, 931055, two 701992, three 1783 and four 196824

SPOTLIGHT

No.	Plate	Name
195127	26212	Spotlight Body (lower half)
195128	26212	Spotlight Body (upper half)
195129	26212	Spotlight Body Snap Ring (large).....
195130	26212	Spotlight Body Snap Ring (small).....
195224	26212	Spotlight Bracket
51463XC	26212	Spotlight Bracket Screw

SPOTLIGHT

No.	Plate	Name
195148	26212	Spotlight Lamp
		NOTE: When ordering No. 195148, state voltage required.
195132	26212	Spotlight Lamp Socket.....
195135	26212	Spotlight Lead with 195132.....
195133	26212	Spotlight Lens (blue glass)
195134	26212	Spotlight Lens Tension Spring
196240	26212	Spotlight Switch Key
195143	-----	Spotlight Switch Key Snap Ring.....
195957	26212	Spotlight Switch Rotating Contact with Cam and Insulator.....
195140	26212	Spotlight Switch Spring Contact (lamp side)..
195141	26212	Spotlight Switch Spring Contact (lead side)...
195233	26212	Spotlight (blue glass lens) complete, Nos. 177X, 51463XC, 195127, 195128, 195129, 195130, 195133, 195134, 195135, 195140,
		196240 and 196625
177X	-----	Spotlight Screw
196625	-----	Spotlight Screw Retaining Washer

NUMERICAL LIST OF PARTS

No.	Plate	Name
44C	26202	Oscillating Hook Pitman Screw Stud (left) ...
138E	26202	Arm Screw (3)
177X	-----	Spotlight Screw for 195233.....
180ZB	26206	Bobbin Winder Bracket Screw.....
190ZJ	26206	Bobbin Winder Tripping Arm Screw for 33690
191C	26201	Feed Dog Screw
203ZB	26201	Face Plate Screw
208ZJ	26206	Bobbin Winder Thread Guide Screw.....
216C	26200	Oscillating Hook Pitman Screw Stud (right) Cap Screw.....
226J	26201	Oscillating Hook Slide Friction Spring Screw
237ZJ	26204	Thread Guard (front of arm) Set Screw.....
240E	26204	Timing Gauge Screw for 33677.....
248ZA	26200	Clamp Stop Motion Clamp Stop Screw.....
256ZB	26200	Clamp Stop Motion Clamp Screw
289B	26208	Braider Thumb Screw
287C	26200
315C	26202	Feed Bar Screw Center for 15445
447AL	26204	Thread Take-up Lever Link Hinge Stud Set Screw.....
448ZA	26200	Arm Shaft Bushing Set Screw for 33692.....
453AI	26205	Thread Take up Spring Regulator Set Screw ..
662J	26203	Oscillating Hook Bobbin Case Cushion Spring Screw for 32660.....
665B	26208	Presser Foot Cord Guide Screw for 36058.....
691BB	26201	Throat Plate Screw
1019AL	26210	Pulley Set Screw for 190086.....
1036AL	26200	Thread Take-up Crank Set Screw for 33615..
1085E	26200	Feed Forked Connection Roller Screw Stud for 1832.....
1130E	26204	Thread Take-up Lever Link Hinge Stud Cap Screw for 33702 and 33704.....
1132C	26203	Oscillating Hook Connecting Link Hinge Screw
1134AL	26200	Needle Bar Crank Position Screw for 33615..
1148AL	26200	Clamp Stop Motion Flanged Bushing Set Screw
1172F	26203	Oscillating Hook Bobbin Case Tension Regu- lating Screw for 32590.....
1173D	26203	Oscillating Hook Bobbin Case Tension Spring Screw for 32590
1216C	26200	Oscillating Hook Pitman Screw Stud (right) for 33661.....
1301C	26202	Feed Raising Bar Hinge Screw.....
1353AL	26204	Needle Bar Connecting Stud Set Screw for 33673

No.	Plate	Name
1381C	26200	Feed Forked Connection Hinge Screw (eccentric).....
1485R	26203	Oscillating Hook Crank Clamping Screw for 32594.....
1512R	26200	Arm Rock Shaft Screw Center (lower) Nut for 33666.....
1513R	26202	Feed Rock Shaft Screw Center Nut for 56814
1519R	26202	Feed Bar Screw Center Nut for 15445.....
1520R	26200	Feed Forked Connection Hinge Screw Nut....
1520R	26200	Oscillating Hook Pitman Screw Stud (right) Nut for 33661.....
1783	26210	End Cover Fastening Screw Nut.....
1783	26211	Controller Back Cover Screw Nut for 196906
1783	26211	Controller Resistance Unit Screw Nut for 196906.....
1832	26200	Feed Forked Connection Roller with 1085E, for 33664.....
1944	26202	Feed Bar Roller and Stud for 32507.....
1944	26202	Feed Raising Bar Roller and Stud for 32510.
2002	26202	Arm Dowel Pin.....
2007/LG	26205	Arm Spool Pin.....
2054ZG	26204	Needle Clamp with 140545ZC.....
2102	26205	Tension Disc for 32757.....
8217	26200	Feed Regulator Friction Washer.....
8422ZG	26205	Thread Guard (head of arm).....
8879	26205	Arm Spool Pin Washer (cloth).....
		NOTE: When ordering No. 8879, color required must be stated.
15072	26206	Bobbin Winder Bobbin Position Pin for 66671
15287	26206	Bobbin Winder Friction Ring (rubber) for 33690.....
		NOTE: When ordering No. 15287, color required must be stated.
15288ZG	26206	Bobbin Winder Pulley for 45297.....
15445	-----	Feed Bar Screw Center 315C with 1519R.....
25510	26208	Braider.....
25525	26209	Bias Gauge.....
25527	26207	Seam Guide for 161119.....
25539	26208	Stiletto.....
25637	26209	Under Braider Foot.....
25893	26208	Hemmer Foot 1/4" hem.....
25978	26208	Presser Foot (single toe) for Gathering.....
26075C	26204	Thread Cutter and Holder.....
26538	-----	Style-o-Matic Attachment (special attachments)
32503	26200	Arm Shaft Bushing for 33662.....
32507R	26202	Feed Bar with 1944.....
32510R	26202	Feed Raising Bar with 1944.....
32520	26203	Oscillating Hook for 32626.....
32522	26207	Bobbin for 161119.....

No.	Plate	Name
32522	26203	Oscillating Hook Bobbin.....
32528	26203	Oscillating Hook Bobbin Ejector Spring for 32660.....
32529R	26203	Oscillating Hook Connecting Link.....
32567	26203	Oscillating Hook Bobbin Case Tension Spring for 32590.....
32569ZB	26201	Oscillating Hook Slide.....
32570	26201	Oscillating Hook Slide Friction Spring.....
32574	26205	Tension Releasing Pin for 32757.....
32589	26209	Feed Cover Plate (oval top).....
32590	26203	Oscillating Hook Bobbin Case with 1172F, 1173D and 32567, for 32626.....
32594R	26203	Oscillating Hook Crank with 1485R.....
32598	26203	Oscillating Hook Bobbin Case Position Oil Pad (felt) for 32660.....
32599	26203	Oscillating Hook Bobbin Case Position Bracket Oil Pad Holder for 32660.....
32600	26201	Feed Dog.....
32618	26200	Clamp Stop Motion Flanged Bushing.....
32622	26207	Feed Cover Plate (flat top) for 161119.....
32626	-----	Oscillating Hook 32520 with 32590.....
32659	26203	Oscillating Hook Bobbin Case Position Bracket for 32660.....
32660	26203	Oscillating Hook Bobbin Case Position Bracket complete, Nos. 662J, 32528, 32598, 32599, 32603, 32601, 32602, 32603, 32604, 50579J and 50580E.....
32661	26203	Oscillating Hook Bobbin Case Cushion Spring for 32660.....
32662	26203	Oscillating Hook Bobbin Case Position Bracket Hinge Stud for 32660.....
32663	26203	Oscillating Hook Bobbin Case Position Bracket Latch for 32660.....
32664	26203	Oscillating Hook Bobbin Ejector for 32660....
32672	26200	Hand Wheel, 3/4 in. pulley.....
		NOTE: When ordering No. 32672, color required must be stated.
32757	26205	Tension (Graduated) complete, Nos. 32574, 32758, 32759, 45864, 45865, 45866, 45869, 45870 and two 2102.....
32758	26205	Thread Take-up Spring for 32757.....
32759	26205	Thread Take-up Spring Regulator with 50305C, for 32757.....
32773ZG	26201	Presser Foot (hinged).....
32776R	26202	Oscillating Hook Bell Crank.....
32783	26201	Throat Plate.....
33602R	26200	Arm Rock Shaft with 905E, for 33661.....
33603	26200	Arm Shaft for 33662.....
33609R	26200	Feed Forked Connection for 33664.....

NUMERICAL LIST OF PARTS

No.	Plate	Name
33611R	26202	Feed Rock Shaft
33613	26204	Needle Bar Connecting Link for 33678
33615	26200	Needle Bar Crank with 1036AL and 1134AL, for 33662
33620AF	26204	Presser Bar Lifter.....
33632ZG	26204	Thread Guard (front of arm).....
33634	26204	Thread Take-up Crank
33635AF	26204	Thread Take-up Lever for 33636.....
33636ZG	-----	Thread Take-up Lever complete, Nos. 33635AF 33637 and 33638 (for Agents only).....
33637	26204	Thread Take-up Lever Hinge Stud for 33636..
33638	26204	Thread Take-up Lever Link for 33636
33654ZB	26201	Face Plate 33663ZB with 125423ZB.....
33655	26204	Needle Bar
33657ZB	26204	Needle Bar Hole Plug.....
33659	26205	Tension Releasing Lever
33660	26205	Tension Releasing Lever Spring.....
33661	-----	Arm Rock Shaft 33602R with 1216C and 1520R
33662	-----	Arm Shaft 33603 with 32503 and 33615.....
33663ZB	26201	Face Plate for 33654
33664	-----	Arm Rock Shaft Connection 3304YK with 1832..
33666	-----	Arm Rock Shaft Screw Center (lower) 50046C with 1512R
33667E	26204	Presser Bar Lifting Bracket with 50052E, for 33669
33667E	-----	Presser Bar Lifting Bracket 33667E with 33676, for 33677.....
33673	26204	Needle Bar Connecting Stud with 1353AL, for 33678
33674	26204	Timing Gauge, for setting the height of the Needle Bar and timing the Oscillating Hook for 33677
33675J	26204	Timing Gauge Screw Washer for 33677.....
33676AF	26204	Slack Thread Regulator for 33669
33677	-----	Presser Bar Lifting Bracket 33669 with 240E, 33674 and 33675.....
33678	-----	Needle Bar Connecting Link 33613 with 33673 for 33702
*33681P	-----	Bed
33689	26206	Bobbin Winder Bracket (belt cover) for 33690..
33690	26206	Bobbin Winder complete, Nos. 190ZJ, 15287, 33689, 45268, 45297, 51303X, 66601, 66775 and 125326
33691	26206	Bobbin Winder Thread Guide.....
*33692	-----	Arm with 448ZA and four 140543L
33693	26200	Feed Regulator
33694	-----	Feed Regulator Thumb Nut 51771ZG with 33695 and 33701.....
33695	26200	Feed Regulator Thumb Nut Screw Stud for 33694

NUMERICAL LIST OF PARTS

No.	Plate	Name
33698	26200	Stitch Indicator (red dot)
33699	26200	Stitch Indicator Plate
33700	26200	Stitch Indicator Spring
33701	26200	Feed Regulator Thumb Nut Screw Stud Friction Spring for 33694.....
33702ZG	-----	Thread Take-up Lever 33636 with 1130E, 33634, 33678, 50056E and 173558.....
33704	-----	Thread Take-up Lever Link Hinge Stud 173558 with 1130E (for Agents only)
33705	26204	Presser Bar Lifter Hinge Pin
33706	26202	Oscillating Hook Pitman
33707	26205	Tension Releasing Lever Hinge Pin.....
33709	26204	Presser Bar (hollow)
35505	-----	Embroidery Attachment for two threads (Special Attachments).....
35931	26209	Hemmer (adjustable).....
35932	26208	Quilter
35985	-----	Tubular Trimming Attachment (Special Attachments).....
36058	26208	Presser Foot with 665B and 36059 for blind stitch cording, to turn small curves.....
NOTE:		When ordering No. 36058, send sample of cord for which it is to be used.
36059	26208	Presser Foot Cord Guide
NOTE:		When ordering No. 36059, send sample of cord for which it is to be used.
36067	26208	Presser Foot for braiding, for art work, for braid 1/16 in. to 3/16 in. wide
NOTE:		When ordering No. 36067, state the size or send sample of braid for which it is to be used.
36333	26208	Hemmer Foot (Flanged) for chiffon and silk..
45268ZG	26206	Bobbin Winder Stop Latch for 33690
45297	26206	Bobbin Winder Frame 66670 with 15288ZG and 66671ZG, for 33690
45339	26205	Tension Regulating Thumb Nut Engaging Pin for 51681
45864	26205	Tension Indicator Flange for 32757.....
NOTE:		When ordering No. 45864, color required must be stated.
45865	26205	Tension Indicator Flanged Stop Washer for 32757.....
45866	26205	Tension Indicator for 32757
45869	26205	Tension Spring for 32757
45870	-----	Tension Screw Stud 140167ZJ with 51681ZB, for 32757
50046C	26200	Arm Rock Shaft Screw Center (lower) for 33666.....
50047C	26200	Arm Rock Shaft Screw Center (upper).....

Copyright © 1980 by Singer Sewing Machine Company, Inc. All rights reserved. Printed in the U.S.A.

No.	Plate	Name
195128	26212	Spotlight Body (upper half) for 195233
195129	26212	Spotlight Body Snap Ring (large) for 195233..
195130	26212	Spotlight Body Snap Ring (small) for 195233
195132	26212	Spotlight Lamp Socket for 195135
195133	26212	Spotlight Lens (blue glass) for 195233.....
195134	26212	Spotlight Lens Tension Spring for 195233....
195135	26212	Spotlight Lead with 195132 for 195233.....
195140	26212	Spotlight Switch Spring Contact (lamp side) for 195233
195141	26212	Spotlight Switch Spring Contact (lead side) for 195233
195143	-----	Spotlight Switch Key Snap Ring for 195233...
195148	26212	Spotlight Lamp for 195233
		NOTE: When ordering No. 195148, state voltage required.
195224	26212	Spotlight Bracket for 195233
195233	26212	Spotlight (blue glass lens) complete, Nos. 177X, 51463XC, 195127, 195128, 195129, 195130, 195133, 195134, 195135, 195140, 195141, 195143, 195148, 195224, 195227 196240 and 196625
195540	26210	Armature Shaft Bearing.....
195541	26210	Armature Shaft Bearing Retainer.....
195871	-----	Field Core complete for RF5-7 and RF5-8 Motors
195957	26212	Spotlight Switch Rotating Contact with Cam and Insulator for 195233
196240	26212	Spotlight Switch Key for 195233
196625	-----	Spotlight Screw Retaining Washer for 195233..
196819	26211	Controller Back Cover for 196906
196824	26211	Controller Back Cover Cushion for 196906....
196826	26211	Controller Housing for 196906
196827	26211	Controller Resistance Unit complete for 196906
196832	26210	Brush Holder Spacing Bushing
196849	26211	Controller Insulation for 196906.....
196881	26211	Controller Lead Bushing for 196924.....
196903	26211	Lead Cord Complete
196906	26211	Controller complete, Nos. 50939, 140686, 196819, 196826, 196827, 196849, 196924, 931055, two 701992, three 1783 and four 196824
196924	26211	Controller Lead with 196881 and 197612, for 196906
197275	26210	Armature complete for RF5-8 Motor
197276	26210	Field Core with Coils and Terminals complete for RF5-8 Motor
197277	-----	Field Coils Complete for RF5-8 Motor
197278	26210	End Cover (pulley end).....

No.	Plate	Name
197279	26210	End Cover (commutator end).....
197280	-----	Armature complete for RF5-7 Motor.....
197281	-----	Field Core with Coils and Terminals complete for RF5-7 Motor.....
197282	-----	Field Coils complete for RF5-7 Motor
197293	26210	Brush Holder
197611	26210	Brush Tube Insulation
197612	26211	Controller Lead Strain Relief for 196924.....
197612	26211	Lead Strain Relief
197613	26211	Lead Cord Plug
198651	26210	Belt (moulded)
701734	26210	Motor Screw Washer
701992	26211	Controller Resistance Unit Screw Nut Washer for 196906
887915	26210	Lead Connector (small)
888043	26210	Lead Connector (large)
931055	-----	Controller Back Cover Screw Washer for 196906.....
931744	26210	Armature Shaft Thrust Washer (1/64 in.).....
931745	-----	Armature Shaft Thrust Washer (1/32 in.).....
931746	-----	Armature Shaft Thrust Washer (3/64 in.).....
964514	26210	Field Coils Retainer

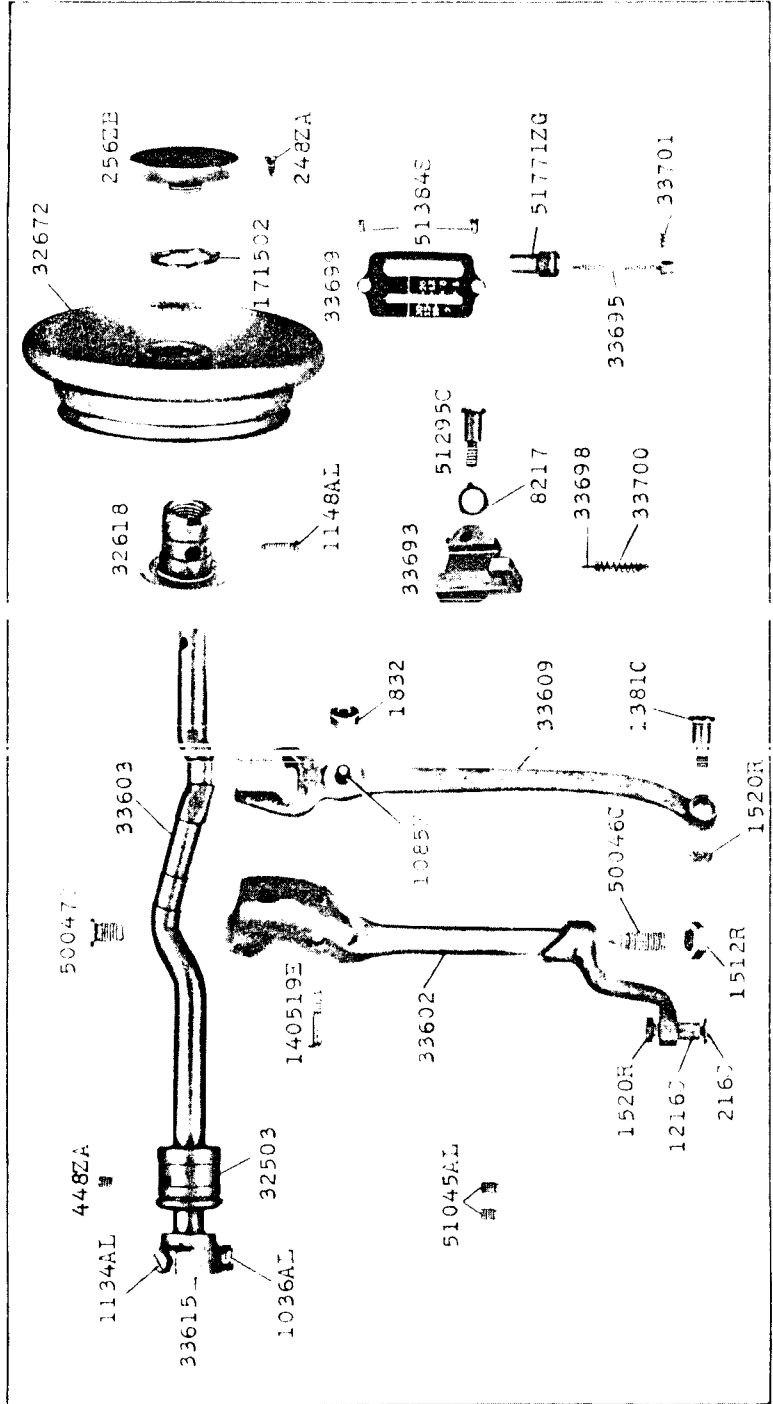

26201-1/2

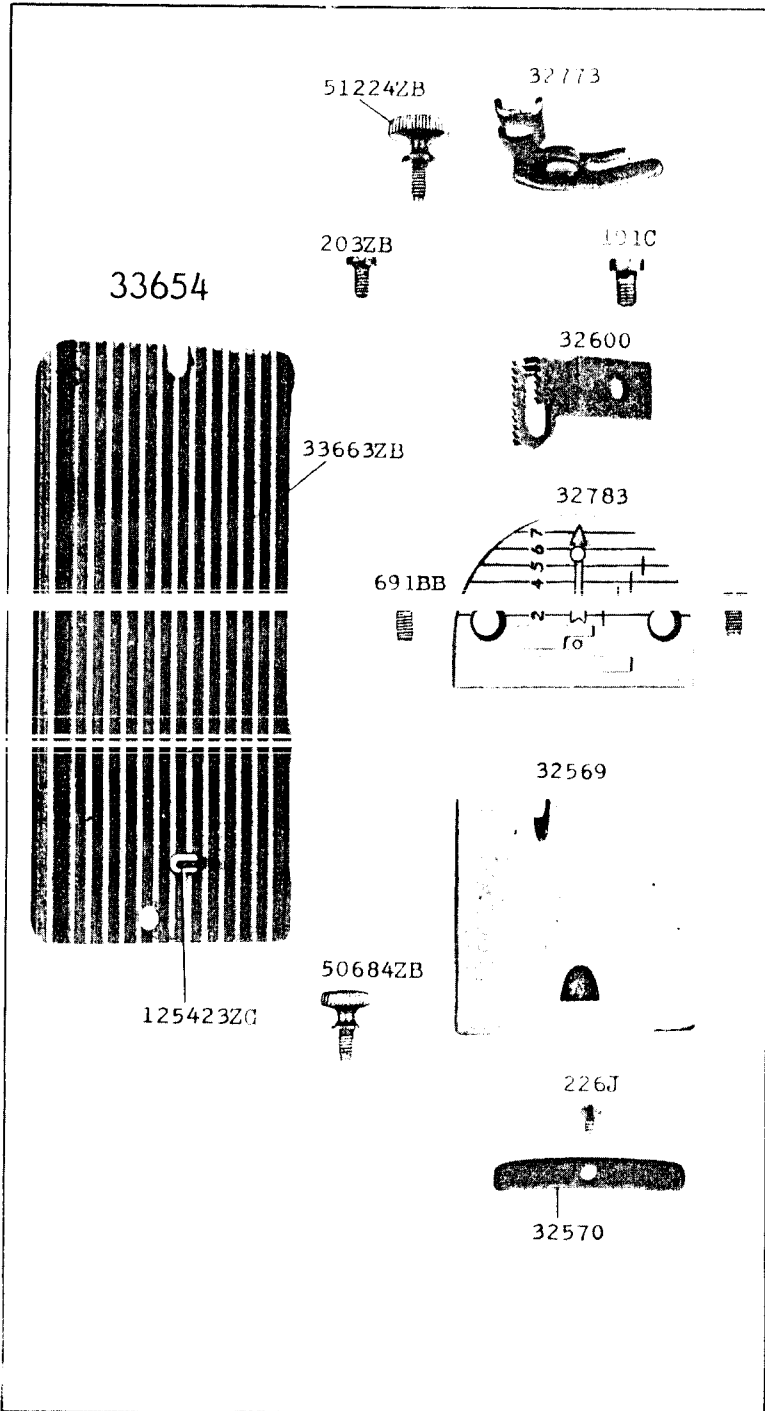

26202-1/2

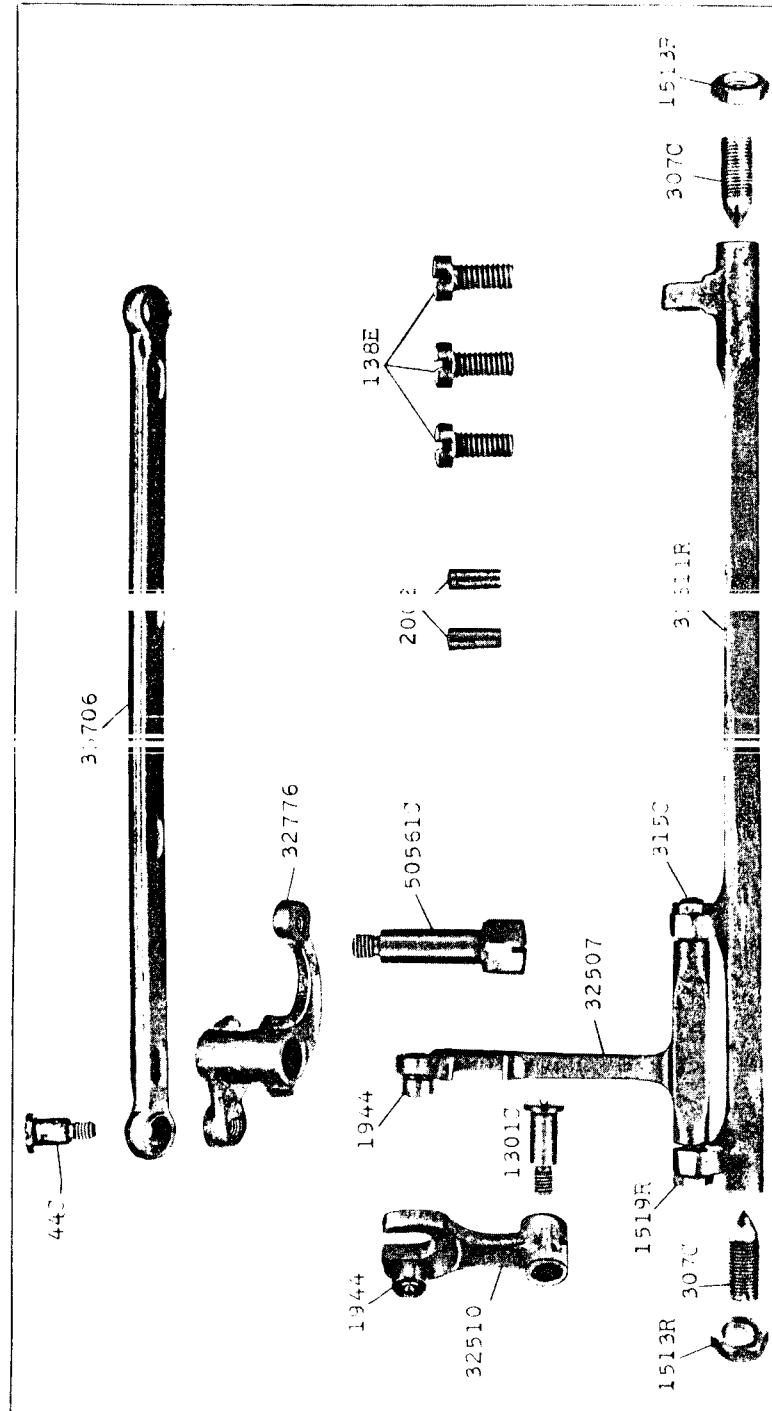

26203-1/2

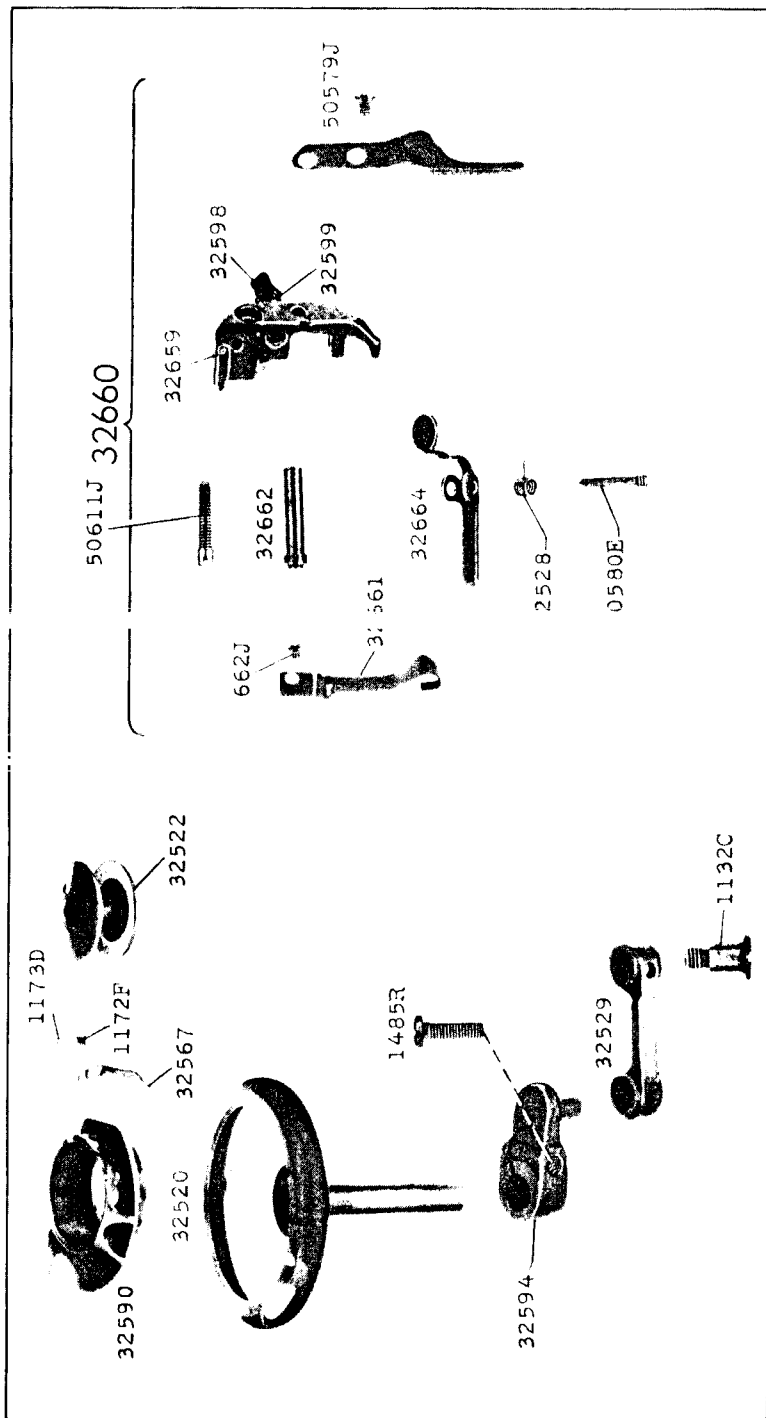

26204-1/2

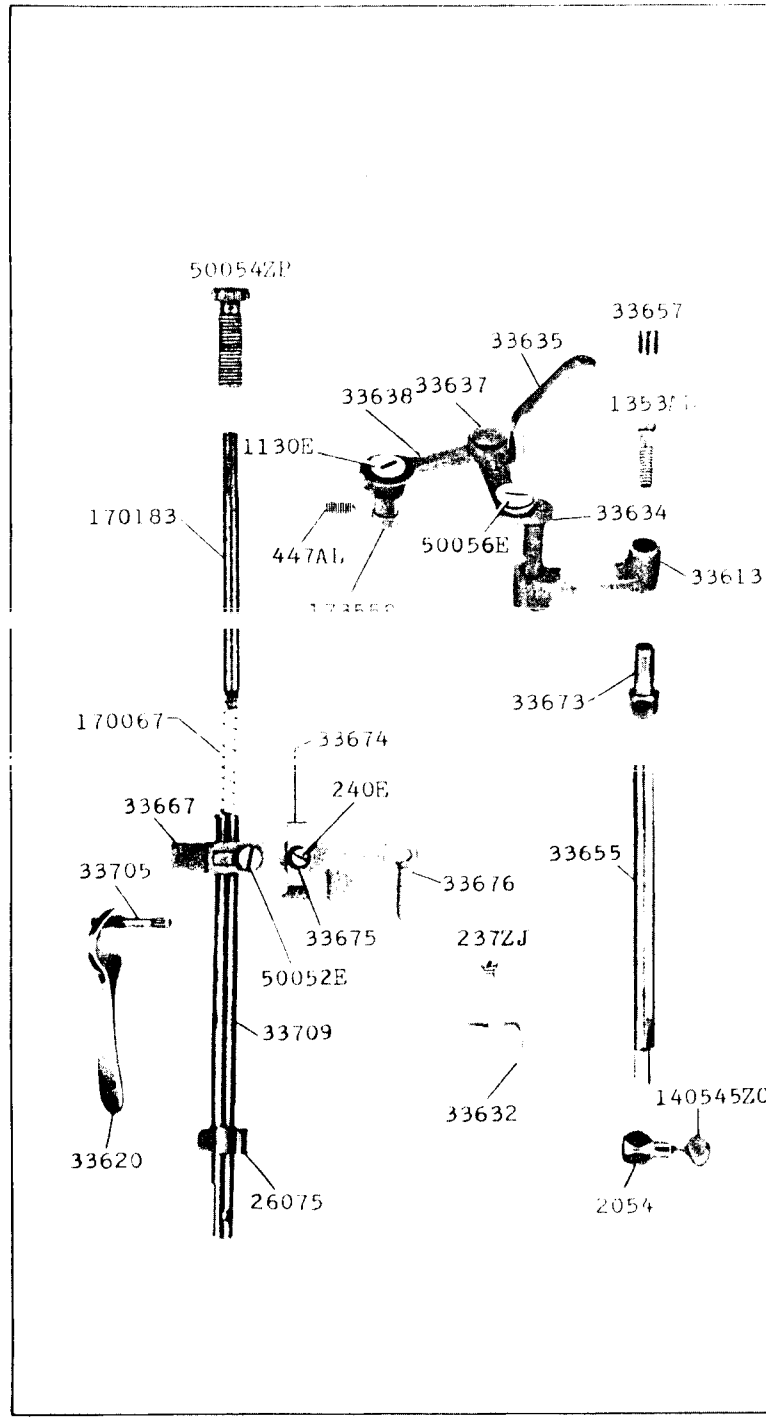

26205-2/3

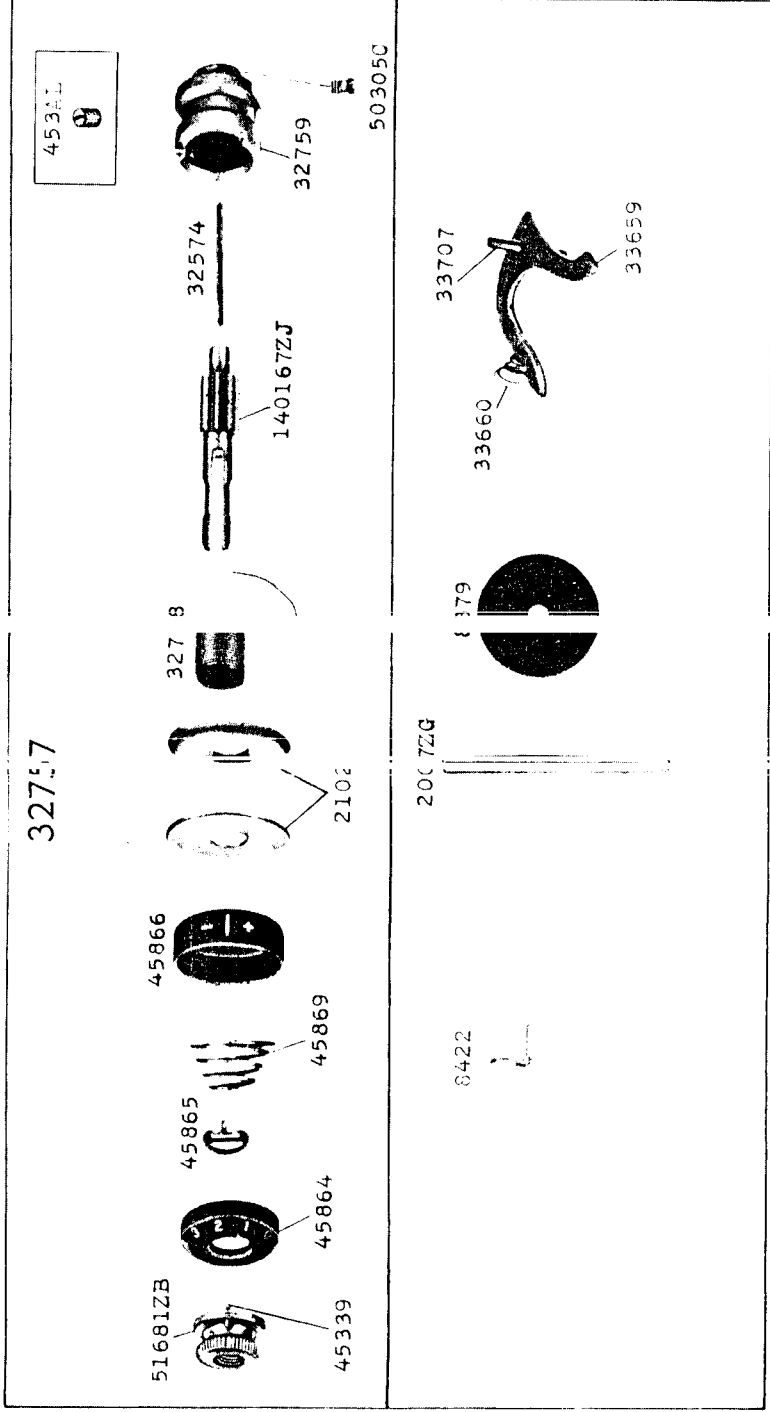

26206 1/2

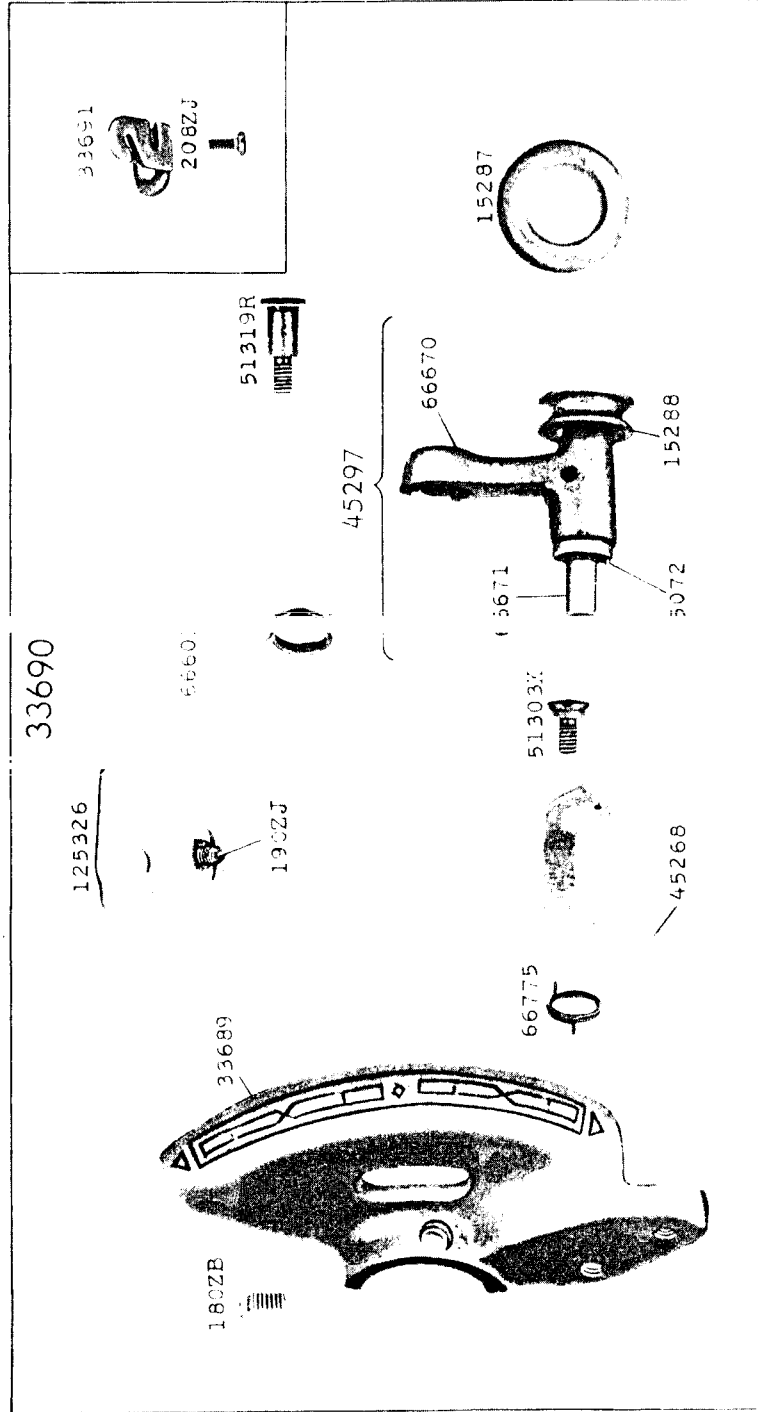

26207-1/2

161119

161208

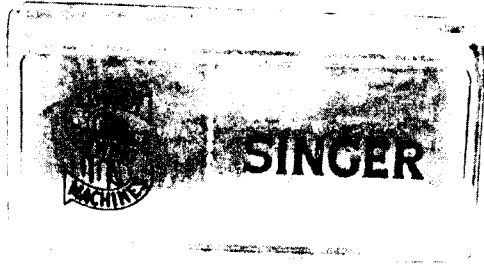

161133

120378



25527

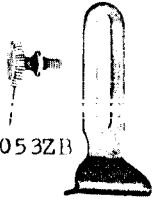

50053ZB

32622



161127

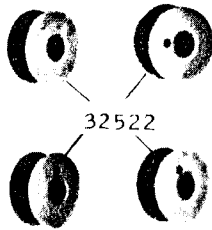
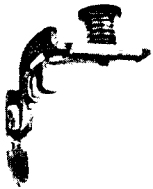

32522

26208-2/3

289B



25510

25893



25978



36058



36059

665B

36067



36333



120842



121441

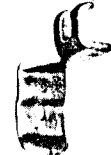

121614



121615

51282J

35932

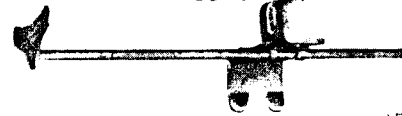

25539



121725



120687

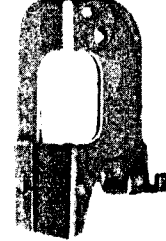

26209-2/3

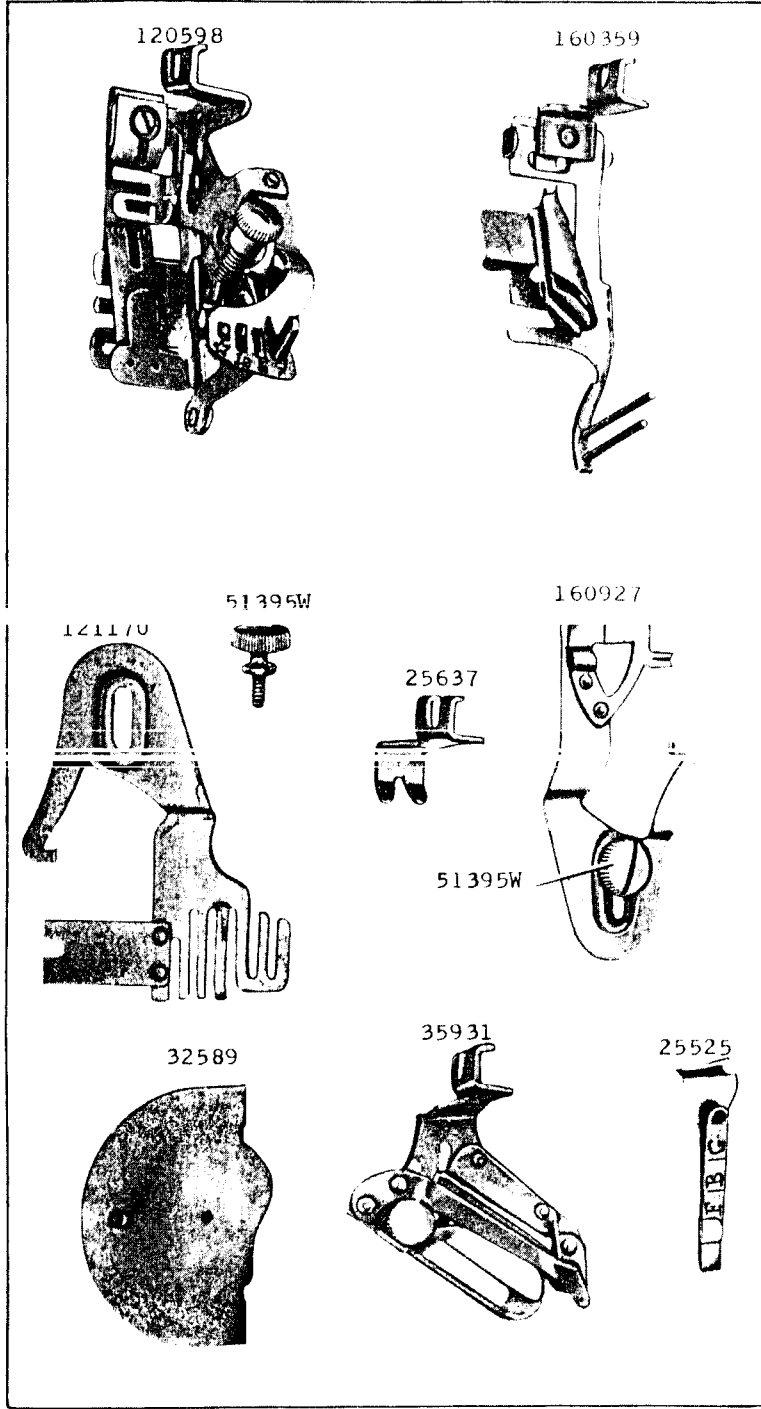

26210-1/3

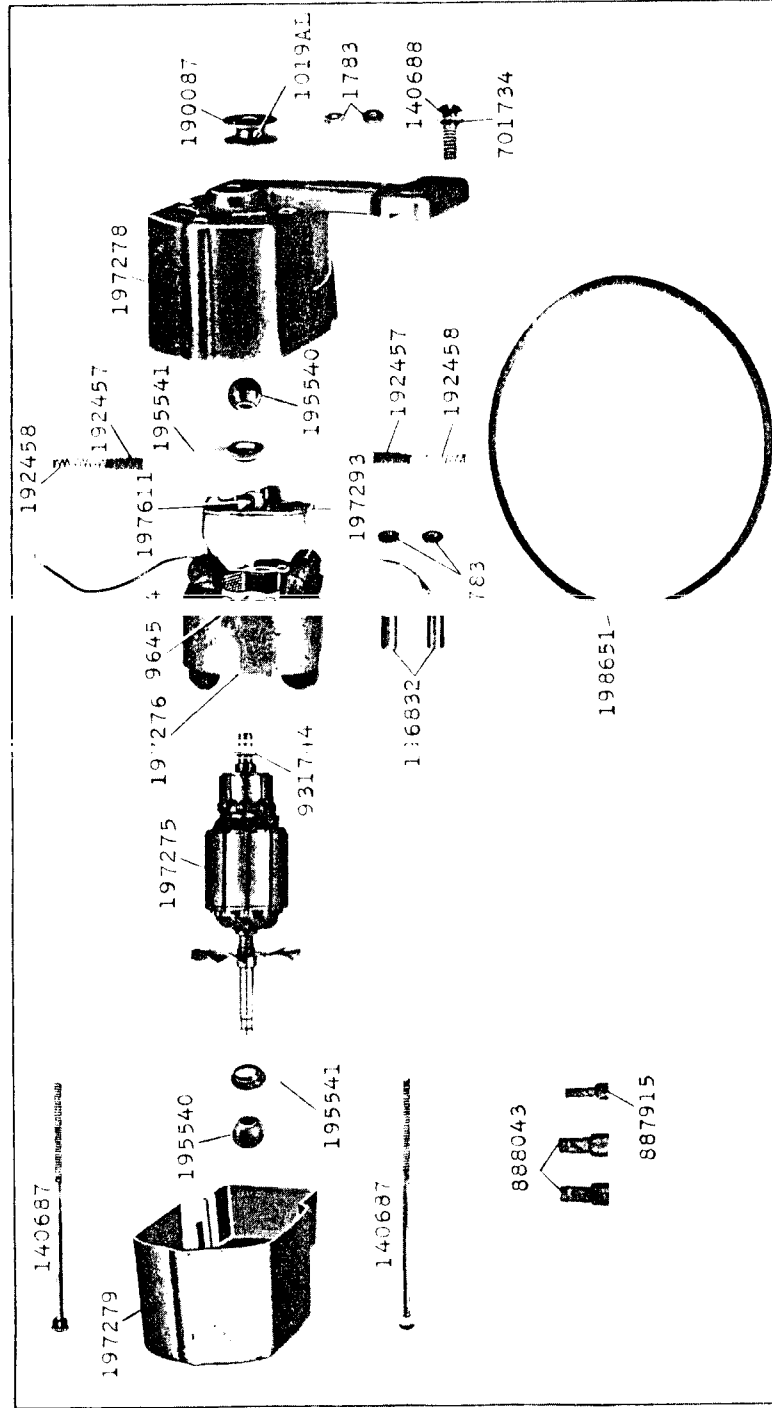

26211-1/3

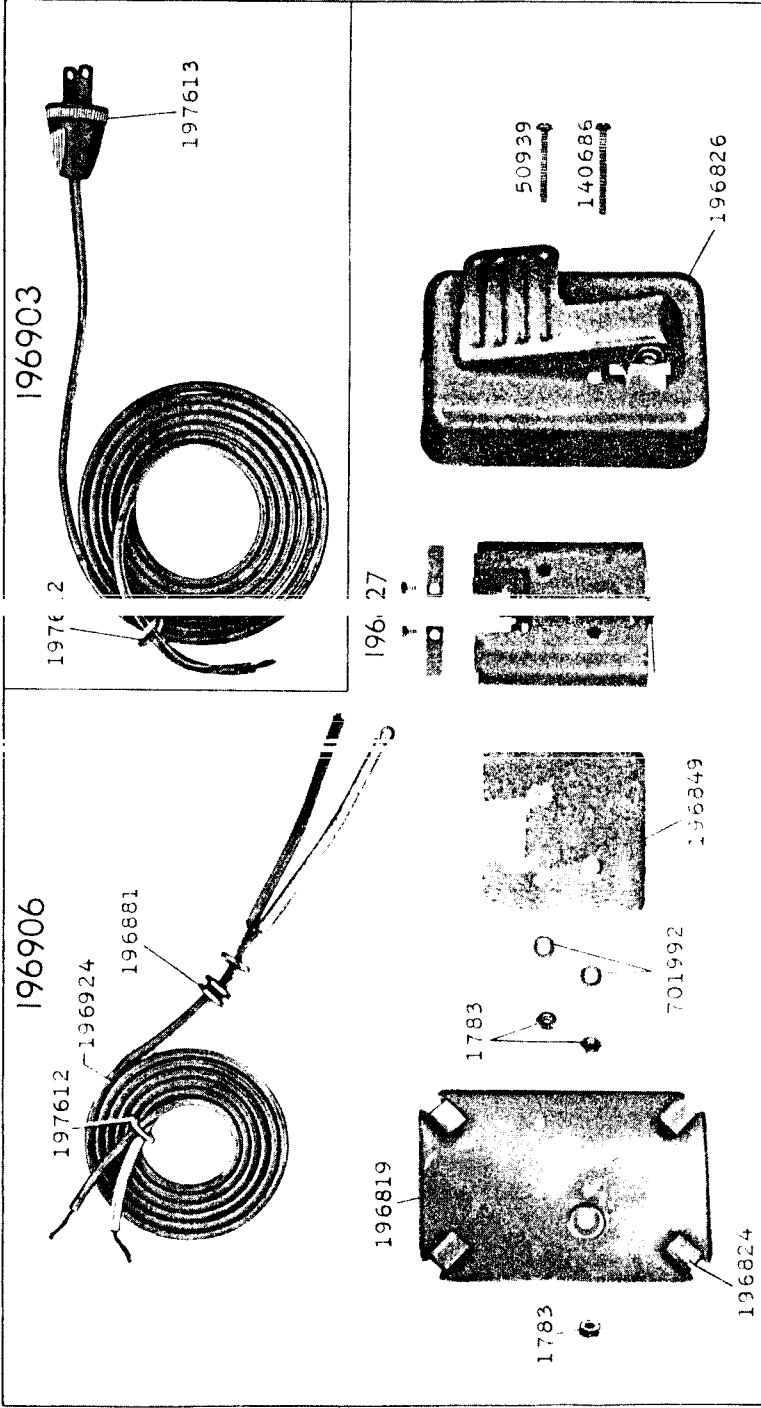

26212-1/2

