

Form 18142
JANUARY, 1926
PRINTED IN U. S. A.

LIST OF PARTS



MACHINE No. 86-3

THE SINGER MANUFACTURING COMPANY

INDEX

COPYRIGHT, U. S. A., 1916, 1921, 1922, 1923 AND 1926,
BY THE SINGER MANUFACTURING Co.
ALL RIGHTS RESERVED FOR ALL COUNTRIES

	PAGE
ACCESSORIES.....	17
FOOT LIFTER PARTS.....	18
IRON BASE.....	17
MACHINE No. 86-3.....	7
NUMERICAL LIST OF PARTS.....	21
OBSOLETE PARTS.....	19
THREAD UNWINDER.....	18

INSTRUCTIONS FOR ORDERING

In ordering from this list, use ONLY the PART number in the FIRST column.

The number stamped on a Sewing Machine part is in every case the number of the single part only.

Every combination of parts sent out as such has its specific number, which, although not stamped on the parts, must be used when ordering the combination.

Each number always indicates the SAME PART in whatever list it appears, or for whatever machine.

The letters after some of the numbers indicate the style of finish only, as follows:

- A. Hardened, Polished and Plated.
- B. Polished and Plated.
- C. Hardened only.
- D. Polished only.
- E. Soft, not Polished.
- F. Hardened and Polished.
- G.
- H. Blued.
- J. Plated only.
- K. Hardened and Plated.
- L. Brass or Gilt.
- M. Oxidized.
- P. Japanned.
- R. Merlized.
- T. Copper-plated.

These letters MUST BE USED when they appear in the list, and AFTER the number as in the list.

In this series:

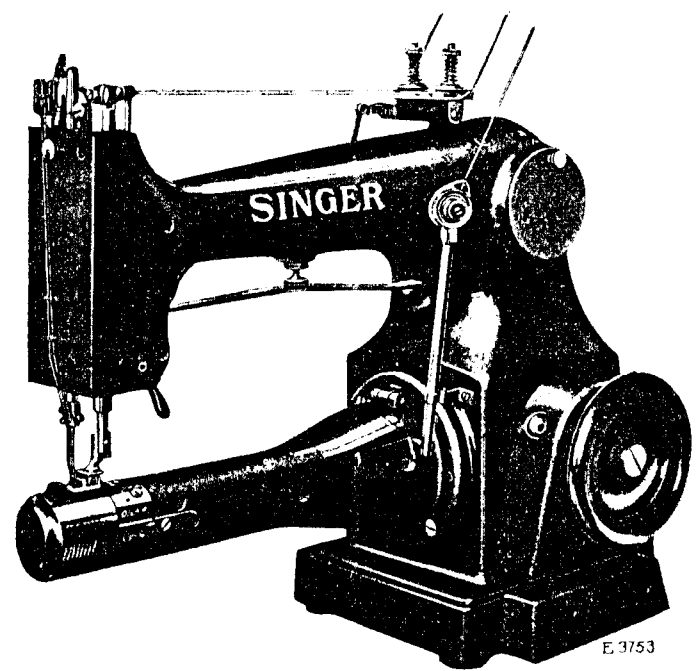
- 1 to 1500 and 50001 to 51500 are Screw Numbers.
- 1501 to 1800 are Nut Numbers.
- 1801 to 2000 are Roller Numbers.
- 2001 to 50000 and 52001 and upward are numbers of Machine Parts.

The figures in the second column refer only to the plates, illustrating the parts, and are NOT TO BE USED in ordering.

Parts marked with an asterisk (*) are furnished only when repairs are made at factory.

LIST OF PARTS COMPLETE

FOR



MACHINE No. 86-3

FOR SEAM COVERING ON KNIT GOODS, UNDERWEAR, ETC.
 TWO NEEDLES, ONE LOOPER. MECHANISM ENTIRELY ENCLOSED. GAUGES $\frac{1}{8}$, $\frac{3}{16}$ and $\frac{1}{4}$ INCH. OUTSIDE STITCH REGULATING DEVICE. DROP FEED. FOOT LIFTER. IN THE OPERATION OF THIS MACHINE, THE TOP OF THE HAND WHEEL TURNS FROM INSTEAD OF TOWARD THE OPERATOR.

NO.	PLATE	NAME
*55072	---	Arm.....
54913	6367	" Back Cover.....
54914	---	Arm Back Cover complete, Nos. 1538d, 50223d, 54913, 54915, 54916 and two 1443d.....

NO.	PLATE	NAME
54915	6369	Arm Back Cover Latch with 911E.....
50223D	6385	" " " " Hinge Screw.....
911E	6369	" " " " Screw Stud.....
1538D	6369	" " " " " " " Thumb Nut.....
54916	6369	Arm Back Cover Spring.....
1443D	6385	" " " " Screw.....
54897	6384	" Oil Cup.....
54917	6384	" " Tube for oiling 55077.....
55073	6389	" Rock Shaft.....
54919	6369	" " " Bushing (back).....
50224C	6385	" " " " " Set Screw.....
54920	6369	" " " " (front).....
888C	6385	" " " " " Set Screw.....
54921	6390	" " " Collar with two 456C....
456C	6385	" " " " " Set Screw.....
54603	6390	" " " Crank (back) with two 50135C.....
50135C	6390	Arm Rock Shaft Crank (back) Set Screw.....
54604	6390	" " " " (front) with two 50135C.....
50135C	6390	Arm Rock Shaft Crank (front) Set Screw.....
56016	6389	" Side Cover.....
286D	6385	" " " Thumb Screw.....
54923	6367	Belt Cover.....
134D	6385	" " Screw.....
54885	6367	Cloth Plate (left) with 54889 and two 4621.....
54886	6367	" " (right).....
54887	6367	" " Bracket with 345C.....
345C	6369	" " " Screw.....
50217D	6369	" " Screw.....
54888	6369	" " Spring.....
237D	6369	" " " Guide Screw.....
50218C	6369	" " " Lock Screw.....
*54889	6369	" " " Packing.....
4621	6369	" " " " Rivet.....
219D	6385	" " " " " Set Screw.....
54890	—	Cloth Plate complete, Nos. 219D, 237D, 50218C, 54885, 54886 and 54888.....
54891	—	Cloth Plate with Bracket complete, Nos. 54887, 54890 and two 50217D.....
55146	6389	Crank Connecting Rod complete, Nos. 219F, 1722E, 1723E, 54616, 54925, 55033 and 55034.....
*54925	—	Crank Connecting Rod (rod only).....
50368C	6390	" " " " Ball Screw Stud.....
1520E	6390	" " " " " " " Nut.....

NO.	PLATE	NAME
*54612	—	Crank Connecting Rod Cap (lower).....
896E	6385	" " " " " Screw.....
*54613	—	" " " " (upper).....
171E	6385	" " " " " Screw.....
*54614	—	" " " End Bearing (lower).....
*55032	—	Crank Connecting Rod End Bearing (upper).....
*54616	—	Crank Connecting Rod Head (lower) Nos. 54612, 54614 and two 896E.....
*55033	—	Crank Connecting Rod Head (upper) Nos. 50368C, 54613, 55032 and two 171E....
1722E	6391	Crank Connecting Rod Nut (lower).....
1723E	6391	" " " " (upper).....
55034	6390	" " " Position Plate.....
219F	6385	" " " " " Screw.....
*54927	—	Cylinder with 460C, 54613, 54664, 54913, 54914 and two 391D.....
54620	6384	Cylinder Dowel Pin.....
54621	6389	" End Cover.....
54622	—	Cylinder End Cover complete, Nos. 202D, 54621, 54728, 125599 and two 54628....
55151	6390	Cylinder End Cover Lock Spring.....
54624	6369	" " " " " Cap.....
189D	6385	" " " " " Screw.....
*54625	—	" " " Slide (back).....
125599	6390	" " " " " 54625 with 54626 and 54627.....
978F	6391	Cylinder End Cover Slide Block Stop Screw.....
*54626	—	Cylinder End Cover Slide (front).....
54627	6390	" " " " " Hinge Pin.....
54628	6384	" " " " Rivet.....
54643	6384	" Oil Tube.....
55074	6389	" Rock Shaft (lower) with 54704....
54929	6369	" " " " Bushing.....
447C	6385	" " " " " Set Screw.....
55075	6390	Cylinder Rock Shaft (lower) Eccentric.....
50225D	6385	" " " " " " " Adjusting Screw.....
54931	6390	Cylinder Rock Shaft (lower) Eccentric Connecting Rod with 54932 and two 171E.....
*54932	—	Cylinder Rock Shaft (lower) Eccentric Connecting Rod Cap.....
171E	6385	Cylinder Rock Shaft (lower) Eccentric Connecting Rod Cap Screw.....

NO.	PLATE	NAME
54933	6390	Cylinder Rock Shaft (lower) Eccentric Connecting Rod Stud with 207E.....
207E	6390	Cylinder Rock Shaft (lower) Eccentric Connecting Rod Stud Clamping Screw
103D	6385	Cylinder Rock Shaft (lower) Eccentric Hinge Screw.....
54704	6390	Cylinder Rock Shaft (lower) Key.....
54630	6389	" " " (upper).....
54934	6390	" " " " Collar with two 465c.....
465c	6385	Cylinder Rock Shaft (upper) Collar Set Screw.....
54632	6390	Cylinder Rock Shaft (upper) Crank with two 457c.....
54935	6390	Cylinder Rock Shaft (upper) Crank Connecting Link.....
457c	6390	Cylinder Rock Shaft (upper) Crank Set Screw.....
55076	6392	Cylinder Rock Shaft (upper) Eccentric with 457c and 624c.....
55066	6394	Cylinder Rock Shaft (upper) Eccentric Connecting Rod with 54939, 54940 and two each 171E and 896E.....
55067	6392	Cylinder Rock Shaft (upper) Eccentric Connecting Rod Ball Stud.....
1120c	6392	Cylinder Rock Shaft (upper) Eccentric Connecting Rod Ball Stud Set Screw..
1700E	6392	Cylinder Rock Shaft (upper) Eccentric Connecting Rod Ball Stud Set Screw Nut.....
*54939	—	Cylinder Rock Shaft (upper) Eccentric Connecting Rod Cap (lower).....
171E	6385	Cylinder Rock Shaft (upper) Eccentric Connecting Rod Cap (lower) Screw....
*54940	—	Cylinder Rock Shaft (upper) Eccentric Connecting Rod Cap (upper).....
896E	6385	Cylinder Rock Shaft (upper) Eccentric Connecting Rod Cap (upper) Screw....
55077	6393	Cylinder Rock Shaft (upper) Eccentric Connecting Rod Lever with 1120c and 1700E.....
54942	6374	Cylinder Rock Shaft (upper) Eccentric Connecting Rod Lever Hinge Stud....
446c	6385	Cylinder Rock Shaft (upper) Eccentric Connecting Rod Lever Hinge Stud Set Screw.....

NO.	PLATE	NAME
55034	6390	Cylinder Rock Shaft (upper) Eccentric Connecting Rod Position Plate.....
219F	6385	Cylinder Rock Shaft (upper) Eccentric Connecting Rod Position Plate Screw..
624c	6392	Cylinder Rock Shaft (upper) Eccentric Position Screw.....
457c	6390	Cylinder Rock Shaft (upper) Eccentric Set Screw.....
134D	6385	Cylinder Screw.....
54662	6374	" Thread Cover.....
767D	6385	" " " Screw.....
*54943	—	" Top Cover (back).....
54664	6384	" " " " Hinge Pin....
460c	6385	" " " " " " Set Screw.....
*54944	—	Cylinder Top Cover (front) with 665D and 54666.....
391D	6385	Cylinder Top Cover (front) Screw.....
54666	6374	" " " " Spring.....
665D	6374	" " " " " Screw..
54945	6389	Face Plate with two 2827.....
46111	6381	" " Pin.....
203F	6385	" " Screw.....
2827	6392	" " Thread Guard with 8505.....
8505	6392	" " " " Rivet.....
54672	6395	Feed Dog (12 teeth) 16 teeth to the inch..
54947	6374	" " Adjusting Wedge.....
55078	6392	" " Carrier with two 462c.....
462c	6385	" " " Set Screw.....
54949	6374	" " " Slide Block.....
50226c	6374	" " " " " Screw.....
50128c	6395	" " Screw.....
55044	6392	" Eccentric.....
103D	6385	" " Adjusting Screw.....
54865	6374	" " " " Friction Washer.....
55079	6392	Feed Eccentric Flange with two 440c....
440c	6385	" " " Adjusting Screw....
440c	6385	" " " Set Screw.....
103D	6385	" " Hinge Screw.....
54865	6374	" " " " Friction Washer.....
55080	6392	Feed Lifting Eccentric with 457c and 624c
624c	6392	" " " Position Screw....
457c	6390	" " " Set Screw.....
54952	6394	" " Lever.....

NO.	PLATE	NAME
54953	6394	Feed Lifting Lever Connecting Rod with 54940 and two 896E.....
*54940	—	Feed Lifting Lever Connecting Rod Cap 896E 6385
		Screw.....
50227c	6385	Feed Lifting Lever Connecting Rod Hinge Screw.....
1620E	6385	Feed Lifting Lever Connecting Rod Hinge Screw Nut.....
324c	6385	Feed Lifting Lever Screw Centre.....
54954	6374	" Regulating Lever.....
54955	6374	" " " Bracket.....
127E	6374	" " " " Screw.....
974c	6374	" " " Hinge Screw.....
54956	6374	" " " Spring.....
2269	6374	" " " Stop Pin.....
54957	6392	" Regulator.....
54958	6392	" " Friction Spring.....
55118	—	Feed Rod complete, Nos. 1722E, 54960, 54963 and 55078.....
54960	6394	Feed Rod (rod only).....
*54961	—	" " Cap.....
896E	6385	" " " Screw.....
*54962	—	" " End Bearing.....
54963	6394	Feed Rod Head, Nos. 54961, 54962 and two 896E.....
1722E	6391	Feed Rod Nut.....
54964	6367	Hand Wheel and Pulley, 2¼ in. diam., with 430c and 1299c.....
430c	6385	Hand Wheel and Pulley Set Screw (long).....
1299c	6385	" " " " " " (short).....
54965	6394	" " " " Shaft.....
54966	6394	" " " " " Bushing (left).....
54967	6384	Hand Wheel and Pulley Shaft Bushing (left) Oil Pad (braided cotton).....
888c	6385	Hand Wheel and Pulley Shaft Bushing (left) Set Screw.....
54968	6394	Hand Wheel and Pulley Shaft Bushing (right).....
54969	6384	Hand Wheel and Pulley Shaft Bushing (right) Oil Pad (braided cotton).....
895c	6385	Hand Wheel and Pulley Shaft Bushing (right) Set Screw.....
150D	6391	Hand Wheel and Pulley Shaft Screw.....
54970	6384	" " " " " Washer.....
55081	6393	Looper with 54707, for knit goods.....

NO.	PLATE	NAME
55148	6396	Looper with 54707, for sweater goods.....
54691	6393	" Carrier with 447c and two 185H.....
185H	6393	" " Adjusting Screw.....
54692	6392	" " Hinge Pin.....
620c	6385	" " " Set Screw.....
55082	6393	" " Holder with 620c and two 211E.....
211E	6392	Looper Carrier Holder Clamping Screw.....
54694	6392	" " Slide Block (two pieces) with 54695 and two 54705.....
*54695	—	Looper Carrier Slide Block Ball Stud.....
208D	6392	" " " " " Clamping Screw.....
54973	6392	Looper Carrier Slide Block Holder with 202D and 208D.....
202D	6392	Looper Carrier Slide Block Holder Clamping Screw.....
54705	6392	Looper Carrier Slide Block Pin.....
55083	6393	" Needle Guard.....
665D	6374	" " " Screw.....
54707	6393	" " " Steady Pin.....
447c	6385	" Set Screw.....
54708	6389	Needle Bar (hollow).....
54709	—	Needle Bar complete, Nos. 1449H, 54708 and 54714 to 54716.....
54710	6393	Needle Bar Bushing (lower).....
563c	6385	" " " " Set Screw.....
54974	6393	" " " (upper).....
563c	6385	" " " " Set Screw.....
54711	6393	" " Connecting Link.....
54712	6393	" " " " Hinge Stud.....
1520E	6390	" " " " " Nut.....
54713	6393	" " " Stud with 207E.....
207E	6390	" " " " Clamping Screw.....
54714	6393	Needle Clamp with two 209F.....
54715	6393	" " Thread Retainer.....
1449H	6393	" " " " Screw.....
54716	6393	" " " " Spring.....
209F	6393	" Set Screw.....
55084	6393	Presser Bar.....
54978	6393	" " Bushing.....
563c	6385	" " " Set Screw.....
125597	6393	" " Guide Bracket with 207D and 391D.....
391D	6385	Presser Bar Guide Bracket Adjusting Screw.....
207D	6390	" " " " Clamping Screw.....

NO.	PLATE	NAME
55085	6393	Presser Bar Guide Bracket Guide Bar....
446c	6385	" " " " " " Set Screw.....
54719	6395	Presser Bar Lifter.....
50228c	6395	" " " Hinge Screw.....
55087	6395	" " Lifting Bracket with 1492E...
1492e	6395	" " " " Clamping Screw.....
55009	6379	Presser Bar Spring (flat).....
54722	6384	" " " Stud.....
54723	6395	" Foot Hinge Block.....
26276	6384	" " " Pin.....
1080F	6395	" " " Screw.....
54724	—	" " Plate.....
54725	—	" " Shank.....
54726	6395	Presser Foot (double hinged) grooved on bottom, complete, Nos. 26276, 54723 to 54725 and two 1080F.....
190D	6385	Presser Foot Screw.....
50132D	6385	Pressure Regulating Thumb Screw.....
1543D	6385	" " " " Lock Nut.....
54728	6395	Seam Guide, for medium or heavy work...
202D	6392	" " Screw.....
55138	6396	Slack Thread Regulator with 662D, 54986, 55139 and two 39395.....
203C	6385	Slack Thread Regulator Screw.....
*55139	6396	" " " Section.....
39395	6396	" " " Rivet....
54985	6396	" " " Spring (heavy)...
55012	6396	" " " " (light)....
54732	6396	" " " " Bracket
203C	6385	" " " " " " Screw.....
1425D	6396	Slack Thread Regulator Spring Screw.....
54986	6396	" " " " Stop.....
662D	6396	" " " " " Screw
2102	6380	Tension (under thread) Disc.....
1560c	6380	" " " Regulating Thumb Nut.....
828c	6380	Tension (under thread) Screw Stud.....
10148	6380	" " " Spring.....
17547	6380	" " " Thread Guide....
54987	6380	" (upper thread) Bracket.....
376D	6380	" " " " Screw....
2102	6380	" " " Disc.....

NO.	PLATE	NAME
1560c	6380	Tension (upper thread) Regulating Thumb Nut.....
32572	6380	Tension (upper thread) Releasing Disc....
54988	6380	" " " " Pin.....
54989	6380	" " " " Shaft
54872	6396	" " " " " Crank with 624c.....
54873	6396	Tension (upper thread) Releasing Shaft Crank Link.....
110c	6385	Tension (upper thread) Releasing Shaft Crank Link Hinge Screw.....
624c	6392	Tension (upper thread) Releasing Shaft Crank Set Screw.....
54990	6380	Tension (upper thread) Releasing Shaft Spring.....
316F	6380	Tension (upper thread) Releasing Shaft Stop Screw.....
1547D	6380	Tension (upper thread) Releasing Shaft Stop Screw Nut.....
50133c	6380	Tension (upper thread) Screw Stud.....
54738	6380	" " " Spring.....
17547	6380	" " " Thread Guide....
55089	6396	Thread (under) Guard.....
337D	6396	" " " Screw.....
55090	6396	" " Nipper Bracket.....
190D	6385	" " " " Screw...
55091	6396	" " " Connecting Rod with 55092 and two 171E.....
*55092	—	Thread (under) Nipper Connecting Rod Cap.....
171E	6385	Thread (under) Nipper Connecting Rod Cap Screw.....
999F	6385	Thread (under) Nipper Connecting Rod Hinge Screw.....
1700E	6392	Thread (under) Nipper Connecting Rod Hinge Screw Nut.....
55093	6396	Thread (under) Nipper Eccentric with 465c.....
465c	6385	Thread (under) Nipper Eccentric Set Screw.....
54740	6396	Thread (under) Nipper Spring.....
233D	6385	" " " " Screw.....
55094	6397	" " Pull-off with 460c.....
460c	6385	" " " Set Screw.....
55150	6397	" " " Stripper.....
337D	6396	" " " " Screw...

NO.	PLATE	NAME
55096	6397	Thread (under) Pull-off Thread Guard with 220E.....
220E	6369	Thread (under) Pull-off Thread Guard Stop Screw.....
55097	6397	Thread (under) Pull-off Thread Guard and Thread (under) Take-up Thread Guard Holder.....
190D	6385	Thread (under) Pull-off Thread Guard and Thread (under) Take-up Thread Guard Holder Screw.....
55098	6397	Thread (under) Pull-off Thread Guard and Thread (under) Take-up Thread Guard Hinge Pin.....
55099	6397	Thread (under) Pull-off Thread Guard Spring.....
226D	6397	Thread (under) Pull-off Thread Guard Spring Screw.....
55100	6397	Thread (under) Take-up with 460C.....
55101	6397	" " " Eccentric with 440C.....
440C	6385	Thread (under) Take-up Eccentric Set Screw.....
460C	6385	Thread (under) Take-up Set Screw.....
55102	6397	" " " Shaft.....
50229C	6385	" " " " S c r e w Centre.....
462C	6385	Thread (under) Take-up Shaft Screw Centre Set Screw.....
55103	6397	Thread (under) Take-up Stripper.....
337D	6396	" " " " Screw....
55104	6397	" " " " Thread Guard with 220E.....
55105	6397	Thread (under) Take-up Thread Guard Spring.....
226D	6397	Thread (under) Take-up Thread Guard Spring Screw.....
220E	6369	Thread (under) Take-up Thread Guard Stop Screw.....
55106	6397	Thread (upper) Controller (left thread)...
55107	6397	" " " (right thread)...
54806	6397	" " " Lever.....
54879	6397	" " " " Connec- tion.....
999F	6385	Thread (upper) Controller Lever Connec- tion Hinge Screw.....
974D	6374	Thread (upper) Controller Lever Hinge Screw.....

NO.	PLATE	NAME
54758	6397	Thread (upper) Controller Post.....
743C	6397	" " " " Set Screw
219F	6385	" " " Screw.....
55108	6397	" " Take-up.....
330D	6397	" " " Screw.....
55109	6397	" " " Staple.....
1484F	6397	" " " " Screw.....
55110	6397	" " " Stripper.....
226D	6397	" " " " Screw...
54760	6389	" Tube.....
54773	-----	" " 54760 with 54772.....
54772	6397	" " Bracket.....
1484F	6397	" " " Screw.....
54761	6384	" " for 54927.....
55111	6395	Throat Plate with 54763, 54764 and two 229D, for 54672.....
1319F	6395	Throat Plate Screw.....
54763	6395	" " Guide (left).....
54764	6395	" " " (right).....
229D	6395	" " " Screw.....

IRON BASE

NO.	PLATE	NAME
54998	6367	Machine Base with three wood screws 1½ in. No. 12 and four each 935D, 42088 and 66707.....
42088	6384	Machine Cushion (felt).....
935D	6384	" " Screw.....
66707	6395	" " " Washer.....

ACCESSORIES

NO.	PLATE	NAME
1407J	5563	Machine Thumb Screw for 3 in. table....
1408J	5563	" " " " 2 in. table....
14063	6384	" " " Spring.....
9842	6384	" " " " Washer....
120344	6375	Oiler (copper plated) with 120345.....
120345	6375	" Spout, 5 in. long.....
26026	6375	Screw Driver (machine).....
26485	6375	" " (shuttle tension).....
120341	6375	Tweezers (curved).....
4822	6375	Wrench for 1547 and 1700.....
8908	6375	" " 1520, 1620, 1722 and 1723...
37051	6375	" " 50368.....

FOOT LIFTER PARTS

NO.	PLATE	NAME
6439	—	Chain, 36 in. to 45 in., with 56864 and 56865.....
NOTE: When ordering No. 6439, give length required.		
4879	6379	Chain Connecting Link.....
56864	6379	" Hook (large).....
56865	6379	" " (small).....
55112	6379	Lifting Lever.....
54767	6379	" " Extension.....
161D	6385	" " " Screw.....
866D	6385	" " Hinge Screw.....
4881	6367	Treadle.....
4882	6379	" Shaft.....
4883	6379	" Spring.....
4884	6367	" Stand.....
4885	6367	Treadle complete, Nos. 4879, 4881 to 4884 and two wood screws 1 in. No. 16.....
55113	—	Foot Lifter complete, Nos. 866D, 4885, 6439, 54767, 55112 and two 161D.....

THREAD UNWINDER

(FOR THREE SPOOLS)

NO.	PLATE	NAME
225389	7165	Spool Rest (for one spool) with 201018c...
225395	7165	" " (for two spools) with 201018c...
225388	7165	" " Rod.....
200383C	6391	" " " Set Screw.....
201018C	6391	" " Set Screw.....
202490	7165	" Stand with 200383c.....
225391	7165	Thread Guide.....
201696J	6391	" " Lock Nut.....
225392	7165	" " Rod with 208E and 225393...
208E	6392	" " " Screw.....
225393	6391	" " " Washer.....
225397	7165	Thread Unwinder complete, Nos. 201696J, 202490, 225388, 225389, 225392, 225395 and three each 225391 and wood screws 1/8 in. No. 13.....
27739	7234	Thread Cone (wood) for large cones.....
225390	7234	" " Holder, for inverted cones...

NOTE: Nos. 27739 and 225390 are used with, but not included in, 225397.

OBSOLETE PARTS

NO.	PLATE	NAME
55086	6393	Presser Bar Guide Bracket with 207D and 453C.....
453C	6385	Presser Bar Guide Bracket Set Screw.....
55088	6396	Slack Thread Regulator with 662D and 54986, use 55138.....
55095	6397	Thread (under) Pull-off Stripper, use 55150.....

NUMERICAL LIST OF PARTS

FOR

MACHINE No. 86-3

NUMERICAL LIST OF PARTS

NO.	PLATE	NAME
103D	6385	Cylinder Rock Shaft (lower) Eccentric Hinge Screw
103D	6385	Feed Eccentric Adjusting Screw
103D	6385	" " Hinge Screw
110C	6385	Tension (upper thread) Releasing Shaft Crank Link Hinge Screw
127E	6374	Feed Regulating Lever Bracket Screw
134D	6385	Belt Cover Screw
134D	6385	Cylinder Screw
150D	6391	Hand Wheel and Pulley Shaft Screw
161D	6385	Lifting Lever Extension Screw for 55113
171E	6385	Crank Connecting Rod Cap (upper) Screw for 55033
171E	6385	Cylinder Rock Shaft (lower) Eccentric Connecting Rod Cap Screw for 54931
171E	6385	Cylinder Rock Shaft (upper) Eccentric Connecting Rod Cap (lower) Screw for 55066
171E	6385	Thread (under) Nipper Connecting Rod Cap Screw for 55091
185H	6393	Looper Carrier Adjusting Screw for 54691
189D	6385	Cylinder End Cover Lock Spring Cap Screw
190D	6385	Presser Foot Screw
190D	6385	Thread (under) Nipper Bracket Screw
190D	6385	" " Pull-off Thread Guard and Thread (under) Take-up Thread Guard Holder Screw
202D	6392	Looper Carrier Slide Block Holder Clamping Screw for 54973
202D	6392	Seam Guide Screw for 54622
203C	6385	Slack Thread Regulator Screw
203C	6385	" " " Spring Bracket Screw
203F	6385	Face Plate Screw
207E	6390	Cylinder Rock Shaft (lower) Eccentric Connecting Rod Stud Clamping Screw for 54933
207E	6390	Needle Bar Connecting Stud Clamping Screw for 54713
207D	6390	Presser Bar Guide Bracket Clamping Screw for 55086 and 125597

NUMERICAL LIST OF PARTS

FOR

MACHINE No. 88-3

NO. PLATE	NAME
208D 6392	Looper Carrier Slide Block Ball Stud Clamping Screw for 54973.....
208E 6392	Thread Unwinder Thread Guide Rod Screw for 225392.....
209F 6393	Needle Set Screw for 54714.....
211E 6392	Looper Carrier Holder Clamping Screw for 55082.....
219D 6385	Cloth Plate Spring Screw for 54890.....
219F 6385	Crank Connecting Rod Position Plate Screw for 55146.....
219F 6385	Cylinder Rock Shaft (upper) Eccentric Connecting Rod Position Plate Screw..
219F 6385	Thread (upper) Controller Screw.....
220E 6369	" (under) Pull-off Thread Guard Stop Screw for 55096.....
220E 6369	Thread (under) Take-up Thread Guard Stop Screw for 55104.....
226D 6397	Thread (under) Pull-off Thread Guard Spring Screw.....
226D 6397	Thread (under) Take-up Thread Guard Spring Screw.....
226D 6397	Thread (upper) Take-up Stripper Screw..
229D 6395	Throat Plate Guide Screw for 55111.....
233D 6385	Thread (under) Nipper Spring Screw....
237D 6369	Cloth Plate Spring Guide Screw for 54890
286D 6385	Arm Side Cover Thumb Screw.....
316F 6380	Tension (upper thread) Releasing Shaft Stop Screw.....
324C 6385	Feed Lifting Lever Screw Centre.....
330D 6397	Thread (upper) Take-up Screw.....
337D 6396	" (under) Guard Screw.....
337D 6396	" " Pull-off Stripper Screw...
337D 6396	" " Take-up Stripper Screw..
345C 6369	Cloth Plate Bracket Screw for 54887.....
376D 6380	Tension (upper thread) Bracket Screw...
391D 6385	Cylinder Top Cover (front) Screw for 54927.....
391D 6385	Presser Bar Guide Bracket Adjusting Screw for 125597.....
430C 6385	Hand Wheel and Pulley Set Screw (long) for 54964.....
440C 6385	Feed Eccentric Flange Adjusting Screw for 55079.....
440C 6385	Feed Eccentric Flange Set Screw for 55079
440C 6385	Thread (under) Take-up Eccentric Set Screw for 55101.....

NO. PLATE	NAME
446C 6385	Cylinder Rock Shaft (upper) Eccentric Connecting Rod Lever Hinge Stud Set Screw.....
446C 6385	Presser Bar Guide Bracket Guide Bar Set Screw.....
447C 6385	Cylinder Rock Shaft (lower) Bushing Set Screw.....
447C 6385	Looper Set Screw for 54691.....
453C 6385	Presser Bar Guide Bracket Set Screw for 55086, obsolete.....
456C 6385	Arm Rock Shaft Collar Set Screw for 54921.....
457C 6390	Cylinder Rock Shaft (upper) Crank Set Screw for 54632.....
457C 6390	Cylinder Rock Shaft (upper) Eccentric Set Screw for 55076.....
457C 6390	Feed Lifting Eccentric Set Screw for 55080
460C 6385	Cylinder Top Cover (back) Hinge Pin Set Screw for 54927.....
460C 6385	Thread (under) Pull-off Set Screw for 55094.....
460C 6385	Thread (under) Take-up Set Screw for 55100.....
462C 6385	Feed Dog Carrier Set Screw for 55078...
462C 6385	Thread (under) Take-up Shaft Screw Centre Set Screw.....
465C 6385	Cylinder Rock Shaft (upper) Collar Set Screw for 54934.....
465C 6385	Thread (under) Nipper Eccentric Set Screw for 55093.....
563C 6385	Needle Bar Bushing (lower) Set Screw....
563C 6385	" " " (upper) Set Screw....
563C 6385	Presser Bar Bushing Set Screw.....
620C 6385	Looper Carrier Hinge Pin Set Screw for 55082.....
624C 6392	Cylinder Rock Shaft (upper) Eccentric Position Screw for 55076.....
624C 6392	Feed Lifting Eccentric Position Screw for 55080.....
624C 6392	Tension (upper thread) Releasing Shaft Crank Set Screw for 54872.....
662D 6396	Slack Thread Regulator Spring Stop Screw for 55088 and 55138.....
665D 6374	Cylinder Top Cover (front) Spring Screw for 54944.....
665D 6374	Looper Needle Guard Screw.....
743C 6397	Thread (upper) Controller Post Set Screw

NO.	PLATE	NAME
767D	6385	Cylinder Thread Cover Screw.....
828c	6380	Tension (under thread) Screw Stud.....
866D	6385	Lifting Lever Hinge Screw for 55113.....
888c	6385	Arm Rock Shaft Bushing (front) Set Screw
888c	6385	Hand Wheel and Pulley Shaft Bushing (left) Set Screw.....
895c	6385	Hand Wheel and Pulley Shaft Bushing (right) Set Screw.....
896E	6385	Crank Connecting Rod Cap (lower) Screw for 54616.....
896E	6385	Cylinder Rock Shaft (upper) Eccentric Connecting Rod Cap (upper) Screw for 55066.....
896E	6385	Feed Lifting Lever Connecting Rod Cap Screw for 54953.....
896E	6385	Feed Rod Cap Screw for 54963.....
911E	6369	Arm Back Cover Latch Screw Stud for 54915.....
935D	6384	Machine Cushion Screw for 54998.....
974c	6374	Feed Regulating Lever Hinge Screw.....
974D	6374	Thread (upper) Controller Lever Hinge Screw.....
978F	6391	Cylinder End Cover Slide Block Stop Screw.....
999F	6385	Thread (under) Nipper Connecting Rod Hinge Screw.....
999F	6385	Thread (upper) Controller Lever Conne- ction Hinge Screw.....
1080F	6395	Presser Foot Hinge Screw for 54726.....
1120c	6392	Cylinder Rock Shaft (upper) Eccentric Connecting Rod Ball Stud Set Screw for 55077.....
1299c	6385	Hand Wheel and Pulley Set Screw (short) for 54964.....
1319F	6395	Throat Plate Screw.....
1407J	5563	Machine Thumb Screw for 3 in. table (Ac- cessories).....
1408J	5563	Machine Thumb Screw for 2 in. table (Ac- cessories).....
1425D	6396	Slack Thread Regulator Spring Screw.....
1443D	6385	Arm Back Cover Spring Screw for 54914..
1449H	6393	Needle Clamp Thread Retainer Screw for 54709.....
1484F	6397	Thread (upper) Take-up Staple Screw....
1484F	6397	“ Tube Bracket Screw.....
1492E	6395	Presser Bar Lifting Bracket Clamping Screw for 55087.....

NO.	PLATE	NAME
1520E	6390	Crank Connecting Rod Ball Screw Stud Nut.....
1520E	6390	Needle Bar Connecting Link Hinge Stud Nut.....
1538D	6369	Arm Back Cover Latch Screw Stud Thumb Nut for 54914.....
1543D	6385	Pressure Regulating Thumb Screw Lock Nut.....
1547D	6380	Tension (upper thread) Releasing Shaft Stop Screw Nut.....
1560c	6380	Tension (under thread) Regulating Thumb Nut.....
1560c	6380	Tension (upper thread) Regulating Thumb Nut.....
1620E	6385	Feed Lifting Lever Connecting Rod Hinge Screw Nut.....
1700E	6392	Cylinder Rock Shaft (upper) Eccentric Connecting Rod Ball Stud Set Screw Nut for 55077.....
1700E	6392	Thread (under) Nipper Connecting Rod Hinge Screw Nut.....
1722E	6391	Crank Connecting Rod Nut (lower) for 55146.....
1722E	6391	Feed Rod Nut for 55118.....
1723E	6391	Crank Connecting Rod Nut (upper) for 55146.....
2102	6380	Tension (under thread) Disc.....
2102	6380	“ (upper thread) Disc.....
2269	6374	Feed Regulating Lever Stop Pin.....
2827	6392	Face Plate Thread Guard with 8505, for 54945.....
4621	6369	Cloth Plate Spring Packing Rivet for 54885.....
4822	6375	Wrench for 1547 and 1700 (Accessories)...
4879	6379	Chain Connecting Link for 4885.....
Nos. 4881 TO 4884 FOR 4885		
4881	6367	Treadle.....
4882	6379	“ Shaft.....
4883	6379	“ Spring.....
4884	6367	“ Stand.....
4885	6367	Treadle complete for 55113, Nos. 4879, 4881 to 4884 and two wood screws 1 in. No. 16.....
6439	—	Chain, 36 in. to 45 in., with 56864 and 56865, for 55113.....
8505	6392	Face Plate Thread Guard Rivet for 2827..

NO.	PLATE	NAME
8908	6375	Wrench for 1520, 1620, 1722 and 1723 (Accessories).....
9842	6384	Machine Thumb Screw Spring Washer (Accessories).....
10148	6380	Tension (under thread) Spring.....
14063	6384	Machine Thumb Screw Spring (Accessories)
17547	6380	Tension (under thread) Thread Guide...
17547	6380	" (upper thread) Thread Guide...
26026	6375	Screw Driver, machine (Accessories).....
26276	6384	Presser Foot Hinge Pin for 54726.....
26485	6375	Screw Driver, shuttle tension (Accessories)
27739	7234	Thread Unwinder Thread Cone (wood) for large cones, for 225397.....
32572	6380	Tension (upper thread) Releasing Disc...
37051	6375	Wrench for 50368 (Accessories).....
39395	6396	Slack Thread Regulator Section Rivet for 55138.....
42088	6384	Machine Cushion (felt) for 54998.....
46111	6384	Face Plate Pin.....
50128c	6395	Feed Dog Screw.....
50132d	6385	Pressure Regulating Thumb Screw.....
50133c	6380	Tension (upper thread) Screw Stud.....
50135c	6390	Arm Rock Shaft Crank (back) Set Screw for 54603.....
50135c	6390	Arm Rock Shaft Crank (front) Set Screw for 54604.....
50217d	6369	Cloth Plate Screw for 54891.....
50218c	6369	" " Spring Lock Screw for 54890...
50223d	6385	Arm Back Cover Latch Hinge Screw for 54914.....
50224c	6385	Arm Rock Shaft Bushing (back) Set Screw
50225d	6385	Cylinder Rock Shaft (lower) Eccentric Adjusting Screw.....
50226c	6374	Feed Dog Carrier Slide Block Screw.....
50227c	6385	" Lifting Lever Connecting Rod Hinge Screw.....
50228c	6395	Presser Bar Lifter Hinge Screw.....
50229c	6385	Thread (under) Take-up Shaft Screw Centre.....
50368c	6390	Crank Connecting Rod Ball Screw Stud for 55033.....
54603	6390	Arm Rock Shaft Crank (back) with two 50135c.....
54604	6390	Arm Rock Shaft Crank (front) with two 50135c.....
*54612	—	Crank Connecting Rod Cap (lower) for 54616.....

NO.	PLATE	NAME
*54613	—	Crank Connecting Rod Cap (upper) for 55033.....
*54614	—	Crank Connecting Rod End Bearing (lower) for 54616.....
*54616	—	Crank Connecting Rod Head (lower) for 55146, Nos. 54612, 54614 and two 896e
54620	6384	Cylinder Dowel Pin.....
54621	6389	" End Cover for 54622.....
54622	—	Cylinder End Cover complete, Nos. 202n, 54621, 54728, 125599 and two 54628...
54624	6369	Cylinder End Cover Lock Spring Cap.....
*54625	—	" " " " Slide (back) for 125599
*54626	—	" " " " (front) for 125599
54627	6390	" " " " Hinge Pin for 125599.....
54628	6384	Cylinder End Cover Slide Rivet for 54622
54630	6389	" Rock Shaft (upper).....
54632	6390	" " " " Crank with two 457c.....
54643	6384	Cylinder Oil Tube for 54927.....
54662	6374	" Thread Cover.....
54664	6384	" Top Cover (back) Hinge Pin for 54927.....
54666	6374	Cylinder Top Cover (front) Spring for 54944.....
54672	6395	Feed Dog (12 teeth) 16 teeth to the inch
54691	6393	Looper Carrier with 447c and two 185u...
54692	6392	" " Hinge Pin.....
54694	6392	" " Slide Block (two pieces) with 54695 and two 54705.....
*54695	—	Looper Carrier Slide Block Ball Stud for 54694.....
54704	6390	Cylinder Rock Shaft (lower) Key for 55074
54705	6392	Looper Carrier Slide Block Pin for 54694...
54707	6393	" Needle Guard Steady Pin for 55081
54708	6389	Needle Bar (hollow) for 54709.....
54709	—	Needle Bar complete, Nos. 1449n, 54708 and 54714 to 54716.....
54710	6393	Needle Bar Bushing (lower).....
54711	6393	" " Connecting Link.....
54712	6393	" " " " Hinge Stud
54713	6393	" " " " Stud with 207e...
54714	6393	" Clamp with two 209f, for 54709...
54715	6393	" " Thread Retainer for 54709
54716	6393	" " " " Spring for 54709.....

NUMERICAL LIST OF PARTS

NO.	PLATE	NAME
54719	6395	Presser Bar Lifter.....
54722	6384	" " Spring Stud.....
54723	6395	" Foot Hinge Block for 54726.....
54724	—	" " Plate for 54726.....
54725	—	" " Shank for 54726.....
54726	6395	Presser Foot (double hinged) grooved on bottom, complete, Nos. 26276, 54723 to 54725 and two 1080f.....
54728	6395	Seam Guide, for medium or heavy work, for 54622.....
54732	6396	Slack Thread Regulator Spring Bracket.....
54738	6380	Tension (upper thread) Spring.....
54740	6396	Thread (under) Nipper Spring.....
54758	6397	" (upper) Controller Post.....
54760	6389	" Tube for 54773.....
54761	6384	" " " 54927.....
54763	6395	Throat Plate Guide (left) for 55111.....
54764	6395	" " " (right) for 55111.....
54767	6379	Lifting Lever Extension for 55113.....
54772	6397	Thread Tube Bracket for 54773.....
54773	—	" " 54760 with 54772.....
54806	6397	" (upper) Controller Lever.....
54865	6374	Feed Eccentric Adjusting Screw Friction Washer.....
54865	6374	Feed Eccentric Hinge Screw Friction Washer.....
54872	6396	Tension (upper thread) Releasing Shaft Crank with 624c.....
54873	6396	Tension (upper thread) Releasing Shaft Crank Link.....
54879	6397	Thread (upper) Controller Lever Connection.....
54885	6367	Cloth Plate (left) with 54889 and two 4621, for 54890.....
54886	6367	Cloth Plate (right) for 54890.....
54887	6367	" " Bracket with 345c, for 54891.....
54888	6369	" " Spring for 54890.....
*54889	6369	" " " Packing for 54885.....
54890	—	Cloth Plate complete for 54891, Nos. 219d, 237d, 50218c, 54885, 54886 and 54888.....
54891	—	Cloth Plate with Bracket complete, Nos. 54887, 54890 and two 50217d.....
54897	6384	Arm Oil Cup.....
54913	6367	" Back Cover for 54914.....
54914	—	Arm Back Cover complete, Nos. 1538d, 50223d, 54913, 54915, 54916 and two 1443d.....

NUMERICAL LIST OF PARTS

NO	PLATE	NAME
54915	6369	Arm Back Cover Latch with 911e, for 54914.....
54916	6369	Arm Back Cover Spring for 54914.....
54917	6384	" Oil Tube for oiling 55077.....
54919	6369	" Rock Shaft Bushing (back).....
54920	6369	" " " " (front).....
54921	6390	" " " Collar with two 456c.....
54923	6367	Belt Cover.....
*54925	—	Crank Connecting Rod (rod only) for 55146.....
*54927	—	Cylinder with 460c, 54643, 54664, 54943, 54944 and two 391d.....
54929	6369	Cylinder Rock Shaft (lower) Bushing.....
54931	6390	" " " " Eccentric Connecting Rod with 54932 and two 171e.....
*54932	—	Cylinder Rock Shaft (lower) Eccentric Connecting Rod Cap for 54931.....
54933	6390	Cylinder Rock Shaft (lower) Eccentric Connecting Rod Stud with 207e.....
54934	6390	Cylinder Rock Shaft (upper) Collar with two 465c.....
54935	6390	Cylinder Rock Shaft (upper) Crank Connecting Link.....
*54939	—	Cylinder Rock Shaft (upper) Eccentric Connecting Rod Cap (lower) for 55066.....
*54940	—	Cylinder Rock Shaft (upper) Eccentric Connecting Rod Cap (upper) for 55066.....
*54940	—	Feed Lifting Lever Connecting Rod Cap for 54953.....
54942	6374	Cylinder Rock Shaft (upper) Eccentric Connecting Rod Lever Hinge Stud.....
*54943	—	Cylinder Top Cover (back) for 54927.....
*54944	—	" " " (front) with 665d and 54666, for 54927.....
54945	6389	Face Plate with two 2827.....
54947	6374	Feed Dog Adjusting Wedge.....
54949	6374	" " Carrier Slide Block.....
54952	6394	" Lifting Lever.....
54953	6394	" " " Connecting Rod with 54940 and two 896e.....
54954	6374	Feed Regulating Lever.....
54955	6374	" " " Bracket.....
54956	6374	" " " Spring.....
54957	6392	" Regulator.....
54958	6392	" " Friction Spring.....
54960	6394	" Rod (rod only) for 55118.....

NO.	PLATE	NAME
*54961	—	Feed Rod Cap for 54963.....
*54962	—	“ “ End Bearing for 54963.....
54963	6394	Feed Rod Head for 55118, Nos. 54961, 54962 and two 896E.....
54964	6367	Hand Wheel and Pulley, 2¼ in. diam., with 430c and 1299c.....
54965	6394	Hand Wheel and Pulley Shaft.....
54966	6394	“ “ “ “ “ Bushing (left).....
54967	6384	Hand Wheel and Pulley Shaft Bushing (left) Oil Pad (braided cotton).....
54968	6394	Hand Wheel and Pulley Shaft Bushing (right).....
54969	6384	Hand Wheel and Pulley Shaft Bushing (right) Oil Pad (braided cotton).....
54970	6384	Hand Wheel and Pulley Shaft Washer....
54973	6392	Looper Carrier Slide Block Holder with 202b and 208b.....
54974	6393	Needle Bar Bushing (upper).....
54978	6393	Presser Bar Bushing.....
54985	6396	Slack Thread Regulator Spring (heavy)....
54986	6396	“ “ “ “ “ Stop for 55088 and 55138.....
54987	6380	Tension (upper thread) Bracket.....
54988	6380	“ “ “ Releasing Pin....
54989	6380	“ “ “ “ Shaft
54990	6380	“ “ “ “ “ Spring.....
54998	6367	Machine Base with three wood screws 1½ in. No. 12 and four each 935b, 42088 and 66707.....
55009	6379	Presser Bar Spring (flat).....
55012	6396	Slack Thread Regulator Spring (light)....
*55032	—	Crank Connecting Rod End Bearing (upper) for 55033.....
*55033	—	Crank Connecting Rod Head (upper) for 55146, Nos. 50368c, 54613, 55032 and two 171E.....
55034	6390	Crank Connecting Rod Position Plate for 55146.....
55034	6390	Cylinder Rock Shaft (upper) Eccentric Connecting Rod Position Plate.....
55044	6392	Feed Eccentric.....
55066	6394	Cylinder Rock Shaft (upper) Eccentric Connecting Rod with 54939, 54940 and two each 171E and 896E.....

NO.	PLATE	NAME
55067	6392	Cylinder Rock Shaft (upper) Eccentric Connecting Rod Ball Stud.....
*55072	—	Arm.....
55073	6389	“ Rock Shaft.....
55074	6389	Cylinder Rock Shaft (lower) with 54704....
55075	6390	“ “ “ “ Eccentric....
55076	6392	“ “ “ (upper) Eccentric with 457c and 624c.....
55077	6393	Cylinder Rock Shaft (upper) Eccentric Connecting Rod Lever with 1120c and 1700E.....
55078	6392	Feed Dog Carrier with two 462c, for 55118
55079	6392	“ Eccentric Flange with two 440c....
55080	6392	“ Lifting Eccentric with 457c and 624c
55081	6393	Looper with 54707, for knit goods.....
55082	6393	“ Carrier Holder with 620c and two 211E.....
55083	6393	Looper Needle Guard.....
55084	6393	Presser Bar.....
55085	6393	“ “ Guide Bracket Guide Bar....
55086	6393	“ “ “ “ with 207b and 453c, obsolete.....
55087	6395	Presser Bar Lifting Bracket with 1492E...
55088	6396	Slack Thread Regulator with 662b and 54986, obsolete, use 55138.....
55089	6396	Thread (under) Guard.....
55090	6396	“ “ Nipper Bracket.....
55091	6396	“ “ “ Connecting Rod with 55092 and two 171E.....
*55092	—	Thread (under) Nipper Connecting Rod Cap for 55091.....
55093	6396	Thread (under) Nipper Eccentric with 465c.....
55094	6397	Thread (under) Pull-off with 460c.....
55095	6397	“ “ “ Stripper, obsolete, use 55150.....
55096	6397	Thread (under) Pull-off Thread Guard with 220E.....
55097	6397	Thread (under) Pull-off Thread Guard and Thread (under) Take-up Thread Guard Holder.....
55098	6397	Thread (under) Pull-off Thread Guard and Thread (under) Take-up Thread Guard Hinge Pin.....
55099	6397	Thread (under) Pull-off Thread Guard Spring.....

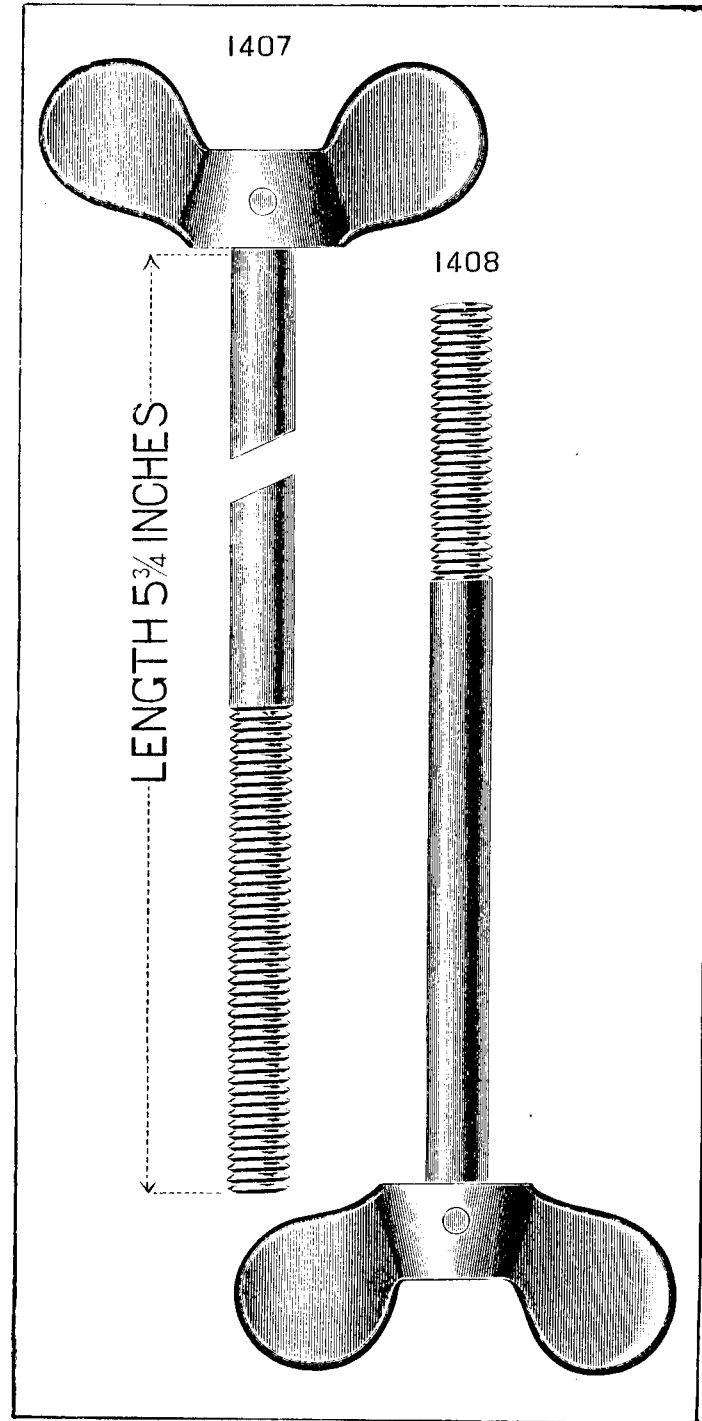
NO.	PLATE	NAME
55100	6397	Thread (under) Take-up with 460c.....
55101	6397	“ “ “ Eccentric with 440c.....
55102	6397	Thread (under) Take-up Shaft.....
55103	6397	“ “ “ Stripper.....
55104	6397	“ “ “ Thread Guard with 220E.....
55105	6397	Thread (under) Take-up Thread Guard Spring.....
55106	6397	Thread (upper) Controller (left thread)...
55107	6397	“ “ “ (right thread)...
55108	6397	“ “ Take-up.....
55109	6397	“ “ Staple.....
55110	6397	“ “ Stripper.....
55111	6395	Throat Plate with 54763, 54764 and two 229D, for 54672.....
55112	6379	Lifting Lever for 55113.....
55113	—	Foot Lifter complete, Nos. 866D, 4885, 6439, 54767, 55112 and two 161D.....
55118	—	Feed Rod complete, Nos. 1722E, 54960, 54963 and 55078.....
55138	6396	Slack Thread Regulator with 662D, 54986, 55139 and two 39395.....
*55139	6396	Slack Thread Regulator Section for 55138
55146	6389	Crank Connecting Rod complete, Nos. 219F, 1722E, 1723E, 54616, 54925, 55033 and 55034.....
55148	6396	Looper with 54707, for sweater goods....
55150	6397	Thread (under) Pull-off Stripper.....
55151	6390	Cylinder End Cover Lock Spring.....
56016	6389	Arm Side Cover.....
56864	6379	Chain Hook (large) for 6439.....
56865	6379	“ “ (small) for 6439.....
66707	6395	Machine Cushion Screw Washer for 54998
120341	6375	Tweezers, curved (Accessories).....
120344	6375	Oiler (copper plated) with 120345 (Acces- sories).....
120345	6375	Oiler Spout, 5 in. long, for 120344.....
125597	6393	Presser Bar Guide Bracket with 207D and 391D.....
125599	6390	Cylinder End Cover Slide (back) 54625 with 54626 and 54627, for 54622.....
200383c	6391	Thread Unwinder Spool Rest Rod Set Screw for 202490.....
201018c	6391	Thread Unwinder Spool Rest Set Screw for 225389 and 225395.....

NO.	PLATE	NAME
201696J	6391	Spool Unwinder Thread Guide Lock Nut for 225397.....
202490	7165	Thread Unwinder Spool Stand with 200383c, for 225397.....
225388	7165	Thread Unwinder Spool Rest Rod for 225397.....
225389	7165	Thread Unwinder Spool Rest (for one spool) with 201018c, for 225397.....
225390	7234	Thread Unwinder Thread Cone Holder, for inverted cones, for 225397.....
225391	7165	Thread Unwinder Thread Guide for 225397
225392	7165	“ “ “ “ Rod with 208E and 225393, for 225397.....
225393	6391	Thread Unwinder Thread Guide Rod Washer for 225392.....
225395	7165	Thread Unwinder Spool Rest (for two spools) with 201018c, for 225397.....
225397	7165	Thread Unwinder complete, Nos. 201696J, 202490, 225388, 225389, 225392, 225395 and three each 225391 and wood screws 7/8 in. No. 13.....

ILLUSTRATIONS OF PARTS

FOR

MACHINE No. 86-3



ILLUSTRATIONS OF PARTS

FOR

MACHINE NO. 86-3

PLATE 6367—ONE-FOURTH SIZE

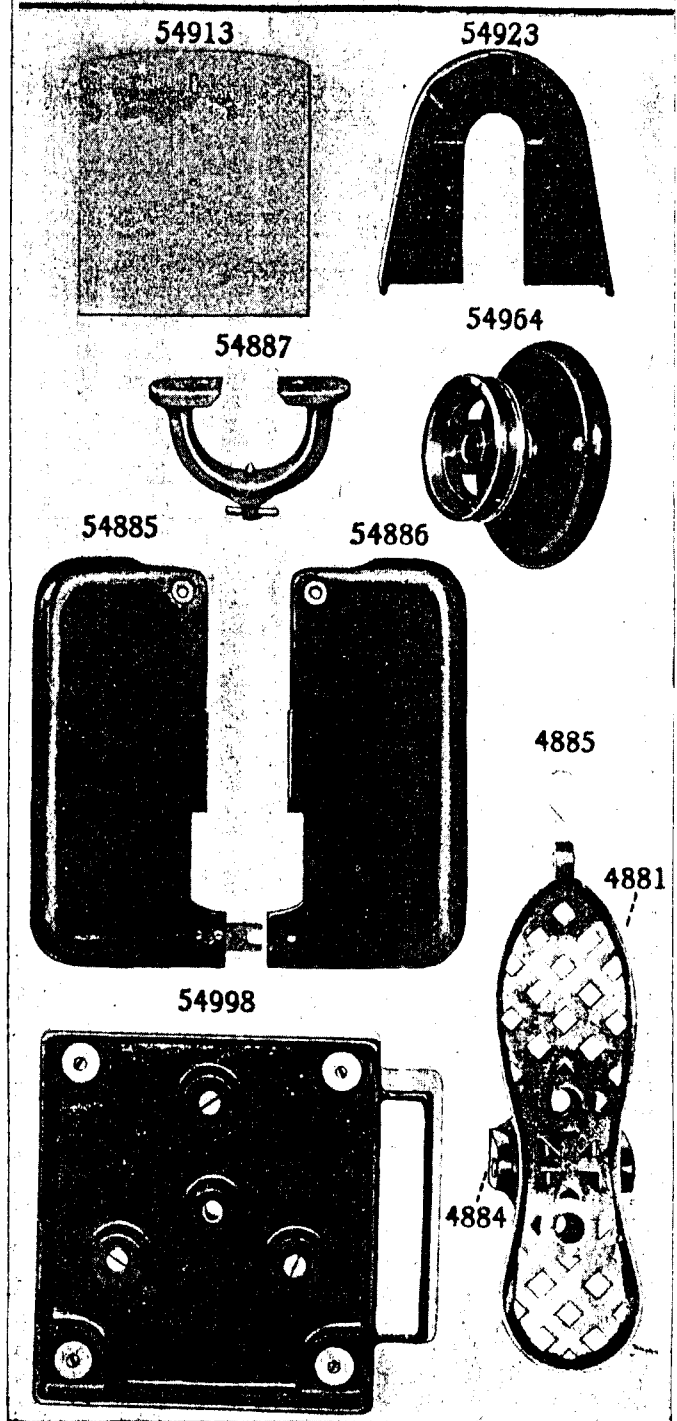


PLATE 6369—FULL SIZE

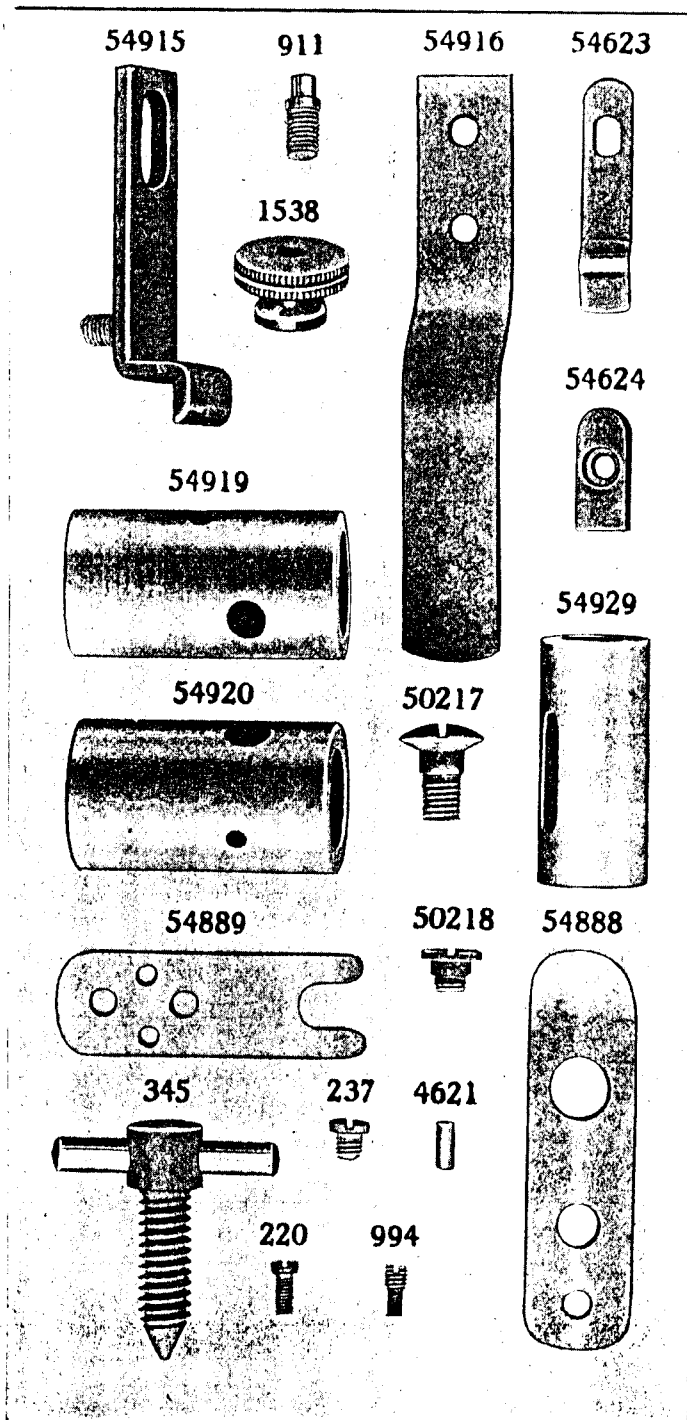


PLATE 6374—FULL SIZE

54942



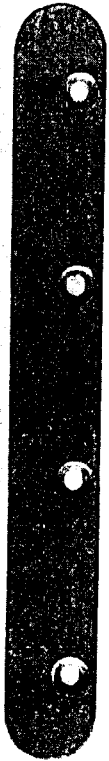
54671



54947



54662



54666



50226



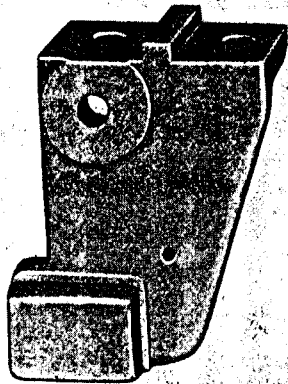
665



54949



54955



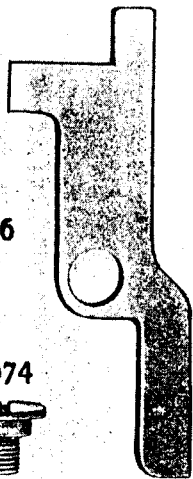
54865



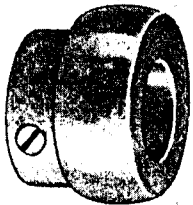
127



54954



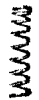
54951



2269



54956

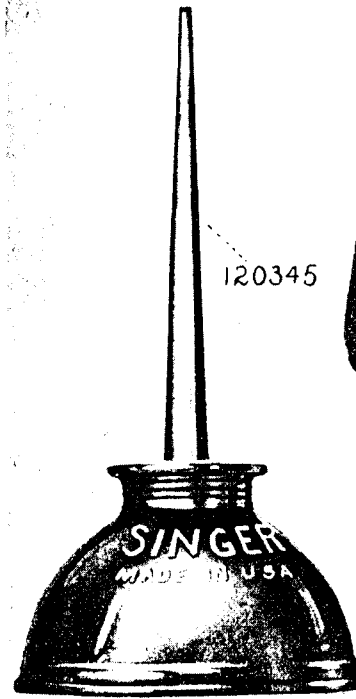


974



PLATE 6375—ONE-HALF SIZE

120344

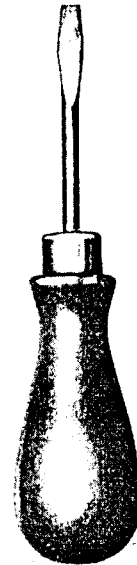


120345

26485



26026



37051

120341



8908



4822

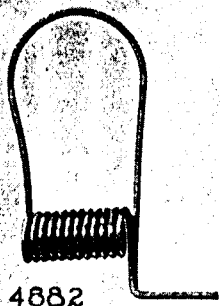
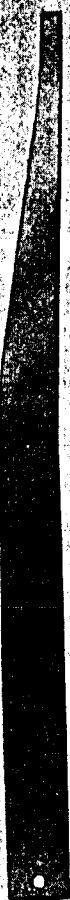


PLATE 6379—ONE-HALF SIZE

55009 54767

4883

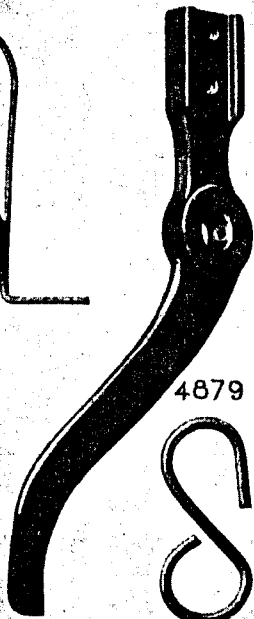
55112



4882



56864



4879

56865



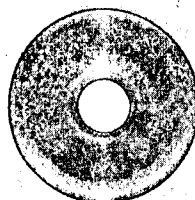
PLATE 6380—FULL SIZE

2102

828

916

1560



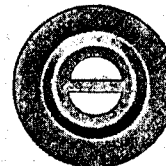
1547



10148



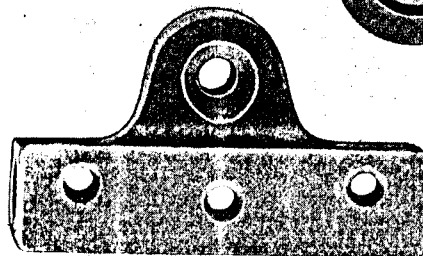
32572



54988



54987



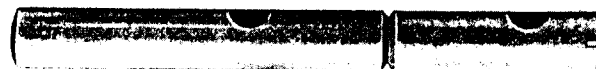
376



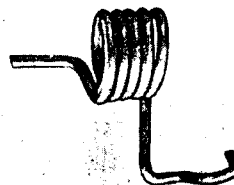
316



54989



54990



50133



17547

54738

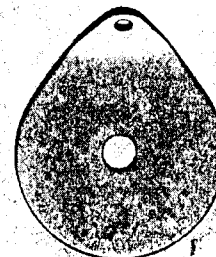


PLATE 6384--FULL SIZE

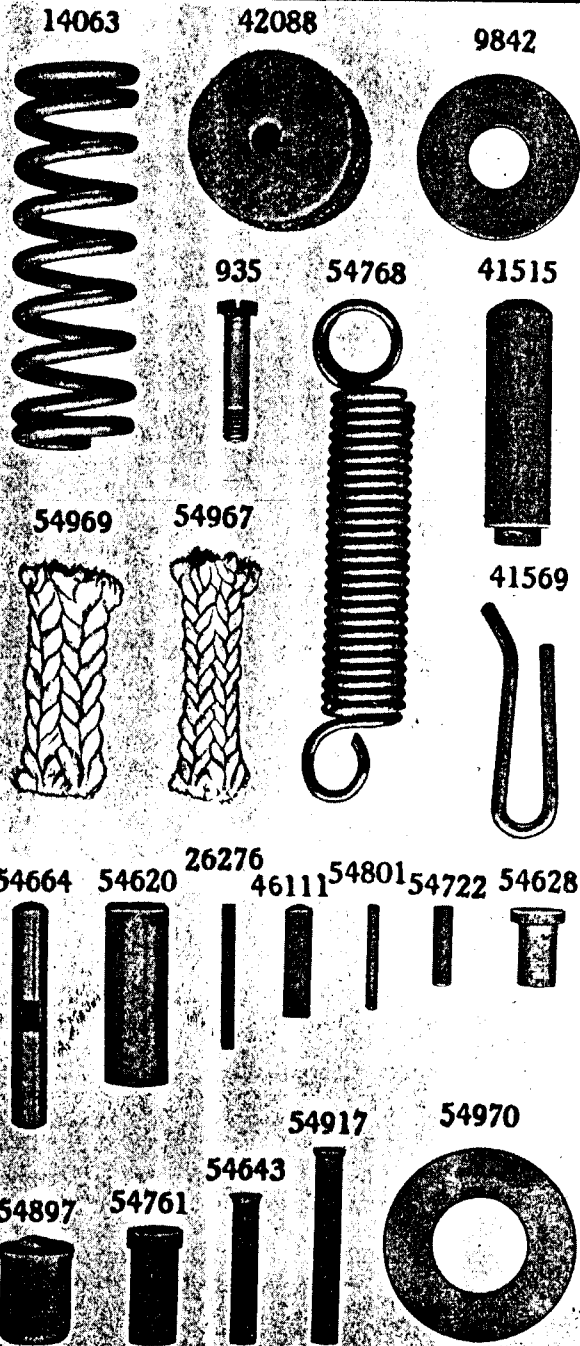


PLATE 6385--FULL SIZE

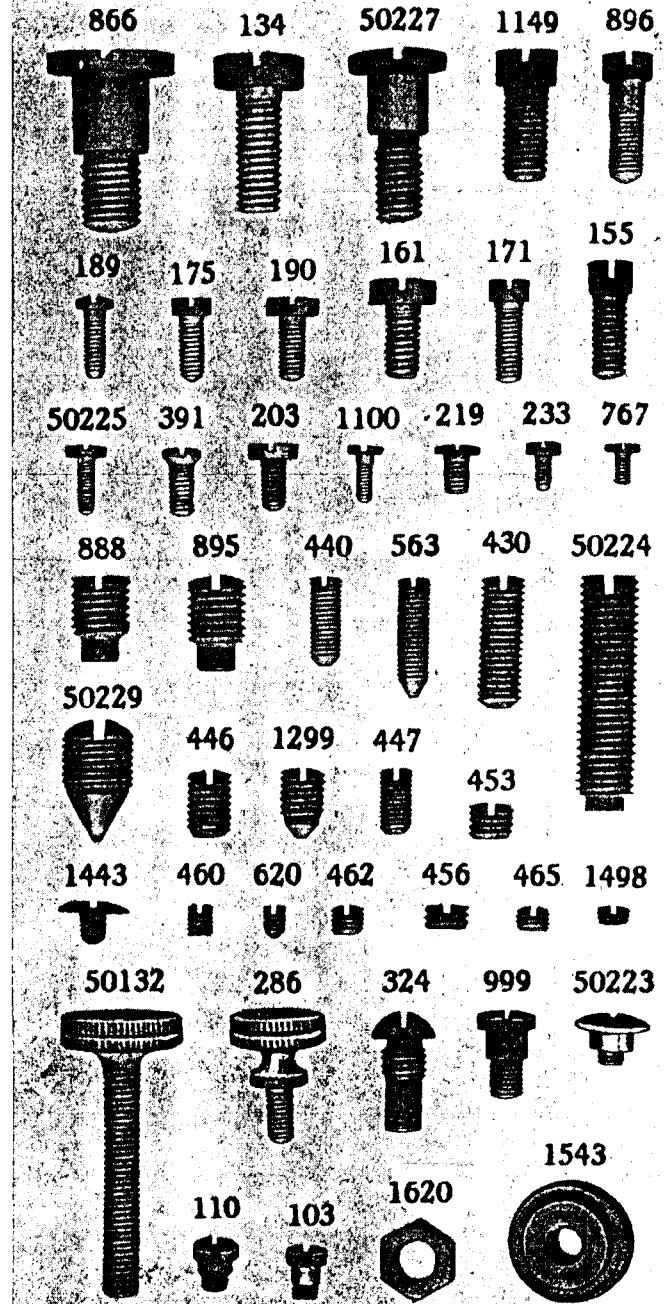


PLATE 6389—ONE-HALF SIZE

55073 54630 55074 54708 54760

54945

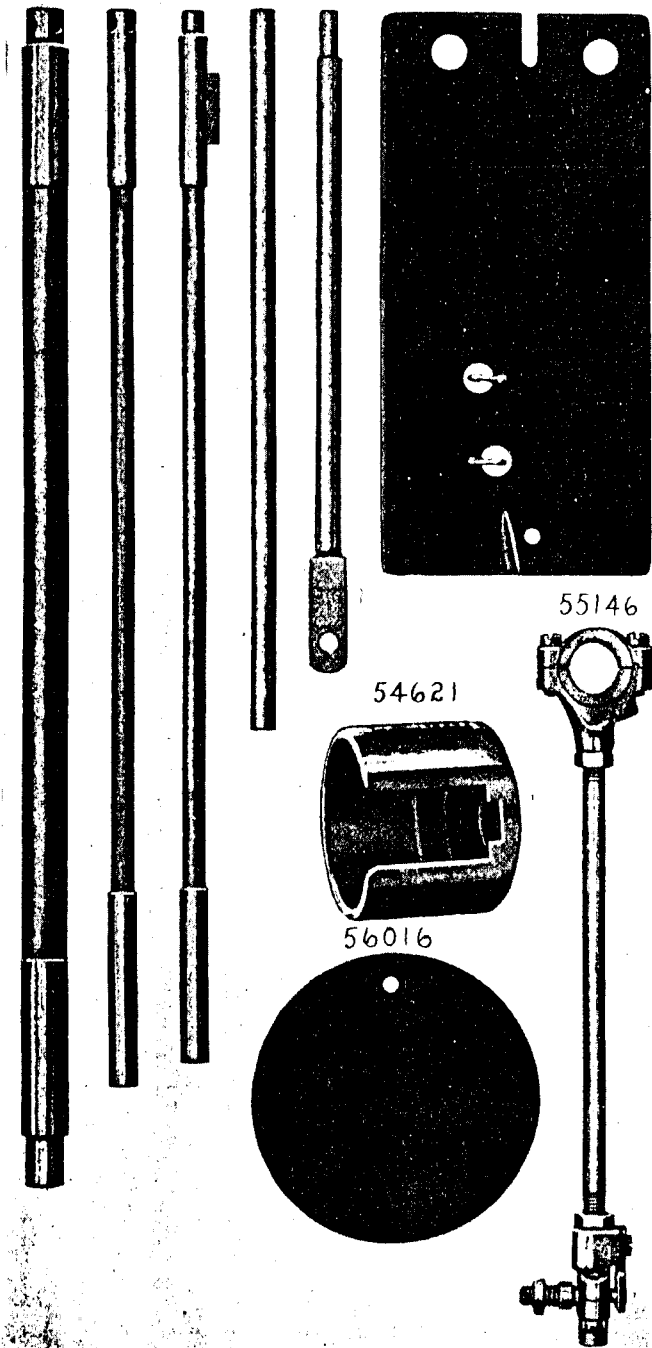


PLATE 6390—FULL SIZE

54931

55075

125599

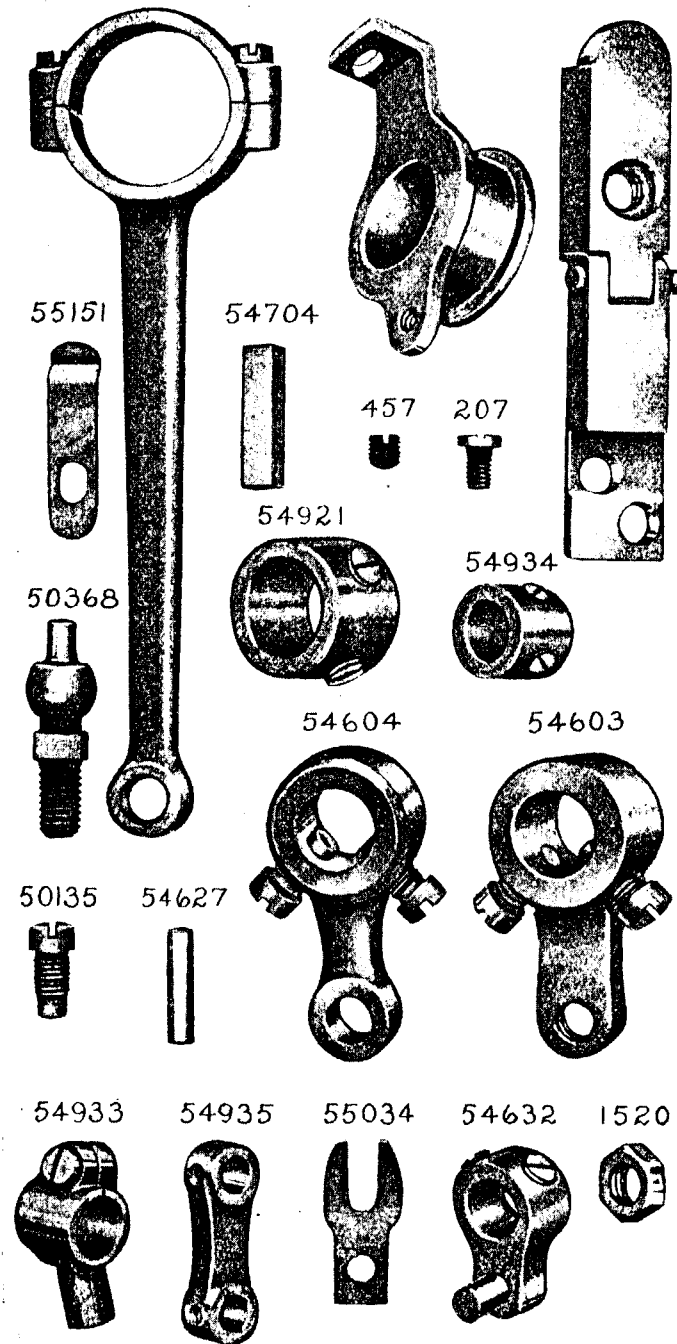


PLATE 6391—FULL SIZE

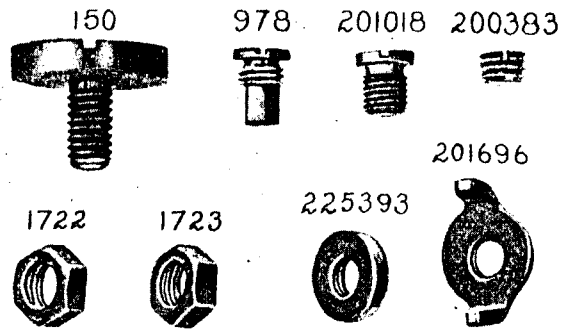


PLATE 6392—FULL SIZE

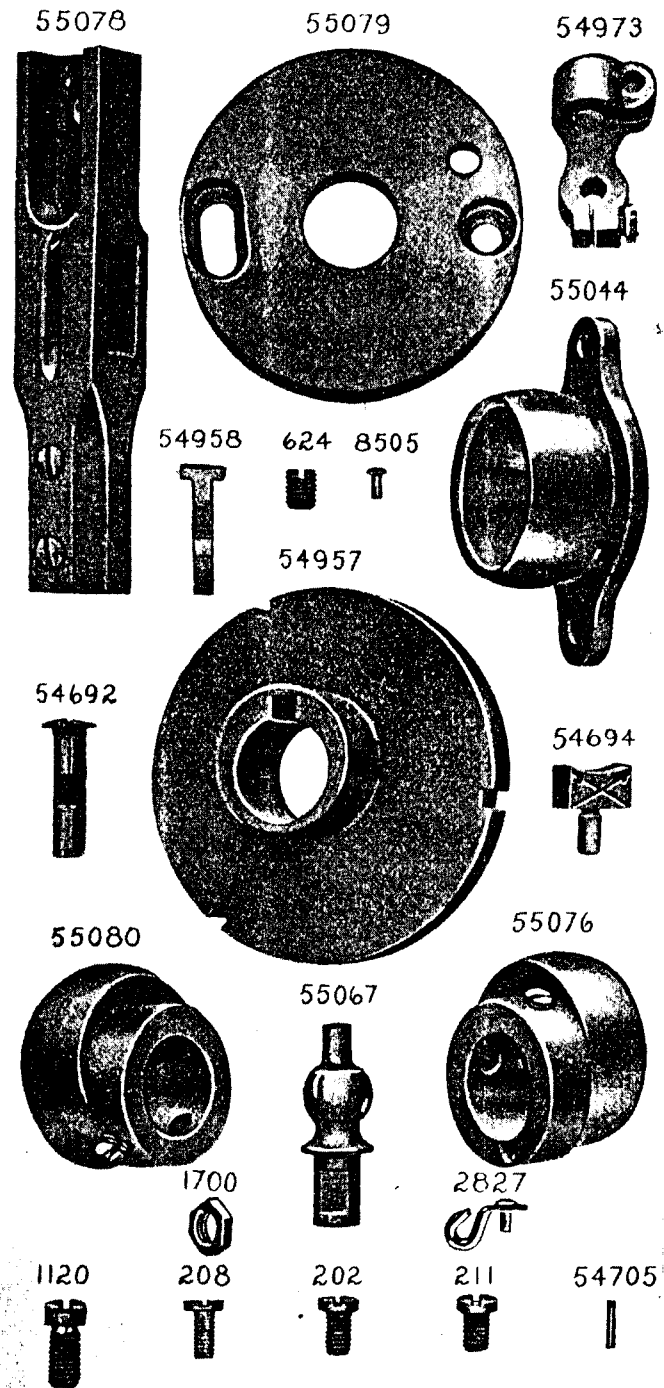


PLATE 6393—FULL SIZE

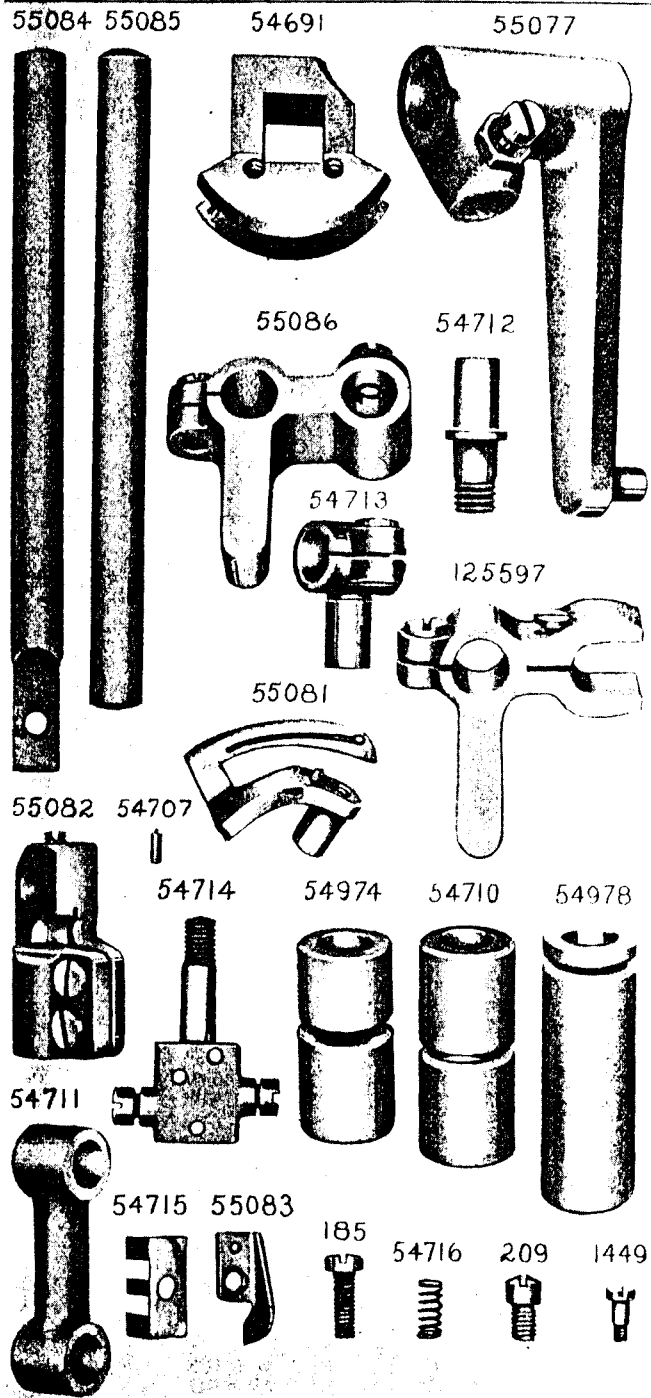


PLATE 6394—ONE-HALF SIZE

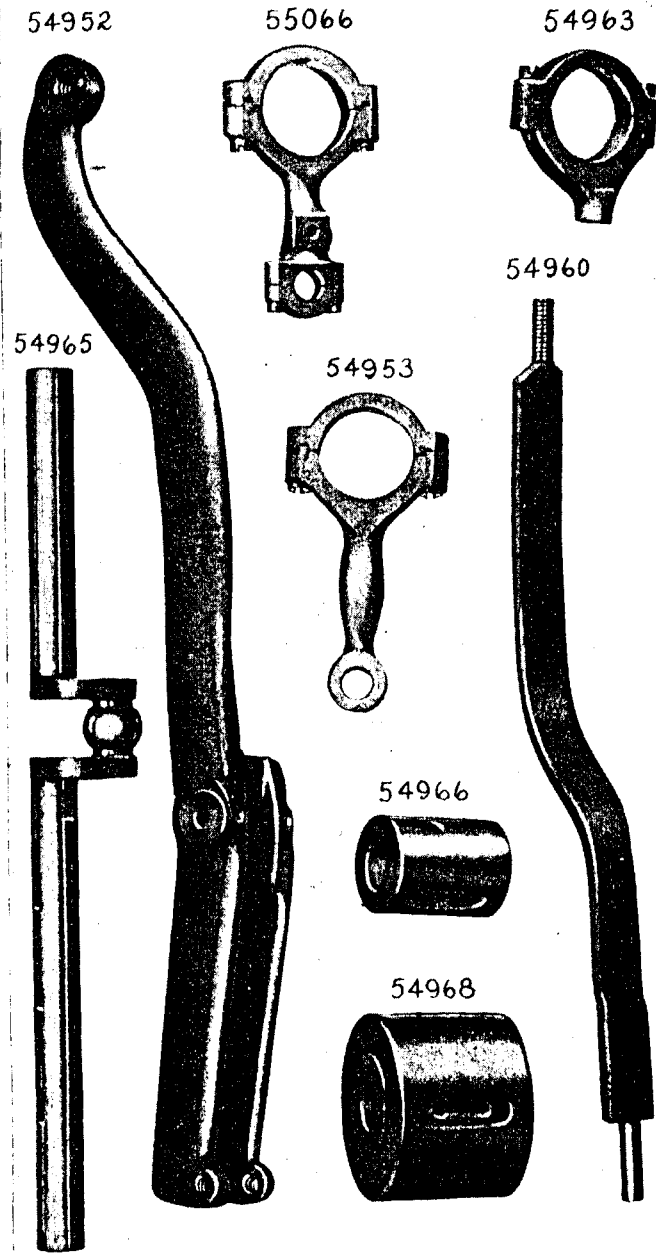


PLATE 6395—FULL SIZE

54719



55087



50228



54672



54726



54728



55111



54723



50128



1492



54764



54763



1319



229



1080

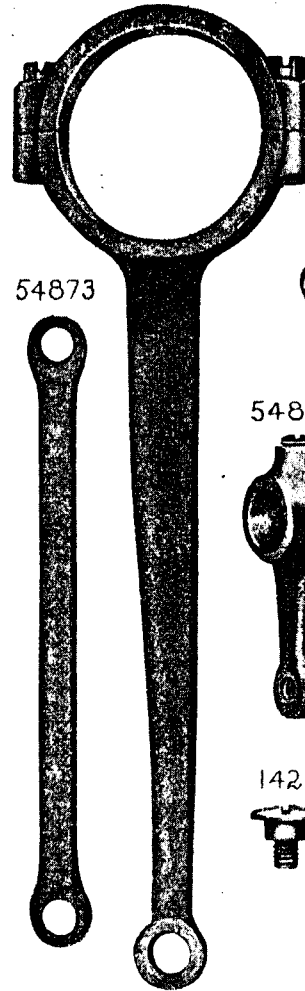


66707

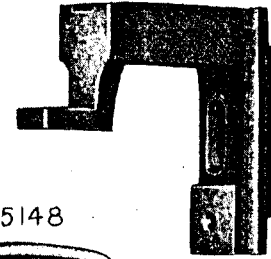


PLATE 6396—FULL SIZE

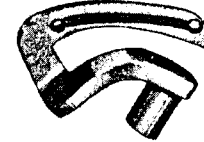
55091



55090

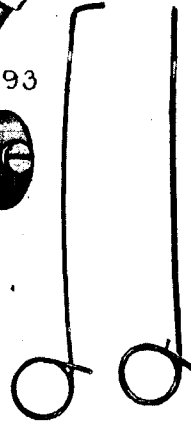


55148



54873

55012 54985



54872



55093



1425



337



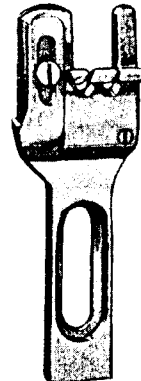
662



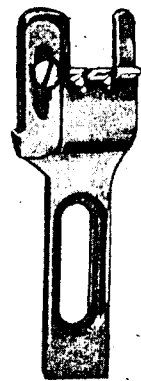
55089 54986



55138



55088



39395



54740



54732



55139



PLATE 6397—FULL SIZE

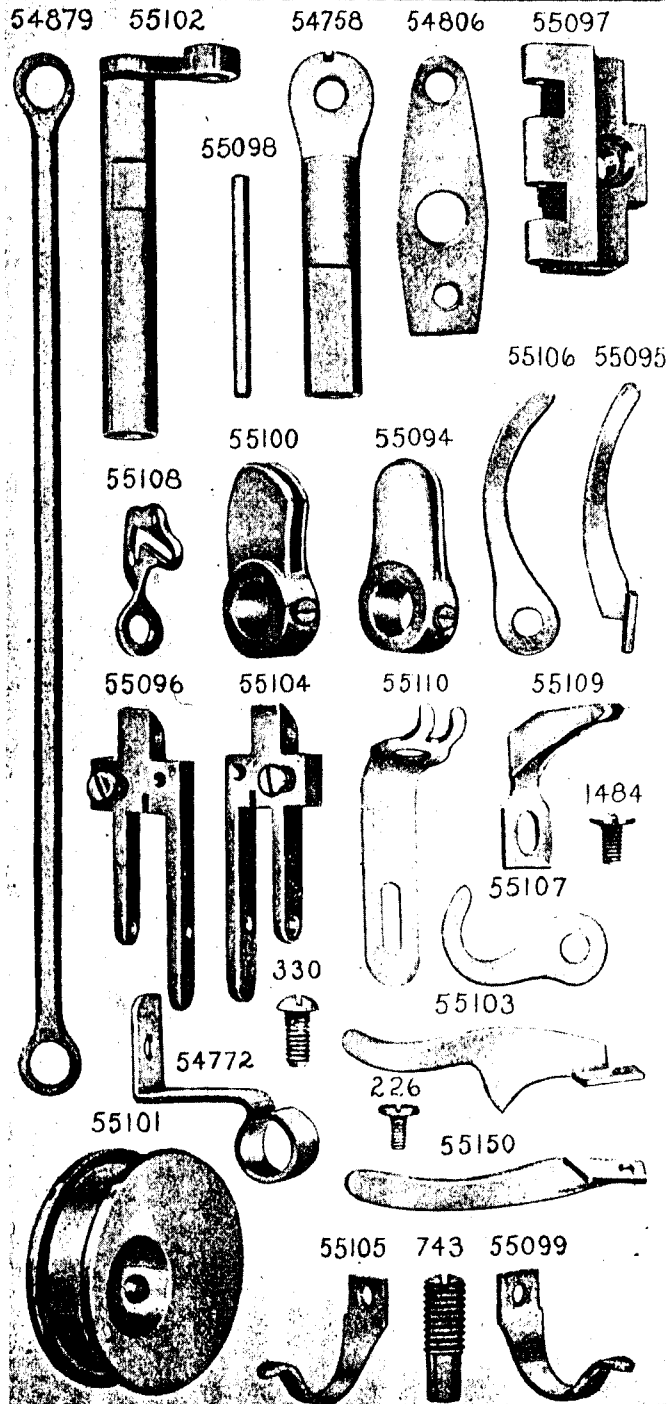


PLATE 7165—ONE-SIXTH SIZE

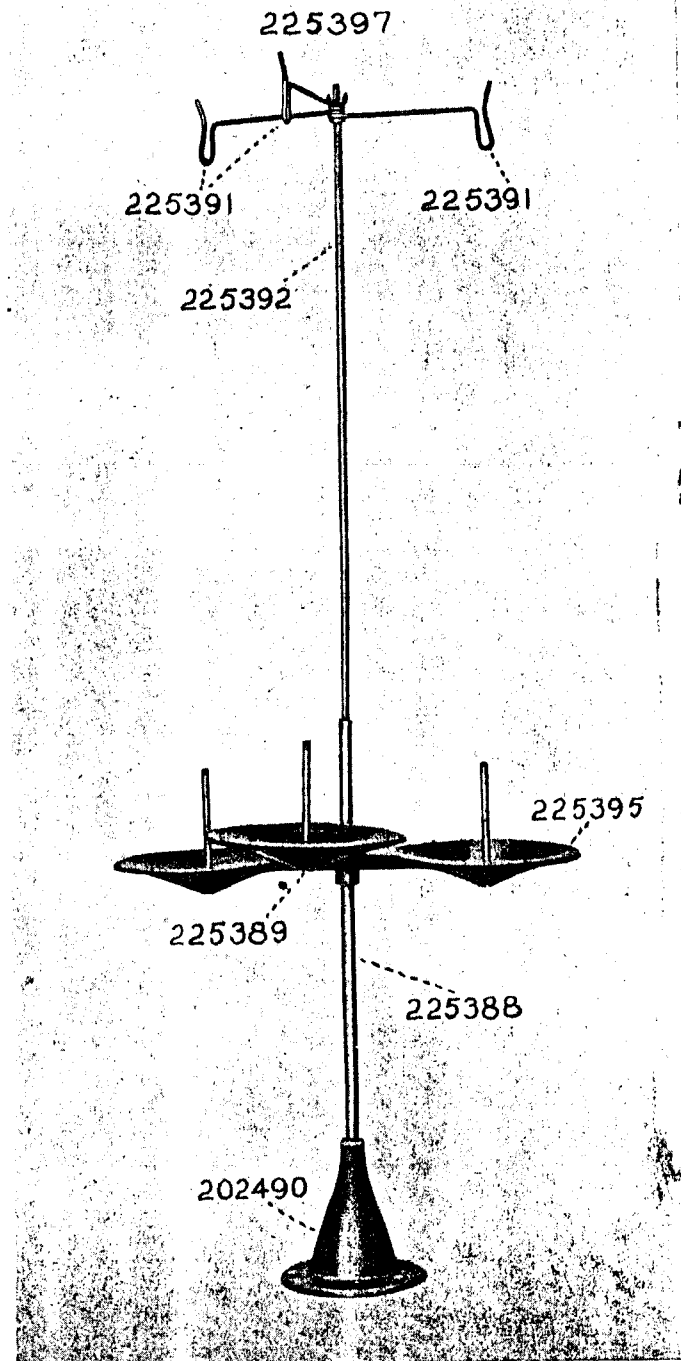


PLATE 7234—ONE-HALF SIZE

27739



225390

