

**SINGER**  
**306W24,W25**

**LIST**  
OF  
**PARTS**  
FOR FAMILY SHOPS



**SINGER**  
MACHINES  
Nos. 306w24 and 306w25

---

THE SINGER MANUFACTURING COMPANY

## INSTRUCTIONS FOR ORDERING

In ordering from this list, use **ONLY** the PART number in the **FIRST** column.

The number stamped on a Sewing Machine Part is the number of the Single Part only, except when the part includes Set Screws, Clamping Screws, Studs and Rollers Spun on, Small Wires riveted, or Parts soldered together, etc., which it is necessary to furnish in combination.

Every combination of parts sent out has its specific number which, although not stamped on Parts (except in above case), must be used when ordering the combination.

Each number always indicates the **SAME PART** in whatever list it appears, or for whatever Machine.

The letters after some of the numbers indicate the style of finish only, as follows:

- A—Hardened, Polished, Nickel Plated and Buffed.
- AL—Heat Treated for Toughness.
- ALX—Heat Treated for Toughness and Black Oxide.
- B—Polished, Nickel Plated and Buffed.
- C—Hardened only.
- D—Polished only.
- E—Soft, Not polished.
- F—Hardened and Polished.
- J—Nickel Plated only.
- R—Merlized.
- X—Black Oxide, for Iron and Steel.
- XC—Hardened and Black Oxide, for Iron and Steel.
- Y—Black Nickel Plated only.
- Z—Chromium Plated.

These letters **MUST BE USED** when they appear in the list and **AFTER** the number, as in the list.

In this series

- 1 to 1500, 200001 to 201500 and 350001 to 351500 are Screw Numbers.
- 1501 to 1800, 201501 to 201800 and 351501 to 351800 are Nut Numbers.
- 1801 to 2000, 201801 to 202000 and 351801 to 352000 are Roller Numbers.
- 2001 to 50000 and 202001 to 350000 are Numbers of Machine Parts.

The figures in the second column refer only to the plate in which the illustration of the part is shown and are **NOT TO BE USED** in ordering.

Two or more numbers over a cut indicate that the difference between such parts is not visible in an illustration.

Parts marked with an asterisk (\*) are furnished only when repairs are made at the factory.

## INDEX

Accessory.....	16
Arm Top Cover with Handle.....	15
Attachment Set.....	16
Bobbin Winder.....	17
Fashion Discs.....	18
Machine No. 306w24.....	5
Machine No. 306w25.....	5
Motor (BA3-8).....	20
Motor Parts, Etc.....	20
Numerical List of Parts.....	23
SINGER Light.....	20

## SPECIAL NOTICE

When ordering the following enumerated parts,  
the style of finish required, whether  
"Black" or "Beige," must be stated on order.

No.	Name
66670	Bobbin Winder Frame
105072	Hand Wheel
105109	Needle Vibrator Indicator Ring
105116	Needle Vibrator Zero Position Control Bearing Sleeve
105119	Needle Vibrator Zero Position Control Lever
105150	Needle Vibrator Amplitude Regulating Lever
105157	Arm Side Cover (back)
105159	Face Plate
105194	Bobbin Winder Bracket (Belt Cover)
105203	Arm Top Cover with two each 2007Z, 8879 and 45826
105207	Fashion Disc Follower Frame with 180ZB
105214	Needle Bar Frame Pitman
105215	Needle Bar Frame Pitman Crank with 180C
188417	Needle Vibrator Rock Shaft Lever
196619	SINGER Light and Bracket
BA3-8	Motor, Bracket, 3 Pin Terminal and All Leads

## LIST OF PARTS COMPLETE

FOR

5

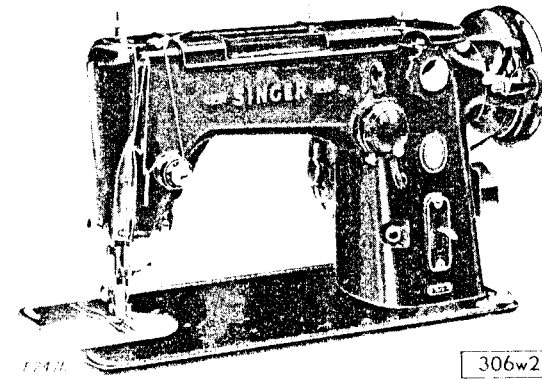

MACHINE No. 306w24

FAMILY MACHINE. SAME AS MACHINE No. 306w25  
EXCEPT TREADLE OPERATED.

## MACHINE No. 306w25

FAMILY MACHINE

SINGLE NEEDLE. LOCK STITCH.  
TRANSVERSE HOOK. DROP FEED.

Interchangeable Fashion Discs Produce Zigzag or  
Ornamental Stitch Patterns Automatically.

Adjustable Reverse Feed.

MOTOR DRIVEN.

No.	Plate	Name
*105201	-----	Arm
Note: Due to the accuracy required in setting Arm to Bed, these Parts cannot be supplied except when repairs are made at factory.		
670E	19010	Arm Binding Screw (3)
105080	19010	Arm Binding Screw Washer (3)
105205	19007	Arm Cross Shaft
105202	19001	Arm Cross Shaft Driving Worm with two 50395A1.

No.	Plate	Name	No.	Plate	Name
50395AL	19001	Arm Cross Shaft Driving Worm Set Screw	105159	19010	Face Plate
105206	19007	Arm Cross Shaft Worm Gear with two 50395AL	105160	19010	Face Plate complete, Nos. 105159 and two 189541
50395AL	19007	Arm Cross Shaft Worm Gear Set Screw	50222ZB	19010	Face Plate Screw
4389	19010	Arm Dowel Pin (For Repairs Only)	105004	19010	Face Plate Thread Guard
105154	19001	Arm Shaft	189541	19010	Face Plate Thread Guard 105004 with 125373
105156	19001	Arm Shaft Bushing (back)	125373	19010	Face Plate Thread Guard Rivet
SS. 664E	19001	Arm Shaft Bushing (back) Clamping Screw (3)	51224ZB	19010	Face Plate Thumb Screw
105083	19001	Arm Shaft Bushing (back) Pad (felt)	276301	19007	Fashion Disc, Number 1, Zig-Zag Stitch (in Machine)
105183	19001	Arm Shaft Bushing (front)	105207	19007	Fashion Disc Follower Frame with 180ZB
443AL	19001	Arm Shaft Bushing (front) Set Screw	180ZB	19007	Fashion Disc Follower Frame Binding Screw
189542	19001	Arm Shaft Connection Belt	105209	19007	Fashion Disc Follower Frame Hinge Pin
188458	19001	Arm Shaft Connection Belt Pulley	449AL	19007	Fashion Disc Follower Frame Hinge Pin Set Screw
448AL	19001	Arm Shaft Connection Belt Pulley Set Screw	105210	19007	Fashion Disc Follower Frame Locating Collar with 200AL
189510	19001	Arm Shaft Connection Belt Pulley Spring Ring	200AL	19007	Fashion Disc Follower Frame Locating Collar Set Screw
188452	19001	Arm Shaft Connection Belt Pulley complete, Nos. 188458, two each 448AL and 189510	105211	19007	Fashion Disc Follower Frame Return Spring
105233	19001	Arm Shaft Thrust Collar with two 50395AL	105213	19007	Fashion Disc Follower Frame Stud
50395AL	19001	Arm Shaft Thrust Collar Set Screw	105212	19007	Fashion Disc Follower Frame complete, Nos. 105207, 105208 and 105213
105157	19010	Arm Side Cover (back)	NN.122ZA	19007	Fashion Disc Retaining Nut with 105234
51224ZB	19010	Arm Side Cover (back) Thumb Screw	105234	19007	Fashion Disc Retaining Nut Friction Washer (rubber)
105203	19001	Arm Top Cover with two each 2007Z, 8879 and 45826	105085	19003	Feed Bar
SS. 693ZB	19001	Arm Top Cover Screw (2)	315C	19003	Feed Bar Screw Center
2007Z	19001	Arm Top Cover Spool Pin (2 Required)	15445	19003	Feed Bar Screw Center 315C with 1519E (2)
45826	19001	Arm Top Cover Spool Pin Spring (2 Required)	1519E	19003	Feed Bar Screw Center Nut
8879	19001	Arm Top Cover Spool Pin Washer (cloth) (2 Required)	105010	19003	Feed Bar Supporting Bracket with two 889AL
*105184	-----	Bed	889AL	19003	Feed Bar Supporting Bracket Set Screw
Note:	Due to the accuracy required in setting Arm to Bed, these Parts cannot be supplied except when repairs are made at factory.				
256ZB	19001	Clamp Stop Motion Clamp Screw	105149	19006	Feed Dog, for 105144
248ZA	19001	Clamp Stop Motion Clamp Stop Screw	50117C	19006	Feed Dog Screw (2)
171502	19001	Clamp Stop Motion Clamp Washer	188927	19002	Feed Eccentric with two 183026AL
45311	19001	Clamp Stop Motion Flanged Bushing	183026AL	19002	Feed Eccentric Set Screw
45313	19001	Clamp Stop Motion Flanged Bushing 45311 with 256ZB	189577	19003	Feed Forked Connection
51320AL	19001	Clamp Stop Motion Flanged Bushing Set Screw	189705	19003	Feed Forked Connection 189577 with 2049 and 189578
45312	19001	Clamp Stop Motion complete, Nos. 248ZA, 171502, 45313 and 51320AL	189706	19003	Feed Forked Connection complete, Nos. 1550ZJ, 1637J, 183016C, 183017, 188925, 188926, 189572 and 189705
			2049	19003	Feed Forked Connection Pin
			189578	19003	Feed Forked Connection Shaft

No.	Plate	Name
189579	19003	Feed Forked Connection Shaft Adjusting Collar with two 465AL
465AL	19003	Feed Forked Connection Shaft Adjusting Collar Set Screw
105132	19002	Feed Lifting Eccentric with two 1120AL
105161	19002	Feed Lifting Eccentric Fork
1120AL	19002	Feed Lifting Eccentric Set Screw
105011	19002	Feed Lifting Rock Shaft
189579	19002	Feed Lifting Rock Shaft Adjusting Collar with two 465AL
105255	19002	Feed Lifting Rock Shaft and Eccentric Fork complete, Nos. 157AL, SS. 694J, 105011, 105132, 105161, 105166 to 105168 and 189579
465AL	19002	Feed Lifting Rock Shaft Adjusting Collar Set Screw
188952	19002	Feed Lifting Rock Shaft Crank with 158E and 125330
158E	19002	Feed Lifting Rock Shaft Crank Clamping Screw
15170	19002	Feed Lifting Rock Shaft Crank Slide Block
125330	19002	Feed Lifting Rock Shaft Crank Slide Block 15170 with 125060
125060	19002	Feed Lifting Rock Shaft Crank Slide Block Stud
189588	19007	Feed Regulator Connecting Rod
86C	19007	Feed Regulator Connecting Rod Screw
189589C	19007	Feed Regulator Connecting Rod Stud
808AL	19003	Feed Regulator Connecting Rod Stud Set Screw
105162	19007	Feed Regulator Indicator Plate
335X	19007	Feed Regulator Indicator Plate Screw (2)
105163	19007	Feed Regulator Lever
105235	19007	Feed Regulator Lever Friction Fork
183018C	19007	Feed Regulator Lever Hinge Screw
105130	19007	Feed Regulator Stop Block
105093	19007	Feed Regulator Stop Block 105130 with 447AL and SS. 667AL
447AL	19007	Feed Regulator Stop Block Set Screw
SS. 698ZB	19007	Feed Regulator Stop Screw
105165	19007	Feed Reversing Handle
SS. 667AL	19007	Feed Reversing Handle Binding Screw
105012	19003	Feed Rock Shaft
105013	19003	Feed Rock Shaft Adjusting Collar with two 183026AL
183026AL	19003	Feed Rock Shaft Adjusting Collar Set Screw
105014	19003	Feed Rock Shaft Bushing (front)
448AL	19003	Feed Rock Shaft Bushing Set Screw

No.	Plate	Name
188925	19003	Feed Rock Shaft Connecting Link with 808AL
188926	19003	Feed Rock Shaft Connecting Link Slide Block
183017	19003	Feed Rock Shaft Connecting Link Slide Block Slide Bar
1550ZJ	19003	Feed Rock Shaft Connecting Link Slide Block Slide Bar Nut
189572	19003	Feed Rock Shaft Crank with 158E
158E	19003	Feed Rock Shaft Crank Clamping Screw
183016C	19003	Feed Rock Shaft Crank Hinge Screw
1637J	19003	Feed Rock Shaft Crank Hinge Screw Nut
105166	19002	Feed Throw-out Crank
157AL	19002	Feed Throw-out Crank Set Screw
SS. 694J	19002	Feed Throw-out Eccentric Fork Thumb Screw
105167	19002	Feed Throw-out Eccentric Fork Thumb Screw Clip
105168	19002	Feed Throw-out Spring
SS. 666AL	19002	Feed Throw-out Stop Screw
1637X	19002	Feed Throw-out Stop Screw Nut
105072	19001	Hand Wheel (3-1/4 in. belt diam.) for Machine No. 306w25
125473	19001	Hand Wheel (2-1/4 in. belt diam.) for Machine No. 306w24
51045AL	19010	Machine Hinge Set Screw (2)
105186	19005	Needle Bar (hollow) with 32519
105015	19005	Needle Bar Connecting Link with 1161AL
189518	19005	Needle Bar Connecting Link Hinge Block (lower)
189515	19005	Needle Bar Connecting Link Hinge Block (upper) with 183011E
183011E	19005	Needle Bar Connecting Link Hinge Block (upper) Adjusting Screw
1130E	19005	Needle Bar Connecting Link Hinge Block (upper) Cap Screw
105017	19005	Needle Bar Connecting Link Hinge Pin
105016	19005	Needle Bar Connecting Link Pin Retainer
1161AL	19005	Needle Bar Connecting Link Pin Retainer Screw
189520	19005	Needle Bar Connecting Link Stud with 400C and 465AL
400C	19005	Needle Bar Connecting Link Stud Adjusting Screw
183012C	19005	Needle Bar Connecting Link Stud Cap Screw
465AL	19005	Needle Bar Connecting Link Stud Set Screw
105018	19005	Needle Bar Connection Nos. 105015, 105016, 189515, 189518 and two 105017

No.	Plate	Name
105019	19005	Needle Bar Connection complete, Nos. 1130E, 105018, 183012C, 189514 and 189520
188949	19001	Needle Bar Crank with 1036C and 1065C
1065C	19001	Needle Bar Crank Position Screw
105169	19005	Needle Bar Frame
105170	19005	Needle Bar Frame 105169 with 665ZB and 189532
105214	19007	Needle Bar Frame Pitman
105215	19007	Needle Bar Frame Pitman Crank with 180C
180C	19007	Needle Bar Frame Pitman Crank Pinch Screw
105216	19007	Needle Bar Frame Pitman Driving Link
105208	19007	Needle Bar Frame Pitman Driving Link Hinge Stud with 51699X
1423C	19007	Needle Bar Frame Pitman Driving Link Hinge Stud Cap Screw
51699X	19007	Needle Bar Frame Pitman Driving Link Hinge Stud Nut
SS. 695AL	19007	Needle Bar Frame Pitman Fulcrum Pin (eccentric)
1521X	19007	Needle Bar Frame Pitman Fulcrum Pin Nut
183020C	19007	Needle Bar Frame Pitman Hinge Screw
105242	19007	Needle Bar Frame Pitman Restraining Collar with 904AL
904AL	19007	Needle Bar Frame Pitman Restraining Collar Set Screw
105244	19005	Needle Bar Frame Return Spring
105243	19005	Needle Bar Frame Return Spring Retaining Tube
183038C	19005	Needle Bar Frame Supporting Bracket
183015C	19005	Needle Bar Frame Supporting Bracket Hinge Screw
624AL	19005	Needle Bar Frame Supporting Bracket Set Screw
27795	19005	Needle Bar Frame Supporting Bracket Set Screw Washer
105237	19005	Needle Bar Frame complete, Nos. 105170 and 105186
105256	19005	Needle Bar Frame 105237 with 105189 and 105190
189532	19005	Needle Bar Height Indicator
665ZB	19005	Needle Bar Height Indicator Screw
32519	19005	Needle Bar Pin
105263	19005	Needle Clamp
105189	19005	Needle Clamp 105263 with SS. 675AL and 140545ZJ
105190	19005	Needle Clamp Gib

No.	Plate	Name
SS. 675AL	19005	Needle Clamp Position Screw
140545ZJ	19005	Needle Clamp Thumb Screw
105150	19008	Needle Vibrator Amplitude Regulating Lever
105104	19008	Needle Vibrator Amplitude Regulating Lever Indent Clamping Pad
SS. 669ZA	19008	Needle Vibrator Amplitude Regulating Lever Indent Clamping Thumb Screw
105103	19008	Needle Vibrator Amplitude Regulating Lever Indent Plate
105105	19008	Needle Vibrator Amplitude Regulating Lever Indent Retaining Plate with 105129
50362E	19008	Needle Vibrator Amplitude Regulating Lever Indent Retaining Plate Screw
105101	19008	Needle Vibrator Amplitude Regulating Lever Plunger
105102	19008	Needle Vibrator Amplitude Regulating Lever Plunger Spring
105172	19008	Needle Vibrator Amplitude Regulating Lever complete, Nos. 105101, 105102, 105106 to 105108, 105150 and three 934E
105108	19008	Needle Vibrator Amplitude Regulating Shaft with 1423E
934E	19008	Needle Vibrator Amplitude Regulating Shaft Flange Fixing Screw
105129	19008	Needle Vibrator Amplitude Regulating Shaft Friction Spring
1423E	19008	Needle Vibrator Amplitude Regulating Shaft Screw
105106	19008	Needle Vibrator Amplitude Regulating Shaft Stop Shoe
105107	19008	Needle Vibrator Amplitude Regulating Shaft Stop Shoe Spring
105109	19008	Needle Vibrator Indicator Ring
105176	19008	Needle Vibrator Regulating Slide with two 50311AL
50311AL	19008	Needle Vibrator Regulating Slide Set Screw
105218	19008	Needle Vibrator Regulating Device complete, Nos. SS. 669ZA, 105103 to 105105, 105109, 105116, 105117, 105119, 105120, 105172, 105176, 105179, 105220, two 50156X and three 50362E
188417	19007	Needle Vibrator Rock Shaft Lever
105175	19005	Needle Vibrator Rock Shaft Lever Slide Bushing

No.	Plate	Name
1550X	19005	Needle Vibrator Rock Shaft Lever Slide Bushing Nut
SS. 696AL	19005	Needle Vibrator Rock Shaft Lever Slide Bushing Screw
105174	19007	Needle Vibrator Sliding Block
105116	19008	Needle Vibrator Zero Position Control Bearing Sleeve
SS. 704AL	19008	Needle Vibrator Zero Position Control Bearing Sleeve (front) Set Screw
440AL	19008	Needle Vibrator Zero Position Control Bearing Sleeve (rear) Set Screw
105117	19008	Needle Vibrator Zero Position Control Bearing Sleeve Thrust Washer
105120	19008	Needle Vibrator Zero Position Control Bushing with 140082E
140082E	19008	Needle Vibrator Zero Position Control Bushing Screw
105179	19008	Needle Vibrator Zero Position Control Eccentric with SS. 697X
SS. 697X	19008	Needle Vibrator Zero Position Control Eccentric Set Screw
105119	19008	Needle Vibrator Zero Position Control Lever
105220	19008	Needle Vibrator Zero Position Tenon Plate with two 910AL
50156X	19008	Needle Vibrator Zero Position Tenon Plate Fixing Screw
910AL	19008	Needle Vibrator Zero Position Tenon Plate Stop Screw
32665	19006	Presser Bar
45237	19006	Presser Bar Guide Bracket with 453AL
453AL	19006	Presser Bar Guide Bracket Set Screw
66564	19006	Presser Bar Lifter
85E	19006	Presser Bar Lifter Screw
32675	19006	Presser Bar Spring
2070	19006	Presser Bar Spring Washer
105250	19006	Presser Foot (hinged) for Zig-Zag Stitching complete, Nos. 105249, 189644 and 189645 (all-purpose)
183022ZB	19006	Presser Foot Thumb Screw
263ZJ	19006	Pressure Regulating Thumb Screw
276251	19004	Rotating Hook with two 1253AL
276252	19004	Rotating Hook 276251 with 105042 and four 1053E
276253	19004	Rotating Hook 276252 with 105039 and three 1367E
276254	19004	Rotating Hook 276253 with Bobbin Case Holder 105033

No.	Plate	Name
276255	19004	Rotating Hook and Bobbin Case complete, Nos. 105032 and 276254
55623	19004	Rotating Hook Bobbin
*105030	-----	Rotating Hook Bobbin Case
*105031	-----	Rotating Hook Bobbin Case 105030 with 591F, 1380D and 105035
105032	19004	Rotating Hook Bobbin Case complete, Nos. 592E, 2975, 40393 and 105031
40393	19004	Rotating Hook Bobbin Case Hinge complete, Nos. 2974, 40392 and 125320
105033	19004	Rotating Hook Bobbin Case Holder
105034	19004	Rotating Hook Bobbin Case Holder Position Bracket
190ZB	19004	Rotating Hook Bobbin Case Holder Position Bracket Screw
40392	19004	Rotating Hook Bobbin Case Latch
125320	19004	Rotating Hook Bobbin Case Latch Lever
2974	19004	Rotating Hook Bobbin Case Latch Lever Fulcrum Pin
2975	19004	Rotating Hook Bobbin Case Latch Spring
592E	19004	Rotating Hook Bobbin Case Latch Stop Screw
591F	19004	Rotating Hook Bobbin Case Tension Regulating Screw
105035	19004	Rotating Hook Bobbin Case Tension Spring
1380D	19004	Rotating Hook Bobbin Case Tension Spring Screw
105180	19002	Rotating Hook Driving Shaft
105049	19002	Rotating Hook Driving Shaft Bushing (back)
448AL	19002	Rotating Hook Driving Shaft Bushing (back) Set Screw
188457	19002	Rotating Hook Driving Shaft Connection Belt Pulley with two SS. 641AL
SS. 641AL	19002	Rotating Hook Driving Shaft Connection Belt Pulley Set Screw
105134	19002	Rotating Hook Driving Shaft Spiral Gear with SS. 678AL and 183026AL
105136	19002	Rotating Hook Driving Shaft Spiral Gear Case with SS. 684AL
50234R	19002	Rotating Hook Driving Shaft Spiral Gear Case Cap Screw
50152ZJ	19002	Rotating Hook Driving Shaft Spiral Gear Case Clamping Screw
105038	19002	Rotating Hook Driving Shaft Spiral Gear Case Cover
223ZJ	19002	Rotating Hook Driving Shaft Spiral Gear Case Cover Screw (2)
448AL	19002	Rotating Hook Driving Shaft Spiral Gear Case Set Screw



No.	Plate	Name
183026AL	19002	Rotating Hook Driving Shaft Spiral Gear Set Screw
SS. 678AL	19002	Rotating Hook Driving Shaft Spiral Gear Timing Screw
1253AL	19004	Rotating Hook Screw (3 Required for 105029 and 2 Required for 276255)
105039	19004	Rotating Hook Section
1367E	19004	Rotating Hook Section Screw (3 Required)
105040	19002	Rotating Hook Shaft
105135	19002	Rotating Hook Shaft Adjusting Collar with two SS. 677AL
SS. 677AL	19002	Rotating Hook Shaft Adjusting Collar Set Screw
105041	19002	Rotating Hook Shaft Bushing
SS. 684AL	19002	Rotating Hook Shaft Bushing Set Screw
105042	19004	Rotating Hook Thread Guard
1053E	19004	Rotating Hook Thread Guard Screw (4 Required)
189538	19009	Slack Thread Regulator
465AL	19009	Slack Thread Regulator Set Screw
2102	19009	Tension Disc
125421	19009	Tension Indicator
45864	19009	Tension Indicator Flange
45865	19009	Tension Indicator Flange Stop Washer
105185	19009	Tension Middle Disc
51681ZB	19009	Tension Regulating Thumb Nut with 45339
45339	19009	Tension Regulating Thumb Nut Engaging Pin
189537	19009	Tension Releasing Lever
97J	19009	Tension Releasing Lever Hinge Screw
12329	19009	Tension Releasing Lever Spring
45868	19009	Tension Releasing Pin
45869	19009	Tension Spring
140167ZJ	19009	Tension Stud
45870	19009	Tension Stud 140167ZJ with 51681ZB
105192	19009	Tension (graduated) complete, Nos. 32759, 45864, 45865, 45868 to 45870, 105185, 105193, 125421 and two 2102
26075	19006	Thread Cutter and Holder
105181	19009	Thread Guard (front of Arm)
330ZJ	19009	Thread Guard (front of Arm) Screw
189514	19005	Thread Take-up Crank
1036C	19001	Thread Take-up Crank Position Screw
*188901	----	Thread Take-up Lever
188902	19005	Thread Take-up Lever 188901 with 32543 and 32544
*32544	----	Thread Take-up Lever Link
1131C	19005	Thread Take-up Lever Link Hinge Screw
*32543	----	Thread Take-up Lever Link Hinge Stud

No.	Plate	Name
105050	19005	Thread Take-up Lever complete, Nos. 1131C, 105019 and 188902
105193	19009	Thread Take-up Spring
32759	19009	Thread Take-up Spring Regulator with 50305C
50305C	19009	Thread Take-up Spring Regulator Screw
453AL	19009	Thread Take-up Spring Regulator Set Screw
105143	19006	Throat Plate (with oblong needle hole)
105144	19006	Throat Plate (with oblong needle hole) complete, Nos. 105143, 189625 and two 51282ZJ, for Zig-Zag Seams, for 105149
189625	19006	Throat Plate Spring
51282ZJ	19006	Throat Plate Spring Screw
		Class Number Plate
228485	----	Class Number Plate Drive Screw (2)

## ARM TOP COVER WITH HANDLE

No.	Plate	Name
105259	19022	Arm Top Cover with four 170168
2007Z	19022	" " " Spool Pin
45826	19022	" " " " " Spring
8879	19022	" " " " " Washer
		(cloth)
105260	19022	Machine Handle
170057	19022	" " Hinge Pin
105261	19022	" " Spring
140740J	19022	" " " Screw
170168	19022	Oil Metering Insert
105258	19022	Arm Top Cover with Machine Handle complete, Nos. 105259, 105260, two each 2007Z, 8879, 45826, 105261, 140740J and 170057
SS. 693ZB	19022	Arm Top Cover Screw (2)

## ACCESSORY

No.	Plate	Name
120861	19013	Oil Can, contents 3 fluid oz. (filled with household oil)

## ATTACHMENT SET

160847	19012	Binder (multi-slotted)
189631	19013	Embroidery Plate only (less spring)
189632	19013	Embroidery Plate complete, Nos. 189625, 189631 and two 51282ZJ
189653	19012	Hemmer Foot, for Shell Seams
206x13	-----	Needles, three each, sizes 11 and 14
306x1-3	-----	Twin Needle (size 14)
189648	19012	Presser Foot, for Button Sewing
86616	19012	Presser Foot, for Buttonhole Work
105248	19012	Presser Foot (hinged) for Straight Stitching complete, Nos. 105245 to 105247
105251	19012	Satin Stitch Foot, for Applique, Wide Ornamental and Zig-Zag Seams
160845	19012	Presser Foot (left toe) for Edge Stitching and Zipper Work
160846	19012	Presser Foot (right toe) for Edge Stitching and Zipper Work
55623	19013	Rotating Hook Bobbin (4)
120598	19013	Ruffler (1, 6 and 12 stitch)
25537	19013	Screw Driver (machine)
86613	19013	Screw Driver (Bobbin Case)
105145	19013	Throat Plate only (straight stitching)
189625	19013	Throat Plate Spring (for all plates)
51282ZJ	19013	Throat Plate Spring Screw (for all plates)
105146	19013	Throat Plate complete (for straight stitching) Nos. 105145, 189625 and two 51282ZJ

No.	Plate	Name
160977	-----	Attachment Set complete, Nos. 25537, 86613, 86616, 105146, 105248, 105251, 120598, 160845 to 160847, 189632, 189648, 189653, twin-needle 306x1-3, four 55623 and six needles 206x13
188961	-----	Presser Foot (hinged) complete, for nylon tricot and sheer silk work

## BOBBIN WINDER

15072	19011	Bobbin Position Pin
105194	19011	Bracket (Belt Cover)
66670	19011	Frame
105046	19011	Frame 66670 with 15288ZB and 105047
51319ZB	19011	Frame Hinge Screw
66601	19011	Frame Spring
15287	19011	Friction Ring (rubber)
15288ZB	19011	Pulley
165047	19011	Spindle with 15072
45268	19011	Stop Latch
51303ZB	19011	Stop Latch Hinge Screw
125462	19011	Stop Latch Spring
125326	19011	Tripping Arm
190ZB	19011	Tripping Arm Screw
105195	19011	Bobbin Winder complete, Nos. 190ZB, 15287, 45268, 51303ZB, 51319ZB, 66601, 105046, 105194, 125326 and 125462
125395	19011	Tension Bracket
193ZB	19011	Tension Bracket Screw
7071Z	19011	Tension Bracket Screw Washer
45915	19011	Tension Disc
45847	19011	Tension Disc Spring
45916	19011	Tension Disc Spring Disc
140138B	19011	Tension Screw
125396	19011	Tension Bracket complete, Nos. 45847, 45915, 45916, 125395 and 140138B

## FASHION DISCS

276300 SET No. 1 OF FASHION DISCS  
COMPLETE, NOS. 276301 TO 276306

No.	Plate	Name
276301	19014	Fashion Disc, No. 1, Zig-Zag Stitch (in Machine)
276302	19014	Fashion Disc, No. 2, Multiple Zig-Zag Stitch
276303	19014	Fashion Disc, No. 3, Blind Stitch
276304	19014	Fashion Disc, No. 4, Scallop Stitch
276305	19014	Fashion Disc, No. 5, Arrowhead Stitch
276306	19014	Fashion Disc, No. 6, Domino Stitch

276401 SET No. 2 OF FASHION DISCS  
COMPLETE, NOS. 276307 TO 276310

276307	19015	Fashion Disc, No. 7, Shell Edge Stitch
276308	19015	Fashion Disc, No. 8, Solid Scallop Stitch
276309	19015	Fashion Disc, No. 9, Icicle Stitch
276310	19015	Fashion Disc, No. 10, Banner Stitch

276402 SET No. 3 OF FASHION DISCS  
COMPLETE, NOS. 276311 TO 276314

276311	19016	Fashion Disc, No. 11, Key Stitch
276312	19016	Fashion Disc, No. 12, Walls of Troy Solid Stitch
276313	19016	Fashion Disc, No. 13, Solid Diamond Stitch
276314	19016	Fashion Disc, No. 14, Zig-Zag Point Stitch

276403 SET No. 4 OF FASHION DISCS  
COMPLETE, NOS. 276315 TO 276318

No.	Plate	Name
276315	-----	Fashion Disc, No. 15, Long Oblique Stitch
276316	-----	Fashion Disc, No. 16, Shingle Stitch
276317	-----	Fashion Disc, No. 17, Pennant Stitch
276318	-----	Fashion Disc, No. 18, Three-Step Stitch

276404 SET No. 5 OF FASHION DISCS  
COMPLETE, NOS. 276319 TO 276322

276319	-----	Fashion Disc, No. 19, Ball Stitch
276320	-----	Fashion Disc, No. 20, Curved Mending Stitch
276321	-----	Fashion Disc, No. 21, Thunderbird Stitch
276322	-----	Fashion Disc, No. 22, Semaphore Stitch

276405 SET No. 6 OF FASHION DISCS  
COMPLETE, NOS. 276323 TO 276326

276323	-----	Fashion Disc, No. 23, Solid Pyramid Stitch
276324	-----	Fashion Disc, No. 24, Open Pyramid Stitch
276325	-----	Fashion Disc, No. 25, Spiny Stitch
276326	-----	Fashion Disc, No. 26, Block Stitch

276406 SET No. 7 OF FASHION DISCS  
COMPLETE, NOS. 276327 TO 276330

276327	-----	Fashion Disc, No. 27, Fagotting Stitch
276328	-----	Fashion Disc, No. 28, Comb Stitch
276329	-----	Fashion Disc, No. 29, Pavilion Stitch
276330	-----	Fashion Disc, No. 30, Platform Stitch

## FOR MACHINE No. 306w25

## BA3-8 MOTOR

No.	Plate	Name
195638	24623	Armature complete, for BA3-8 Motor
195540	24623	Armature Shaft Bearing (2)
195541	24623	Armature Shaft Bearing Retainer (2)
196862	24623	Brush (carbon) (2)
195543	24623	Brush Cover (2)
140433X	24623	Brush Cover Screw (2)
195547	24623	Brush Holder
195874	24623	Brush Lead Terminal (2)
196861	24623	Brush Spring (2)
195966	24623	End Cover (commutator end) for BA3-8 Motor with Name Plate
195546	24623	End Cover (commutator end) Washer (felt)
195926	24623	End Cover (pulley end) with Grease Tube
701792	24623	End Cover (pulley end) Washer (felt)
195545	24623	End Cover Insert (brass) (2)
140376X	24623	End Cover Screw (2)
195640	24623	Field Coil complete, for BA3-8 Motor
964514	24623	Field Coil Wedge (2)
195871	24623	Field Core complete
195544	24623	Field Core Wedge
194717	24623	Motor Lead Strain Relief
193231	24623	Pulley (moulded)
51207X	24623	Pulley Set Screw

## MOTOR PARTS USED WITH ABOVE MOTOR

198651	19021	Belt (moulded)
192851	19021	Lead Wire For Controller
190613	19021	Tube filled with Singer Motor Lubricant

## SINGER LIGHT

195281	19021	Body (lower half)
195280	19021	Body (upper half)
195958	19021	Body (upper half) 195280 with 195143, 196240 and 931728

No.	Plate	Name
195352	19021	Body Snap Ring (large)
195130	19021	Body Snap Ring (small)
196618	19021	Bracket
691X	19021	Bracket Screw (to fasten to machine)
140512X	19021	Bracket Screw (to fasten to SINGER Light Body)
196621	19021	Lead with Terminal Clips and Spring Contacts complete, Nos. 195141 and 195351
195279	19021	Lens (Blue Glass)
195357	19021	Reflector
195282	19021	Shade
195358	19021	Shade Holder
195351	19021	Spring Contact and Holder
195141	19021	Spring Contact (lead end)
196240	19021	Switch Key
195143	-----	Switch Key Snap Ring
931728	-----	Switch Key Spring Washer
195137	-----	Switch Rotating Contact
195138	-----	Switch Rotating Contact Cam
195139	-----	Switch Rotating Contact Cam Insulator
195957	19021	Switch Rotating Contact 195137 with 195138 and 195139
196619	19021	SINGER Light (Blue Glass) complete (less lamp) Nos. 691X, 195130, 195279, 195281, 195282, 195357, 195957, 195958, 196618, 196621, two each 140512X, 195352 and 195358
194120	19021	SINGER Light Lamp (state voltage required)

## NUMERICAL LIST OF PARTS

**SINGER** Needles should be used  
 in **SINGER** Machines  
 These Needles and their Containers  
 are marked with the  
 Company's Trade Mark "**SIMANCO.**"\*\* 1

Needles in Containers marked  
 "**FOR SINGER MACHINES**"  
 are NOT **SINGER** made needles. 2

No.	Plate	Name
	85E 19006	Presser Bar Lifter Screw
	86C 19007	Feed Regulator Connecting Rod Screw
	97J 19009	Tension Releasing Lever Hinge Screw
NN.122ZA	19007	Fashion Disc Retaining Nut with 105234
	157AL 19002	Feed Throw-out Crank Set Screw
	158E 19002	Feed Lifting Rock Shaft Crank Clamping Screw, for 188952
	158E 19003	Feed Rock Shaft Crank Clamping Screw, for 189572
	180ZB 19007	Fashion Disc Follower Frame Binding Screw, for 105207
	180C 19007	Needle Bar Frame Pitman Crank Pinch Screw, for 105215
	190ZB 19011	Bobbin Winder Tripping Arm Screw, for 105195
	190ZB 19004	Rotating Hook Bobbin Case Holder Posi- tion Bracket Screw
	193ZB 19011	Bobbin Winder Tension Bracket Screw
	200AL 19007	Fashion Disc Follower Frame Locating Collar Set Screw, for 105210
	223ZJ 19002	Rotating Hook Driving Shaft Spiral Gear Case Cover Screw
	248ZA 19001	Clamp Stop Motion Clamp Stop Screw, for 45312
	256ZB 19001	Clamp Stop Motion Clamp Screw, for 45313
	263ZJ 19006	Pressure Regulating Thumb Screw
	315C 19003	Feed Bar Screw Center, for 15445
	330ZJ 19009	Thread Guard (front of Arm) Screw
	335X 19007	Feed Regulator Indicator Plate Screw
	400C 19005	Needle Bar Connecting Link Stud Adjust- ing Screw, for 189520
	440AL 19008	Needle Vibrator Zero Position Control Bearing Sleeve (rear) Set Screw
	443AL 19001	Arm Shaft Bushing (front) Set Screw
	447AL 19007	Feed Regulator Stop Block Set Screw, for 105093
	448AL 19001	Arm Shaft Connection Belt Pulley Set Screw, for 188452
	448AL 19003	Feed Rock Shaft Bushing Set Screw
	448AL 19002	Rotating Hook Driving Shaft Bushing (back) Set Screw

No.	Plate	Name
448AL	19002	Rotating Hook Driving Shaft Spiral Gear Case Set Screw
449AL	19007	Fashion Disc Follower Frame Hinge Pin Set Screw
453AL	19006	Presser Bar Guide Bracket Set Screw, for 45237
453AL	19009	Thread Take-up Spring Regulator Set Screw
465AL	19003	Feed Forked Connection Shaft Adjusting Collar Set Screw, for 189579
465AL	19002	Feed Lifting Rock Shaft Adjusting Collar Set Screw, for 189579
465AL	19005	Needle Bar Connecting Link Stud Set Screw, for 189520
465AL	19009	Slack Thread Regulator Set Screw
591F	19004	Rotating Hook Bobbin Case Tension Regulating Screw, for 105031
592E	19004	Rotating Hook Bobbin Case Latch Stop Screw, for 105032
624AL	19005	Needle Bar Frame Supporting Bracket Set Screw
SS. 641AL	19002	Rotating Hook Driving Shaft Connection Belt Pulley Set Screw, for 188457
SS. 664E	19001	Arm Shaft Bushing (back) Clamping Screw
665ZB	19005	Needle Bar Height Indicator Screw, for 105170
SS. 666AL	19002	Feed Throw-out Stop Screw
SS. 667AL	19007	Feed Reversing Handle Binding Screw, for 105093
SS. 669ZA	19008	Needle Vibrator Amplitude Regulating Lever Indent Clamping Thumb Screw, for 105218
670E	19010	Arm Binding Screw
SS. 675AL	19005	Needle Clamp Position Screw, for 105189
SS. 677AL	19002	Rotating Hook Shaft Adjusting Collar Set Screw, for 105135
SS. 678AL	19002	Rotating Hook Driving Shaft Spiral Gear Timing Screw, for 105134
SS. 684AL	19002	Rotating Hook Shaft Bushing Set Screw, for 105136
691X	19021	Bracket Screw (to fasten to machine) for 196619
SS. 693ZB	19001	Arm Top Cover Screw
SS. 694J	19002	Feed Throw-out Eccentric Fork Thumb Screw, for 105255
SS. 695AL	19007	Needle Bar Frame Pitman Fulcrum Pin (eccentric)
SS. 696AL	19005	Needle Vibrator Rock Shaft Lever Slide Bushing Screw

No.	Plate	Name
SS. 697X	19008	Needle Vibrator Zero Position Control Eccentric Set Screw, for 105179
SS. 698ZB	19007	Feed Regulator Stop Screw
SS. 704AL	19008	Needle Vibrator Zero Position Control Bearing Sleeve (front) Set Screw
808AL	19003	Feed Regulator Connecting Rod Stud Set Screw, for 188925
889AL	19003	Feed Bar Supporting Bracket Set Screw, for 105010
904AL	19007	Needle Bar Frame Pitman Restraining Collar Set Screw, for 105242
910AL	19008	Needle Vibrator Zero Position Tenon Plate Stop Screw, for 105220
934E	19008	Needle Vibrator Amplitude Regulating Shaft Flange Fixing Screw, for 105172
1036C	19001	Thread Take-up Crank Position Screw, for 188949
1053E	19004	Rotating Hook Thread Guard Screw, for 276252 (4 Required)
1065C	19001	Needle Bar Crank Position Screw, for 188949
1120AL	19002	Feed Lifting Eccentric Set Screw, for 105132
1130E	19005	Needle Bar Connecting Link Hinge Block (upper) Cap Screw, for 105019
1131C	19005	Thread Take-up Lever Link Hinge Screw, for 105050
1161AL	19005	Needle Bar Connecting Link Pin Retainer Screw, for 105015
1253AL	19004	Rotating Hook Screw, for 276251 (3 Required for 105029 and 2 Required for 276255)
1367E	19004	Rotating Hook Section Screw, for 276253 (3 Required)
1380D	19004	Rotating Hook Bobbin Case Tension Spring Screw, for 105031
1423C	19007	Needle Bar Frame Pitman Driving Link Hinge Stud Cap Screw
1423E	19008	Needle Vibrator Amplitude Regulating Shaft Screw, for 105108
1519E	19003	Feed Bar Screw Center Nut, for 15445
1521X	19007	Needle Bar Frame Pitman Fulcrum Pin Nut
1550ZJ	19003	Feed Rock Shaft Connecting Link Slide Block Slide Bar Nut, for 189706
1550X	19005	Needle Vibrator Rock Shaft Lever Slide Bushing Nut
1637J	19003	Feed Rock Shaft Crank Hinge Screw Nut, for 189706
1637X	19002	Feed Throw-out Stop Screw Nut

No.	Plate	Name
2007Z	19001	Arm Top Cover Spool Pin, for 105203 (2 Required)
2049	19003	Feed Forked Connection Pin, for 189705
2070	19006	Presser Bar Spring Washer
2102	19009	Tension Disc, for 105192
2974	19004	Rotating Hook Bobbin Case Latch Lever Fulcrum Pin, for 40393
2975	19004	Rotating Hook Bobbin Case Latch Spring, for 105032
4389	19010	Arm Dowel Pin (For Repairs Only)
7071Z	19011	Bobbin Winder Tension Bracket Screw Washer
8879	19001	Arm Top Cover Spool Pin Washer (cloth) for 105203 (2 Required)
12329	19009	Tension Releasing Lever Spring
15072	19011	Bobbin Winder Bobbin Position Pin, for 105047
15170	19002	Feed Lifting Rock Shaft Crank Slide Block, for 125330
15287	19011	Bobbin Winder Friction Ring (rubber) for 105195
15288ZB	19011	Bobbin Winder Pulley, for 105046
15445	19003	Feed Bar Screw Center 315C with 1519E
25537	19013	Screw Driver (machine) for 160977
26075	19006	Thread Cutter and Holder
27795	19005	Needle Bar Frame Supporting Bracket Set Screw Washer
32519	19005	Needle Bar Pin, for 105186
*32543	-----	Thread Take-up Lever Link Hinge Stud, for 188902
*32544	-----	Thread Take-up Lever Link, for 188902
32665	19006	Presser Bar
32675	19006	Presser Bar Spring
32759	19009	Thread Take-up Spring Regulator with 50305C, for 105192
40392	19004	Rotating Hook Bobbin Case Latch, for 40393
40393	19004	Rotating Hook Bobbin Case Hinge com- plete, Nos. 2974, 40392 and 125320, for 105032
45237	19006	Presser Bar Guide Bracket with 453A1
45268	19011	Bobbin Winder Stop Latch, for 105195
45311	19001	Clamp Stop Motion Flanged Bushing, for 45313
45312	19001	Clamp Stop Motion complete, Nos. 248ZA, 171502, 45313 and 51320A1.
45313	19001	Clamp Stop Motion Flanged Bushing 45311 with 256ZB, for 45312

No.	Plate	Name
45339	19009	Tension Regulating Thumb Nut Engaging Pin, for 51681ZB
45826	19001	Arm Top Cover Spool Pin Spring, for 105203 (2 Required)
45847	19011	Bobbin Winder Tension Disc Spring, for 125396
45864	19009	Tension Indicator Flange, for 105192
45865	19009	Tension Indicator Flange Stop Washer, for 105192
		Nos. 45868 to 45870, for 105192
45868	19009	Tension Releasing Pin
45869	19009	Tension Spring
45870	19009	Tension Stud 140167ZJ with 51681ZB
45915	19011	Bobbin Winder Tension Disc, for 125396
45916	19011	Bobbin Winder Tension Disc Spring Disc, for 125396
50117C	19006	Feed Dog Screw
50152ZJ	19002	Rotating Hook Driving Shaft Spiral Gear Case Clamping Screw
50156X	19008	Needle Vibrator Zero Position Tenon Plate Fixing Screw, for 105218
50222ZB	19010	Face Plate Screw
50234R	19002	Rotating Hook Driving Shaft Spiral Gear Case Cap Screw
50305C	19009	Thread Take-up Spring Regulator Screw, for 32759
50311A1	19008	Needle Vibrator Regulating Slide Set Screw, for 105176
50362E	19008	Needle Vibrator Amplitude Regulating Lever Indent Retaining Plate Screw, for 105218
50395A1	19001	Arm Cross Shaft Driving Worm Set Screw, for 105202
50395A1	19007	Arm Cross Shaft Worm Gear Set Screw, for 105206
50395A1	19001	Arm Shaft Thrust Collar Set Screw, for 105233
51045A1	19010	Machine Hinge Set Screw
51207X	24623	Pulley Set Screw
51224ZB	19010	Arm Side Cover (back) Thumb Screw
51224ZB	19010	Face Plate Thumb Screw
51282ZJ	19006	Throat Plate Spring Screw (for all plates) for 105144 and 105146
51303ZB	19011	Bobbin Winder Stop Latch Hinge Screw, for 105195
51319ZB	19011	Bobbin Winder Frame Hinge Screw, for 105195
51320A1	19001	Clamp Stop Motion Flanged Bushing Set Screw, for 45312
51681ZB	19009	Tension Regulating Thumb Nut with 45339, for 45870

No.	Plate	Name
51699X	19007	Needle Bar Frame Pitman Driving Link Hinge Stud Nut, for 105208
55623	19004	Rotating Hook Bobbin, for 160977
66564	19006	Presser Bar Lifter
66601	19011	Bobbin Winder Frame Spring, for 105195
66670	19011	Bobbin Winder Frame, for 105046
86613	19013	Screw Driver (Bobbin Case) for 160977
86616	19012	Presser Foot, for Buttonhole Work, for 160977
105004	19010	Face Plate Thread Guard, for 189541
105010	19003	Feed Bar Supporting Bracket with two 889AL
105011	19002	Feed Lifting Rock Shaft, for 105255
105012	19003	Feed Rock Shaft
105013	19003	Feed Rock Shaft Adjusting Collar with two 183026AL
105014	19003	Feed Rock Shaft Bushing (front) Nos. 105015 to 105017, for 105018
105015	19005	Needle Bar Connecting Link with 1161AL
105016	19005	Needle Bar Connecting Link Pin Retainer
105017	19005	Needle Bar Connecting Link Hinge Pin
105018	19005	Needle Bar Connection Nos. 105015, 105016, 189515, 189518 and two 105017, for 105019
105019	19005	Needle Bar Connection complete, Nos. 1130E, 105018, 183012C, 189514 and 189520, for 105050
*105030	-----	Rotating Hook Bobbin Case, for 105031
*105031	-----	Rotating Hook Bobbin Case 105030 with 591F, 1380D and 105035, for 105032
105032	19004	Rotating Hook Bobbin Case complete, Nos. 592E, 2975, 40393 and 105031, for 276255
105033	19004	Rotating Hook Bobbin Case Holder, for 276254
105034	19004	Rotating Hook Bobbin Case Holder Position Bracket
105035	19004	Rotating Hook Bobbin Case Tension Spring, for 105031
105038	19002	Rotating Hook Driving Shaft Spiral Gear Case Cover
105039	19004	Rotating Hook Section, for 276253
105040	19002	Rotating Hook Shaft
105041	19002	Rotating Hook Shaft Bushing
105042	19004	Rotating Hook Thread Guard, for 276252
105046	19011	Bobbin Winder Frame 66670 with 15288ZB and 105047, for 105195
105047	19011	Bobbin Winder Spindle with 15072, for 105046

No.	Plate	Name
105049	19002	Rotating Hook Driving Shaft Bushing (back)
105050	19005	Thread Take-up Lever complete, Nos. 1131C, 105019 and 188902
105072	19001	Hand Wheel (3-1/4 in. belt diam.) for Machine No. 306w25
105080	19010	Arm Binding Screw Washer
105083	19001	Arm Shaft Bushing (back) Pad (felt)
105085	19003	Feed Bar
105093	19007	Feed Regulator Stop Block 105130 with 447AL and SS. 667AL
105101	19008	Needle Vibrator Amplitude Regulating Lever Plunger, for 105172
105102	19008	Needle Vibrator Amplitude Regulating Lever Plunger Spring, for 105172 Nos. 105103 to 105105, for 105218
105103	19008	Needle Vibrator Amplitude Regulating Lever Indent Plate
105104	19008	Needle Vibrator Amplitude Regulating Lever Indent Clamping Pad
105105	19008	Needle Vibrator Amplitude Regulating Lever Indent Retaining Plate with 105129 Nos. 105106 to 105108, for 105172
105106	19008	Needle Vibrator Amplitude Regulating Shaft Stop Shoe
105107	19008	Needle Vibrator Amplitude Regulating Shaft Stop Shoe Spring
105108	19008	Needle Vibrator Amplitude Regulating Shaft with 1423E
105109	19008	Needle Vibrator Indicator Ring, for 105218
105116	19008	Needle Vibrator Zero Position Control Bearing Sleeve, for 105218
105117	19008	Needle Vibrator Zero Position Control Bearing Sleeve Thrust Washer, for 105218
105119	19008	Needle Vibrator Zero Position Control Lever, for 105218
105120	19008	Needle Vibrator Zero Position Control Bushings with 140082E, for 105218
105129	19008	Needle Vibrator Amplitude Regulating Shaft Friction Spring, for 105105
105130	19007	Feed Regulator Stop Block, for 105093
105132	19002	Feed Lifting Eccentric with two 1120AL., for 105255
105134	19002	Rotating Hook Driving Shaft Spiral Gear with SS. 678AL and 183026AL
105135	19002	Rotating Hook Shaft Adjusting Collar with two SS. 677AL



No.	Plate	Name
105136	19002	Rotating Hook Driving Shaft Spiral Gear Case with SS. 684AL
105143	19006	Throat Plate (with oblong needle hole) for 105144
105144	19006	Throat Plate (with oblong needle hole) complete, Nos. 105143, 189625 and two 51282ZJ, for Zig Zag Seams, for 105149
105145	19013	Throat Plate only (straight stitching) for 105146
105146	19013	Throat Plate complete (for straight stitching) Nos. 105145, 189625 and two 51282ZJ, for 160977
105149	19006	Feed Dog, for 105144
105150	19008	Needle Vibrator Amplitude Regulating Lever, for 105172
105154	19001	Arm Shaft
105156	19001	Arm Shaft Bushing (back)
105157	19010	Arm Side Cover (back)
105159	19010	Face Plate
105160	19010	Face Plate complete, Nos. 105159 and two 189541
105161	19002	Feed Lifting Eccentric Fork, for 105255
105162	19007	Feed Regulator Indicator Plate
105163	19007	Feed Regulator Lever
105165	19007	Feed Reversing Handle Nos. 105166 to 105168, for 105255
105166	19002	Feed Throw-out Crank
105167	19002	Feed Throw-out Eccentric Fork Thumb Screw Clip
105168	19002	Feed Throw-out Spring
105169	19005	Needle Bar Frame, for 105170
105170	19005	Needle Bar Frame 105169 with 665ZB and 189532, for 105237
105172	19008	Needle Vibrator Amplitude Regulating Lever complete, Nos. 105101, 105102, 105106 to 105108, 105150 and three 934E, for 105218
105174	19007	Needle Vibrator Sliding Block
105175	19005	Needle Vibrator Rock Shaft Lever Slide Bushing
105176	19008	Needle Vibrator Regulating Slide with two 50311AL, for 105218
105179	19008	Needle Vibrator Zero Position Control Eccentric with SS. 697X, for 105218
105180	19002	Rotating Hook Driving Shaft
105181	19009	Thread Guard (front of Arm)
105183	19001	Arm Shaft Bushing (front)
*105184	-----	Bed

No.	Plate	Name
105185	19009	Tension Middle Disc, for 105192
105186	19005	Needle Bar (hollow) with 32519, for 105237
105189	19005	Needle Clamp 105263 with SS. 675AL and 140545ZJ, for 105256
105190	19005	Needle Clamp Gib, for 105256
105192	19009	Tension (graduated) complete, Nos. 32759, 45864, 45865, 45868 to 45870, 105185, 105193, 125421 and two 2102
105193	19009	Thread Take-up Spring, for 105192
105194	19011	Bobbin Winder Bracket (Belt Cover) for 105195
105195	19011	Bobbin Winder complete, Nos. 190ZB, 15287, 45268, 51303ZB, 51319ZB, 66601, 105046, 105194, 125326 and 125462
*105201	-----	Arm
105202	19001	Arm Cross Shaft Driving Worm with two 50395AL
105203	19001	Arm Top Cover with two each 2007Z, 8879 and 45826
105205	19007	Arm Cross Shaft
105206	19007	Arm Cross Shaft Worm Gear with two 50395AL
105207	19007	Fashion Disc Follower Frame with 180ZB, for 105212
105208	19007	Needle Bar Frame Pitman Driving Link Hinge Stud with 51699X, for 105212
105209	19007	Fashion Disc Follower Frame Hinge Pin
105210	19007	Fashion Disc Follower Frame Locating Collar with 200AL
105211	19007	Fashion Disc Follower Frame Return Spring
105212	19007	Fashion Disc Follower Frame complete, Nos. 105207, 105208 and 105213
105213	19007	Fashion Disc Follower Frame Stud, for 105212
105214	19007	Needle Bar Frame Pitman
105215	19007	Needle Bar Frame Pitman Crank with 180C
105216	19007	Needle Bar Frame Pitman Driving Link
105218	19008	Needle Vibrator Regulating Device complete, Nos. SS. 669ZA, 105103 to 105105, 105109, 105116, 105117, 105119, 105120, 105172, 105176, 105179, 105220, two 50156X and three 50362E
105220	19008	Needle Vibrator Zero Position Tenon Plate with two 910AL, for 105218

No.	Plate	Name
105233	19001	Arm Shaft Thrust Collar with two 50395A1.
105234	19007	Fashion Disc Retaining Nut Friction Washer (rubber) for NN, 122ZA
105235	19007	Feed Regulator Lever Friction Fork
105237	19005	Needle Bar Frame complete, Nos. 105170 and 105186, for 105256
105242	19007	Needle Bar Frame Pitman Restraining Collar with 904A1.
105243	19005	Needle Bar Frame Return Spring Retaining Tube
105244	19005	Needle Bar Frame Return Spring
105248	19012	Presser Foot (hinged) for Straight Stitching complete, Nos. 105245 to 105247
105250	19006	Presser Foot (hinged) for Zig-Zag Stitching complete, Nos. 105249, 189644 and 189645 (all-purpose)
105251	19012	Satin Stitch Foot, for Applique, Wide Ornamental and Zig-Zag Seams
105255	19002	Feed Lifting Rock Shaft and Eccentric Fork complete, Nos. 157A1, SS. 694J, 105011, 105132, 105161, 105166 to 105168 and 189579
105256	19005	Needle Bar Frame 105237 with 105189 and 105190
105263	19005	Needle Clamp, for 105189
120598	19013	Ruffler (1, 6 and 12 stitch) for 160977
120861	19013	Oil Can, contents 3 fluid oz. (filled with household oil)
125060	19002	Feed Lifting Rock Shaft Crank Slide Block Stud, for 125330
125320	19004	Rotating Hook Bobbin Case Latch Lever, for 40393
125326	19011	Bobbin Winder Tripping Arm, for 105195
125330	19002	Feed Lifting Rock Shaft Crank Slide Block 15170 with 125060, for 188952
125373	19010	Face Plate Thread Guard Rivet, for 189541
125395	19011	Bobbin Winder Tension Bracket, for 125396
125396	19011	Bobbin Winder Tension Bracket complete, Nos. 45847, 45915, 45916, 125395 and 140138B
125421	19009	Tension Indicator, for 105192
125462	19011	Bobbin Winder Stop Latch Spring, for 105195
125473	19001	Hand Wheel (2-1/4 in. belt diam.) for Machine No. 306w24
140082E	19008	Needle Vibrator Zero Position Control Bushing Screw, for 105120
140138B	19011	Bobbin Winder Tension Screw, for 125396

No.	Plate	Name
140167ZJ	19009	Tension Stud, for 45870
140376X	24623	End Cover Screw
140433X	24623	Brush Cover Screw
140512X	19021	Bracket Screw (to fasten to SINGER Light Body) for 196619
140545ZJ	19005	Needle Clamp Thumb Screw, for 105189
160845	19012	Nos. 160845 to 160847, for 160977
160846	19012	Presser Foot (left toe) for Stitching on Edge and Zipper Work
160847	19012	Presser Foot (right toe) for Stitching on Edge and Zipper Work
160847	19012	Binder (multi-slotted)
160977	-----	Attachment Set complete, Nos. 25537, 86613, 86616, 105146, 105248, 105251, 120598, 160845 to 160847, 189632, 189648, 189653, twin needle 306x1-3, four 55623 and six needles 206x13
171502	19001	Clamp Stop Motion Clamp Washer, for 45312
183011E	19005	Needle Bar Connecting Link Hinge Block (upper) Adjusting Screw, for 189515
183012C	19005	Needle Bar Connecting Link Stud Cap Screw, for 105019
183015C	19005	Needle Bar Frame Supporting Bracket Hinge Screw
183016C	19003	Feed Rock Shaft Crank Hinge Screw, for 189706
183017	19003	Feed Rock Shaft Connecting Link Slide Block Slide Bar, for 189706
183018C	19007	Feed Regulator Lever Hinge Screw
183020C	19007	Needle Bar Frame Pitman Hinge Screw
183022ZB	19006	Presser Foot Thumb Screw
183026AL	19002	Feed Eccentric Set Screw, for 188927
183026AL	19003	Feed Rock Shaft Adjusting Collar Set Screw, for 105013
183026AL	19002	Rotating Hook Driving Shaft Spiral Gear Set Screw, for 105134
183038C	19005	Needle Bar Frame Supporting Bracket
188417	19007	Needle Vibrator Rock Shaft Lever
188452	19001	Arm Shaft Connection Belt Pulley complete, Nos. 188458, two each 448AL and 189510
188457	19002	Rotating Hook Driving Shaft Connection Belt Pulley with two SS. 641AL
188458	19001	Arm Shaft Connection Belt Pulley, for 188452
*188901	-----	Thread Take-up Lever, for 188902
188902	19005	Thread Take-up Lever 188901 with 32543 and 32544, for 105050
188925	19003	Feed Rock Shaft Connecting Link with 808AL, for 189706
188926	19003	Feed Rock Shaft Connecting Link Slide Block, for 189706

No.	Plate	Name
188927	19002	Feed Eccentric with two 183026A1.
188949	19001	Needle Bar Crank with 1036C and 1065C
188952	19002	Feed Lifting Rock Shaft Crank with 158E and 125330
188961	-----	Presser Foot (hinged) complete, for nylon tricot and sheer silk work
189510	19001	Arm Shaft Connection Belt Pulley Spring Ring, for 188452
189514	19005	Thread Take-up Crank, for 105019
189515	19005	Needle Bar Connecting Link Hinge Block (upper) with 183011E, for 105018
189518	19005	Needle Bar Connecting Link Hinge Block (lower) for 105018
189520	19005	Needle Bar Connecting Link Stud with 400C and 465A1., for 105019
189532	19005	Needle Bar Height Indicator, for 105170
189537	19009	Tension Releasing Lever
189538	19009	Slack Thread Regulator
189541	19010	Face Plate Thread Guard 105004 with 125373, for 105160
189542	19001	Arm Shaft Connection Belt
189572	19003	Feed Rock Shaft Crank with 158E, for 189706
189577	19003	Feed Forked Connection, for 189705
189578	19003	Feed Forked Connection Shaft, for 189705
189579	19003	Feed Forked Connection Shaft Adjusting Collar with two 465A1.
189579	19002	Feed Lifting Rock Shaft Adjusting Collar with two 465A1., for 105255
189588	19007	Feed Regulator Connecting Rod
189589C	19007	Feed Regulator Connecting Rod Stud
189625	19006	Throat Plate Spring (for all plates) for 105144 and 105146
189631	19013	Embroidery Plate only (less Spring) for 189632
189632	19013	Embroidery Plate complete, Nos. 189625, 189631 and two 51282ZJ, for 160977
189644	19006	Presser Foot Shank, for 105250
189645	19006	Presser Foot Hinge Pin, for 105250
189648	19012	Presser Foot, for Button Sewing, for 160977
189653	19012	Hemmer Foot, for Shell Seams, for 160977
189705	19003	Feed Forked Connection 189577 with 2049 and 189578, for 189706
189706	19003	Feed Forked Connection complete, Nos. 1550ZJ, 1637J, 183016C, 183017, 188925, 188926, 189572 and 189705
190613	19021	Tube filled with Singer Motor Lubricant
192851	19021	Lead Wire for Controller
193231	24623	Pulley (moulded)

No.	Plate	Name
194120	19021	SINGER Light Lamp (state voltage required)
194717	24623	Motor Lead Strain Relief
195130	19021	Body Snap Ring (small) for 196619 Nos. 195137 to 195139, for 195957
195137	-----	Switch Rotating Contact
195138	-----	Switch Rotating Contact Cam
195139	-----	Switch Rotating Contact Cam Insulator
195141	19021	Spring Contact (lead end)
195143	-----	Switch Key Snap Ring, for 195958
195279	19021	Lens (blue glass) for 196619
195280	19021	Body (upper half) for 195958
195281	19021	Body (lower half) for 196619
195282	19021	Shade, for 196619
195351	19021	Spring Contact and Holder, for 196621
195352	19021	Body Snap Ring (large) for 196619
195357	19021	Reflector, for 196619
195358	19021	Shade Holder, for 196619
195540	24623	Armature Shaft Bearing
195541	24623	Armature Shaft Bearing Retainer
195543	24623	Brush Cover
195544	24623	Field Core Wedge
195545	24623	End Cover Insert (brass)
195546	24623	End Cover (commutator end) Washer (felt)
195547	24623	Brush Holder
195638	24623	Armature complete, for BA3-8 Motor
195640	24623	Field Coil complete, for BA3-8 Motor
195871	24623	Field Core complete
195874	24623	Brush Lead Terminal
195926	24623	End Cover (pulley end) with Grease Tube
195957	19021	Switch Rotating Contact 195137 with 195138 and 195139, for 196619
195958	19021	Body (upper half) 195280 with 195143, 196240 and 931728, for 196619
195966	24623	End Cover (commutator end) for BA3-8 Motor with Name Plate
196240	19021	Switch Key, for 195958
196618	19021	Bracket, for 196619
196619	19021	SINGER Light (Blue Glass) complete (less lamp) Nos. 691X, 195130, 195279, 195281, 195282, 195357, 195957, 195958, 196618, 196621, two each 140512X, 195352 and 195358
196621	19021	Lead with Terminal Clips and Spring Contacts complete, Nos. 195141 and 195351, for 196619
196861	24623	Brush Spring

No.	Plate	Name
196862	24623	Brush (carbon)
198651	19021	Belt (moulded)
228485	-----	Class Number Plate Drive Screw
276251	19004	Rotating Hook with two 1253AL., for 276252
276252	19004	Rotating Hook 276251 with 105042 and four 1053E, for 276253
276253	19004	Rotating Hook 276252 with 105039 and three 1367E, for 276254
276254	19004	Rotating Hook 276253 with Bobbin Case Holder 105033, for 276255
276255	19004	Rotating Hook and Bobbin Case complete, Nos. 105032 and 276254
276300	-----	Set No. 1 of Fashion Discs complete, Nos. 276301 to 276306
		Nos. 276301 to 276306, for 276300
276301	19007	Fashion Disc, No. 1, Zig-Zag Stitch (in Machine)
276302	19014	Fashion Disc, No. 2, Multiple Zig-Zag Stitch
276303	19014	Fashion Disc, No. 3, Blind Stitch
276304	19014	Fashion Disc, No. 4, Scallop Stitch
276305	19014	Fashion Disc, No. 5, Arrowhead Stitch
276306	19014	Fashion Disc, No. 6, Domino Stitch
		Nos. 276307 to 276310, for 276401
276307	19015	Fashion Disc, No. 7, Shell Edge Stitch
276308	19015	Fashion Disc, No. 8, Solid Scallop Stitch
276309	19015	Fashion Disc, No. 9, Icicle Stitch
276310	19015	Fashion Disc, No. 10, Banner Stitch
		Nos. 276311 to 276314, for 276402
276311	19016	Fashion Disc, No. 11, Key Stitch
276312	19016	Fashion Disc, No. 12, Walls of Troy Solid Stitch
276313	19016	Fashion Disc, No. 13, Solid Diamond Stitch
276314	19016	Fashion Disc, No. 14, Zig-Zag Point Stitch
		Nos. 276315 to 276318, for 276403
276315	-----	Fashion Disc, No. 15, Long Oblique Stitch
276316	-----	Fashion Disc, No. 16, Shingle Stitch
276317	-----	Fashion Disc, No. 17, Pennant Stitch
276318	-----	Fashion Disc, No. 18, Three-step Stitch
		Nos. 276319 to 276322, for 276404
276319	-----	Fashion Disc, No. 19, Ball Stitch
276320	-----	Fashion Disc, No. 20, Curved Mending Stitch
276321	-----	Fashion Disc, No. 21, Thunderbird Stitch
276322	-----	Fashion Disc, No. 22, Semaphore Stitch

No.	Plate	Name
		Nos. 276323 to 276326, for 276405
276323	-----	Fashion Disc, No. 23, Solid Pyramid Stitch
276324	-----	Fashion Disc, No. 24, Open Pyramid Stitch
276325	-----	Fashion Disc, No. 25, Spiny Stitch
276326	-----	Fashion Disc, No. 26, Block Stitch
		Nos. 276327 to 276330, for 276406
276327	-----	Fashion Disc, No. 27, Fagotting Stitch
276328	-----	Fashion Disc, No. 28, Comb Stitch
276329	-----	Fashion Disc, No. 29, Pavilion Stitch
276330	-----	Fashion Disc, No. 30, Platform Stitch
276401	-----	Set No. 2 of Fashion Discs complete, Nos. 276307 to 276310
276402	-----	Set No. 3 of Fashion Discs complete, Nos. 276311 to 276314
276403	-----	Set No. 4 of Fashion Discs complete, Nos. 276315 to 276318
276404	-----	Set No. 5 of Fashion Discs complete, Nos. 276319 to 276322
276405	-----	Set No. 6 of Fashion Discs complete, Nos. 276323 to 276326
276406	-----	Set No. 7 of Fashion Discs complete, Nos. 276327 to 276330
701792	24623	End Cover (pulley end) Washer (felt)
931728	-----	Switch Key Spring Washer, for 195958
964514	24623	Field Coil Wedge

SINGER Needles should be used  
 in SINGER Machines  
 These Needles and their Containers  
 are marked with the  
 Company's Trade Mark "SIMANCO."\*\* 1

Needles in Containers marked  
 "FOR SINGER MACHINES"  
 are NOT SINGER made needles. 2

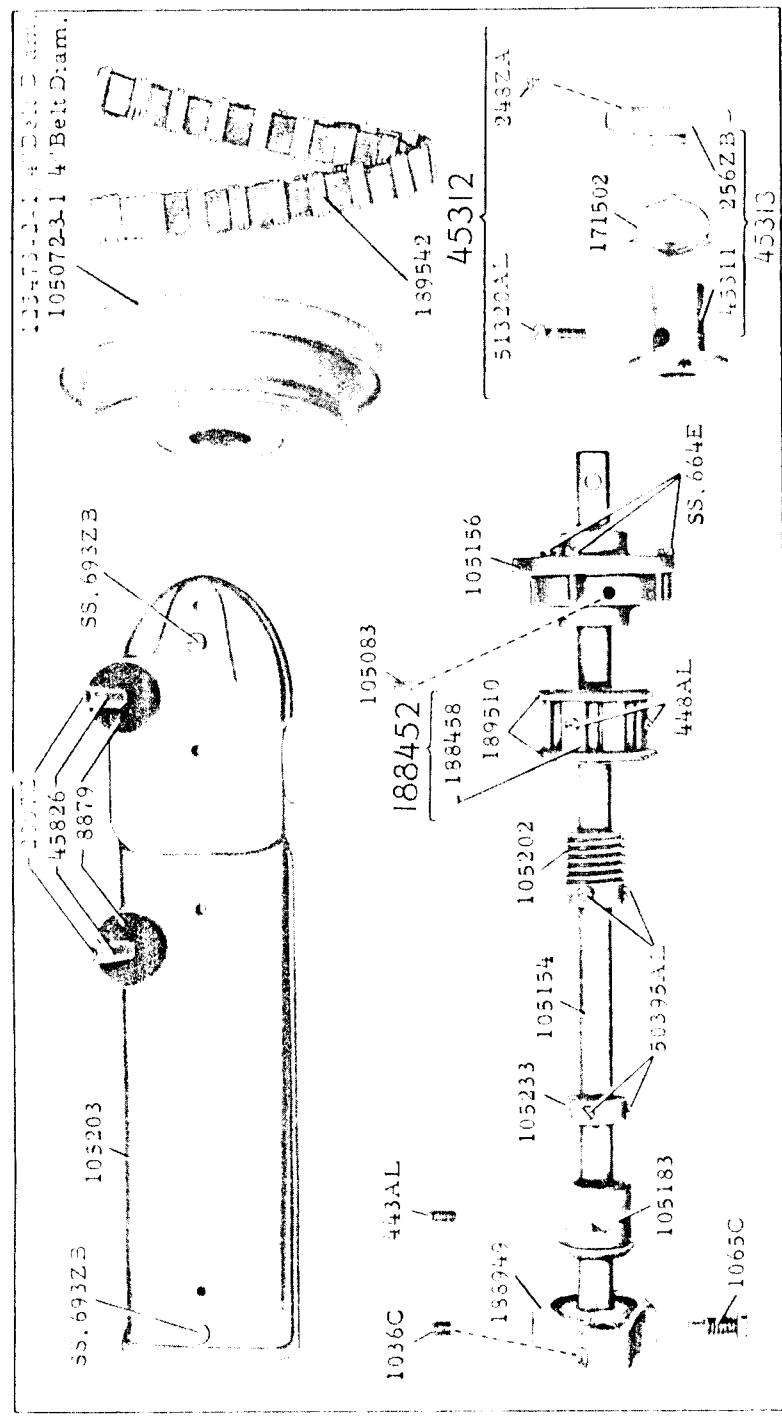

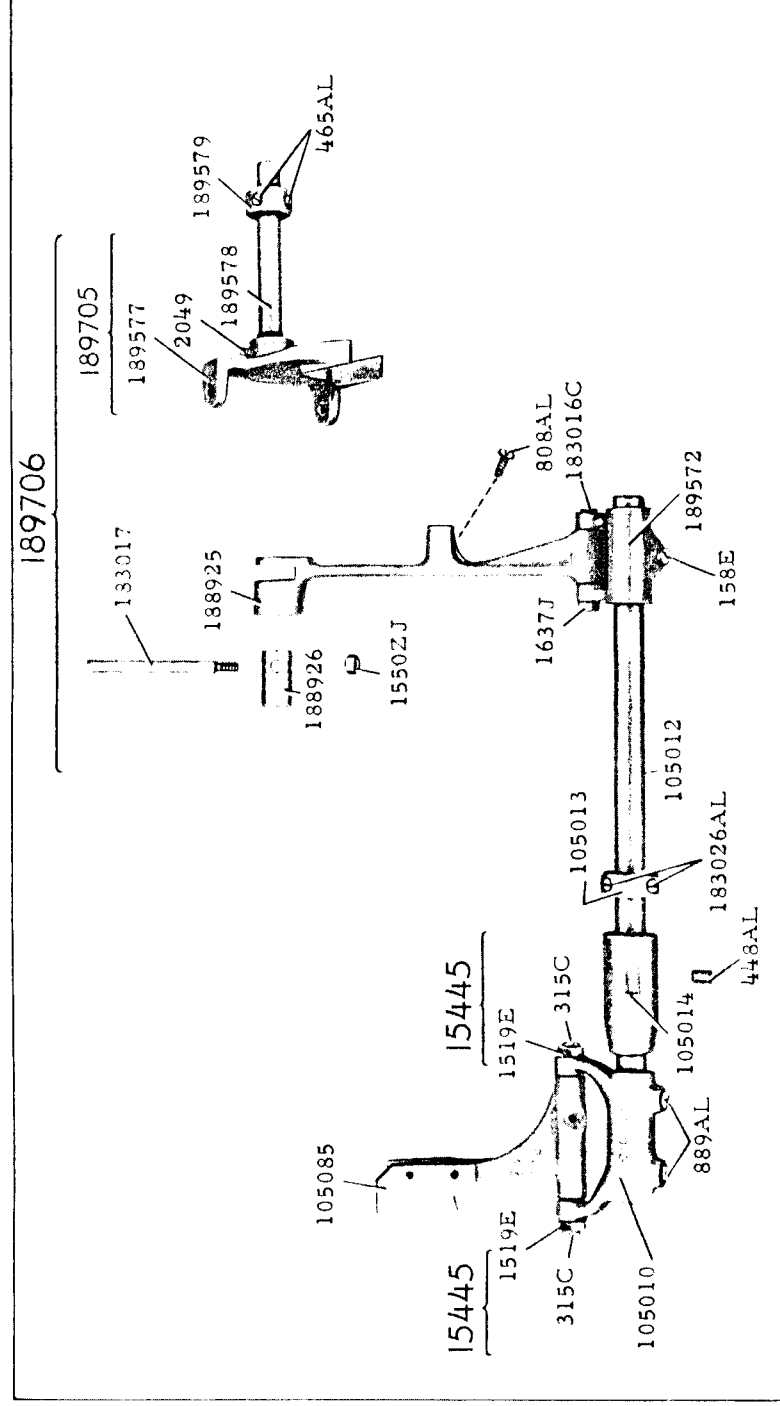
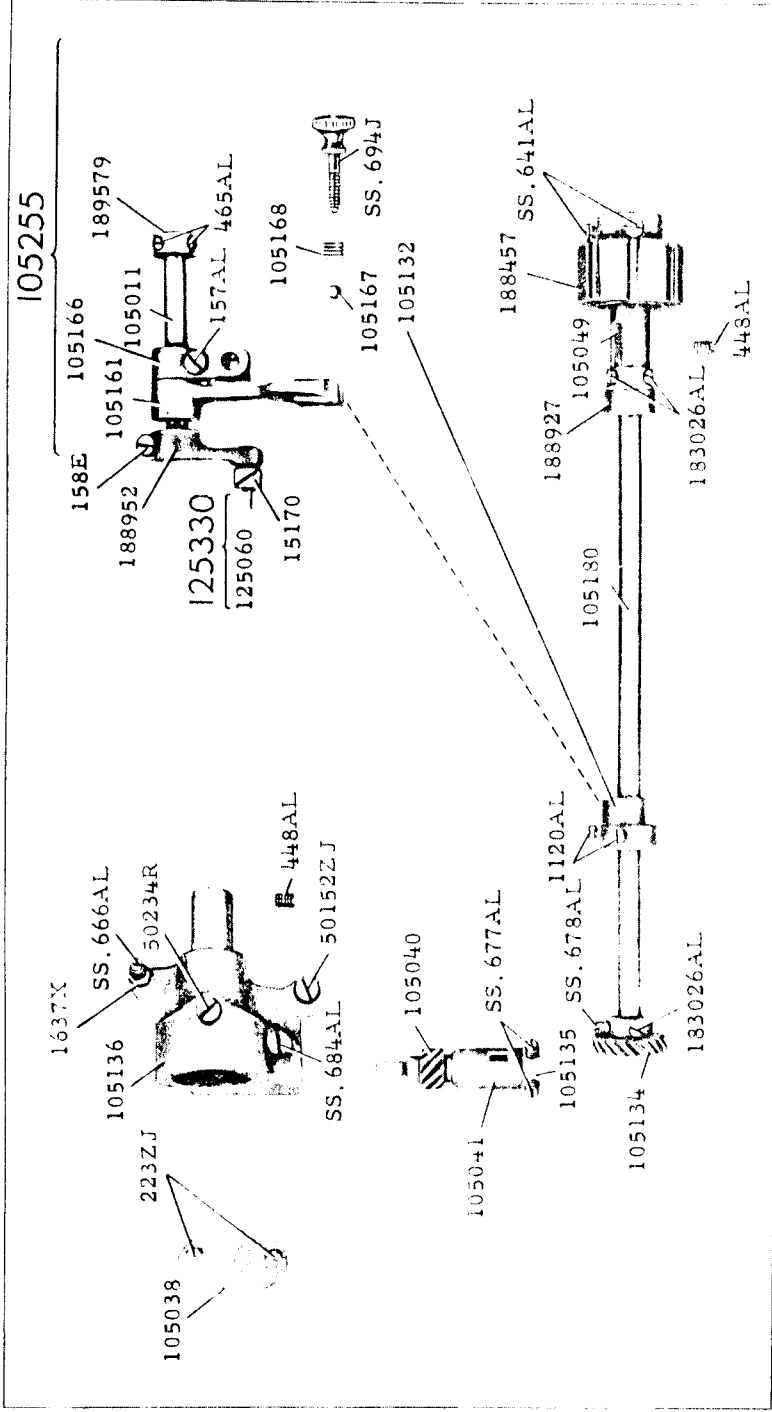

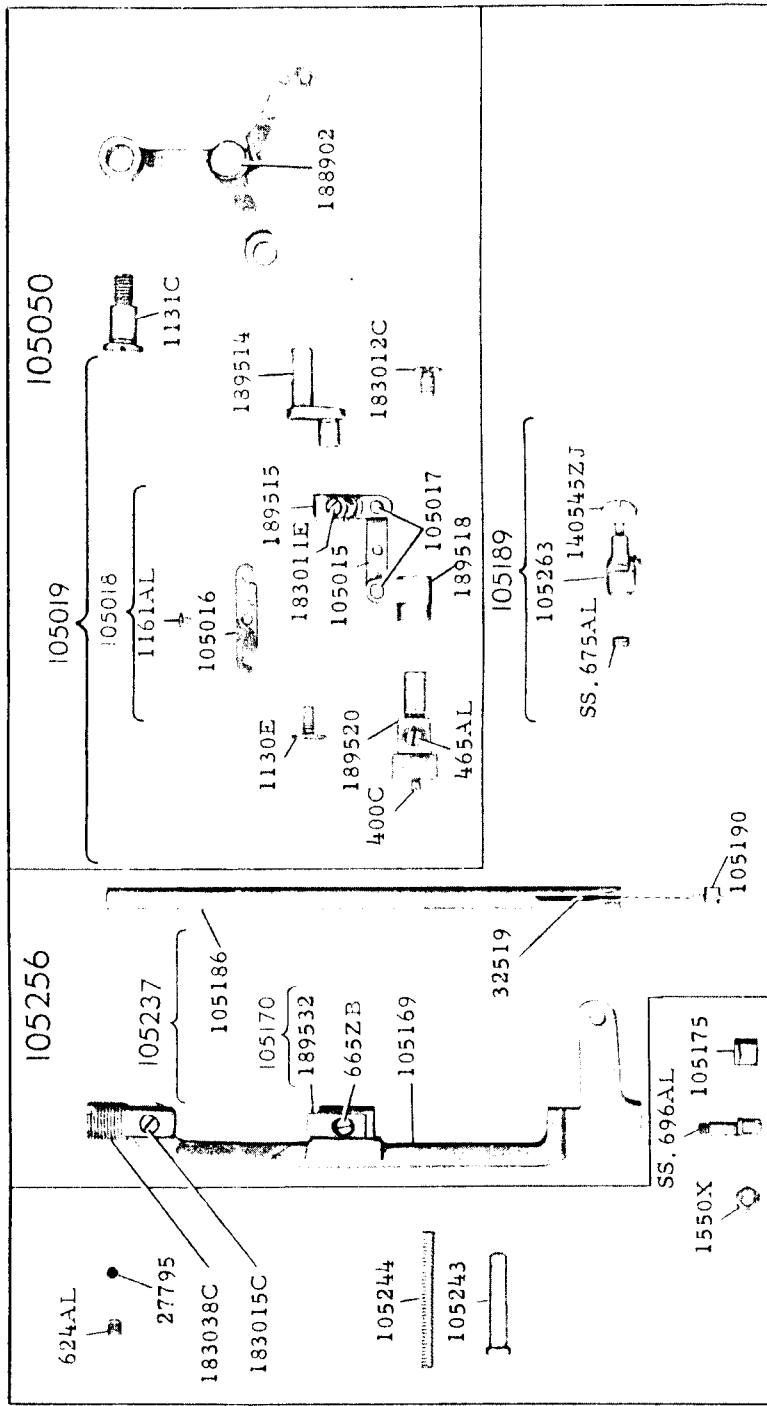
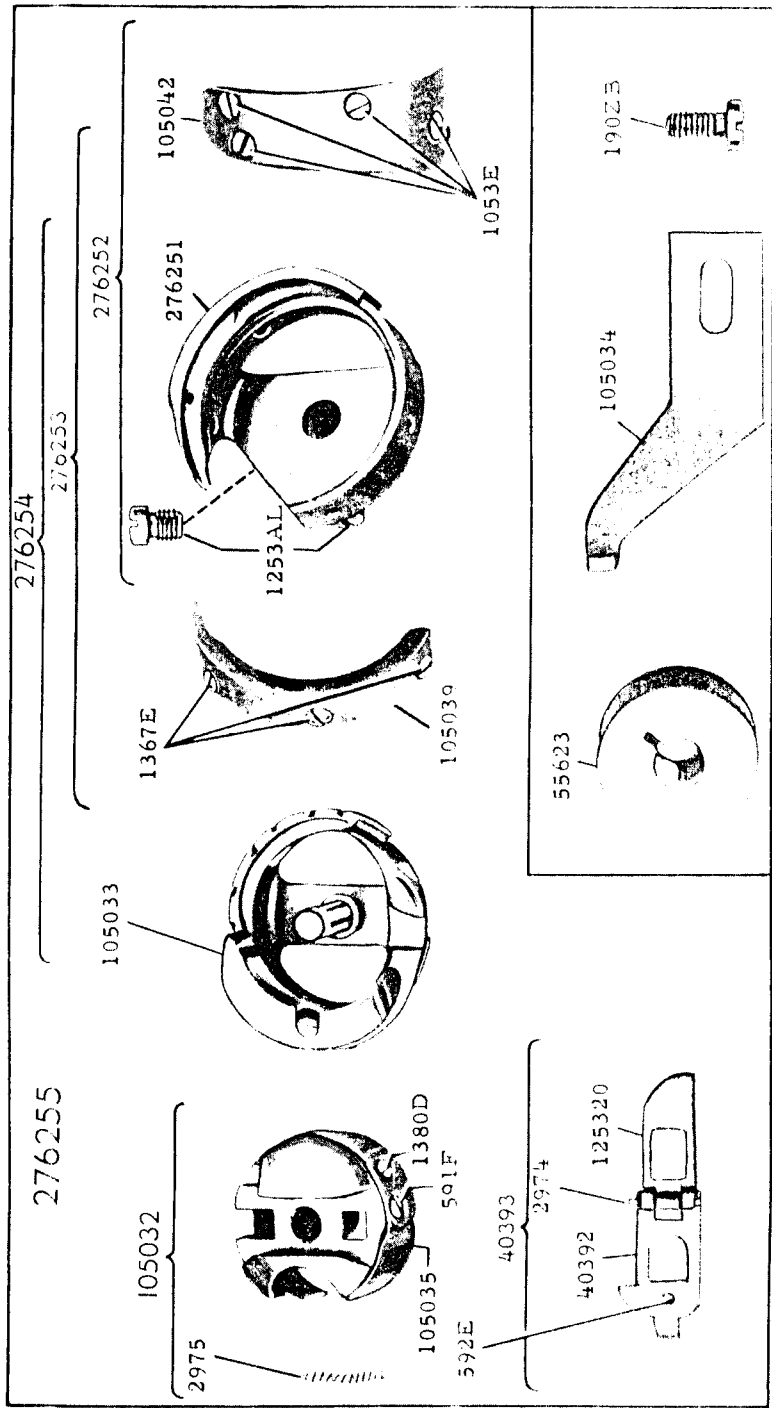

19006 - 1/2

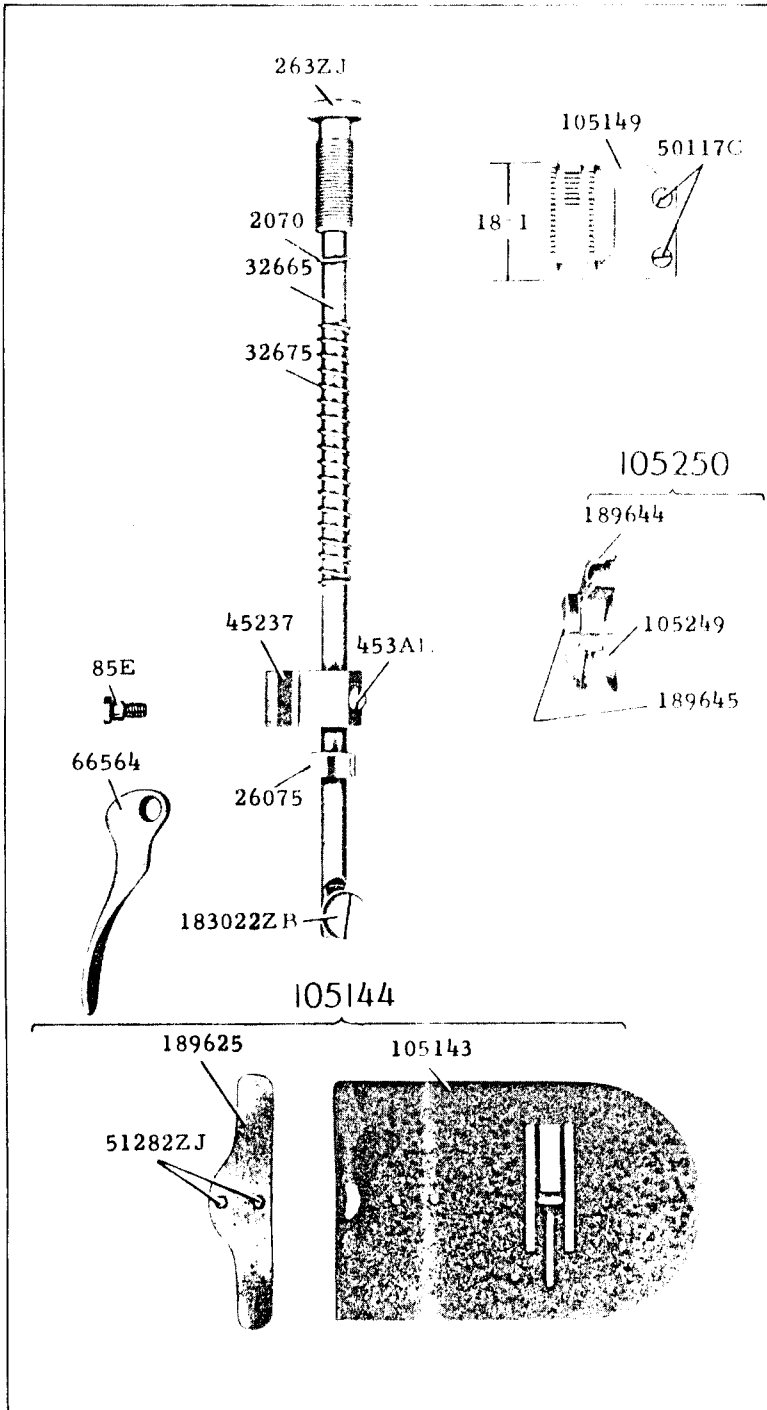

19007 - 3/8

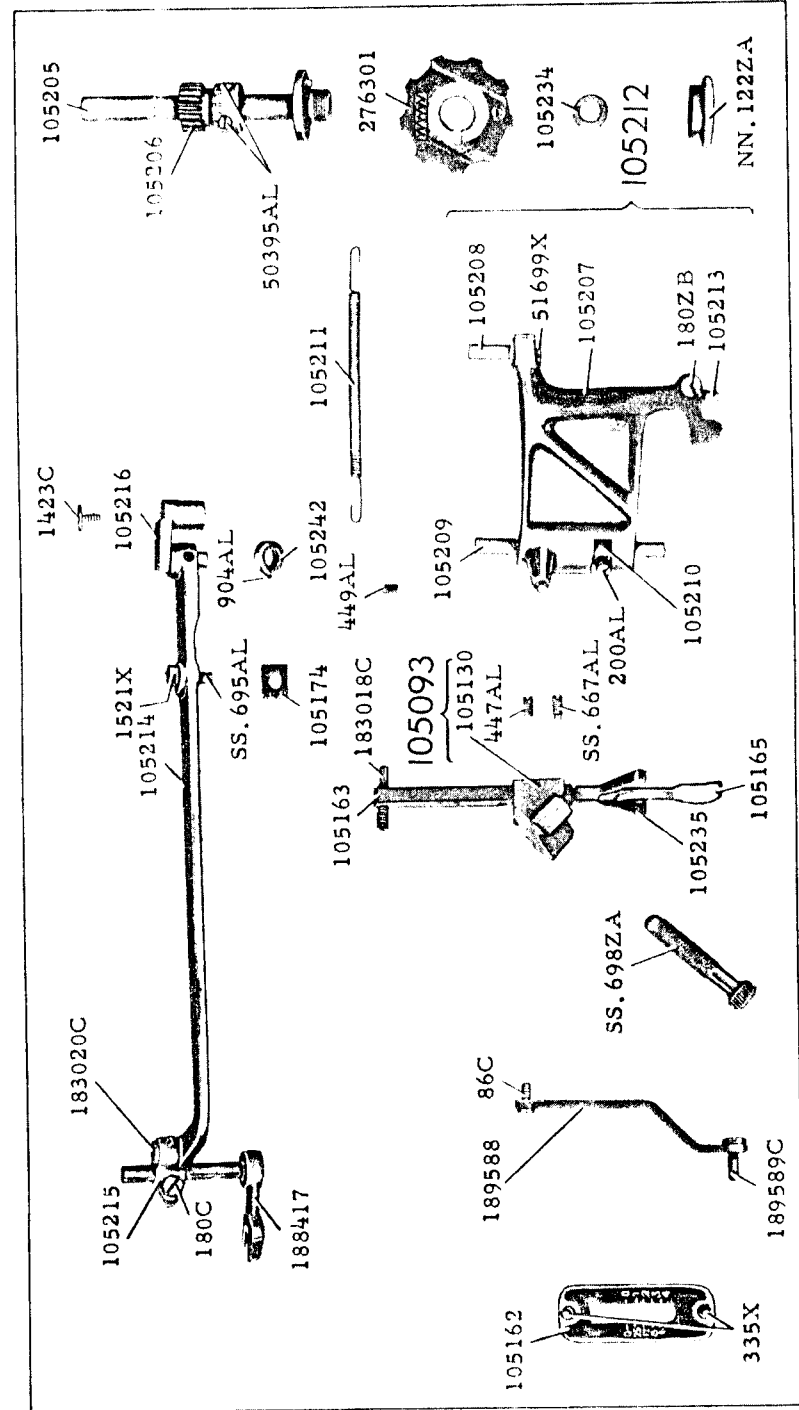



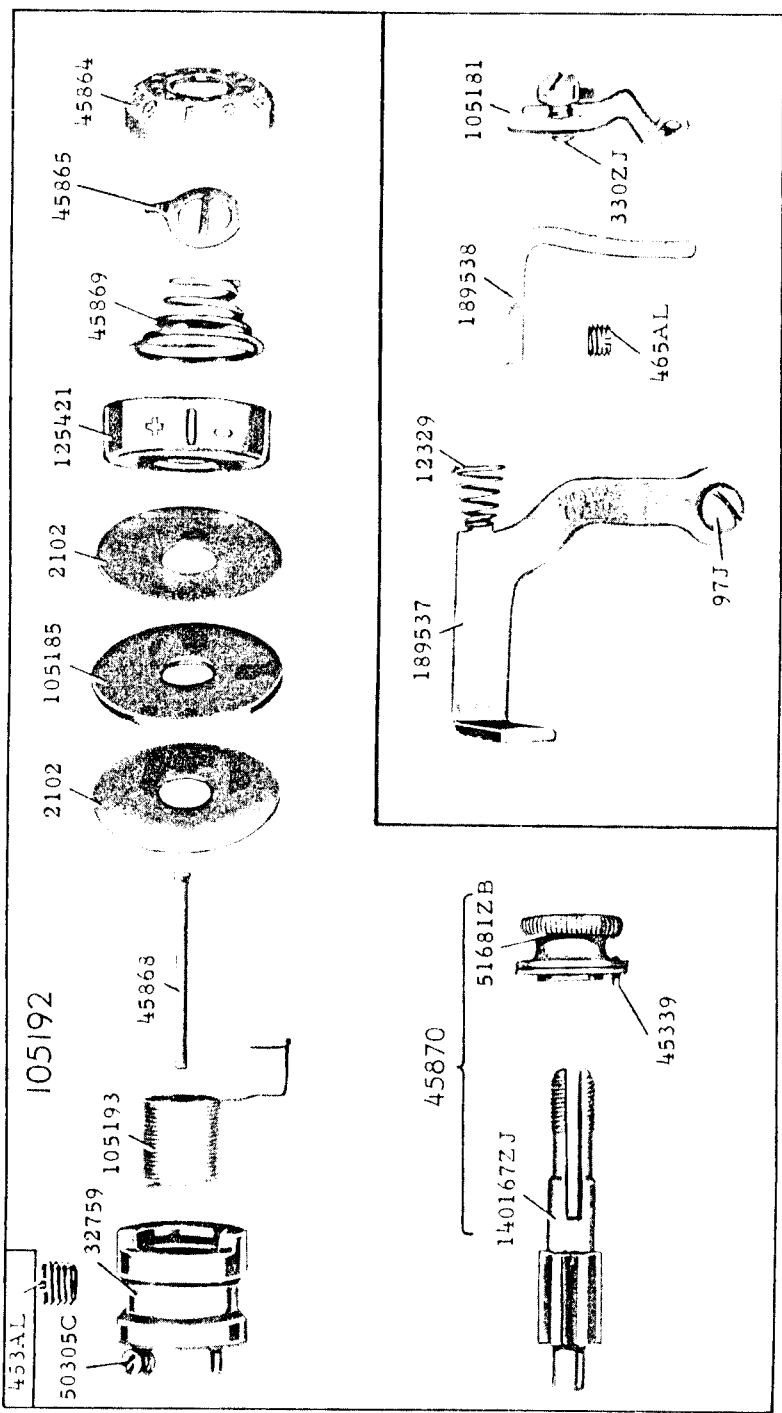
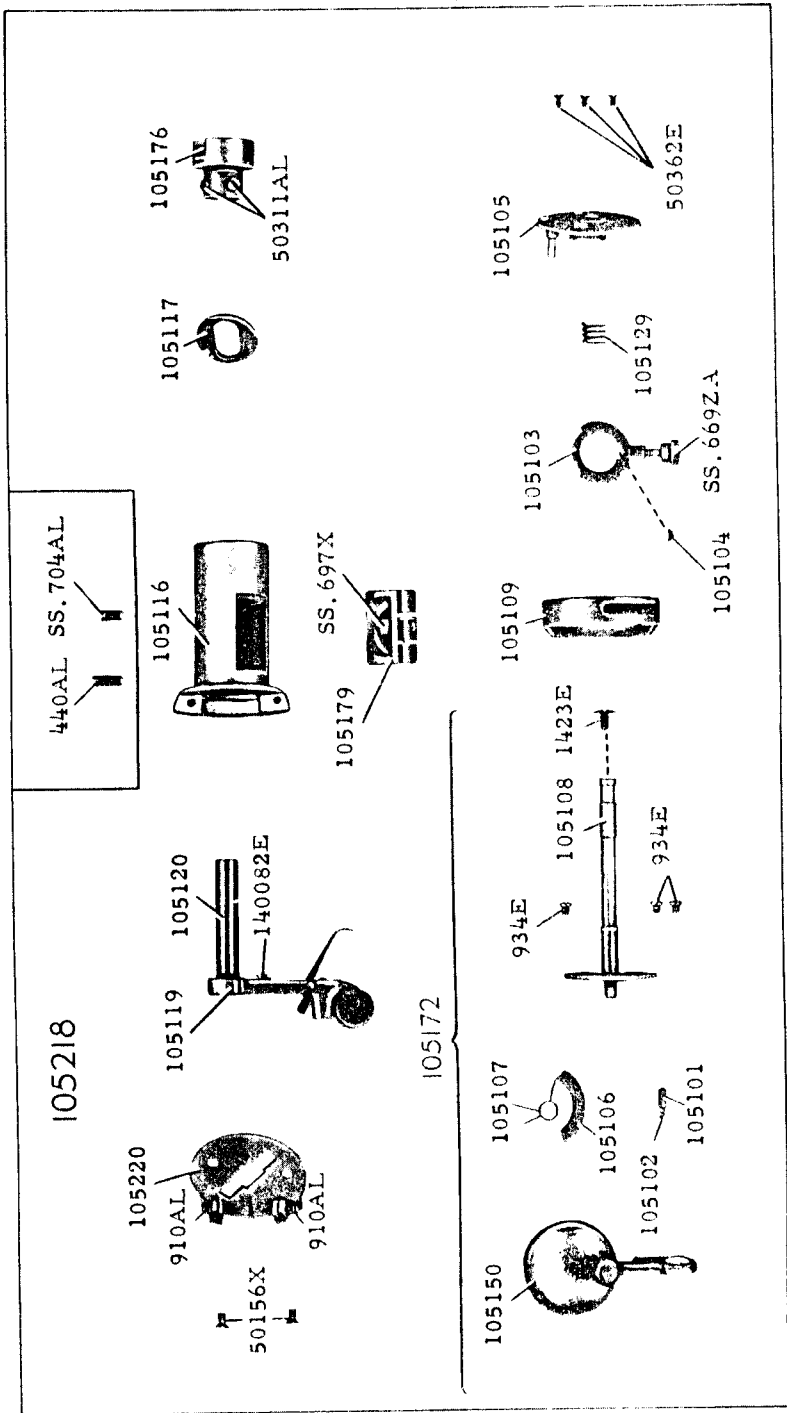

19010 - 5/8

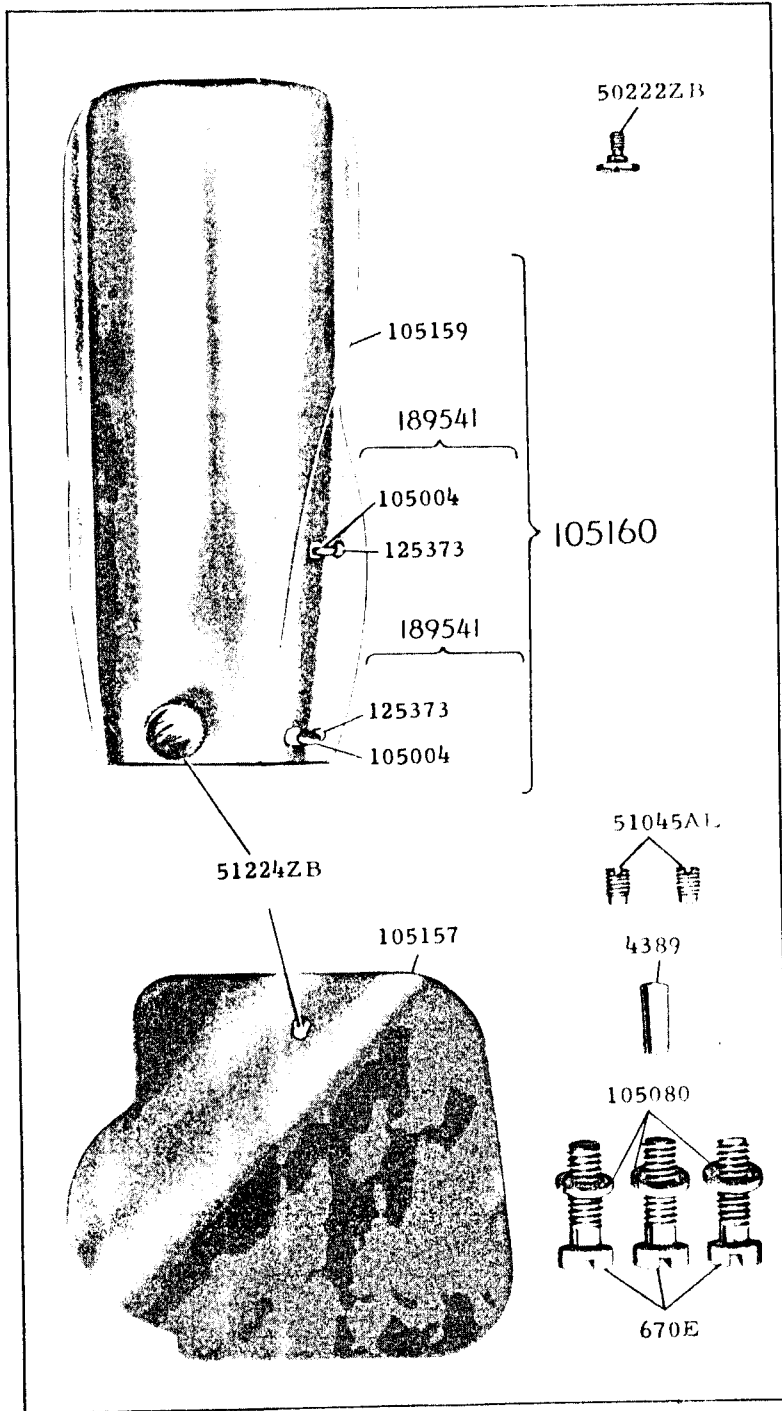

19011 - 5/8

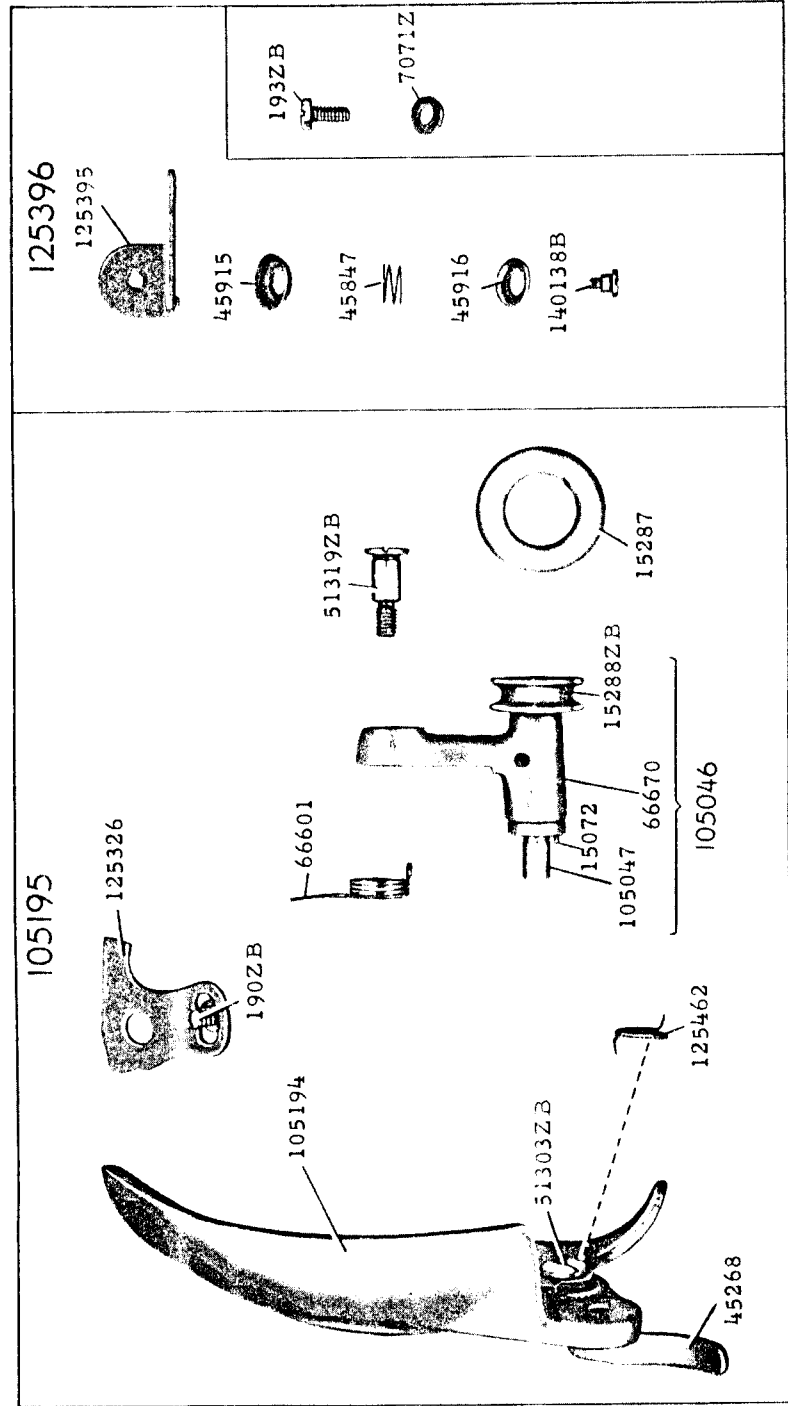

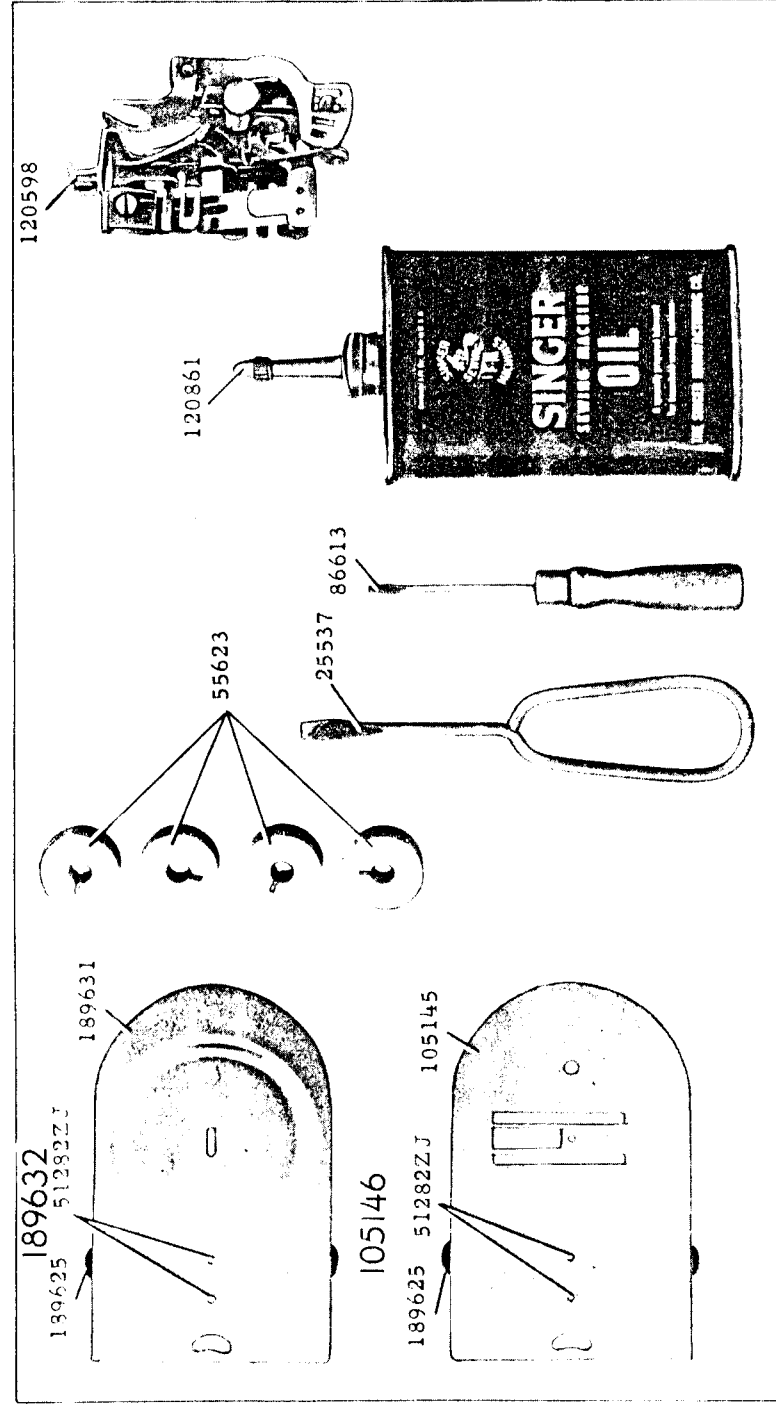
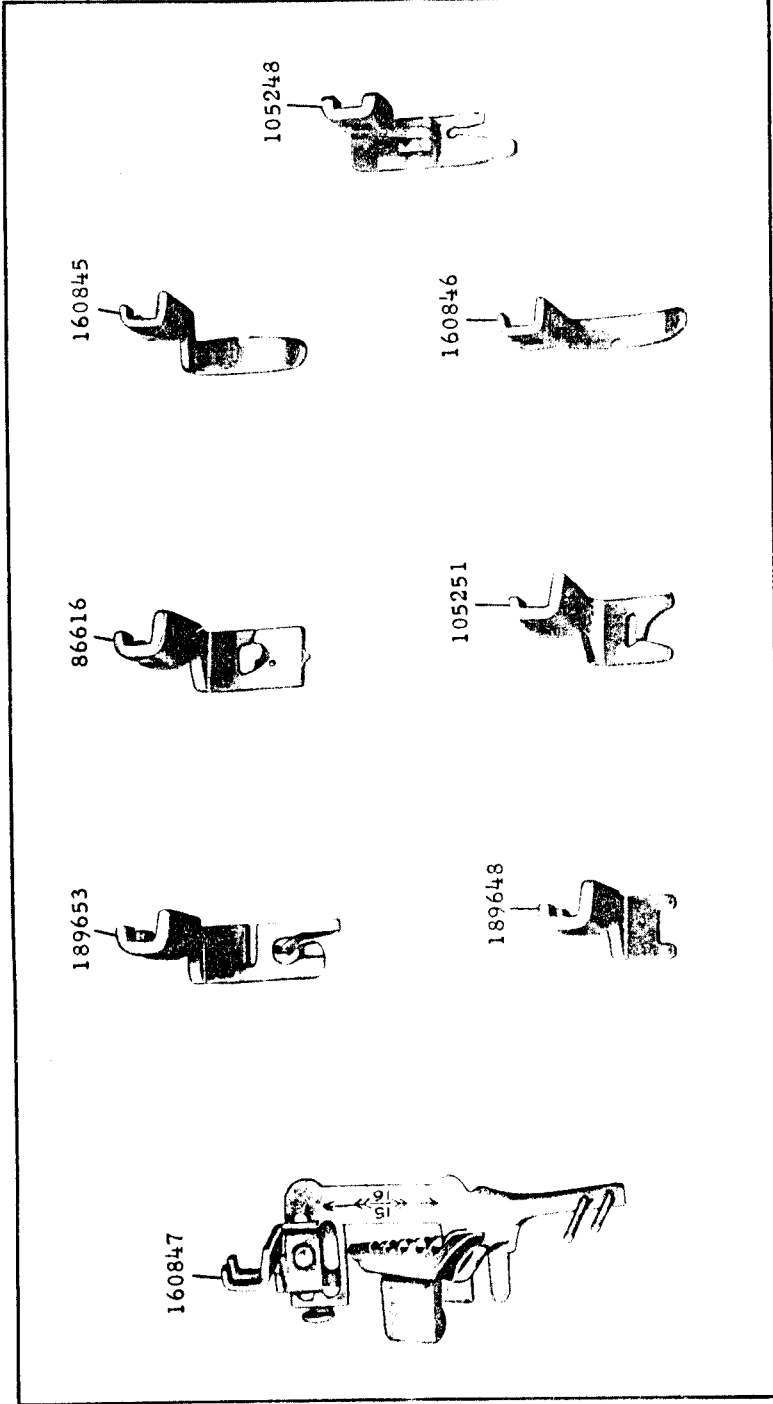

19014

276301

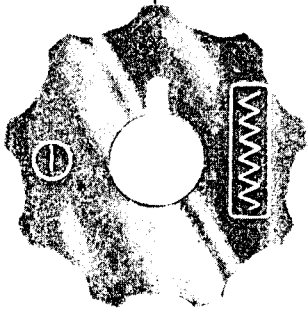

276302

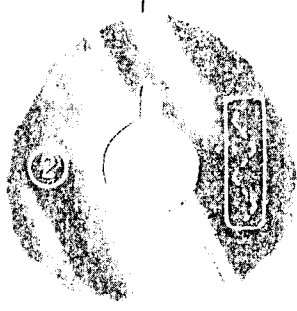

276303

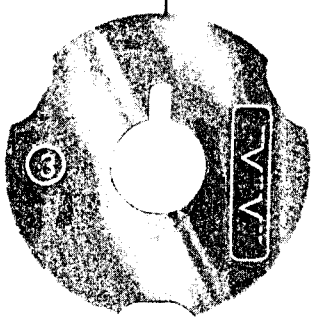

276304



276305

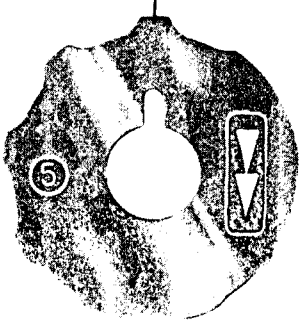

276306

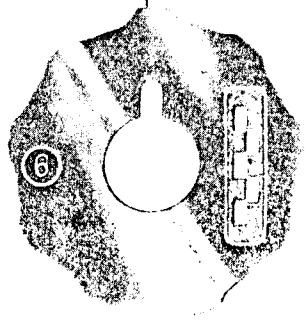

19015

276307

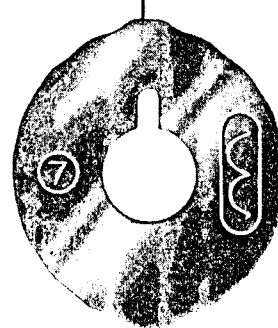

276308

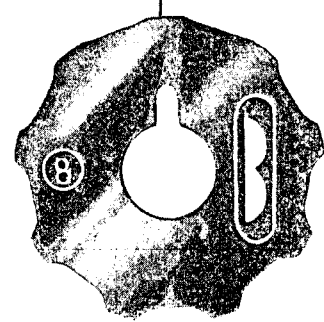

276309

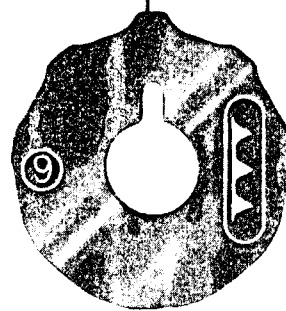

276310

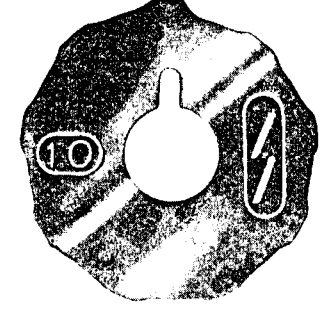

19016

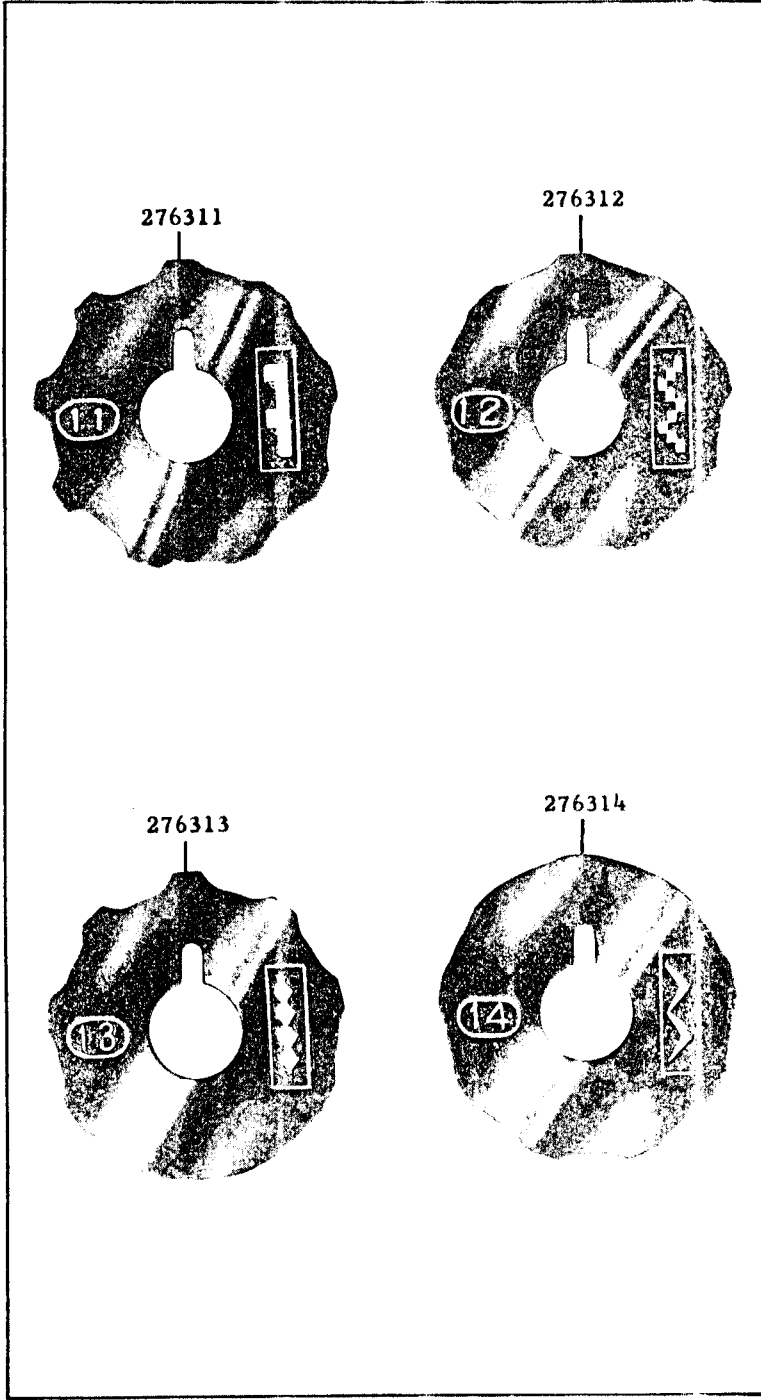

19021 - 1/3

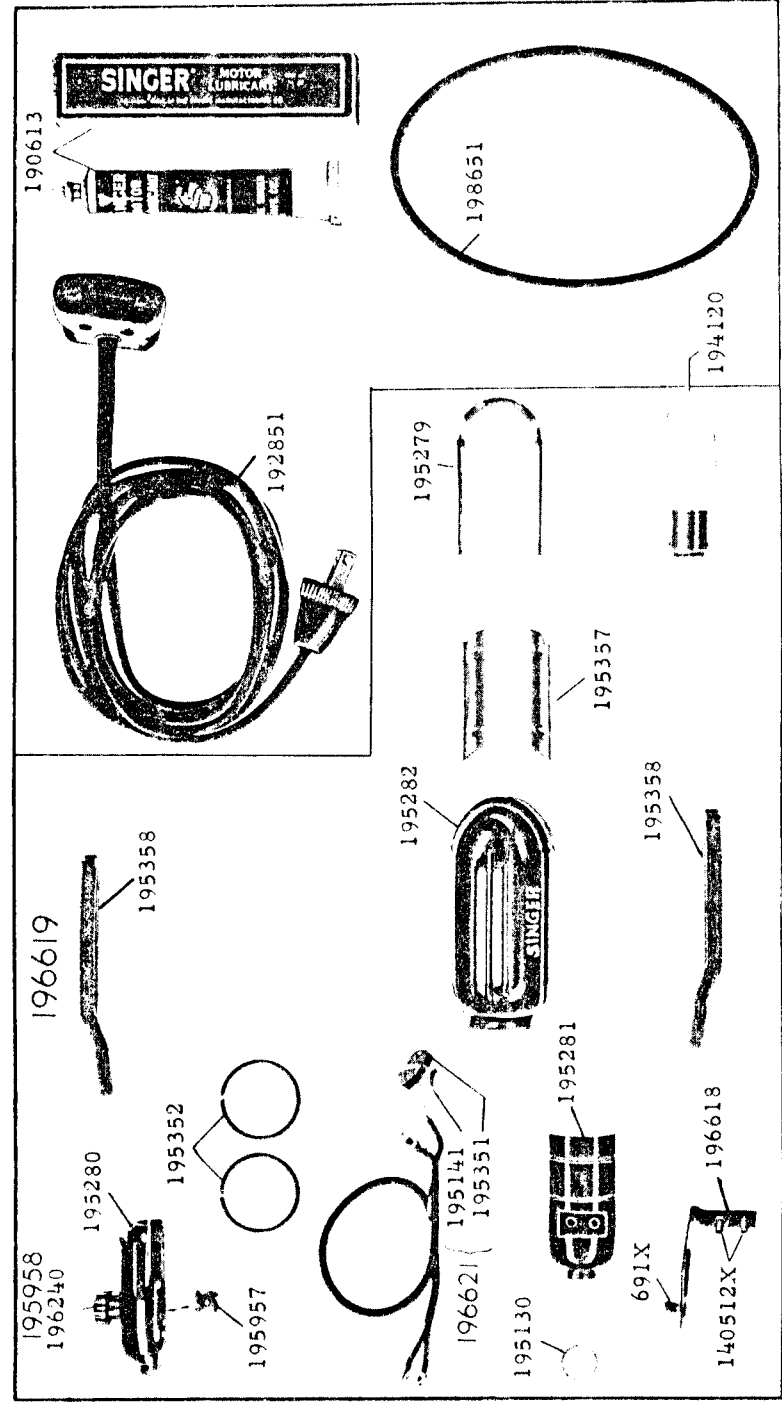

19022 - 1/2

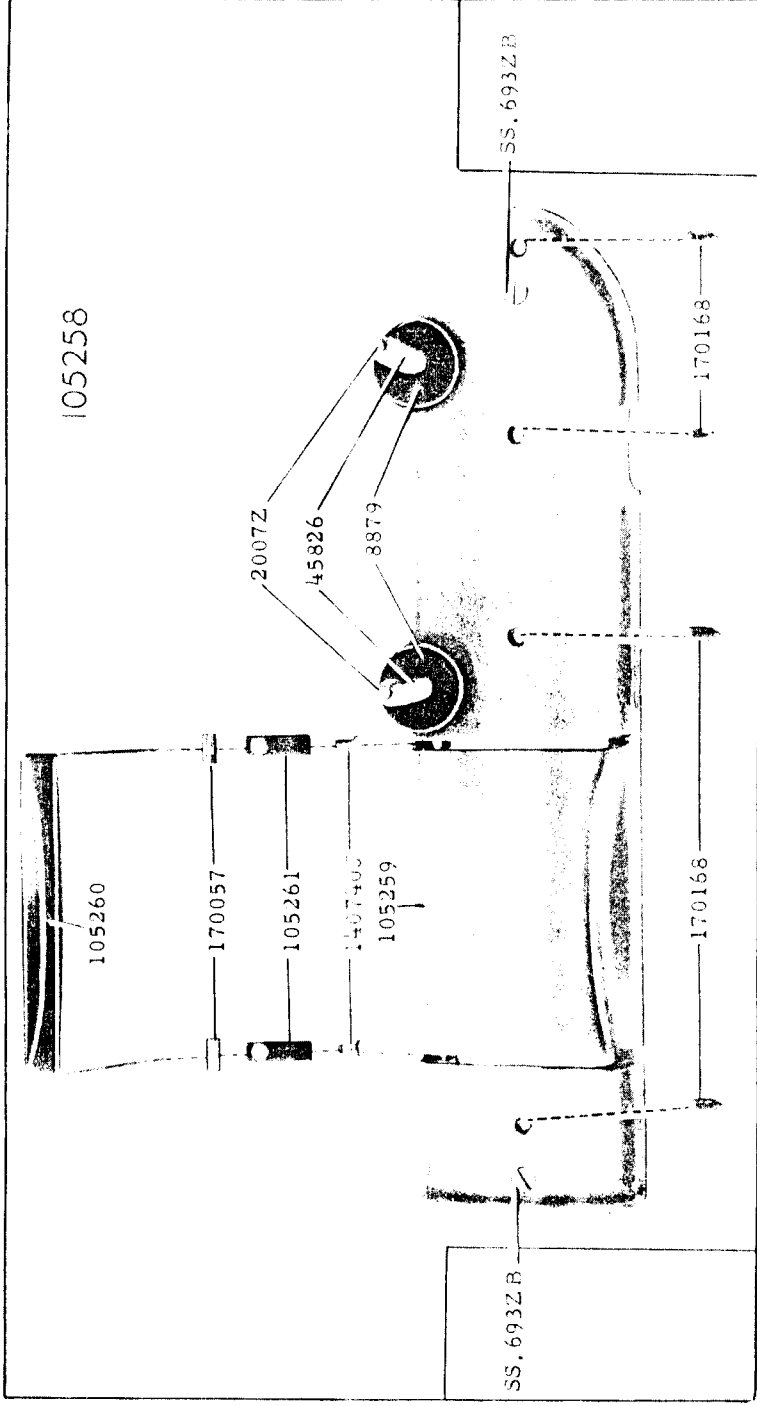

24623.1/3

