

Emilda

31017

41

10  
000

51

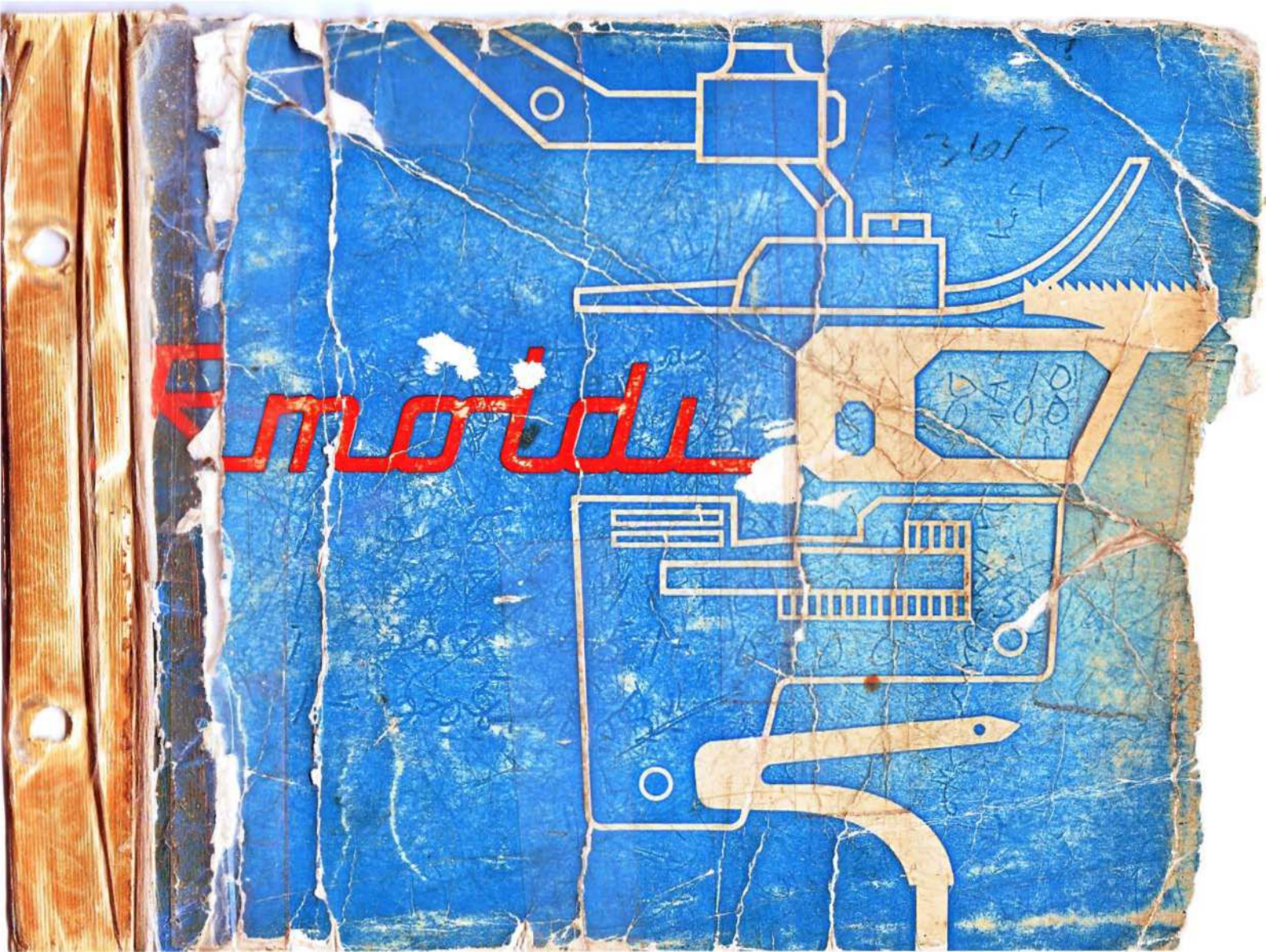



**R 300**

ORGANI DI CUCITURA  
PER MACCHINE TAGLIACUCE RIMOLDI

*Rimoldi* SEWING PARTS  
FOR RIMOLDI OVERLOCK MACHINES

NÄHORGANE DER  
RIMOLDI ÜBERWENDLING - MASCHINEN

ELEMENTS DE COUTURE  
POUR MACHINES SURJETEUSES-RASEUSES RIMOLDI

ORGANOS DE COSTURA  
PARA MÁQUINAS OVERLOCK RIMOLDI

Per tutte le teste serie Tagliacuce classe 227-028-228-327-329-330 i simboli delle viti di fissaggio degli organi di cucitura riportati sulle Tab. R 300 sono:

For all the overlock head series classes 227-028-228-327-329-330 the symbols of the fixing screws of sewing organs given in the R Tables 300 are:

Pour toutes les têtes série surjeteuses-raseuses 227-028-228-327-329-330 les symboles des vis de blocage des organes de coutures indiqués dans les Tables R 300 sont les suivants:

Fuer alle Überwendlichmaschinen-Oberteile Klasse 227-028-228-327-329-330 lauten die Symbole der Schrauben zum Fixieren der in den R Tabellen 300 angegebenen Naehorgane wie folgt:

vite fissa griffa sussidiaria differential feed-dog fixing screw vis de blocage griffe subsidiaire Klemmschraube fuer den Nebentransporteur	Classe Testa Head class Class Têtes Oberteile Klasse	vite fissaggio coltello superiore upper knife fixing screw vis blocage supérieur Klemmschraube fuer den oberen Messer	Classe Testa Head class Class Têtes Oberteile Klasse
<b>202488-0-10</b>	<b>227-028-228-327-329-330</b>	<b>202496-0-10</b>	<b>227-028-228-327</b>
vite fissa griffa principale main feed-dog fixing screw vis de blocage griffe principale Klemmschraube fuer den Haupttransporteur	Classe Testa Head Class Class Têtes Oberteile Klasse	<b>203087-0-10</b>	<b>327-00-1CD-06</b> <b>327-16-1CD-01</b> <b>327-29-1CD-03</b> <b>327-29-1CD-08</b>
<b>202489-0-10</b>	<b>227-028-228-327-329-330</b>	<b>203799-0-10</b>	<b>329-330</b>
vite fissa placca ago needle plate fixing screw vis de blocage plaque aiguille Klemmschraube fuer die Nadelplatte	Classe Testa Head class Class Têtes Oberteile Klasse	<b>724441-0-00</b>	<b>330-00-1CD-04</b>
<b>42-0-00</b>	<b>227-028-228-327-329-330</b>	<b>744573-0-00</b>	<b>330-12-1CD-01</b> <b>330-12-2CD-02</b> <b>330-22-1CD-01</b>
ansa crochet superiore inferiore and lower looper fixing screw blocage crochet supérieur et inférieur schraube fuer den oberen und unteren Greifer	Classe Testa Head Class Class Têtes Oberteile Klasse	vite fissaggio coltello inferiore lower knife fixing screw vis blocage couteau inférieur Klemmschraube fuer den unteren Messer	Classe Testa Head class Class Têtes Oberteile Klasse
<b>12-2-00</b>	<b>227-028-228-327-329-330</b>	<b>742457-2-00</b>	<b>227-028-228-327-329-330</b>



**Virginio Rimoldi & C. S.p.A.**  
Rockwell International

## INTRODUZIONE

Le Tabelle R 300 riportano i simboli delle teste serie Tagliacuce senza e con apparecchiatura ed i simboli dei relativi organi di cucitura previsti, in dotazione e a richiesta (contrassegnati con la lettera R), su tali Teste.

Le Tabelle R 300 dividono in 3 parti:

- La prima parte riporta in ordine progressivo i simboli delle teste classe: 023-227-327-028-228-329-330, con a fianco i simboli delle placche, delle griffe principali e sussidiarie, dei griffini, dei piedini, dei crochets superiori ed inferiori.  
I numeri riportati a fianco dei simboli delle placche ago, indicano le larghezze di costa in millimetri. I numeri riportati a fianco dei simboli delle griffe indicano il passo in millimetri della dentatura delle griffe stesse; quando tale numero non è riportato significa che le griffe sono ricoperte in Vulkollan.
- La seconda parte riporta, sempre in ordine progressivo, i simboli delle teste serie Tagliacuce dotate di apparecchiature speciali; a fianco sono riportati i simboli degli organi di cucitura in dotazione ed a richiesta previste quando le teste sono abbinata alle varie apparecchiature.
- La terza parte riporta suddivisi per denominazione (placche, griffe, ecc.) e nell'ambito di questa in ordine progressivo, tutti i simboli degli organi di cucitura con il relativo "SERVE PER,..". E' possibile infatti conoscendo il simbolo di una placca o di un crochet, sapere su quali teste con o senza apparecchiatura, tale placca o crochet sono previsti. Per sapere se su una determinata testa quella placca ago o crochet è in dotazione o a richiesta, occorre consultare la prima o la seconda parte a secondo dei casi.

## CONSULTAZIONE

La consultazione delle Tabelle R 300 può essere fatta conoscendo:

- 1°) Il simbolo della testa e si vuole sapere quali sono gli organi di cucitura previsti in dotazione o a richiesta (si consulta la 1ª e la 2ª parte).
- 2°) Il simbolo del pezzo e si vuole sapere su quali teste è previsto (si consulta la 3ª parte).

Nel primo caso occorre prestare molta attenzione ai contrassegni ●▲★ che sono riportati a fianco di alcuni organi di cucitura.

Infatti per una stessa testa gli organi di cucitura contrassegnati dallo stesso segno, devono sempre essere richiesti e montati insieme.

Es.: Se per la testa 327-00-1CD-07 si vuole la placca ago 203216-4-10 occorre richiedere anche il piedino simb. 202173-3-10 in quanto ha lo stesso segno della placca ago.

Fanno eccezione le griffe ricoperte in Vulkollan (senza l'indicazione del passo) per le quali l'esigenza sopraddetta vale solo nel caso in cui si richiede il piedino ricoperto in Teflon, mentre non vale quando si richiedono solo le griffe.

Es.: Se si vuole la testa 327-00-1CD-01 con il piedino ricoperto in "Teflon", simb. 202172-3-10 è necessario richiedere anche le griffe simbolo 202056-2-11 e 202060-2-11 ricoperte in Vulkollan.

Mentre se si vogliono le griffe 202056-2-11 e 202060-2-11 non è necessario richiedere il piedino simb. 202172-3-10

## INDICAZIONI SUGLI ORDINI

Quando si richiede una testa con montati particolari a richiesta, occorre indicare sull'ordine, nella riga successiva a quella riportante il simbolo della testa, il o i simboli dei particolari richiesti.

La riga di tali particolari deve essere una riga "zero,,".

Es.: Se si vuole la testa 327-00-1CD-07 con la placca ago per larghezza di costa 5 mm, l'ordine dovrà essere compilato come segue:

1 T327-00-1CD-07

0 CAMBIO MONTATA CON PLACCA 203218-0-10

## INTRODUCTION

The R 300 tables list the symbols of the Overlock head series both with and without devices. For each head the symbols of the sewing organs supplied with the machine are listed, as well as the alternative sewing organs that can be supplied on request (marked with the letter R).

The R 300 tables are divided into 3 parts:

- The first part lists the symbols of head classes 023,227,327,028,228,329,330 in numerical order, with the symbols for needle plates, main and differential feed dogs, chaining feed dogs, presser feet, and upper and lower loopers listed alongside. The numbers by the side of the needle plate symbols give the width of the bight in millimeters. The numbers by the side of the feed-dog symbols give the gauge of the feed-dog teeth in millimeters. When such a figure is not shown this indicates that the feed-dogs are Vulkollan covered.
- The second part lists in numerical order the symbols of the overlock head series fitted with special devices. Alongside are listed the symbols of the sewing organs normally supplied with the machine, as well as the alternatives that can be supplied on request.
- The third part gives the symbols of all sewing organs divided into categories (needle plates, feed-dogs etc), with the symbols in each category arranged in numerical order.  
For each sewing organ the machines on which it can be used are listed. Thus in knowing the symbol of a needle plate or a looper it is possible to know on which overlock heads, either with or without devices, it can be used.  
To know whether on a given head a certain needle plate or looper is fitted as a standard part or on special request, reference must be made to the first or second part of the table, as the case requires.

## USING THE TABLES

To use the R 300 tables one of the following facts must be known:

- 1<sup>o</sup>) The symbol of the head in order to find out which sewing organs are supplied as standard and which are supplied on special request (1st and 2nd parts).
- 2<sup>o</sup>) The symbol of the part in order to know on which heads it can be fitted (3rd part).

For references of the first type special attention should be given to the signs ●▲★ which are shown alongside some of the part symbols. For a given head the sewing organs marked with the same sign must always be ordered and mounted together. Eg. If needle plate 203216-4-10 is required for head 327-00-1CD-07 then presserfoot 202173-3-10 must be used in conjunction as it is marked with the same sign as the needle plate.

The exception is with Vulkollan covered feed-dogs (without note of gauge) for which the abovementioned system is valid only when a Teflon covered presser foot is to be mounted; whereas the system becomes invalid when the feed-dogs alone are to be mounted. Eg. If the Teflon covered presser foot 202172-3-10 is chosen for the head 327-00-1CD-01 it is also necessary to use Vulkollan covered feed-dogs 202056-2-11 and 202060-2-11. Whereas if Vulkollan covered feed-dogs 202056-2-11 and 203060-2-11 are chosen it is not necessary to use presser foot 202172-3-10.

## INTRODUCTION

Les Tableaux R 300 reportent les symboles des machines surjeteuses-raseuses sans et avec dispositif ainsi que les symboles des relatifs organes de couture prévus, en dotation et sur demande (marqués de la lettre R), sur ces machines.

Les Tableaux R 300 se divisent en 3 parties:

- La première partie reporte par ordre progressif les symboles des machines classe: 023-227-327-028-228-329-330 et à côté les symboles des plaques, des griffes principales et subsidiaires, des petites griffes, des pieds presseurs, des crochets supérieurs et inférieurs.  
Les nombres à côté des symboles des plaques à aiguille, indiquent les largeurs du surjet en millimètres. Les nombres à côté des symboles des griffes indiquent le pas de denture en millimètres des griffes: si ces nombres ne sont pas reportés, ça signifie que les griffes sont recouvertes en Vulkollan.
- La deuxième partie reporte, toujours par ordre progressif, les symboles des machines surjeteuses-raseuses équipées de dispositifs spéciaux; à côté sont indiqués les symboles des organes de couture en dotation et sur demande prévus lorsque les machines sont couplées aux différents dispositifs.
- La troisième partie reporte subdivisés d'après la dénomination (plaques, griffes etc.) et par ordre progressif, tous les symboles des organes de couture avec le relatif "SERT POUR". En effet, si on connaît le symbole d'une plaque ou d'un crochet, il est possible de savoir pour quelles machines avec ou sans dispositif la plaque ou le crochet sont prévus. Pour savoir si la plaque à aiguille ou le crochet est en dotation ou sur demande sur une machine déterminée, il faut consulter la première ou la deuxième partie selon les cas.

## CONSULTATION

La consultation des Tableaux R 300 peut être faite si l'on connaît:

- 1<sup>o</sup>) Le symbole de la machine et si l'on veut savoir quels sont les organes de couture prévus en dotation ou sur demande (on consulte la 1<sup>ère</sup> et la 2<sup>ème</sup> partie).
- 2<sup>o</sup>) Le symbole de la pièce et si l'on veut savoir pour quelles machines elle est prévue (on consulte la 3<sup>ème</sup> partie).

Dans le premier cas il faut prêter beaucoup d'attention aux marques ●▲★ qui sont indiquées à côté de certains organes de couture. En effet, pour une même machine les organes de couture avec la même marque, doivent être demandés et montés toujours ensemble. Ex.: si pour la machine 327-00-1CD-07 on demande la plaque à aiguille 203216-4-10, il faut demander aussi le pied symbole 202173-3-10, car il a la même marque que la plaque à aiguille.

Font exception les griffes recouvertes en Vulkollan (sans l'indication du pas) pour lesquelles cette spécification n'est requise que dans le cas où l'on demande le pied presseur recouvert en Teflon, tandis qu'elle n'est pas requise si l'on demande les seules griffes. Ex.: Si l'on veut la tête 327-00-1CD-01 avec le pied presseur recouvert en "Teflon" symb. 202172-3-10, il faut demander aussi les griffes recouvertes en Vulkollan symb. 202056-2-11 et 202060-2-11.

Tandis que si l'on veut les griffes 202056-2-11 et 202060-2-11, il ne faut pas demander aussi le pied presseur symb. 202172-3-10.

## EINLEITUNG

Die R Tabellen 300 enthalten die Bezeichnungen der Ueberwendlich-Maschinenoberteile mit oder ohne Vorrichtungen sowie die Symbole der entsprechenden Naehorgane, welche entweder als Zubehoer oder auf Rueckfrage (mit dem Buchstaben R gekennzeichnet) vorgesehen sind.

Die R Tabellen 300 bestehen aus drei Teilen:

- Der erste Teil fasst in fortschreitender Reihenfolge die Maschinenbezeichnungen der Klassen 023-227-327-028-228-329-330 zusammen, wobei daneben die Symbole der Stichplatten, der Haupt- und Nabentransporteur, der Kleintransporteur, der Drueckerfuesse und der oberen und unteren Greifer aufgefuehrt sind. Die neben der Stichplattensymbole angegebenen Nummern stellen die Nahtbreite in Millimetern dar. Die neben den Symbolen der Transporteur aufgefuehrten Nummern geben den Millimeterabstand der Verzahnung der Transporteur an; ist diese Nummer nicht angegeben, so sind die Transporteur mit Vulkollan belegt.
- Der zweite Teil enthaelt, immer in fortschreitender Reihenfolge, die Symbole der mit Spezialvorrichtungen ausgestatteten Ueberwendlich-Maschinenoberteile; daneben sind auch die als Zubehoer sowie auf Rueckfrage gelieferten Naehorgane aufgefuehrt, welche beim Anbau der verschiedenen Vorrichtungen notwendig werden.
- Der dritte Teil enthaelt lt. Benennung eingeteilt (Stichplatten, Transporteur, usw.) und in fortschreitender Reihenfolge alle Naehorgansymbole der Ueberwendlichmaschinen mit dem entsprechenden Vermerk: "DIENT FUER". Dies ermoeoglicht zu wissen, auf welche Ueberwendlichmaschine z. B. eine gewisse Stichplatte oder Greifer, von welchen man das Symbol kennt, vorgesehen sind. Will man wissen, ob diese Stichplatte bzm. jener Greifer auf eine bestimmte Maschine als Zubehoer oder auf Rueckfrage geliefert wird, so muss man im ersten oder im zweiten Teil der R Tabellen 300 (je nach Fall) nachschlagen.

## NACHSCHLAGEN

Das Nachschlagen der R Tabellen 300 kann durchgefuehrt werden, wenn man folgende Angaben besitzt:

- 1<sup>o</sup>) Das Symbol des Maschinenoberteils, um zu wissen, welche die als Zubehoer oder auf Rueckfrage gelieferten Naehorgane sind (man schlaegt im ersten und im zweiten Teil nach).
- 2<sup>o</sup>) Das Ersatzteilsymbol, um zu wissen auf welche Maschine dieses Teil vorgesehen ist (man schlaegt im dritten Teil nach).

Im ersten Fall muss man sehr gut auf die Kennzeichen ● ▲ ★ achten, welche neben einigen Naehorganen angegeben sind, da alle mit derselben Erkennungsmarke gekennzeichneten Naehorgane fuer eine bestimmte Maschine zusammen bestellt und montiert werden muessen.

Z.B. Wenn man fuer die Klasse 327-00-1CD-07 die Stichplatte 203216-4-10 zu erhalten wuenscht, so muss man auch den Drueckerfuss Nr. 202173-3-10 bestellen, da dieser mit demselben Zeichen wie die Stichplatte gekennzeichnet ist.

Eine Ausnahme stellen die mit Vulkollan belegten Transporteur dar (ohne Teilungangabe — Verzahnung), fuer welche oben-angefuehrtes nur gilt, wenn man den mit Teflon belegten Drueckerfuss wuenscht; wogegen es nicht notwendig ist, wenn man nur die Transporteur bestellt.

Z.B. Wenn man die Klasse 327-00-1CD-01 mit dem mit "Teflon," belegten Drueckerfuss Nr. 202173-3-10 zu erhalten wuenscht, so muss man auch die mit Vulkollan belegten Transporteur Nr. 202056-2-11 und 202060-2-11 bestellen.

Sollte man dagegen die Transporteur 202056-2-11 und 202060-2-11 erwuenschen, dann ist es nicht noetig, den Drueckerfuss Nr. 202172-3-10 zu bestellen.

SERVE PER - SERVES FOR - SERT POUR - DIENT FUER

**1**

ELENCO TESTE  
LISTE OF MACHINE HEADS  
LISTE DES TETES  
LISTE DER MASCHINENOBerteile

**2**

ELENCO TESTE CON APPARECCHIATURE  
LIST OF MACHINE HEADS WITH SPECIAL ATTACHMENTS  
LISTE DES TETES AVEC DISPOSITIFS SPECIAUX  
LISTE DER MASCHINENOBerteile MIT SPEZIALVORRICHTUNGEN

**A**

PLACCA AGO  
NEEDLE PLATE  
PLAQUE AIGUILLE  
STICHPLATTE

**B**

GRIFFA PRINCIPALE  
MAIN FEED DOG  
GRIFFE PRINCIPALE  
HAUPT-TRANSPORTEUR

**C**

GRIFFA SUSSIDIARIA  
AUXILIARY FEED DOG  
GRIFFE SUBSIDIAIRE  
HILFS-TRANSPORTEUR

**D**

GRIFFINO  
CHAINING FEED DOG  
GRIFFE CHAINETTE  
KLEIN-TRANSPORTEUR

**E**

PIEDINO  
PRESSER FOOT  
PIED-PRESSEUR  
DRUECKERFUSS

**F**

CROCHET SUPERIORE  
UPPER LOOPER  
CROCHET SUPERIEUR  
OBERGREIFER

**G**

CROCHET INFERIORE  
LOWER LOOPER  
CROCHET INFERIEUR  
UNTERGREIFER



**Rumoldi**• • • Vedere note parte introduttiva  
See introductory notesVoir notes d'introduction  
Siehe Anmerkungen der Einleitung

00		Indice		TAB		<b>R300</b>	
Data				Foglio 1		Segue F. 2	

Simbolo testa Machine symbol Symbole de la tête Symbol des Obertheile	Placca ago Needle plate Plaque à aiguille Stichplatte	Griffa principale Main feed dog Griffe principale Haupt-Transporteur	Griffa sussidiaria Auxiliary feed dog Griffe subsidiaire Hilfs-Transporteur	Griffino Chaining feed dog Griffe p. chaînette Klein-Transporteur	Piedino Presser foot Pied-presseur Drueckerfuss	Crochet superiore Upper looper Crochet supérieur Oberer Greifer	Crochet inferiore Lower looper Crochet inférieur Unterer Greifer			
023-04-01	200765-0-10	9	200758-0-10	1,5		200767-3-10	200760-0-10	200560-0-11		
023-04-02	200790-0-10	9	200782-0-10	1,5		200791-3-10	200760-0-10	200560-0-11		
023-04-03	200765-0-10	9	200758-0-10	1,5		200767-3-10	200760-0-10	200560-0-11		
023-04-04	200765-0-10	9	200758-0-10	1,5		200767-3-10	200760-0-10	200562-0-11		
023-04-05	200790-0-10	9	200782-0-10	1,5		200791-3-10	200760-0-10	200562-0-11		
227-34-01	203853-4-10	3	203838-0-10	1,5	203841-0-10	1,5	203967-3-10	202092-0-10	202094-0-11	
227-34-03	203854-4-10	3	203840-2-11	—	203843-2-11	—	203426-0-10	203866-3-10	202092-0-10	202094-0-11

Indice
Date
Vr.

Si rende noto che il contenuto della presente tavola non può essere utilizzato o riprodotto in alcun modo senza il permesso scritto della proprietaria S.p.A. V. R. Rumoldi & C. La stessa intende tutelare i suoi diritti.



# Rimoldi

• • •

Vedere note parte introduttiva  
See introductory notes

Voir notes d'introduction  
Siehe Anmerkungen der Einleitung

Indice  
00  
Data  
TAB  
R300  
Foglio 3 Segue F. 4

Simbolo testa Machine symbol Symbole de la tête Symbol des Obertheile	Placca ago Needle plate Plaque à aiguille Stichplatte	Griffa principale Main feed dog Griffe principale Haupt-Transporteur	Griffa sussidiaria Auxiliary feed dog Griffe subsidiaire Hilfs-Transporteur	Griffino Chaining feed dog Griffe p. chaînette Klein-Transporteur	Piedino Presser foot Pied-presseur Drueckerfuss	Crochet superiore Upper looper Crochet supérieur Oberer Greifer	Crochet inferiore Lower looper Crochet inférieur Unterer Greifer			
327-00-1CD-09	203409-4-01 203347-2-10 203349-2-10 <i>2034 615</i>	2 1,2 R 1,4 R	203335-2-11 <i>2018</i>	-	203338-2-11 <i>0168</i>	-	202061-0-10 <i>2016</i>	203362-3-10 <i>2016</i> 203360-3-10 203361-3-10 205940-3-00	202090-0-10	202094-0-11
327-00-1CD-10	203399-0-10 203398-0-10	1 1,5 R	203332-0-10	1,5	203062-0-10	1,5	202061-0-10	203366-3-10	203429-0-10	202094-0-11
327-00-1CD-25	203047-0-20 203048-0-20	3 3,5 R	203060-0-10 ✓ 203095-2-00 •	1,5 - R	203062-0-10 ✓ 203094-2-00 •	1,5 - R	202609-0-10 ✓	203050-3-10 207100-3-00	204033-0-10 R	202094-0-11 X
327-00-1CD-26	203072-0-10	2	203060-0-10 203095-2-00 •	1,5 - R	203062-0-10 203094-2-00 •	1,5 - R	202061-0-10	203077-3-10	204033-0-10 204021-0-10 R	202094-0-11 202095-0-11 R
327-00-1CD-27	203072-0-10	2	203060-0-10 203095-2-00 •	1,5 - R	203062-0-10 203094-2-00 •	1,5 - R	202061-0-10	203803-3-10	204033-0-10 204021-0-10 R	202094-0-11 202095-0-11 R
327-00-1CD-29	203813-0-10	5	203060-0-10 203095-2-00 •	1,5 - R	203062-0-10 203094-2-00 •	1,5 - R	202061-0-10	203815-3-10	204033-0-10 204021-0-10 R	202094-0-11 202095-0-11 R
327-00-1CD-30	203035-0-10 203014-0-10 203037-0-10	4,5 7 R 3,1 R	203028-0-10 203001-0-10 203030-2-11 •	1,5 2 R - R	203031-0-10 203002-0-10 203033-2-11 •	1,5 2 R - R	203004-0-10	207076-3-00 <i>744</i>	204033-0-10	202094-0-11
327-00-1CD-31	203219-0-10	3,8	203199-0-10 203201-2-11 •	1,5 - R	202057-0-10 202060-2-11 •	1,5 - R	202609-0-10	203162-3-10	204033-0-10	202094-0-11
327-00-1CD-32	203151-0-10 203268-0-00	3,8 4,5 R	203140-0-10	1,5	203141-0-10	1,5	202609-0-10	203161-3-10	204033-0-10	202094-0-11
327-00-1CD-39	203409-4-01 203347-2-10 203349-2-10	2 1,2 R 1,4 R	203335-2-11 •	-	203338-2-11 •	-	202061-0-10	203362-3-10 203360-3-10 203361-3-10 205940-3-00	202090-0-10 R R R	202094-0-11

Indice  
Data  
Modifiche  
Vr.

Si rende noto che il contenuto della presente tavola non potrà essere utilizzato o riprodotto senza l'autorizzazione scritta della proprietaria S.p.A. di Rimoldi, la quale si riserva espressamente di tutelare i suoi diritti e norme di legge.



**Rumoldi**

● ▲ ★

Vedere note parte introduttiva  
See introductory notesVoir notes d'introduction  
Siehe Anmerkungen der EinleitungIndice  
00  
Data  
TAB  
R300  
Foglio 5  
Segue F. 6

Simbolo testa Machine symbol Symbole de la tête Symbol des Oberteile	Placca ago Needle plate Plaque à aiguille Stichplatte	Griffa principale Main feed dog Griffe principale Haupt-Transporteur	Griffa sussidiaria Auxiliary feed dog Griffe subsidiaire Hilfs-Transporteur	Griffino Chaining feed dog Griffe p. chaînette Klein-Transporteur	Piedino Presser foot Pied-presseur Drueckerfuss	Crochet superiore Upper looper Crochet supérieur Oberer Greifer	Crochet inferiore Lower looper Crochet inférieur Unterer Greifer			
327-00-2CD-17	204026-0-10	7	206298-0-00	2	203609-0-10	2	203612-0-10	204037-3-10	206209-0-00	202095-0-11
	203547-0-10	8 R	203651-0-11	1,5 R	203540-0-10	1,5 R	203611-2-11 ●	204037-3-10	206208-0-00 R	202094-0-11 R
	203578-0-10	5,5 R	203607-2-11 ●	— R	203611-2-11 ●	— R				
327-00-2CD-18	204006-0-10	5,5	206298-0-00	2	203609-0-10	2	203612-0-10	204009-3-11	204021-0-10	202095-0-11
	204007-0-10	6,5 R	203651-0-11	1,5 R	203540-0-10	1,5 R	204017-3-10 R	204017-3-10 R	204033-0-10 R	202094-0-11 R
	204012-0-10 ●	4 R	203607-2-11 ▲	— R	203611-2-11 ▲	— R				
	205650-0-00	7,5 R	203668-0-11 ●	2 R						
327-00-2CD-32	203548-0-10	7,5	203532-0-10	2	203539-0-10	2	203544-0-10	203556-3-10	204033-0-10	202094-0-11
	203549-0-10	7 R								
	203550-0-10	5,5 R								
327-00-2CD-34	203436-0-10	2,5	203419-2-11	—	203423-2-11	—	203426-0-10	203447-3-10	202092-0-10	202094-0-11
	203435-0-10	3 R	203497-0-10 ●	1 R	203498-0-10 ●	1 R				
327-00-2CD-35	203547-0-10	8	203608-0-10	2	203609-0-10	2	203612-0-10	204037-3-10	204033-0-10	202094-0-11
	203578-0-10	5,5 R	203651-0-11	1,5 R	203540-0-10	1,5 R				
	204026-0-10	7 R	203607-2-11 ●	— R	203611-2-11 ●	— R				
327-00-2CD-38	203442-0-10	3,5	203421-0-10	1,5	203425-0-10	1,5	203003-0-10	203447-3-10	204033-0-10	202094-0-11
	207050-0-00	3,3 R	207048-0-00	1 R	207049-0-00	1 R				
	205661-0-00 ●	3,5 R	203419-2-11 ●	— R	203423-2-11 ●	— R				
327-00-2CD-39	203554-0-10	6,5	203538-0-10	1,5	203543-0-10	1,5	203612-0-10	204037-3-10	206208-0-00	202094-0-11
			206290-0-00	3 R	206291-0-00	3 R				
327-00-2CD-41	203583-0-10	6	203536-0-10	1,5	203542-0-10	1,5	203544-0-10	203597-3-10	207059-0-00	202094-0-11
	203552-0-10	5 R								
	203580-0-10	5,2 R								
327-00-2CD-44	203435-0-10	3 R	203497-0-10	1 R	203498-0-10	1 R	203426-0-10	203447-3-10	202092-0-10	202094-0-11
	203436-0-10	2,5	203419-2-11	—	203423-2-11	—				
327-00-2CD-45	203551-0-10	5	203533-0-10	1,5	203540-0-10	1,5	203612-0-10	204037-3-10	206209-0-00	202095-0-11
	203695-0-00	7 R						206208-0-00 R	202094-0-11 R	

Indice  
Data  
Vr.  
Modifiche

Si rende noto che il contenuto della presente tavola non potrà essere utilizzato o riprodotto senza permesso né concesso né concesso a terzi o riprodotto senza permesso della proprietaria S.p.A. V. D. I. D. I. D. I. C. La stessa intende tutelare i suoi diritti a norma di legge.



**Rumoldi**

• ▲ ★ Vedere note parte introduttiva  
See introductory notes

Voir notes d'introduction  
Siehe Anmerkungen der Einleitung

Indice		TAB	R300
00			
Data		Foglio 7	Segue F. 8

Simbolo testa Machine symbol Symbole de la tête Symbol des Oberteileis	Placca ago Needle plate Plaque à aiguille Stichplatte	Griffa principale Main feed dog Griffe principale Haupt-Transporteur	Griffa sussidiaria Auxiliary feed dog Griffe subsidiaire Hilfs-Transporteur	Griffino Chaining feed dog Griffe p. chaînette Klein-Transporteur	Piedino Presser foot Pied-presseur Drueckerfuss	Crochet superiore Upper looper Crochet supérieur Oberer Greifer	Crochet inferiore Lower looper Crochet inférieur Unterer Greifer
327-01-1CD-06	203035-0-10 4,5	203028-0-10 1,5	203031-0-10 1,5	203004-0-10	203016-3-10	204033-0-10	202094-0-11
327-01-1MD-08	203761-0-10 6 203762-0-10 7,5 R 203785-0-10 5 R 203787-0-10 4 R 203788-0-10 7 R	203001-0-10 2 203030-2-11 ● — R 203028-0-10 1,5 R	203002-0-10 2 203033-2-11 ● — R 203031-0-10 1,5 R	203003-0-10	203766-3-10	206512-0-00	202095-0-11
327-01-1MD-09	203014-0-10 7 203035-0-10 4,5 R 203037-0-10 3,1 R	203001-0-10 2 203028-0-10 1,5 R 203030-2-11 ● — R	203002-0-10 2 203031-0-10 1,5 R 203033-2-11 ● — R	203004-0-10	205503-3-00	206512-0-00	202094-0-11
327-01-1MD-10	203014-0-10 7	203001-0-10 2	203002-0-10 2	203004-0-10	203766-3-10	206512-0-00	202094-0-11
327-01-2CD-05	204026-0-10 7 203547-0-10 8 R 203578-0-10 5,5 R	206298-0-00 2 203651-0-11 1,5 R 203607-2-11 ● — R	203609-0-10 2 203540-0-10 1,5 R 203611-2-11 ● — R	203612-0-10	204028-3-10 203618-3-10	206209-0-00 R	202095-0-11
327-01-2CD-06	204006-0-10 5,5 204007-0-10 6,5 R 204012-0-10 ● 4 R 205650-0-00 7,5 R	206298-0-00 2 203651-0-11 1,5 R 203607-2-11 ▲ — R 203668-0-11 ● 2 R	203609-0-10 2 203540-0-10 1,5 R 203611-2-11 ▲ — R	203612-0-10	204010-3-10	204021-0-10	202095-0-11
327-01-2CD-10	203551-0-10 5 203579-0-10 5,2 R	203533-0-10 1,5	203540-0-10 1,5 203609-0-10 2 R	203612-0-10	204028-3-10	206208-0-00	202094-0-11
327-01-2CD-12	203547-0-10 8 203578-0-10 5,5 R 204026-0-10 7 R	206298-0-00 2	203609-0-10 2	203612-0-10	204028-3-10	206208-0-00	202094-0-11
327-01-2CD-13	203548-0-10 7,5	203532-0-10 2	203539-0-10 2	203544-0-10	204028-3-10	204033-0-10	202094-0-11
327-01-2MD-0	204026-0-10 7 204055-0-10 7,5 R	206298-0-00 2 203651-0-11 1,5 R	203609-0-10 2 203540-0-10 1,5 R	203612-0-10	204028-3-10 204057-3-10 204038-3-00	204022-0-10 R R	202095-0-11

Indice  
Data  
Vr.  
Possibilità

Si rende noto che il contenuto delle presente tavola  
munque divulgato a terzi o riprodotto in alcun modo  
mente che parzialmente senza l'autorizzazione scritta  
stessa intende tutelare i suoi diritti di legge.

# Rumoldi

• • • Vedere note parte introduttiva  
See introductory notes

Voir notes d'introduction  
Siehe Anmerkungen der Einleitung

Indice  
00  
Date  
Foglio 8 Segue F. 9

## R300

Simbolo testa Machine symbol Symbole de la tête Symbol des Oberteile	Placca ago Needle plate Plaque à aiguille Stichplatte	Griffa principale Main feed dog Griffe principale Haupt-Transporteur	Griffa sussidiaria Auxiliary feed dog Griffe subsidiaire Hilfs-Transporteur	Griffino Chaining feed dog Griffe p. chaînette Klein-Transporteur	Piedino Presser foot Pied-presseur Drueckerfuss	Crochet superiore Upper looper Crochet supérieur Oberer Greifer	Crochet inferiore Lower looper Crochet inférieur Unterer Greifer
327-01-2MD-11	204006-0-10 5,5 204007-0-10 6,5 R 204012-0-10 4 R 205650-0-00 7,5 R	206298-0-00 2 203651-0-11 1,5 R 203607-2-11 ▲ 203668-0-11 ● 2 R	203609-0-10 2 203540-0-10 1,5 R 203611-2-11 ▲ — R	203612-0-10 — R	204010-3-10	204022-0-10	202095-0-11
327-10-1CD-02	202783-0-10 3,2 202876-0-10 3 R 202877-0-10 5 R	202780-0-10 1,5	202782-0-10 1,5	202061-0-10	202786-3-10	202092-0-10 204033-0-10 204021-0-10 R	202094-0-11 202095-0-11 R
327-10-1CD-03	202784-0-10 2,5	202781-0-10 1,5	202782-0-10 1,5	202061-0-10	202787-3-11	202092-0-10 204033-0-10 204021-0-10 R	202094-0-11 202095-0-11 R
327-10-1CD-04	202784-0-10 2,5	202781-0-10 1,5	202782-0-10 1,5	202061-0-10	202787-3-11	202092-0-10 204033-0-10 204021-0-10 R	202094-0-11 202095-0-11 R
327-10-1CD-06	202783-0-10 3,2 202876-0-10 3 R 202877-0-10 5 R	202780-0-10 1,5	202782-0-10 1,5	202061-0-10	202786-3-10	202092-0-10 204033-0-10	202094-0-11
327-11-1CD-01	202783-0-10 3,2 202876-0-10 3 R 202877-0-10 5 R	202780-0-10 1,5	202782-0-10 1,5	202061-0-10	203721-3-10	202092-0-10 204033-0-10	202094-0-11
327-11-1CD-02	202783-0-10 3,2 202876-0-10 3 R 202877-0-10 5 R	202780-0-10 1,5	202782-0-10 1,5	202061-0-10	207046-3-00	202092-0-10 204033-0-10 204021-0-10 R	202094-0-11 202095-0-11 R
327-12-1CD-01	202639-0-10 3	202606-0-10 1,5	202608-0-10 1,5	202609-0-10	202645-3-10	202092-0-10 204033-0-10	202094-0-11
327-16-1CD-01	202149-0-10 5	202054-0-10 1,5	202058-0-10 1,5	202061-0-10	202177-3-10	204021-0-10	202095-0-11
327-22-1CD-01	203786-0-10 5 203763-0-10 7 R	203746-0-10 1,5	203747-0-10 1,5	203003-0-10	203767-3-10	204033-0-10 204021-0-10 R	202094-0-11 202095-0-11 R

Si rende noto che il contenuto della presente tavola non è da considerarsi un invito a vendere, ma un semplice riferimento a terzi o a loro prodotti. La Rumoldi S.p.A. non si assume alcuna responsabilità per le azioni intraprese che parzialmente senza l'approvazione scritta della Rumoldi S.p.A. - R. 101 & C. La Rumoldi S.p.A. non si assume alcuna responsabilità per le azioni intraprese da terzi.

modifiche

Vr.

Indice

Data

Vr.

Indice

Data

Vr.

Indice

Data

Vr.

Indice

Data

Vr.

Indice

Data

Vr.

Indice

Data

Vr.

Indice

Data

Vr.



**Rumoldi**

● ▲ ★

Vedere note parte introduttiva  
See introductory notesVoir notes d'introduction  
Siehe Anmerkungen der EinleitungIndice  
00  
Data  
TAB  
R300  
Foglio 9 Segue F. 10

Simbolo testa Machine symbol Symbole de la tête Symbol des Oberteiles	Placca ago Needle plate Plaque à aiguille Stichplatte	Griffa principale Main feed dog Griffe principale Haupt-Transporteur	Griffa sussidiaria Auxiliary feed dog Griffe subsidiaire Hilfs-Transporteur	Griffino Chaining feed dog Griffe p. chaînette Klein-Transporteur	Piedino Presser foot Pied-presseur Drueckerfuss	Crochet superiore Upper looper Crochet supérieur Oberer Greifer	Crochet inferiore Lower looper Crochet inférieur Unterer Greifer				
327-22-1CD-02	203148-0-10 203149-0-10	4,5 5 R	203140-0-10	1,5	203141-0-10	1,5	202061-0-10	203157-3-10 203158-3-10	R	204033-0-10	202094-0-11
327-22-1CD-03	203150-0-10	3,5	203140-0-10	1,5	203141-0-10	1,5	202061-0-10	203159-3-10		204033-0-10	202094-0-11
327-22-1CD-04	203280-0-10	2,5	203270-0-10	1	203271-0-10	1	202061-0-10	203157-3-10 203158-3-10	R	204033-0-10	202094-0-11
327-22-1CD-05	203150-0-10	3,5	203270-0-10	1	203271-0-10	1	202061-0-10	203159-3-10		204033-0-10	202094-0-11
327-22-2CD-06	203554-0-10 203582-0-10	6,5 6 R	203538-0-10 206290-0-00	1,5 3 R	203543-0-10 206291-0-00	1,5 3 R	203612-0-10	203558-3-10		206208-0-00	202094-0-11
327-22-1MD-07	203763-0-10 203786-0-10	7 5 R	203746-0-10	1,5	203747-0-10	1,5	203003-0-10	203767-3-10		206512-0-00 202092-0-10	202095-0-11 202094-0-11 R
327-23-1CD-01	203786-0-10 203763-0-10	5 7 R	203746-0-10	1,5	203747-0-10	1,5	203003-0-10	203789-3-10 203790-3-10	R	204033-0-10 204021-0-10	202094-0-11 202095-0-11 R
327-23-1CD-02	203148-0-10 203149-0-10	4,5 5 R	203140-0-10	1,5	203141-0-10	1,5	202061-0-10	203160-3-10		204033-0-10	202094-0-11
327-23-1CD-08	203280-0-10	2,5	203270-0-10	1	203271-0-10	1	202061-0-10	203160-3-10		204033-0-10	202094-0-11
327-23-2CD-06	203554-0-10 203582-0-10	6,5 6 R	203538-0-10 206290-0-00	1,5 3 R	203543-0-10 206291-0-00	1,5 3 R	203612-0-10	203584-3-10 203585-3-10	R	206208-0-00	202094-0-11
327-23-1MD-07	203763-0-10 203786-0-10	7 5 R	203746-0-10	1,5	203747-0-10	1,5	203003-0-10	203789-3-10 203790-3-10	R	206512-0-00 202092-0-10	202095-0-11 202094-0-11 R
327-28-1CD-02	202507-0-10 202148-0-10 202504-0-10 202508-0-10 202590-0-10	5 4,6 R 4,1 R 5,6 R 6 R	202053-0-10 202757-0-00 ●	1,5 1,5 R	202057-0-10 202758-0-00 ●	1,5 1,5 R	202061-0-10	202774-3-10		202092-0-10 204021-0-10 204033-0-10	202095-0-11 202094-0-11 R

Indice  
Data  
Vr.

Si rende noto che il contenuto della presente tavola non potrà essere utilizzato o ripresentato, né copiato, senza permesso scritto dalla proprietaria S.p.A. V. L. D. I. &amp; C. La stessa intende tutelare i suoi diritti in conformità di legge.



**Rumoldi**

● ▲ ★

Vedere note parte introduttiva  
See introductory notesVoir notes d'introduction  
Siehe Anmerkungen der Einleitung

Indice

00

TAB

**R 300**

Data

Foglio 11 Segue F. 12

Simbolo testa Machine symbol Symbole de la tête Symbol des Obertheiles	Placca ago Needle plate Plaque à aiguille Stichplatte		Griffa principale Main feed dog Griffe principale Haupt-Transporteur		Griffa sussidiaria Auxiliary feed dog Griffe subsidiaire Hilfs-Transporteur		Griffino Chaining feed dog Griffe p. chaînette Klein-Transporteur	Piedino Presser foot Pied-presseur Drueckerfuss	Crochet superiore Upper looper Crochet supérieur Oberer Greifer	Crochet inferiore Lower looper Crochet inférieur Unterer Greifer
327-29-1CD-08	203072-0-10	2	203060-0-10 203095-2-00 ●	1,5 — R	203062-0-10 203094-2-00 ●	1,5 — R	202061-0-10	203800-3-10	204033-0-10	202094-0-11
327-30-1CD-07	203219-0-10	3,8	205951-0-00	1,5	205952-0-00	1,5	202609-0-10	205954-3-00	202090-0-10	202094-0-11
327-34-1CD-01	202504-0-10 202148-0-10 202507-0-10 202508-0-10 202590-0-10	4,1 4,6 5 5,6 6	202542-0-10	1,5	203265-0-10	1,5	202061-0-10	206140-3-00	204021-0-10	202095-0-11
327-34-1MD-02	204050-0-10	6,5	203001-0-10	2	203002-0-10	2	203004-0-10	204051-3-10	202092-0-10	202095-0-11
327-34-1MD-03	205597-0-00	6,5	203001-0-10	2	203002-0-10	2	203004-0-10	205595-3-10	202092-0-10	202095-0-11
327-49-1MD-01	204066-0-10	8	204061-0-10	2	204062-0-10	2	203003-0-10	205604-3-00 205607-3-00	206512-0-00 R 202092-0-10	R 202094-0-11

Indice

Data

Vr.

Si rende noto che il contenuto della presente tavola non potrà essere utilizzato o riprodotto, in tutto o in parte, senza il permesso scritto della proprietaria Rumoldi S.p.A. La stessa intende tutelare i suoi diritti a norma di legge.



**Rumoldi**

• • • Vedere note parte introduttiva  
See introductory notes

Voir notes d'introduction  
Siehe Anmerkungen der Einleitung

Indice  
00  
Data  
Foglio 13 Segue F. 14

**R300**

Simbolo testa Machine symbol Symbole de la tête Symbol des Obertheile	Placca ago Needle plate Plaque à aiguille Stichplatte	Griffa principale Main feed dog Griffe principale Haupt-Transporteur	Griffa sussidiaria Auxiliary feed dog Griffe subsidiaire Hilfs-Transporteur	Griffino Chaining feed dog Griffe p. chaînette Klein-Transporteur	Piedino Presser foot Pied-presseur Drueckerfuss	Crochet superiore Upper looper Crochet supérieur Oberer Greifer	Crochet inferiore Lower looper Crochet inférieur Unterer Greifer		
028-00-09	203437-0-10 203435-0-10 203436-0-10	3,2 3 R 2,5 R	203419-2-11 —	—	204395-2-11 —	—	203426-0-10 203447-0-10	202092-0-10	202413-0-11
028-00-10	203478-0-10 203439-0-10 203475-0-10	3 4,5 R 3,5 R	203421-0-10 207048-0-00	1,5 1 R	204396-0-10 207049-0-00	1,5 1 R	203003-0-10 203447-3-10	202092-0-10	202413-0-11
028-00-11	203547-0-10 203578-0-10 204026-0-10	8 5,5 R 7 R	206298-0-00	2	203609-0-10	2	203612-0-10 204037-3-10	204033-0-10 204021-0-10	202094-0-11 202095-0-11 R
028-00-12	203551-0-10 203579-0-10 203695-0-00	5 5,2 R 7 R	203533-0-10	1,5	204409-0-10	1,5	203612-0-10 204037-3-10	204033-0-10 204021-0-10	202094-0-11 204676-0-10 R
028-00-13	203552-0-10 203580-0-10 203583-0-10	5 5,2 R 6 R	203536-0-10	1,5	204410-0-10	1,5	203544-0-10 203597-3-10	204033-0-10	202094-0-11
028-00-14	204026-0-10 203547-0-10 203578-0-10	7 8 R 5,5 R	206298-0-00 203651-0-11 203607-2-11 ●	2 1,5 R — R	203609-0-10 204409-0-10 203611-2-11 ●	2 1,5 R — R	203612-0-10 204037-3-10	204021-0-10 204033-0-10	202095-0-11 202094-0-11 R
028-00-15	204006-0-10 204007-0-10 205650-0-00	5,5 6,5 R 7,5 R	206298-0-00 203651-0-11 203607-2-11 ●	2 1,5 R — R	203609-0-10 203611-2-11 ● 204409-0-10	2 — R 1,5 R	203612-0-10 204009-3-11 204017-3-10	204021-0-10 R 204033-0-10	202095-0-11 R 202094-0-11
028-00-16	204006-0-10 204007-0-10 205650-0-00	5,5 5,5 R 7,5 R	206298-0-00 203651-0-11 203607-2-11 ●	2 1,5 R — R	203609-0-10 203611-2-11 ● 204409-0-10	2 — R 1,5 R	203612-0-10 204009-3-11 204017-3-10	R 204021-0-10	202095-0-11
028-00-17	204026-0-10	7	206298-0-00 203651-0-11	2 1,5 R	203609-0-10 204409-0-10	2 1,5 R	203612-0-10 204037-3-10	204022-0-10 204034-0-10 203490-0-00	202095-0-11 202094-0-11 R

Si rende noto che il contenuto della presente tavola  
nonché divulgato a terzi o riprodotto o sia integral-  
mente che parzialmente senza l'autorizzazione scritta  
della Rumoldi S.p.A. stessa intende tutelare i suoi diritti e norme di legge.

Indice  
Data  
Vr.  
Modifiche



**Rimoldi**

• ▲ \*

Vedere note parte introduttiva  
See introductory notesVoir notes d'introduction  
Siehe Anmerkungen der Einleitung

Indice

**R300**

00

Foglio 15 Segue F.16

Simbolo testa Machine symbol Symbole de la tête Symbol des Obertheile	Placca ago Needle plate Plaque à aiguille Stichplatte	Griffa principale Main feed dog Griffe principale Haupt-Transporteur	Griffa sussidiaria Auxiliary feed dog Griffe subsidaire Hilfs-Transporteur	Griffino Chaining feed dog Griffe p. chaînette Klein-Transporteur	Piedino Presser foot Pied-presseur Drueckerfuss	Crochet superiore Upper looper Crochet supérieur Oberer Greifer	Crochet inferiore Lower looper Crochet inférieur Unterer Greifer
028-01-02	202504-0-10 202148-0-10 202507-0-10 202508-0-10 202590-0-10	4,1 4,6 R 5 R 5,6 R 6 R	202053-0-10 1,5	204169-0-10 1,5	202061-0-10	202178-3-10	204021-0-10 202095-0-11
028-01-03	203785-0-10 203761-0-10 203787-0-10 203788-0-10 203762-0-10	5 6 R 4 R 7 R 7,5 R	203028-0-10 1,5 203001-0-10 2 R	204355-0-10 1,5 203002-0-10 2 R	203003-0-10	203016-3-10 203042-3-10 R	204033-0-10 202094-0-11
028-01-04	203214-0-10 203217-0-10 203218-0-10 203220-0-10	3,3 3,8 R 5 R 2,8 R	203199-0-10 1,5	204169-0-10 1,5	202061-0-10	202178-3-10	204033-0-10 202094-0-11
028-01-05	204026-0-10 203547-0-10 203578-0-10	7 8 R 5,5 R	206298-0-00 2 203651-0-11 1,5 R 203607-2-11 ● — R	203609-0-10 2 203611-2-11 ● — R 204409-0-10 1,5 R	203612-0-10	204028-3-10 203618-3-10 R	204021-0-10 204033-0-10 R 202095-0-11 202094-0-11 R
028-01-06	204006-0-10 204007-0-10 205650-0-00	5,5 6,5 R 7,5 R	206298-0-00 2 203651-0-11 1,5 R 203607-2-11 ● — R	203609-0-10 2 203611-2-11 ● — R 204409-0-10 1,5 R	208612-0-10	204010-3-10	204021-0-10 202095-0-11
028-01-07	204026-0-10 204055-0-10	7 7,5 R	206298-0-00 2 203651-0-11 1,5 R	203609-0-10 2 204409-0-10 1,5 R	203612-0-10	204028-3-10 204038-3-00 R 204057-3-10 R	204022-0-10 202095-0-11 204034-0-10
028-01-08	203761-0-10 203762-0-10 203785-0-10 203787-0-10 203788-0-10	6 7,5 R 5 R 4 R 7 R	203001-0-10 2	204334-0-10 2	203003-0-10	203766-3-10	203755-0-10 202095-0-11
028-10-01	202751-0-10	2,5	202750-0-10 1	204290-0-10 1	202061-0-10	202752-3-10	202092-0-10 204033-0-10 R 202094-0-11

Indice  
Data  
Vr.  
Indice

Si rende noto che il contenuto della presente tavola non potrà essere utilizzato o riprodotto senza permesso scritto dalla Rimoldi S.p.A. che potrà essere richiesto presso la Direzione Generale della Rimoldi S.p.A. in viale dell'Industria, 10 - 20139 Milano - Italia. La stessa intende tutelare i suoi diritti a norma di legge.

**Rumoldi**

• • • Vedere note parte introduttiva  
See introductory notes

Voir notes d'introduction  
Siehe Anmerkungen der Einleitung

Indice  
00  
Data  
Foglio 16 Segue F.17

**R300**

Simbolo testa Machine symbol Symbole de la tête Symbol des Oberteiles	Placca ago Needle plate Plaque à aiguille Stichplatte	Griffa principale Main feed dog Griffe principale Haupt-Transporteur	Griffa sussidiaria Auxiliary feed dog Griffe subsidiaire Hilfs-Transporteur	Griffino Chaining feed dog Griffe p. chaînette Klein-Transporteur	Piedino Presser foot Pied-presseur Drueckerfuss	Crochet superiore Upper looper Crochet supérieur Oberer Greifer	Crochet inferiore Lower looper Crochet inférieur Unterer Greifer			
028-10-02	202783-0-10 202876-0-10 202877-0-10	3,2 3 5	202780-0-10	1,5	204300-0-10 204304-0-10	1,5 1,5	202061-0-10	202786-3-10	202092-0-10 204033-0-10 204021-0-10	202094-0-11 202095-0-11
028-10-03	202783-0-10 202876-0-10 202877-0-10	3,2 3 5	202780-0-10	1,5	204300-0-10 204304-0-10	1,5 1,5	202061-0-10	202786-3-10	202092-0-10 204033-0-10 204021-0-10	202094-0-11 202095-0-11
028-10-04	202783-0-10 202876-0-10 202877-0-10	3,2 3 5	202780-0-10	1,5	204300-0-10 204304-0-10	1,5 1,5	202061-0-10	202786-3-10	202092-0-10 204033-0-10 204021-0-10	202094-0-11 202095-0-11
028-10-05	202783-0-10 202876-0-10 202877-0-10	3,2 3 5	202780-0-10	1,5	204300-0-10 204304-0-10	1,5 1,5	202061-0-10	202786-3-10	202092-0-10 204033-0-10 204021-0-10	202094-0-11 202095-0-11
028-11-01	202783-0-10 202876-0-10 202877-0-10	3,2 3 5	202780-0-10	1,5	204300-0-10 204304-0-10	1,5 1,5	202061-0-10	203721-3-10	202092-0-10 204033-0-10	202094-0-11
028-16-01	202149-0-10	5	202054-0-10	1,5	202058-0-10	1,5	202061-0-10	202177-3-10	204021-0-10	202095-0-11
028-28-01	202507-0-10 202148-0-10 202504-0-10 202508-0-10 202590-0-10	5 4,6 4,1 5,6 6	202053-0-10	1,5	204169-0-10	1,5	202061-0-10	202774-3-10	202092-0-10	202095-0-11 202094-0-11
028-28-02	202507-0-10 202148-0-10 202504-0-10 202508-0-10 202590-0-10	5 4,6 4,1 5,6 6	202053-0-10	1,5	204169-0-10	1,5	202061-0-10	202774-3-10	202092-0-10 204021-0-10 204033-0-10	202095-0-11 202094-0-11
028-28-03	202764-0-10 202936-0-10 202763-0-10	4 6,5 3,5	202761-0-10	1,5			202938-3-11	202092-0-10		202094-0-11
028-28-04	202763-0-10 202764-0-10 202936-0-10	3,5 4 6,5	202761-0-10	1,5			202774-3-10	202092-0-10 204033-0-10		202094-0-11

Si fonda noto che il contenuto della presente tavola  
non può essere riprodotto o copiato integralmente  
senza permesso scritto dalla proprietaria S.p.A. V. RINALDI & C. La  
responsabilità di questa tavola è a norma di legge.

modifiche

Data

Vr.



**Rumoldi**

• ▲ ★ Vedere note parte introduttiva  
See introductory notes

Voir notes d'introduction  
Siehe Anmerkungen der Einleitung

Indice  
00 01 02 03 04 05 06 07 08 09 10 11 12 13 14 15 16 17 18 19 20  
Date Foglio 17 Segue F.18

**R300**

Simbolo testa Machine symbol Symbole de la tête Symbol des Oberteiles	Placca ago Needle plate Plaque à aiguille Stichplatte	Griffa principale Main feed dog Griffe principale Haupt-Transporteur	Griffa sussidiaria Auxiliary feed dog Griffe subsidiaire Hilfs-Transporteur	Griffino Chaining feed dog Griffe p. chaînette Klein-Transporteur	Piedino Presser foot Pied-presseur Drueckerfuss	Crochet superiore Upper looper Crochet supérieur Oberer Greifer	Crochet inferiore Lower looper Crochet inférieur Unterer Greifer
028-28-05	202935-0-10 202936-0-10	5,5 6,5 R	204322-0-10	2		202938-3-11	202092-0-10 202094-0-11
028-28-06	202935-0-10 202936-0-10	5,5 6,5 R	204322-0-10	2		202938-3-11	202092-0-10 204033-0-10 202094-0-11
028-28-07	203354-2-10	1,3	203335-2-11	—	204378-2-11	—	202609-0-10 203361-3-10 202090-0-10 202413-0-11
028-28-09	204523-0-10	10	204520-0-11 204541-0-11	1,5 2 R		204525-3-11	203756-0-10 202095-0-11
028-28-10	204566-4-10	7	204545-0-11	2		204547-0-11	204571-3-11 204592-3-11 R 203755-0-10 202092-0-10 R 202095-0-11
028-28-11	204566-4-10	7	204545-0-11	2		204547-0-11	204571-3-11 204592-3-11 R 203755-0-10 202092-0-10 R 202095-0-11
028-29-01	202504-0-10 202148-0-10 202507-0-10 202508-0-10 202590-0-10	4,1 4,6 R 5 R 5,6 R 6 R	202053-0-10	1,5	204169-0-10 204250-0-10	1,5 1,5 R	202061-0-10 202175-3-10 204021-0-10 202095-0-11
028-29-02	202504-0-10 202148-0-10 202507-0-10 202508-0-10 202590-0-10	4,1 4,6 R 5 R 5,6 R 6 R	202053-0-10	1,5	204169-0-10 204250-0-10	1,5 1,5 R	202061-0-10 202176-3-10 204021-0-10 202095-0-11
028-29-03	202150-0-10	3,5	202053-0-10	1,5	204169-0-10	1,5	202061-0-10 202182-3-10 204021-0-10 202095-0-11
028-29-04	203147-2-10	3,2	203199-0-10	1,5	204169-0-10	1,5	202061-0-10 203154-3-10 204033-0-10 202094-0-11
028-29-05	203214-0-10 203217-0-10 203218-0-10 203220-0-10	3,3 3,8 R 5 R 2,8 R	203199-0-10	1,5	204169-0-10	1,5	202061-0-10 202175-3-10 204033-0-10 202094-0-11

Indice  
Data  
Vr.  
Modifiche

Si rende noto che il contenuto della presente tavola non potrà essere utilizzato o riprodotto senza permesso scritto dalla Rumoldi S.p.A. e che il presente documento è riservato ai soli diritti di norma di legge.

Si rende noto che il contenuto della presente tavola non potrà essere utilizzato o riprodotto integralmente o parzialmente senza l'autorizzazione scritta della proprietaria S.p.A. V. RIMOLDI & C. La stessa azienda detiene i soli diritti a norma di legge.

modifiche

Vr.	Data	Indice

Simbolo testa Machine symbol Symbole de la tête Symbol des Oberteiles	Placca ago Needle plate Plaque à aiguille Stichplatte		Griffa principale Main feed dog Griffe principale Haupt-Transporteur		Griffa sussidiaria Auxiliary feed dog Griffe subsidiaire Hilfs-Transporteur		Griffino Chaining feed dog Griffe p. chaînette Klein-Transporteur	Piedino Presser foot Pied-presseur Drueckerfuss	Crochet superiore Upper looper Crochet supérieur Oberer Greifer	Crochet inferiore Lower looper Crochet inférieur Unterer Greifer
028-29-06	203214-0-10 203217-0-10 203218-0-10 203220-0-10	3,3 3,8 R 5 R 2,8 R	203199-0-10	1,5	204169-0-10	1,5	202061-0-10	202176-3-10	204033-0-10	202094-0-11
028-29-07	203072-0-10	2	203060-0-10	1,5	204337-0-10	1,5	202061-0-10	203800-3-10	204033-0-10	202094-0-11
028-29-08	204523-0-10	10	204520-0-11 204541-0-11	1,5 2 R				204526-3-11	203756-0-10	202095-0-11
028-30-01	202707-0-10 202634-0-10 202635-0-10 202636-0-10 202716-0-10 202709-0-10	2 2,5 R 3,5 R 1,2 R 3 R 1,5 R	202605-0-10 202698-2-11 ● 202695-0-10	1,5 — R 1 R	204278-0-10 204286-2-11 ● 204284-0-10	1,5 — R 1 R	202609-0-10	202710-3-10	202090-0-10	202413-0-11
028-30-02	202707-0-10 202634-0-10 202635-0-10 202636-0-10 202716-0-10 202709-0-10	2 2,5 R 3,5 R 1,2 R 3 R 1,5 R	202605-0-10 202698-2-11 ● 202695-0-10	1,5 — R 1 R	204278-0-10 204286-2-11 ● 204284-0-10	1,5 — R 1 R	202609-0-10	203400-3-10	203429-0-10	202413-0-11
028-30-03	203047-0-20 203048-0-20	3 3,5 R	203060-0-10	1,5	204337-0-10	1,5	202609-0-10	203050-3-10	204033-0-10	202094-0-11
028-30-04	203047-0-20 203048-0-20	3 3,5 R	203060-0-10	1,5	204337-0-10	1,5	202609-0-10	203053-3-10	204033-0-10	202094-0-11
028-30-05	203072-0-10	2	203060-0-10	1,5	204337-0-10	1,5	202061-0-10	203077-3-10	204033-0-10	202094-0-11
028-30-06	203072-0-10	2	203805-0-10	1	204290-0-10	1	202061-0-10	203077-3-10	204033-0-10	202094-0-11
028-34-01	204050-0-10	6,5	203001-0-10	2	204334-0-10	2	203004-0-10	204051-3-10	202092-0-10	202095-0-11

Vr.	Data	Indice

Vr.	Data	Indice

Vr.	Data	Indice

Vr.	Data	Indice

**Rumoldi**

• • •

Vedere note parte introduttiva  
See introductory notes

Voir notes d'introduction  
Siehe Anmerkungen der Einleitung

Indice **R300**  
Data Foglio 19 Segue F. 20

Simbolo testa Machine symbol Symbole de la tête Symbol des Oberteiles	Placca ago Needle plate Plaque à aiguille Stichplatte	Griffa principale Main feed dog Griffe principale Haupt-Transporteur	Griffa sussidiaria Auxiliary feed dog Griffe subsidiaire Hilfs-Transporteur	Griffino Chaining feed dog Griffe p. chaînette Klein-Transporteur	Piedino Presser foot Pied-presseur Drueckerfuss	Crochet superiore Upper looper Crochet supérieur Oberer Greifer	Crochet inferiore Lower looper Crochet inférieur Unterer Greifer	
228-00-01	202504-0-10 202148-0-10 202507-0-10 202508-0-10 202590-0-10	4,1 4,6 R 5 R 5,6 R 6 R	202053-0-10 1,5	204169-0-10 204250-0-10 1,5 R	202061-0-10	202171-3-10 202509-3-10 R	204021-0-10 202092-0-10 R 204033-0-10 R	202095-0-11 202094-0-11 R
228-00-02	202707-0-10 202634-0-10 202635-0-10 202636-0-10 202716-0-10 202709-0-10	2 2,5 R 3,5 R 1,2 R 3 R 1,5 R	202605-0-10 202695-0-10 202698-2-11 ● — R	1,5 1 R — R	204278-0-10 204284-0-10 204286-2-11 ● — R	202609-0-10 202644-3-10 202717-3-10 R	202090-0-10	202413-0-11
228-00-03	202637-0-10 202638-0-10 202708-0-10	3,5 4 R 3 R	202605-0-10 202698-2-11 ● 202695-0-10	1,5 — R 1 R	204278-0-10 204286-2-11 ● 204284-0-10	202609-0-10 202646-3-10	202090-0-10	202413-0-11
228-00-04	203785-0-10 203761-0-10 203787-0-10 203788-0-10 203762-0-10	5 6 R 4 R 7 R 7,5 R	203028-0-10 1,5	204355-0-10 204358-0-10 1,5 R	203003-0-10	203015-3-10	204033-0-10 204021-0-10 R	202094-0-11 202095-0-11 R
228-00-05	203214-0-10 203217-0-10 203218-0-10 203220-0-10	3,3 4 R 5 R 2,8 R	203199-0-10 1,5	204169-0-10 1,5	202061-0-10	202171-3-10 202509-3-10 R	204033-0-10 202092-0-10 R 204021-0-10 R	202094-0-11 202095-0-11 R
228-00-06	203409-4-01 203347-2-10 203349-2-10	2 1,2 R 1,4 R	203335-2-11 —	204378-2-11 —	202061-0-10	203362-3-10 203361-3-10 203360-3-10 205940-3-00	202090-0-10	202094-0-11
228-00-07	203399-0-10 203398-0-10	1 1,5 R	203332-0-10 1,5	204337-0-10 1,5	202061-0-10	203366-3-10	203429-0-10 202092-0-10 R	202094-0-11
228-00-08	203398-0-10 203399-0-10	1,5 1 R	203332-0-10 1,5	204337-0-10 1,5	202061-0-10	203366-3-10 202641-3-10 R	202090-0-10	202413-0-11

Indice  
Data  
Vr.

Si vende noto che il contenuto della presente tavola non potrà essere utilizzato o riprodotto in alcun modo senza permesso scritto dalla proprietaria S.p.A. V. Rini, D.I. & C. La stessa intende tutelare i suoi diritti a norma di legge.



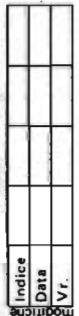

Si rende noto che il contenuto della presente tavola non potrà essere utilizzato o rappresentato in alcun modo senza il permesso scritto della proprietaria S.p.A. V. R. I. S. DI & C. La stessa intende tutelare i suoi diritti a norma di legge.

Simbolo testa Machine symbol Symbole de la tête Symbol des Oberteilets		Placca ago Needle plate Plaque à aiguille Stichplatte		Griffa principale Main feed dog Griffe principale Haupt-Transporteur		Griffa sussidiaria Auxiliary feed dog Griffe subsidiaire Hilfs-Transporteur		Griffino Chaining feed dog Griffe p. chaînette Klein-Transporteur		Piedino Presser foot Pied-presseur Drueckerfuss		Crochet superiore Upper looper Crochet supérieur Oberer Greifer		Crochet inferiore Lower looper Crochet inférieur Unterer Greifer	
												Indice		Foglio 21	
										00		R300			
										Data					
228-01-01	202504-0-10 202148-0-10 202507-0-10 202508-0-10 202590-0-10	4,1 4,6 5 5,6 6	R R R R	202053-0-10	1,5	204169-0-10	1,5	202061-0-10		202178-3-10		204021-0-10		202095-0-11	
228-01-02	203785-0-10 203761-0-10 203787-0-10 203788-0-10 203762-0-10	5 6 4 7 7,5	R R R R	203028-0-10 203001-0-10	1,5 2	204355-0-10 203002-0-10	1,5 2	203003-0-10	R	203016-3-10 203042-3-10	R	204033-0-10		202094-0-11	
228-01-03	203214-0-10 203217-0-10 203218-0-10 203220-0-10	3,3 3,9 5 2,8	R R R	203199-0-10	1,5	204169-0-10	1,5	202061-0-10		202178-3-10		204033-0-10		202094-0-11	
228-01-04	203219-0-10	3,8		203199-0-10	1,5	204169-0-10	1,5	202609-0-10		202178-3-10		204033-0-10		202094-0-11	
228-10-01	202783-0-10 202876-0-10 202877-0-10	3,2 3 5	R R	202780-0-10	1,5	204300-0-10 204304-0-10	1,5 1,5	202061-0-10	R	202786-3-10		202092-0-10 204033-0-10 204021-0-10	R	202094-0-11 202095-0-11	R
228-10-02	202784-0-10	2,5		202781-0-10	1,5	204300-0-10	1,5	202061-0-10		202787-3-11		202092-0-10 204033-0-10 204021-0-10	R	202094-0-11 202095-0-11	R
228-10-03	202784-0-10	2,5		202781-0-10	1,5	204300-0-10	1,5	202061-0-10		202787-3-11		202092-0-10 204033-0-10 204021-0-10	R	202094-0-11 202095-0-11	R
228-10-04	204437-0-10 204965-0-00	2,5 1,5	R	204425-0-10	1,5	204426-0-10	1,5	204427-0-10		204439-3-12		202092-0-10 204033-0-10		202094-0-11	
228-10-05	202783-0-10 202876-0-10 202877-0-10	3,2 3 5	R R	202780-0-10	1,5	204300-0-10 204304-0-10	1,5 1,5	202061-0-10		202786-3-10		202092-0-10 204033-0-10		202094-0-11	

# Rumoldi

• • •

Vedere note parte introduttiva  
See introductory notes

Voir notes d'introduction  
Siehe Anmerkungen der Einleitung

Indice  
00  
Data  
Foglio 22 Segue F. 23

## R300

Simbolo testa Machine symbol Symbole de la tête Symbol des Oberteileis	Placca ago Needle plate Plaque à aiguille Stichplatte	Griffa principale Main feed dog Griffe principale Haupt-Transporteur	Griffa sussidiaria Auxiliary feed dog Griffe subsidiaire Hilfs-Transporteur	Griffino Chaining feed dog Griffe p. chaînette Klein-Transporteur	Piedino Presser foot Pied-presseur Drueckerfuss	Crochet superiore Upper looper Crochet supérieur Oberer Greifer	Crochet inferiore Lower looper Crochet inférieur Unterer Greifer			
228-10-06	202783-0-10 202876-0-10 202877-0-10	3,2 3 R 5 R	202780-0-10	1,5	204300-0-10 204304-0-10	1,5 R	202061-0-10	202786-3-10	202092-0-10 204033-0-10	202094-0-11
228-10-07	202783-0-10 202876-0-10 202877-0-10	3,2 3 R 5 R	202780-0-10	1,5	204300-0-10 204304-0-10	1,5 R	202061-0-10	202786-3-10	202092-0-10 204033-0-10	202094-0-11
228-10-08	205725-0-00	2,5	204425-0-10	1,5	204426-0-10	1,5	204427-0-10	205723-3-00	202092-0-10 204033-0-10	202094-0-11
228-28-01	202507-0-10 202148-0-10 202504-0-10 202508-0-10 202590-0-10	5 4,6 R 4,1 R 5,6 R 6 R	202053-0-10	1,5	204169-0-10	1,5	202061-0-10	202774-3-10	202092-0-10	202095-0-11 202094-0-11 R
228-28-02	202507-0-10 202148-0-10 202504-0-10 202508-0-10 202590-0-10	5 4,6 R 4,1 R 5,6 R 6 R	202053-0-10	1,5	204169-0-10	1,5	202061-0-10	202774-3-10	202092-0-10 204021-0-10 204033-0-10 R	202095-0-11 202094-0-11 R
228-28-03	202764-0-10 202936-0-10 202763-0-10	4 6,5 R 3,5 R	202761-0-10	1,5				202938-3-11	202092-0-10	202094-0-11
228-28-04	202763-0-10 202764-0-10 202936-0-10	3,5 4 R 6,5 R	202761-0-10	1,5				202774-3-10	202092-0-10	202094-0-11
228-28-05	202935-0-10 202936-0-10	5,5 6,5 R	204322-0-10	2				202938-3-11	202092-0-10	202094-0-11
228-28-06	202935-0-10 202936-0-10	5,5 6,5 R	204322-0-10	2				202938-3-11	202092-0-10	204094-0-11
228-28-07	203354-2-10	1,3	203335-2-11	-	204378-2-11	-	202609-0-10	203361-3-10	202090-0-10	202413-0-11

Si rende noto che il contenuto della presente tavola non potrà essere utilizzato o riprodotto senza permesso scritto dalla Rumoldi S.p.A. V. R. 101 & C. La stessa intende tutelare i suoi diritti in forma di legge.

modifiche

V.

Indice  
Data

V.

Indice  
Data

V.

Indice  
Data

V.

Indice  
Data

V.

Indice  
Data

V.

Indice  
Data

V.

Indice  
Data

V.

Indice  
Data

V.

**Rimoldi**

• ▲ \*

Vedere note parte introduttiva  
See introductory notesVoir notes d'introduction  
Siehe Anmerkungen der Einleitung

Indice				F.A.S.	<b>R300</b>
00					
Data				Foglio 23	Segue F. 24

Simbolo testa Machine symbol Symbole de la tête Symbol des Oberteiles	Placca ago Needle plate Plaque à aiguille Stichplatte		Griffa principale Main feed dog Griffe principale Haupt-Transporteur			Griffa sussidiaria Auxiliary feed dog Griffe subsidiaire Hilfs-Transporteur			Griffino Chaining feed dog Griffe p. chaînette Klein-Transporteur	Piedino Presser foot Pied-presseur Druckerfuss	Crochet superiore Upper looper Crochet supérieur Oberer Greifer	Crochet inferiore Lower looper Crochet inférieur Unterer Greifer
228-28-08	204566-4-10	7	204545-0-11	2					204547-0-11	204571-3-11 204592-3-11	R 203755-0-10 202092-0-10	202095-0-11
228-28-09	204523-0-10	10	204520-0-11 204541-0-11	1,5 2	R					204525-3-11	203756-0-10	202095-0-11
228-28-10	202636-0-10	1,2	202605-0-10 202695-0-10 202698-2-11 ●	1,5 1 -	R	204278-0-10 204284-0-10 204286-2-11 ●	1,5 1 -	R R	202609-0-10	202643-3-10	204033-0-10	202094-0-11
228-28-11	204566-4-10	7	204545-0-10	2					204547-0-11	204571-3-11 204592-3-11	203755-0-10 202092-0-10	R 202095-0-11
228-28-12	941045-2-00 941311-2-00	R	202053-0-10	1,5		204169-0-10 204250-0-10	1,5 1,5	R	921350-0-11	941090-3-00 941310-3-00	R 202092-0-10 204021-0-10 204033-0-10	202095-0-11 202094-0-11
228-34-01	204050-0-10	6,5	203001-0-10	2		204334-0-10	2		203004-0-10	204051-3-10	202092-0-10 204033-0-10	R 202095-0-11

Indice
Data
Vr.

Si rende noto che il contenuto della presente tavola  
non può essere riprodotto o ristampato integral-  
mente che parzialmente senza l'autorizzazione scrit-  
ta della proprietà. Si prega di notare che la  
stessa intende tutelare i suoi diritti. Firma di legge.

**Rimoldi**

• ▲ ★ Vedere note parte introduttiva  
See introductory notes

Voir notes d'introduction  
Siehe Anmerkungen der Einleitung

Indice  
00  
Date  
Foglio 24 Segue F. 25

**R 300**

Simbolo testa Machine symbol Symbole de la tête Symbol des Oberteiles	Placca ago Needle plate Plaque à aiguille Stichplatte	Griffa principale Main feed dog Griffe principale Haupt-Transporteur	Griffa sussidiaria Auxiliary feed dog Griffe subsidiaire Hilfs-Transporteur	Griffino Chaining feed dog Griffe p. chaînette Klein-Transporteur	Piedino Presser foot Pied-presseur Drueckerfuss	Crochet superiore Upper looper Crochet supérieur Oberer Greifer	Crochet inferiore Lower looper Crochet inférieur Unterer Greifer		
329-00-2CD-01	204695-0-11 204809-0-00 204696-0-10	3,5 5,5 R 4,2 R	204668-0-10 204998-0-00 ● 205537-0-00 ▲ 204806-2-11 ★	1,5 1,5 R 1,5 R — R	204668-0-10 204999-0-00 ● 204808-2-11 ★ 205536-0-00 ▲	1,5 1,5 R — R 1,5 R	202609-0-10 204950-3-11	202092-0-10 204033-0-10 R	202413-0-11 204675-0-10 R
329-00-2CD-02	204698-0-11 204692-0-00 206866-0-00	3,7 4 R 5 R	204667-0-10	1,5	204669-0-10	1,5	204819-0-10 204706-3-11	202092-0-10 204033-0-10 R	202413-0-11 204675-0-10 R
329-00-2CD-03	204821-0-10 204838-0-00 204837-0-00	3 5 R 3,2 R	204813-0-10 205539-0-00 ●	1,5 1,5 R	204816-0-10 205538-0-00 ●	1,5 1,5 R	204819-0-10 204826-3-10	202092-0-10 204033-0-10 R	202413-0-11 204675-0-10 R
329-00-2CD-04	204822-0-10 204823-0-10	3 3,6 R	204814-0-10	1,5	204817-0-10	1,5	204819-0-10 204827-3-10	202092-0-10 204033-0-10 R	202413-0-11 204675-0-10 R
329-00-2CD-05	204864-0-10 204948-0-10	5 4 R	204846-0-10 204940-0-10 ● 204941-0-10 ▲ 204997-0-00 ★	1,5 2 R 2 R 1,5 R	204850-0-10 204942-0-10 ● 204851-0-11 ★ 204943-0-11 ▲	1,5 2 R 1,5 R 2 R	202609-0-10 204950-3-11	202092-0-10 204033-0-10 R	202413-0-11 204675-0-10 R 204676-0-10 R
329-00-2CD-06	205025-0-10 207051-0-00 ●	5,5 2 R	205007-0-10 205059-0-10 205009-2-11 ▲ 205060-0-10 ★ 207052-0-00 ●	1,5 2 R — R 2 R 1,5 R	205011-0-10 205064-0-10 205013-2-11 ▲ 205065-0-10 ★	1,5 2 R — R 2 R	202609-0-10 205074-3-11 207155-3-00 ●	202092-0-10 204033-0-10 R	202413-0-11 204676-0-10 R 204675-0-10 R
329-00-2CD-07	205026-0-10	5	205061-0-10 205062-0-10 ● 205010-0-10	2 2 R 1,5 R	205066-0-10 205067-0-10 ● 205014-0-10	2 2 R 1,5 R	202609-0-10 205110-3-11	202092-0-10 204033-0-10 R	202413-0-11 204676-0-10 R
329-00-2CD-08	205102-0-10	3,5	204846-0-10 204940-0-10 204997-0-00 ● 204941-0-10 ▲	1,5 2 R 1,5 R 2 R	204850-0-10 204942-0-10 204851-0-11 ● 204943-0-11 ▲	1,5 2 R 1,5 R 2 R	202609-0-10 205103-3-10	202092-0-10 204033-0-10 R	202413-0-11 204675-0-10 R
329-00-2CD-09	205082-0-10	2,5	204813-0-10 205539-0-00 ●	1,5 1,5 R	204816-0-10 205538-0-00 ●	1,5 1,5 R	204819-0-10 205084-3-10	202092-0-10 204033-0-10 R	202413-0-11 204675-0-10 R

Si rende noto che il contenuto della presente tavola non può essere diviso o ristampato senza permesso scritto dalla Rimoldi S.p.A. Si sono riservati i diritti di ristampa e di riproduzione.

modifiche  
Vr.

Indice	Date





# Rumoldi

• • • Vedere note parte introduttiva  
See introductory notes

Voir notes d'introduction  
Siehe Anmerkungen der Einleitung

Indice		R3
00		
Data		Foglio 25 Segue

Simbolo testa Machine symbol Symbole de la tête Symbol des Oberteiles	Placca ago Needle plate Plaque à aiguille Stichplatte	Griffa principale Main feed dog Griffe principale Haupt-Transporteur	Griffa sussidiaria Auxiliary feed dog Griffe subsidiaire Hilfs-Transporteur	Griffino Chaining feed dog Griffe p. chaînette Klein-Transporteur	Piedino Presser foot Pied-presseur Drueckerfuss	Crochet superiore Upper looper Crochet supérieur Oberer Greifer	Crochet inferiore Lower looper Crochet inférieur Unterer Greifer				
329-00-2CD-10	205025-0-10	5,5	205060-0-10	2	205065-0-10	2	202609-0-10	205118-3-10	202092-0-10	202413-0-11	
			205007-0-10	1,5 R	205011-0-10	1,5 R			204033-0-10	R 204676-0-10	
			205009-2-11 •	— R	205013-2-11 •	— R					
			205059-0-10 ▲	2 R	205064-0-10 ▲	2 R					
329-00-2CD-11	205083-0-10	3	204814-0-10	1,5	204817-0-10	1,5	204819-0-10	205085-3-10	202092-0-10	202413-0-11	
									204033-0-10	R 204675-0-10	
329-00-2CD-12	204864-0-10 204948-0-10	5	204941-0-10	2	204943-0-11	2	202609-0-10	206002-3-01	202092-0-10	202413-0-11	
		4 R	204846-0-10	1,5 R	204850-0-10	1,5 R			204033-0-10	R 204675-0-10	
			204940-0-10 •	2 R	204851-0-10 ▲	1,5 R					
			204997-0-00 ▲	1,5 R	204942-0-10 •	2 R					
329-00-2CD-13	205026-0-10	5	205061-0-10	2	205066-0-10	2	202609-0-10	205070-3-10	202092-0-10	202413-0-11	
				205062-0-10 •	2 R	205067-0-10 •	2 R			204033-0-10	R 204676-0-10
				205010-0-10	1,5 R	205014-0-10	1,5 R				
329-00-2CD-15	204867-0-10 204949-0-10	6	204848-0-10	1,5	204852-0-10	1,5	202609-0-10	204950-3-11	202092-0-10	202413-0-11	
		4,5 R	204849-0-10 •	1,5 R	204853-0-10 •	1,5 R			204033-0-10	R 204675-0-10	
329-00-3MU-01	206042-0-10	5	206044-0-10	2,5				206046-3-01	202092-0-10	202413-0-11	
								204033-0-10	R 206048-0-10		
329-01-2CD-01	204948-0-10 204864-0-10	4	204846-0-10	1,5	204850-0-10	1,5	202609-0-10	204951-3-11	202092-0-10	202413-0-11	
				204940-0-10	2 R	204942-0-10	2 R			204033-0-10	R 204675-0-10
				204997-0-00 •	1,5 R	204851-0-11 •	1,5 R				
				204941-0-10 ▲	2 R	204943-0-11 ▲	2 R				
329-01-2CD-02	205025-0-10	5,5	205007-0-10	1,5	205011-0-10	1,5	202609-0-10	205033-3-11	202092-0-10	202413-0-11	
				205059-0-10	2 R	205064-0-10	2 R			204033-0-10	R 204676-0-10
				205060-0-10 •	2 R	205065-0-10 •	2 R				
329-12-2CD-02	206172-2-00	4,5	206176-0-00	1,5	204850-0-10	1,5	202609-0-10	204873-3-11	202092-0-10	202413-0-11	
								204033-0-10	R 204675-0-10		
329-22-2CD-02	204824-0-10	3	204815-0-10	1,5	204818-0-10	1,5	204819-0-10	204828-3-10	202092-0-10	202413-0-11	
								204033-0-10	R 204675-0-10		

Indice  
Data  
Vr.  
Modific.

Si rende noto che il contenuto  
non potrà essere utilizzato o  
riprodotto senza permesso scritto  
della proprietaria S.p.A. V. L. Di  
stessa intende tutelare i suoi diritti  
La norma di legge.





Si rende noto che il contenuto del presente tavolo non è da considerarsi definitivo e che il contenuto può subire modifiche e integrazioni. Le parti non ancora definite saranno indicate con la sigla "N.D.". La presente intenzione è pubblicata in conformità di legge.

**Rimoldi**

• ▲ ★

Vedere note parte introduttiva  
See introductory notes

Voir notes d'introduction  
Siehe Anmerkungen der Einleitung

Indice

00

T.A.B.

**R300**

Data

Foglio 27

Segue F. -

Simbolo testa Machine symbol Symbole de la tête Symbol des Oberteiles	Placca ago Needle plate Plaque a aiguille Stichplatte	Griffa principale Main feed dog Griffe principale Haupt-Transporteur	Griffa sussidiaria Auxiliary feed dog Griffe subsidaire Hilfs-Transporteur	Griffino Chaining feed dog Griffe p. chaînette Klein-Transporteur	Piedino Presser foot Pied-presseur Drueckerfuss	Crochet superiore Upper looper Crochet supérieur Oberer Greifer	Crochet inferiore Lower looper Crochet inférieur Unterer Greifer
330-00-1CD-01	205153-0-10	205138-0-10	1,5	205139-0-10	1,5	205196-3-10	204675-0-10 204676-0-10 R
330-00-1CD-02	205208-0-10	205205-0-10 205221-0-10	2 1,5 R	205206-0-10 205222-0-10	2 1,5 R	205209-3-10 205223-3-10	204675-0-10 P
330-00-1CD-03	205246-0-10	205240-0-10 205241-0-10 •	2 2 R	205242-0-10 205243-0-10 •	2 2 R	205244-0-10 205245-0-10 •	205247-3-10 205223-3-10 R
330-00-1CD-04	205704-0-00	205702-0-00	2	205701-0-00	2	205710-3-00	204675-0-10 204676-0-10 R
330-12-1CD-01	205402-0-10	205390-0-10	1,5	206225-0-00	1,5	206224-0-00	205418-3-10 204675-0-10
330-12-1CD-03	205403-0-10	205390-0-10	1,5	206225-0-00	1,5	206224-0-00	205418-3-10 204675-0-10
330-12-2CD-02	206229-0-00	206228-0-00	1,5	206226-0-00	1,5	206227-0-00	206231-3-00 204676-0-10 204675-0-10 R
330-22-1CD-01	205342-0-10	205326-0-10	1,5	205328-0-10	1,5	205346-3-10	204675-0-10

Indice  
Data  
Vr.  
modificabile

*Rumoldi*

Simbolo testa Head symbol Symbole de la tête Symbol des Obertheiles	Coltello superiore Upper knife Couteau supérieur Oberes Messer	Coltello inferiore Lower knife Couteau inférieur Gegen Messer	Salva ago Rear needle guard Protège-aiguille Nadelschutz	Spingi asola Front needle guard Pare-boucle Schlingen- Spreizer	Simbolo testa Head symbol Symbole de la tête Symbol des Obertheiles	Coltello superiore Upper knife Couteau supérieur Oberes Messer	Coltello inferiore Lower knife Couteau inférieur Gegen Messer	Salva ago Rear needle guard Protège-aiguille Nadelschutz	Spingi asola Front needle guard Pare-boucle Schlingen- Spreizer
023-04-01	200270-0-10	200273-0-10			327-00-1CD-06	207001-2-00 202932-0-10	207016-2-00 203012-0-10	203758-0-10	203757-0-10
023-04-02	200270-0-10	200273-0-10			327-00-1CD-07	207000-2-00 202142-0-10 202143-0-10 207008-2-00	207015-2-00 202146-0-10	202140-0-10	202137-0-10
023-04-03	200270-0-10	200273-0-10			327-00-1CD-09	207000-2-00 202142-0-10 202143-0-10 207008-2-00	207015-2-00 202146-0-10	202140-0-10	202137-0-10
023-04-04	200270-0-10	200273-0-10			327-00-1CD-10	207000-2-00 202142-0-10 202143-0-10 207008-2-00	207015-2-00 202146-0-10	202140-0-10	202137-0-10
023-04-05	200270-0-10	200273-0-10			327-00-1CD-25	207006-2-00 203066-0-10	207024-2-00 203144-0-10	202140-0-10	202137-0-10
227-34-01	207000-2-00 202142-0-10 202143-0-10 207008-2-00	207015-2-00 202146-0-10	203850-0-10	203849-0-10	327-00-1CD-26	207006-2-00 203066-0-10	207017-2-00 203069-0-10	202140-0-10	202137-0-10
227-34-03	207000-2-00 202142-0-10 202143-0-10 207008-2-00	207015-2-00 202146-0-10	203850-0-10	203849-0-10	327-00-1CD-27	207006-2-00 203066-0-10	207017-2-00 203069-0-10	202140-0-10	202137-0-10
327-00-1CD-01	207000-2-00 202142-0-10 202143-0-10 207008-2-00	207015-2-00 202146-0-10	202140-0-10	202137-0-10	327-00-1CD-29	207007-2-00 203812-0-10	207017-2-00 203069-0-10	202140-0-10	202137-0-10
327-00-1CD-02	207000-2-00 202142-0-10 202143-0-10 207008-2-00	207015-2-00 202146-0-10	202140-0-10	202137-0-10	327-00-1CD-30	207001-2-00 207006-2-00	207016-2-00 207017-2-00	203758-0-10	203757-0-10
327-00-1CD-03	202629-0-10 202630-0-10	207015-2-00 202146-0-10	202140-0-10	202624-0-10	327-00-1CD-31	207000-2-00 202142-0-10 202143-0-10 207008-2-00	207015-2-00 202146-0-10	202140-0-10	202137-0-10
327-00-1CD-05	207000-2-00 202142-0-10 202143-0-10 207008-2-00	207015-2-00 202146-0-10	202140-0-10	202137-0-10					

Indice  
Data  
Vr.  
Modifiche

Si rende noto che il contenuto del presente tavolo è di esclusiva proprietà della Rumoldi e che non può essere in alcun modo divulgato a terzi o riprodotto integralmente che parzialmente senza l'autorizzazione scritta della proprietaria S.p.A. V. Rile (C) & C. La riproduzione, totale o parziale, è vietata.

Rimoldi

Simbolo testa Head symbol Symbole de la tête Symbol des Oberteiles	Coltello superiore Upper knife Couteau supérieur Oberes Messer	Coltello inferiore Lower knife Couteau inférieur Gegen Messer	Salva ago Rear needle guard Protège-aiguille Nadelschutz	Spingi asola Front needle guard Pare-boucle Schlingen- Spreizer	Simbolo testa Head symbol Symbole de la tête Symbol des Oberteiles	Coltello superiore Upper knife Couteau supérieur Oberes Messer	Coltello inferiore Lower knife Couteau inférieur Gegen Messer	Salva ago Rear needle guard Protège-aiguille Nadelschutz	Spingi asola Front needle guard Pare-boucle Schlingen- Spreizer
327-00-1CD-32	207000-2-00 202142-0-10 R 202143-0-10 R 207008-2-00 R	207015-2-00 202146-0-10 R	202140-0-10	202137-0-10	327-00-2CD-15	207000-2-00 202142-0-10 R 202143-0-10 R 207008-2-00 R	207015-2-00 202146-0-10 R	204025-0-11	204024-0-10
327-00-1CD-39	207000-2-00 202142-0-10 R 202143-0-10 R 207008-2-00 R	207015-2-00 202146-0-10 R	202140-0-10	202137-0-10	327-00-2CD-16	207000-2-00 202142-0-10 R 202143-0-10 R 207008-2-00 R	207015-2-00 202146-0-10 R	204025-0-11	204024-0-10
327-00-1MD-23	207004-2-00 203759-0-10 R 203783-0-10 R 207003-2-00 R	207016-2-00 203012-0-10 R	203758-0-10	203757-0-10	327-00-2CD-17	207002-2-00 203010-0-10 R	207016-2-00 203012-0-10 R	204025-0-11	204024-0-10
327-00-1MD-33	207004-2-00 203759-0-10 R 203783-0-10 R 207003-2-00 R	207016-2-00 203012-0-10 R	203758-0-10	203757-0-10	327-00-2CD-18	207002-2-00 203010-0-10 R	207016-2-00 203012-0-10 R	203432-0-10	203430-0-10
327-00-1MD-34	207004-2-00 203759-0-10 R 203783-0-10 R 207003-2-00 R	207016-2-00 203012-0-10 R	203758-0-10	203757-0-10	327-00-2CD-32	207001-2-00 202932-0-10 R	207016-2-00 203012-0-10 R	204025-0-11	204024-0-10
327-00-2CD-12	207000-2-00 202142-0-10 R 202143-0-10 R 207008-2-00 R	207015-2-00 202146-0-10 R	203433-0-10	203430-0-10	327-00-2CD-34	207000-2-00 202142-0-10 R 202143-0-10 R 207008-2-00 R	207015-2-00 202146-0-10 R	203432-0-10	203430-0-10
327-00-2CD-13	207000-2-00 202142-0-10 R 202143-0-10 R 207008-2-00 R	207015-2-00 202146-0-10 R	203433-0-10	203430-0-10	327-00-2CD-35	207002-2-00 203010-0-10 R	207016-2-00 203012-0-10 R	204025-0-11	204024-0-10
327-00-2CD-14	207001-2-00 202932-0-10 R	207016-2-00 203012-0-10 R	204025-0-11	204024-0-10	327-00-2CD-38	207000-2-00 202142-0-10 R 202143-0-10 R 207008-2-00 R	207015-2-00 202146-0-10 R	203432-0-10	203430-0-10
327-00-2CD-15	207000-2-00 202142-0-10 R 202143-0-10 R 207008-2-00 R	207015-2-00 202146-0-10 R	203433-0-10	203430-0-10	327-00-2CD-39	207001-2-00 202932-0-10 R	207016-2-00 203012-0-10 R	204025-0-11	204024-0-10
327-00-2CD-16	207000-2-00 202142-0-10 R 202143-0-10 R 207008-2-00 R	207015-2-00 202146-0-10 R	203433-0-10	203430-0-10	327-00-2CD-41	207000-2-00 202142-0-10 R 202143-0-10 R 207008-2-00 R	207015-2-00 202146-0-10 R	204025-0-11	204024-0-10

Si rende noto che il contenuto degli  
non potrà essere utilizzato o ripo-  
mento che parzialmente senza l'au-  
ta della proprietà S.p.A. V. RIMOLDI & C. La  
stessa intende tutelare i suoi diritti a norma di legge.

modifiche

Vr.	Data	Indice



*Rumoldi*

Simbolo testa Head symbol Symbole de la tête Symbol des Oberteiles	Coltello superiore Upper knife Couteau supérieur Oberes Messer	Coltello inferiore Lower knife Couteau inférieur Gegen Messer	Salva ago Rear needle guard Protège-aiguille Nadelschutz	Spingi asola Front needle guard Pare-boucle Schlingen- Spreizer	Simbolo testa Head symbol Symbole de la tête Symbol des Oberteiles	Coltello superiore Upper knife Couteau supérieur Oberes Messer	Coltello inferiore Lower knife Couteau inférieur Gegen Messer	Salva ago Rear needle guard Protège-aiguille Nadelschutz	Spingi asola Front needle guard Pare-boucle Schlingen- Spreizer	
327-00-2CD-44	207000-2-00	207015-2-00	203432-0-10	203430-0-10	327-01-1CD-03	207001-2-00	207016-2-00	203758-0-10	203757-0-10	
	202142-0-10	R 202146-0-10	R			202932-0-10	R 203012-0-10	R		
	202143-0-10	R								
	207008-2-00	R								
327-00-2CD-45	207008-2-00	207015-2-00	204025-0-11	204024-0-10	327-01-1CD-04	207000-2-00	207015-2-00	202140-0-10	202137-0-10	
	202142-0-10	R 202146-0-10	R			202142-0-10	R 202146-0-10	R		
	202143-0-10	R				202143-0-10	R			
	207000-2-00	R				207008-2-00	R			
327-00-2MD-20	207004-2-00	207016-2-00	204025-0-11	204024-0-10	327-01-1CD-05	207000-2-00	207015-2-00	202140-0-10	202137-0-10	
	203759-0-10	R 203012-0-10	R			202142-0-10	R 202146-0-10	R		
	203783-0-10	R				202143-0-10	R			
	207003-2-00	R				207008-2-00	R			
327-00-2MD-21	207004-2-00	207016-2-00	204025-0-11	204024-0-10	327-01-1CD-06	207001-2-00	207016-2-00	203758-0-10	203757-0-10	
	203759-0-10	R 203012-0-10	R			202932-0-10	R 203012-0-10	R		
	203783-0-10	R								
	207003-2-00	R								
327-00-2MD-36	207004-2-00	207016-2-00	203432-0-10	203430-0-10	327-01-1MD-08	207004-2-00	207016-2-00	203758-0-10	203757-0-10	
	203759-0-10	R 203012-0-10	R			203759-0-10	R 203012-0-10	R		
	203783-0-10	R				203783-0-10	R			
	207003-2-00	R				207003-2-00	R			
327-00-2MD-37	207004-2-00	207016-2-00	204025-0-11	204024-0-10	327-01-1MD-09	207004-2-00	207016-2-00	203758-0-10	203757-0-10	
	203759-0-10	R 203012-0-10	R			203759-0-10	R 203012-0-10	R		
	203783-0-10	R				203783-0-10	R			
	207003-2-00	R				207003-2-00	R			
327-01-1MD-10	207004-2-00	207016-2-00	204025-0-11	204024-0-10	327-01-1MD-10	207004-0-10	207016-2-00	203758-0-10	203757-0-10	
	203759-0-10	R 203012-0-10	R			203759-0-10	R 203012-0-10	R		
	203783-0-10	R				203783-0-10	R			
	207003-2-00	R				207003-2-00	R			
327-01-1CD-01	207000-2-00	207015-2-00	202140-0-10	202137-0-10	327-01-2CD-05	207002-2-00	207016-2-00	204025-0-11	204024-0-10	
	202142-0-10	R 202146-0-10	R			203010-0-10	R 203012-0-10	R		
	202143-0-10	R								
	207008-2-00	R								
327-01-1CD-02	207000-2-00	207015-2-00	202140-0-10	202137-0-10	327-01-2CD-06	207002-2-00	207016-2-00	203432-0-10	203430-0-10	
	202142-0-10	R 202146-0-10	R			203010-0-10	R 203012-0-10	R		
	202143-0-10	R								
	207008-2-00	R								

Indice  
Data  
Vr  
modifiche

Si rende noto che il contenuto dell'presente tavola non potrà essere utilizzato o riprodotto in alcun modo, neppure parzialmente, senza il permesso scritto della Rumoldi & C. La stessa intende tutelare i suoi diritti a norma di legge.

# Rumoldi

Simbolo testa Head symbol Symbole de la tête Symbol des Oberteiles	Coltello superiore Upper knife Couteau supérieur Oberes Messer	Coltello inferiore Lower knife Couteau inférieur Gegen Messer	Salva ago Rear needle guard Protège-aiguille Nadelschutz	Spingi asola Front needle guard Pare-boucle Schlingen- Spreizer	Simbolo testa Head symbol Symbole de la tête Symbol des Oberteiles	Coltello superiore Upper knife Couteau supérieur Oberes Messer	Coltello inferiore Lower knife Couteau inférieur Gegen Messer	Salva ago Rear needle guard Protège-aiguille Nadelschutz	Spingi asola Front needle guard Pare-boucle Schlingen- Spreizer		
327-01-2CD-10	207000-2-00 202142-0-10 202143-0-10 207008-2-00	R 202146-0-10 R R	204025-0-11	204024-0-10	327-11-1CD-01	207000-2-00 202142-0-10 202143-0-10 207008-2-00	R R R	207015-2-00 202146-0-10	R R	202140-0-10	202137-0-10
327-01-2CD-12	207001-2-00 202932-0-10	R 203012-0-10 R	204025-0-11	204024-0-10	327-11-1CD-02	207000-2-00 202142-0-10 202143-0-10 207008-2-00	R R R	207015-2-00 203146-0-10	R R	202140-0-10	202137-0-10
327-01-2CD-13	207001-2-00 202932-0-10	R 203012-0-10 R	204025-0-11	204024-0-10	327-12-1CD-01	207003-2-00 203783-0-10	R R	207023-2-00 205339-0-10	R R	202140-0-10	202137-0-10
327-01-2MD-07	207004-2-00 203759-0-10 203783-0-10 207003-2-00	R 203012-0-10 R R	204025-0-11	204024-0-10	327-16-1CD-01					202140-0-10	202137-0-10
327-01-2MD-11	207004-2-00 203759-0-10 203783-0-10 207003-0-10	R 203012-0-10 R R	203432-0-10	203430-0-10	327-22-1CD-01	207001-2-00 202932-0-10	R R	207016-2-00 203012-0-10	R R	203758-0-10	203757-0-10
327-10-1CD-02	207000-2-00 202142-0-10 202143-0-10 207008-2-00	R 202146-0-10 R R	202140-0-10	202137-0-10	327-22-1CD-02	207000-2-00 202142-0-10 202143-0-10 207008-2-00	R R R	207015-2-00 202146-0-10	R R	202140-0-10	202137-0-10
327-10-1CD-03	207000-2-00 202142-0-10 202143-0-10 207008-2-00	R 202146-0-10 R R	202140-0-10	202137-0-10	327-22-1CD-03	207000-2-00 202142-0-10 202143-0-10 207008-2-00	R R R	207024-2-00 203144-0-10	R R	202140-0-10	202137-0-10
327-10-1CD-04	207000-2-00 202142-0-10 202143-0-10 207008-2-00	R 202146-0-10 R R	202140-0-10	202137-0-10	327-22-1CD-04	207000-2-00 202142-0-10 202143-0-00 207008-2-00	R R R	207015-2-00 202146-0-10	R R	202140-0-10	202137-0-10
327-10-1CD-06	207000-2-00 202142-0-10 202143-0-10 207008-0-10	R 202146-0-10 R R	202140-0-10	202137-0-10	327-22-1CD-05	207000-2-00 202142-0-10 202143-0-10 207008-2-00	R R R	207024-2-00 203144-0-10	R R	202140-0-10	202137-0-10

Si rende noto che il contenuto degli elenchi qui sopra riportati non potrà essere utilizzato o riprodotto integralmente o in parte senza la autorizzazione scritta della proprietaria S.p.A. V. Rumoldi & C. S.p.A. La stessa intende tutelare i suoi diritti a norma di legge.

<b>modifiche</b>	
Vr	Indice
	Data

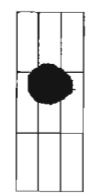

**Ronald**

Simbolo testa Head symbol Symbole de la tête Symbol des Oberteile	Coltello superiore Upper knife Couteau supérieur Oberes Messer	Coltello inferiore Lower knife Couteau inférieur Gegen Messer	Salva ago Rear needle guard Protège-aiguille Nadelschutz	Spingi asola Front needle guard Pare-boucle Schlingen- Spreizer	Simbolo testa Head symbol Symbole de la tête Symbol des Oberteile	Coltello superiore Upper knife Couteau supérieur Oberes Messer	Coltello inferiore Lower knife Couteau inférieur Gegen Messer	Salva ago Rear needle guard Protège-aiguille Nadelschutz	Spingi asola Front needle guard Pare-boucle Schlingen- Spreizer
327-22-1MD-07	207004-2-00	207016-2-00	203758-0-10	203757-0-10	327-28-1CD-07	207000-2-00	207015-2-00	202140-0-10	202137-0-10
	203759-0-10	R 203012-0-10	R	202142-0-10		R 202146-0-10	R		
	203783-0-10	R		202143-0-10		R			
	207003-2-00	R		207008-2-00		R			
327-22-2CD-06	207001-2-00	207016-2-00	204025-0-11	204024-0-10	327-28-1CD-09	207000-2-00	207015-2-00	202140-0-10	202137-0-10
	202932-0-10	R 203012-0-10	R	202142-0-10		R 202146-0-10	R		
327-22-2MD-09	207004-2-00	207016-2-00	204025-0-11	204024-0-10	327-28-1CD-11	207000-2-00	207015-2-00	202140-0-10	202137-0-10
	203759-0-10	R 203012-0-10	R	202142-0-10		R 202146-0-10	R		
	203783-0-10	R		202143-0-10		R			
	207003-2-00	R		207008-2-00		R			
327-23-1CD-01	207001-2-00	207016-2-00	203758-0-10	203757-0-10	327-28-1CU-04	207001-2-00	207016-2-00	203758-0-10	203757-0-10
	202932-0-10	R 203012-0-10	R	202932-0-10		R 203012-0-10	R		
327-23-1CD-02	207000-2-00	207015-2-00	202140-0-10	202137-0-10	327-28-1CU-06	207001-2-00	207016-2-00	203758-0-10	203757-0-10
	202142-0-10	R 202146-0-10	R	202932-0-10		R 203012-0-10	R		
	202143-0-10	R		207008-2-00		R			
	207008-2-00	R							
327-23-1CD-08	207000-2-00	207015-2-00	202140-0-10	202137-0-10	327-29-1CD-01	207006-2-00	207015-2-00	202140-0-10	202137-0-10
	202142-0-10	R 202146-0-10	R	203066-0-10		R 202146-0-10	R		
	202143-0-10	R							
	207008-2-00	R							
327-23-1MD-07	207004-2-00	207016-2-00	203758-0-10	203757-0-10	327-29-1CD-02	207006-2-00	207015-2-00	202140-0-10	202137-0-10
	203759-0-10	R 203012-0-10	R	203066-0-10		R 202146-0-10	R		
	203783-0-10	R							
	207003-2-00	R							
327-23-2CD-06	207001-2-00	207016-2-00	204025-0-11	204024-0-10	327-29-1CD-03	207000-2-00	207015-2-00	202140-0-10	202137-0-10
	202932-0-10	R 203012-0-10	R	202142-0-10		R 202146-0-10	R		
				202143-0-10		R			
				207008-2-00		R			
327-28-1CD-02	207000-2-00	207015-2-00	202140-0-10	202137-0-10	327-29-1CD-05	207006-2-00	207015-2-00	202140-0-10	202137-0-10
	202142-0-10	R 202146-0-10	R	203066-0-10		R 202146-0-10	R		
	202143-0-10	R							
	207008-2-00	R							
327-29-1CD-06	207000-2-00	207015-2-00	202140-0-10	202137-0-10	327-29-1CD-06	207006-2-00	207015-2-00	202140-0-10	202137-0-10
	202142-0-10	R 202146-0-10	R	203066-0-10		R 202146-0-10	R		
	202143-0-10	R							
	207008-2-00	R							

Indice  
Data  
Vr.

Si rende noto che il contenuto della presente tavola non potrà essere utilizzato o riprodotto né in qualunque modo divulgato a terzi, o riprodotto integralmente o in parte, senza il permesso scritto dalla stessa proprietaria S.P.A. V. Riva, D.I. & C. La stessa intende tutelare i suoi diritti alla norma di legge.



Rumoldi

Si rende noto che il contenuto delle presenti tavole non potrà essere utilizzato o riprodotto in alcun modo senza l'autorizzazione scritta della proprietaria S.p.A. V. Rumoldi & C. La stessa intende tutelare i suoi diritti a norma di legge.

Simbolo testa Head symbol Symbole de la tête Symbol des Oberteiles	Coltello superiore Upper knife Couteau supérieur Oberes Messer	Coltello inferiore Lower knife Couteau inférieur Gegen Messer	Salva ago Rear needle guard Protège-aiguille Nadelschutz	Spingi asola Front needle guard Pare-boucle Schlingen- Spreizer	Simbolo testa Head symbol Symbole de la tête Symbol des Oberteiles	Coltello superiore Upper knife Couteau supérieur Oberes Messer	Coltello inferiore Lower knife Couteau inférieur Gegen Messer	Salva ago Rear needle guard Protège-aiguille Nadelschutz	Spingi asola Front needle guard Pare-boucle Schlingen- Spreizer
327-29-1CD-08	207006-2-00 203066-0-10	207017-2-00 203069-0-10	202140-0-10	202137-0-10	028-00-08	202142-0-10	202146-0-10	202140-0-10	202137-0-10
327-30-1CD-07	207000-2-00 202142-0-10 202143-0-10 207008-2-00	207015-2-00 202146-0-10	202140-0-10	202137-0-10	028-00-09 028-00-10 028-00-11	202142-0-10 202142-0-10 202932-0-10	202146-0-10 202146-0-10 203012-0-10	203433-0-10 203433-0-10 204025-0-11	203430-0-10 203430-0-10 204024-0-10
327-34-1CD-01	207000-2-00 202142-0-10 202143-0-10 207008-2-00	207015-2-00 202146-0-10	202140-0-10	202137-0-10	028-00-12 028-00-13 028-00-14	202142-0-10 202142-0-10 203010-0-10	202146-0-10 202146-0-10 203012-0-10	204025-0-11 204025-0-11 204025-0-11	204024-0-10 204024-0-10 204024-0-10
327-34-1MD-02		203012-0-10	203758-0-10	203757-0-10	028-00-15	203010-0-10	203012-0-10	203432-0-10	203430-0-10
327-34-1MD-03	207004-2-00 203759-0-10 203783-0-10 207003-2-00	207016-2-00 203012-0-10	203758-0-10	203757-0-10	028-00-16 028-00-17	203010-0-10 203759-0-10 203783-0-10	203012-0-10 203012-0-10	203432-0-10 204025-0-11	203430-0-10 204024-0-10
327-49-1MD-01	207009-2-00 204065-0-10	207016-2-00 203012-0-10	203758-0-10	203757-0-10	028-00-18	203759-0-10 203783-0-10	203012-0-10	203758-0-10	203757-0-10
028-00-01	202142-0-10	202146-0-10	202140-0-10	202137-0-10	028-00-19 028-00-20			203758-0-10	203757-0-10
028-00-02	202932-0-10	203012-0-10	203758-0-10	203757-0-10	028-00-21	203066-0-10	203144-0-10	202140-0-10	202137-0-10
028-00-03	202142-0-10	202146-0-10	202140-0-10	202137-0-10	028-00-22	203066-0-10	203069-0-10	202140-0-10	202137-0-10
028-00-04	202142-0-10	202146-0-10	202140-0-10	202137-0-10	028-00-23	203066-0-10	203069-0-10	202140-0-10	202137-0-10
028-00-05	202629-0-10	202146-0-10	202140-0-10	202624-0-10	028-00-24	203066-0-10	203069-0-10	202140-0-10	202137-0-10
028-00-06	202142-0-10	202146-0-10	202140-0-10	202137-0-10	028-00-25	203812-0-10	203069-0-10	202140-0-10	202137-0-10
028-00-07	202142-0-10	202146-0-10	202140-0-10	202137-0-10	028-00-26	202932-0-10 202142-0-10	203012-0-10 202146-0-10	203758-0-10 202140-0-10	203757-0-10 202137-0-10

modifiche

Vr	Data	Indice



# Rumoldi

Indice  
 00    01    02    03    04    05    06    07    08    09    10  
 Data    Foglio 7    Segue F. 8

## R300

Simbolo testa Head symbol Symbole de la tête Symbol des Oberteiles	Coltello superiore Upper knife Couteau supérieur Oberes Messer	Coltello inferiore Lower knife Couteau inférieur Gegen Messer	Salva ago Rear needle guard Protège-aiguille Nadelschutz	Spingi asola Front needle guard Pare-boucle Schlingen- Spreizer	Simbolo testa Head symbol Symbole de la tête Symbol des Oberteiles	Coltello superiore Upper knife Couteau supérieur Oberes Messer	Coltello inferiore Lower knife Couteau inférieur Gegen Messer	Salva ago Rear needle guard Protège-aiguille Nadelschutz	Spingi asola Front needle guard Pare-boucle Schlingen- Spreizer
028-01-01	202142-0-10	202146-0-10	202140-0-10	202137-0-10	028-28-06	202932-0-10	203012-0-10	203758-0-10	203757-0-10
028-01-02	202142-0-10	202146-0-10	202140-0-10	202137-0-10	028-28-07	202142-0-10	202146-0-10	202140-0-10	202137-0-10
028-01-03	202932-0-10	203012-0-10	203758-0-10	203757-0-10	028-28-09			203758-0-10	203757-0-10
028-01-04	202142-0-10	202146-0-10	202140-0-10	202137-0-10	028-28-10			203758-0-10	203757-0-10
028-01-05	203010-0-10	203012-0-10	204025-0-11	204024-0-10	028-28-11	204559-0-10	204561-0-10	203758-0-10	203757-0-10
028-01-06	203010-0-10	203012-0-10	203432-0-10	203430-0-10	028-29-01	203066-0-10	202146-0-10	202140-0-10	202137-0-10
028-01-07	203759-0-10	203012-0-10	204025-0-11	204024-0-10	028-29-02	202142-0-10	202146-0-10	202140-0-10	202137-0-10
028-01-08	203759-0-10	203012-0-10	203758-0-10	203757-0-10	028-29-03			202140-0-10	202137-0-10
028-10-01	202142-0-10	202146-0-10	202140-0-10	202137-0-10	028-29-04	202142-0-10	202146-0-10	202140-0-10	202137-0-10
028-10-02	202142-0-10	202146-0-10	202140-0-10	202137-0-10	028-29-05	203066-0-10	202146-0-10	202140-0-10	202137-0-10
028-10-03	202142-0-10	202146-0-10	202140-0-10	202137-0-10	028-29-06	203066-0-10	202146-0-10	202140-0-10	202137-0-10
028-10-04	202142-0-10	202146-0-10	202140-0-10	202137-0-10	028-29-07	203066-0-10	203069-0-10	202140-0-10	202137-0-10
028-10-05	202142-0-10	202146-0-10	202140-0-10	202137-0-10	028-29-08			203758-0-10	203757-0-10
028-11-01	202142-0-10	202146-0-10	202140-0-10	202137-0-10	028-30-01	202142-0-10	202146-0-10	202140-0-10	202137-0-10
028-16-01			202140-0-10	202137-0-10	028-30-02	202142-0-10	202146-0-10	202140-0-10	202137-0-10
028-28-01	202142-0-10	202146-0-10	202140-0-10	202137-0-10	028-30-03	203066-0-10	203144-0-10	202140-0-10	202137-0-10
028-28-02	202142-0-10	202146-0-10	202140-0-10	202137-0-10	028-30-04	203066-0-10	203144-0-10	202140-0-10	202137-0-10
028-28-03	202932-0-10	203012-0-10	203758-0-10	203757-0-10	028-30-05	203066-0-10	203069-0-10	202140-0-10	202137-0-10
028-28-04	202932-0-10	203012-0-10	203758-0-10	203757-0-10	028-30-06	203066-0-10	203069-0-10	202140-0-10	202137-0-10
028-28-05	202932-0-10	203012-0-10	203758-0-10	203757-0-10	028-34-01		203012-0-10	203758-0-10	203757-0-10

Indice  
 Data  
 Vr

Si rende noto che il contenuto della presente tavola non potrà essere utilizzato o riprodotto, né in tutto o in parte, senza la permesso scritto e autorizzato della proprietaria S.p.A. V. R. Di. & C. La stessa, intente tutelare i suoi diritti, si riserva di leggere

Runoldi

Si rende noto che il contenuto della presente tavola è destinato ad essere utilizzato come riferimento e non può essere copiato o ristampato senza la permesso scritto dell'Editore Runoldi. Sono protetti i diritti d'autore e di proprietà intellettuale.

modifiche

V.	Indice	Data

Simbolo testa Head symbol Symbole de la tête Symbol des Oberteiles	Coltello superiore Upper knife Couteau supérieur Oberes Messer	Coltello inferiore Lower knife Couteau inférieur Gegen Messer	Salva ago Rear needle guard Protège-aiguille Nadelschutz	Spingi asola Front needle guard Pare-boucle Schlingen- Spreizer	Simbolo testa Head symbol Symbole de la tête Symbol des Oberteiles	Coltello superiore Upper knife Couteau supérieur Oberes Messer	Coltello inferiore Lower knife Couteau inférieur Gegen Messer	Salva ago Rear needle guard Protège-aiguille Nadelschutz	Spingi asola Front needle guard Pare-boucle Schlingen- Spreizer
228-00-01	207000-2-00 202142-0-10 R 202143-0-10 R 207008-2-00 R	207015-2-00 202146-0-10 R	202140-0-10	202137-0-10	228-00-09	207000-2-00 202142-0-10 R 202143-0-10 R 207008-2-00 R	207015-2-00 202146-0-10 R	203433-0-10	203430-0-10
228-00-02	207000-2-00 202142-0-10 R 202143-0-10 R 207008-2-00 R	207015-2-00 202146-0-10 R	202140-0-10	202137-0-10	228-00-10	207000-2-00 202142-0-10 R 202143-0-10 R 207008-2-00 R	207015-2-00 202146-0-10 R	203433-0-10	203430-0-10
228-00-03	202629-0-10	207015-2-00 202146-0-10 R	202140-0-10	202624-0-10	228-00-11	207006-2-00 203066-0-10 R	207024-2-00 203144-0-10 R	202140-0-10	202137-0-10
228-00-04	207001-2-00 202932-0-10 R	207016-2-00 203012-0-10 R	203758-0-10	203757-0-10	228-00-12	207006-2-00 203066-0-10 R	207017-2-00 203069-0-10 R	202140-0-10	202137-0-10
228-00-05	207000-2-00 202142-0-10 R 202143-0-10 R 207008-2-00 R	207015-2-00 202146-0-10 R	202140-0-10	202137-0-10	228-00-13	207001-2-00 202932-0-10 R	207016-2-00 203012-0-10 R	203758-0-10	203757-0-10
228-00-06	207000-2-00 202142-0-10 R 202143-0-10 R 207008-2-00 R	207015-2-00 202146-0-10 R	202140-0-10	202137-0-10	228-00-14	207000-2-00 202142-0-10 R 202143-0-10 R 207008-2-00 R	207015-2-00 202146-0-10 R	202140-0-10	202137-0-10
228-00-07	207000-2-00 202142-0-10 R 202143-0-10 R 202144-0-10 R 207008-2-00 R	207015-2-00 202146-0-10 R 202147-0-10 R	202140-0-10	202137-0-10	228-00-15	207000-2-00 202142-0-10 R 202143-0-10 R 207008-2-00 R	207015-2-00 202146-0-10 R	202140-0-10	202137-0-10
228-00-08	207000-2-00 202142-0-10 R 202143-0-10 R 207008-2-00 R	207015-2-00 202146-0-10 R	202140-0-10	202137-0-10	228-00-16		203758-0-10	203757-0-10	
					228-00-17	207000-2-00 202142-0-10 R 202143-0-10 R 207008-2-00 R	207015-2-00 202146-0-10 R	202140-0-10	202137-0-10
					228-00-18	207000-2-00 202142-0-10 R 202143-0-10 R 207008-2-00 R	207015-2-00 202146-0-10 R	202140-0-10	202137-0-10

**Rumoldi**

Simbolo testa Head symbol Symbole de la tête Symbol des Oberteiles	Coltello superiore Upper knife Couteau supérieur Oberes Messer	Coltello inferiore Lower knife Couteau inférieur Gegen Messer	Salva ago Rear needle guard Protège-aiguille Nadelschutz	Spingi asola Front needle guard Pare-boucle Schlingen- Spreizer	Simbolo testa Head symbol Symbole de la tête Symbol des Oberteiles	Coltello superiore Upper knife Couteau supérieur Oberes Messer	Coltello inferiore Lower knife Couteau inférieur Gegen Messer	Salva ago Rear needle guard Protège-aiguille Nadelschutz	Spingi asola Front needle guard Pare-boucle Schlingen- Spreizer
228-00-19	207000-2-00 202142-0-10 R 202143-0-10 R 207008-2-00 R	207015-2-00 202146-0-10 R	203433-0-10	203430-0-10	228-10-04	207000-2-00 202142-0-10 R 202143-0-10 R 207008-2-00 R	207015-2-00	204434-0-10	204433-0-10
228-01-01	207000-2-00 202142-0-10 R 202143-0-10 R 207008-2-00 R	207015-2-00 202146-0-10 R	202140-0-10	202137-0-10	228-10-05	207000-2-00 202142-0-10 R 202143-0-10 R 207008-2-00 R	207015-2-00 202146-0-10 R	202140-0-10	202137-0-10
228-01-02	207001-2-00 202932-0-10 R	207016-2-00 203012-0-10 R	202758-0-10	202757-0-10	228-10-06	207000-2-00 202142-0-10 R 202143-0-10 R 207008-2-00 R	207015-2-00 202146-0-10 R	202140-0-10	202137-0-10
228-01-03	207000-2-00 202142-0-10 R 202143-0-10 R 207008-2-00 R	207015-2-00 202146-0-10 R	202140-0-20	202137-0-10	228-10-07	207000-2-00 202142-0-10 R 202143-0-10 R 207008-2-00 R	207015-2-00 202146-0-10 R	202140-0-10	202137-0-10
228-01-04	207000-2-00 202142-0-10 R 202143-0-10 R 207008-2-00 R	207015-2-00 202146-0-10 R	202140-0-10	202137-0-10	228-10-08	207000-2-00 202142-0-10 R 202143-0-10 R 207008-2-00 R	207018-2-00	204434-0-10	204433-0-10
228-10-01	207000-2-00 202142-0-10 R 202143-0-10 R 207008-2-00 R	207015-2-00 202146-0-10 R	202140-0-10	202137-0-10	228-28-01	207000-2-00 202142-0-10 R 202143-0-10 R 207008-2-00 R	207015-2-00 202146-0-10 R	202140-0-10	202137-0-10
228-10-02	207000-2-00 202142-0-10 R 202143-0-10 R 207008-2-00 R	207015-2-00 202146-0-10 R	202140-0-10	202137-0-10	228-28-02	207000-2-00 202142-0-10 R 202143-0-10 R 207008-2-00 R	207015-2-00 202146-0-10 R	202140-0-10	202137-0-10
228-10-03	207000-2-00 202142-0-10 R 202143-0-10 R 207008-2-00 R	207015-2-00 202146-0-10 R	202140-0-10	202137-0-10	228-28-03	207001-2-00 202932-0-10 R	207016-2-00 203012-0-10 R	203758-0-10	203757-0-10

Indice  
Data  
Vr.

Si rende noto che il contenuto della presente tavola non potrà essere utilizzato o riprodotto in alcun modo, né comunque divulgato a terzi, o riprodotto, né integralmente o in parte, senza il permesso scritto della proprietaria S.p.A. V. N. I. D. I. & C. La stessa intende tutelare i suoi diritti a norma di legge.



**Rimoldi**

Simbolo testa Head symbol Symbole de la tête Symbol des Oberteiles	Coltello superiore Upper knife Couteau supérieur Oberes Messer	Coltello inferiore Lower knife Couteau inférieur Gegen Messer	Salva ago Rear needle guard Protège-aiguille Nadelschutz	Spingi asola Front needle guard Pare-boucle Schlingen- Spreizer	Simbolo testa Head symbol Symbole de la tête Symbol des Oberteiles	Coltello superiore Upper knife Couteau supérieur Oberes Messer	Coltello inferiore Lower knife Couteau inférieur Gegen Messer	Salva ago Rear needle guard Protège-aiguille Nadelschutz	Spingi asola Front needle guard Pare-boucle Schlingen- Spreizer		
329-00-2CD-08	207003-2-00 203759-0-10 203783-0-10 207004-2-00	R 204693-0-11 R	207020-2-01 R	204863-0-10	205100-0-10 205430-0-10	329-01-2CD-01	207003-2-00 203759-0-10 203783-0-10 207004-2-00	R 204693-0-11 R	207020-2-01 R	204863-0-10	204690-0-10 204861-0-10
329-00-2CD-09	207003-2-00 203759-0-10 203783-0-10 207004-2-00	R 204693-0-11 R	207020-2-01 R	204863-0-10	204690-0-10 205080-0-10	329-01-2CD-02	207003-2-00 203759-0-10 203783-0-10 207004-2-00	R 204693-0-11 R	207020-2-01 R	204863-0-10	204861-0-10 205024-0-10
329-00-2CD-10	207003-2-00 203759-0-10 203783-0-10 207004-2-00	R 204693-0-11 R	207020-2-01 R	204863-0-10	204861-0-10 205024-0-10	329-12-2CD-02	207003-2-00 203759-0-10 203783-0-10 207004-2-00	R 204693-0-11 R	207020-2-01 R	204863-0-10	204690-0-10 204861-0-10
329-00-2CD-11	207003-2-00 203759-0-10 203783-0-10 207004-2-00	R 204693-0-11 R	207020-2-01 R	204863-0-10	204690-0-10 205080-0-10	329-22-2CD-02	207003-2-00 203759-0-10 203783-0-10 207004-2-00	R 204693-0-11 R	207020-2-01 R	204863-0-10	204820-0-10
329-00-2CD-12	207003-2-00 203759-0-10 203783-0-10 207004-2-00	R 204693-0-11 R	207020-2-01 R	204863-0-10	204690-0-10 204861-0-10	329-22-2CD-03	207003-2-00 203759-0-10 203783-0-10 207004-2-00	R 204693-0-11 R	207020-2-01 R	204863-0-10	204690-0-10 204861-0-10
329-00-2CD-13	207003-2-00 203759-0-10 203783-0-10 207004-2-00	R 204693-0-10 R	207020-2-01 R	204863-0-10	204861-0-10	329-22-2CD-04	207003-2-00 203759-0-10 203783-0-10 207004-2-00	R 204693-0-11 R	207020-2-01 R	204863-0-10	204861-0-10 205024-0-10
329-00-2CD-15	207003-2-00 203759-0-10 203783-0-10 207004-2-00	R 204693-0-11 R	207020-2-01 R	204863-0-10	204690-0-10 204861-0-10	329-23-2CD-02	207003-2-00 203759-0-10 203783-0-10 207004-2-00	R 204693-0-11 R	207020-2-01 R	204863-0-10	204820-0-10 204861-0-10
329-00-3MU-01	207003-2-00 203759-0-10 203783-0-10 207004-2-00	R 206062-0-01 R	207021-2-01 R		206052-0-10 206053-0-10	329-23-2CD-03	207003-2-00 203759-0-10 203783-0-10 207004-2-00	R 204693-0-11 R	207020-2-01 R	204863-0-10	204690-0-10 204861-0-10

Si rende noto che il contenuto della presente tavola modificherebbe il contenuto della tavola precedente, il quale è stato pubblicato integralmente che parzialmente senza l'aggiunta di nuove intenzioni, e non è stato modificato dalla proprietà S. P. A. O. H. di Legnano.

Indice  
Data  
Vr.

**Rumoldi**

Indice				TAB	<b>R300</b>
00					
Data		Foglio 12		Segue F.	

Simbolo testa Head symbol Symbole de la tête Symbol des Oberteiles	Coltello superiore Upper knife Couteau supérieur Oberes Messer	Coltello inferiore Lower knife Couteau inférieur Gegen Messer	Salva ago Rear needle guard Protège-aiguille Nadelschutz	Spingi asola Front needle guard Pare-boucle Schlingen- Spreizer	Simbolo testa Head symbol Symbole de la tête Symbol des Oberteiles	Coltello superiore Upper knife Couteau supérieur Oberes Messer	Coltello inferiore Lower knife Couteau inférieur Gegen Messer	Salva ago Rear needle guard Protège-aiguille Nadelschutz	Spingi asola Front needle guard Pare-boucle Schlingen- Spreizer
329-23-2CD-04	207003-2-00 203759-0-10 203783-0-10 207004-2-00	R 204693-0-11 R R	204863-0-10	204861-0-10 205024-0-10					
330-00-1CD-01	207000-2-00 202142-0-10 202143-0-10 207008-2-00	R 205151-0-10 R R		205148-0-10					
330-00-1CD-02			205236-0-00	205237-0-00					
330-00-1CD-03			205236-0-00	205237-0-00					
330-00-1CD-04	207003-2-00 203759-0-10 203783-0-10 205713-0-00 207004-2-00	R R R R	207023-2-00	205236-0-00 205237-0-00					
330-12-1CD-01	203510-0-10 203526-0-10	R 205400-0-10 R	207025-2-00 205400-0-10	205236-0-00 205237-0-00					
330-12-1CD-03	203510-0-10 203526-0-10	R 205400-0-10 R	207025-2-00 205400-0-10	205236-0-00 205237-0-00					
330-12-2CD-02	203510-0-10 203526-0-10	R 205400-0-10 R	207025-2-00 205400-0-10	205236-0-00 205237-0-00					
330-22-1CD-01	203510-0-10 203526-0-10	R 205400-0-00 R	207025-2-00 205400-0-00	205236-0-00 205237-0-00					

Si rende noto che il contenuto della presente tavola non potrà essere utilizzato o riprodotto senza permesso scritto dalla Rumoldi & C. S.p.A. V. R. V. Roma. La stessa intende tutelare i suoi diritti e norme di legge.

modifiche	
Indice	
Data	
Vr	



ELENCO TESTE CON APPARECCHIATURE  
LIST OF MACHINE HEADS WITH SPECIAL ATTACHMENTS  
LISTE DES TETES AVEC DISPOSITIFS SPECIAUX  
LISTE DER MASCHINENBERTEILE MIT SPEZIALVORRICHTUNGEN



**Rimoldi**

• ▲ ★ Vedere note parte introduttiva  
See introductory notes

Voir notes d'introduction  
Siehe Anmerkungen der Einleitung

Indice  
00  
TAB  
**R300**  
Data Foglio 1 Segue F. 2

Simbolo testa Machine symbol Symbole de la tête Symbol des Oberteiles	Placca ago Needle plate Plaque à aiguille Stichplatte	Griffa principale Main feed dog Griffe principale Haupt-Transporteur	Griffa sussidiaria Auxiliary feed dog Griffe subsidiaire Hilfs-Transporteur	Griffino Chaining feed dog Griffe p. chaînette Klein-Transporteur	Piedino Presser foot Pied-presseur Drueckerfuss	Crochet superiore Upper looper Crochet supérieur Oberer Greifer	Crochet inferiore Lower looper Crochet inférieur Unterer Greifer
327-00-1CD-01/103-90	920768-0-10 920750-0-10 920769-0-10 920770-0-10	3 3,4 R 3,7 R 4,1 R				920751-3-10 927252-3-00 R	
327-00-1CD-01/135-81	923774-0-00 923831-0-00 923832-0-00 923833-0-00 923834-0-00	4,1 4,6 R 5 R 5,6 R 6 R	202056-2-11 •	R	202060-2-11 •	R	921350-0-11 921352-3-10 923901-3-00 • R
327-00-1CD-02/103-90	920786-0-10 920788-0-10	1,8 2,6 R				920789-3-10	
327-00-1CD-02/135-81	923775-0-00 923835-0-00 923836-0-00 923837-0-00 923838-0-00	2 2,5 R 3,5 R 1,5 R 1,2 R			921350-0-11	921381-3-10	
327-00-1CD-03/103-90	920820-0-00	2,5				920810-3-10	
327-00-1CD-03/135-81	923840-0-00 923841-0-00 923842-0-00	3,5 4 R 3 R			921350-0-11	921383-3-10	
327-00-1CD-05/103-90	920786-0-10 920788-0-10	1,8 2,6 R				920789-3-10	
327-00-1CD-05/135-81	923775-0-00 923835-0-00 923836-0-00 923837-0-00 923838-0-00	2 2,5 R 3,5 R 1,5 R 1,2 R			921350-0-11	921382-3-10	
327-00-1CD-06/103-90	203795-0-00	3,6	920802-0-10	1,5		203796-3-00	

Indice  
Data  
Vr.  
Modello

Si rende noto che il contenuto della presente tavola  
è di proprietà esclusiva della Rimoldi S.p.A. e non può  
essere divulgato a terzi o riprodotto sia integral-  
mente che parzialmente senza l'autorizzazione scrit-  
ta della proprietaria S.p.A. Viri, LDI & C. Le  
stesse intese tutelare i loro diritti norma di legge.

**Rumoldi**

• • •

Vedere note parte introduttiva  
See introductory notesVoir notes d'introduction  
Siehe Anmerkungen der Einleitung

Indice		TAB	<b>R300</b>
00			
Data	Foglio 2	Segue F. 3	

Simbolo testa Machine symbol Symbole de la tête Symbol des Oberteileis	Placca ago Needle plate Plaque à aiguille Stichplatte	Griffa principale Main feed dog Griffe principale Haupt-Transporteur	Griffa sussidiaria Auxiliary feed dog Griffe subsidiaire Hilfs-Transporteur	Griffino Chaining feed dog Griffe p. chaînette Klein-Transporteur	Piedino Presser foot Pied-presseur Drueckerfuss	Crochet superiore Upper looper Crochet supérieur Oberer Greifer	Crochet inferiore Lower looper Crochet inférieur Unterer Greifer
327-00-1CD-06/135-81	923890-0-00	5		921350-0-11	921422-3-10		
	923777-0-00	4 R					
	923888-0-00	6 R					
	923891-0-00	7 R					
	923889-0-00	7,5 R					
327-00-1CD-07/103-90	920796-0-10	2,4			920751-3-10 927252-3-00	R	
	920797-0-10	3 R					
327-00-1CD-07/135-81	923830-0-00	3,3		921350-0-11	921352-3-10		
	923850-0-00	1,2 R					
	923851-0-00	2,8 R					
327-00-1CD-09/135-81	921336-4-01	2		921350-0-11	921438-3-10 923910-3-00	R	
	923856-2-00	1,2 R					
	923858-2-00	1,4 R					
327-00-1CD-09/137-81	921336-4-01	2		921350-0-11	921438-3-10 923910-3-00	R	
	923856-2-00	1,2 R					
	923858-2-00	1,4 R					
327-00-1CD-10/135-81	923854-0-00	1		921350-0-11	921439-3-10		
327-00-1CD-10/137-81	923854-0-00	1		921350-0-11	921439-3-10		
327-00-1CD-25/103-90	920862-0-00	2,5			920860-3-00		
327-00-1CD-25/135-81	923911-0-00	3		921350-0-11	921417-3-10		
	923927-0-00	3,5 R					
327-00-1CD-30/103-90	920803-0-10	3,3	920802-0-10		920884-3-00		
	203056-0-00	2,3 R	1,5				
	920805-0-00	4,5 R					
327-00-1CD-30/135-81	923848-0-00	4,5		921350-0-11	926781-3-00		
	923847-0-00	7 R					
	923849-0-00	3,1 R					
327-00-1CD-31/103-90	920812-0-10	2,8			920795-3-10		

Si vende noto che il contenuto della presente tavola non potrà essere utilizzato o riprodotto, né in tutto o in parte, senza permesso scritto dalla proprietaria S.p.A. V. Rizzoli & C. La stessa intende tutelare i suoi diritti a norma di legge.

modifiche

V.	Data	Indice













**Rimoldi**

• • •

Vedere note parte introduttiva  
See introductory notesVoir notes d'introduction  
Siehe Anmerkungen der EinleitungIndice TAB **R300**

Data Foglio 3 Segue F. 4

Simbolo testa Machine symbol Symbole de la tête Symbol des Oberteile	Placca ago Needle plate Plaque à aiguille Stichplatte	Griffa principale Main feed dog Griffe principale Haupt-Transporteur	Griffa sussidiaria Auxiliary feed dog Griffe subsidaire Hilfs-Transporteur	Griffino Chaining feed dog Griffe p. chaînette Klein-Transporteur	Piedino Presser foot Pied-presseur Drueckerfuss	Crochet superiore Upper looper Crochet supérieur Oberer Greifer	Crochet inferiore Lower looper Crochet inférieur Unterer Greifer
327-00-1CD-31/135-81	923852-0-00 3,8				921350-0-11 921426-3-10		
327-00-1CD-39/135-81	921336-4-01 2 923856-2-00 1,2 R 923858-2-00 1,4 R				921350-0-11 921438-3-10 923910-3-00 R		
327-00-1CD-39/137-81	921336-4-01 2 923856-2-00 1,2 R 923858-2-00 1,4 R				921350-0-11 921438-3-10 923910-3-00 R		
327-00-1MD-23/135-81	923888-0-00 6 923777-0-00 4 R 923890-0-00 5 R 923889-0-00 7,5 R 923891-0-00 7 R				921350-0-11 923783-3-00		
327-00-1MD-33/135-81	923847-0-00 7 923848-0-00 4,5 R 923849-0-00 3,1 R				921350-0-11 926781-3-00		
327-00-2CD-12/135-81	921451-0-10 3 923863-0-00 3 R 923864-0-00 2,5 R				921350-0-11 921453-3-10		
327-00-2CD-13/135-81	923867-0-00 3 923866-0-00 3,5 R 923865-0-00 4,5 R 923869-2-00 3,6 R 923871-2-00 3,1 R				921350-0-11 921455-3-10		
327-00-2CD-13/137-81	923867-0-00 3 923866-0-00 3,5 R 923865-0-00 4,5 R 923869-2-00 3,6 R 923871-2-00 3,1 R				921350-0-11 921455-3-10		
327-00-2CD-14/108-91	920832-0-00 7 920836-0-00 6 R 920878-0-00 7 R	920831-0-00 2			920835-3-00		

Indice  
Data  
Modifiche  
Vr.Si vende noto che il contenuto della presente tavola  
non può essere riprodotto o ristampato senza l'assen-  
simento scritto della proprietaria S.p.A. "Rimoldi & C. La  
testa intende tutelare i suoi diritti e norme di legge.

# Rumoldi

• ▲ ★ Vedere note parte introduttiva  
See introductory notes

Voir notes d'introduction  
Siehe Anmerkungen der Einleitung

Indice  
00  
Data  
Foglio 4 Segue F. 5

## R 300

Si rende noto che il contenuto della presente tavola è di proprietà Rumoldi S.p.A. e non può essere integralmente o parzialmente riprodotto, senza l'autorizzazione scritta della proprietaria S.p.A. Tutti i diritti sono riservati. Rumoldi S.p.A. - Via S. Andrea 10 - 37030 Montebelluna (TV) - Italia

modifiche

V. l. Data



Simbolo testa Machine symbol Symbole de la tête Symbol des Oberteile	Placca ago Needle plate Plaque à aiguille Stichplatte	Griffa principale Main feed dog Griffe principale Haupt-Transporteur	Griffa sussidiaria Auxiliary feed dog Griffe subsidiaire Hilfs-Transporteur	Griffino Chaining feed dog Griffe p. chaînette Klein-Transporteur	Piedino Presser foot Pied-presseur Drueckerfuss	Crochet superiore Upper looper Crochet supérieur Oberer Greifer	Crochet inferiore Lower looper Crochet inférieur Unterer Greifer
327-00-2CD-15/108-91	920855-0-00 6	920830-0-00 1,5 920831-0-00 2 R			920835-3-00		
327-00-2CD-16/108-91	920857-0-00 6	920856-0-00 1,5			920854-3-00		
327-00-2CD-17/108-91	920878-0-00 7 920832-0-00 7 R	920831-0-00 2 920830-0-00 1,5 R			920835-3-00		
327-00-2CD-18/108-91	920879-0-00 6 920807-0-00 6 R 920806-0-00 5,5 R 920808-0-00 6,5 R 920880-0-00 5,5 R 920881-0-00 6,5 R	920831-0-00 2 920830-0-00 1,5 R			920835-3-00		
327-00-2CD-32/108-91	920851-0-00 7 920852-0-00 6,5 R	920850-0-00 2			920854-3-00		
327-00-2CD-34/135-81	923864-0-00 2,5 923863-0-00 3 R			921350-0-11	921453-3-10		
327-00-2CD-34/137-81	923864-0-00 2,5 923863-0-00 3 R			921350-0-11	921453-3-10		
327-00-2CD-38/135-81	923903-0-00 3,5 923904-0-00 ● 3,5 R	203419-2-11 ●	203423-2-11 ●	921350-0-11	921453-3-10		
327-00-2CD-38/137-81	923903-0-00 3,5 923904-0-00 ● 3,5 R	203419-2-11 ●	203423-2-11 ●	921350-0-11	921453-3-10		
327-00-2CD-41/135-81	923817-0-00 6 923877-0-00 5 R 923878-0-00 5,2 R			923876-0-00	923880-3-00		
327-00-2MD-20/135-81	923886-0-00 7			923902-0-00	923887-3-00		
327-00-2MD-21/108-91	920832-0-00 7 920878-0-00 7 R	920831-0-00 2 920830-0-00 1,5 R			920835-3-00		

**Rimoldi**

• ▲ ★ Vedere note parte introduttiva  
See introductory notes

Voir notes d'introduction  
Siehe Anmerkungen der Einleitung

Indice

TAB

**R300**

00

Data

Foglio 5 Segue F. 6

Simbolo testa Machine symbol Symbole de la tête Symbol des Obertheile	Placca ago Needle plate Plaque à aiguille Stichplatte	Griffa principale Main feed dog Griffe principale Haupt-Transporteur	Griffa sussidiaria Auxiliary feed dog Griffe subsidiaire Hilfs-Transporteur	Griffino Chaining feed dog Griffe p. chaînette Klein-Transporteur	Piedino Presser foot Pied-presseur Drueckerfuss	Crochet superiore Upper looper Crochet supérieur Oberer Greifer	Crochet inferiore Lower looper Crochet inférieur Unterer Greifer
327-00-2MD-36/108-81	920807-0-00	6	920831-0-00	2	920835-3-00		
	920806-0-00	5,5 R	920830-0-00	1,5 R			
	920808-0-00	6,5 R					
	920879-0-00	6 R					
	920880-0-00	5,5 R					
	920881-0-00	6,5 R					
327-00-2MD-36/135-81	923881-0-00	6,5		923902-0-00	923885-3-00		
	923882-0-00	6,5 R					
	923883-0-00	7,5 R					
327-10-1CD-02/135-81	923843-0-00	3,2		921350-0-11	921403-3-10		
	923844-0-00	3 R					
	923845-0-00	5 R					
327-10-1CD-03/135-81	923846-0-00	2,5		921350-0-11	921404-3-10		
327-10-1CD-04/135-81	923846-0-00	2,5		921350-0-11	921404-3-10		
327-10-1CD-06/135-81	923843-0-00	3,2		921350-0-11	921403-3-10		
	923844-0-00	3 R					
	923845-0-00	5 R					
327-11-1CD-02/135-81	923843-0-00	3,2		921350-0-11	926900-3-00		
	923844-0-00	3 R					
	923845-0-00	5 R					
327-28-1CD-02/135-81	923832-0-00	5		921350-0-11	921396-3-10		
	923831-0-00	4,6 R					
	923774-0-00	4,1 R					
	923833-0-00	5,6 R					
	923834-0-00	6 R					
327-28-1CD-07/135-81	923862-2-00	1,3		921350-0-11	921440-3-10		
327-28-1CD-08/135-81	923838-0-00	1,2		921350-0-11	923839-3-00		
327-28-1CD-11/135-81	923853-0-00	1,5		921350-0-11	921437-3-10		

Indice  
Data  
Vr.

Si rende noto che il contenuto della presente tavola  
nonché divulgato a terzi o riprodotto sia integral-  
mente che parzialmente senza l'autorizzazione scrit-  
ta della Rimoldi S.p.A. costituisce una violazione della  
stessa. Intende tutelare i suoi diritti in forma di legge.

**Rimoldi**

• ▲ ★ Vedere note parte introduttiva  
See introductory notes

Voir notes d'introduction  
Siehe Anmerkungen der Einleitung

Indice  
00  
Data

TAB  
**R300**

Foglio 6 Segue F. 7

Si rende noto che il contenuto delle pagine contenute in questo catalogo non potrà essere utilizzato o riprodotto senza permesso scritto dalla proprietaria S.p.A. V. RIMOLDI & C. La stessa intende tutelare i suoi diritti a norma di legge.

Simbolo testa Machine symbol Symbole de la tête Symbol des Oberteiles	Placca ago Needle plate Plaque à aiguille Stichplatte	Griffa principale Main feed dog Griffe principale Haupt-Transporteur	Griffa sussidiaria Auxiliary feed dog Griffe subsidiaire Hilfs-Transporteur	Griffino Chaining feed dog Griffe p. chaînette Klein-Transporteur	Piedino Presser foot Pied-presseur Drueckerfuss	Crochet superiore Upper looper Crochet supérieur Oberer Greifer	Crochet inferiore Lower looper Crochet inférieur Unterer Greifer
327-28-1CU-04/135-81	923892-0-00 923776-0-00 923895-0-00	3,5 4 6,5	921392-0-10	1,5		921396-3-10	
327-28-1CU-06/135-81	923894-0-00 923895-0-00	5,5 6,5	923893-0-00	2		921395-3-11	

modifiche

Vl.	Data				
-----	------	--	--	--	--

--	--	--	--	--	--

--	--	--	--	--	--

# Rumoldi

• ▲ • Vedere note parte introduttiva  
See introductory notes

Voir notes d'introduction  
Siehe Anmerkungen der Einleitung

Indice  
00  
Data  
Foglio 7 Segue F. 8

## R300

Simbolo testa Machine symbol Symbole de la tête Symbol des Oberteiles	Placca ago Needle plate Plaque à aiguille Stichplatte	Griffa principale Main feed dog Griffe principale Haupt-Transporteur	Griffa sussidiaria Auxiliary feed dog Griffe subsidiaire Hilfs-Transporteur	Griffino Chaining feed dog Griffe p chaînette Klein-Transporteur	Piedino Presser foot Pied-presseur Drueckerfuss	Crochet superiore Upper looper Crochet supérieur Oberer Greifer	Crochet inferiore Lower looper Crochet inférieur Unterer Greifer
028-00-01/103-90	920768-0-10 3 920750-0-10 3,4 R 920769-0-10 3,7 R 920770-0-10 4,1 R					920751-3-10	
028-00-01/135-80	923774-0-00 4,1 923831-0-00 4,6 R 923832-0-00 5 R 923833-0-00 5,6 R 923834-0-00 6 R	202056-2-11 •	R	202060-2-11 •	R	921350-0-11	921352-3-10 923901-3-00 • R
028-00-02/103-90	203795-0-00 3,6	920802-0-10	1,5			203796-3-00	
028-00-02/135-80	923890-0-00 5 923777-0-00 4 R 923888-0-00 6 R			921350-0-11		921422-3-10	
028-00-03/103-90	920796-0-10 2,4 920797-0-10 3 R					920751-3-10	
028-00-03/135-80	923830-0-00 3,3 923850-0-00 1,2 R 923851-0-00 2,8 R			921350-0-11		921352-3-10	
028-00-04/103-90	920786-0-10 1,8 920788-0-10 2,6 R					920789-3-10	
028-00-04/135-80	923775-0-00 2 923835-0-00 2,5 R 923836-0-00 3,5 R 923837-0-00 1,5 R 923838-0-00 1,2 R			921350-0-11		921382-3-10	
028-00-05/103-90	920820-0-00 2,5					920810-3-10	
028-00-05/135-80	923840-0-00 3,5 923841-0-00 4 R 923842-0-00 3 R			921350-0-11		921383-3-10	

Indice  
Data  
V.r.

Si rende noto che il contenuto della presente tavola non potrà essere utilizzato o riprodotto senza integralmente autorizzazione scritta dalla Rumoldi & C. La stessa intende tutelare i suoi diritti a norma di legge.

**Rumoldi**

● ▲ ★

Vedere note parte introduttiva  
See introductory notesVoir notes d'introduction  
Siehe Anmerkungen der Einleitung

Indice

00

TAG

**R 300**

Data

Foglio 8

Segue F. 9

Simbolo testa Machine symbol Symbole de la tête Symbol des Oberteile	Placca ago Needle plate Plaque à aiguille Stichplatte	Griffa principale Main feed dog Griffe principale Haupt-Transporteur	Griffa sussidiaria Auxiliary feed dog Griffe subsidiaire Hilfs-Transporteur	Griffino Chaining feed dog Griffe p. chaînette Klein-Transporteur	Piedino Presser foot Pied-presseur Drueckerfuss	Crochet superiore Upper looper Crochet supérieur Oberer Greifer	Crochet inferiore Lower looper Crochet inférieur Unterer Greifer
028-00-06/135-80	921336-4-01 2 923858-2-00 1,4 R 923856-2-00 1,2 R			921350-0-11	921438-3-10 923910-3-00 R		
028-00-06/137-80	921336-4-01 2 923858-2-00 1,4 R 923856-2-00 1,2 R			921350-0-11	921438-3-10 923910-3-00 R		
028-00-07/135-80	923854-0-00 1			921350-0-11	921439-3-10		
028-00-07/137-80	923854-0-00 1			921350-0-11	921439-3-10		
028-00-08/135-80	923853-0-00 1,5			921350-0-11	921437-3-10		
028-00-09/135-80	921451-0-10 3 923863-0-00 3 R 923864-0-00 2,5 R			921350-0-11	921453-3-10		
028-00-09/137-80	921451-0-10 3 923863-0-00 3 R 923864-0-00 2,5 R			921350-0-11	921453-3-10		
028-00-10/135-80	923867-0-00 3 923866-0-00 3,5 R 923865-0-00 4,5 R 923869-2-00 3,5 R 923871-2-00 3 R			921350-0-11	921455-3-10		
028-00-10/137-80	923867-0-00 3 923866-0-00 3,5 R 923865-0-00 4,5 R 923869-2-00 3,5 R 923871-2-00 3 R			921350-0-11	921455-3-10		
028-00-11/108-90	920832-0-00 7 920836-0-00 6 R 920878-0-00 7 R	920831-0-00 2			920835-3-00		
028-00-12/108-90	920855-0-00 6	920830-0-00 1,5			920835-3-00		

Si senda nota che il contenuto della presente tavola non è un diritto di proprietà intellettuale e che il presente manuale divulgato a terzi o riprodotto, sia integralmente che parzialmente senza permesso scritto dalla Rumoldi S.p.A. è vietato. La Rumoldi S.p.A. si riserva espressamente il diritto di essere ritenuta responsabile in merito a questa nota.

modifiche

Vr.

Indice

Data

Vr.



**Rumoldi**

• ▲ ★ Vedere note parte introduttiva  
See introductory notes

Voir notes d'introduction  
Siehe Anmerkungen der Einleitung

Indice

00

TAB

**R300**

Data

Foglio 9 Segue F. 10

Simbolo testa Machine symbol Symbole de la tête Symbol des Oberteiles	Placca ago Needle plate Plaque à aiguille Stichplatte	Griffa principale Main feed dog Griffe principale Haupt-Transporteur	Griffa sussidiaria Auxiliary feed dog Griffe subsidiaire Hilfs-Transporteur	Griffino Chaining feed dog Griffe p. chaînette Klein-Transporteur	Piedino Presser foot Pied-presseur Drueckerfuss	Crochet superiore Upper looper Crochet supérieur Oberer Greifer	Crochet inferiore Lower looper Crochet inférieur Unterer Greifer
028-00-13/108-90	920857-0-00 6	920856-0-00 1,5			920854-3-00		
028-00-14/108-90	920878-0-00 7 920832-0-00 7 R	920831-0-00 2 920830-0-00 1,5 R	203540-0-10 1,5 R		920835-3-00		
028-00-15/108-90	920879-0-00 6 920807-0-00 6 R 920806-0-00 5,5 R 920808-0-00 6,5 R 920880-0-00 5,5 R 920881-0-00 6,5 R	920831-0-00 2 920830-0-00 1,5 R	203540-0-10 1,5 R		920835-3-00		
028-00-16/108-90	920879-0-00 6 920807-0-00 6 R 920806-0-00 5,5 R 920808-0-00 6,5 R 920880-0-00 5,5 R 920881-0-00 6,5 R	920831-0-00 2 920830-0-00 1,5 R	203540-0-10 1,5 R		920835-3-00		
028-00-16/135-80	923881-0-00 5,5 923882-0-00 6,5 R 923883-0-00 7,5 R			923902-0-00	923885-3-00		
028-00-17/135-80	923886-0-00 7			923902-0-00	923887-3-00		
028-00-18/135-80	923888-0-00 6 923777-0-00 4 R 923890-0-00 5 R 923889-0-00 7,5 R 923891-0-00 7 R			921350-0-11	923783-3-00		
028-00-25/103-90	920803-0-10 3,3 203056-0-00 2,3 R 920805-0-00 4,5 R	920802-0-10 1,5			920884-3-00		
028-00-25/135-80	923848-0-00 4,5 923847-0-00 7 R 923849-0-00 3,1 R			921350-0-11	926781-3-00		

Indice  
Data  
Vr.

Si rende noto che il contenuto della presente tavola non potrà essere utilizzato o rappresentato né con mezzi meccanici né con altri procedimenti senza il permesso scritto della proprietaria S.p.A. V. R. DI & C. La stessa intende tutelare i suoi diritti. Firma di legge

*Rumoldi*• ▲ ★ Vedere note parte introduttiva  
See introductory notesVoir notes d'introduction  
Siehe Anmerkungen der EinleitungIndice  
00  
Date  
TAB  
**R300**  
Foglio 10 Segue F. 11

Simbolo testa Machine symbol Symbole de la tête Symbol des Oberteile	Placca ago Needle plate Plaque à aiguille Stichplatte	Griffa principale Main feed dog Griffe principale Haupt-Transporteur	Griffa sussidiaria Auxiliary feed dog Griffe subsidiaire Hilfs-Transporteur	Griffino Chaining feed dog Griffe p. chaînette Klein-Transporteur	Piedino Presser foot Pied-presseur Drueckerfuss	Crochet superiore Upper looper Crochet supérieur Oberer Greifer	Crochet inferiore Lower looper Crochet inférieur Unterer Greifer
028-10-02/135-80	923843-0-00 923844-0-00 923845-0-00	3,2 3 5			921350-0-11	921403-3-10	
028-10-03/135-80	923843-0-00 923844-0-00 923845-0-00	3,2 3 5			921350-0-11	921403-3-10	
028-10-04/135-80	923843-0-00 923844-0-00 923845-0-00	3,2 3 5			921350-0-11	921403-3-10	
028-10-05/135-80	923843-0-00 923844-0-00 923845-0-00	3,2 3 5			921350-0-11	921403-3-10	
028-28-01/135-80	923832-0-00 923831-0-00 923774-0-00 923833-0-00 923834-0-00	5 4,6 4,1 5,6 6			921350-0-11	921396-3-10	
028-28-02/135-80	923832-0-00 923831-0-00 923774-0-00 923833-0-00 923834-0-00	5 4,6 4,1 5,6 6			921350-0-11	921396-3-10	
028-28-03/135-80	923776-0-00 923892-0-00	4 3,5	921392-0-10	1,5		921395-3-11	
028-28-04/135-80	923892-0-00 923776-0-00	3,5 4	921392-0-10	1,5		921396-3-10	
028-28-05/135-80	923894-0-00 923895-0-00	5,5 6,5	923896-0-00	2		921395-3-11	
028-28-06/135-80	923894-0-00 923895-0-00	5,5 6,5	923896-0-00	2		921395-3-11	
028-28-07/135-80	923862-2-00	1,3			921350-0-11	921440-3-10	

Si rende noto che il contenuto della presente tavola non potrà essere utilizzato o rappresentato né con nessuna divulgazione a terzi o riprodotto, sia integralmente che parzialmente, senza il permesso scritto della proprietaria S.p.A. V. R. Di S. C. La stessa intende tutelare i suoi diritti.

modifiche

Vr.  
Data

**Rimoldi**

• ▲ ★ Vedere note parte introduttiva  
See introductory notes

Voir notes d'introduction  
Siehe Anmerkungen der Einleitung

Indice		TAB	<b>R300</b>
00			
Data		Foglio 11	Segue F.12

Simbolo testa Machine symbol Symbole de la tête Symbol des Oberteiles	Placca ago Needle plate Plaque à aiguille Stichplatte	Griffa principale Main feed dog Griffe principale Haupt-Transporteur	Griffa sussidiaria Auxiliary feed dog Griffe subsidiaire Hilfs-Transporteur	Griffino Chaining feed dog Griffe p. chaînette Klein-Transporteur	Piedino Presser foot Pied-presseur Drueckerfuss	Crochet superiore Upper looper Crochet supérieur Oberer Greifer	Crochet inferiore Lower looper Crochet inférieur Unterer Greifer
228-00-01/103-90	920768-0-10 3 920750-0-10 3,4 R 920769-0-10 3,7 R 920770-0-10 4,1 R				920751-3-10		
228-00-01/135-80	923774-0-00 4,1 923831-0-00 4,6 R 923832-0-00 5 R 923833-0-00 5,6 R 923834-0-00 6 R	202056-2-11 • — R	202060-2-11 • — R	921350-0-11	921352-3-10 923901-3-00 • R		
228-00-02/103-90	920786-0-10 1,8 920788-0-10 2,6 R				920789-3-10		
228-00-02/135-80	923775-0-10 2 923835-0-00 2,5 R 923836-0-00 3,5 R 923837-0-00 1,5 R 923838-0-00 1,2 R			921350-0-11	921382-3-10		
228-00-03/103-90	920820-0-00 2,5				920810-3-10		
228-00-04/103-90	203795-0-00 3,6	920802-0-10 1,5			203796-3-00		
228-00-04/135-80	923890-0-00 5 923777-0-00 4 R 923888-0-00 6 R			921350-0-11	921422-3-10		
228-00-05/103-90	920796-0-10 2,4 920797-0-10 3 R				920751-3-10		
228-00-05/135-80	923830-0-00 3,3 923850-0-00 1,2 R 923851-0-00 2,8 R			921350-0-11	921352-3-10		
228-00-06/135-80	921336-4-01 2 923858-2-00 1,4 R 923856-2-00 1,2 R			921350-0-11	921438-3-10 923910-3-00 R		

Si rende noto che il contenuto della presente tavola non può deviare in alcun modo dalle norme di riferimento che parzialmente senza l'autorizzazione scritta della proprietaria S.p.A. V. RIN. I. & C. Le stesse norme troverete i loro scritti a pagina 01 legge.

Indice  
Data  
Vr.

**Rumoldi**

● ● ●

Vedere note parte introduttiva  
See introductory notesVoir notes d'introduction  
Siehe Anmerkungen der Einleitung

Indice

00

T. ed.

**R 300**

Data

Foglio 12

Segue F. 13

Simbolo testa Machine symbol Symbole de la tête Symbol des Oberteiles	Placca ago Needle plate Plaque à aiguille Stichplatte	Griffa principale Main feed dog Griffe principale Haupt-Transporteur	Griffa sussidiaria Auxiliary feed dog Griffe subsidiaire Hilfs-Transporteur	Griffino Chaining feed dog Griffe p. chaînette Klein-Transporteur	Piedino Presser foot Pied-presseur Drueckerfuss	Crochet superiore Upper looper Crochet supérieur Oberer Greifer	Crochet inferiore Lower looper Crochet inférieur Unterer Greifer
228-00-06/137-80	921336-4-01 2 923858-2-00 1,4 R 923856-2-00 1,2 R			921350-0-11	921438-3-10 923910-3-00 R		
228-00-07/135-80	923854-0-00 1			921350-0-11	921439-3-10		
228-00-07/137-80	923854-0-00 1			921350-0-11	921439-3-10		
228-00-08/135-80	923853-0-00 1,5			921350-0-11	921437-3-10		
228-00-09/135-80	921451-0-10 3 923863-0-00 3 R 923864-0-00 2,5 R			921350-0-11	921453-3-10		
228-00-09/137-80	921451-0-10 3 923863-0-00 3 R 923864-0-00 2,5 R			921350-0-11	921453-3-10		
228-00-10/135-80	923867-0-00 3 923866-0-00 3,5 R 923865-0-00 4,5 R 923869-2-00 3,5 R 923871-2-00 3 R			921350-0-11	921455-3-10		
228-00-10/137-80	923867-0-00 3 923866-0-00 3,5 R 923865-0-00 4,5 R 923869-2-00 3,5 R 923871-2-00 3 R			921350-0-11	921455-3-10		
228-00-13/103-90	920803-0-10 3,3 203056-0-00 2,3 R 920805-0-00 4,5 R	920802-0-10 1,5			920884-3-00		
228-00-13/135-80	923848-0-00 4,5 923847-0-00 7 R 923849-0-00 3,1 R			921350-0-11	926781 3-00		

Si rende noto che il contenuto della presente tavola non è vincolato e può essere modificato senza preavviso e senza che parzialmente senza l'approvazione scritta della Rumoldi S.p.A. Sono diretti e firmati in nome di legge

modifiche

V. Data

V. Data

V. Data

V. Data

V. Data

V. Data

V. Data

V. Data

V. Data

V. Data

V. Data

V. Data

V. Data

V. Data

V. Data

V. Data

V. Data

V. Data

V. Data

V. Data

V. Data

V. Data

V. Data

V. Data

V. Data

V. Data

V. Data

V. Data

V. Data

V. Data

V. Data

V. Data

V. Data

V. Data

V. Data

V. Data

V. Data

V. Data

V. Data

V. Data

V. Data

V. Data

V. Data

**Rimoldi**

● ● ●

Vedere note parte introduttiva  
See introductory notesVoir notes d'introduction  
Siehe Anmerkungen der EinleitungIndice  
00  
Data  
TAB  
**R300**  
Foglio 13 Segue F. 14

Simbolo testa Machine symbol Symbole de la tête Symbol des Oberteiles	Placca ago Needle plate Plaque à aiguille Stichplatte	Griffa principale Main feed dog Griffe principale Haupt-Transporteur	Griffa sussidiaria Auxiliary feed dog Griffe subsidiaire Hilfs-Transporteur	Griffino Chaining feed dog Griffe p. chaînette Klein-Transporteur	Piedino Presser foot Pied-presseur Drueckerfuss	Crochet superiore Upper looper Crochet superieur Oberer Greifer	Crochet inferiore Lower looper Crochet inférieur Unterer Greifer
228-00-14/103-90	920786-0-10 1,8 920788-0-10 2,6 R				920789-3-10		
228-00-14/135-80	923775-0-00 2 923835-0-00 2,5 R 923836-0-00 3,5 R 923837-0-00 1,5 R 923838-0-00 1,2 R			921350-0-11	921381-3-10		
228-00-15/103-90	920812-0-10 2,8				920795-3-10		
228-00-15/135-80	923852-0-00 3,8			921350-0-11	921426-3-10		
228-00-17/135-80	921336-4-01 2 923858-2-00 1,4 R 923856-2-00 1,2 R			921350-0-11	921438-3-10 923910-3-00	R	
228-00-17/137-80	921336-4-01 2 923858-2-00 1,4 R 923856-2-00 1,2 R			921350-0-11	921438-3-10 923910-3-00	R	
228-00-18/135-80	921538-2-10 1,4				921530-3-11		
228-00-18/137-80	921538-2-10 1,4				921530-3-11		
228-10-01/135-80	923843-0-00 3,2 923844-0-00 3 R 923845-0-00 5 R			921350-0-11	921403-3-10		
228-10-02/135-80	923846-0-00 2,5			921350-0-11	921404-3-10		
228-10-03/135-80	923846-0-00 2,5			921350-0-11	921404-3-10		
228-10-05/135-80	923843-0-00 3,2 923844-0-00 3 R 923845-0-00 5 R			921350-0-11	921403-3-10		
228-10-06/135-80	923843-0-00 3,2 923844-0-00 3 R 923845-0-00 5 R			921350-0-11	921403-3-10		

Indice  
Data  
Vr.

Si rende noto che il contenuto della presente tavola non potrà essere utilizzato o riprodotto in tutto o in parte, né in alcun modo, senza il permesso scritto dalla proprietaria S.p.A. V. RIMOLDI &amp; C. La stessa intende tutelare i suoi diritti a norma di legge.

Si rende noto che il contenuto della presente tavola non è da considerarsi un'opera di diritto di proprietà intellettuale ma di pubblico dominio, divulgato a terzi o riprodotto in qualsiasi forma, senza autorizzazione scritta dalla Rimoldi, non costituisce un'infrazione ai diritti di legge.

Simbolo testa Machine symbol Symbole de la tête Symbol des Oberteile	Placca ago Needle plate Plaque à aiguille Stichplatte	Griffa principale Main feed dog Griffe principale Haupt-Transporteur	Griffa sussidiaria Auxiliary feed dog Griffe subsidiaire Hilfs-Transporteur	Griffino Chaining feed dog Griffe p. chaînette Klein-Transporteur	Piedino Presser foot Pied-presseur Drueckerfuss	Crochet superiore Upper looper Crochet supérieur Oberer Greifer	Crochet inferiore Lower looper Crochet inférieur Unterer Greifer
228-10-07/135-80	923843-0-00 3,2 923844-0-00 3 R 923845-0-00 5 R			921350-0-11	921403-3-10		
228-28-01/135-80	923832-0-00 5 923831-0-00 4,6 R 923774-0-00 4,1 R 923833-0-00 5,6 R 923834-0-00 6 R			921350-0-11	921396-3-10		
228-28-02/135-80	923832-0-00 5 923831-0-00 4,6 R 923774-0-00 4,1 R 923833-0-00 7,5 R 923834-0-00 6 R			921350-0-11	921396-3-10		
228-28-03/135-80	923776-0-00 4 923892-0-00 3,5 R	921392-0-10 1,5			921395-3-11		
228-28-04/135-80	923892-0-00 3,5 923776-0-00 4 R	921392-0-10 1,5			921396-3-10		
228-28-05/135-80	923894-0-00 5,5 923895-0-00 6,5 R	923896-0-00 2			921395-3-11		
228-28-06/135-80	923894-0-00 5,5 923895-0-00 6,5 R	923896-0-00 2			921395-3-11		
228-28-07/135-80	923862-2-00 1,3			921350-0-11	921440-3-10		
228-28-10/135-80	923838-0-00 1,2			921350-0-11	923839-3-00		

modifiche

Indice  
Data

V.:



**Rimoldi**

• ▲ \*

Vedere note parte introduttiva  
See introductory notesVoir notes d'introduction  
Siehe Anmerkungen der Einleitung

Indice

00

TAS

**R 300**

Data

Foglio 15

Segue F.

Simbolo testa Machine symbol Symbole de la tête Symbol des Oberteile	Placca ago Needle plate Plaque à aiguille Stichplatte	Griffa principale Main feed dog Griffe princpale Haupt-Transporteur	Griffa sussidiaria Auxiliary feed dog Griffe subsidiaire Hilfs-Transporteur	Griffino Chaining feed dog Griffe p. chaînette Klein-Transporteur	Piedino Pressér foot Pied-presseur Drueckerfuss	Crochet superiore Upper looper Crochet supérieur Oberer Greifer	Crochet inferiore Lower looper Crochet inférieur Unterer Greifer
329-00-2CD-01/136-81	921491-0-11 923897-0-00	3,5 5,5					
329-00-2CD-02/136-81	921492-0-11	3,7					
329-00-2CD-03/136-81	921493-0-10	3					
329-00-2CD-04/136-81	921494-0-10	3					
329-00-2CD-05/136-81	921495-0-10 921506-0-00	5 4					
329-00-2CD-06/136-81	923898-0-00	5,5					
329-00-2CD-07/136-81	923899-0-00	5					
329-00-2CD-08/136-81	923909-0-00	3,5					
329-00-2CD-10/136-81	923898-0-00	5,5					
329-00-3MU-01/136-81	923908-0-10	5					
329-22-2CD-04/136-81	923899-0-00	5					
330-00-1CD-01/136-81	921512-0-10						

Indice  
Data  
Vr.

Si rende noto che il contenuto della presente tavola non potrà essere utilizzato o riprodotto senza il permesso scritto dalla proprietaria S.p.A. Rimoldi D.I.C. La stessa intende tutelare i suoi diritti a norma di legge.

PLACCA AGO  
NEEDLE PLATE  
PLAQUE AIGUILLE  
STICHPLATTE



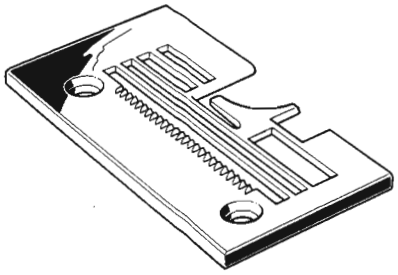
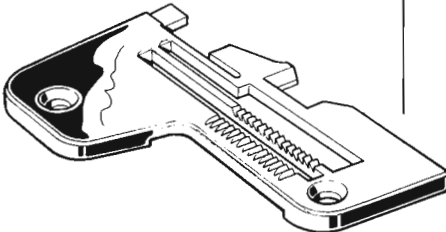
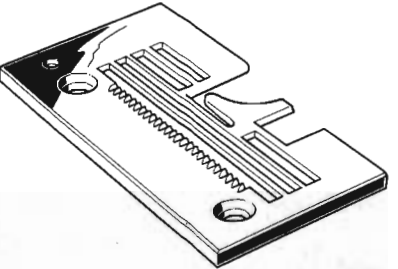
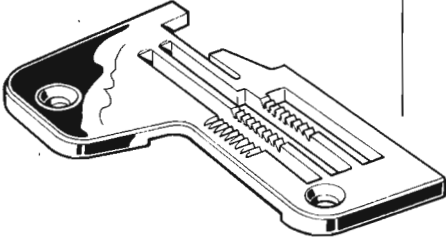

Si rende noto che il contenuto della presente tavola non potrà essere utilizzato o riprodotto in alcun modo, neppure divulgato a terzi, o riprodotto integralmente o parzialmente in qualsiasi modo, senza il consenso scritto della proprietaria S.P.A. V. F. 200790-010. La stessa intende tutelare i suoi diritti, a norma di legge.

<i>Rumoldi</i>		PLACCA AGO	NEEDLE PLATE	PLAQUE AIGUILLE	STICHPLATTE	Indice TAB R300
			Serve per Serves for Pour machines Dient fuer			Data Foglio 1   Segue F. 2
<b>200765-0-10</b>  Largh. costa Width of bight Largeur du surjet Ueberwendlichbreite } 1,5 mm  		<b>023-04-01</b> <b>023-04-03</b> <b>023-04-04</b>	<b>202148-0-10</b>  Largh. costa Width of bight Largeur du surjet Ueberwendlichbreite } 4,6 mm  		Serve per Serves for Pour machines Dient fuer  <b>327-00-1CD-01</b> <b>327-01-1CD-01</b> <b>327-01-1CD-02</b> <b>327-28-1CD-02</b> <b>327-29-1CD-01</b> <b>327-29-1CD-02</b> <b>327-34-1CD-01</b> <b>028-00-01</b> <b>028-01-01</b> <b>028-01-02</b> <b>028-28-01</b> <b>028-28-02</b> <b>028-29-01</b> <b>028-29-02</b> <b>228-00-01</b> <b>228-01-01</b> <b>228-28-01</b> <b>228-28-02</b>	
<b>200790-0-10</b>  Largh. costa Width of bight Largeur du surjet Ueberwendlichbreite } 1,5 mm  		<b>023-04-02</b> <b>023-04-05</b>	<b>202149-0-10</b>  Largh. costa Width of bight Largeur du surjet Ueberwendlichbreite } 5 mm  		Serve per Serves for Pour machines Dient fuer  <b>327-16-1CD-01</b> <b>028-16-01</b>	

**Rumoldi****PLACCA AGO****NEEDLE PLATE****PLAQUE AIGUILLE****STICHPLATTE**

Indice

TAB

**R300**

Data

Foglio 2 | Segue F. 3

**202150-0-10**

Largh. costa  
Width of bight  
Largeur du surjet } 3,5 mm  
Ueberwendlichbreite

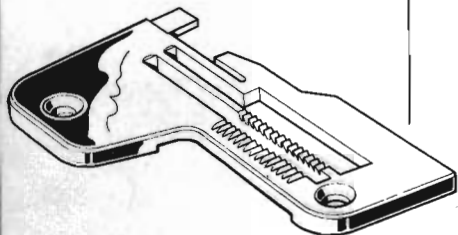

Serve per  
Serves for  
Pour machines  
Dient fuer

327-29-1CD-03  
028-29-03

**202506-4-10**

Largh. costa  
Width of bight  
Largeur du surjet } 4,1 mm  
Ueberwendlichbreite

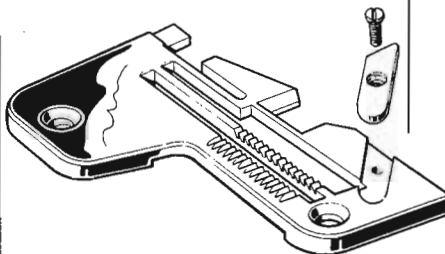

Serve per  
Serves for  
Pour machines  
Dient fuer

327-00-1CD-01

**202504-0-10**

Largh. costa  
Width of bight  
Largeur du surjet } 4,1 mm  
Ueberwendlichbreite

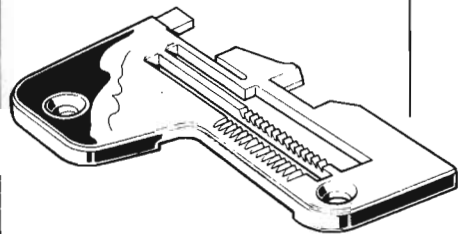

Serve per  
Serves for  
Pour machines  
Dient fuer

327-00-1CD-01  
327-01-1CD-01  
327-01-1CD-02  
327-28-1CD-02  
327-29-1CD-01  
327-29-1CD-02  
327-34-1CD-01  
028-00-01  
028-01-01  
028-01-02  
028-28-01  
028-28-02  
028-29-01  
028-29-02  
228-00-01  
228-01-01  
228-28-01  
228-28-02

**202507-0-10**

Largh. costa  
Width of bight  
Largeur du surjet } 5 mm  
Ueberwendlichbreite

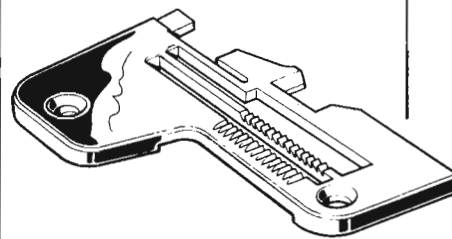

Serve per  
Serves for  
Pour machines  
Dient fuer

327-00-1CD-01  
327-01-1CD-01  
327-01-1CD-02  
327-28-1CD-02  
327-29-1CD-01  
327-29-1CD-02  
327-34-1CD-01  
028-00-01  
028-01-01  
028-01-02  
028-28-01  
028-28-02  
028-29-01  
028-29-02  
228-00-01  
228-01-01  
228-28-01  
228-28-02

Si vende solo per il contenuto della presente tavola non potrà utilizzarsi per macchine di altro tipo sia integrali che parzialmente serrate. Il presente catalogo non è vincolante per le macchine di altro tipo che non siano espressamente indicate. Le macchine di altro tipo non sono coperte da questa tavola e i loro diritti a norma di legge sono riservati.

Modificato da

Data	V.

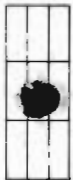

**Rumoldi**

PLACCA AGO

NEEDLE PLATE

PLAQUE AIGUILLE

STICHPLATTE

Indice	TAB	<b>R300</b>
Data	Foglio 3	Segue F. 4

**202508-0-10**

Largh. costa  
Width of bight  
Largeur du surjet  
Ueberwendlichbreite } 5,6 mm

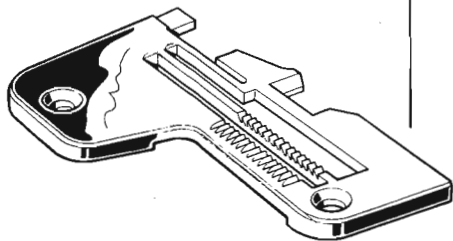

Serve per  
Serves for  
Pour machines  
Dient fuer

327-00-1CD-01  
327-01-1CD-01  
327-01-1CD-02  
327-28-1CD-02  
327-29-1CD-01  
327-29-1CD-02  
327-34-1CD-01  
028-00-01  
028-01-01  
028-01-02  
028-28-01  
028-28-02  
028-29-01  
028-29-02  
228-00-01  
228-01-01  
228-28-01  
228-28-02

**202634-0-10**

Largh. costa  
Width of bight  
Largeur du surjet  
Ueberwendlichbreite } 2,5 mm

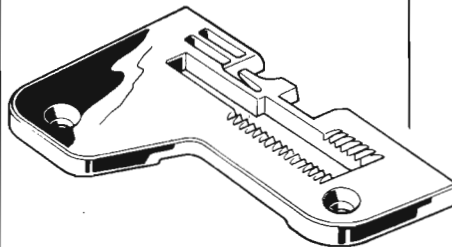

Serve per  
Serves for  
Pour machines  
Dient fuer

327-00-1CD-02  
327-00-1CD-05  
028-00-04  
028-00-26  
028-30-01  
028-30-02  
228-00-02  
228-00-14

**202590-0-10**

Largh. costa  
Width of bight  
Largeur du surjet  
Ueberwendlichbreite } 6 mm

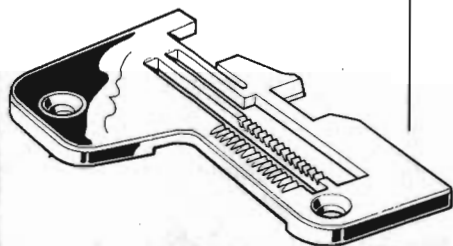

Serve per  
Serves for  
Pour machines  
Dient fuer

327-00-1CD-01  
327-01-1CD-01  
327-01-1CD-02  
327-28-1CD-02  
327-29-1CD-01  
327-29-1CD-02  
327-34-1CD-01  
028-00-01  
028-01-01  
028-01-02  
028-28-01  
028-28-02  
028-29-01  
028-29-02  
228-00-01  
228-01-01  
228-28-01  
228-28-02

**202635-0-10**

Largh. costa  
Width of bight  
Largeur du surjet  
Ueberwendlichbreite } 3,5 mm

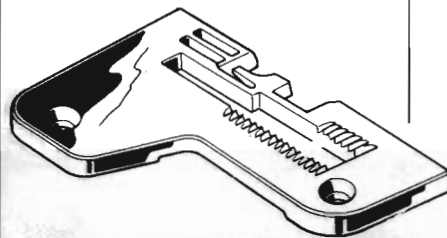

Serve per  
Serves for  
Pour machines  
Dient fuer

327-00-1CD-02  
327-00-1CD-05  
028-00-04  
028-00-26  
028-30-01  
028-30-02  
228-00-02  
228-00-14

Indice  
Data  
Vr

Si rende noto che il contenuto della presente tavola non potrà essere utilizzato o rappresentato, né copiato, né ristampato, né tradotto, né distribuito, né in qualsiasi modo, senza il permesso scritto e autorizzato dalla proprietaria S.p.A. V. Rumoldi & C. La stessa intende tutelare i suoi diritti in forma di legge.

**202636-0-10**

Largh. costa  
Width of bight  
Largeur du surjet  
Ueberwendlichbreite } 1,2 mm

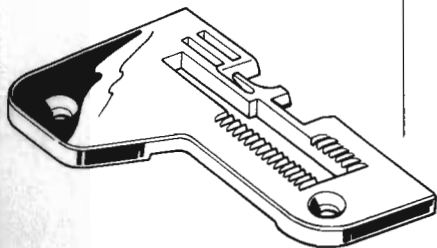

Serve per  
Serves for  
Pour machines  
Dient fuer

- 327-00-1CD-02
- 327-00-1CD-05
- 327-28-1CD-09
- 028-00-04
- 028-30-01
- 028-30-02
- 228-00-02
- 228-00-14
- 228-28-10

**202638-0-10**

Largh. costa  
Width of bight  
Largeur du surjet  
Ueberwendlichbreite } 4 mm

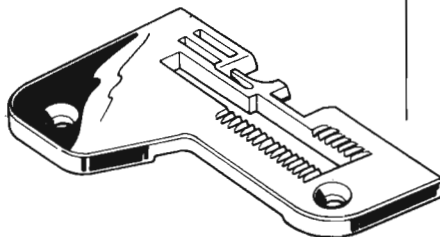

Serve per  
Serves for  
Pour machines  
Dient fuer

- 327-00-1CD-03
- 028-00-05
- 228-00-03

**202637-0-10**

Largh. costa  
Width of bight  
Largeur du surjet  
Ueberwendlichbreite } 3,5 mm

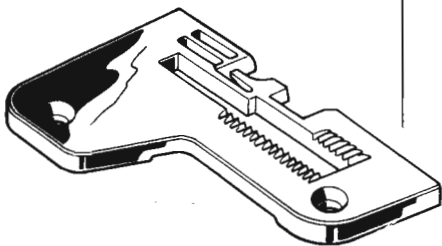

Serve per  
Serves for  
Pour machines  
Dient fuer

- 327-00-1CD-03
- 028-00-05
- 228-00-03

**202639-0-10**

Largh. costa  
Width of bight  
Largeur du surjet  
Ueberwendlichbreite } 3 mm

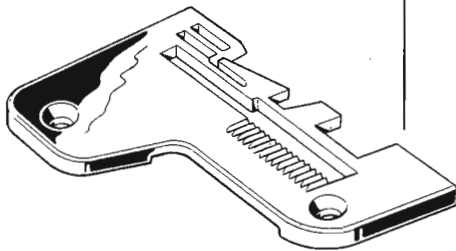

Serve per  
Serves for  
Pour machines  
Dient fuer

- 327-12-1CD-01

Si rende noto che il contenuto della presente tavola non potrà essere utilizzato o riprodotto senza permesso scritto dalla proprietaria S.p.A. V. R. 0156. Chi la stessa intende tutelare i suoi diritti a norma di legge.

Indice	Data	Vr



**Rumoldi**

PLACCA AGO

NEEDLE PLATE

PLAQUE AIGUILLE

STICHPLATTE

Indice	TAB	<b>R300</b>
Data	Foglio 5	Segue F. 6

**202707-0-10**

Largh. costa  
Width of bight  
Largeur du surjet  
Ueberwendlichbreite } 2 mm

Serve per  
Serves for  
Pour machines  
Dient fuer

327-00-1CD-02  
327-00-1CD-05  
028-00-04  
028-00-26  
028-30-01  
028-30-02  
228-00-02  
228-00-14

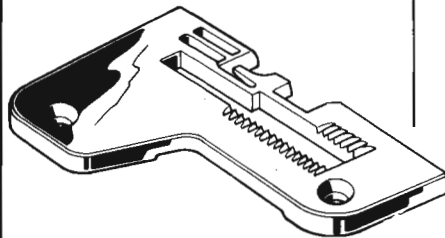
**202709-0-10**

Largh. costa  
Width of bight  
Largeur du surjet  
Ueberwendlichbreite } 1,5 mm

Serve per  
Serves for  
Pour machines  
Dient fuer

327-00-1CD-02  
327-00-1CD-05  
028-00-04  
028-30-01  
028-30-02  
228-00-02  
228-00-14

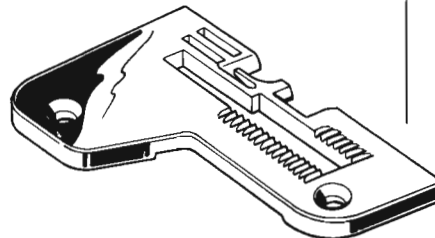
**202708-0-10**

Largh. costa  
Width of bight  
Largeur du surjet  
Ueberwendlichbreite } 3 mm

Serve per  
Serves for  
Pour machines  
Dient fuer

327-00-1CD-03  
028-00-05  
228-00-03

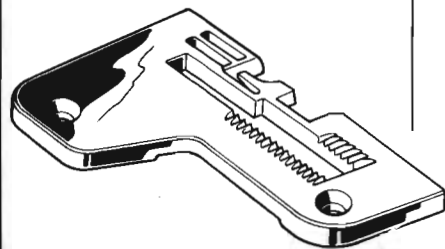
**202716-0-10**

Largh. costa  
Width of bight  
Largeur du surjet  
Ueberwendlichbreite } 3 mm

Serve per  
Serves for  
Pour machines  
Dient fuer

327-00-1CD-02  
327-00-1CD-05  
028-00-04  
028-30-01  
028-30-02  
228-00-02  
228-00-14

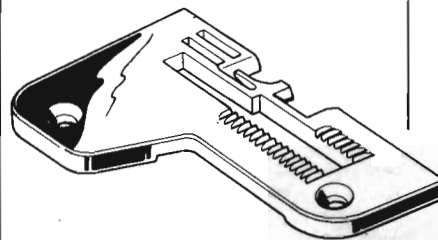

Si rende noto che il contenuto della presente tavola non potrà essere utilizzato o rappresentato, né come intero né parzialmente senza l'autorizzazione scritta della proprietaria S.p.A. V. L. D. I. & C. La stessa intende tutelare i suoi diritti, come di legge.

Indice  
Data  
V.  
modific.

**202738-4-00**

Largh. costa  
Width of bight } 3,5 mm  
Largeur du surjet  
Ueberwendlichbreite }

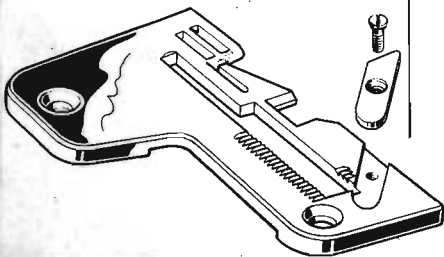

Serve per  
Serves for  
Pour machines  
Dient fuer

327-00-1CD-02  
228-00-14

**202763-0-10**

Largh. costa  
Width of bight } 3,5 mm  
Largeur du surjet  
Ueberwendlichbreite }

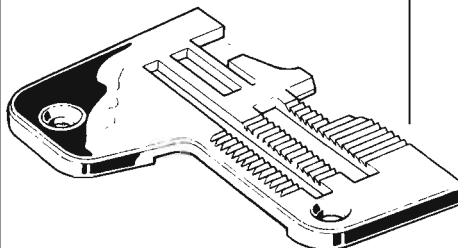

Serve per  
Serves for  
Pour machines  
Dient fuer

327-28-1CU-04  
028-28-03  
028-28-04  
228-28-03  
228-28-04

**202751-0-10**

Largh. costa  
Width of bight } 2,5 mm  
Largeur du surjet  
Ueberwendlichbreite }

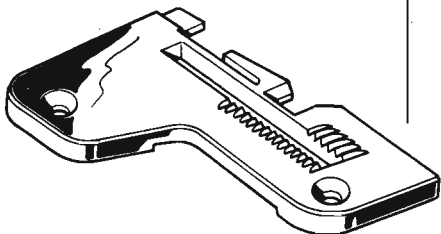

Serve per  
Serves for  
Pour machines  
Dient fuer

028-10-01

**202764-0-10**

Largh. costa  
Width of bight } 4 mm  
Largeur du surjet  
Ueberwendlichbreite }

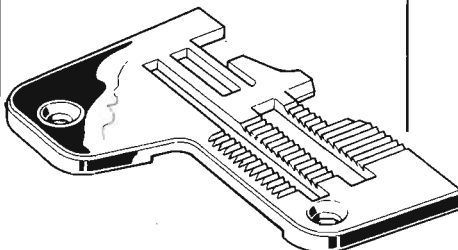

Serve per  
Serves for  
Pour machines  
Dient fuer

327-28-1CU-04  
028-28-03  
028-28-04  
228-28-03  
228-28-04

Si rende noto che il contenuto della presente tavola non potrà essere utilizzato o rappresentato in qualunque divulgato a terzi o riprodotto sia integralmente che parzialmente. Sono vietate espressamente le ristampe e le riproduzioni senza permesso scritto dalla Rimoldi S.p.A. e senza permesso scritto dalla Rimoldi S.p.A. per i suoi diritti.

Modifiche

Indice	Data	V.



**Remoldi**
**PLACCA AGO**
**NEEDLE PLATE**
**PLAQUE AIGUILLE**
**STICHPLATTE**
**202783-0-10**

Largh. costa  
Width of bight  
Largeur du surjet  
Ueberwendlichbreite } 3,2 mm

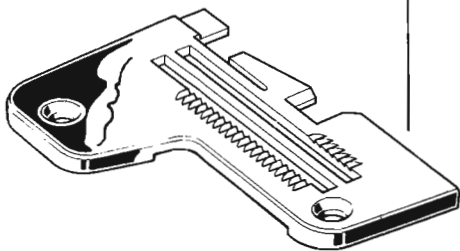

Serve per  
Serves for  
Pour machines  
Dient fuer

327-10-1CD-02  
327-10-1CD-06  
327-11-1CD-01  
327-11-1CD-02  
028-10-02  
028-10-03  
028-10-04  
028-10-05  
028-11-01  
228-10-01  
228-10-05  
228-10-06  
228-10-07

**202876-0-10**

Largh. costa  
Width of bight  
Largeur du surjet  
Ueberwendlichbreite } 3 mm

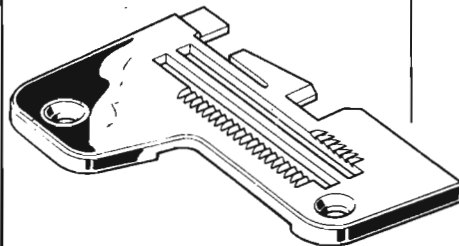

Serve per  
Serves for  
Pour machines  
Dient fuer

327-10-1CD-02  
327-10-1CD-06  
327-11-1CD-01  
327-11-1CD-02  
028-10-02  
028-10-03  
028-10-04  
028-10-05  
028-11-01  
228-10-01  
228-10-05  
228-10-06  
228-10-07

**202784-0-10**

Largh. costa  
Width of bight  
Largeur du surjet  
Ueberwendlichbreite } 2,5 mm

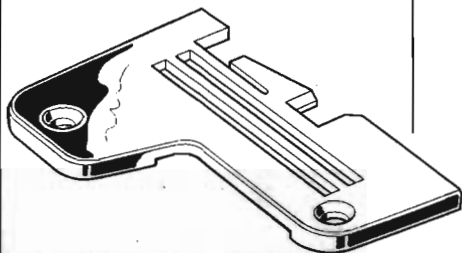

Serve per  
Serves for  
Pour machines  
Dient fuer

327-10-1CD-03  
327-10-1CD-04  
228-10-02  
228-10-03

**202877-0-10**

Largh. costa  
Width of bight  
Largeur du surjet  
Ueberwendlichbreite } 5 mm

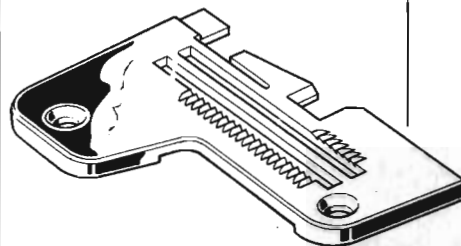

Serve per  
Serves for  
Pour machines  
Dient fuer

327-10-1CD-02  
327-10-1CD-06  
327-11-1CD-01  
327-11-1CD-02  
028-10-02  
028-10-03  
028-10-04  
028-10-05  
028-11-01  
228-10-01  
228-10-05  
228-10-06  
228-10-07

Si rende noto che il contenuto della presente tavola  
 non è ristretto al solo uso di riferimento e può essere  
 liberamente divulgato o riprodotto, o in tutto o in parte,  
 senza autorizzazione, da chiunque, a fini commerciali,  
 industriali, letterarie, artistiche, scientifiche o di altro  
 genere, senza che il titolare della presente tavola sia  
 tenuto a risarcire il danno. La presente tavola è di  
 proprietà della Remoldi S.p.A. e non può essere ristampata  
 o riprodotta senza permesso scritto dalla Remoldi S.p.A.  
 La presente tavola, a meno di esplicita indicazione di legge,  
 è riservata ai soli abbonati della Remoldi S.p.A.

Indice	
Data	
V.	





**Rimoldi**

PLACCA AGO

NEEDLE PLATE

PLAQUE AIGUILLE

STICHPLATTE

Indice	TAB	<b>R300</b>
00		
Data 1-73	Foglio 9	Segue F.10

**203037-0-10**

Largh. costa  
Width of bight  
Largeur du surjet  
Ueberwendlichbreite } 3,1 mm

Serve per  
Serves for  
Pour machines  
Dient fuer

327-00-1CD-30  
327-00-1MD-33  
327-01-1MD-09  
028-00-25  
228-00-13

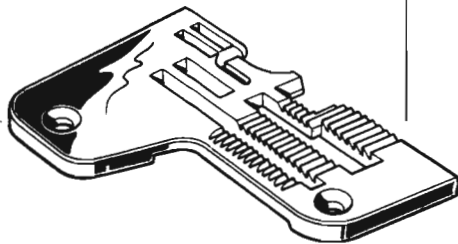
**203048-0-20**

Largh. costa  
Width of bight  
Largeur du surjet  
Ueberwendlichbreite } 3,5 mm

Serve per  
Serves for  
Pour machines  
Dient fuer

327-00-1CD-25  
028-00-20  
028-30-03  
028-30-04  
228-00-11

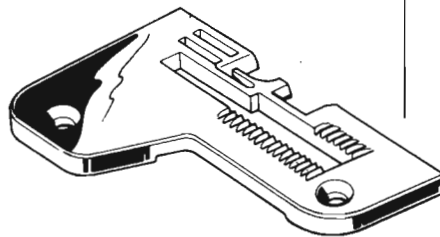
**203047-0-20**

Largh. costa  
Width of bight  
Largeur du surjet  
Ueberwendlichbreite } 3 mm

Serve per  
Serves for  
Pour machines  
Dient fuer

327-00-1CD-25  
028-00-20  
028-30-03  
028-30-04  
228-00-11

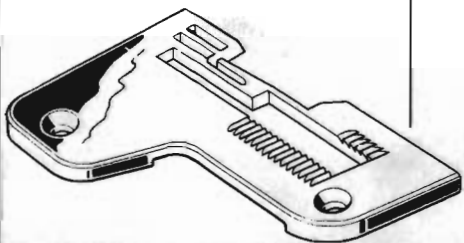
**203056-0-00**

Largh. costa  
Width of bight  
Largeur du surjet  
Ueberwendlichbreite } 2,3 mm

Serve per  
Serves for  
Pour machines  
Dient fuer

327-00-1CD-30/103-90  
028-00-25/103-90  
228-00-13/103-90

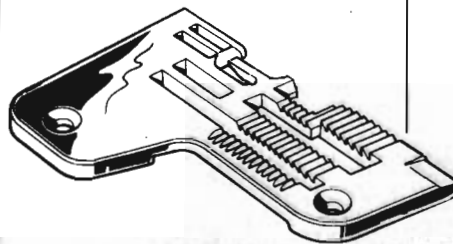

Indice  
Data  
V.  
Modelli

Si rende noto che il contenuto della presente tavola non potrà essere utilizzato o appoggiato né con, né senza permesso scritto dalla Rimoldi S.p.A. La stessa intende tutelare i suoi diritti in forma di legge.



**Rotolodi**

PLACCA AGO

NEEDLE PLATE

PLAQUE AIGUILLE

STICHPLATTE

Indice		10	R300
00			
Data	1-73	Foglio	11
			Segue F.12

**203150-0-10**

Largh. costa  
Width of bight  
Largeur du surjet  
Ueberwendlichbreite } 3,5 mm

Serve per  
Serves for  
Pour machines  
Dient fuer

327-22-1CD-03  
327-22-1CD-05

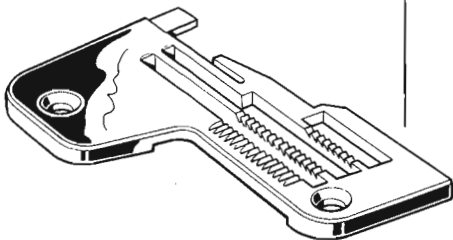
**203214-0-10**

Largh. costa  
Width of bight  
Largeur du surjet  
Ueberwendlichbreite } 3,3 mm

Serve per  
Serves for  
Pour machines  
Dient fuer

327-00-1CD-07  
327-01-1CD-04  
327-29-1CD-05  
327-29-1CD-06  
028-00-03  
028-10-04  
028-29-05  
028-29-06  
228-00-05  
228-01-03

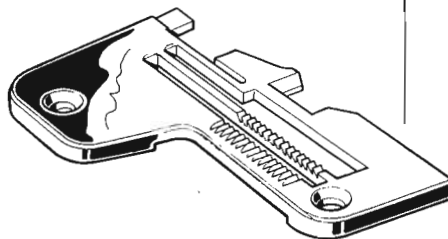
**203151-0-10**

Largh. costa  
Width of bight  
Largeur du surjet  
Ueberwendlichbreite } 3,8 mm

Serve per  
Serves for  
Pour machines  
Dient fuer

327-00-1CD-32

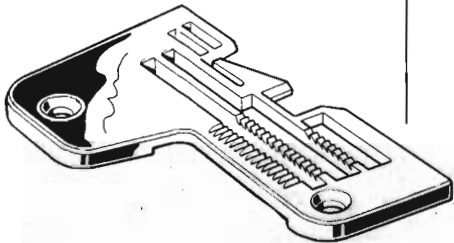
**203216-4-10**

Largh. costa  
Width of bight  
Largeur du surjet  
Ueberwendlichbreite } 3,3 mm

Serve per  
Serves for  
Pour machines  
Dient fuer

327-00-1CD-07

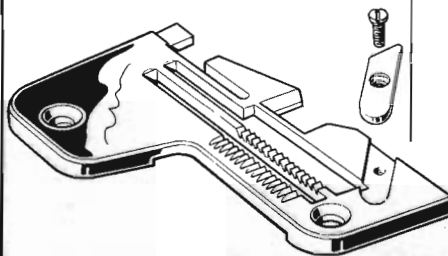

Si rende noto che il contenuto della presente tavola non potrà essere utilizzato o riprodotto in alcun modo, neppure divulgato a terzi o riprodotto in forma integrale o parziale, senza il permesso scritto della proprietaria S.p.A. V. F.lli D'Ignazio & C. La stessa intende tutelare i suoi diritti in forma di legge.

INDEX  
Date  
V.

Si rende noto che il contenuto della presente tavola non è esente da responsabilità, né per quanto concerne i diritti di riproduzione, né per quanto concerne il materiale di cui è composto, né per quanto concerne l'informazione stessa intesa tutelare i suoi diritti, norma di legge.

**203217-0-10**

Largh. costa  
 Width of bight  
 Largeur du surjet  
 Ueberwendlichbreite } 4 mm

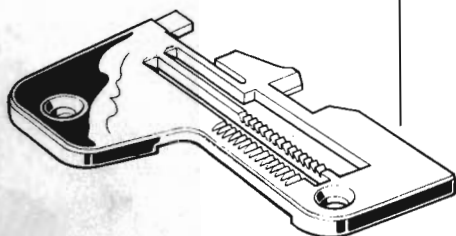

Serve per  
 Serves for  
 Pour machines  
 Dient fuer

- 327-00-1CD-07
- 327-01-1CD-04
- 327-29-1CD-05
- 327-29-1CD-06
- 028-00-03
- 028-01-04
- 028-29-05
- 028-29-06
- 228-00-05
- 228-01-03

**203219-0-10**

Largh. costa  
 Width of bight  
 Largeur du surjet  
 Ueberwendlichbreite } 3,8 mm

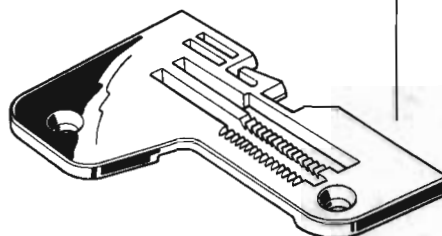

Serve per  
 Serves for  
 Pour machines  
 Dient fuer

- 327-00-1CD-31
- 327-01-1CD-05
- 327-30-1CD-07
- 228-00-15
- 228-01-04

**203218-0-10**

Largh. costa  
 Width of bight  
 Largeur du surjet  
 Ueberwendlichbreite } 5 mm

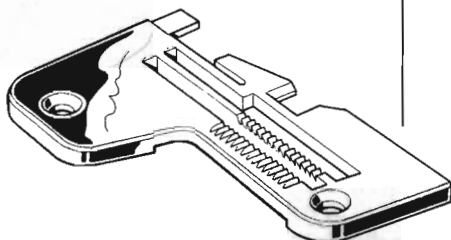

Serve per  
 Serves for  
 Pour machines  
 Dient fuer

- 327-00-1CD-07
- 327-01-1CD-04
- 327-29-1CD-05
- 327-29-1CD-06
- 028-00-03
- 029-01-04
- 028-29-05
- 028-29-06
- 228-00-05
- 228-01-03

**203220-0-10**

Largh. costa  
 Width of bight  
 Largeur du surjet  
 Ueberwendlichbreite } 2,8 mm

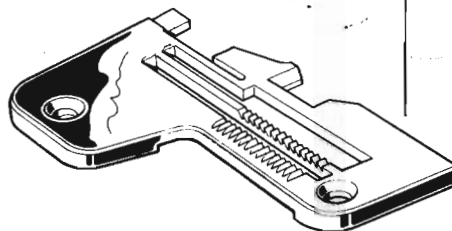

Serve per  
 Serves for  
 Pour machines  
 Dient fuer

- 327-00-1CD-07
- 327-01-1CD-04
- 327-29-1CD-05
- 327-29-1CD-06
- 028-00-03
- 028-01-04
- 028-29-05
- 028-29-06
- 228-00-05
- 228-01-03

Modifiche		Indice
No.	Data	V.





Indice
Data
V.

Si rende noto che il contenuto della presente tavola non potrà essere utilizzato o riprodotto, né copiato, senza permesso scritto dalla proprietaria S.p.A. V. S. SLDI & C. La stessa intende tutelare i suoi diritti e norme di legge.

**Rimoldi**

PLACCA AGO

NEEDLE PLATE

PLAQUE AIGUILLE

STICHPLATTE

Indice	TAB	<b>R300</b>
00		
Data	1-73	Foglio 13   Segue F.14

**203268-0-00**

Largh. costa  
Width of bight  
Largeur du surjet  
Ueberwendlichbreite } 4,5 mm

Serve per  
Serves for  
Pour machines  
Dient fuer

327-00-1CD-32

**203347-2-10**

Largh. costa  
Width of bight  
Largeur du surjet  
Ueberwendlichbreite } 1,2 mm

Serve per  
Serves for  
Pour machines  
Dient fuer

327-00-1CD-09  
327-00-1CD-39  
028-00-06  
228-00-06  
228-00-17

**203280-0-10**

Largh. costa  
Width of bight  
Largeur du surjet  
Ueberwendlichbreite } 2,5 mm

Serve per  
Serves for  
Pour machines  
Dient fuer

327-22-1CD-04  
327-23-1CD-08

**203349-2-10**

Largh. costa  
Width of bight  
Largeur du surjet  
Ueberwendlichbreite } 1,4 mm

Serve per  
Serves for  
Pour machines  
Dient fuer

327-00-1CD-09  
327-00-1CD-39  
028-00-06  
228-00-06  
228-00-17  
228-00-18



**Rimoldi**

PLACCA AGO

NEEDLE PLATE

PLAQUE AIGUILLE

STICHPLATTE

Indice				TAB	<b>R300</b>
00					
Data 1-73				Foglio 15	Segue F.16

**203435-0-10**

Largh. costa  
Width of bight  
Largeur du surjet  
Ueberwendlichbreite } 3 mm

Serve per  
Serves for  
Pour machines  
Dient fuer

327-00-2CD-12  
327-00-2CD-34  
327-00-2CD-44  
028-00-09  
228-00-09

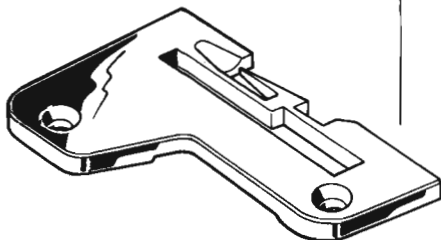
**203437-0-10**

Largh. costa  
Width of bight  
Largeur du surjet  
Ueberwendlichbreite } 3,2 mm

Serve per  
Serves for  
Pour machines  
Dient fuer

327-00-2CD-12  
028-00-09  
228-00-09

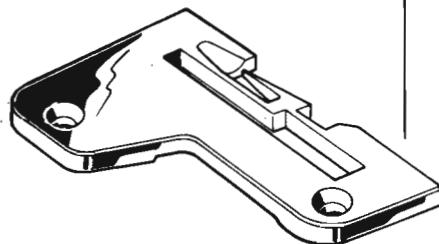
**203436-0-10**

Largh. costa  
Width of bight  
Largeur du surjet  
Ueberwendlichbreite } 2,5 mm

Serve per  
Serves for  
Pour machines  
Dient fuer

327-00-2CD-12  
327-00-2CD-34  
327-00-2CD-44  
028-00-09  
228-00-09

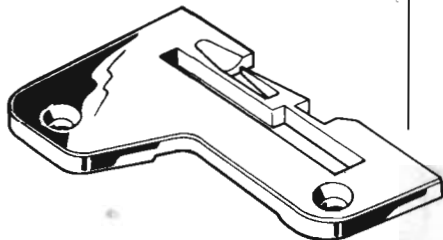
**203439-2-10**

Largh. costa  
Width of bight  
Largeur du surjet  
Ueberwendlichbreite } 4,5 mm

Serve per  
Serves for  
Pour machines  
Dient fuer

327-00-2CD-13  
028-00-10  
228-00-10

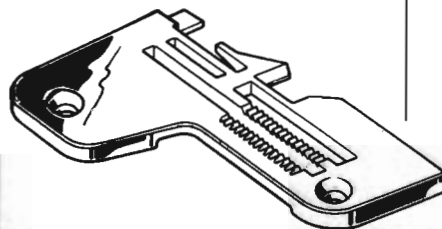

Indice  
Data  
V.  
VI.

Si senda noto che il contenuto della presente tavola non può essere ristampato, né può essere riprodotto o integralmente o parzialmente senza l'autorizzazione scritta della stessa ditta. Inviare i suoi diritti in forma di legge.

**Rimoldi**

PLACCA AGO

NEEDLE PLATE

PLAQUE AIGUILLE

STICHPLATTE

Indice	TAB	<b>R300</b>
Data 1-73	Foglio 16	Seque F17

**203441-2-10**

Largh. costa  
Width of bight  
Largeur du surjet  
Ueberwendlichbreite } 4,6 mm

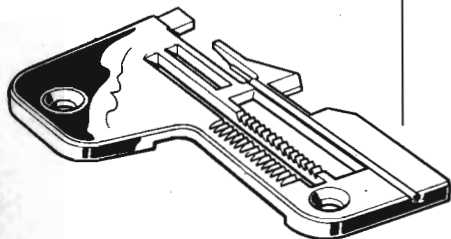

Serve per  
Serves for  
Pour machines  
Dient fuer

327-00-2CD-13

**203475-0-10**

Largh. costa  
Width of bight  
Largeur du surjet  
Ueberwendlichbreite } 3,5 mm

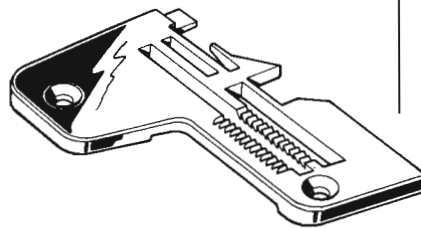

Serve per  
Serves for  
Pour machines  
Dient fuer

327-00-2CD-13  
028-00-10  
228-00-10

**203442-0-10**

Largh. costa  
Width of bight  
Largeur du surjet  
Ueberwendlichbreite } 3,5 mm

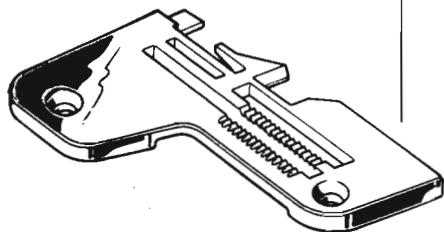

Serve per  
Serves for  
Pour machines  
Dient fuer

327-00-2CD-38

**203477-2-10**

Largh. costa  
Width of bight  
Largeur du surjet  
Ueberwendlichbreite } 3,6 mm

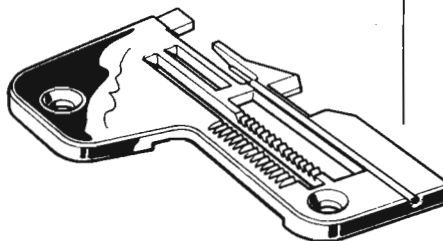

Serve per  
Serves for  
Pour machines  
Dient fuer

327-00-2CD-13

Si rende noto che il contenuto della presente tavola  
non può essere riprodotto o ristampato senza permesso  
scritto dalla Rimoldi S.p.A. e che il presente disegno  
è riservato a terzi o riprodotto sia integralmente  
che parzialmente senza permesso scritto dalla  
Rimoldi S.p.A. in base all'art. 17 della legge  
n. 633 del 25/3/1977.

Modifiche

Indice	
Data	
v.	



**Remoldi**

PLACCA AGO

NEEDLE PLATE

PLAQUE AIGUILLE

STICHPLATTE

Indice		R300
00		
Data 1-73		Foglio 17
		Segue F.18

**203478-0-10**

Largh. costa  
Width of bight  
Largeur du surjet  
Ueberwendlichbreite } 3 mm

Serve per  
Serves for  
Pour machines  
Dient fuer

327-00-2CD-13  
028-00-10  
228-00-10

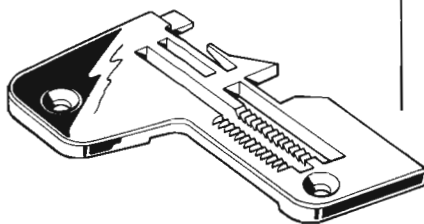
**203547-0-10**

Largh. costa  
Width of bight  
Largeur du surjet  
Ueberwendlichbreite } 8 mm

Serve per  
Serves for  
Pour machines  
Dient fuer

327-00-2CD-14  
327-00-2CD-17  
327-00-2CD-35  
327-01-2CD-05  
327-01-2CD-12  
028-00-11  
028-00-14  
028-01-05

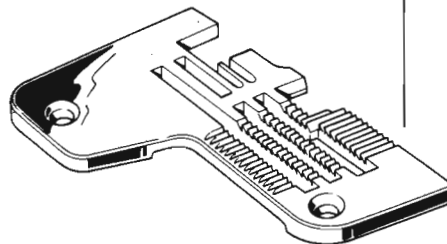
**203482-2-10**

Largh. costa  
Width of bight  
Largeur du surjet  
Ueberwendlichbreite } 3,1 mm

Serve per  
Serves for  
Pour machines  
Dient fuer

327-00-2CD-13

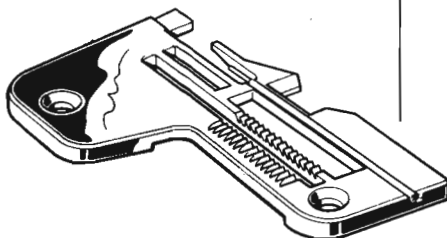
**203548-0-10**

Largh. costa  
Width of bight  
Largeur du surjet  
Ueberwendlichbreite } 7,5 mm

Serve per  
Serves for  
Pour machines  
Dient fuer

327-00-2CD-32  
327-00-2MD-37  
327-01-2CD-13

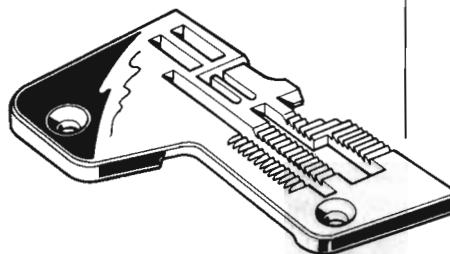

Si rende noto che il contenuto della presente tavola non potrà essere utilizzato o rappresentato né comunque divulgato a terzi o riprodotto sia integralmente che in parte senza il permesso scritto dalla L.D.I. & C. La stessa intende tutelare i suoi diritti in forma di legge.

indice  
Data  
v.

**203549-0-10**

Largh. costa }  
Width of bight } 7 mm  
Largeur du surjet }  
Ueberwendlichbreite }

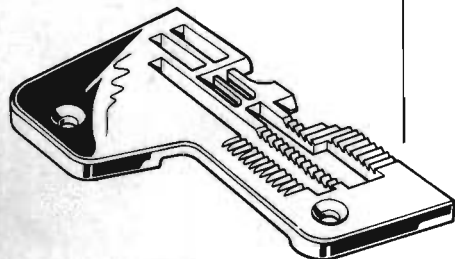

Serve per  
Serves for  
Pour machines  
Dient fuer

327-00-2CD-32

**203551-0-10**

Largh. costa }  
Width of bight } 5 mm  
Largeur du surjet }  
Ueberwendlichbreite }

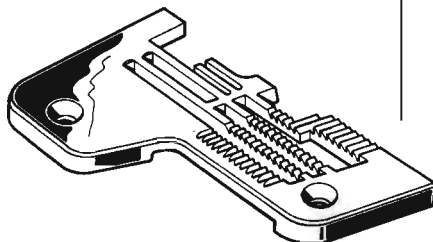

Serve per  
Serves for  
Pour machines  
Dient fuer

327-00-2CD-15  
327-00-2CD-45  
327-01-2CD-10  
028-00-12

**203550-0-10**

Largh. costa }  
Width of bight } 5,5 mm  
Largeur du surjet }  
Ueberwendlichbreite }

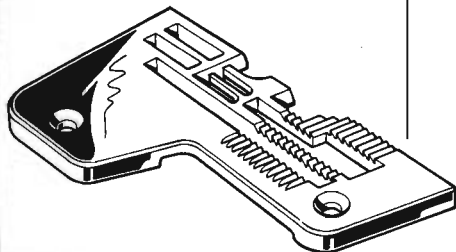

Serve per  
Serves for  
Pour machines  
Dient fuer

327-00-2CD-32

**203552-0-10**

Largh. costa }  
Width of bight } 5 mm  
Largeur du surjet }  
Ueberwendlichbreite }

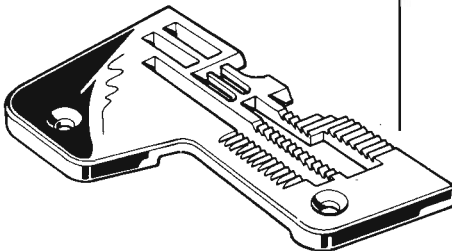

Serve per  
Serves for  
Pour machines  
Dient fuer

327-00-2CD-16  
327-00-2CD-41  
028-00-13

Si rende noto che il contenuto della presente tavola  
 e' un bene tutelato a terzi o riprodotto, senza autorizza-  
 zione del proprietario S.p.A., V.le dell'Industria, 101  
 10121 - TORINO - ITALIA.

Indice	
Data	
v.	





**203554-0-10**

Largh. costa  
 Width of bight } 6,5 mm  
 Largeur du surjet  
 Ueberwendlichbreite

Serve per  
 Serves for  
 Pour machines  
 Dient fuer

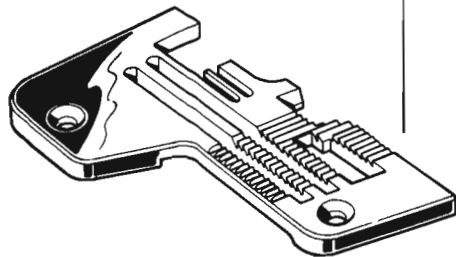
327-00-2CD-39  
 327-22-2CD-06  
 327-23-2CD-06



**203579-0-10**

Largh. costa  
 Width of bight } 5,2 mm  
 Largeur du surjet  
 Ueberwendlichbreite

Serve per  
 Serves for  
 Pour machines  
 Dient fuer

327-00-2CD-15  
 327-01-2CD-10  
 028-00-12

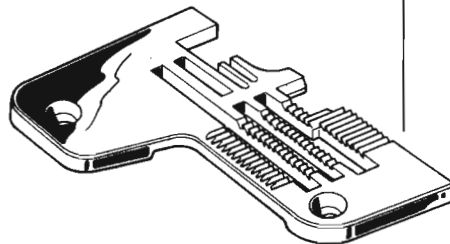

**203578-0-10**

Largh. costa  
 Width of bight } 5,5 mm  
 Largeur du surjet  
 Ueberwendlichbreite

Serve per  
 Serves for  
 Pour machines  
 Dient fuer

327-00-2CD-14  
 327-00-2CD-17  
 327-00-2CD-35  
 327-01-2CD-05  
 327-01-2CD-12  
 028-00-11  
 028-00-14  
 028-01-05

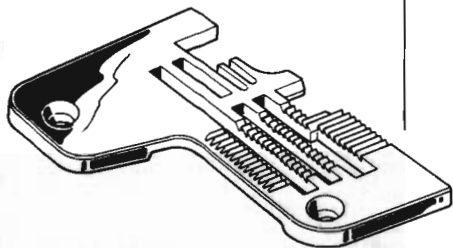

**203580-0-10**

Largh. costa  
 Width of bight } 5,2 mm  
 Largeur du surjet  
 Ueberwendlichbreite

Serve per  
 Serves for  
 Pour machines  
 Dient fuer

327-00-2CD-16  
 327-00-2CD-41  
 028-00-13

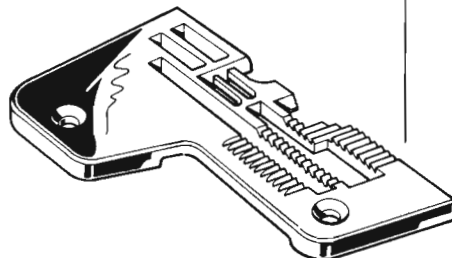



**Rimoldi****PLACCA AGO****NEEDLE PLATE****PLAQUE AIGUILLE****STICHPLATTE**

Indice				TAB	<b>R300</b>
00					
Data 1-73				Foglio 21	Segue F.22

**203762-0-10**

Largh. costa  
Width of bight  
Largeur du surjet  
Ueberwendlichbreite } 7,5 mm

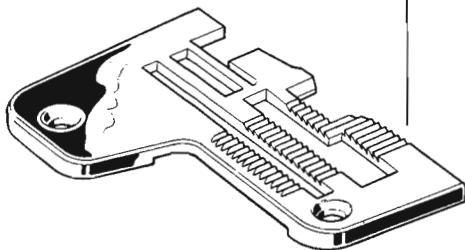

Serve per  
Serves for  
Pour machines  
Dient fuer

327-00-1CD-06  
327-00-1MD-23  
327-01-1CD-03  
327-01-1MD-08  
028-00-02  
028-00-18  
028-01-03  
028-01-08  
228-00-04  
228-01-02

**203785-0-10**

Largh. costa  
Width of bight  
Largeur du surjet  
Ueberwendlichbreite } 5 mm

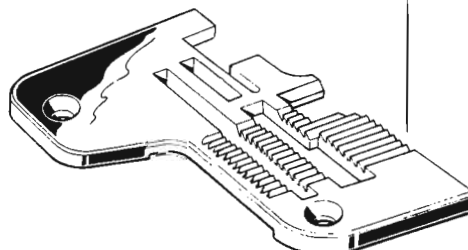

Serve per  
Serves for  
Pour machines  
Dient fuer

327-00-1CD-06  
327-00-1MD-23  
327-01-1CD-03  
327-01-1MD-08  
028-00-02  
028-00-18  
028-01-03  
028-01-08  
228-00-04  
228-01-02

**203763-0-10**

Largh. costa  
Width of bight  
Largeur du surjet  
Ueberwendlichbreite } 7 mm

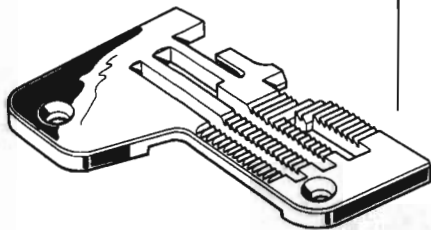

Serve per  
Serves for  
Pour machines  
Dient fuer

327-00-1MD-34  
327-22-1CD-01  
327-22-1MD-07  
327-23-1CD-01  
327-23-1MD-07

**203786-0-10**

Largh. costa  
Width of bight  
Largeur du surjet  
Ueberwendlichbreite } 5 mm

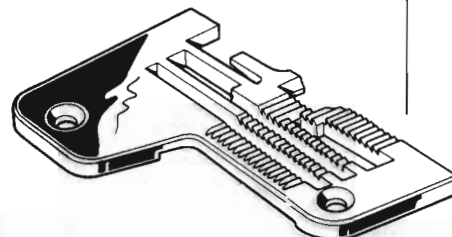

Serve per  
Serves for  
Pour machines  
Dient fuer

327-22-1CD-01  
327-22-1MD-07  
327-23-1CD-01  
327-23-1MD-07

Indice  
Data  
V,  
Vr,  
modificati

Si rende noto che il contenuto della presente tavola non è un brevetto e non può essere riprodotto o integralmente o parzialmente senza l'autorizzazione scritta della stessa impresa tutelare i suoi diritti in forma di legge.

**203787-0-10**

Largh. costa  
Width of bight  
Largeur du surjet  
Ueberwendlichbreite } 4 mm

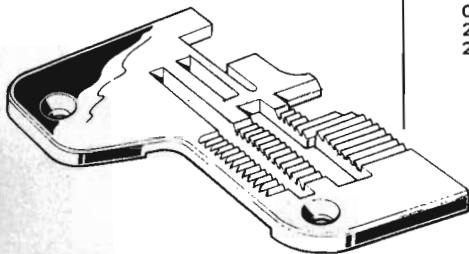

Serve per  
Serves for  
Pour machines  
Dient fuer

- 327-00-1CD-06
- 327-00-1MD-23
- 327-01-1CD-03
- 327-01-1MD-08
- 028-00-02
- 028-00-18
- 028-01-03
- 028-01-08
- 228-00-04
- 228-01-02

**203795-0-00**

Largh. costa  
Width of bight  
Largeur du surjet  
Ueberwendlichbreite } 3,6 mm

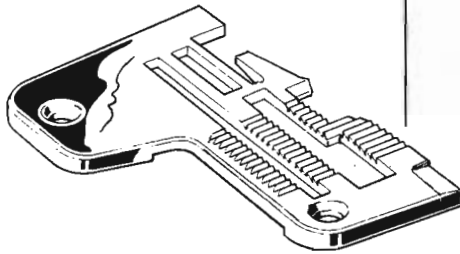

Serve per  
Serves for  
Pour machines  
Dient fuer

- 327-00-1CD-06/103-90
- 028-00-02/103-90
- 228-00-04/103-90

**203788-0-10**

Largh. costa  
Width of bight  
Largeur du surjet  
Ueberwendlichbreite } 7 mm

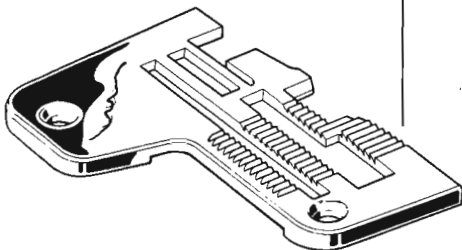

Serve per  
Serves for  
Pour machines  
Dient fuer

- 327-00-1CD-06
- 327-00-1MD-23
- 327-01-1CD-03
- 327-01-1MD-08
- 028-00-02
- 028-00-18
- 028-01-03
- 028-01-08
- 228-00-04
- 228-01-02

**203813-0-10**

Largh. costa  
Width of bight  
Largeur du surjet  
Ueberwendlichbreite } 5 mm

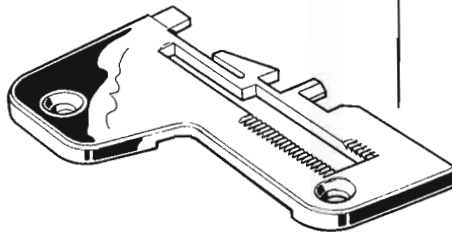

Serve per  
Serves for  
Pour machines  
Dient fuer

- 327-00-1CD-29
- 028-00-24

Si rende noto che il contenuto della presente tavola non potrà essere utilizzato o riprodotto senza permesso scritto dalla proprietaria S.p.A. V. Nazario Sauro, 36 - 00186 Roma (D.I. & C.). La stessa intende tutelare i suoi diritti e norme di legge.

modifiche

V.	Indice	Data



**Rumoldi**

PLACCA AGO

NEEDLE PLATE

PLAQUE AIGUILLE

STICHPLATTE

Indice				TAB	<b>R300</b>
00					
Data 1-73				Foglio 23	Segue F 24

**203853-4-10**

Largh. costa  
Width of bight  
Largeur du surjet  
Ueberwendlichbreite } 3 mm

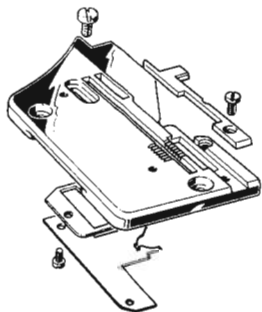

Serve per  
Serves for  
Pour machines  
Dient fuer

227-34-01

**204006-0-10**

Largh. costa  
Width of bight  
Largeur du surjet  
Ueberwendlichbreite } 5,5 mm

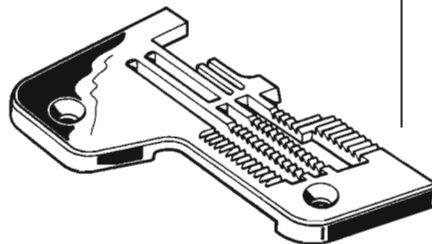

Serve per  
Serves for  
Pour machines  
Dient fuer

327-00-2CD-18  
327-00-2MD-36  
327-01-2CD-06  
327-01-2MD-11  
028-00-15  
028-00-16  
028-01-06

**203854-4-10**

Largh. costa  
Width of bight  
Largeur du surjet  
Ueberwendlichbreite } 3 mm

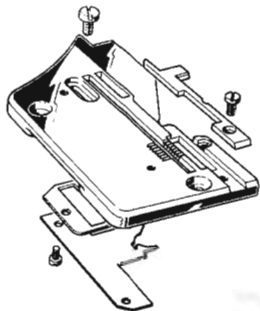

Serve per  
Serves for  
Pour machines  
Dient fuer

227-34-03

**204007-0-10**

Largh. costa  
Width of bight  
Largeur du surjet  
Ueberwendlichbreite } 6,5 mm

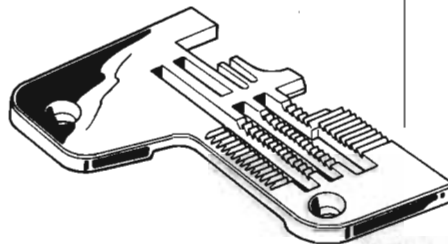

Serve per  
Serves for  
Pour machines  
Dient fuer

327-00-2CD-18  
327-00-2MD-36  
327-01-2CD-06  
327-01-2MD-11  
028-00-15  
028-00-16  
028-01-06

Indice  
Data  
V.  
Modifiche

Si vende solo che il contenuto della presente tavola non può essere utilizzato o riprodotto in alcun modo, né divulgato a terzi, o riprodotto sia integralmente che parzialmente, senza la scritta Rumoldi S.p.A. in calce. Di C. D. I. stessa intenzione tutelare i suoi diritti in forma di legge.





**Rimoldi**

PLACCA AGO

NEEDLE PLATE

PLAQUE AIGUILLE

STICHPLATTE

Indice

T.A.B.

**R300**

00

Data 1-73

Foglio 25

Segue F.26

**204066-0-10**

Largh. costa }  
 Width of bight } 8 mm  
 Largeur du surjet }  
 Ueberwendlichbreite }

Serve per  
 Serves for  
 Pour machines  
 Dient fuer

327-49-1MD-01

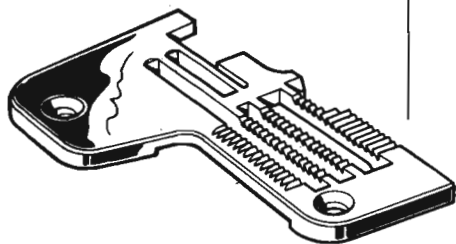
**204523-0-10**

Largh. costa }  
 Width of bight } 10 mm  
 Largeur du surjet }  
 Ueberwendlichbreite }

Serve per  
 Serves for  
 Pour machines  
 Dient fuer

028-28-09  
 028-29-08  
 228-28-09

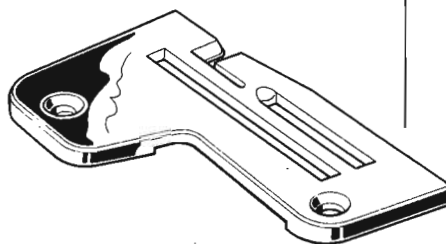
**204437-0-10**

Largh. costa }  
 Width of bight } 2 5 mm  
 Largeur du surjet }  
 Ueberwendlichbreite }

Serve per  
 Serves for  
 Pour machines  
 Dient fuer

228-10-04

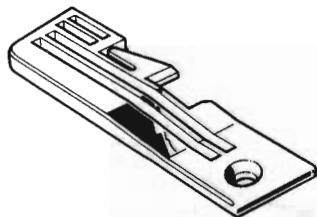
**204566-4-10**

Largh. costa }  
 Width of bight } 7 mm  
 Largeur du surjet }  
 Ueberwendlichbreite }

Serve per  
 Serves for  
 Pour machines  
 Dient fuer

028-28-10  
 028-28-11  
 228-28-08  
 228-28-11

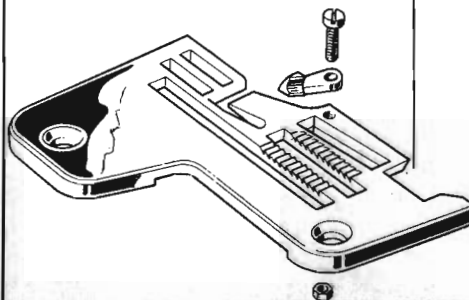

Si rende noto che il contenuto della presente tavola non potrà essere utilizzato o rappresentato né comunque divulgato a terzi o riprodotto sia integralmente sia parzialmente senza il permesso scritto della proprietaria S.p.A. V. R. 101 & C. La stessa intende tutelare i suoi diritti.

Indice  
 Data  
 V. r.

**204610-4-10**

Largh. costa }  
Width of bight } 5 mm  
Largeur du surjet }  
Ueberwendlichbreite }

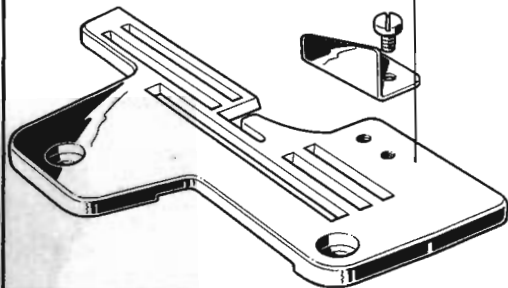

Serve per  
Serves for  
Pour machines  
Dient fuer

028-00-19  
228-00-16

**204695-0-11**

Largh. costa }  
Width of bight } 3,5 mm  
Largeur du surjet }  
Ueberwendlichbreite }

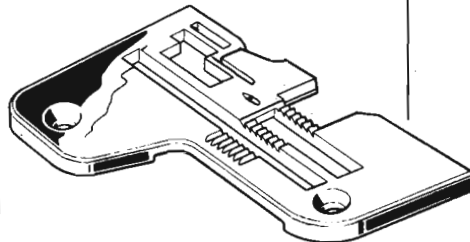

Serve per  
Serves for  
Pour machines  
Dient fuer

329-00-2CD-01

**204692-0-00**

Largh. costa }  
Width of bight } 4 mm  
Largeur du surjet }  
Ueberwendlichbreite }

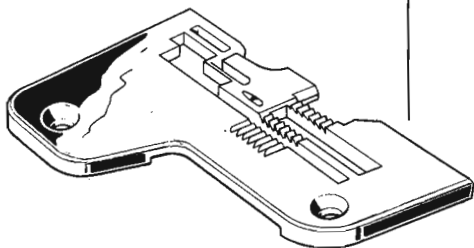

Serve per  
Serves for  
Pour machines  
Dient fuer

329-00-2CD-02

**204696-0-10**

Largh. costa }  
Width of bight } 4,2 mm  
Largeur du surjet }  
Ueberwendlichbreite }

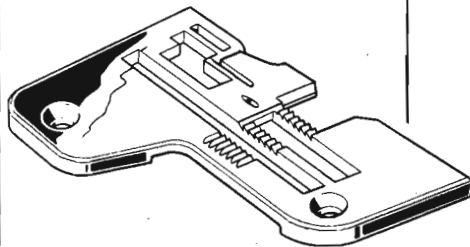

Serve per  
Serves for  
Pour machines  
Dient fuer

329-00-2CD-01

Si vede sotto che il contenuto delle pagine non  
 deve essere divulgato a terzi o riprodotto in  
 alcuna forma senza permesso scritto dalla Rumoldi  
 stessa. Intende tutelare i suoi diritti.

modifiche

Indice	
Data	
V	



**Remoldi**

PLACCA AGO

NEEDLE PLATE

PLAQUE AIGUILLE

STICHPLATTE

Indice

TAB

**R300**

Data 1-73 Foglio 27 Segue F.28

**204698-0-11**

Largh. costa  
Width of bight  
Largeur du surjet  
Ueberwendlichbreite } 3,7 mm

Serve per  
Serves for  
Pour machines  
Dient fuer

329-00-2CD-02

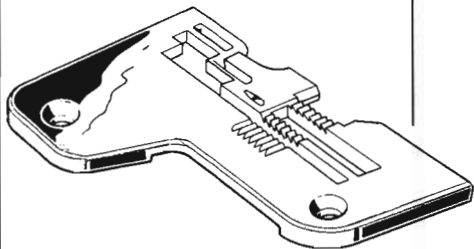
**204821-0-10**

Largh. costa  
Width of bight  
Largeur du surjet  
Ueberwendlichbreite } 3 mm

Serve per  
Serves for  
Pour machines  
Dient fuer

329-00-2CD-03

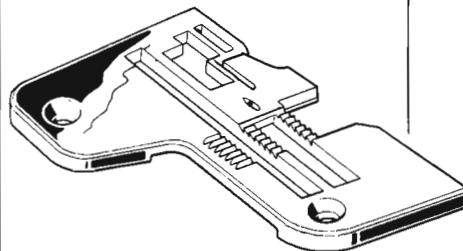
**204809-0-00**

Largh. costa  
Width of bight  
Largeur du surjet  
Ueberwendlichbreite } 5,5 mm

Serve per  
Serves for  
Pour machines  
Dient fuer

329-00-2CD-01

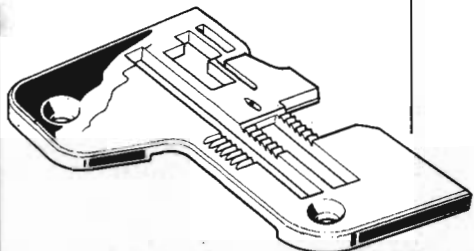
**204822-0-10**

Largh. costa  
Width of bight  
Largeur du surjet  
Ueberwendlichbreite } 3 mm

Serve per  
Serves for  
Pour machines  
Dient fuer

329-00-2CD-04

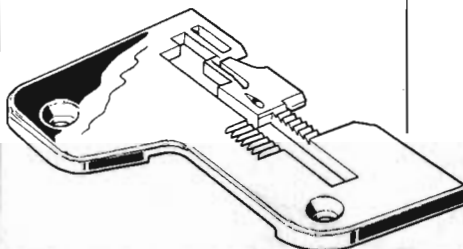

Si rende noto che il contenuto della presente tavola  
 non puo' essere copiato, ristampato, riprodotto o integral-  
 mente divulgato a terzi o riprodotto sia integral-  
 mente che parzialmente senza l'autorizzazione scrit-  
 ta della Remoldi S.p.A. pena di legge.  
 La stessa intende tutelare i suoi diritti.

indice  
 Data  
 V.  
 modifich

**204823-0-10**

Largh. costa  
Width of bight  
Largeur du surjet  
Ueberwendlichbreite } 3,6 mm

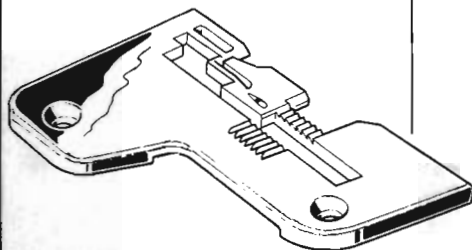

Serve per  
Serves for  
Pour machines  
Dient fuer

329-00-2CD-04

**204837-0-00**

Largh. costa  
Width of bight  
Largeur du surjet  
Ueberwendlichbreite } 3,2 mm

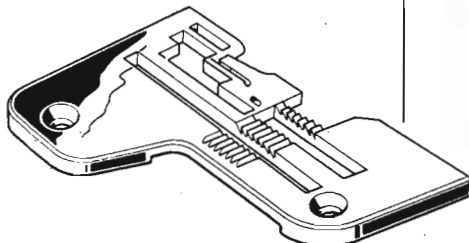

Serve per  
Serves for  
Pour machines  
Dient fuer

329-00-2CD-03

**204824-0-10**

Largh. costa  
Width of bight  
Largeur du surjet  
Ueberwendlichbreite } 3 mm

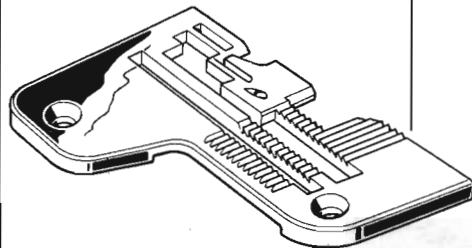

Serve per  
Serves for  
Pour machines  
Dient fuer

329-22-2CD-02  
329-23-2CD-02

**204838-0-00**

Largh. costa  
Width of bight  
Largeur du surjet  
Ueberwendlichbreite } 5 mm

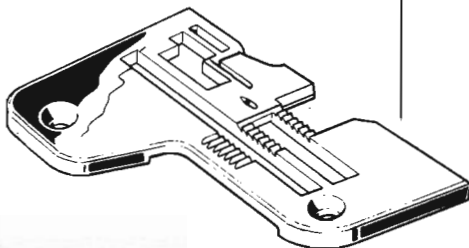

Serve per  
Serves for  
Pour machines  
Dient fuer

329-00-2CD-03

Si rende noto che il contenuto della presente tavola non potrà essere utilizzato o rappresentato né con nome né parzialmente senza l'autorizzazione scritta della proprietaria S.p.A. V. V. prima di essere stampato o ristampato.

Indice	
Data	
V.	

**Arnoldi**

PLACCA AGO

NEEDLE PLATE

PLAQUE AIGUILLE

STICHPLATTE

Indice		TAB	<b>R300</b>
00			
Data 1-73	Foglio 29	Segue F.30	

**204864-0-10**

Largh. costa  
Width of bight  
Largeur du surjet  
Ueberwendlichbreite

} 5 mm

Serve per  
Serves for  
Pour machines  
Dient fuer

329-00-2CD-05  
329-00-2CD-12  
329-01-2CD-01

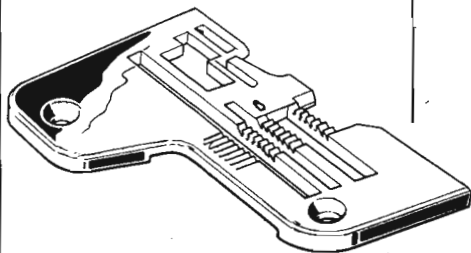
**204948-0-10**

Largh. costa  
Width of bight  
Largeur du surjet  
Ueberwendlichbreite

} 4 mm

Serve per  
Serves for  
Pour machines  
Dient fuer

329-00-2CD-05  
329-00-2CD-12  
329-01-2CD-01

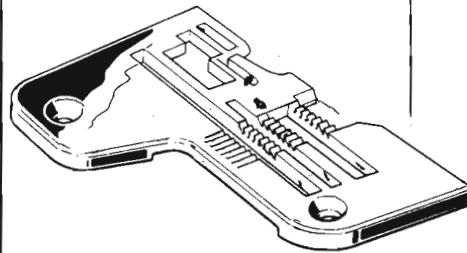
**204867-0-10**

Largh. costa  
Width of bight  
Largeur du surjet  
Ueberwendlichbreite

} 6 mm

Serve per  
Serves for  
Pour machines  
Dient fuer

329-00-2CD-15  
329-22-2CD-03  
329-23-2CD-03

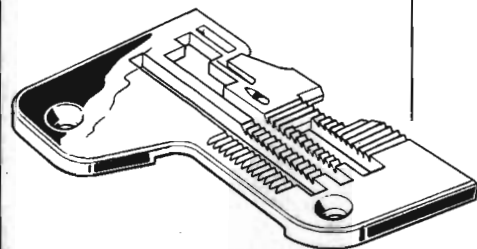
**204949-0-10**

Largh. costa  
Width of bight  
Largeur du surjet  
Ueberwendlichbreite

} 4 5 mm

Serve per  
Serves for  
Pour machines  
Dient fuer

329-00-2CD-15  
329-22-2CD-03  
329-23-2CD-03

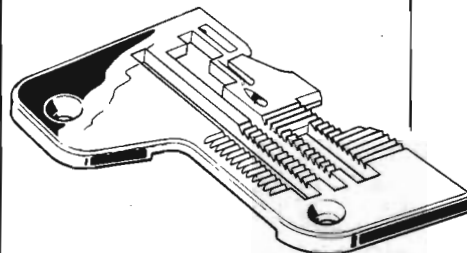

Indice  
Data  
V.  
Modifiche

Si rende noto che il contenuto della presente tavola non potrà essere utilizzato o riprodotto senza permesso scritto dalla Arnoldi S.p.A. senza autorizzazione scritta dalla stessa Arnoldi S.p.A. stessa intende tutelare i suoi diritti in forma di legge.

**204965-0-00**

Largh. costa  
Width of bight  
Largeur du surjet  
Ueberwendlichbreite } 15 mm

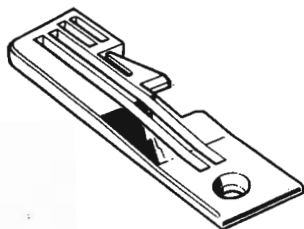

Serve per  
Serves for  
Pour machines  
Dient fuer

228-10-04

**205026-0-10**

Largh. costa  
Width of bight  
Largeur du surjet  
Ueberwendlichbreite } 5 mm

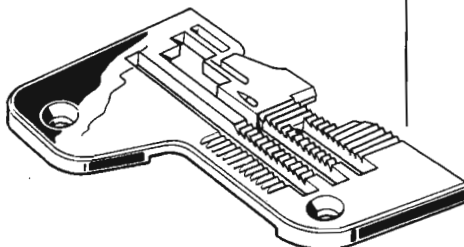

Serve per  
Serves for  
Pour machines  
Dient fuer

329-00-2CD-07  
329-00-2CD-13  
329-22-2CD-04  
329-23-2CD-04

**205025-0-10**

Largh. costa  
Width of bight  
Largeur du surjet  
Ueberwendlichbreite } 5,5 mm

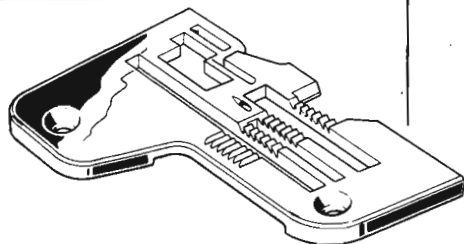

Serve per  
Serves for  
Pour machines  
Dient fuer

329-00-2CD-06  
329-00-2CD-10  
329-01-2CD-02

**205082-0-10**

Largh. costa  
Width of bight  
Largeur du surjet  
Ueberwendlichbreite } 2,5 mm

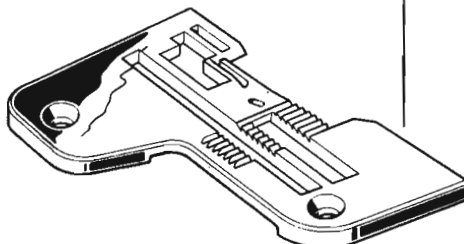

Serve per  
Serves for  
Pour machines  
Dient fuer

329-00-2CD-09

modifiche

Indice	Data	Vr

Si rende nota che il contenuto della presente tavola  
 non puo essere ristampato o copiato senza permesso  
 preventivo che peraltro non sara valido se non sara  
 integralmente ristampato e con la stessa  
 numerazione. E' vietata espressamente la  
 ristampa o l'uso di qualsiasi parte della  
 stessa in altre tavole o in qualsiasi forma di legge.

**Rimoldi**

PLACCA AGO

NEEDLE PLATE

PLAQUE AIGUILLE

STICHPLATTE

Indice				TAB	<b>R300</b>
00					
Data 1-73				Foglio 31	Segue F.32

**205083-0-10**

Largh. costa  
Width of bight  
Largeur du surjet  
Ueberwendlichbreite } 3 mm

Serve per  
Serves for  
Pour machines  
Dient fuer

329-00-2CD-11

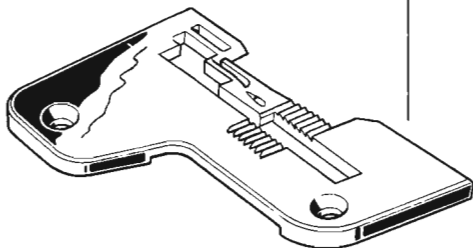
**205153-0-10**

Largh. costa  
Width of bight  
Largeur du surjet  
Ueberwendlichbreite } — mm

Serve per  
Serves for  
Pour machines  
Dient fuer

330-00-1CD-01

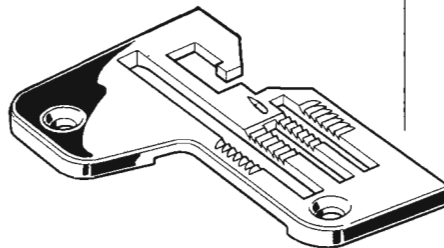
**205102-0-10**

Largh. costa  
Width of bight  
Largeur du surjet  
Ueberwendlichbreite } 3 5 mm

Serve per  
Serves for  
Pour machines  
Dient fuer

329-00-2CD-08

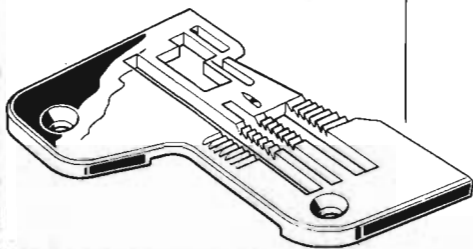
**205208-0-10**

Largh. costa  
Width of bight  
Largeur du surjet  
Ueberwendlichbreite } — mm

Serve per  
Serves for  
Pour machines  
Dient fuer

330-00-1CD-02

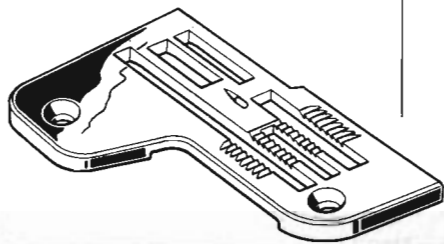

Indice  
Data  
V.

Si vende solo. Se il contenuto della presente tavola non può essere utilizzato integralmente, si prega di non divulgare e terzi o riprodurre, né sia integralmente che parzialmente, senza il permesso scritto della stessa ditta, che intende tutelare i suoi diritti in forma di legge.





**205597-0-00**

Largh. costa  
Width of bight  
Largeur du surjet  
Ueberwendlichbreite } 6,5 mm

Serve per  
Serves for  
Pour machines  
Dient fuer

327-34-1MD-03

**205661-0-00**

Largh. costa  
Width of bight  
Largeur du surjet  
Ueberwendlichbreite } 3,5 mm

Serve per  
Serves for  
Pour machines  
Dient fuer

327-00-2CD-38

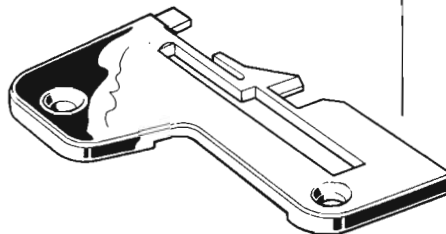
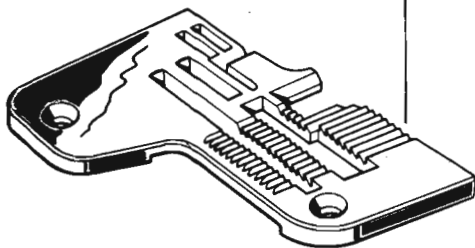

**205650-0-00**

Largh. costa  
Width of bight  
Largeur du surjet  
Ueberwendlichbreite } 7,5 mm

Serve per  
Serves for  
Pour machines  
Dient fuer

327-00-2CD-18  
327-00-2MD-36  
327-01-2CD-06  
327-01-2MD-11  
028-00-15  
028-00-16  
028-01-06

**205704-0-00**

Largh. costa  
Width of bight  
Largeur du surjet  
Ueberwendlichbreite } - mm

Serve per  
Serves for  
Pour machines  
Dient fuer

330-00-1CD-04

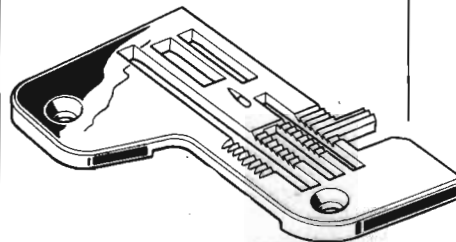
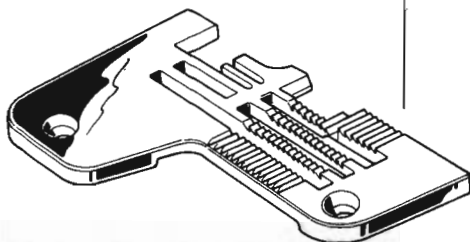

Si rende noto che il contenuto della presente tavola non potrà essere utilizzato o rappresentato, né copiato, né riprodotto, né ristampato, né tradotto, né divulgato, né comunicato in qualsiasi forma, senza l'autorizzazione scritta della proprietaria S.p.A. V. I. L. D. I. & C. La stessa intende tutelare i suoi diritti.

Indice  
Data  
V.



**Rumoldi**

PLACCA AGO

NEEDLE PLATE

PLAQUE AIGUILLE

STICHPLATTE

Indice		TAB		<b>R300</b>
00				
Data 1-73		Foglio 35		Segue F.36

**206866-0-00**

Largh. costa }  
Width of bight } 5 mm  
Largeur du surjet }  
Ueberwendlichbreite }

329-00-2CD-02

Serve per  
Serves for  
Pour machines  
Dient fuer

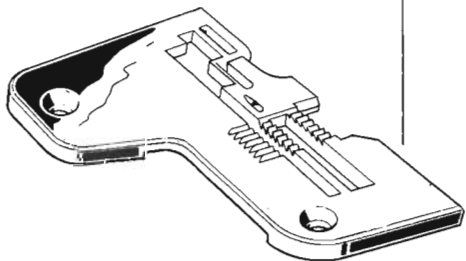

**207051-0-00**

Largh. costa }  
Width of bight } 2 mm  
Largeur du surjet }  
Ueberwendlichbreite }

329-00-2CD-06

Serve per  
Serves for  
Pour machines  
Dient fuer

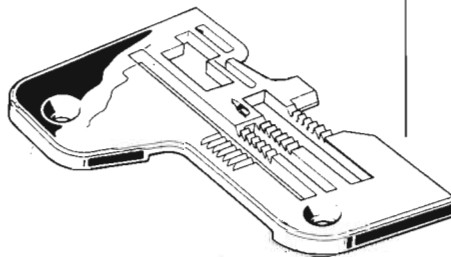

**207050-0-00**

Largh. costa }  
Width of bight } 3,3 mm  
Largeur du surjet }  
Ueberwendlichbreite }

327-00-2CD-38

Serve per  
Serves for  
Pour machines  
Dient fuer

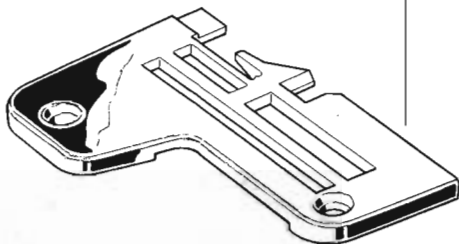

**207148-0-00**

*234 MC*

Largh. costa }  
Width of bight } 3,1 mm  
Largeur du surjet }  
Ueberwendlichbreite }

327-00-1CD-26  
327-00-1CD-30

Serve per  
Serves for  
Pour machines  
Dient fuer

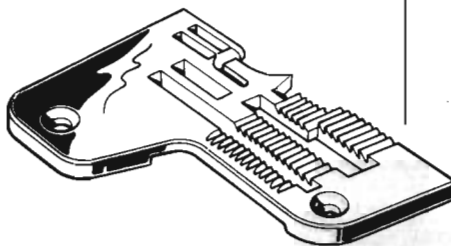

Si rende noto che il contenuto della presente tavola non può essere ristampato, copiato, riprodotto, o in qualsiasi modo divulgato, senza il permesso scritto e autorizzato dalla proprietaria S.p.A. V. I. Rumoldi & C. La stessa intende tutelare i suoi diritti. Firma di legge

Indice  
Data  
V.

**920750-0-10**

Largh. costa  
Width of bight  
Largeur du surjet  
Ueberwendlichbreite } 3,4 mm

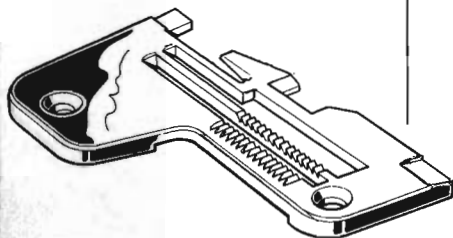

Serve per  
Serves for  
Pour machines  
Dient fuer

327-00-1CD-01/103-90  
028-00-01/103-90  
228-00-01/103-90

**920769-0-10**

Largh. costa  
Width of bight  
Largeur du surjet  
Ueberwendlichbreite } 3,7 mm

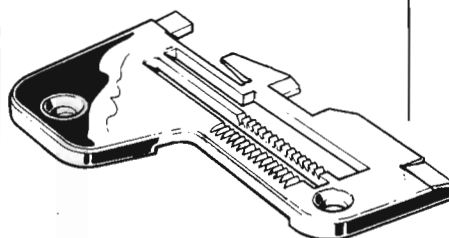

Serve per  
Serves for  
Pour machines  
Dient fuer

327-00-1CD-01/103-90  
028-00-01/103-90  
228-00-01/103-90

**920768-0-10**

Largh. costa  
Width of bight  
Largeur du surjet  
Ueberwendlichbreite } 3 mm

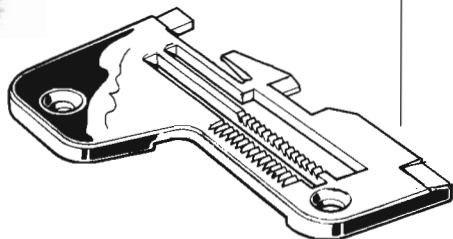

Serve per  
Serves for  
Pour machines  
Dient fuer

327-00-1CD-01/103-90  
028-00-01/103-90  
228-00-01/103-90

**920770-0-10**

Largh. costa  
Width of bight  
Largeur du surjet  
Ueberwendlichbreite } 4,1 mm

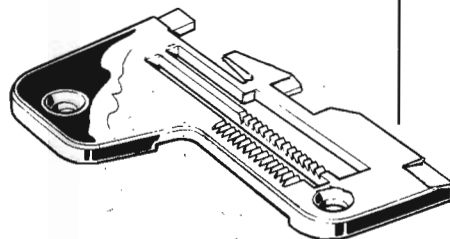

Serve per  
Serves for  
Pour machines  
Dient fuer

327-00-1CD-01/103-90  
028-00-01/103-90  
228-00-01/103-90

Si rende noto che il contenuto della presente tavola  
 non puo' essere ristampato o copiato senza permesso  
 scritto dalla Rumoldi S.p.A. senza permesso scritto  
 dalla Rumoldi S.p.A. senza permesso scritto dalla Rumoldi S.p.A.

modifiche	note	data	v.

**Rimoldi**

PLACCA AGO

NEEDLE PLATE

PLAQUE AIGUILLE

STICHPLATTE

Indice

00

00

R300

Data 1-73 Foglio 37 Sequenza 38

920786-0-10

Largh. costa  
Width of bight  
Largeur du surjet  
Ueberwendlichbreite

1,8 mm

Serve per  
Serves for  
Pour machines  
Dient fuer

327-00-1CD-02/103-90  
327-00-1CD-05/103-90  
028-00-04/103-90  
228-00-02/103-90  
228-00-14/103-90

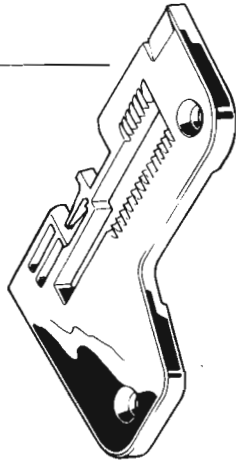

920788-0-10

Largh. costa  
Width of bight  
Largeur du surjet  
Ueberwendlichbreite

2,6 mm

Serve per  
Serves for  
Pour machines  
Dient fuer

327-00-1CD-02/103-90  
327-00-1CD-05/103-90  
028-00-04/103-90  
228-00-02/103-90  
228-00-14/103-90

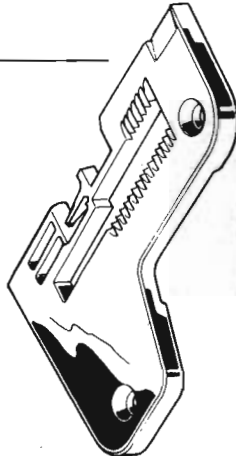

920796-0-10

Largh. costa  
Width of bight  
Largeur du surjet  
Ueberwendlichbreite

2,4 mm

Serve per  
Serves for  
Pour machines  
Dient fuer

327-00-1CD-07/103-90  
028-00-03/103-90  
228-00-05/103-90

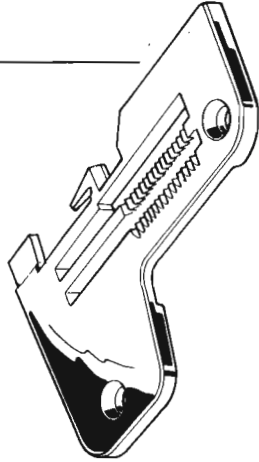

920797-0-10

Largh. costa  
Width of bight  
Largeur du surjet  
Ueberwendlichbreite

3 mm

Serve per  
Serves for  
Pour machines  
Dient fuer

327-00-1CD-07/103-90  
028-00-03/103-90  
228-00-05/103-90

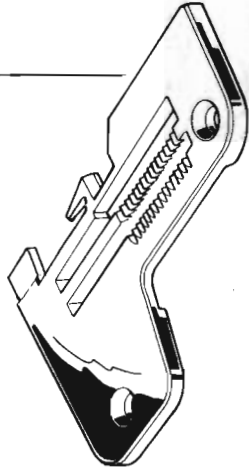

Si rende noto che il contenuto della presente tavola non potrà essere utilizzato o rappresentato né con altri nomi o segni o riprodurre in qualsiasi modo, senza permesso scritto, dalla proprietaria S.p.A. "V. Rizzoli & C. La stessa intende tutelare i suoi diritti.

Indice  
Date  
V.

**920803-0-10**

Largh. costa  
Width of bight  
Largeur du surjet  
Ueberwendlichbreite

3,3 mm

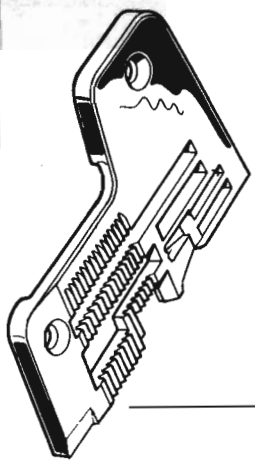

Serve per  
Serves for  
Pour machines  
Dient fuer

327-00-1CD-30/103-90  
028-00-25/103-90  
228-00-13/103-90

**920805-0-10**

Largh. costa  
Width of bight  
Largeur du surjet  
Ueberwendlichbreite

4,5 mm

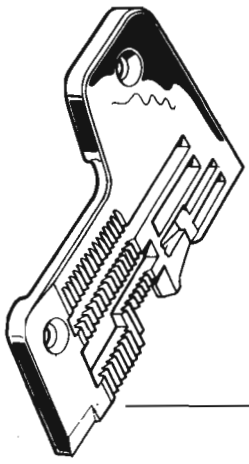

Serve per  
Serves for  
Pour machines  
Dient fuer

327-00-1CD-30/103-90  
028-00-25/103-90  
228-00-13/103-90

**920806-0-10**

Largh. costa  
Width of bight  
Largeur du surjet  
Ueberwendlichbreite

5,5 mm

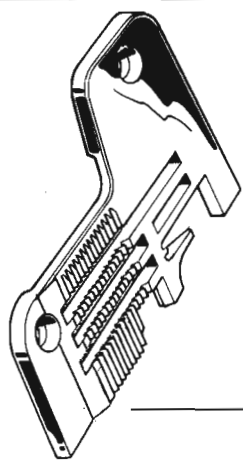

Serve per  
Serves for  
Pour machines  
Dient fuer

327-00-2CD-18/108-91  
327-00-2MD-36/108-91  
028-00-15/108-90  
028-00-16/108-90

**920807-0-10**

Largh. costa  
Width of bight  
Largeur du surjet  
Ueberwendlichbreite

6 mm

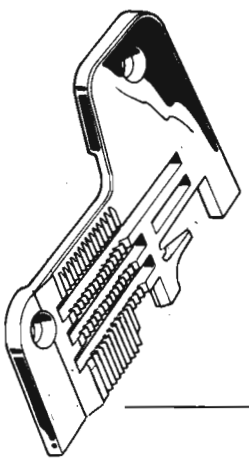

Serve per  
Serves for  
Pour machines  
Dient fuer

327-00-2CD-18/108-91  
327-00-2MD-36/108-91  
028-00-15/108-90  
028-00-16/108-90

Si rende noto che il contenuto della presente tavola non potrà essere utilizzato o riprodotto in alcun modo senza permesso scritto dalla proprietaria S.P.A. V. V. Romoldi & C. Le stesse intende tutelare i suoi diritti a norma di legge.

Modifica	Indice	Data	V.

**Rumoldi**

PLACCA AGO

NEEDLE PLATE

PLAQUE AIGUILLE

STICHPLATTE

00	Indice	TAB	<b>R300</b>
Data	1-73	Foglio 39	Segue F.40

**920808-0-10**

Largh. costa  
Width of bight  
Largeur du surjet  
Ueberwendlichbreite } 6,5 mm

Serve per  
Serves for  
Pour machines  
Dient fuer

327-00-2CD-18/108-91  
327-00-2MD-36/108-91  
028-00-15/108-90  
028-00-16/108-90

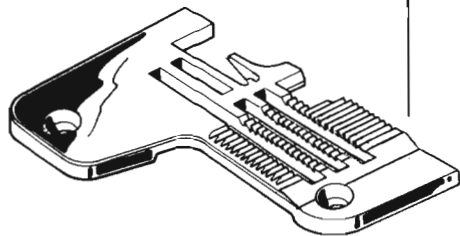
**920820-0-00**

Largh. costa  
Width of bight  
Largeur du surjet  
Ueberwendlichbreite } 2,5 mm

Serve per  
Serves for  
Pour machines  
Dient fuer

327-00-1CD-03/103-90  
028-00-05/103-90  
228-00-03/103-90

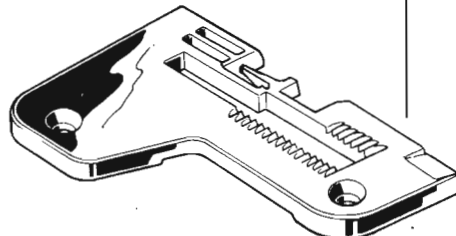
**920812-0-10**

Largh. costa  
Width of bight  
Largeur du surjet  
Ueberwendlichbreite } 2,8 mm

Serve per  
Serves for  
Pour machines  
Dient fuer

327-00-1CD-31/103-90  
228-00-15/103-90

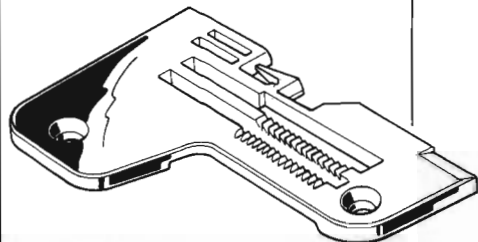
**920832-0-00**

Largh. costa  
Width of bight  
Largeur du surjet  
Ueberwendlichbreite } 7 mm

Serve per  
Serves for  
Pour machines  
Dient fuer

327-00-2CD-14/108-91  
327-00-2CD-17/108-91  
327-00-2MD-21/108-91  
028-00-11/108-90  
028-00-14/108-90

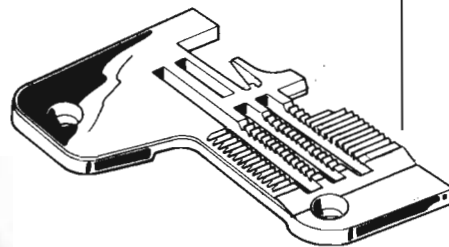

Si rende noto che il contenuto della presente tavola non potrà essere utilizzato o rappresentato, né con qualunque titolo, senza il permesso scritto e autorizzato dalla proprietaria S.p.A. V. R. Di & C. La stessa intende tutelare i suoi diritti.

indice  
Data  
V.

**920836-0-00**

Largh. costa  
Width of bight  
Largeur du surjet  
Ueberwendlichbreite } 6 mm

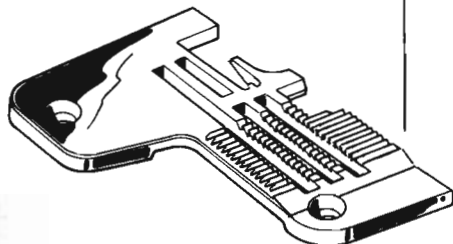

Serve per  
Serves for  
Pour machines  
Dient fuer

327-00-2CD-14/108-91  
028-00-11/108-90

**920852-0-00**

Largh. costa  
Width of bight  
Largeur du surjet  
Ueberwendlichbreite } 6,5 mm

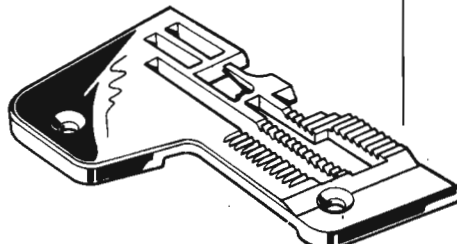

Serve per  
Serves for  
Pour machines  
Dient fuer

327-00-2CD-32/108-91

**920851-0-00**

Largh. costa  
Width of bight  
Largeur du surjet  
Ueberwendlichbreite } 7 mm

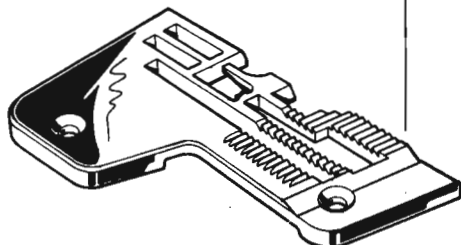

Serve per  
Serves for  
Pour machines  
Dient fuer

327-00-2CD-32/108-91

**920855-0-00**

Largh. costa  
Width of bight  
Largeur du surjet  
Ueberwendlichbreite } 6 mm

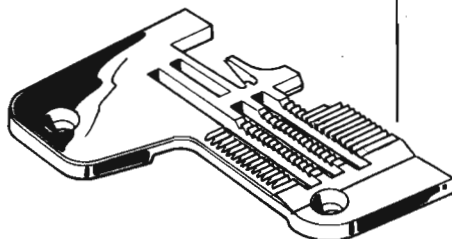

Serve per  
Serves for  
Pour machines  
Dient fuer

327-00-2CD-15/108-91  
028-00-12/108-90

Si rende noto che il contenuto della presente tavola non potrà essere utilizzato o rappresentato, né come disegno o come modello, senza il permesso scritto della proprietaria S.p.A. V. E. D. I. & C. Le stesse aziende tutelano i suoi diritti in ogni forma di legge.

modifich.

Indice	Data	Vr





**Remoldi**

PLACCA AGO

NEEDLE PLATE

PLAQUE AIGUILLE

STICHPLATTE

Indice				TAB	<b>R300</b>
00					
Data 1-73				Foglio 41	Segue F42

**920857-0-00**

Largh. costa  
Width of bight  
Largeur du surjet  
Ueberwendlichbreite } 6 mm

Serve per  
Serves for  
Pour machines  
Dient fuer

327-00-2CD-16/108-91  
028-00-13/108-90

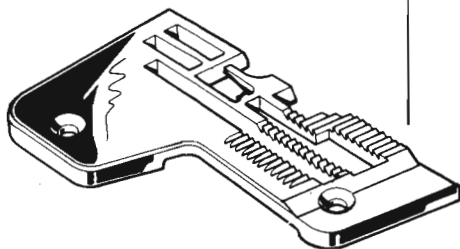
**920878-0-00**

Largh. costa  
Width of bight  
Largeur du surjet  
Ueberwendlichbreite } 7 mm

Serve per  
Serves for  
Pour machines  
Dient fuer

327-00-2CD-14/108-91  
327-00-2CD-17/108-91  
327-00-2MD-21/108-91  
028-00-14/108-91

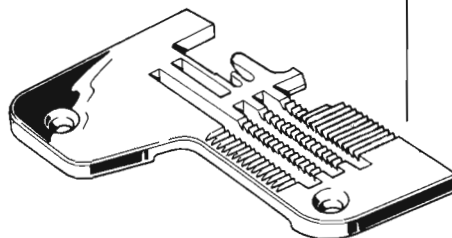
**920862-0-00**

Largh. costa  
Width of bight  
Largeur du surjet  
Ueberwendlichbreite } 2,5 mm

Serve per  
Serves for  
Pour machines  
Dient fuer

327-00-1CD-25/103-90

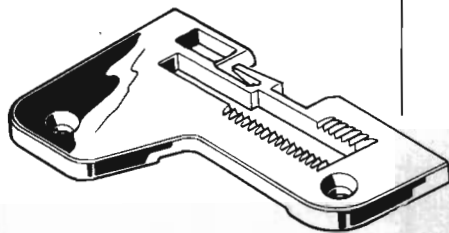
**920879-0-00**

Largh. costa  
Width of bight  
Largeur du surjet  
Ueberwendlichbreite } 6 mm

Serve per  
Serves for  
Pour machines  
Dient fuer

327-00-2CD-18/108-91  
327-00-2MD-36/108-91  
028-00-15/108-90  
028-00-16/108-90

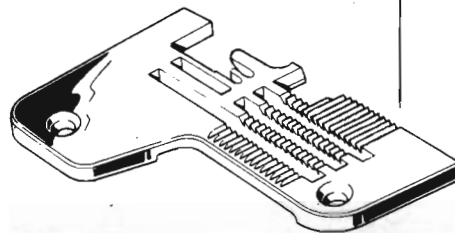

Indice  
Data  
V.  
mm

Si vende nudo che il contenuto della presente tavola non può essere utilizzato o appreso in alcun modo, neppure divulgato a terzi o riprodotto sia integralmente che in parte, senza il permesso scritto dalla Remoldi S.p.A. Lo stesso intende tutelare i suoi diritti in forma di legge.

**920880-0-00**

Largh. costa  
Width of bight  
Largeur du surjet  
Ueberwendlichbreite } 5,5 mm

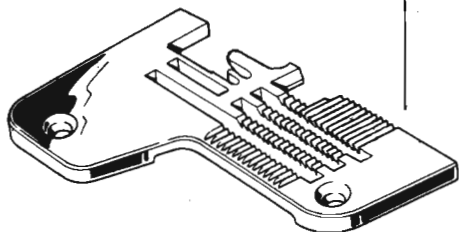

Serve per  
Serves for  
Pour machines  
Dient fuer

327-00-2CD-18/108-91  
327-00-2MD-36/108-91  
028-00-15/108-90  
028-00-16/108-90

**921336-4-01**

Largh. costa  
Width of bight  
Largeur du surjet  
Ueberwendlichbreite } 2 mm

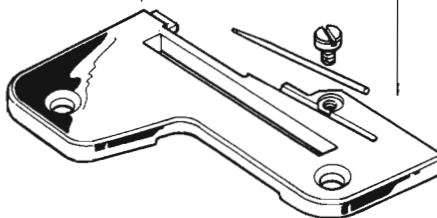

Serve per  
Serves for  
Pour machines  
Dient fuer

327-00-1CD-09/135-81/137-81  
327-00-1CD-39/135-81/137-81  
028-00-06/135-80/137-80  
228-00-06/135-80/137-80  
228-00-17/135-80/137-80

**920881-0-00**

Largh. costa  
Width of bight  
Largeur du surjet  
Ueberwendlichbreite } 6,5 mm

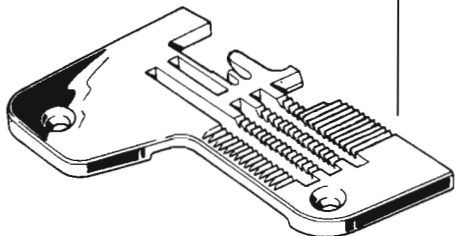

Serve per  
Serves for  
Pour machines  
Dient fuer

327-00-2CD-18/108-91  
327-00-2MD-36/108-91  
028-00-15/108-90  
028-00-16/108-90

**921451-0-10**

Largh. costa  
Width of bight  
Largeur du surjet  
Ueberwendlichbreite } 3 mm

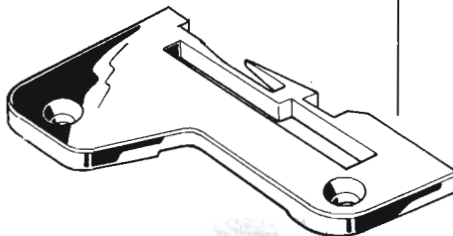

Serve per  
Serves for  
Pour machines  
Dient fuer

327-00-2CD-12/135-81  
028-00-09/135-80/137-80  
228-00-09/135-80/137-80  
228-00-09/135-80/137-80

Si fonda conto che il contenuto della presente tavola non potrà essere utilizzato o appuramento né con-  
munque divulgato a terzi o riprodotto, sia integral-  
te dell'opera. Si riserva ai Rimoldi il diritto di leg-  
gesta intende tutelare i suoi diritti.

modifiche

Integr.	Data	V.

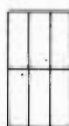

**Rumoldi**

PLACCA AGO

NEEDLE PLATE

PLAQUE AIGUILLE

STICHPLATTE

**921491-0-11**

Largh. costa  
Width of bight  
Largeur du surjet  
Ueberwendlichbreite } 3,5 mm

Serve per  
Serves for  
Pour machines  
Dient fuer

329-00-2CD-01/136-81

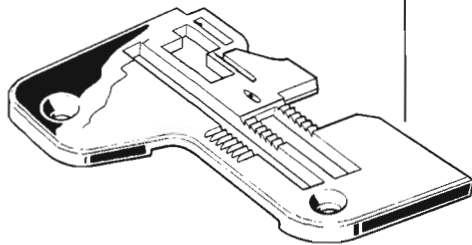

**921493-0-10**

Largh. costa  
Width of bight  
Largeur du surjet  
Ueberwendlichbreite } 3 mm

Serve per  
Serves for  
Pour machines  
Dient fuer

329-00-2CD-03/136-81

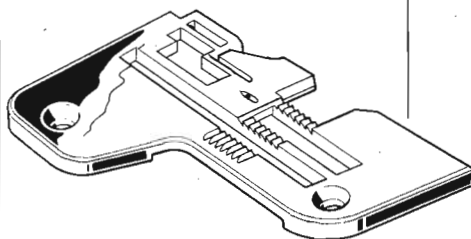

**921492-0-11**

Largh. costa  
Width of bight  
Largeur du surjet  
Ueberwendlichbreite } 3,7 mm

Serve per  
Serves for  
Pour machines  
Dient fuer

329-00-2CD-02/136-81

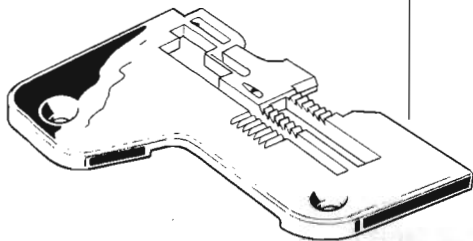

**921494-0-10**

Largh. costa  
Width of bight  
Largeur du surjet  
Ueberwendlichbreite } 3 mm

Serve per  
Serves for  
Pour machines  
Dient fuer

329-00-2CD-01/136-81

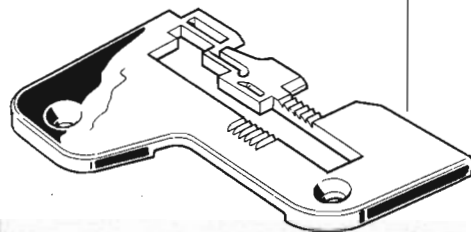

Si rende noto che il contenuto della presente tavola non potrà essere utilizzato o rappresentato né comunque divulgato a terzi, o riprodotto sia integralmente sia parzialmente, senza il permesso scritto della proprietaria S.p.A. Rumoldi S.p.A. La stessa intende tutelare i suoi diritti, forma di legge.

INDICE  
Date  
V.

**Remoldi**

PLACCA AGO

NEEDLE PLATE

PLAQUE AIGUILLE

STICHPLATTE

Indice	00	TAB	<b>R300</b>
Data	1-73	Foglio 44	Segue F45

**925495-0-10**

Largh. costa  
Width of bight  
Largeur du surjet  
Ueberwendlichbreite } 5 mm

329-00-2CD-05/136-81

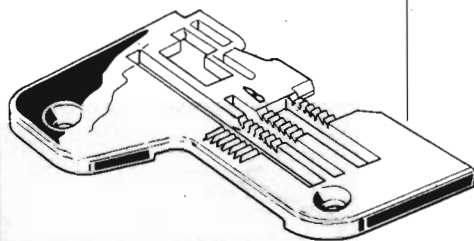
**921512-0-10**

Largh. costa  
Width of bight  
Largeur du surjet  
Ueberwendlichbreite } — mm

330-00-1CD-01/136-81

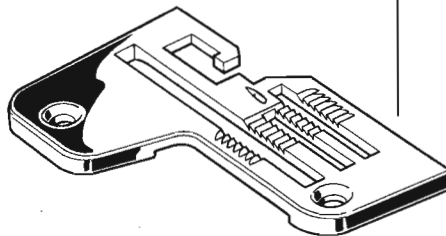
**921506-0-00**

Largh. costa  
Width of bight  
Largeur du surjet  
Ueberwendlichbreite } 4 mm

329-00-2CD-05/136-81

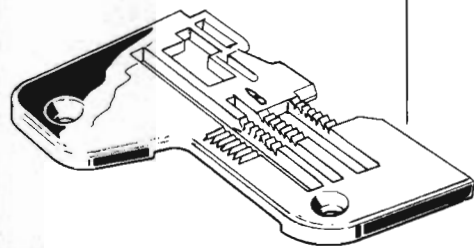
**921538-2-10**

Largh. costa  
Width of bight  
Largeur du surjet  
Ueberwendlichbreite } 1,4 mm

228-00-18/135-80/137-80

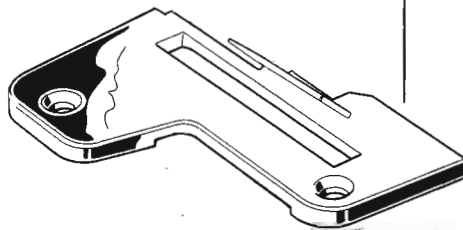

Si rende noto che il contenuto della presente tavola non potrà essere utilizzato o rappresentato né con parole, disegni, o terzi o riprodotto, senza l'autorizzazione scritta della proprietà S.p.A. V. R. O. I. S. C. La stessa intende tutelare i suoi diritti in forma di legge.

modifiche

Indice	
Data	
Vr	







INDICE
Data
V.

Si rende noto che il contenuto della presente tavola non potrà essere utilizzato o rappresentato né concesso in licenza o in prestito senza il permesso scritto della proprietaria S.p.A. V. R. & C. La stessa intende tutelare i suoi diritti.

**Renoldi**

PLACCA AGO

NEEDLE PLATE

PLAQUE AIGUILLE

STICHPLATTE

Indice	00					TAB	<b>R300</b>
Data	1-73	Foglio	45	Segue	F.46		

**923774-0-00**

Largh. costa  
Width of bight  
Largeur du surjet  
Ueberwendlichbreite } 4,1 mm

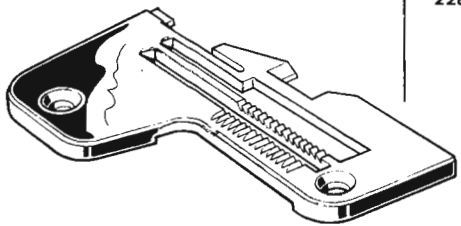

Serve per  
Serves for  
Pour machines  
Dient fuer

- 327-00-1CD-01/135-81
- 327-28-1CD-02/135-81
- 028-00-01/135-80
- 028-28-01/135-80
- 028-28-02/135-80
- 228-00-01/135-80
- 228-28-01/135-80
- 228-28-02/135-80

**923776-0-00**

Largh. costa  
Width of bight  
Largeur du surjet  
Ueberwendlichbreite } 4 mm

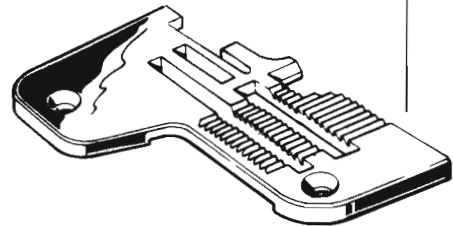

Serve per  
Serves for  
Pour machines  
Dient fuer

- 327-28-1CD-04/135-81
- 028-28-03/135-80
- 028-28-04/135-80
- 228-28-03/135-80
- 228-28-04/135-80

**923775-0-00**

Largh. costa  
Width of bight  
Largeur du surjet  
Ueberwendlichbreite } 2 mm

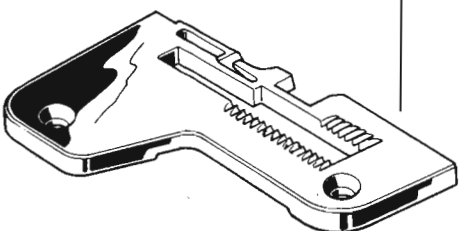

Serve per  
Serves for  
Pour machines  
Dient fuer

- 327-00-1CD-02/135-81
- 327-00-1CD-05/135-81
- 028-00-04/135-80
- 228-00-02/135-80
- 228-00-14/135-80

**923777-0-00**

Largh. costa  
Width of bight  
Largeur du surjet  
Ueberwendlichbreite } 4 mm

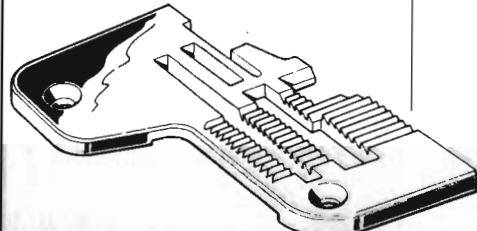

Serve per  
Serves for  
Pour machines  
Dient fuer

- 327-00-1CD-06/135-80
- 327-00-1MD-23/135-81
- 028-00-02/135-80
- 028-00-18/135-80
- 228-00-04/135-80



**Rimoldi**

PLACCA AGO

NEEDLE PLATE

PLAQUE AIGUILLE

STICHPLATTE

Indice

**R300**

00

ab

Data 1-73

Foglio 47 | Segue F.48

**923833-0-00**

Largh. costa  
Width of bight  
Largeur du surjet  
Ueberwendlichbreite } 5,6 mm

Serve per  
Serves for  
Pour machines  
Dient fuer

327-00-1CD-01/135-81  
327-28-1CD-02/135-81  
028-00-01/135-80  
028-28-01/135-80  
028-28-02/135-80  
228-00-01/135-80  
228-28-01/135-80  
228-28-02/135-80

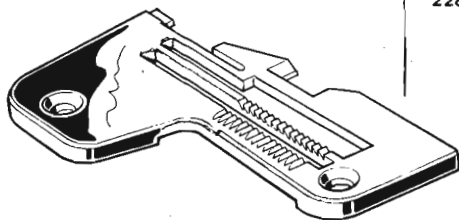
**923835-0-00**

Largh. costa  
Width of bight  
Largeur du surjet  
Ueberwendlichbreite } 2,5 mm

Serve per  
Serves for  
Pour machines  
Dient fuer

327-00-1CD-02/135-81  
327-00-1CD-05/135-81  
028-00-04/135-80  
228-00-02/135-80  
228-00-14/135-80

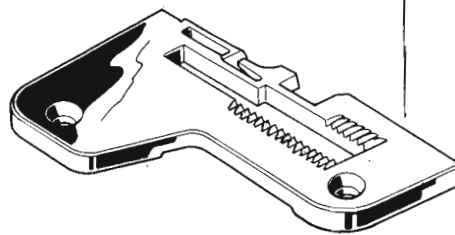
**923834-0-00**

Largh. costa  
Width of bight  
Largeur du surjet  
Ueberwendlichbreite } 6 mm

Serve per  
Serves for  
Pour machines  
Dient fuer

327-00-1CD-01/135-81  
327-28-1CD-02/135-81  
028-00-01/135-80  
028-28-01/135-80  
028-28-02/135-80  
228-00-01/135-80  
228-28-01/135-80  
228-28-02/135-80

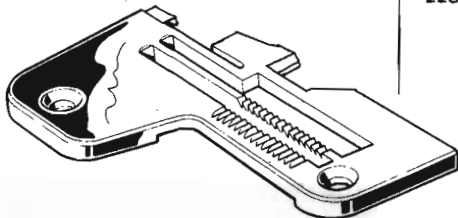
**923836-0-00**

Largh. costa  
Width of bight  
Largeur du surjet  
Ueberwendlichbreite } 3,5 mm

Serve per  
Serves for  
Pour machines  
Dient fuer

327-00-1CD-02/135-81  
327-00-1CD-05/135-81  
028-00-04/135-80  
228-00-02/135-80  
228-00-14/135-80

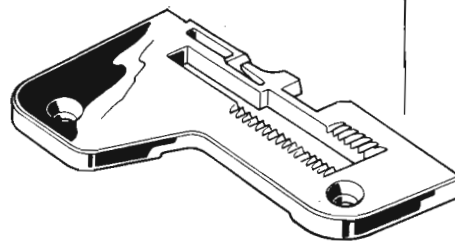

Si rende noto che il contenuto della presente tavola non è utilizzabile o riproducibile integralmente o parzialmente senza l'autorizzazione scritta della proprietaria S.p.A. V.lli. 9, 101 & C. La stessa intende tutelare i suoi diritti e sistemi di legge.

Indice  
Data  
V.





**Rumoldi**

PLACCA AGO

NEEDLE PLATE

PLAQUE AIGUILLE

STICHPLATTE

Indice	TAB	<b>R300</b>
Data 1-73	Foglio 49	Segue F.50

**923842-0-00**

Largh. costa  
Width of bight  
Largeur du surjet  
Ueberwendlichbreite } 3 mm

Serve per  
Serves for  
Pour machines  
Dient fuer

327-00-1CD-03/135-81.  
028-00-05/135-80

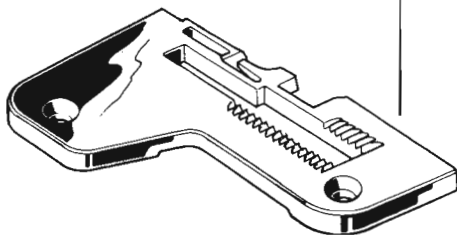
**923844-0-00**

Largh. costa  
Width of bight  
Largeur du surjet  
Ueberwendlichbreite } 3 mm

Serve per  
Serves for  
Pour machines  
Dient fuer

327-10-1CD-02/135-81  
327-10-1CD-06/135-81  
327-11-1CD-02/135-81  
028-10-02/135-80  
028-10-03/135-80  
028-10-04/135-80  
028-10-05/135-80  
228-10-01/135-80  
228-10-05/135-80  
228-10-06/135-80  
228-10-07/135-80

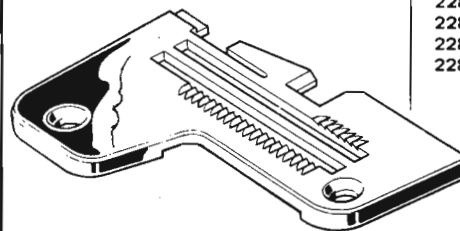
**923843-0-00**

Largh. costa  
Width of bight  
Largeur du surjet  
Ueberwendlichbreite } 3,2 mm

Serve per  
Serves for  
Pour machines  
Dient fuer

327-10-1CD-02/135-81  
327-10-1CD-06/135-81  
327-11-1CD-02/135-81  
028-10-02/135-80  
028-10-03/135-80  
028-10-04/135-80  
028-10-05/135-80  
228-10-01/135-80  
228-10-05/135-80  
228-10-06/135-80  
228-10-07/135-80

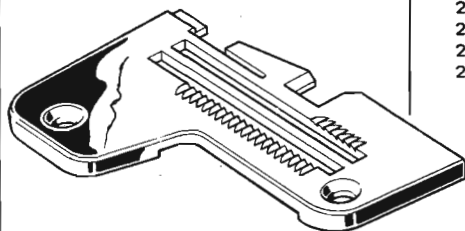
**923845-0-00**

Largh. costa  
Width of bight  
Largeur du surjet  
Ueberwendlichbreite } 5 mm

Serve per  
Serves for  
Pour machines  
Dient fuer

327-10-1CD-02/135-81  
327-10-1CD-06/135-81  
327-11-1CD-02/135-81  
028-10-02/135-80  
028-10-03/135-80  
028-10-04/135-80  
028-10-05/135-80  
228-10-01/135-80  
228-10-05/135-80  
228-10-06/135-80  
228-10-07/135-80

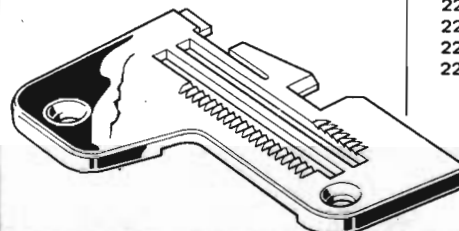

Indice  
Data  
Vr

Si, senda neto che il contenuto della presente tavola non potrà essere utilizzato o rappresentato né comunque divulgato a terzi o riprodotto o integralmente o parzialmente senza il permesso scritto della proprietaria S.p.A. V. F. S. O. I. & C. La stessa intende tutelare i suoi diritti, in forma di legge.

**923846-0-00**

Largh. costa }  
 Width of bight } 2,5 mm  
 Largeur du surjet }  
 Ueberwendlichbreite }

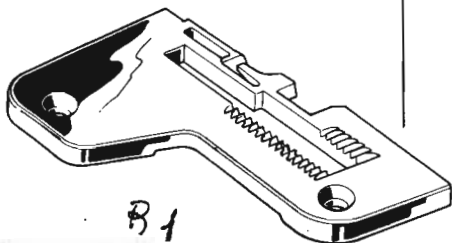

Serve per  
 Serves for  
 Pour machines  
 Dient fuer

327-10-03/135-81  
 327-10-1CD-04/135-81  
 228-10-02/135-80  
 228-10-03/135-80

**923848-0-00**

Largh. costa }  
 Width of bight } 4 5 mm  
 Largeur du surjet }  
 Ueberwendlichbreite }

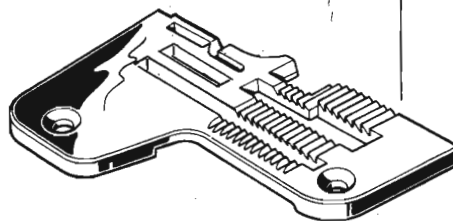

Serve per  
 Serves for  
 Pour machines  
 Dient fuer

327-00-1CD-30/135-81  
 327-00-1MD-33/135-81  
 028-00-25/135-80  
 228-00-13/135-80

**923847-0-00**

Largh. costa }  
 Width of bight } 7 mm  
 Largeur du surjet }  
 Ueberwendlichbreite }

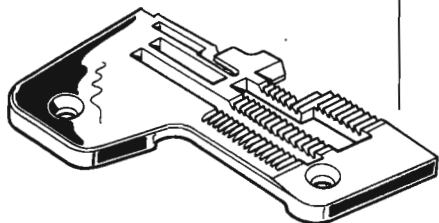

Serve per  
 Serves for  
 Pour machines  
 Dient fuer

327-00-1CD-30/135-81  
 327-00-1MD-33/135-81  
 028-00-25/135-80  
 228-00-13/135-80

**923849-0-00**

Largh. costa }  
 Width of bight } 3,1 mm  
 Largeur du surjet }  
 Ueberwendlichbreite }

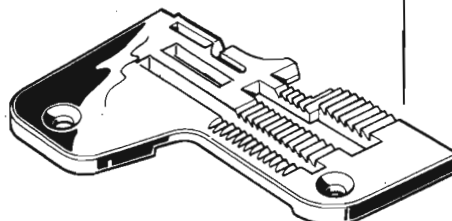

Serve per  
 Serves for  
 Pour machines  
 Dient fuer

327-00-1CD-30/135-81  
 327-00-1MD-33/135-81  
 028-00-25/135-80  
 228-00-13/135-80

Si rende noto che il contenuto della presente tavola  
 non può essere riprodotto o utilizzato in alcun modo  
 senza il permesso scritto della Rimoldi S.p.A.  
 Le macchine di cui è indicata la serie e i tipi sono  
 marchi registrati della Rimoldi S.p.A. e sono integrati  
 nei disegni con i simboli della Rimoldi S.p.A. per  
 stressare l'importanza di utilizzare i suoi prodotti in  
 conformità delle norme di legge.

modificata

Indice	Data	V.



**Rumoldi**

PLACCA AGO

NEEDLE PLATE

PLAQUE AIGUILLE

STICHPLATTE

Indice		TAB	<b>R300</b>
00			
Data 1-73		Foglio 51	Segue F.52

**923850-0-00**

Largh. costa  
Width of bight  
Largeur du surjet  
Ueberwendlichbreite } 1,2 mm

Serve per  
Serves for  
Pour machines  
Dient fuer

327-00-1CD-07/135-81  
028-00-03/135-80  
228-00-05/135-80

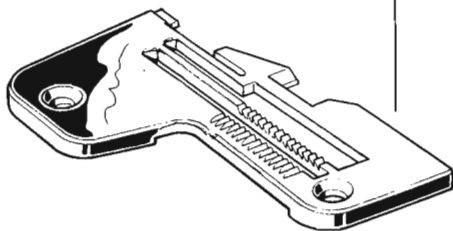
**923852-0-00**

Largh. costa  
Width of bight  
Largeur du surjet  
Ueberwendlichbreite } 3,8 mm

Serve per  
Serves for  
Pour machines  
Dient fuer

327-00-1CD-31/135-81  
228-00-15/135-80

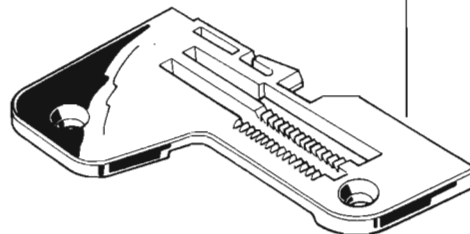
**923851-0-00**

Largh. costa  
Width of bight  
Largeur du surjet  
Ueberwendlichbreite } 2,8 mm

Serve per  
Serves for  
Pour machines  
Dient fuer

327-00-1CD-07/135-81  
028-00-03/135-80  
228-00-05/135-80

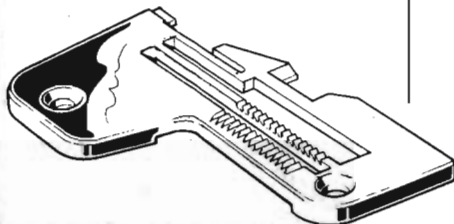
**923853-0-00**

Largh. costa  
Width of bight  
Largeur du surjet  
Ueberwendlichbreite } 1,5 mm

Serve per  
Serves for  
Pour machines  
Dient fuer

327-28-1CD-11/135-81  
028-00-08/135-80  
228-00-07/135-80

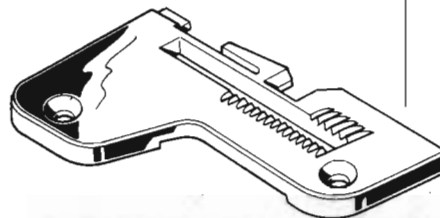

Si rende noto che il contenuto della presente tavola non potrà essere utilizzato o riprodotto senza permesso scritto dalla proprietaria S.p.A. V. F. 2, D.I. & C. La stessa intende tutelare i suoi diritti e norma di legge.



**Rimoldi**

PLACCA AGO

NEEDLE PLATE

PLAQUE AIGUILLE

STICHPLATTE

Indice	TAB	<b>R300</b>
00		
Data 1-73	Foglio 53	Segue F.54

**923863-0-00**

Largh. costa  
Width of bight  
Largeur du surjet  
Ueberwendlichbreite } 3 mm

Serve per  
Serves for  
Pour machines  
Dient fuer

327-00-2CD-34/135-81/137-81  
327-00-2CD-12/135-81  
028-00-09/135-80/137-80  
228-00-09/135-80/137-80

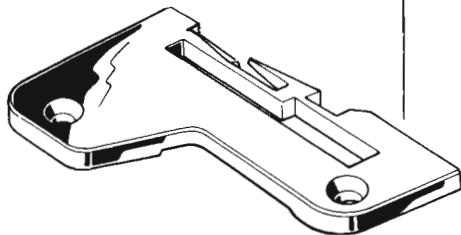
**923865-0-00**

Largh. costa  
Width of bight  
Largeur du surjet  
Ueberwendlichbreite } 4,5 mm

Serve per  
Serves for  
Pour machines  
Dient fuer

327-00-2CD-13/135-81/137-81  
028-00-10/135-80/137-80  
228-00-10/135-80/137-80

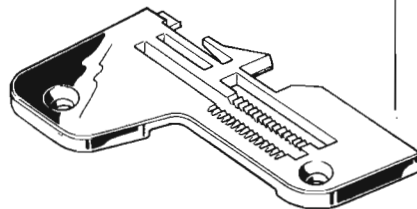
**923864-0-00**

Largh. costa  
Width of bight  
Largeur du surjet  
Ueberwendlichbreite } 2,5 mm

Serve per  
Serves for  
Pour machines  
Dient fuer

327-00-2CD-34/135-81/137-81  
327-00-2CD-12/135-81  
028-00-09/135-80/137-80  
228-00-09/135-80/137-80

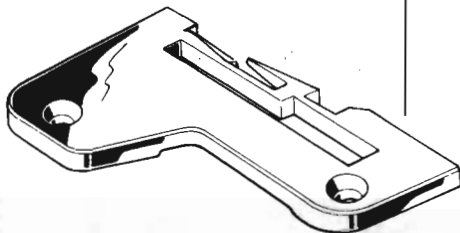
**923866-0-00**

Largh. costa  
Width of bight  
Largeur du surjet  
Ueberwendlichbreite } 3,5 mm

Serve per  
Serves for  
Pour machines  
Dient fuer

327-00-2CD-13/135-81/137-81  
028-00-10/135-80/137-80  
228-00-10/135-80/137-80

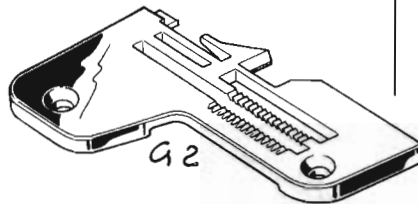

Indice  
Data  
Vr

Si rende noto che il contenuto della presente tavola non potrà essere utilizzato o rappresentato né comunque divulgato a terzi o riprodotto sia integralmente sia in parte senza il permesso scritto della stessa. La stessa intende tutelare i suoi diritti in forma di legge.



**Rimoldi**

PLACCA AGO

NEEDLE PLATE

PLAQUE AIGUILLE

STICHPLATTE

Indice  
00

TAB

**R300**

Data 1-73 Foglio 55 Segue F.56

**923878-0-00**

Largh. costa  
Width of bight  
Largeur du surjet  
Ueberwendlichbreite } 5,2 mm

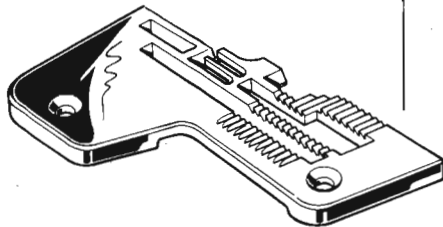

Serve per  
Serves for  
Pour machines  
Dient fuer

327-00-2CD-41/135-81

**923882-0-00**

Largh. costa  
Width of bight  
Largeur du surjet  
Ueberwendlichbreite } 6,5 mm

*25  
65  
9/8*

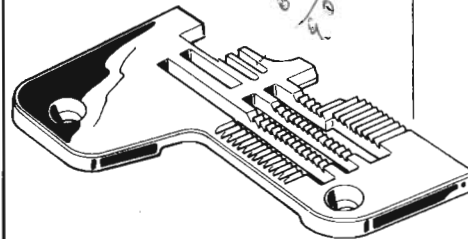

Serve per  
Serves for  
Pour machines  
Dient fuer

327-00-2MD-36/135-81  
028-00-16/135-80**923881-0-00**

Largh. costa  
Width of bight  
Largeur du surjet  
Ueberwendlichbreite } 5,5 mm

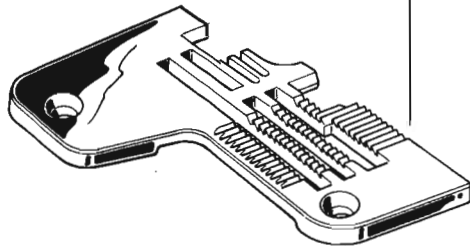

Serve per  
Serves for  
Pour machines  
Dient fuer

327-00-2MD-36/135-81  
028-00-16/135-80**923883-0-00**

Largh. costa  
Width of bight  
Largeur du surjet  
Ueberwendlichbreite } 7,5 mm

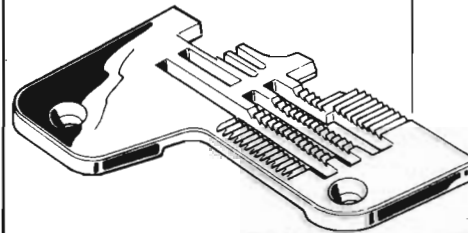

Serve per  
Serves for  
Pour machines  
Dient fuer

327-00-2MD-36/135-81  
028-00-16/135-80

Si rende noto che il contenuto della presente tavola non potrà essere utilizzato o rappresentato, né conosciuta o pubblicata, senza l'autorizzazione scritta della proprietaria S.p.A. V. F. e C. Le stesse intendono tutelare i suoi diritti.





**Rimoldi**

PLACCA AGO

NEEDLE PLATE

PLAQUE AIGUILLE

STICHPLATTE

Indice	TAB	<b>R300</b>
00		
Data 1-73	Foglio 57	Segue F.58

**923891-0-00**

Largh. costa  
Width of bight  
Largeur du surjet  
Ueberwendlichbreite } 7 mm

Serve per  
Serves for  
Pour machines  
Dient fuer

327-00-1 CD-06/135-81  
327-00-1 MD-23/135-81  
028-00-18/135-80

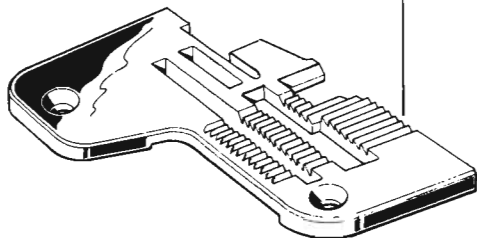
**923894-0-00**

Largh. costa  
Width of bight  
Largeur du surjet  
Ueberwendlichbreite } 5,5 mm

Serve per  
Serves for  
Pour machines  
Dient fuer

327-28-1 CU-06/135-81  
028-28-05/135-80  
028-28-06/135-80  
228-28-05/135-80  
228-28-06/135-80

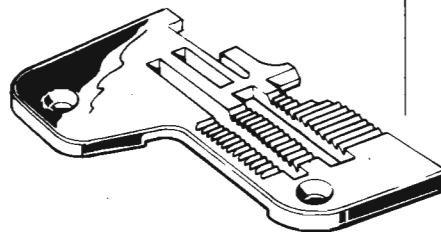
**923892-0-00**

Largh. costa  
Width of bight  
Largeur du surjet  
Ueberwendlichbreite } 3,5 mm

Serve per  
Serves for  
Pour machines  
Dient fuer

327-28-1 CU-04/135-81  
028-28-03/135-80  
028-28-04/135-80  
228-28-03/135-80  
228-28-04/135-80

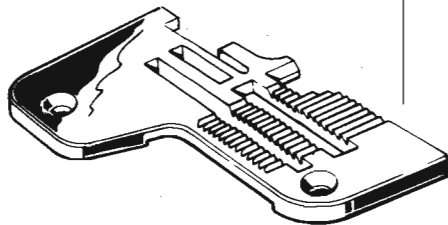
**923895-0-00**

Largh. costa  
Width of bight  
Largeur du surjet  
Ueberwendlichbreite } 6,5 mm

Serve per  
Serves for  
Pour machines  
Dient fuer

327-28-1 CU-04/135-81  
327-28-1 CU-06/135-81  
028-28-05/135-80  
028-28-06/135-80  
228-28-05/135-80  
228-28-06/135-80

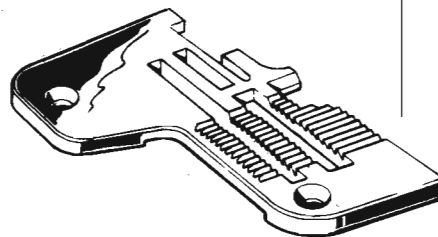

Si rende noto che il contenuto della presente tavola non potrà essere utilizzato o rappresentato né come disegni né come fotografie senza l'autorizzazione scritta della proprietaria S.p.A. V. L. D. I. & C. La stessa intende tutelare i suoi diritti e le forme di legge.

**923897-0-00**

Largh. costa  
Width of bight  
Largeur du surjet } 5,5 mm  
Ueberwendlichbreite

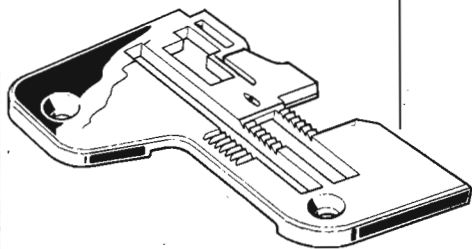

Serve per  
Serves for  
Pour machines  
Dient fuer

329-00-2CD-01/136-81

**923899-0-00**

Largh. costa  
Width of bight  
Largeur du surjet } 5 mm  
Ueberwendlichbreite

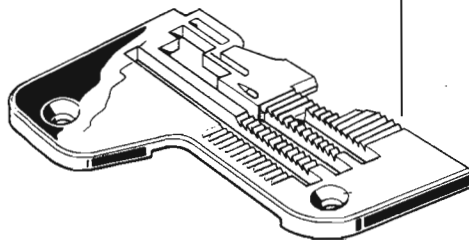

Serve per  
Serves for  
Pour machines  
Dient fuer

329-00-2CD-07/136-81  
329-22-2CD-04/136-81

**923898-0-00**

Largh. costa  
Width of bight  
Largeur du surjet } 5,5 mm  
Ueberwendlichbreite

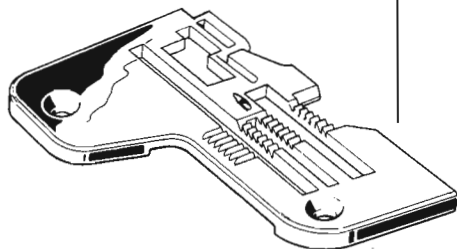

Serve per  
Serves for  
Pour machines  
Dient fuer

329-00-2CD-06/136-81  
329-00-2CD-10/136-81

**923903-0-00**

Largh. costa  
Width of bight  
Largeur du surjet } 3,5 mm  
Ueberwendlichbreite

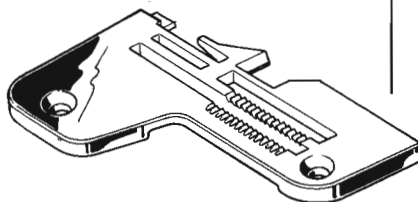

Serve per  
Serves for  
Pour machines  
Dient fuer

327-00-2CD-38/135-81/137-81

Si rende noto che il contenuto della presente tavola non potrà essere utilizzato o rappresentato né con alcun titolo, né in alcuna forma, senza permesso scritto dalla Rumoldi S.p.A. V. Piave, 11 - 36010 - Biadene di Tezze (PD) - Italia. In caso contrario, si sono riservati i diritti di legge.

modifiche	Indice
Date	
V/	

**Rimoldi**

PLACCA AGO

NEEDLE PLATE

PLAQUE AIGUILLE

STICHPLATTE

Index		TAB	<b>R300</b>
00			
Data 1-73		Foglio 59	Segue F.60

**923904-0-00**

Largh. costa  
Width of bight  
Largeur du surjet  
Ueberwendlichbreite } 3,5 mm

Serve per  
Serves for  
Pour machines  
Dient fuer

327-00-2CD-38/135-81/137-81

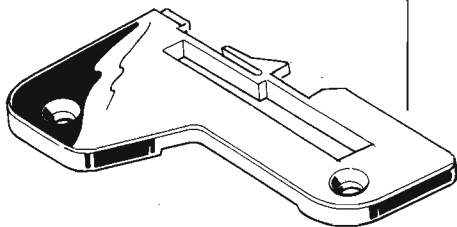
**923908-0-00**

Largh. costa  
Width of bight  
Largeur du surjet  
Ueberwendlichbreite } 3,5 mm

Serve per  
Serves for  
Pour machines  
Dient fuer

329-00-2CD-08/136-81

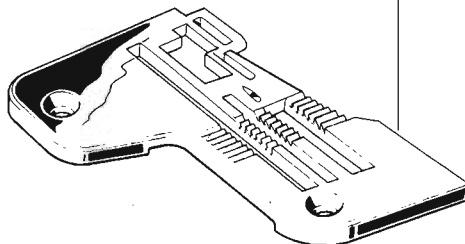
**923908-0-00**

Largh. costa  
Width of bight  
Largeur du surjet  
Ueberwendlichbreite } 5 mm

Serve per  
Serves for  
Pour machines  
Dient fuer

329-00-3MU-01/136-81

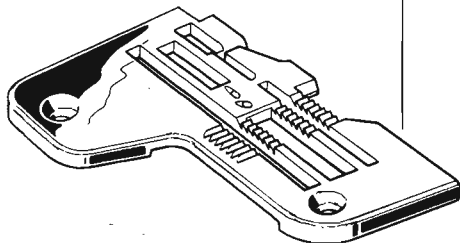
**923911-0-00**

Largh. costa  
Width of bight  
Largeur du surjet  
Ueberwendlichbreite } 3 mm

Serve per  
Serves for  
Pour machines  
Dient fuer

327-00-1CD-25/135-81

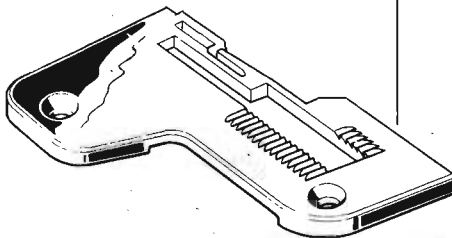



GRIFFA PRINCIPALE  
MAIN FEED DOG  
GRIFFE PRINCIPALE  
HAUPT-TRANSPORTEUR

**Rumoldi**

GRIFFA PRINCIP.

MAIN FEED DOG

GRIFFE PRINCIPALE

HAUPTTRANSPORTEUR

Indice	TAB	<b>R300</b>
Data	Foglio 1	Segue F. 2

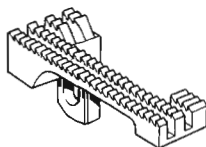
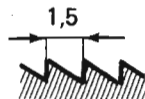
**200758-0-10**

Serve per  
Serves for  
Pour machines  
Dient fuer

023-04-01  
023-04-03  
023-04-04

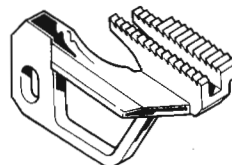
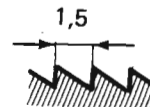
**202053-0-10**

Serve per  
Serves for  
Pour machines  
Dient fuer

327-00-1CD-01  
327-01-1CD-01  
327-01-1CD-02  
327-28-1CD-02  
327-29-1CD-01  
327-29-1CD-02  
327-29-1CD-03  
028-00-01  
028-01-01  
028-01-02  
028-28-01  
028-28-02  
028-29-01  
028-29-02  
028-29-03  
228-00-01  
228-01-01  
228-28-01  
228-28-02  
228-28-12

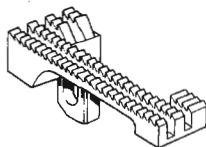
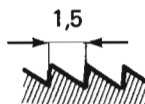
**200782-0-10**

Serve per  
Serves for  
Pour machines  
Dient fuer

023-04-02  
023-04-05

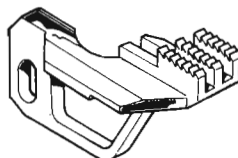
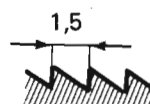
**202054-0-10**

Serve per  
Serves for  
Pour machines  
Dient fuer

327-16-1CD-01  
028-16-01

Indice  
Data  
Vr

modifiche

Si rende noto che il contenuto della presente tavola non potrà essere utilizzato o rappresentato, né commentato, né copiato, né ristampato, né pubblicamente che parzialmente senza l'autorizzazione scritta della proprietaria S.p.A. V.lli. D.L.D.I. & C. La stessa intende tutelare i suoi diritti in conformità di legge.

202056-2-11

Serve per  
Serves for  
Pour machines  
Dient fuer

- 327-00-1CD-01
- 327-01-1CD-01
- 327-01-1CD-02
- 327-29-1CD-01
- 327-29-1CD-02
- 327-00-1CD-01/135-81
- 028-00-01/135-80
- 228-00-01/135-80

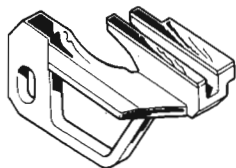

202604-0-10

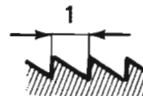

Serve per  
Serves for  
Pour machines  
Dient fuer

327-28-1CD-11

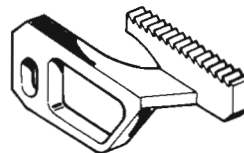

202542-0-10

Serve per  
Serves for  
Pour machines  
Dient fuer

327-34-1CD-01

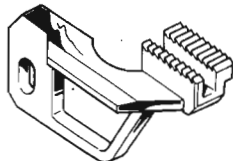
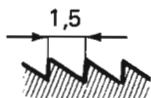

202605-0-10

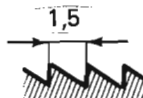

Serve per  
Serves for  
Pour machines  
Dient fuer

- 327-00-1CD-02
- 327-00-1CD-03
- 327-00-1CD-05
- 327-28-1CD-09
- 028-00-04
- 028-00-05
- 028-30-01
- 028-30-02
- 228-00-02
- 228-00-03
- 228-00-14
- 228-28-10

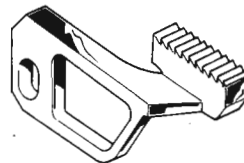

Si rende noto che il contenuto della presente tavola non potrà essere utilizzato o rappresentato né con alcun disegno a testi o a riproduzione senza permesso scritto della proprietaria Sp.A. V. R. I. & C. La stessa intende tutelare i suoi diritti.

modi chr

Indice	Data



**Rumoldi**

GRIFFA PRINCIP.

MAIN FEED DOG

GRIFFE PRINCIPALE

HAUPTTRANSPORTEUR

Indice	TAB	<b>R300</b>
00		
Data	Foglio 3	Segue F. 4

202606-0-10

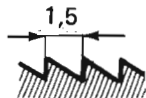

Serve per  
Serves for  
Pour machines  
Dient fuer

327-12-1CD-01

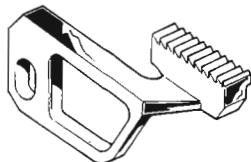

202698-2-11

Serve per  
Serves for  
Pour machines  
Dient fuer

028-00-04  
028-00-05  
028-30-01  
028-30-02  
228-00-02  
228-00-03  
228-00-14  
228-28-10

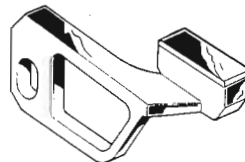

202695-0-10

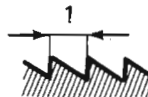

Serve per  
Serves for  
Pour machines  
Dient fuer

327-00-1CD-02  
327-00-1CD-03  
327-00-1CD-05  
327-28-1CD-09  
028-00-04  
028-00-05  
028-30-01  
028-30-02  
228-00-02  
228-00-03  
228-00-14  
228-28-10

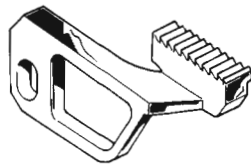

202750-0-10

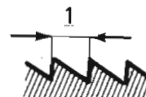

Serve per  
Serves for  
Pour machines  
Dient fuer

028-10-01

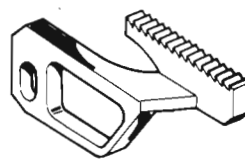

Si rende noto che il contenuto della presente tavola non potrà essere utilizzato o riprodotto, in tutto o in parte, senza il permesso scritto della proprietaria S.p.A. V. L. D. I. & C. La stessa intende tutelare i suoi diritti a norma di legge.

Indice  
Data  
Vr

Modifiche



202757-0-00

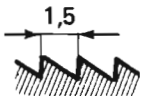

Serve per  
Serves for  
Pour machines  
Dient fuer

327-00-1CD-01  
327-28-1CD-02

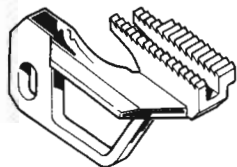

202780-0-10

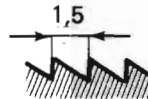

Serve per  
Serves for  
Pour machines  
Dient fuer

327-10-1CD-02  
327-10-1CD-06  
327-11-1CD-01  
327-11-1CD-02  
028-10-02  
028-10-03  
028-10-04  
028-10-05  
028-11-01  
228-10-01  
228-10-05  
228-10-06  
228-10-07

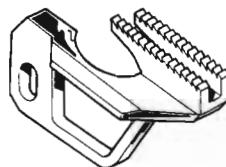

202761-0-10

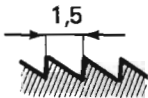

Serve per  
Serves for  
Pour machines  
Dient fuer

327-28-1CU-04  
028-28-03  
028-28-04  
228-28-03  
228-28-04

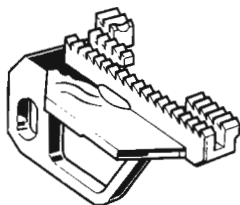

202781-0-10

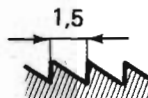

Serve per  
Serves for  
Pour machines  
Dient fuer

327-10-1CD-03  
327-10-1CD-04  
228-10-02  
228-10-03

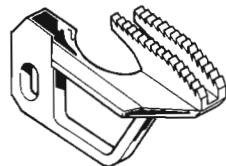

Si vede, nota che il contenuto della presente tavola non potrà essere utilizzato o appropiata né in tutto né in parte, senza il permesso scritto dalla Remoldi S.p.A. in via S. Maria 10, 20122 Milano, Italia. È vietata espressamente la ristampa o l'uso non autorizzato senza il permesso scritto dalla Remoldi S.p.A. in via S. Maria 10, 20122 Milano, Italia. Tutti i diritti sono riservati.

Modifiche

Indice	Data	Vr





**Rimoldi**

GRIFFA PRINCIP.

MAIN FEED DOG

GRIFFE PRINCIPALE

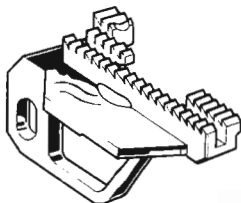
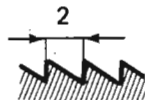
HAUPTTRANSPORTEUR

**202927-0-10**

Serve per  
Serves for  
Pour machines  
Dient fuer

327-28-1 CU-06

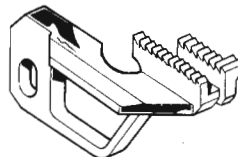
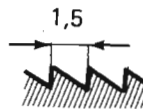
**203028-0-10**

Serve per  
Serves for  
Pour machines  
Dient fuer

327-00-1CD-06  
327-00-1CD-30  
327-00-1MD-23  
327-00-1MD-33  
327-01-1CD-03  
327-01-1CD-06  
327-01-1MD-08  
327-01-1MD-09  
028-00-02  
028-00-25  
028-01-03  
228-00-04  
228-00-13  
228-01-02.

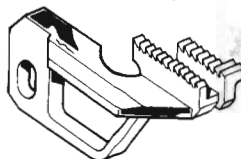
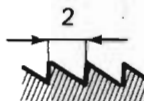
**203001-0-10**

Serve per  
Serves for  
Pour machines  
Dient fuer

327-00-1CD-06  
327-00-1CD-30  
327-00-1MD-23  
327-00-1MD-33  
327-01-1CD-03  
327-01-1MD-08  
327-01-1MD-09  
327-01-1MD-10  
327-34-1MD-02  
327-34-1MD-03  
028-00-18  
028-01-03  
028-01-08  
028-34-01  
228-01-02  
228-34-01

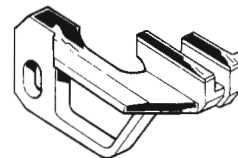
**203030-2-11**

Serve per  
Serves for  
Pour machines  
Dient fuer

327-00-1CD-06  
327-00-1CD-30  
327-00-1MD-23  
327-00-1MD-33  
327-01-1CD-03  
327-01-1MD-08  
327-01-1MD-09

Indice  
Data  
Vr

model: h

Si rende noto che il contenuto della presente tavola è coperto da un brevetto di invenzione. Qualunque ristampa o divulgazione senza l'autorizzazione scritta della Rimoldi S.p.A. è espressamente vietata. La stessa intenzione tutelare i suoi diritti.



203201-2-11

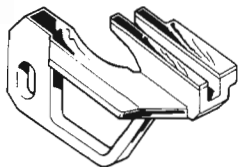

Serve per  
Serves for  
Pour machines  
Dient fuer

- 327-00-1CD-07
- 327-00-1CD-31
- 327-01-1CD-04
- 327-29-1CD-05
- 327-29-1CD-06

203332-0-10

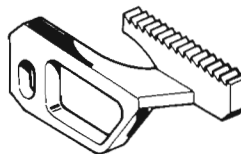
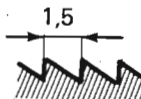

Serve per  
Serves for  
Pour machines  
Dient fuer

- 327-00-1CD-10
- 327-28-1CD-11
- 028-00-07
- 028-00-08
- 228-00-07
- 228-00-08

203270-0-10

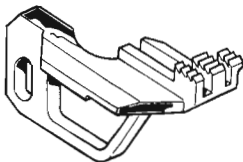
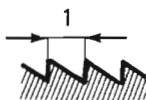

Serve per  
Serves for  
Pour machines  
Dient fuer

- 327-22-1CD-04
- 327-22-1CD-05
- 327-23-1CD-08

203335-2-11

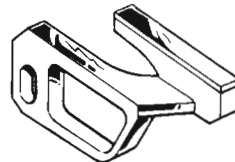

Serve per  
Serves for  
Pour machines  
Dient fuer

- 327-00-1CD-09
- 327-00-1CD-39
- 327-28-1CD-07
- 028-00-06
- 028-28-07
- 228-00-06
- 228-00-17
- 228-28-07

Indice  
Data  
Vr

modell

Si rende noto che il contenuto della presente tavola non potrà essere utilizzato o rappresentato né come merce divulgata a terzi o riprodotto sia integralmente sia in parte, senza il permesso scritto della Remold S.p.A. La stessa intende tutelare i suoi diritti e la propria fama di legge.

**203419-2-11**

Serve per  
Serves for  
Pour machines  
Dient fuer

327-00-2CD-12  
327-00-2CD-34  
327-00-2CD-38  
327-00-2CD-44  
028-00-09  
228-00-09  
327-00-2CD-38/135-81/137-81

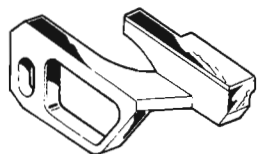
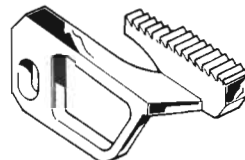
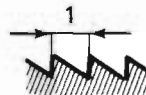
**203497-0-10**

Serve per  
Serves for  
Pour machines  
Dient fuer

327-00-2CD-12  
327-00-2CD-34  
327-00-2CD-44

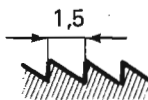
**203421-0-10**

Serve per  
Serves for  
Pour machines  
Dient fuer

327-00-2CD-13  
327-00-2CD-38  
028-00-10  
228-00-10

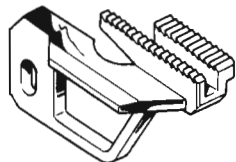
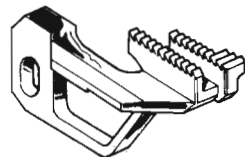
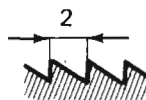
**203532-0-10**

Serve per  
Serves for  
Pour machines  
Dient fuer

327-00-2CD-32  
327-00-2MD-37  
327-01-2CD-13

Indice	Date	Vr



203533-0-10

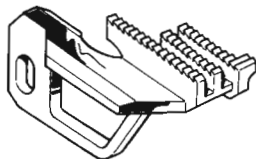
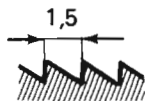

Serve per  
Serves for  
Pour machines  
Dient fuer

327-00-2CD-15  
327-00-2CD-45  
327-01-2CD-10  
028-00-12

203538-0-10

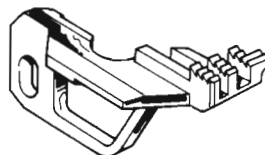
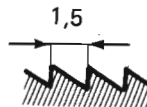

Serve per  
Serves for  
Pour machines  
Dient fuer

327-00-2CD-39  
327-22-2CD-06  
327-23-2CD-06

203536-0-10

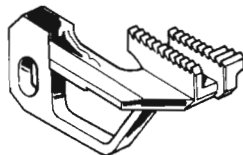
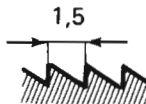

Serve per  
Serves for  
Pour machines  
Dient fuer

327-00-2CD-16  
327-00-2CD-41  
028-00-13

203607-2-11

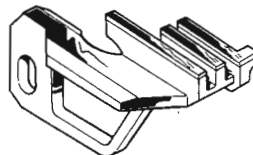

Serve per  
Serves for  
Pour machines  
Dient fuer

327-00-2CD-17  
327-00-2CD-18  
327-00-2CD-35  
327-00-2MD-36  
327-01-2CD-05  
327-01-2CD-06  
327-01-2MD-11  
028-00-14  
028-00-15  
028-00-16  
028-01-06  
028-01-05

Si rende noto che il contenuto della presente tavola non potrà essere utilizzato o rappresentato, né copiato, né ristampato, né divulgato, né autorizzato senza il permesso scritto della proprietaria S.p.A. V. L. Rumoldi & C. La stessa intende tutelare i suoi diritti secondo la norma di legge.

indice  
Data  
Vr.  
modifiche

203608-0-10

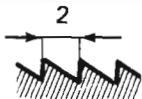

Serve per  
Serves for  
Pour machines  
Dient fuer

327-00-2CD-35

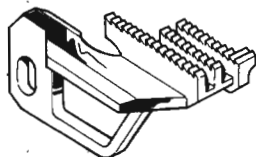

203668-0-11

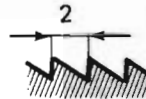

Serve per  
Serves for  
Pour machines  
Dient fuer

327-00-2CD-15  
327-00-2CD-18  
327-00-2MD-36  
327-01-2CD-06  
327-01-2MD-11

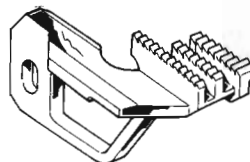

203651-0-11

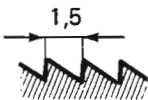

Serve per  
Serves for  
Pour machines  
Dient fuer

327-00-2CD-17  
327-00-2CD-18  
327-00-2CD-35  
327-00-2MD-20  
327-00-2MD-21  
327-00-2MD-36  
327-01-2CD-05  
327-01-2CD-06  
327-01-2MD-07  
327-01-2MD-11  
028-00-14  
028-00-15  
028-00-16  
028-00-17  
028-01-05  
028-01-06  
028-01-07

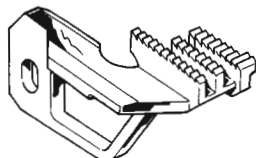

203746-0-10

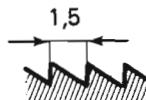

Serve per  
Serves for  
Pour machines  
Dient fuer

327-00-1MD-34  
327-22-1CD-01  
327-22-1MD-07  
327-23-1CD-01  
327-23-1MD-07

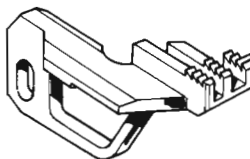

Si rende noto che il contenuto della presente tavola non potrà essere utilizzato o rappresentato, né copiato, né ristampato, né riprodotto in alcun modo senza l'autorizzazione scritta della proprietaria S.p.A. V. R. & C. Le stesse intende tutelare i suoi diritti a norma di legge.

modifiche

Indice	Data
Vr	









Si rende noto che il contenuto della presente tavola non potrà essere utilizzato o riprodotto, né comunque divulgato a terzi o riprodotto, integralmente o parzialmente, senza il permesso scritto della proprietaria S.p.A. V. G. OLDI & C. La stessa intende tutelare i suoi diritti, norma di legge.

**Rimoldi**

**GRIFFA PRINCIP. MAIN FEED DOG GRIFFE PRINCIPALE HAUPTTRANSPORTEUR**

Indice	00					TAB	<b>R300</b>
Data						Foglio 11	Segue F.12

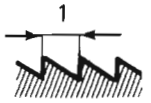
**203805-0-10**



Serve per  
Serves for  
Pour machines  
Dient fuer

028-00-23  
028-30-06

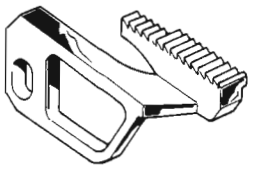

**203840-2-11**

Serve per  
Serves for  
Pour machines  
Dient fuer

227-34-03

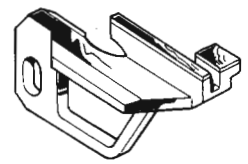

**203838-0-10**

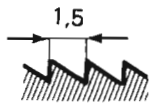

Serve per  
Serves for  
Pour machines  
Dient fuer

227-34-01

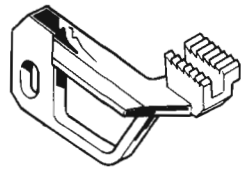

**204061-0-10**

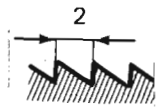

Serve per  
Serves for  
Pour machines  
Dient fuer

327-49-1MD-01

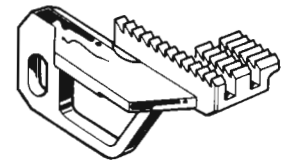



**204322-0-10**

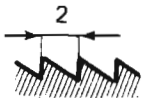

Serve per  
Serves for  
Pour machines  
Dient fuer

028-28-05  
028-28-06  
228-28-05  
228-28-06

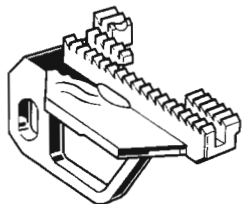

**204425-0-10**

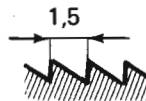

Serve per  
Serves for  
Pour machines  
Dient fuer

228-10-04  
228-10-08

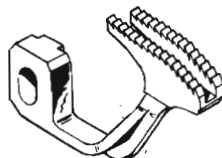

**204375-2-11**

Serve per  
Serves for  
Pour machines  
Dient fuer

228-00-18

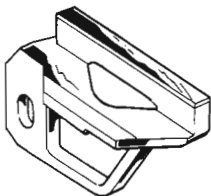

**204520-0-11**

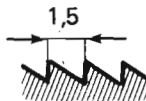

Serve per  
Serves for  
Pour machines  
Dient fuer

028-28-09  
028-29-08  
228-28-09

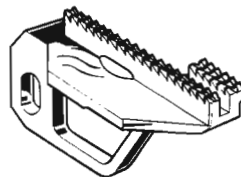

Si vende solo che il contratto della presente tavola non potrà essere utilizzato o appoggiato ad alcun manufatto di cui si sia avvalso il contraente. Si riserva espressamente il diritto di modificare senza preavviso le forme e le dimensioni di questo disegno. Si intende tutelare i suoi diritti in ogni forma di legge.

modifiche

Indice	Data	V./



204541-0-11

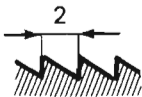

Serve per  
Serves for  
Pour machines  
Dient fuer

028-28-09  
028-29-08  
228-28-09

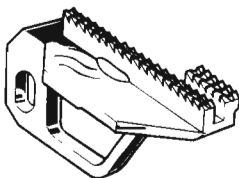

204605-0-11

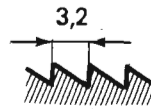

Serve per  
Serves for  
Pour machines  
Dient fuer

028-00-19  
228-00-16

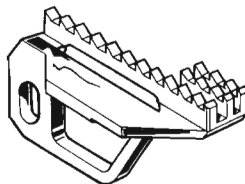

204545-0-11

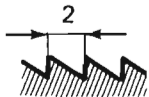

Serve per  
Serves for  
Pour machines  
Dient fuer

028-28-10  
028-28-11  
228-28-08  
228-28-11

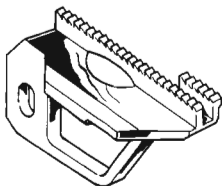

204666-0-10

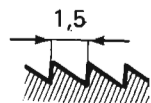

Serve per  
Serves for  
Pour machines  
Dient fuer

329-00-2CD-01

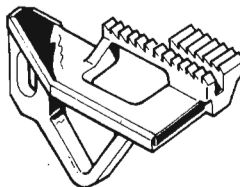

Si rende noto che il contenuto della presente tavola non potrà essere utilizzato o riprodotto senza permesso scritto dalla proprietaria S.p.A. V. GOLDI & C. La stessa intende tutelare i suoi diritti e in forma di legge.

Indice  
Data  
V.

modifiche



**204815-0-10**

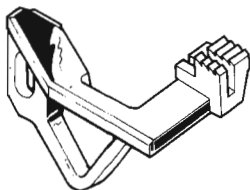
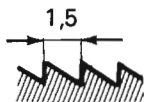

Serve per  
Serves for  
Pour machines  
Dient fuer

329-22-2CD-02  
329-23-2CD-02

**204848-0-10**

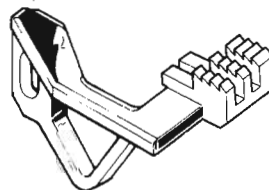
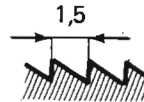

Serve per  
Serves for  
Pour machines  
Dient fuer

329-00-2CD-15  
329-22-2CD-03  
329-23-2CD-03

**204846-0-10**

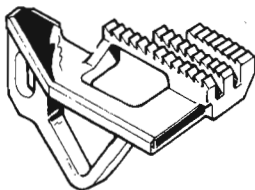
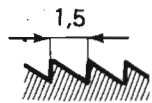

Serve per  
Serves for  
Pour machines  
Dient fuer

329-00-2CD-06  
329-00-2CD-08  
329-00-2CD-12  
329-01-2CD-01

**204849-0-10**

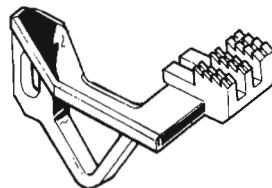
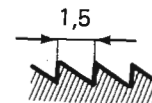

Serve per  
Serves for  
Pour machines  
Dient fuer

329-00-2CD-15  
329-22-2CD-03  
329-23-2CD-03

Indice  
Data  
V.  
modifiche

Si rende noto che il contenuto della presente tavola  
nonche' divulgato, o terzi o riprodotto sia integral-  
mente che parzialmente senza autorizzazione scrit-  
ta della Rumoldi S.p.A. e' espressamente vietato. La  
stessa intende tutelare i suoi diritti in base alla  
norma di legge.



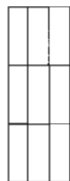

Si rende noto che il contenuto della presente tavola non potrà essere utilizzato o rappresentato né comunque divulgato a terzi o riprodotta integralmente senza il permesso scritto dalla proprietà della proprietaria S.p.A. V. L. S. S. L. D. I. & C. La stessa intende tutelare i suoi diritti e norme di legge.

**Rumoldi**

**GRIFFA PRINCIP.**

**MAIN FEED DOG**

**GRIFFE PRINCIPALE**

**HAUPTTRANSPORTEUR**

Indice	TAB	<b>R300</b>
00		
Data	Foglio 17	Segue F.18

**205007-0-10**

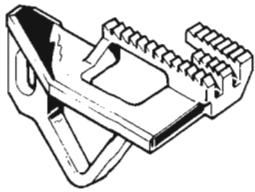
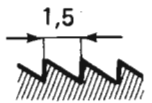

Serve per  
Serves for  
Pour machines  
Dient fuer

- 329-00-2CD-06
- 329-00-2CD-10
- 329-01-2CD-02

**205010-0-10**

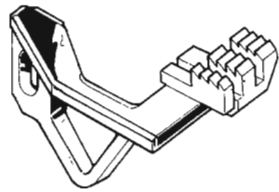
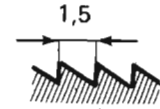

Serve per  
Serves for  
Pour machines  
Dient fuer

- 329-00-2CD-07
- 329-00-2CD-13
- 329-22-2CD-04
- 329-23-2CD-04

**205009-2-11**

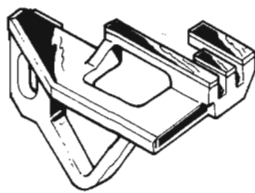

Serve per  
Serves for  
Pour machines  
Dient fuer

- 329-00-2CD-06
- 329-00-2CD-10

**205059-0-10**

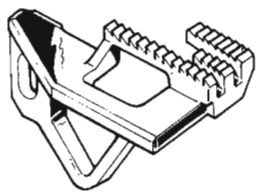
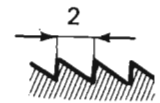

Serve per  
Serves for  
Pour machines  
Dient fuer

- 329-00-2CD-06
- 329-00-2CD-10
- 329-01-2CD-02

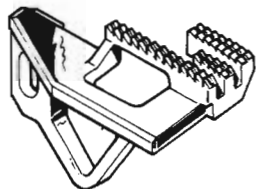
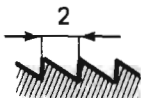
**205060-0-10**

Serve per  
Serves for  
Pour machines  
Dient fuer

329-00-2CD-06  
329-00-2CD-10  
329-01-2CD-02

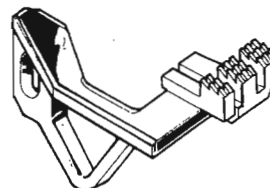
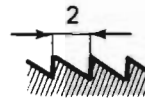
**205062-0-10**

Serve per  
Serves for  
Pour machines  
Dient fuer

329-00-2CD-07  
329-00-2CD-13  
329-22-2CD-04  
329-23-2CD-04

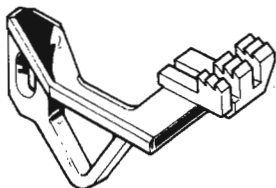
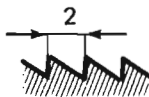
**205061-0-10**

Serve per  
Serves for  
Pour machines  
Dient fuer

329-00-2CD-07  
329-00-2CD-13  
329-22-2CD-04  
329-23-2CD-04

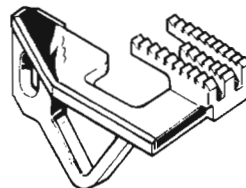
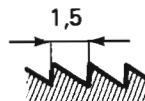
**205138-0-10**

Serve per  
Serves for  
Pour machines  
Dient fuer

330-00-1CD-01

modifiche

V.	Data	Indice

**Rimoldi**

**GRIFFA PRINCIP.**

**MAIN FEED DOG**

**GRIFFE PRINCIPALE**

**HAUPTTRANSPORTEUR**

Indice	TAB	<b>R300</b>
00		
Data	Foglio 19	Segue F.20

**205205-0-10**

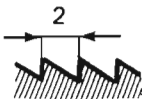

Serve per  
Serves for  
Pour machines  
Dient fuer

330-00-1CD-02

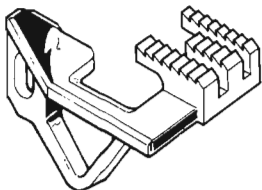

**205240-0-10**

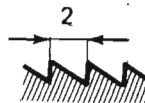

Serve per  
Serves for  
Pour machines  
Dient fuer

330-00-1CD-03

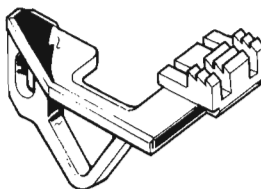

**205221-0-10**

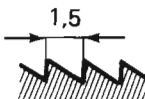

Serve per  
Serves for  
Pour machines  
Dient fuer

330-00-1CD-02

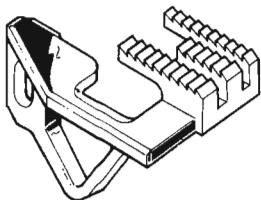

**205241-0-10**

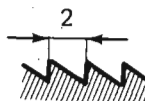

Serve per  
Serves for  
Pour machines  
Dient fuer

330-00-1CD-03

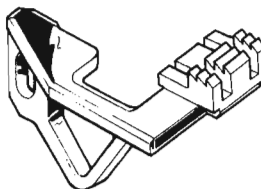

Si rende noto che il contenuto della presente tavola  
 non può essere riprodotto, né in tutto, né in parte,  
 in qualunque modo, senza permesso scritto dalla  
 proprietaria S.p.A. Rimoldi S.p.A. Le  
 stesse intenzioni, tuttavia, si sono diritte, norma di legge.

modiche  
 Vr  
 Data  
 Indica





**Remoldi****GRIFFA PRINCIP.****MAIN FEED DOG****GRIFFE PRINCIPALE****HAUPTTRANSPORTEUR**

00	Indice	TAB	<b>R300</b>
Data	Foglio 21   Segue F.22		

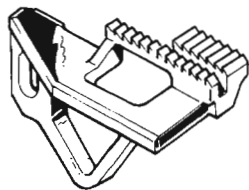
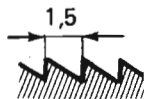
**205539-0-00**
 Serve per  
 Serves for  
 Pour machines  
 Dient fuer

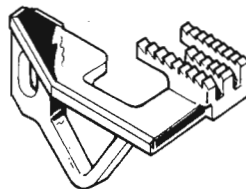
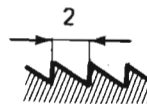
**329-00-2CD-03**  
**329-00-2CD-09**
**205702-0-00**
 Serve per  
 Serves for  
 Pour machines  
 Dient fuer

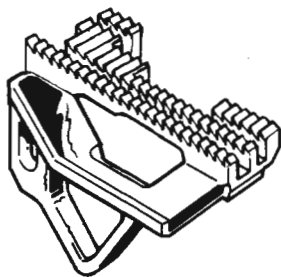
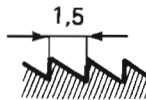
**330-00-1CD-04**
**205615-0-00**
 Serve per  
 Serves for  
 Pour machines  
 Dient fuer

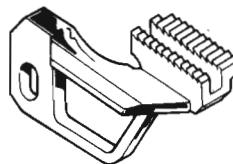
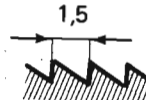
**329-22-2CD-03**
**205951-0-00**
 Serve per  
 Serves for  
 Pour machines  
 Dient fuer

**327-30-1CD-07**

Si rende noto che il contenuto della presente tavola  
 è di proprietà esclusiva della Remoldi S.p.A. e non può  
 essere divulgato a terzi o riprodotto sia integral-  
 mente che parzialmente senza l'autorizzazione scrit-  
 ta della Remoldi S.p.A. La Remoldi S.p.A. si riserva  
 la stessa intenzione tutelare i suoi diritti secondo la  
 norma di legge.

 indice  
 Data  
 Vr  
 modifichè



**Rumold**

GRIFFA PRINCIP.

MAIN FEED DOG

GRIFFE PRINCIPALE

HAUPTTRANSPORTEUR

Indice

TAB

**R300**

00

Foglio 23 | Segue F.24

206298-0-00

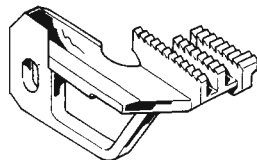
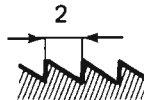

Serve per  
Serves for  
Pour machines  
Dient fuer

327-00-2CD-14  
327-00-2CD-17  
327-00-2CD-18  
327-00-2MD-20  
327-00-2MD-21  
327-00-2MD-36  
327-01-2CD-05  
327-01-2CD-06  
327-01-2CD-12  
328-01-2MD-07  
327-01-2MD-11  
028-00-11  
028-00-14  
028-00-15  
028-00-16  
028-00-17  
028-01-05  
028-01-06  
028-01-07

207052-0-00

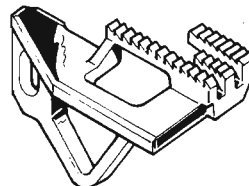
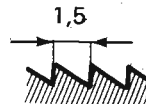

Serve per  
Serves for  
Pour machines  
Dient fuer

329-00-2CD-06

207048-0-00

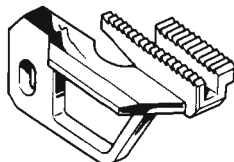
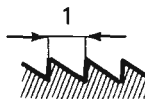

Serve per  
Serves for  
Pour machines  
Dient fuer

327-00-2CD-13  
327-00-2CD-38  
028-00-10  
228-00-10

920802-0-10

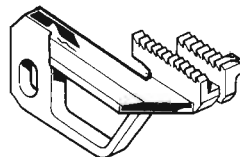
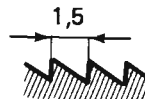

Serve per  
Serves for  
Pour machines  
Dient fuer

327-00-1CD-06/103-90  
327-00-1CD-30/103-90  
028-00-02/103-90  
028-00-25/103-90  
228-00-04/103-90  
228-00-13/103-90

Indice  
Data  
Vr

Si rende noto che il contenuto della presente tavola non potrà essere utilizzato o rappresentato né con mezzi meccanici né con altri procedimenti senza l'autorizzazione scritta della proprietaria S.p.A. V. L. S. L. D. I. & C. La stessa intende tutelare i suoi diritti e norme di legge.

**920830-0-00**

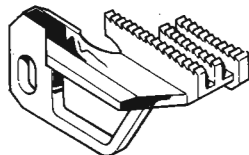
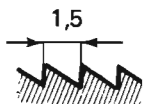

Serve per  
Serves for  
Pour machines  
Dient fuer

327-00-2CD-15/108-91  
327-00-2CD-17/108-91  
327-00-2CD-18/108-91  
327-00-2MD-21/108-91  
327-00-2MD-36/108-91  
028-00-12/108-90  
028-00-14/108-90  
028-00-15/108-90  
028-00-16/108-90

**920850-0-00**

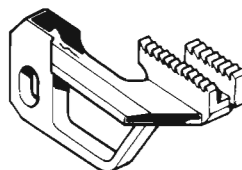
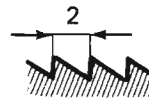

Serve per  
Serves for  
Pour machines  
Dient fuer

327-00-2CD-32/108-91

**920831-0-00**

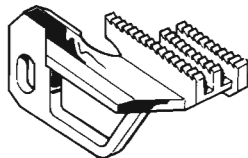
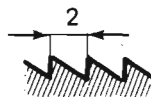

Serve per  
Serves for  
Pour machines  
Dient fuer

327-00-2CD-14/108-91  
327-00-2CD-15/108-91  
327-00-2CD-17/108-91  
327-00-2CD-18/108-91  
327-00-2MD-21/108-91  
327-00-2MD-36/108-91  
028-00-11/108-90  
028-00-14/108-90  
028-00-15/108-90  
028-00-16/108-90

**920856-0-00**

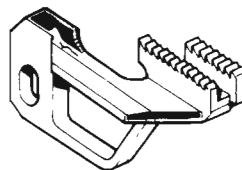
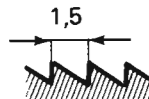

Serve per  
Serves for  
Pour machines  
Dient fuer

327-00-2CD-16/108-91  
028-00-13/108-90

modifiche

V.	Data	Indice

Si rende noto che il contenuto della presente tavola non è vincolante per le macchine di cui è parte integrante, e che il presente disegno non è da considerarsi come un documento tecnico, ma solo come un mezzo di comunicazione. Le modifiche apportate a questo disegno, senza il consenso scritto dell'ingegnere, non sono valide. Sono riservati i diritti di legge.

**Remoldi**

GRIFFA PRINCIP.

MAIN FEED DOG

GRIFFE PRINCIPALE

HAUPTTRANSPORTEUR

Indice	TAB	<b>R300</b>
00		
Data	Foglio 25	Segue F.---

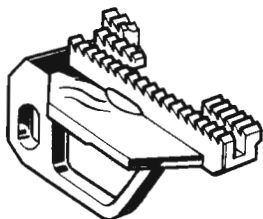
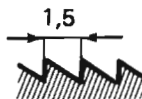
**921392-0-00**

Serve per  
Serves for  
Pour machines  
Dient fuer

327-28-1CU-04/135-81  
028-28-03/135-80  
028-28-04/135-80  
228-28-03/135-80  
228-28-04/135-80

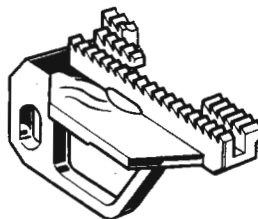
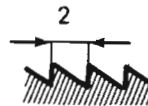
**923896-0-00**

Serve per  
Serves for  
Pour machines  
Dient fuer

028-28-05/135-80  
028-28-06/135-80  
228-28-05/135-80  
228-28-06/135-80

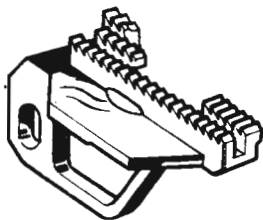
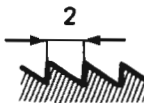
**923893-0-00**

Serve per  
Serves for  
Pour machines  
Dient fuer

327-28-1CU-06/135-81

Serve per  
Serves for  
Pour machines  
Dient fuer

Indice	
Data	
Vr	

modifiche

Si rende noto che il contenuto della presente tavola non potrà essere utilizzato o rappresentato né copiato, duplicato o terzi o riprodotto sia integralmente che parzialmente senza il permesso scritto della proprietaria S.p.A. V. S. 11, D. 8. C. La stessa intende tutelare i suoi diritti, forme di legge.

Rundlauf

GRIFFA PRINCIPAL

MAIN FEED DOG

GRIFFE PRINCIPALE

HAUPTTRANSPORTREUR

R 300

933892-0-00



Dient fuer  
Four machines  
Serves for  
Serves for

337-58-10U-04V138-81  
028-58-03V138-80  
028-58-04V138-80  
328-58-03V138-80  
328-58-04V138-80

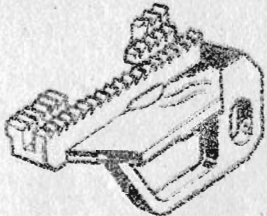

933893-0-00



Dient fuer  
Four machines  
Serves for  
Serves for

337-58-10U-04V138-81



933892-0-00

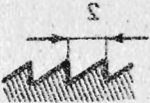

Dient fuer  
Four machines  
Serves for  
Serves for

328-58-08V138-80  
328-58-08V138-80  
028-58-08V138-80  
028-58-08V138-80



Dient fuer  
Four machines  
Serves for  
Serves for



1. 2. 3. 4. 5. 6. 7. 8. 9. 10. 11. 12. 13. 14. 15. 16. 17. 18. 19. 20. 21. 22. 23. 24. 25. 26. 27. 28. 29. 30. 31. 32. 33. 34. 35. 36. 37. 38. 39. 40. 41. 42. 43. 44. 45. 46. 47. 48. 49. 50. 51. 52. 53. 54. 55. 56. 57. 58. 59. 60. 61. 62. 63. 64. 65. 66. 67. 68. 69. 70. 71. 72. 73. 74. 75. 76. 77. 78. 79. 80. 81. 82. 83. 84. 85. 86. 87. 88. 89. 90. 91. 92. 93. 94. 95. 96. 97. 98. 99. 100.

GRIFFA SUSSIDIARIA  
AUXILIARY FEED DOG  
GRIFFE SUBSIDIAIRE  
HILFS-TRANSPORTEUR



202057-0-10

Serve per  
Serves for  
Pour machines  
Dient fuer

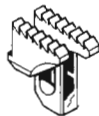
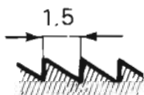

327-00-1CD-01  
327-00-1CD-07  
327-00-1CD-31  
327-01-1CD-01  
327-01-1CD-02  
327-01-1CD-04  
327-01-1CD-05  
327-28-1CD-02  
327-29-1CD-01  
327-29-1CD-02  
327-29-1CD-03  
327-29-1CD-04  
327-29-1CD-05  
327-29-1CD-06

202060-2-11

Serve per  
Serves for  
Pour machines  
Dient fuer

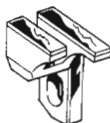

327-00-1CD-01  
327-00-1CD-07  
327-00-1CD-31  
327-01-1CD-01  
327-01-1CD-02  
327-01-1CD-04  
327-29-1CD-01  
327-29-1CD-02  
327-29-1CD-05  
327-29-1CD-06  
  
327-00-1CD-01/135-81  
028-00-01/135-80  
228-00-01/135-80

202608-0-10

Serve per  
Serves for  
Pour machines  
Dient fuer

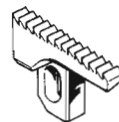
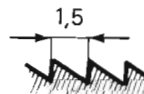

327-00-1CD-02  
327-00-1CD-03  
327-00-1CD-05  
327-12-1CD-01  
327-28-1CD-09

202058-0-10

Serve per  
Serves for  
Pour machines  
Dient fuer

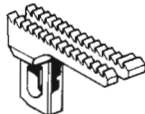
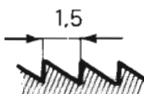

327-16-1CD-01  
028-16-01

202607-0-10

Serve per  
Serves for  
Pour machines  
Dient fuer

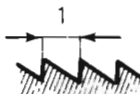

327-28-1CD-11

202699-0-10

Serve per  
Serves for  
Pour machines  
Dient fuer

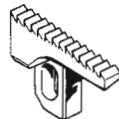
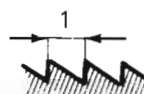

327-00-1CD-02  
327-00-1CD-03  
327-00-1CD-05  
327-28-1CD-09

Si rende noto che il contenuto della presente tavola  
 non è da considerarsi un contratto, ma solo un  
 memento che parzialmente senza pregiudizio della  
 proprietà S.p.A. Rumoldi & C. La  
 stessa intende tutelare i suoi diritti.

202758-0-00

Serve per  
 Serves for  
 Pour machines  
 Dient fuer

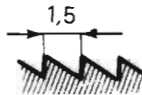

327-00-1CD-01  
 327-28-1CD-02

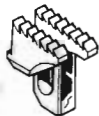

203002-0-10

Serve per  
 Serves for  
 Pour machines  
 Dient fuer

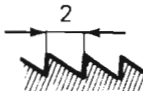

327-00-1CD-06  
 327-00-1CD-30  
 327-00-1MD-23  
 327-00-1MD-33  
 327-01-1CD-03  
 327-01-1MD-08  
 327-01-1MD-09  
 327-01-1MD-10  
 327-01-1MD-09  
 327-34-1MD-03  
 028-01-03  
 228-01-02

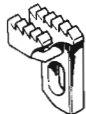

203033-2-11

Serve per  
 Serves for  
 Pour machines  
 Dient fuer

327-00-1CD-06  
 327-00-1CD-30  
 327-00-1MD-23  
 327-00-1MD-33  
 327-01-1CD-03  
 327-01-1MD-08  
 327-01-1MD-09

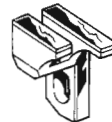

202782-0-10

Serve per  
 Serves for  
 Pour machines  
 Dient fuer

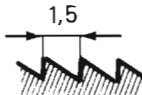

327-10-1CD-02  
 327-10-1CD-03  
 327-10-1CD-04  
 327-10-1CD-06  
 327-11-1CD-01  
 327-11-1CD-02

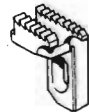

203031-0-10

Serve per  
 Serves for  
 Pour machines  
 Dient fuer

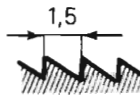

327-00-1CD-06  
 327-00-1CD-30  
 327-00-1MD-23  
 327-00-1MD-33  
 327-01-1CD-03  
 327-01-1CD-06  
 327-01-1MD-08  
 327-01-1MD-09

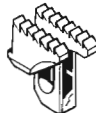

203062-0-10

Serve per  
 Serves for  
 Pour machines  
 Dient fuer

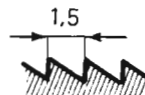

327-00-1CD-10  
 327-00-1CD-25  
 327-00-1CD-26  
 327-00-1CD-27  
 327-00-1CD-29  
 327-28-1CD-11  
 327-29-1CD-08  
 327-49-1MD-01



Si rende noto che il contenuto della presente tavola non potrà essere utilizzato o rappresentato in alcun modo senza permesso scritto dalla proprietaria S.p.A. V. R. Di & C. La stessa intende tutelare i suoi diritti prima di legge.

|          |  |
|----------|--|
| Indice   |  |
| Data     |  |
| Foglio   |  |
| Sequenza |  |
| F. 3     |  |

**Rimoldi****GRIFFA SUSSID. SUBSIDIARY FEED DOG GRIFFE SUBSIDIAIRE HILFSTRANSPORTEUR**

|        |          |            |  |
|--------|----------|------------|--|
| Indice | R300     |            |  |
| 00     |          |            |  |
| Data   | Foglio 3 | Segue F. 4 |  |

**203094-2-00**
 Serve per  
 Serves for  
 Pour machines  
 Dient fuer

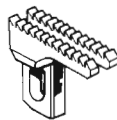
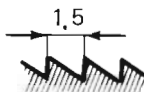
 327-00-1CD-25  
 327-00-1CD-26  
 327-00-1CD-27  
 327-00-1CD-29  
 327-29-1CD-08
**203265-0-10**
 Serve per  
 Serves for  
 Pour machines  
 Dient fuer

327-34-1CD-01

**203338-2-11**
 Serve per  
 Serves for  
 Pour machines  
 Dient fuer

 327-00-1CD-09  
 327-00-1CD-39  
 327-28-1CD-07
**203141-0-10**
 Serve per  
 Serves for  
 Pour machines  
 Dient fuer

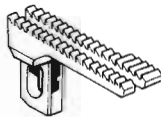
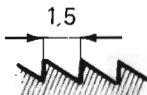
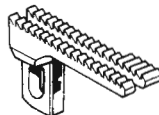
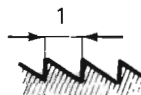
 327-00-1CD-32  
 327-22-1CD-02  
 327-22-1CD-03  
 327-23-1CD-02
**203271-0-10**
 Serve per  
 Serves for  
 Pour machines  
 Dient fuer

 327-22-1CD-04  
 327-22-1CD-05  
 327-23-1CD-08
**203423-2-11**
 Serve per  
 Serves for  
 Pour machines  
 Dient fuer

 327-00-2CD-12  
 327-00-2CD-34  
 327-00-2CD-38  
 327-00-2CD-44  
 327-00-2CD-38/135-81  
 137-81

Si rende noto che il contenuto della presente tavola non potrà essere utilizzato o rappresentato né in alcun modo divulgato a terzi, o riprodotto o sia integralmente o parzialmente, senza il permesso scritto dalla proprietaria S.p.A. V. I. DI & C. La stessa intende tutelare i suoi diritti e norme di legge.



**203609-0-10**

Serve per  
Serves for  
Pour machines  
Dient fuer

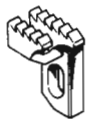
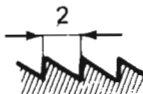

- 327-00-2CD-14
- 327-00-2CD-15
- 327-00-2CD-17
- 327-00-2CD-18
- 327-00-2CD-35
- 327-00-2MD-20
- 327-00-2MD-21
- 327-00-2MD-36
- 327-01-2CD-05
- 327-01-2CD-06
- 327-01-2CD-10
- 327-01-2CD-12
- 327-01-2MD-07
- 327-01-2MD-11
- 028-00-11
- 028-00-14
- 028-00-15
- 028-00-16
- 028-00-17
- 028-01-05
- 028-01-06
- 028-01-07

**203747-0-10**

Serve per  
Serves for  
Pour machines  
Dient fuer

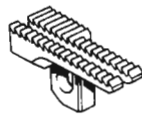
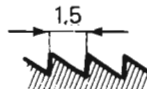

- 327-00-1MD-34
- 327-22-1CD-01
- 327-22-1MD-07
- 327-23-1CD-01
- 327-23-1MD-07

**203843-2-11**

Serve per  
Serves for  
Pour machines  
Dient fuer

**227-34-03**



**203611-2-11**

Serve per  
Serves for  
Pour machines  
Dient fuer



- 327-00-2CD-17
- 327-00-2CD-18
- 327-00-2CD-35
- 327-00-2MD-36
- 327-01-2CD-05
- 327-01-2CD-06
- 327-01-2MD-11
- 028-00-14
- 028-00-15
- 028-00-16
- 028-01-05
- 028-01-06

**203841-0-10**

Serve per  
Serves for  
Pour machines  
Dient fuer

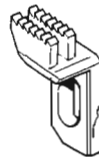
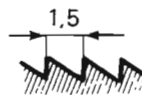

**227-34-01**

**204062-0-10**

Serve per  
Serves for  
Pour machines  
Dient fuer

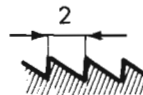

**327-49-1MD-01**

Si rende noto che il contenuto della presente tavola non potrà essere utilizzato o rappresentato né copiato, né ristampato, né tradotto, né riprodotto in alcun modo senza il permesso scritto della proprietaria S.p.A. V. P. DI & C. La stessa intende tutelare i suoi diritti in tutte le forme di legge.



**Renoldi**

GRIFFA SUSSID.

SUBSIDIARY FEED DOG

GRIFFE SUBSIDIAIRE

HILFSTRANSPORTEUR

|        |          |             |
|--------|----------|-------------|
| Indice | TAB      | <b>R300</b> |
| 00     |          |             |
| Data   | Foglio 7 | Segue F. 8  |

**204300-0-10**

Serve per  
Serves for  
Pour machines  
Dient fuer

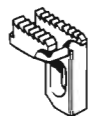
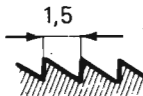

028-10-02  
028-10-03  
028-10-04  
028-10-05  
028-11-01  
228-10-01  
228-10-02  
228-10-03  
228-10-05  
228-10-06  
228-10-07

**204334-0-10**

Serve per  
Serves for  
Pour machines  
Dient fuer

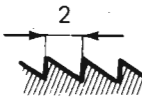

028-00-18  
028-01-08  
028-34-01  
228-34-01

**204355-0-10**

Serve per  
Serves for  
Pour machines  
Dient fuer

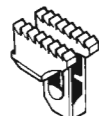
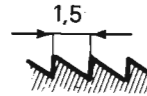

028-00-02  
028-00-25  
028-01-03  
228-00-04  
228-00-13  
228-01-02

**204304-0-10**

Serve per  
Serves for  
Pour machines  
Dient fuer

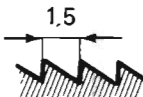

028-10-02  
028-10-03  
028-10-04  
028-10-05  
028-11-01  
228-10-01  
228-10-05  
228-10-06  
228-10-07

**204337-0-10**

Serve per  
Serves for  
Pour machines  
Dient fuer

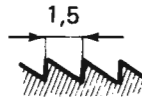

028-00-07  
028-00-08  
028-00-20  
028-00-21  
028-00-22  
028-00-24  
028-29-07  
028-30-03  
028-30-04  
028-30-05  
228-00-07  
228-00-08  
228-00-11  
228-00-12

**204358-0-10**

Serve per  
Serves for  
Pour machines  
Dient fuer

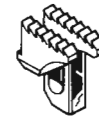
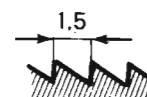

028-00-02  
228-00-04

Si avverte, sotto pena di nullità, che il contenuto della presente tavola non può, per alcun titolo, essere riprodotto o ristampato integralmente o parzialmente senza il permesso scritto dalla Renoldi S.p.A. La stessa intende tutelare i suoi diritti.

**Renoldi**

GRIFFA SUSSID.

SUBSIDIARY FEED DOG

GRIFFE SUBSIDIAIRE

HILFSTRANSPORTEUR

Indice

TAB

**R300**

Data

Foglio 8

Segue F. 9

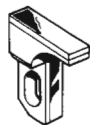
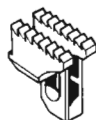
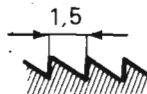
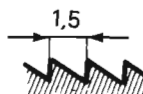
**204378-2-11**Serve per  
Serves for  
Pour machines  
Dient fuer028-00-06  
028-28-07  
228-00-06  
228-00-17  
228-28-07**204396-0-10**Serve per  
Serves for  
Pour machines  
Dient fuer028-00-10  
228-00-10**204410-0-10**Serve per  
Serves for  
Pour machines  
Dient fuer

028-00-13

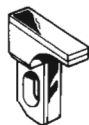
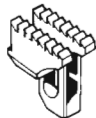
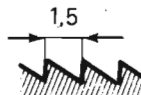
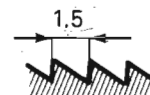
**204395-2-11**Serve per  
Serves for  
Pour machines  
Dient fuer028-00-09  
228-00-09**204409-0-10**Serve per  
Serves for  
Pour machines  
Dient fuer028-00-12  
028-00-14  
028-00-15  
028-00-16  
028-00-17  
028-01-05  
028-01-06  
028-01-07**204426-0-10**Serve per  
Serves for  
Pour machines  
Dient fuer228-10-04  
228-10-08

Si veda nota che il contenuto della presente tavola non potrà essere utilizzato o riprodotto senza permesso scritto dalla Renoldi S.p.A. Al fine di evitare qualsiasi responsabilità, la Renoldi S.p.A. non intende tutelare i suoi diritti in merito di legge.

modifiche

| Indice | Data |
|--------|------|
| V      |      |
|        |      |
|        |      |
|        |      |
|        |      |
|        |      |

|  |  |
|--|--|
|  |  |
|  |  |
|  |  |
|  |  |

|  |  |
|--|--|
|  |  |
|  |  |
|  |  |
|  |  |



**Rumoldi**

GRIFFA SUSSID. SUBSIDIARY FEED DOG GRIFFE SUBSIDIAIRE HILFSTRANSPORTEUR

|        |          |             |
|--------|----------|-------------|
| Indice | TAB      | <b>R300</b> |
| 00     |          |             |
| Data   | Foglio 9 | Segue F.10  |

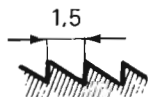
**204668-0-10**
 Serve per  
 Serves for  
 Pour machines  
 Dient fuer

329-00-2CD-01

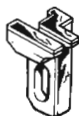
**204808-2-11**
 Serve per  
 Serves for  
 Pour machines  
 Dient fuer

329-00-2CD-01

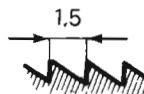
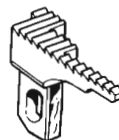
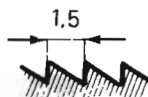
**204817-0-10**
 Serve per  
 Serves for  
 Pour machines  
 Dient fuer

 329-00-2CD-04  
 329-00-2CD-11
**204669-0-10**
 Serve per  
 Serves for  
 Pour machines  
 Dient fuer

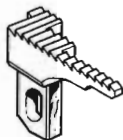
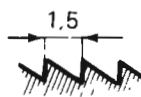
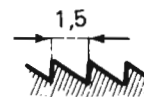
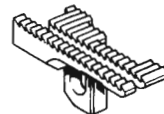
329-00-2CD-02

**204816-0-10**
 Serve per  
 Serves for  
 Pour machines  
 Dient fuer

 329-00-2CD-03  
 329-00-2CD-09
**204818-0-10**
 Serve per  
 Serves for  
 Pour machines  
 Dient fuer

 329-22-2CD-02  
 329-23-2CD-02

Si rende noto che il contenuto della presente tavola non potrà essere utilizzato o rappresentato né in modo né in parte, o riprodotto, senza il permesso scritto della Rumoldi S.p.A. o della Rumoldi R. Di & C. La stessa intende tutelare i suoi diritti in forma di legge.

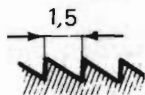
**204850-0-10**

Serve per  
Serves for  
Pour machines  
Dient fuer



329-00-2CD-05  
329-00-2CD-08  
329-00-2CD-12  
329-01-2CD-01  
329-12-2CD-02



**204852-0-10**

Serve per  
Serves for  
Pour machines  
Dient fuer



329-00-2CD-15  
329-22-2CD-03  
329-23-2CD-03

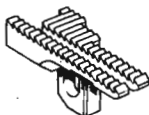

**204942-0-10**

Serve per  
Serves for  
Pour machines  
Dient fuer

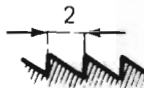

329-00-2CD-05  
329-00-2CD-08  
329-00-2CD-12  
329-01-2CD-01



**204851-0-11**

Serve per  
Serves for  
Pour machines  
Dient fuer



329-00-2CD-05  
329-00-2CD-08  
329-00-2CD-12  
329-01-2CD-01



**204853-0-10**

Serve per  
Serves for  
Pour machines  
Dient fuer

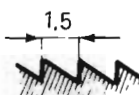

329-00-2CD-15  
329-22-2CD-03  
329-23-2CD-03



**204943-0-11**

Serve per  
Serves for  
Pour machines  
Dient fuer

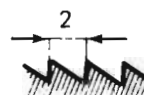

329-00-2CD-05  
329-00-2CD-08  
329-00-2CD-12  
329-01-2CD-01



Si vende solo che il contenuto della presente tavola non possa essere utilizzato o riprodotto in modo che parzialmente o totalmente senza permesso scritto della proprietaria S.p.A. V. P. ... D.L. Di C. La stessa azienda tutela i suoi diritti e norme di legge.

|        |       |
|--------|-------|
| Indice | 00    |
| Date   |       |
| Foglio | 10    |
| Segue  | F. 11 |

**Rumoldi**

GRIFFA SUSSID.

SUBSIDIARY FEED DOG

GRIFFE SUBSIDIAIRE

HILFSTRANSPORTEUR

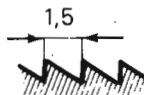
indice  
00  
TAB  
**R300**  
Date  
Foglio 11 | Sequenza F.12**204999-0-00**Serve per  
Serves for  
Pour machines  
Dient fuer

329-00-2CD-01

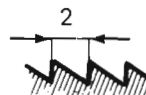
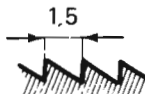
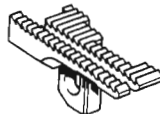
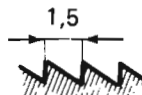
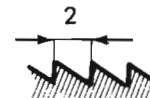
**205013-2-11**Serve per  
Serves for  
Pour machines  
Dient fuer329-00-2CD-06  
329-00-2CD-10**205064-0-10**Serve per  
Serves for  
Pour machines  
Dient fuer329-00-2CD-06  
329-00-2CD-10  
329-01-2CD-02**205011-0-10**Serve per  
Serves for  
Pour machines  
Dient fuer329-00-2CD-06  
329-00-2CD-10  
329-01-2CD-02**205014-0-10**Serve per  
Serves for  
Pour machines  
Dient fuer329-00-2CD-07  
329-00-2CD-13  
329-22-2CD-04  
329-23-2CD-04**205065-0-10**Serve per  
Serves for  
Pour machines  
Dient fuer329-00-2CD-02  
329-00-2CD-06  
329-00-2CD-10

Si rende noto che il contenuto della presente tavola non potrà essere utilizzato o approssimato senza permesso scritto dalla Rumoldi S.p.A. V. R. 10001 DI S. C. Le Rumoldi intende tutelare i suoi diritti. - Firma di legge



**205243-0-10**

Serve per  
Serves for  
Pour machines  
Dient fuer

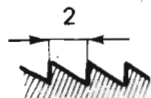

330-00 1CD-03

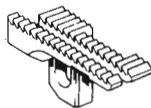

**205499-0-00**

Serve per  
Serves for  
Pour machines  
Dient fuer

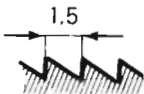

028-00 26

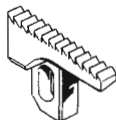

**205538-0-00**

Serve per  
Serves for  
Pour machines  
Dient fuer

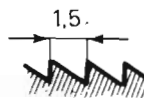

329-00 2CD-03  
329-00 2CD-09

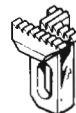

**205328-0-10**

Serve per  
Serves for  
Pour machines  
Dient fuer

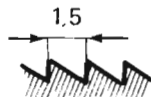

330-22-1CD-01

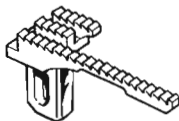

**205536-0-00**

Serve per  
Serves for  
Pour machines  
Dient fuer

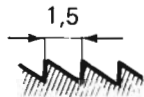

329-00 2CD-01



**205701-0-00**

Serve per  
Serves for  
Pour machines  
Dient fuer

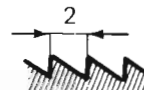

330-00 1CD-04

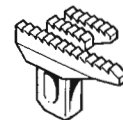

Si avverte che il contenuto della presente tavola non potrà essere ristampato, riprodotto, integrato, né divulgato a terzi, o riprodotto, integrato, né divulgato a terzi, senza il permesso scritto della Rumoldi S.p.A. La Rumoldi S.p.A. si riserva il diritto di tutelare i suoi diritti e la propria immagine in conformità della legge.



**GRIFFINO  
CHAINING FEED DOG  
GRIFFE CHAINETTE  
KLEIN-TRANSPORTEUR**

|  |  |  |  |  |  |
|--|--|--|--|--|--|
|  |  |  |  |  |  |
|--|--|--|--|--|--|

|  |  |  |  |  |  |
|--|--|--|--|--|--|
|  |  |  |  |  |  |
|--|--|--|--|--|--|

|  |  |  |  |  |  |
|--|--|--|--|--|--|
|  |  |  |  |  |  |
|--|--|--|--|--|--|

**Rumold**

**202061-0-10**



**GRIFFINO**



**CHAINING FEED DOG**

**GRIFFE P. CHAINETTE**

**KLEINTRANSPORTEUR**

INDICE  
00  
Data  
Foglio 1  
**R300**  
Segue F. 2

|   |  |   |  |  |  |
|---|--|---|--|--|--|
| <p>Serve per<br/>Serves for<br/>Pour machines<br/>Dient fuer</p>                    | <p>327-00-1CD-01/07/09/10/26/27/29/39<br/>327-01-1CD-01/02/04<br/>327-10-1CD-02/03/04/06<br/>327-11-1CD-01/02<br/>327-16-1CD-01<br/>327-22-1CD-02/03/04/05<br/>327-23-1CD-02/08<br/>327-28-1CD-02/11<br/>327-29-1CD-01/02/03/04/05/06/08<br/>327-34-1CD-01<br/>028-00-01/03/06/07/08/21/22/23/24<br/>028-01-01/02/04<br/>028-10-01/02/03/04/05<br/>028-11-01<br/>028-16-01<br/>028-28-01/02<br/>028-29-01/02/03/04/05/06/07<br/>028-30-05/06<br/>228-00-01/05/06/07/08/12/17/18<br/>228-01-01/03<br/>228-10-01/02/03/05/06/07<br/>228-28-01/02</p> | <p>Serve per<br/>Serves for<br/>Pour machines<br/>Dient fuer</p>                  | <p>327-00-1CD-06<br/>327-01-1MD-23<br/>327-00-1MD-34<br/>327-00-2CD-13<br/>327-00-2CD-38<br/>327-01-1CD-03<br/>327-01-1MD-08<br/>327-22-1CD-01<br/>327-22-1MD-07<br/>327-23-1CD-01<br/>327-23-1MD-07<br/>327-49-1MD-01<br/>028-00-02<br/>028-00-10<br/>028-00-18<br/>028-01-03<br/>028-01-08<br/>228-00-04<br/>228-00-10<br/>228-01-02</p> | <p>Serve per<br/>Serves for<br/>Pour machines<br/>Dient fuer</p> | <p>227-34-03<br/>327-00-2CD-12<br/>327-00-2CD-34<br/>327-00-2CD-44<br/>028-00-09<br/>228-00-09</p> |
|  |  |  |   | <p><b>203426-0-10</b></p>  |  |

|   |  |   |  |  |  |
|---|--|---|--|--|--|
| <p>Serve per<br/>Serves for<br/>Pour machines<br/>Dient fuer</p>                    | <p>327-00-1CD-02<br/>327-00-1CD-03<br/>327-00-1CD-05<br/>327-00-1CD-25<br/>327-00-1CD-31<br/>327-00-1CD-32<br/>327-01-1CD-05<br/>327-12-1CD-01<br/>327-28-1CD-07<br/>327-28-1CD-09<br/>327-30-1CD-07<br/>028-00-04<br/>028-00-05<br/>028-00-20<br/>028-00-26<br/>028-28-07<br/>028-30-01<br/>028-30-02<br/>028-30-03<br/>028-30-04<br/>028-30-04<br/>228-00-02<br/>228-00-03</p> | <p>Serve per<br/>Serves for<br/>Pour machines<br/>Dient fuer</p>                  | <p>327-00-1CD-30<br/>327-00-1MD-33<br/>328-01-1CD-06<br/>327-01-1MD-09<br/>327-01-1MD-10<br/>327-34-1MD-02<br/>028-00-25<br/>028-34-01<br/>228-00-13<br/>228-34-01</p> | <p>Serve per<br/>Serves for<br/>Pour machines<br/>Dient fuer</p> | <p>327-00-2CD-16<br/>327-00-2CD-32<br/>327-00-2CD-41<br/>327-01-2MD-37<br/>028-00-13</p> |
|  |  |  |   | <p><b>202609-0-10</b></p>  |  |

Si rende noto che il contenuto della presente tavola  
 stessa intende tutelare i suoi diritti e non si riserva  
 mente che parzialmente senza il permesso scritto  
 della proprietaria S.p.A. V. P. L. D. I. & C. L. A.  
 forma di legge.





|  |
|--|
|  |
|  |
|  |

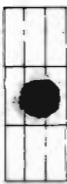

|  |
|--|
|  |
|  |
|  |

Indirizzo  
Data  
V.

Si rende noto che il contenuto della presente scheda non deve essere divulgato a terzi, o riprodotto, integralmente o parzialmente, senza l'autorizzazione della stessa, intendendo tutelare i suoi diritti e norme di legge.

**Arnoldi**

**GRIFFINO**

**CHAINING FEED DOG**

**GRIFFE P. CHAINETTE**

**KLEINTRANSPORTEUR**

Indice  
00  
Data

TAB.

**R 300**

Foglio 3 | Segue F. 4

**205245-0-10**

Serve per  
Serves for  
Pour machines  
Dient fuer

330-00 1CD-03

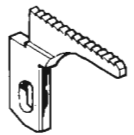

**206227-0-00**

Serve per  
Serves for  
Pour machines  
Dient fuer

330-12-2CD-02



**206224-0-00**

Serve per  
Serves for  
Pour machines  
Dient fuer

330-12-1CD-01  
330-12-1CD-03

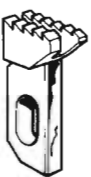

Serve per  
Serves for  
Pour machines  
Dient fuer

Serve per  
Serves for  
Pour machines  
Dient fuer

Rimoldi

GRIFINO

CHAINING FEED DOG

GRIFFE P. CHAINETTE

KLEINTRANSPORTEUR

921350-0-11



Serve per

Serves for

Pour machines

Dient fuer

|                             |                         |                         |
|-----------------------------|-------------------------|-------------------------|
| 327-00-1CD-01/135-81        | 327-28-1CD-07/135-81    | 228-00-04/135-80        |
| 327-00-1CD-02/135-81        | 327-28-1CD-09/135-81    | 228-00-05/135-80        |
| 327-00-1CD-03/135-81        | 327-28-1CD-11/135-81    | 228-00-06/135-80/137-80 |
| 327-00-1CD-05/135-81        | 028-00-01/135-80        | 228-00-07/135-80/137-80 |
| 327-00-1CD-06/135-81        | 028-00-02/135-80        | 228-00-08/135-80        |
| 327-00-1CD-07/135-81        | 028-00-03/135-80        | 228-00-09/135-80/137-80 |
| 327-00-1CD-09/135-81/137-81 | 028-00-04/135-80        | 228-00-10/135-80/137-80 |
| 327-00-1CD-10/135-81/137-81 | 028-00-05/135-80        | 228-00-13/135-80        |
| 327-00-1CD-25/135-81        | 028-00-06/135-80/137-80 | 228-00-14/135-80        |
| 327-00-1CD-30/135-81        | 028-00-07/135-80/137-80 | 228-00-15/135-80        |
| 327-00-1CD-31/135-81        | 028-00-08/135-80        | 228-00-17/135-80/137-80 |
| 327-00-1CD-39/135-81/137-81 | 028-00-09/135-80/137-80 | 228-10-01/135-80        |
| 327-00-1MD-23/135-81        | 028-00-10/135-80/137-80 | 228-10-02/135-80        |
| 327-00-1MD-33/135-81        | 028-00-18/135-80        | 228-10-03/135-80        |
| 327-00-2CD-12/135-81        | 028-00-25/135-80        | 228-10-05/135-80        |
| 327-00-2CD-13/135-81/137-81 | 028-10-02/135-80        | 228-10-06/135-80        |
| 327-00-2CD-34/135-81/137-81 | 028-10-03/135-80        | 228-10-07/135-80        |
| 327-00-2CD-38/135-81/137-81 | 028-10-04/135-80        | 228-28-01/135-80        |
| 327-10-1CD-02/135-81        | 028-10-05/135-80        | 228-28-02/135-80        |
| 327-10-1CD-03/135-81        | 028-28-01/135-80        | 228-28-07/135-80        |
| 327-10-1CD-04/135-81        | 028-28-02/135-80        | 228-28-10/135-80        |
| 327-10-1CD-06/135-81        | 028-28-07/135-80        |                         |
| 327-11-1CD-02/135-81        | 228-00-01/135-80        | 228-28-12               |
| 327-28-1CD-02/135-81        | 228-00-02/135-80        |                         |

923876-0-00



Serve per  
Serves for  
Pour machines  
Dient fuer

327-00-2CD-41/135-81

923902-0-00



Serve per  
Serves for  
Pour machines  
Dient fuer

327-00-2MD-20/135-81  
327-00-2MD-36/135-81  
028-00-16/135-80  
028-00-17/135-80

Serve per  
Serves for  
Pour machines  
Dient fuer

Importato da:

|          |  |
|----------|--|
| Nome     |  |
| Cognome  |  |
| Via      |  |
| C.A.P.   |  |
| Città    |  |
| Prov.    |  |
| Telefono |  |



Si rende noto che il contenuto della presente tavola non potrà essere utilizzato o rappresentato né in modo diretto né indiretto, né in modo particolare, senza permesso scritto dalla proprietaria S.p.A. V. R.lli, in quanto a essa si rivendica tuttora i suoi diritti di legge.

**PIEDINO  
PRESSER FOOT  
PIED-PRESSEUR  
DRUECKERFUSS**

**Rimoldi**

PIEDINO

PRESSER FOOT

PIED PRESSEUR

DRUECKERFUSS

|        |  |  |  |          |             |
|--------|--|--|--|----------|-------------|
| Indice |  |  |  | TAB      | <b>R300</b> |
|        |  |  |  |          |             |
| Data   |  |  |  | Foglio 1 | Segue F. 2  |

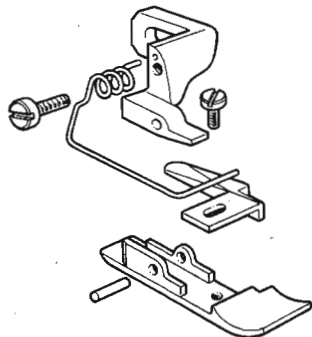
**200767-3-10**

Serve per  
Serves for  
Pour machines  
Dient fuer

023-04-01  
023-04-03  
023-04-04

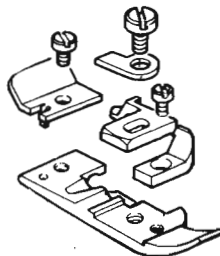
**202171-3-10**

Serve per  
Serves for  
Pour machines  
Dient fuer

327-00-1CD-01  
327-00-1CD-07  
028-00-03  
228-00-01  
228-00-05

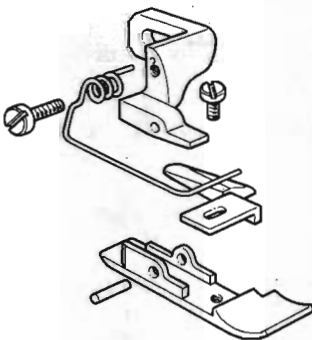
**200791-3-10**

Serve per  
Serves for  
Pour machines  
Dient fuer

023-04-02  
023-04-05

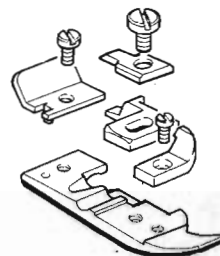
**202172-3-10**

Serve per  
Serves for  
Pour machines  
Dient fuer

327-00-1CD-01  
327-00-1CD-07  
327-01-1CD-01

Si rende noto che il contenuto della presente tavola  
non è da considerarsi un'opera di ingegneria, ma  
meramente divulgativo a terzi o viziato, non si integra-  
mente che parzialmente senza l'autorizzazione scritta  
della stessa azienda, tutelata i suoi diritti e l'immagine di legge.

Indice  
Data  
Vr.

modifiche



Si rende noto che il contenuto della presente tavola non potrà essere utilizzato o riprodotto, in tutto o in parte, senza permesso scritto dalla Arnoldi, s.p.a. in viale dell'Industria, 10 - 20139 Milano. La stessa intende tutelare i suoi diritti e norme di legge.

|        |  |
|--------|--|
| Indice |  |
| Data   |  |
| Vr.    |  |



|  |  |
|--|--|
|  |  |
|  |  |

**202178-3-10**

Serve per  
Serves for  
Pour machines  
Dient fuer

327-01-1CD-02  
327-01-1CD-04  
327-01-1CD-05  
028-01-02  
028-01-04  
228-01-01  
228-01-03  
228-01-04

**202509-3-10**

Serve per  
Serves for  
Pour machines  
Dient fuer

327-00-1CD-01  
327-00-1CD-07  
327-01-1CD-01  
028-00-01  
028-00-03  
028-01-01  
228-00-01  
228-00-05

**202182-3-10**

Serve per  
Serves for  
Pour machines  
Dient fuer

327-29-1CD-03  
028-29-03

**202641-3-10**

Serve per  
Serves for  
Pour machines  
Dient fuer

327-28-1CD-11  
028-00-08  
228-00-08





**Rumoldi**

PIEDINO

PRESSER FOOT

PIED PRESSEUR

DRUECKERFUSS

|        |  |  |  |          |             |
|--------|--|--|--|----------|-------------|
| Indice |  |  |  | TAB      | <b>R300</b> |
|        |  |  |  |          |             |
| Data   |  |  |  | Foglio 5 | Segue F. 6  |

202646-3-10

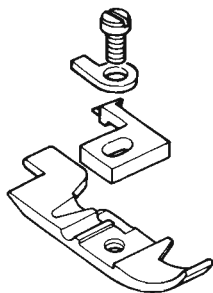

Serve per  
Serves for  
Pour machines  
Dient fuer

327-00-1CD-03  
028-00-05  
228-00-03

202732-3-00

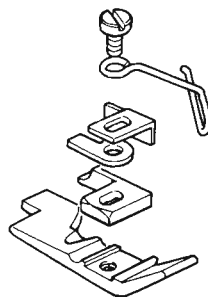

Serve per  
Serves for  
Pour machines  
Dient fuer

327-00-1CD-02  
228-00-14

202710-3-10

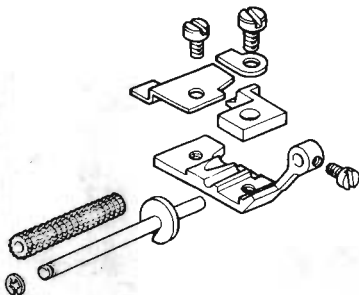

Serve per  
Serves for  
Pour machines  
Dient fuer

028-30-01

202752-3-10

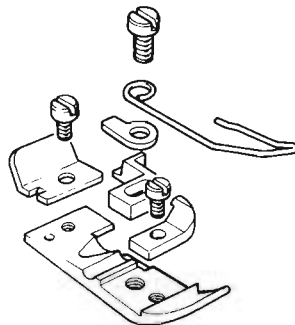

Serve per  
Serves for  
Pour machines  
Dient fuer

028-10-01

Si rende noto che il contenuto della presente tavola non deve essere utilizzato o riprodotto in alcun modo, né parzialmente o integralmente, senza l'autorizzazione scritta della proprietaria S.p.A. V. L. Rumoldi & C. La stessa intende tutelare i suoi diritti.

Indice  
Data  
Vr.

modificata



**Rimoldi****PIEDINO****PRESSER FOOT****PIED PRESSEUR****DRUECKERFUSS**

|        |          |             |
|--------|----------|-------------|
| Indice | TAB      | <b>R300</b> |
| Data   | Foglio 7 | Segue F. 8  |

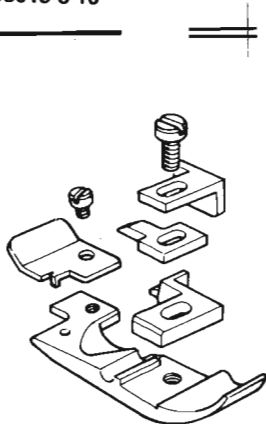
**203015-3-10**

Serve per  
Serves for  
Pour machines  
Dient fuer

327-00-1CD-06  
028-00-02  
228-00-04

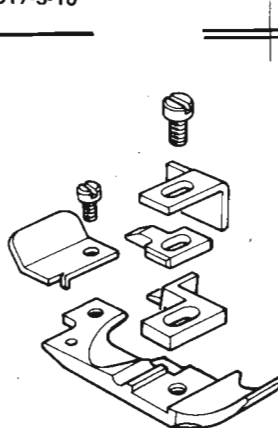
**203017-3-10**

Serve per  
Serves for  
Pour machines  
Dient fuer

327-00-1MD-33

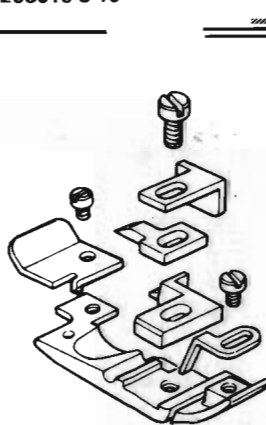
**203016-3-10**

Serve per  
Serves for  
Pour machines  
Dient fuer

327-01-1CD-03  
327-01-1CD-06  
028-01-03  
228-01-02

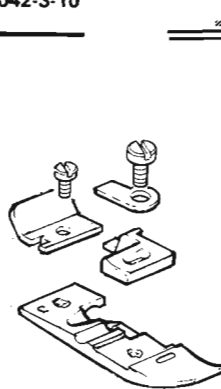
**203042-3-10**

Serve per  
Serves for  
Pour machines  
Dient fuer

327-01-1CD-03  
028-01-03  
228-01-02

Indice  
Data  
V.

Si rende noto che il contenuto della presente tavola non potrà essere utilizzato o riprodotto, né copiato, senza permesso scritto dalla Rimoldi S.p.A. V.le della Libertà, 10 - 37069 Verona. La stessa intende tutelare i suoi diritti di legge.

203050-3-10



Serve per  
Serves for  
Pour machines  
Dient fuer

327-00-1CD-25  
028-00-20  
028-30-03  
228-00-11

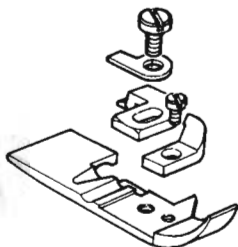

203077-3-10



Serve per  
Serves for  
Pour machines  
Dient fuer

327-00-1CD-26  
028-00-21  
028-00-23  
028-30-05  
028-30-06  
228-00-12



203053-3-10

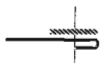

Serve per  
Serves for  
Pour machines  
Dient fuer

028-30-04

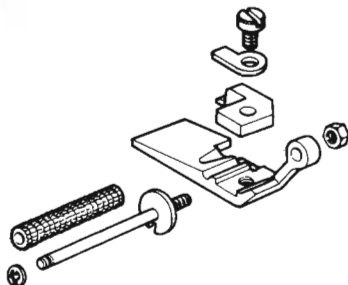

203154-3-10



Serve per  
Serves for  
Pour machines  
Dient fuer

327-29-1CD-04  
028-29-04

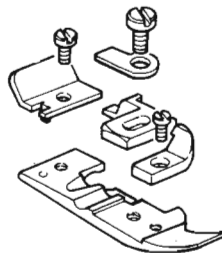

Si rende nota che il contenuto della presente tavola non è un diritto di proprietà intellettuale e che lo stesso non può essere riprodotto o ristampato senza permesso scritto dalla Rumoldi s.p.a. in quanto lo stesso intende tutelare i suoi diritti.

modifiche

|        |  |
|--------|--|
| Indice |  |
| Data   |  |
| V.     |  |



|  |  |
|--|--|
|  |  |
|  |  |

**Rumoldi**

PIEDINO

PRESSER FOOT

PIED PRESSEUR

DRUECKERFUSS

Indice

TAB

**R300**

Data

Foglio 9

Segue F.10

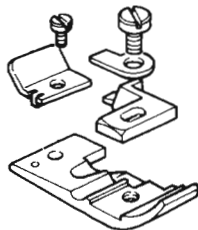
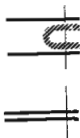
**203157-3-10**

Serve per  
Serves for  
Pour machines  
Dient fuer

327-01-1CD-01  
327-22-1CD-02  
327-22-1CD-04  
028-01-01

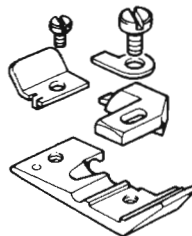
**203159-3-10**

Serve per  
Serves for  
Pour machines  
Dient fuer

327-22-1CD-03  
327-22-1CD-05

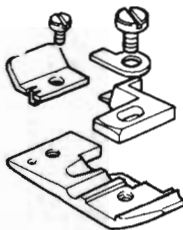
**203158-3-10**

Serve per  
Serves for  
Pour machines  
Dient fuer

327-22-1CD-02  
327-22-1CD-04

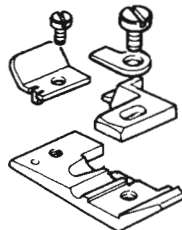
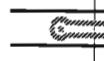
**203160-3-10**

Serve per  
Serves for  
Pour machines  
Dient fuer

327-23-1CD-02  
327-23-1CD-08

Indice  
Data  
Vr

modirich

Si rende noto che il contenuto della presente tavola non potrà essere utilizzato o rappresentato né comunque divulgato a terzi o riprodotto in qualsiasi forma senza il permesso scritto della proprietaria S.p.A. V. R. Z.01 & C. La stessa intende tutelare i suoi diritti in forma di legge.



**Rumoldi**

PIEDINO

PRESSER FOOT

PIED PRESSEUR

DRUECKERFUSS

Indice

TAB

**R300**

Data

Foglio 11 | Segue F.12

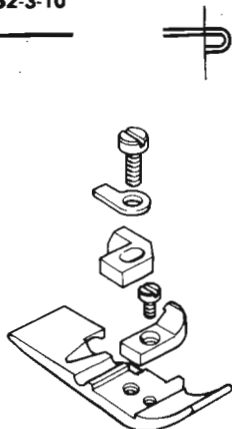
**203362-3-10**

Serve per  
Serves for  
Pour machines  
Dient fuer

327-00-1CD-09  
327-00-1CD-39  
028-00-06  
228-00-06  
228-00-17  
228-00-18

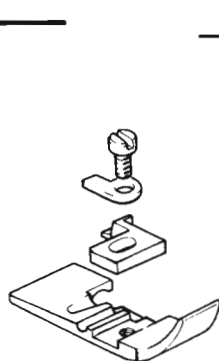
**203400-3-10**

Serve per  
Serves for  
Pour machines  
Dient fuer

028-30-02

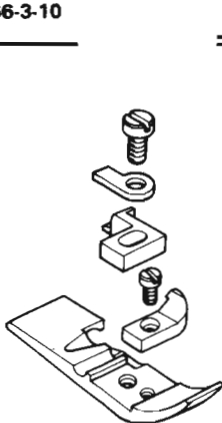
**203366-3-10**

Serve per  
Serves for  
Pour machines  
Dient fuer

327-00-1CD-10  
327-28-1CD-11  
028-00-07  
028-00-08  
228-00-07  
228-00-08

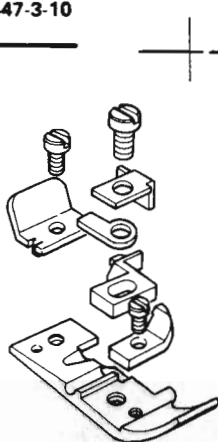
**203447-3-10**

Serve per  
Serves for  
Pour machines  
Dient fuer

327-00-2CD-12  
327-00-2CD-13  
327-00-2CD-34  
327-00-2CD-38  
327-00-2CD-44  
028-00-09  
028-00-10  
228-00-09  
228-00-10

Indice  
Data  
Vr

modifiche

Si rende noto che il contenuto della presente tavola non potrà essere utilizzato o rappresentato né copiato, né ristampato, né riprodotto in alcun modo senza la permesso scritto e autorizzato dalla proprietaria S.p.A. V. I. DI & C. La stessa intende tutelare i suoi diritti in forma di legge.





**Arnold**

PIEDINO

PRESSER FOOT

PIED PRESSEUR

DRUECKERFUSS

|        |           |             |
|--------|-----------|-------------|
| Indice | TAB       | <b>R300</b> |
| Data   | Foglio 13 | Segue F.14  |

203597-3-10

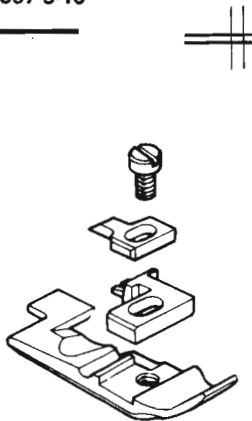

Serve per  
Serves for  
Pour machines  
Dient fuer

327-00-2CD-16  
327-00-2CD-41  
028-00-13

203721-3-10

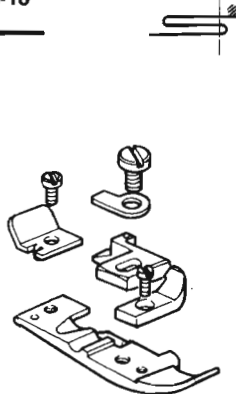

Serve per  
Serves for  
Pour machines  
Dient fuer

327-11-1CD-01  
028-11-01

203618-3-10

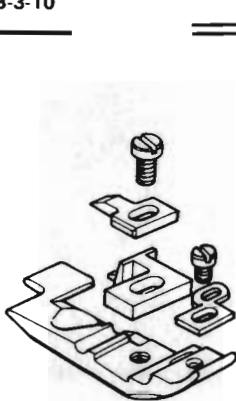

Serve per  
Serves for  
Pour machines  
Dient fuer

327-01-2CD-05  
028-01-05..

203765-3-10

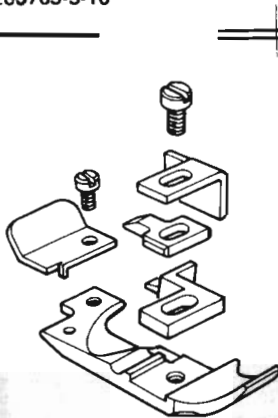

Serve per  
Serves for  
Pour machines  
Dient fuer

327-00-1MD-23  
327-00-1MD-34  
028-00-18

Indice  
Data  
Vr.

Si rende noto che il contenuto della presente tavola non potrà essere utilizzato o riprodotto senza permesso scritto dalla proprietaria S.p.A. V. Lodi & C. La stessa intende tutelare i suoi diritti in conformità di legge.



|  |
|--|
|  |
|  |
|  |



|  |
|--|
|  |
|  |
|  |

|        |
|--------|
| Indice |
| Data   |
| V.     |

modifiche

Si rende noto che il contenuto della presente tavola non potrà essere utilizzato o rappresentato né comunque divulgato a terzi o riprodotto sia integralmente che in parte, senza il permesso scritto della proprietaria S.p.A. S. Di & C. La stessa intende tutelare i suoi diritti e firma di legge.

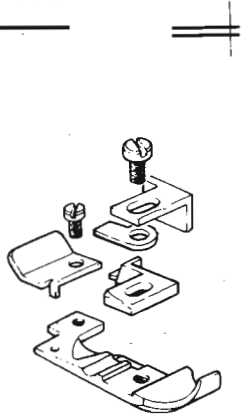
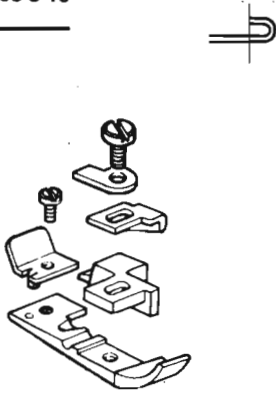
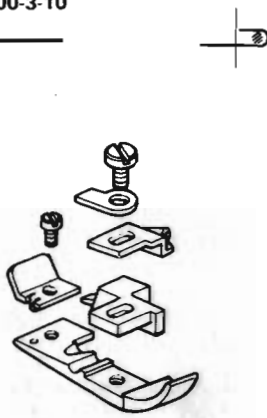
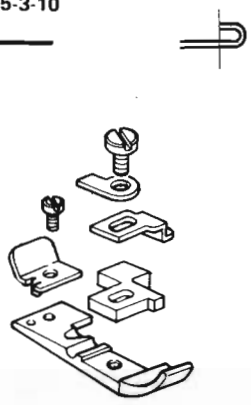
| <i>Renoldi</i>   | PIEDINO  | PRESSER FOOT   | PIED PRESSEUR   | DRUECKERFUSS |
|--|--|--|---|--------------|
| <p data-bbox="181 150 305 174"><b>203796-3-00</b></p>   | <p data-bbox="619 126 768 210">Serve per<br/>Serves for<br/>Pour machines<br/>Dient fuer</p> <p data-bbox="561 246 784 307">327-00-1CD-06/103-90<br/>028-00-02/103-90<br/>228-00-04/103-90</p> | <p data-bbox="900 150 1024 174"><b>203803-3-10</b></p>   | <p data-bbox="1346 126 1495 210">Serve per<br/>Serves for<br/>Pour machines<br/>Dient fuer</p> <p data-bbox="1288 246 1437 288">327-00-1CD-27<br/>028-00-22</p> |              |
| <p data-bbox="181 662 305 686"><b>203800-3-10</b></p>  | <p data-bbox="619 644 768 722">Serve per<br/>Serves for<br/>Pour machines<br/>Dient fuer</p> <p data-bbox="569 758 718 800">327-29-1CD-08<br/>028-29-07</p>                                    | <p data-bbox="900 662 1024 686"><b>203815-3-10</b></p>  | <p data-bbox="1346 644 1495 722">Serve per<br/>Serves for<br/>Pour machines<br/>Dient fuer</p> <p data-bbox="1288 764 1437 806">327-00-1CD-29<br/>028-00-24</p> |              |

|        |           |            |
|--------|-----------|------------|
| Indice | R300      |            |
| Data   | Foglio 15 | Segue F.16 |

**203866-3-10**

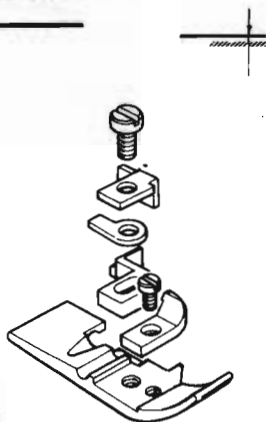

Serve per  
Serves for  
Pour machines  
Dient fuer

227-34-03

**204009-3-11**

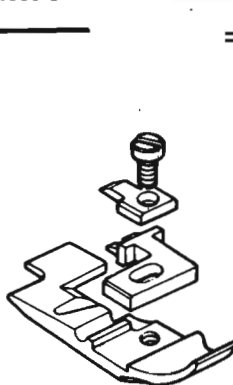

Serve per  
Serves for  
Pour machines  
Dient fuer

327-00-2CD-18  
327-00-2MD-36  
028-00-15  
028-00-16

**203967-3-10**

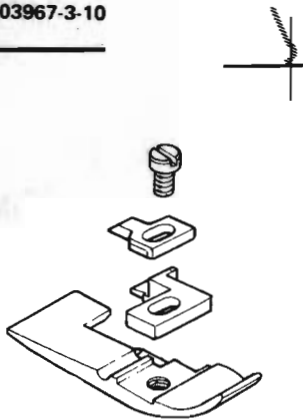

Serve per  
Serves for  
Pour machines  
Dient fuer

227-34-01

**204010-3-10**

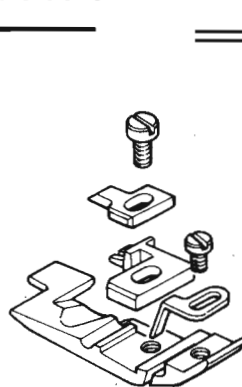

Serve per  
Serves for  
Pour machines  
Dient fuer

327-01-2CD-06  
327-01-2MD-11  
028-01-06

Si rende noto che il contenuto della presente tavola  
 rimane diviso in terzi o frazioni, senza che l'intero  
 sia integralmente coperto, si prega di restituire  
 alla proprietà S.p.A. di Rumoldi, via S. Maria  
 101, 20138 Milano, Italia, l'intero documento.

modifiche

| Indice | Data | V. |
|--------|------|----|
|        |      |    |
|        |      |    |
|        |      |    |
|        |      |    |

|  |  |
|--|--|
|  |  |
|  |  |

|  |  |
|--|--|
|  |  |
|  |  |

**Remoldi****PIEDINO****PRESSER FOOT****PIED PRESSEUR****DRUECKERFUSS**

Indice

TAB

**R300**

Data

Foglio 17

Segue 18

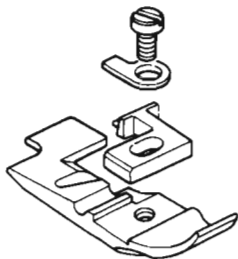
**204017-3-10**

Serve per  
Serves for  
Pour machines  
Dient fuer

327-00-2CD-18  
327-00-2MD-36  
028-00-15  
028-00-16

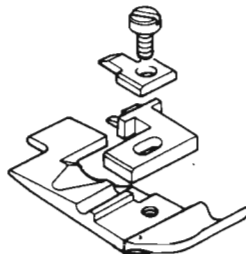
**204037-3-10**

Serve per  
Serves for  
Pour machines  
Dient fuer

327-00-2CD-14  
327-00-2CD-15  
327-00-2CD-17  
327-00-2CD-35  
327-00-2CD-39  
327-00-2CD-45  
327-00-2MD-20  
327-00-2MD-21  
028-00-11  
028-00-12  
028-00-14  
028-00-17

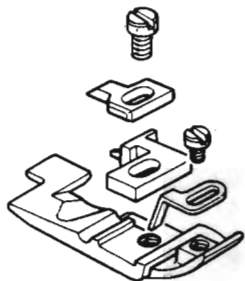
**204028-3-10**

Serve per  
Serves for  
Pour machines  
Dient fuer

327-01-2CD-05  
327-01-2CD-10  
327-01-2CD-12  
327-01-2CD-13  
327-01-2MD-07  
028-01-05  
028-01-07

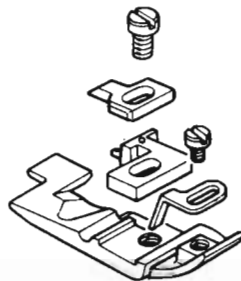
**204038-3-00**

Serve per  
Serves for  
Pour machines  
Dient fuer

327-01-2MD-07  
028-01-07

Indice  
Data  
V.

modifiche

Si vende noto che il contenuto della presente tavola  
non è da considerarsi un progetto o un disegno  
munito di brevetto e terzi o riproduzioni o  
modifiche o integrazioni o variazioni o  
trasmissioni o comunicazioni o diffusione scritte  
o grafiche o elettroniche o in qualsiasi forma  
o con qualsiasi mezzo o per qualsiasi modo  
è vietata senza il permesso scritto della  
proprietaria S.p.A. V. R. L. DI & C. La  
stessa intende tutelare i suoi diritti e norme di legge.

Si veda noto che il contenuto della presente tavola non potrà essere utilizzato o rappresentato né come intero né parzialmente senza l'autorizzazione scritta della proprietaria S.p.A. V. V. Di S. C. La stessa intende tutelare i suoi diritti.

modificati

| V./. | Indice |
|------|--------|
|      | Date   |
|      |        |
|      |        |
|      |        |
|      |        |
|      |        |
|      |        |
|      |        |
|      |        |



|  |  |
|--|--|
|  |  |
|  |  |
|  |  |

204051-3-10

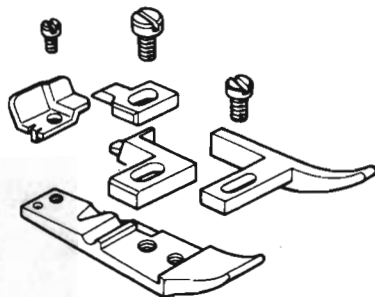

Serve per  
Serves for  
Pour machines  
Dient fuer

327-34-1MD-02  
228-34-01

204439-3-12

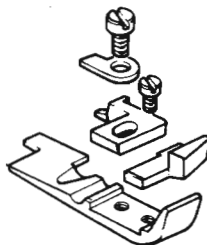

Serve per  
Serves for  
Pour machines  
Dient fuer

228-10-04

204057-3-10

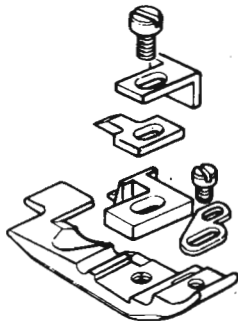

Serve per  
Serves for  
Pour machines  
Dient fuer

327-01-2MD-07  
028-01-07

204525-3-11

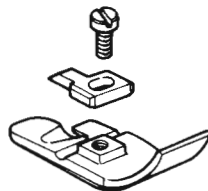

Serve per  
Serves for  
Pour machines  
Dient fuer

028-28-09  
228-28-09

*Rumoldi*

PIEDINO

PRESSER FOOT

PIED PRESSEUR

DRUECKERFUSS

|        |           |  |  |           |             |
|--------|-----------|--|--|-----------|-------------|
| Indice |           |  |  | TAB       | <b>R300</b> |
| Date   | Foglio 19 |  |  | Segue F20 |             |

204526-3-11

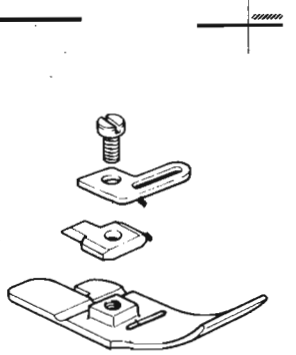

Serve per  
Serves for  
Pour machines  
Dient fuer

028-29-08

204592-3-11

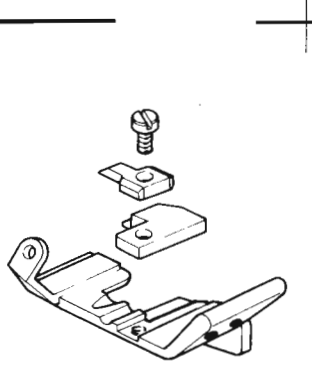

Serve per  
Serves for  
Pour machines  
Dient fuer

028-28-10  
028-28-11  
228-28-08  
228-28-11

204571-3-11

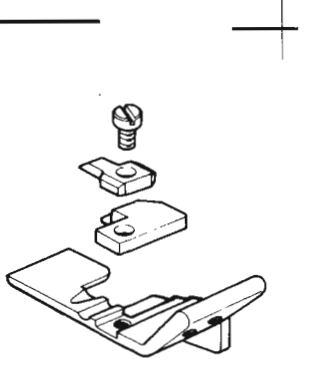

Serve per  
Serves for  
Pour machines  
Dient fuer

028-28-10  
028-28-11  
228-28-08  
228-28-11

204611-3-11

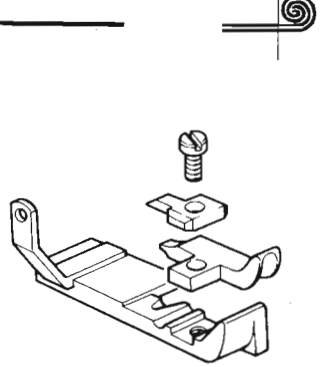

Serve per  
Serves for  
Pour machines  
Dient fuer

028-00-19  
228-00-16

Indice  
Date  
Vr

Si rende noto che il contenuto della presente tavola non potrà essere utilizzato o rappresentato in modo totale o parziale senza l'autorizzazione scritta della proprietaria S.p.A. V. P. Rumoldi & C. La stessa intende tutelare i suoi diritti. Firma di legge.

**204633-3-10**

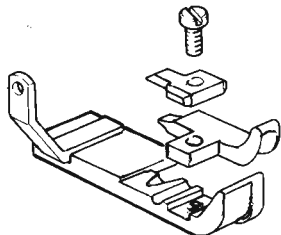

Serve per  
Serves for  
Pour machines  
Dient fuer

028-00-19  
228-00-16

**204826-3-10**

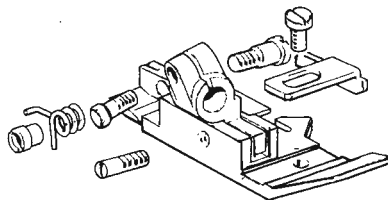

Serve per  
Serves for  
Pour machines  
Dient fuer

329-00-2CD-03

**204706-3-11**

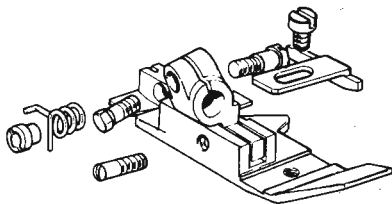

Serve per  
Serves for  
Pour machines  
Dient fuer

329-00-2CD-02

**204827-3-10**

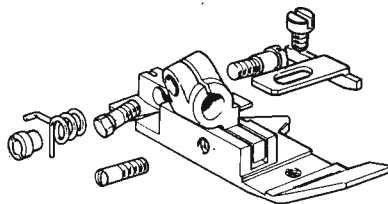

Serve per  
Serves for  
Pour machines  
Dient fuer

329-00-2CD-04

Si rende noto che il contenuto della presente tavola non potrà essere utilizzato o rappresentato, né comunque che parzialmente senza il permesso scritto della proprietà S.p.A. V. I. DI & C. La stessa intende tutelare i suoi diritti in forma di legge.

modifiche

| V. | Data | Indice |
|----|------|--------|
|    |      |        |
|    |      |        |
|    |      |        |
|    |      |        |
|    |      |        |
|    |      |        |

|  |
|--|
|  |
|  |
|  |
|  |

|  |
|--|
|  |
|  |
|  |
|  |



*Rumoldi*

PIEDINO

PRESSER FOOT

PIED PRESSEUR

DRUECKERFUSS

|        |           |             |
|--------|-----------|-------------|
| Indice | TAB       | <b>R300</b> |
| Data   | Foglio 21 | Segue F22   |

204828-3-10



Serve per  
Serves for  
Pour machines  
Dient fuer

329-22-2CD-02

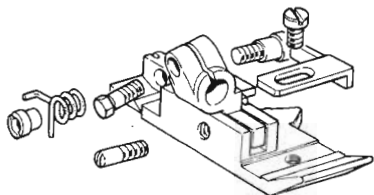

204873-3-11



Serve per  
Serves for  
Pour machines  
Dient fuer

329-12-2CD-02

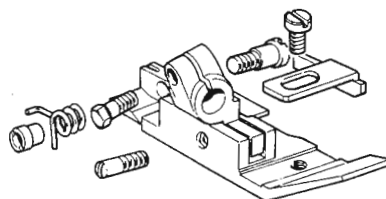

204829-3-10



Serve per  
Serves for  
Pour machines  
Dient fuer

329-23-2CD-02

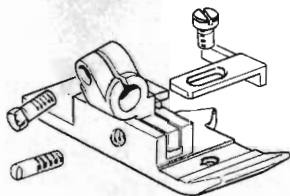

204875-3-11



Serve per  
Serves for  
Pour machines  
Dient fuer

329-22-2CD-03

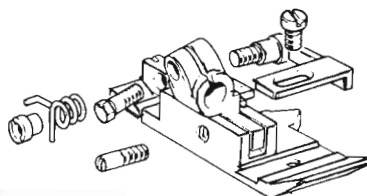

Si rende noto che il contenuto della presente tavola  
 non può essere copiato, ristampato, riprodotto o  
 comunque divulgato a terzi o riprodotto integral-  
 mente che parzialmente senza l'autorizzazione scrit-  
 ta della proprietaria S.p.A. Rumoldi S.p.A. La  
 stessa intende tutelare i suoi diritti.

Indice  
 Data  
 Vr

modelli



**Rumoldi**

PIEDINO

PRESSER FOOT

PIED PRESSEUR

DRUECKERFUSS

|        |           |             |
|--------|-----------|-------------|
| Indice | TAB       | <b>R300</b> |
| Data   | Foglio 23 | Segue F24   |

**205034-3-11**

Serve per  
Serves for  
Pour machines  
Dient fuer

329-22-2CD-04

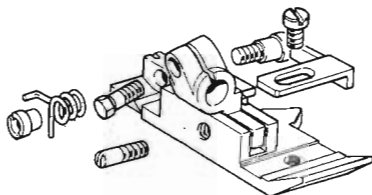
**205070-3-11**

Serve per  
Serves for  
Pour machines  
Dient fuer

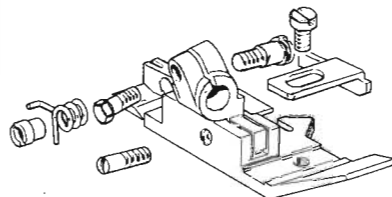
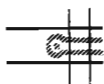
329-00-2CD-06  
329-00-2CD-13**205035-3-11**

Serve per  
Serves for  
Pour machines  
Dient fuer

329-23-2CD-04

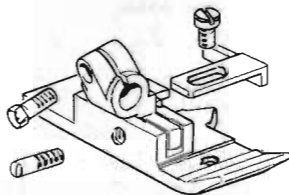
**205084-3-10**

Serve per  
Serves for  
Pour machines  
Dient fuer

329-00-2CD-09

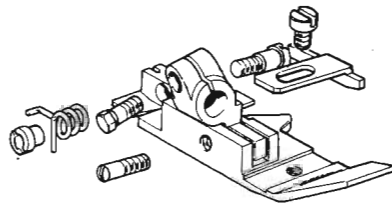

Si rende noto che il contenuto della presente tavola  
non può essere copiato, ristampato, o riprodotto  
in qualsiasi modo, senza permesso scritto dalla  
proprietaria S.p.A. Rumoldi & C. La  
stessa intende tutelare i suoi diritti secondo la legge.

Indice  
Data  
V.

modelltech

*Rumoldi*

PIEDINO

PRESSER FOOT

PIED PRESSEUR

DRUECKERFUSS

|        |           |             |
|--------|-----------|-------------|
| Indice | TAB       | <b>R300</b> |
| Date   | Foglio 24 | Segue F 25  |

205085-3-10

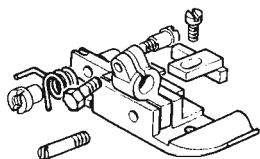

Serve per  
Serves for  
Pour machines  
Dient fuer

329-00-2CD-11

205110-3-11

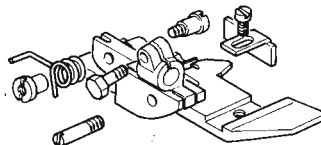

Serve per  
Serves for  
Pour machines  
Dient fuer

329-00-2CD-07

205103-3-10

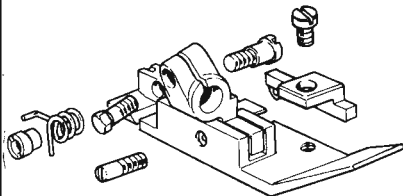

Serve per  
Serves for  
Pour machines  
Dient fuer

329-00-2CD-08

205118-3-11

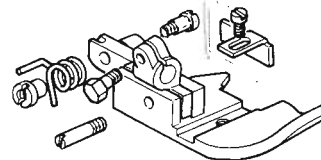

Serve per  
Serves for  
Pour machines  
Dient fuer

329-00-2CD-10

Si rende noto che il contenuto della presente tavola non potrà essere utilizzato o rappresentato né come disegno né come fotografia senza permesso scritto della proprietaria S.p.A. V. C. L. D. S. C. La stessa intende tutelare i suoi diritti secondo le norme di legge.

modifiche

| Indice | Data |
|--------|------|
|        |      |
|        |      |
|        |      |
|        |      |
|        |      |



|  |  |
|--|--|
|  |  |
|  |  |

**Remold**

PIEDINO

PRESSER FOOT

PIED PRESSEUR

DRUECKERFUSS

|        |  |  |  |                       |             |
|--------|--|--|--|-----------------------|-------------|
| Indice |  |  |  | TAB                   | <b>R300</b> |
|        |  |  |  |                       |             |
| Data   |  |  |  | Foglio 25   Segue F26 |             |

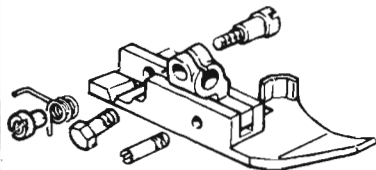
**205196-3-10**

Serve per  
Serves for  
Pour machines  
Dient fuer

330-00-1CD-01

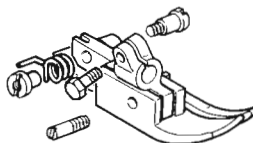
**205223-3-10**

Serve per  
Serves for  
Pour machines  
Dient fuer

330-00-1CD-02  
330-00-1CD-03

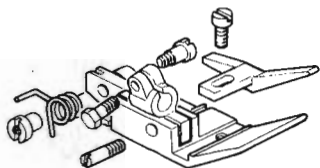
**205209-3-10**

Serve per  
Serves for  
Pour machines  
Dient fuer

330-00-1CD-02

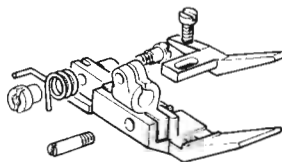
**205247-3-10**

Serve per  
Serves for  
Pour machines  
Dient fuer

330-00-1CD-03

Si rende noto che il contenuto della presente tavola  
 non è da considerarsi un'opera d'arte e che, in  
 mancanza di divieto, è lecito riprodurla integral-  
 mente o parzialmente senza l'autorizzazione scrit-  
 ta dell'ingegnere S.p.A. di cui è proprietaria. La  
 stessa intende tutelare i suoi diritti, come di legge.

Indice  
Data  
Vr

modifichim

**Rimoldi**

PIEDINO

PRESSER FOOT

PIED PRESSEUR

DRUECKERFUSS

|        |           |             |
|--------|-----------|-------------|
| Indice | TAB       | <b>R300</b> |
| Date   | Foglio 26 | Segue F 27  |

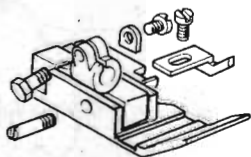
**205346-3-10**

Serve per  
Serves for  
Pour machines  
Dient fuer

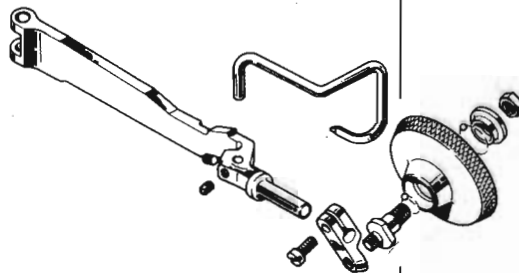
**330-22-1CD-01****205471-4-00**

Serve per  
Serves for  
Pour machines  
Dient fuer

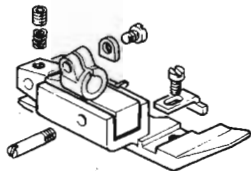
**028-00-26****205418-3-10**

Serve per  
Serves for  
Pour machines  
Dient fuer

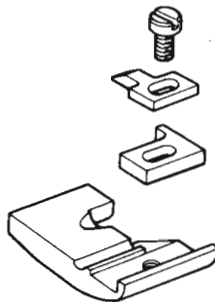
**330-12-1CD-01**  
**330-12-1CD-03****205503-3-00**

Serve per  
Serves for  
Pour machines  
Dient fuer

**327-01-1MD-09**

Si rende noto che il contenuto della presente tavola  
è di proprietà esclusiva di Rimoldi & C. La  
reproduzione o l'uso non autorizzato senza  
il permesso scritto della Rimoldi & C. La  
reproduzione o l'uso non autorizzato senza  
il permesso scritto della Rimoldi & C. La  
reproduzione o l'uso non autorizzato senza  
il permesso scritto della Rimoldi & C. La

modifiche

| V. | Data | Indice |
|----|------|--------|
|    |      |        |
|    |      |        |
|    |      |        |
|    |      |        |
|    |      |        |

|  |  |  |
|--|--|--|
|  |  |  |
|  |  |  |
|  |  |  |
|  |  |  |

|  |  |  |
|--|--|--|
|  |  |  |
|  |  |  |
|  |  |  |

*Remold*

PIEDINO

PRESSER FOOT

PIED PRESSEUR

DRUECKERFUSS

|        |           |             |
|--------|-----------|-------------|
| Indice | TAB       | <b>R300</b> |
| Data   | Foglio 27 | Segue F.28  |

205595-3-10

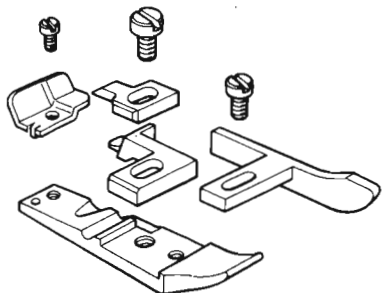

Serve per  
Serves for  
Pour machines  
Dient fuer

327-34-1MD-03

662

205607-3-00

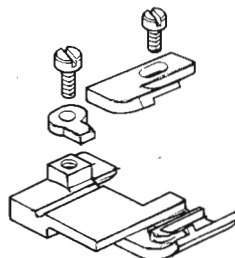

Serve per  
Serves for  
Pour machines  
Dient fuer

327-49-1MD-01

205604-3-00

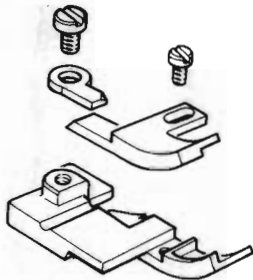

Serve per  
Serves for  
Pour machines  
Dient fuer

327-40-1MD-01

205710-3-00

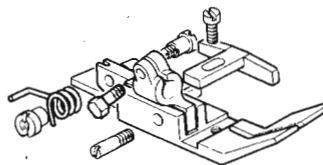

Serve per  
Serves for  
Pour machines  
Dient fuer

330-00-1CD-04

Indice  
Data  
Vr.

modifiche

Si rende noto che il contenuto della presente tavola  
è di proprietà esclusiva della Remold S.p.A. e non può  
in nessun caso essere riprodotto o utilizzato senza  
il permesso scritto della Remold S.p.A. La  
stessa intende tutelare i suoi diritti come di legge.





**Rimoldi**

PIEDINO

PRESSER FOOT

PIED PRESSEUR

DRUECKERFUSS

|        |  |                        |             |
|--------|--|------------------------|-------------|
| Indice |  | TAB                    | <b>R300</b> |
|        |  |                        |             |
| Data   |  | Foglio 29   Segue F.30 |             |

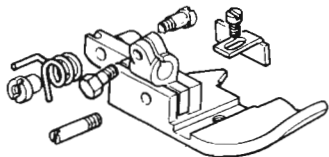
**206046-3-01**

Serve per  
Serves for  
Pour machines  
Dient fuer

329-00-3MU-01

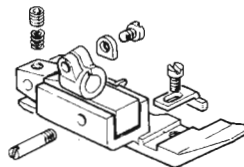
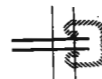
**206231-3-00**

Serve per  
Serves for  
Pour machines  
Dient fuer

330-12-2CD-02

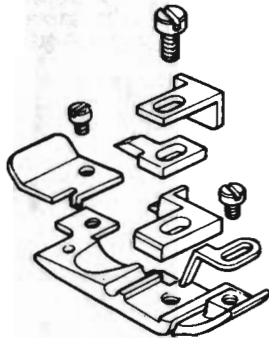
**206140-3-00**

Serve per  
Serves for  
Pour machines  
Dient fuer

327-34-1CD-01

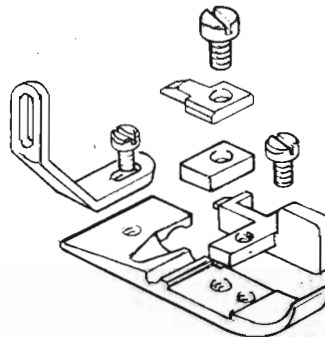
**207046-3-00**

Serve per  
Serves for  
Pour machines  
Dient fuer

327-11-1CD-02

Si rende noto che il contenuto della presente tavola  
non può essere copiato, ristampato, riprodotto, o  
in alcun modo divulgato a terzi o riprodotto, sia integral-  
mente che parzialmente senza l'autorizzazione scritta  
della Rimoldi S.p.A. Rimoldi S.p.A. è proprietaria e  
tiene a bada intesa tutelare i suoi diritti e norma di legge.

Indice  
Data  
V.:

modifiche





Si rende noto che il contenuto della presente tavola non potrà essere utilizzato o rappresentato né con nome né con immagine senza il permesso scritto della proprietaria S.p.A. V. F. Di & C. La stessa intende tutelare i suoi diritti.

|        |  |
|--------|--|
| Indice |  |
| Date   |  |
| V.     |  |



920854-3-00

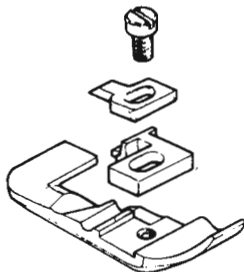

Serve per  
Serves for  
Pour machines  
Dient fuer

327-00-2CD-16/108-91  
327-00-2CD-32/108-91  
028-00-13/108-90

920884-3-10

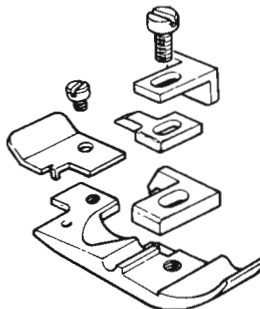

Serve per  
Serves for  
Pour machines  
Dient fuer

327-00-1CD-30/103-90  
028-00-25/103-90  
228-00-13/103-90

234

920860-3-00

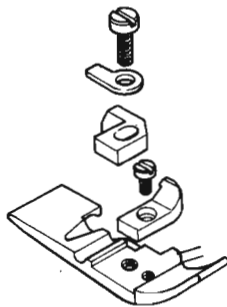

Serve per  
Serves for  
Pour machines  
Dient fuer

327-00-1CD-25/103-90

921352-3-10

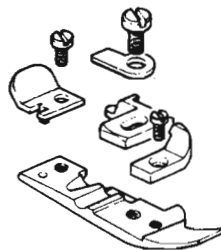

Serve per  
Serves for  
Pour machines  
Dient fuer

327-00-1CD-01/135-81  
327-00-1CD-07/135-81  
028-00-01/135-80  
028-00-03/135-80  
228-00-01/135-80  
228-00-05/135-80

|  |
|--|
|  |
|  |
|  |



|  |
|--|
|  |
|  |
|  |

|        |
|--------|
| Indice |
| Data   |
| Vr     |

modulisch

Si rende noto che il contenuto della presente tavola non potrà essere utilizzato o rappresentato in alcuna maniera divulgata a terzi o riprodotto integralmente o parzialmente senza il permesso scritto della proprietaria S.p.A. V. Riva, 21 & C. La stessa intende tutelare i suoi diritti a norma di legge.

|                |         |              |               |              |   |        |  |  |  |  |  |  |  |  |  |      |  |  |  |  |  |  |  |  |  |
|----------------|---------|--------------|---------------|--------------|---|--------|--|--|--|--|--|--|--|--|--|------|--|--|--|--|--|--|--|--|--|
| <i>Renoldi</i> | PIEDINO | PRESSER FOOT | PIED PRESSEUR | DRUECKERFUSS | <table border="1" style="font-size: small;"> <tr> <td>Indice</td> <td> </td> <td> </td> <td> </td> <td> </td> <td> </td> <td> </td> <td> </td> <td> </td> <td> </td> </tr> <tr> <td>Data</td> <td> </td> <td> </td> <td> </td> <td> </td> <td> </td> <td> </td> <td> </td> <td> </td> <td> </td> </tr> </table> | Indice |  |  |  |  |  |  |  |  |  | Data |  |  |  |  |  |  |  |  |  |
| Indice         |         |              |               |              |   |        |  |  |  |  |  |  |  |  |  |      |  |  |  |  |  |  |  |  |  |
| Data           |         |              |               |              |   |        |  |  |  |  |  |  |  |  |  |      |  |  |  |  |  |  |  |  |  |

**R300**

Foglio 33 Segue F.34

**921381-3-10**

Serve per  
Serves for  
Pour machines  
Dient fuer

327-00-1CD-02/135-81  
228-00-14/135-80

**921383-3-10**

Serve per  
Serves for  
Pour machines  
Dient fuer

327-00-1CD-03/135-81  
028-00-05/135-80

**921382-3-10**

Serve per  
Serves for  
Pour machines  
Dient fuer

327-00-1CD-05/135-81  
028-00-04/135-80  
228-00-02/135-80

**921395-3-11**

Serve per  
Serves for  
Pour machines  
Dient fuer

327-28-1CU-06/135-81  
028-28-03/135-80  
028-28-05/135-80  
028-28-06/135-80  
228-28-03/135-80  
228-28-05/135-80  
228-28-06/135-80

**921396-3-10**

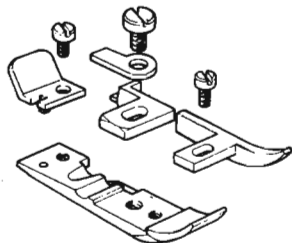

Serve per  
Serves for  
Pour machines  
Dient fuer

- 327-28-1CD-02/135-81
- 327-28-1CU-04/135-81
- 028-28-01/135-80
- 028-28-02/135-80
- 028-28-04/135-80
- 228-28-01/135-80
- 228-28-02/135-80
- 228-28-04/135-80

**921404-3-10**

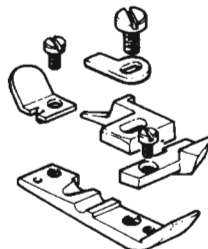

Serve per  
Serves for  
Pour machines  
Dient fuer

- 327-10-1CD-03/135-81
- 327-10-1CD-04/135-81
- 228-10-02/135-80
- 228-10-03/135-80

**921403-3-10**

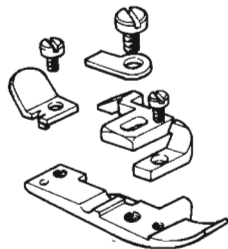

Serve per  
Serves for  
Pour machines  
Dient fuer

- 327-10-1CD-02/135-81
- 327-10-1CD-06/135-81
- 028-10-02/135-80
- 028-10-03/135-80
- 028-10-04/135-80
- 028-10-05/135-80
- 228-10-01/135-80
- 228-10-05/135-80
- 228-10-06/135-80
- 228-10-07/135-80

**921417-3-10**

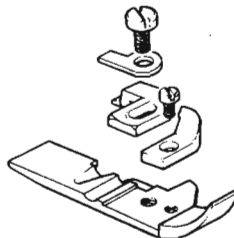

Serve per  
Serves for  
Pour machines  
Dient fuer

- 327-00-1CD-25/135-81

Si rende noto che il contenuto della presente tavola non potrà essere utilizzato o riprodotto senza permesso né con qualunque divieto a terzi o ristretto diritto di ristampare. La presente tavola è di proprietà della Rimoldi S.p.A. e con la stessa invade tutelare i suoi diritti a norma di legge.

modifiche

| Indice | Data | Vr |
|--------|------|----|
|        |      |    |
|        |      |    |
|        |      |    |
|        |      |    |
|        |      |    |



|  |  |  |
|--|--|--|
|  |  |  |
|  |  |  |
|  |  |  |

**Rimoldi****PIEDINO****PRESSER FOOT****PIED PRESSEUR****DRUECKERFUSS**

|            |  |  |  |               |              |
|------------|--|--|--|---------------|--------------|
| In d i c e |  |  |  | T A B E L L A | <b>R 300</b> |
|            |  |  |  |               |              |
| Data       |  |  |  | Foglio 35     | Segue F.36   |

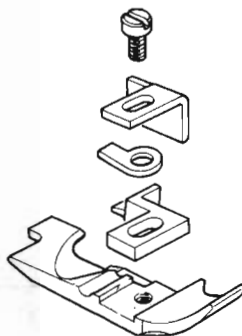
**921422-3-10**

Serve per  
Serves for  
Pour machines  
Dient fuer

327-00-1CD-06/135-81  
028-00-02/135-80  
228-00-04 /135-80

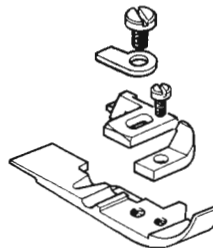
**921437-3-10**

Serve per  
Serves for  
Pour machines  
Dient fuer

327-28-1CD-11/135-81  
028-00-08/135-80  
228-00-08/135-80

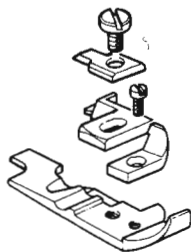
**921426-3-10**

Serve per  
Serves for  
Pour machines  
Dient fuer

327-00-1CD-31/135-81  
228-00-15/135-80

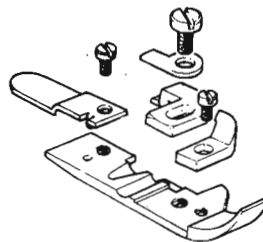
**921438-3-10**

Serve per  
Serves for  
Pour machines  
Dient fuer

327-00-1CD-09/135-81/137-81  
327-00-1CD-39/135-81/137-81  
028-00-06/135-80/137-80  
228-00-06/135-80/137-80  
228-00-17/135-80/137-80

Indice  
Data  
Vr

modifiche

Si rende noto che il contenuto della presente tavola  
non è destinato a essere divulgato a terzi o riprodotto  
in alcun modo, né integralmente o parzialmente senza l'autorizzazione scritta  
della stessa azienda tutelare i suoi diritti a norma di legge.

921439-3-10

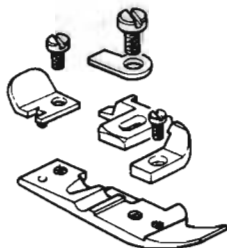

Serve per  
Serves for  
Pour machines  
Dient fuer

327-00-1CD-10/135-81/137-81  
028-00-07/135-80/137-80  
228-00-07/135-80/137-80

921453-3-10

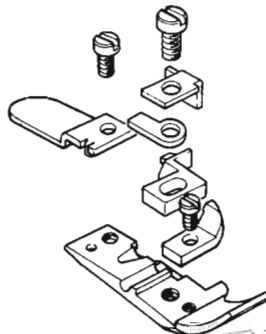

Serve per  
Serves for  
Pour machines  
Dient fuer

327-00-2CD-12/135-81  
327-00-2CD-18/135-81/137-81  
327-00-2CD-34/135-81/137-81  
028-00-09/135-80/137-80  
228-00-09/135-80/137-80

921440-3-10

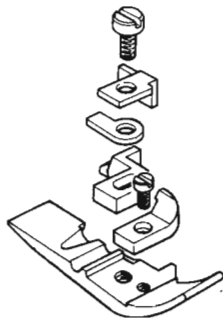

Serve per  
Serves for  
Pour machines  
Dient fuer

327-28-1CD-07/135-81  
028-28-07/135-80  
228-28-07/135-80

921455-3-10

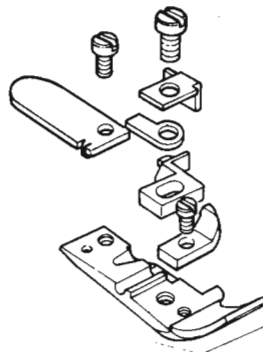

Serve per  
Serves for  
Pour machines  
Dient fuer

327-00-2CD-13/135-81/137-81  
028-00-10/135-80/137-80  
228-00-10/135-80/137-80

Si rende noto che il contenuto delle presentate tavole non potrà essere utilizzato o riprodotto senza permesso scritto dalla Rumoldi S.p.A. e che per l'uso di esse si integrano le condizioni di vendita e di distribuzione contenute nella stessa. Intende tutelare i suoi diritti e norme di legge.

modifiche

| V. | Data | Indice |
|----|------|--------|
|    |      |        |
|    |      |        |
|    |      |        |
|    |      |        |

|  |  |  |
|--|--|--|
|  |  |  |
|  |  |  |
|  |  |  |

|  |  |  |
|--|--|--|
|  |  |  |
|  |  |  |
|  |  |  |



**Remoldi**

PIEDINO

PRESSER FOOT

PIED PRESSEUR

DRUECKERFUSS

|        |           |        |             |
|--------|-----------|--------|-------------|
| Indice |           | T.A.B. | <b>R300</b> |
| Data   | Foglio 37 |        |             |

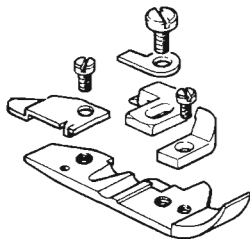
**921530-3-11**

Serve per  
Serves for  
Pour machines  
Dient fuer

228-00-18/135-80/137-80

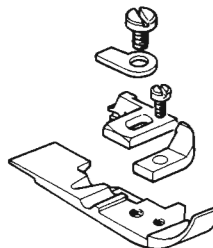
**923839-3-00**

Serve per  
Serves for  
Pour machines  
Dient fuer

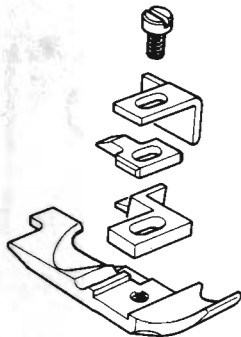
327-28-1CD-09/135-81  
228-28-10/135-80**923783-3-00**

Serve per  
Serves for  
Pour machines  
Dient fuer

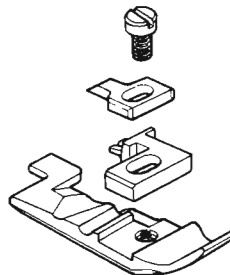
327-00-1MD-23/135-81  
028-00-18/135-80**923880-3-00**

Serve per  
Serves for  
Pour machines  
Dient fuer

327-00-2CD-41/135-81

Indice  
Data  
V.

Modifiche

Si rende noto che il contenuto della presente tavola non potrà essere utilizzato, appreso, copiato, né in alcun modo divulgato a terzi o riprodotto, sia integralmente che parzialmente, senza l'autorizzazione scritta della stessa, la quale si riserva espressamente il diritto di legge. La stessa intende tutelare i suoi diritti.



**Renoldi**

**PIEDINO**

**PRESSER FOOT**

**PIED PRESSEUR**

**DRUECKERFUSS**

|        |  |  |  |                        |             |
|--------|--|--|--|------------------------|-------------|
| Indice |  |  |  | TAB                    | <b>R300</b> |
|        |  |  |  |                        |             |
| Data   |  |  |  | Foglio 39   Segue F.40 |             |

**926781-3-00**

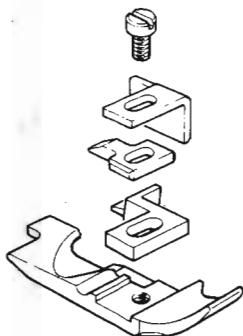

Serve per  
Serves for  
Pour machines  
Dient fuer

327-00-1CD-30/135-81  
327-00-1MD-33/135-81  
028-00-25/135-80  
228-00-13/135-80

*BLA 4*

**927252-3-00**

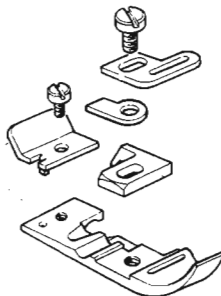

Serve per  
Serves for  
Pour machines  
Dient fuer

327-00-1CD-01/103-90  
327-00-1CD-07/103-90

**926900-3-00**

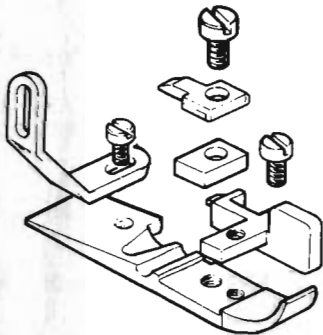

Serve per  
Serves for  
Pour machines  
Dient fuer

327-11-1CD-02/135-81

**941090-3-00**

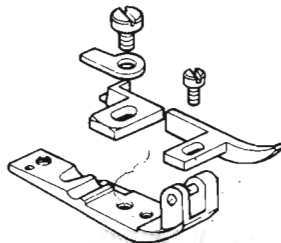

Serve per  
Serves for  
Pour machines  
Dient fuer

**228-28-12**

Modifiche  
Indice  
Data  
v,  
v,

Si rende noto che il contenuto della presente tavola, qualunque sia, è di proprietà esclusiva della Renoldi S.p.A. e non può essere divulgato a terzi o riprodotto, integralmente o parzialmente, senza il permesso scritto della stessa azienda tutelare i suoi diritti. Fine di legge.



CROCHET SUPERIORE  
UPPER LOOPER  
CROCHET SUPERIEUR  
OBERGREIFER

|  |  |
|--|--|
|  |  |
|  |  |
|  |  |
|  |  |



|  |  |
|--|--|
|  |  |
|  |  |
|  |  |
|  |  |

|  |  |
|--|--|
|  |  |
|  |  |
|  |  |
|  |  |

Si rende noto che il contenuto della presente tavola non potrà essere utilizzato o rappresentato né comunque, divulgato a terzi o riprodotto in qualsiasi forma senza il permesso scritto della proprietaria S.p.A. V. R. S. Di & C. La stessa intende tutelare i suoi diritti. Firma di legge.

**Rinoldi**

**CROCHET SUPER.**

**UPPER LOOPER**

**CROCHET SUP.**

**OBERGREIFER**

|        |          |             |
|--------|----------|-------------|
| Indice | TAB      | <b>R300</b> |
| 00     |          |             |
| Data   | Foglio 1 | Segue F. 2  |

**200760-0-10**

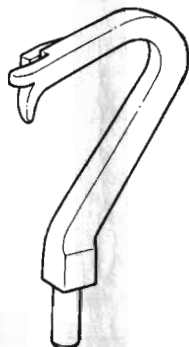

Serve per  
Serves for  
Pour machines  
Dient fuer

- 023-04-01
- 023-04-02
- 023-04-03
- 023-04-04
- 023-04-05

**202090-0-10**

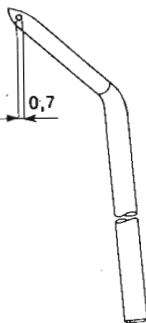

Serve per  
Serves for  
Pour machines  
Dient fuer

- 327-00-1CD-09
- 327-00-1CD-39
- 327-28-1CD-07
- 327-30-1CD-07
- 028-00-04
- 028-00-05
- 028-00-06
- 028-00-08
- 028-28-07
- 028-30-01
- 228-00-02
- 228-00-03
- 228-00-06
- 228-00-08
- 228-00-17
- 228-00-18
- 228-28-07

**203429-0-10**

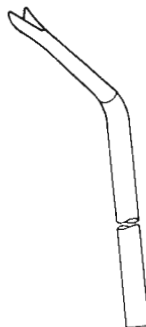

Serve per  
Serves for  
Pour machines  
Dient fuer

- 327-00-1CD-05
- 327-00-1CD-10
- 028-00-07
- 028-30-02
- 228-00-07

**203755-0-10**



Serve per  
Serves for  
Pour machines  
Dient fuer

- 028-00-18
- 028-00-19
- 028-01-08
- 028-28-10
- 028-28-11
- 228-00-16
- 228-28-08
- 228-28-11

**202092-0-10**

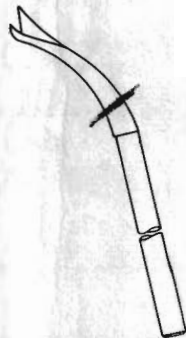

Serve per  
Serves for  
Pour machines  
Dient fuer

- 227-34-01
- 227-34-03
- 327-00-1CD-01
- 327-00-2CD-12/13/34/44
- 327-00-1MD-23
- 327-10-1CD-02/03/04/06
- 327-11-1CD-01/02
- 327-12-1CD-01
- 327-22-1MD-07
- 327-23-1MD-07
- 327-28-1CD-02
- 327-28-1CU-04/06
- 327-34-1MD-02/03
- 327-49-1MD-01
- 028-00-03/09/10/18/19/26
- 028-10-01/02/03/04/05
- 028-11-01
- 028-28-01/02/03/04/05/06/10/11
- 028-34-01
- 228-00-01/05/07/09/10/16
- 228-10-01/02/03/04/05/06/07/08
- 228-28-01/02/03/04/05/06/08/11/12
- 228-34-01
- 329-00-2CD-01/02/03/04/05/06/07/08/09/10/11/12/13/15
- 329-00-3MU-01
- 329-01-2CD-01/02
- 329-12-2CD-02
- 329-22-2CD-02/03/04
- 329-23-2CD-02/03/04

**203490-0-00**

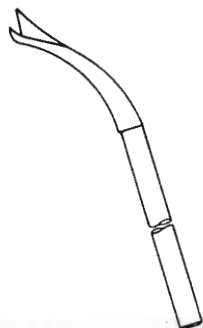

Serve per  
Serves for  
Pour machines  
Dient fuer

- 327-00-2MD-20
- 028-00-17

**203756-0-10**

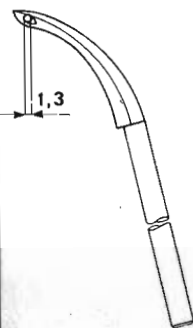

Serve per  
Serves for  
Pour machines  
Dient fuer

- 028-28-09
- 028-29-08
- 228-28-09

**Remoldi****CROCHET SUPER. UPPER LOOPER****CROCHET SUP.****OBERGREIFER**

|        |                     |             |
|--------|---------------------|-------------|
| Indice | TAB                 | <b>R300</b> |
| 00     |                     |             |
| Data   | Foglio 2 Sequenza 3 |             |

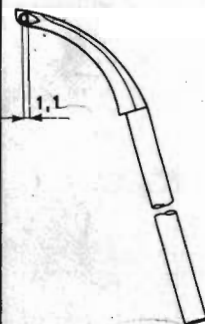
**204021-0-10**

Serve per - Serves for  
Pour machines  
Dient fuer

327-00-1CD-01/06/07/26/27/29  
327-00-2CD-15/18  
327-01-1CD-01/02  
327-01-2CD-06  
327-10-1CD-02/03/04  
327-11-1CD-02  
327-16-1CD-01  
327-22-1CD-01  
327-23-1CD-01  
327-28-1CD-02  
327-29-1CD-01/02/03  
327-34-1CD-01  
028-00-01/02/03/11/12/14/15  
16/21/22/24/25  
028-01-01/02/05/06  
028-10-02/03/04/05  
028-16-01  
028-28-02  
028-29-01/02/03  
228-00-01/04/05/12  
228-01-01  
228-10-01/02/03  
228-28-02/12

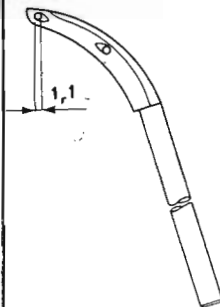
**204022-0-10**

Serve per  
Serves for  
Pour machines  
Dient fuer

327-00-2MD-20  
327-00-2MD-36  
327-01-2MD-07  
327-01-2MD-11  
028-00-17  
028-01-07

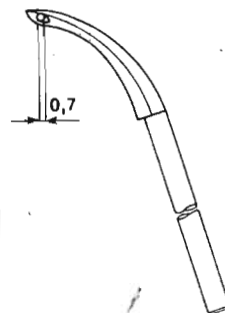
**206208-0-00**

Serve per  
Serves for  
Pour machines  
Dient fuer

327-00-2CD-14  
327-00-2CD-15  
327-00-2CD-16  
327-00-2CD-17  
327-00-2CD-39  
327-00-2CD-45  
327-00-2MD-21  
327-00-2MD-37  
327-01-2CD-10  
327-01-2CD-12

327-22-2CD-06  
327-23-2CD-06

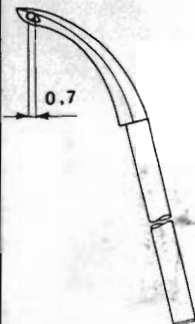
**204033-0-10**

Serve per - Serves for  
Pour machines  
Dient fuer

327-00-1CD-01/02/03/06/07/25/26  
27/29/30/31/32  
327-00-2CD-18/32/35/38/45  
327-01-1CD-03/04/05/06  
327-01-2CD-13  
327-10-1CD-02/03/04/06  
327-11-1CD-01/02  
327-12-1CD-01  
327-22-1CD-01/02/03/04/05  
327-23-1CD-01/02/08  
327-28-1CD-02/09  
327-28-1CU-04/06  
327-29-1CD-04/05/06/08  
028-00-02/03/11/12/13/14/15  
20/21/22/23/24/25/26  
028-01-03/04/05  
028-10-01/02/03/04/05  
028-11-01  
028-28-02/04/06  
028-29-04/05/06/07  
028-30-03/04/05/06  
228-00-01/04/05/11/12/13/14/15  
228-01-02/03/04  
228-10-01/02/03/04/05/06/07/08  
228-28-02/10/12  
228-34-01  
329-00-2CD-01/02/03/04/05/06  
07/08/09/10/11/12/13/15  
329-00-3MU-01  
329-01-2CD-01/02  
329-12-2CD-02  
329-22-2CD-02/03/04  
329-23-2CD-02/03/04

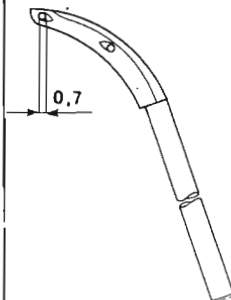
**204034-0-10**

Serve per  
Serves for  
Pour machines  
Dient fuer

327-00-2MD-36  
028-00-17  
028-01-07

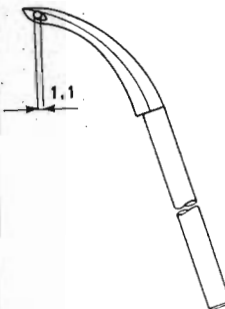
**206209-0-00**

Serve per  
Serves for  
Pour machines  
Dient fuer

327-00-2CD-14  
327-00-2CD-17  
327-00-2CD-45  
327-00-2MD-21  
327-00-2MD-37  
327-01-2CD-05

Si trova nota che il contenuto della presente tavola  
non deve essere ristampato o copiato senza permesso  
previa che parzialmente senza permesso. Questa  
tabella in modo speciale non deve essere ristampata  
senza permesso.

Indice

Data

V.

V.

V.

V.

V.

V.

V.

V.

V.

V.

V.

V.

V.

V.

V.

V.

V.

V.

V.

V.

V.

V.

V.

V.

V.

V.

V.

V.

V.

V.

V.

V.

V.

V.

V.

V.

V.

V.

V.

V.

V.

V.

V.

V.

**Rumoldi**

**CROCHET SUPER. UPPER LOOPER**

**CROCHET SUP.**

**OBERGREIFER**

|        |  |     |          |             |
|--------|--|-----|----------|-------------|
| Indice |  | TAB |          | <b>R300</b> |
| 00     |  |     |          |             |
| Data   |  |     | Foglio 3 | Segue F. —  |

**206512-0-00**

Serve per  
Serves for  
Pour machines  
Dient fuer

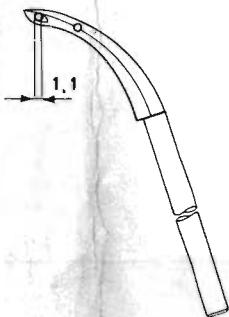

- 327-00-1MD-23
- 327-00-1MD-33
- 327-00-1MD-34
- 327-01-1MD-08
- 327-01-1MD-09
- 327-01-1MD-10
- 327-22-1MD-07
- 327-23-1MD-07
- 327-49-1MD-01

**207059-0-00**

Serve per  
Serves for  
Pour machines  
Dient fuer

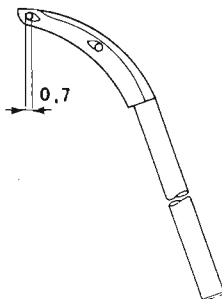

- 327-00-2CD-41

Serve per  
Serves for  
Pour machines  
Dient fuer

**206513-0-00**

Serve per  
Serves for  
Pour machines  
Dient fuer

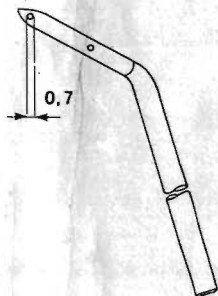

- 327-00-1CD-05
- 327-28-1CD-11

Serve per  
Serves for  
Pour machines  
Dient fuer

Serve per  
Serves for  
Pour machines  
Dient fuer

Si rende noto che il contenuto della presente tavola non potrà essere utilizzato o riprodotto senza permesso scritto dalla proprietaria S.p.A. V. R. 11 & C. La stessa intende tutelare i suoi diritti.

Indice  
Data  
V.



CROCHET INFERIORE  
LOWER LOOPER  
CROCHET INFERIEUR

202094-0-11

Serve per  
Serves for  
Pour machines  
Dient fuer

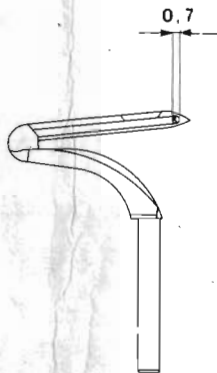

- 227-34-01
- 227-34-03
- 327-00-1CD-01/02/03/05/06/07/09  
10/25/26/27/29/30/31/32/39
- 327-00-1MD-23/33
- 327-00-2CD-14/15/16/17/18/32/34  
35/38/39/41/44/45
- 327-00-2MD-20/21/36/37
- 327-01-1CD-03/04/05/06
- 327-01-1MD-09/10
- 327-01-2CD-10/12/13
- 327-10-1CD-02/03/04/06
- 327-11-1CD-01/02
- 327-12-1CD-01
- 327-22-1CD-01/02/03/04/05
- 327-22-1MD-07
- 327-22-2CD-06
- 327-23-1CD-01/02/08
- 327-23-1MD-07
- 327-23-2CD-06
- 327-28-1CD-02/09
- 327-28-1CU-04/06
- 327-29-1CD-04/05/06/08
- 327-30-1CD-07
- 327-49-1MD-01
- 028-00-02/03/06/07/11/12/13/14/15  
17/18/20/21/22/23/24/25/26
- 028-01-03/04/05
- 028-10-01/02/03/04/05
- 028-11-01
- 028-28-01/02/03/04/05/06
- 028-29-04/05/06/07
- 028-30-03/04/05/06
- 228-00-01/04/05/06/07/11  
12/13/14/15/17
- 228-01-02/03/04
- 228-10-01/02/03/04/05/06/07/08
- 228-28-01/02/03/04/05/06/10/12

202095-0-11

Serve per  
Serves for  
Pour machines  
Dient fuer

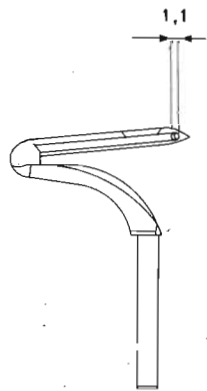

- 327-00-1CD-01/06/07/26/27/29
- 327-00-1MD-23/34
- 327-00-2CD-14/15/17/18/45
- 327-00-2MD-20/21/36/37
- 327-01-1CD-01/02
- 327-01-1MD-08
- 327-01-2CD-05/06
- 327-01-2MD-07/11
- 327-10-1CD-02/03/04
- 327-11-1CD-02
- 327-16-1CD-01
- 327-22-1CD-01
- 327-22-1MD-07
- 327-23-1CD-01
- 327-23-1MD-07
- 327-28-1CD-02
- 327-29-1CD-01/02/03
- 327-34-1CD-01
- 327-34-1MD-02/03
- 028-00-01/02/03/11/14/15/16/17/18  
19/21/22/24/25
- 028-01-01/02/05/06/07/08
- 028-10-02/03/04/05
- 028-16-01
- 028-28-01/02/09/10/11
- 028-29-01/02/03/08
- 028-34-01
- 228-00-01/04/05/12/16
- 228-01-01
- 228-10-01/02/03
- 228-28-01/02/08/09/11/12
- 228-34-01

Si rende noto che il contenuto della presente tavola non potrà essere utilizzato o rappresentato né con mezzi meccanici né elettronicamente senza l'autorizzazione scritta della proprietaria S.p.A. V. D. & C. La stessa intende tutelare i suoi diritti.



**S.p.A. VIRGINIO RIMOLDI & C.**

Via Vespri Siciliani, 9 - 20146 MILANO (ITALY)  
Telegr. VIRIMOLDI MILANO - Telex 33120 MILANO

Printed in Italy