



Union Special
INDUSTRIAL SEWING EQUIPMENT

STYLE

**ADJUSTING INSTRUCTIONS AND
ILLUSTRATED PARTS LIST**

63900A

63900B

63900C

63900D

63900AL

**63900 CLASS STREAMLINED HIGH SPEED
NEEDLE FEED LOCKSTICH MACHINES**

**CATALOG NO.
126M**

Catalog No. 126 M

INSTRUCTIONS

FOR

ADJUSTING AND OPERATING

LIST OF PARTS

CLASS 63900

Needle Feed
Streamlined Lockstitch

Styles

63900 A 63900 C
63900 B 63900 D
 63900 AL

Second Edition

Copyright 1963 & 1970
by
Union Special Corporation
Rights Reserved in All Countries

UNION SPECIAL CORPORATION
INDUSTRIAL SEWING MACHINES
CHICAGO

August, 1978

Printed in U.S.A.

FOREWORD

The predominant idea behind Union Special, is to build the best industrial machines in the world. The new high speed, streamlined Class 63900 lockstitch machines are a decided achievement along these lines. Parts are made to precision gauges, insuring complete interchangeability.

A few of the outstanding features are:

1. QUICK INSTALLATION

The average installation time required will be about 10 minutes from packing box to production sewing, if installation instructions are followed.

2. STREAMLINED DESIGN

Pleasing in appearance, this functional design provides greater stability and ruggedness, freedom from difficult-to-clean recesses. New neutral taupe finish is more restful to operator's eye.

3. SIMPLIFIED OILING

Lubrication of these machines is automatic. Oil is supplied to all moving parts for trouble free operation. A completely adjustable, double filtered hook oiling system provided long hook life. A single, large capacity, accurately gauged reservoir, sealed against lint and dust, reduces to a minimum oiling maintenance.

4. RAPID ACCELERATION

Precision methods in the manufacture of all parts, coupled with an advanced oiling system, makes possible top operating speed almost instantaneous for higher productive rates and lower costs.

5. PUSH BUTTON CONTROL

For quick, easy adjustment of the stitch length, a large, easy-to-read indicator dial is marked in stitch lengths, plus a readily accessible means for adjusting the needle feed.

It is the constant aim of Union Special to furnish concisely prepared information which enables customers to procure all possible advantages from the use of UNION SPECIAL machines. The following pages discuss valuable Adjusting and Operating data.

Adjusting Instructions for Mechanics, covering Styles in this catalog, call attention to many parts which must meet exacting conditional adjustments. Illustrations are used to pinpoint areas under discussion.

Exploded views, together with explanations as to quantity, part number and name, follow the Instructions, after which, is shown a collection of sewing part combinations, with recommendations experience has prompted us to recommend for a wide range of operations.

Union Special representatives, to be found in all leading manufacturing centers, are anxious to cooperate in planning and make estimates tailored to your requirements.

UNION SPECIAL CORPORATION

Engineering Department

IDENTIFICATION OF MACHINES

Each UNION SPECIAL machine is identified by a Style number on a name plate on the machine. Style numbers are classified as standard and special. Standard Style numbers have one or more letters suffixed, but never contain the letter "Z". Example: "Style 63900 A". Special Style numbers contain the letter "Z". When only minor changes are made in a standard machine, a "Z" is suffixed to the Standard Style number. Example: "Style 63900 AZ".

Styles of machines similar in construction are grouped under a Class number, which differs from the style number, in that it contains no letters. Example: "Class 63900".

APPLICATION OF CATALOG

This catalog applies specifically to the Standard Styles of machines as listed herein. It can also be applied with discretion to some Special Styles of machines in this class. Reference to direction, such as right, left, front, back, etc., are given from the operator's position while seated at the machine. Operating direction of handwheel is toward the operator.

STYLES OF MACHINES

High Speed Streamlined Long Arm Needle Feed Lockstitch Machines, One Needle, Light, Medium and Heavy Duty, Drop Feed, Rotary Hook, Horizontal Hook Shaft, Push Button Stitch Regulator, Slotted Segment for Adjusting Needle Feed, Stitch Length Indicator, One Reservoir Enclosed Automatic Lubricating System, Head Oil Siphon, Adjustable Hook Oil Control, Needle Bearing Adjustable Feed Eccentric, Needle Bearings for Take-up Lever and Needle Bar Driving Link, Feed Timing on Lower Main Shaft, Needle Feed Timing on Upper Shaft, Maximum Work Space to Right of Needle Bar 11 1/8 Inches.

- 63900 A Equipped with disc tension for needle thread. For miscellaneous plain seaming operations on light and medium weight work. 1 9/64 inch needle bar travel. Type 183 GXS or 183 GYS needles. Seam specification 301-SSa-1. Specify Style number, stitches per inch, thread size, needle type and size. Maximum recommended speed 5500 R. P. M.
- 63900 B Equipped with disc tension for needle thread. For miscellaneous plain seaming operations on medium and medium heavy weight work. 1 13/64 inch needle bar travel. Type 180 GXS or 180 GYS needles. Seam specification 301-SSa-1. Specify Style number, stitches per inch, thread size, needle type and size. Maximum recommended speed 5500 R. P. M.
- 63900 C Equipped with a rotary tension for needle thread. For miscellaneous plain seaming operations on light and medium weight work. 1 9/64 inch needle bar travel. Type 183 GXS or 183 GYS needles. Seam specification 301-SSa-1. Specify Style number, stitches per inch, thread size, needle type and size. Maximum recommended speed 5500 R. P. M.
- 63900 D Equipped with a rotary tension for needle thread. For miscellaneous plain seaming operations on medium and medium heavy weight work. 1 13/64 inch needle bar travel. Type 180 GXS or 180 GYS needles. Seam specification 301-SSa-1. Specify Style number, stitches per inch, thread size, needle type and size. Maximum recommended speed 5500 R. P. M.
- 63900 AL Same as Style 63900 C except fitted with a .025 inch eccentric (.050 inch throw) feed driving shaft.

NOTE: For the number necessary to complete the Styling of these 63900 machines, refer to Pages 6 and 7. The number indicates a certain sewing combination - presser foot, throat plate and feed dog. Specify the needle hole size if more than one is available.

NEEDLES

Each UNION SPECIAL needle has both a type number and a size number. The type number denotes the kind of shank, point, length, groove, finish and other details. The size number, stamped on the needle shank, denotes the largest diameter of the blade measured in thousandths of an inch across the eye. Collectively, the type number and the size number represent the complete symbol which is given on the label of all needles packaged and sold by Union Special.

Needle Type 180 GXS or 180 GYS is recommended for Styles 63900 B and D, and needle Type 183 GXS or 183 GYS is recommended for Styles 63900 A, C and AL. Their description and sizes available are listed below.

<u>Type No.</u>	<u>Description and Sizes</u>
180 GXS	Round shank, round point, lockstitch, short length, ball eye, single groove, wide angle groove, struck groove, deep spot, ball point, chromium plated - sizes 075/029, 080/032, 090/036, 100/040, 110/044, 125/049, 140/054, 150/060.
180 GYS	Round shank, round point, lockstitch, short length, ball eye, single groove, wide angle groove, struck groove, deep spot, chromium plated - sizes 075/029, 080/032, 090/036, 100/040, 110/044, 125/049, 140/054, 150/060.
183 GXS	Round shank, round point, lockstitch, extra short length, ball eye, single groove, wide angle groove, struck groove, deep spot, ball point, chromium plated - sizes 065/025, 075/029, 080/032, 090/036, 100/040, 110/044.
183 GYS	Round shank, round point, lockstitch, extra short length, ball eye, single groove, wide angle groove, struck groove, deep spot, chromium plated - sizes 075/029, 080/032, 090/036, 100/040, 110/044.

To have needle orders promptly and accurately filled, an empty package, a sample needle, or the type and size number should be forwarded. Use description on label. A complete order would read: "1000 Needles, Type 180 GXS, Size 080/032".

Selection of proper needle size should be determined by the size of the thread used. Thread should pass freely through the needle eye in order to produce a good stitch formation.

SELECTING THE SIZE OF THE NEEDLE

The strength requirement of the seam produced is largely dependent upon the size of the thread employed. The quality of the work desired is largely dependent upon the size of the needle employed.

The following table shows the preferred size of needle for a given size and kind of thread. The choice, however, should give consideration to factors referred to above, which may dictate the selection of a needle size slightly larger or smaller than the size specified.

<u>Cotton Thread Size</u>	<u>Mercerized Thread Size</u>	<u>Needle Size</u>
0	-	150/060
30	B	140/054 to 150/060
36	A	125/049 to 140/054
40	A	110/044 to 125/049
50	0	110/044 to 125/049
60	00	100/040 to 110/044
70	000	090/036 to 100/040
80	0000	080/032 to 090/036
90	0000	080/032 to 090/036
100	-	075/029 to 080/032

STYLE NUMBERS NECESSARY TO COMPLETE STYLING OF 63900 MACHINES

** Only Style numbers available for Style 63900 AL.

(AFTER EACH STYLE NUMBER IS LISTED THE PRESSER FOOT, THROAT PLATE AND FEED DOG MAKING UP THE SPECIFIC STYLE. WHERE MORE THAN ONE PART NUMBER IS SHOWN FOR A SPECIFIC STYLE, ONLY ONE WILL BE FURNISHED WITH EACH MACHINE. IN ALL CASES, THE STYLE NUMBER WILL BE LISTED AND THE PRESSER FOOT, FEED DOG AND THROAT PLATE MUST ALSO BE LISTED ON S. R.)

<u>STYLE NUMBER</u>	<u>PRESSER FOOT</u>	<u>FEED DOG</u>	<u>THROAT PLATE</u>	<u>STITCH RANGE</u>
** 1	61920 L	61926 D	*61928 B	12-16
** 2	61920 S	61926 D	*61928 B	12-16
** 2-A	L440 A			
** 2-B	61920 M			
** 3	61920 B	61926	*61928	11-18
** 3-A	61920 S			
** 4	61927 A	61926 A	*61928 A	11-18
** 4-A	61320 P			
** 4-B	61420 R			
** 4-C	61920 B			
5	61420 BT	61905 B-063 or 073 or 083	61924 B	7-18
5-A	L440 A			
6	61920 F	61905 F-063	61924 C	7-18
** 7	61920 J	61926	*61928	11-18
** 7-A	L471 A			
** 7-B	61920 P			
8	61920 B	61905 J-063	61924 J	7-18
9	61920 J	61905 J-063	61924 J	7-18
9-A	L471 A			
10	61920 A	61905 C-073	61924 C	7-18
10-A	61920 S			
11	61920 C	61905 C-073	61924 C	7-18
12	61920 S	61905 K-073 or 083	61924 K	7-18
12-A	61920 A			
12-B	61320 P			
13	61920 J	61905 E-073	61924 E	7-18
14	61920 J	61905 G-073 or 083	61924 G	7-18
15	61920 A	61905 B-063 or 073 or 083	61924 B	7-18
16	61920 R	61905 J-063	61924 J	7-18
**17	61920 N	61926 D	*61928 B	12-16
**18	61420 BT	61926	*61928	11-18
**18-A	61920 C			
**19	L310 A	61926	*61928	11-18
20	61320 P	61905 E-073	61924 E	7-18
20-A	61420 BT			
20-B	L440 A			
**21	61920 P	61926 C	*61928 B	12-16
**21-A	61920 S			
**21-B	61920 L			
**21-C	61420 BU			
**22	61920 M	61926 C	*61928 B	12-16

* Needle hole in throat plate (.053 needle slot)

<u>STYLE NUMBER</u>	<u>PRESSER FOOT</u>	<u>FEED DOG</u>	<u>THROAT PLATE</u>	<u>STITCH RANGE</u>
23 23-A	61420 BU 61920 S	61926 H	#61928 H or H-050	9-18
24	61420	61905 K-073 or 083	61924 K	7-18
25	61420 BT	61905 M-063	61924 E	7-18
26	61920 B	61905 C-073	61924 C	7-18
**27	61920 B	61926 C	*61928 B	12-16
28 28-A	61920 B 61920 A	61905 E-073	61924 E	7-18
29	61420 BT	61905 J-063	61924 J	7-18
**30 **30-A	61920 L 61920 A	61926	*61928	11-18
**31 **31-A	61420 AP 61920 M	61926	*61928	11-18
**32	61920 R	61926	*61928	11-18
**33	61920 M	61926 E	*61928 C	12-16
**34	61920 B	61926 T	*61928	11-18
**35	61920 M	61926 F	*61928 C	12-16
**36 **36-A	61420 BV 61420 BY	61926 C	*61928 B	12-16
**37	61420 BT	61926 D	*61928 B	12-16
38	61920 L	61905 J-063	61924 J	7-18
**39	61920 D	61926 D	*61928 B	12-16
40	63920 C	61926 R	*61928 R	7-20
**76	L460 A	61926 A	*61928 A	11-18
**77	L427 A	61926	*61928	11-18
78	61220 K	61905 H-063 or 083	61924 H	7-18
79	61920 T	61926 B	61928 M-073	6-10
80	L391 A	61926 B	#63928 E	6-10
81	61920 T	61926 B	61928 M-053	6-10
82	L391 A	61926 B	61928 M-053	6-10
**83	L347 A	61926 A	*61928 A	11-18
**84	61920 U	L379 A	† L378 A	12-18
85	61220 K	L582 A	† L581 A	7-18
86 86-A	61420 CM 61420 H	L582 A	† L581 A	7-18
**88	61920 G	61926 G	61928 G-060	10-25
**89	61920 K	61405 AC	61928 K-060	10-25
**90	61920 G	61926 G	61928 G-050	7-20
**91	61920 K	61405 AC	61928 K-050	7-20

* Needle hole in throat plate (.053 needle slot)

Needle hole in throat plate (.073 needle slot)

† Needle hole in throat plate (.063 needle slot)

NOTE: Style No. 88 is actually 29480 CM, Style No. 89 is actually 29480 CN, Style No. 90 is actually 29480 EN and Style No. 91 is actually 29480 EP.

IDENTIFYING PARTS

Where the construction permits, each part is stamped with its part number. Parts too small for a complete catalog stamping are identified by letter symbols which distinguish one part from another that is similar in appearance.

Part numbers represent the same part, regardless of catalog in which they appear.

IMPORTANT! ON ALL ORDERS, PLEASE INCLUDE PART NAME AND STYLE OF MACHINE FOR WHICH PART IS ORDERED.

ORDERING OF REPAIR PARTS

ILLUSTRATIONS

The arrangement of this catalog is to facilitate easy and accurate ordering of Class 63900 replacement parts.

Seven exploded view plates cover the Standard Styles listed in this catalog. Each plate presents a sector of the machine, parts being aligned as in their assembled position. Small keyline views show by a blackened area exactly where the parts being discussed fit in the assembled machine. On the page opposite the illustration will be found a listing of the parts with their part numbers, descriptions and the number of pieces required in the particular view being shown.

Numbers in the first column are reference numbers only, and merely indicate the position of the part in the illustration. Reference numbers should never be used in ordering parts. Always use the part number listed in the second column. Each exploded view plate carries a reference number for each part available for sale.

Sub-assemblies, which are sold complete, or by separate part, are in a bracket or a solid line box on the picture plate. Component parts of sub-assemblies, which can be furnished for repairs, are indicated by indenting their descriptions under the description of the main sub-assembly. Example:

20	29126 DD	Feed Driving Eccentric and Connecting Rod Assembly-----	1
21	61437 K	Feed Drive Eccentric (.092 inch throw)-----	1
22	61438 B	Feed Drive Eccentric Connecting Rod-----	1
23	88	Set Screw-----	1
24	660-225	Needle Bearing-----	1

In those cases where a part is common to all of the machines covered by this catalog, no specific usage will be mentioned in the description. However, when the parts for the various machines are not the same, the specific usage will be mentioned in the description, and, if necessary, the difference will be shown in the illustration.

At the back of the book will be found a numerical index of all the parts shown in this book. This will facilitate locating the illustration and description when only the part number is known.

USE GENUINE NEEDLES AND REPAIR PARTS

Success in the operation of these machines can be secured only with genuine UNION SPECIAL Needles and Repair Parts as furnished by the Union Special Corporation, its subsidiaries and authorized distributors. They are designed according to the most approved scientific principles, and are made with utmost precision. Maximum efficiency and durability are assured.

Genuine needles are packaged with labels marked *Union Special*. Genuine repair parts are stamped with the Union Special trademark, U S Emblem. Each trademark is your guarantee of the highest quality in materials and workmanship.

TERMS

Prices are strictly net cash and subject to change without notice. All shipments are forwarded f. o. b. shipping point. Parcel Post shipments are insured unless otherwise directed. A charge is made to cover the postage and insurance.

RECOMMENDED STYLE NUMBERS FOR SPECIFIC OPERATIONS

ARTICLE AND OPERATION	STYLE NUMBER	PRESSER FOOT	FEED DOG	THROAT PLATE	REMARKS
BAGS, Plastic Clothing, Shoe and Damper Binding	79	61920 T	61926 B	61928 M-073	
	80	L391 A	61926 B	#63928 E	
Hemming	33	61920 M	61926 E	*61928 C	
BLOUSES					
Runstitch collars	1	61920 L	61926 D	*61928 B	
Piece front facings and attach facings	1	61920 L	61926 D	*61928 B	
Hem right and left front facings	35	61920 M	61926 F	*61928 C	
Edgestitch right and left front facings and collar	83	L347 A	61926 A	*61928 A	
Attach collar	7	61920 J	61926	*61928	
COATS, Children's					
Make liner, make darts, join shoulders, set sleeves, close sleeve and sides	21-B	61920 L	61926 C	*61928 B	
Make collar and cuffs	21-B	61920 L	61926 C	*61928 B	
Seam, gore, join side seams, sew darts and plaits and join shoulders	27	61920 B	61926 C	*61928 B	
Attach lining to sleeves and front facings	27	61920 B	61926 C	*61928 B	
COATS, Ladies' Car					
Make lining, join sleeves, shoulders and side and back seams	1	61920 L	61926 D	*61928 B	
	37	61420 BT	61926 D	*61928 B	
Sew knit wristlets and collar to lining	8	61920 B	61905 J-063	61924 J	
Set pockets, make darts, sew knit facing to pocket backs	8	61920 B	61905 J-063	61924 J	
	21-B	61920 L	61926 C	*61928 B	
Set sleeves, close sleeves, attach collar, sew lining to front facings	8	61920 B	61905 J-063	61924 J	
	38	61920 L	61905 J-063	61924 J	
Edgestitch front and collar	33	61920 M	61926 E	*61928 C	

Needle hole in throat plate (.073 inch needle slot)

* Needle hole in throat plate (.053 inch needle slot)

CLASS 63900 (Page 2)

ARTICLE AND OPERATION	STYLE NUMBER	PRESSER FOOT	FEED DOG	THROAT PLATE	REMARKS
COATS, Boy's Sport Make lining, gore sleeves, set sleeves, close shoulders and side seams	1	61920 L	61926 D	*61928 B	
Make collar, gore sleeves, join shoulders and set pockets	21-B 27	61920 L 61920 B	61926 C 61926 C	*61928 B *61928 B	
Attach lining to front facings, seam back, close sleeves and side seam Edgestitch front and collar	21-B 33	61920 L 61920 M	61926 C 61926 E	*61928 B *61928 C	
COATS, Sport and Suit Seam sleeves, elbow seams, sleeve linings, seam back, side seams, front facings to lining, pocket facings	3-A 1 1	61920 S 61920 L 61920 L	61926 61926 D 61926 D	*61928 *61928 B *61928 B	
Hem yoke Lining	1	61920 L	61926 D	*61928 B	
COATS, Men's Top and Overcoats Make lining and back yoke Close and cord elbow seams and underarm seams	21-A 21-C 21-B 21-A 21-B	61920 S 61420 BU 61920 L 61920 S 61920 L	61926 C 61926 C 61926 C 61926 C 61926 C	*61928 B *61928 B *61928 B *61928 B *61928 B	
Sew lining and tape to vent					
Close back seam, side seams and cord stitch	21-A 21-B 36 36-A 21-B	61920 S 61920 L 61420 BV 61420 BY 61920 L	61926 C 61926 C 61926 C 61926 C 61926 C	*61928 B *61928 B *61928 B *61928 B *61928 B	

* Needle hole in throat plate (.053 inch needle slot)

CLASS 63900 (Page 4)

ARTICLE AND OPERATION	STYLE NUMBER	PRESSER FOOT	FEED DOG	THROAT PLATE	REMARKS
DRESSES, Uniform					
Close end of collar	32	61920 R	61926	*61928	
Attach pockets	7	61920 J	61926	*61928	
Attach right and left front facings	1	61920 L	61926 D	*61928 B	
Sew collar down	7	61920 J	61926	*61928	
JACKETS					
Runstitch collar, cuffs and flaps	10	61920 A	61905 C-073	61924 C	
	10-A	61920 S	61905 C-073	61924 C	
	12-A	61920 A	61905 K-073 or 083	61924 K	
	12	61920 S	61905 K-073 or 083	61924 K	
Attach collar and cuffs	10	61920 A	61905 C-073	61924 C	
	10-A	61920 S	61905 C-073	61924 C	
	12-A	61920 A	61905 K-073 or 083	61924 K	
	12	61920 S	61905 K-073 or 083	61924 K	
Sew down collar and cuffs	13	61920 J	61905 E-073	61924 E	
	14	61920 J	61905 G-073 or 083	61924 G	
Gore sleeves, close sleeves, side seam, set sleeves, shoulder joining	11	61920 C	61905 C-073	61924 C	
	12-A	61920 A	61905 K-073 or 083	61924 K	
Set pockets	10	61920 A	61905 C-073	61924 C	
Hem bottom	10-A	61920 S	61905 C-073	61924 C	
	11	61920 C	61905 C-073	61924 C	
	12-A	61920 A	61905 K-073 or 083	61924 K	
Edge stitch fronts	10	61920 A	61905 C-073	61924 C	
	10-A	61920 S	61905 C-073	61924 C	
	12-A	61920 A	61905 K-073 or 083	61924 K	
	12-B	61320 P	61905 K-073 or 083	61924 K	
Attach zippers	20	61320 P	61905 E-073	61924 E	
	20-A	61420 BT	61905 E-073	61924 E	
	20-B	L440 A	61905 E-073	61924 E	
JACKET LININGS, Rayon and Sateen					
Shoulder joining, gore sleeves, piece back panel, close sides and sleeves, set sleeves	1	61920 L	61926 D	*61928 B	
	25	61420 BT	61905 M-063	61924 E	

* Needle hole in throat plate (.053 inch needle slot)

CLASS 63900 (Page 5)

ARTICLE AND OPERATION	STYLE NUMBER	PRESSER FOOT	FEED DOG	THROAT PLATE	REMARKS
OUTERWEAR, Infant's					
Make lining, seam sleeves, sides and back	1	61920 L	61926 D	*61928 B	
Make collar flaps and topstitch	27	61920 B	61926 C	*61928 B	
Gore panels, topstitch panel, side seam	21-B	61920 L	61926 C	*61928 B	
Attach lining to front facings, attach collar, attach lining to bottom, close sleeves	21-B	61920 L	61926 C	*61928 B	
Attach waistband and stitch facings down	21-B	61920 L	61926 C	*61928 B	
PAJAMAS, Ladies' Woven					
Runstitch collar with piping	84	61920 U	L379 A	† L378 A	
Sew on front facings	1	61920 L	61926 D	*61928 B	
Attach pockets	7	61920 J	61926	*61928	
Attach waistband	7	61920 J	61926	*61928	
	7-A	L471 A	61926	*61928	
	7	61920 J	61926	*61928	
Topstitch band					
PAJAMAS, Men's					
Runstitch collar	1	61920 L	61926 D	*61928 B	
	3	61920 B	61926	*61928	
Attach pockets	7	61920 J	61926	*61928	
Attach collar	1	61920 L	61926 D	*61928 B	
Stitch down collar	9	61920 J	61905 J-063	61924 J	
	7	61920 J	61926	*61928	
Hem cuffs	78	61220 K	61905 H-063 or 083	61924 H	
PANTS, Work					
Front and hip pocket facings	21-B	61920 L	61926 C	*61928 B	
	7	61920 J	61926	*61928	
Set and cord front pockets	21-B	61920 L	61926 C	*61928 B	
Hang front pockets	22	61920 M	61926 C	*61928 B	
	21-B	61920 L	61926 C	*61928 B	
	23	61420 BU	61926 H	*61928 B	
Set hip pockets	78	61220 K	61905 H-063 or 083	# 61928 H or H-050	
	86	61420 CM	L582 A	61924 H	
	86-A	61420 H	L582 A	† L581 A	

Needle hole in throat plate (.073 inch needle slot)
 † Needle hole in throat plate (.063 inch needle slot)
 * Needle hole in throat plate (.053 inch needle slot)

CLASS 63900 (Page 6)

ARTICLE AND OPERATION	STYLE NUMBER	PRESSER FOOT	FEED DOG	THROAT PLATE	REMARKS
PANTS, Work (Continued)					
Attach waistband	23	61420 BU	61926 H	#61928 H or H-050	
	23-A	61920 S	61926 H	#61928 H	
Topstitch left fly	1	61920 L	61926 D	or H-050	
	23	61420 BU	61926 H	*61928 B #61928 H	
	23-A	61920 S	61926 H	or H-050 #61928 H	
Topstitch waistband	24	61420	61905 K-073 or 083	or H-050	
	23	61420 BU	61926 H	61924 K #61928 H	
	21-B	61920 L	61926 C	or H-050 *61928 B	
PANTS, Boy's Dress					
Pocket facings, set front pockets	1	61920 L	61926 D	*61928 B	
Topstitch left fly	34	61920 B	61926 T	*61928	
Attach waistband to fronts, close seat seam	34	61920 B	61926 T	*61928	
Topstitch waistband	21	61920 P	61926 C	*61928 B	
	21-B	61920 L	61926 C	*61928 B	
PANTS, Dress and Slacks (Including Wash and Wear)					
Front and hip pocket facings	1	61920 L	61926 D	*61928 B	
	7	61920 J	61926	*61928	
Set and cord front pockets	2	61920 S	61926 D	*61928 B	
	1	61920 L	61926 D	*61928 B	
	1	61920 L	61926 D	*61928 B	
Attach right and left fly	21-B	61920 L	61926 C	*61928 B	
	17	61920 N	61926 D	*61928 B	
	2-A	L440 A	61926 D	*61928 B	
Attach waistband	1	61920 L	61926 D	*61928 B	
	2	61920 S	61926 D	*61928 B	
Side seam and inseam	1	61920 L	61926 D	*61928 B	
	18	61420 BT	61926 D	*61928 B	
Topstitch left fly				*61928	
Needle hole in throat plate (.053 needle slot)					
Needle hole in throat plate (.073 needle slot)					

CLASS 63900 (Page 7)

ARTICLE AND OPERATION	STYLE NUMBER	PRESSER FOOT	FEED DOG	THROAT PLATE	REMARKS
ROBES, Ladies'					
Bind collar and cuffs, front panels and bottoms	81	61920 T	61926 B	61928 M-053	
	82	L391 A	61926 B	61928 M-053	
Hem bottom	31	61420 AP	61926	*61928	
	31-A	61920 M	61926	*61928	
Sew collar down	9	61920 J	61905 J-063	61924 J	
	9-A	L471 A	61905 J-063	61924 J	
SHIRTS, Dress and Sport					
Runstitch collar	1	61920 L	61926 D	*61928 B	1/4 inch margin
	3	61920 B	61926	*61928	3/16 inch margin
Topstitch collar	4	61927 A	61926 A	*61928 A	1/16 inch margin
	4-A	61320 P	61926 A	*61928 A	1/8 inch margin
	4-B	61420 R	61926 A	*61928 A	3/32 inch margin
	4-C	61920 B	61926 A	*61928 A	3/16 inch margin
	1	61920 L	61926 D	*61928 B	1/4 inch margin
	2-B	61920 M	61926 D	*61928 B	1/4 inch margin
Attach collar band	5	61420 BT	61905 B-063 or 073 or 083	61924 B	
	5-A	L440 A	61905 B-063 or 073 or 083	61924 B	
Join shoulders (one operation)	2-B	61920 M	61926 D	*61928 B	
	6	61920 F	61905 F-063	61924 C	
Topstitch collar band	39	61920 D	61926 D	*61928 B	Attachment req.
	7	61920 J	61926	*61928	
	7-B	61920 P	61926	*61928	
Attach collar (first operation)	1	61920 L	61926 D	*61928 B	
Stitch down collar (second operation)	7	61920 J	61926	*61928	
	7-B	61920 P	61926	*61928	
Runstitch cuffs	2-B	61920 M	61926 D	*61928 B	
	1	61920 L	61926 D	*61928 B	
	3	61920 B	61926	*61928	
Topstitch cuffs	4	61927 A	61926 A	*61928 A	
	1	61920 L	61926 D	*61928 B	
Hem bottom	76	L460 A	61926 A	*61928 A	1/8 inch hem
Hem button front	2-B	61920 M	61926 D	*61928 B	

* Needle hole in throat plate (.053 inch needle hole)

CLASS 63900 (Page 8)

ARTICLE AND OPERATION	STYLE NUMBER	PRESSER FOOT	FEED DOG	THROAT PLATE	REMARKS
SHIRTS, Dress and Sport (Continued)					
Attach facing to left front	2-B	61920 M	61926 D	*61928 B	
Quilt collar band	1	61920 L	61926 D	*61928 B	
Set pockets	7	61920 J	61926	*61928	
Hem top of pockets	7	61920 J	61926	*61928	
Attach sleeve facings (continuous)	85	61220 K	L582 A	† L581 A	
SHIRTS, Knit Sport					
Attach front facings	8	61920 B	61905 J-063	61924 J	
Runstitch cuffs and collar	8	61920 B	61905 J-063	61924 J	
Attach and stitch down collar and cuffs	9	61920 J	61905 J-063	61924 J	
Set pockets	9	61920 J	61905 J-063	61924 J	
SHIRTS, Work and Heavy Sport					
Runstitch and top stitch collar and cuffs	11	61920 C	61905 C-073	61924 C	1/4 inch margin
	10	61920 A	61905 C-073	61924 C	1/4 inch margin
	12-A	61920 A	61905 K-073 or 083	61924 K	1/4 inch margin
Attach collar and cuffs	10	61920 A	61905 C-073	61924 C	
	12-A	61920 A	61905 K-073 or 083	61924 K	
	13	61920 J	61905 E-073	61924 E	
Sew down collar and cuffs	14	61920 J	61905 G-073 or 083	61924 G	
Attach collar band	15	61920 A	61905 B-063 or 073	61924 B	
	19	L310 A	61926	*61928	
Hem work shirts	77	L427 A	61926	*61928	
SHORTS AND SLACKS, Ladies'					
Attach facings to pockets	27	61920 B	61926 C	*61928 B	
Attach pockets	28-A	61920 A	61905 E-073	61924 E	
Attach and close pockets	27	61920 B	61926 C	*61928 B	
Attach elastic to waistband and finish band	26	61920 B	61905 C-073	61924 C	
	23	61420 BU	61926 H	#61928 H	or H-050
SHORTS, Men's Woven					
Form right and left fly	7	61920 J	61926	*61928	
	7-B	61920 P	61926	*61928	

* Needle hole in throat plate (.053 needle slot)
 † Needle hole in throat plate (.063 needle slot)
 # Needle hole in throat plate (.073 needle slot)

CLASS 63900 (Page 9)

ARTICLE AND OPERATION		STYLE NUMBER	PRESSER FOOT	FEED DOG	THROAT PLATE	REMARKS
SHORTS, Men's Woven (Continued)						
	French band hem	18	61420 BT	61926	*61928	
	Attach waistband	2-B	61920 M	61926 D	*61928 B	
	SHIRTS, Ladies' Cotton and Wool	3	61920 B	61926	*61928	
	Make bows, sew lining to back, attach waistband and stitch down band					
	SLIPS, Cotton and Woven Synthetic Material	1	61920 L	61926 D	*61928 B	
	Topstitch right and rear side panels					
	SNOW SUITS, Children's Lined	7-B	61920 P	61926	*61928	
	Make liner, attach sleeves, seat seam, side and center seam					
	Attach hood, hood lining, cuffs and anklets	1	61920 L	61926 D	*61928 B	
	Edgestitch fronts	12	61920 S	61905 K-073 or 083	61924 K	
	SWEATERS, Ladies' Cardigan	12-A	61920 A	61905 K-073 or 083	61924 K	
	Attach button and buttonhole facings	33	61920 M	61926 E	*61928 C	
	SWIM SUITS, Ladies' Woven	16	61920 R	61905 J-063	61924 J	
	Make shoulder straps					
	Close back seam	18	61420 BT	61926	*61928	
		18-A	61920 C	61926	*61928	
		30	61920 L	61926	*61928	
		30-A	61920 A	61926	*61928	
	SWIM SUITS, Ladies' Knit	28	61920 B	61905 E-073	61924 E	
	Sewing bra lining to fronts	28-A	61920 A	61905 E-073	61924 E	
		29	61420 BT	61905 J-063	61924 J	
	Seam bra lining	1	61920 L	61926 D	*61928 B	
	Make shoulder straps	18	61420 BT	61926	*61928	
	Join lining and trunks	1	61920 L	61926 D	*61928 B	
	Close bra darts	1	61920 L	61926 D	*61928 B	
	Close top of swim suit	1	61920 L	61926 D	*61928 B	

* Needle hole in throat plate (.053 needle slot)

INSTALLING

CAUTION! When unpacking, DO NOT lift machine out of box by placing one hand on handwheel. Using both hands on bed casting, lift gently.

Before leaving factory, each UNION SPECIAL machine is sewed off, inspected and carefully packed. After the machine and accessories have been removed from the packing box, the following steps should be followed:

PREPARATION OF MACHINE FOR INSTALLATION

A bag of assembly parts, consisting of one frame thread eyelet, one eyelet attaching screw, one extra bobbin, two hinge studs, and two screws for holding miscellaneous attachments to the bed plate, is packed with each machine.

Insert hinge studs in holes provided for them in rear of cloth plate. Assemble the upper frame eyelet (A, Fig. 2 or 2A).

STANDARD ACCESSORIES

Included also with each machine is box of STANDARD ACCESSORIES--containing one bobbin winder assembly, the machine mounting frame, one oil drain jar and its clamp spring, one knee lifter assembly and its rubber pad, bed positioning spring and screw, four isolator pads and clips, and one machine rest pin. These parts are essential when setting up the machine.

TABLE TOPS

Lockstitch machines are installed in table tops, prepared with cut-out, so that the bed plate is FLUSH with the top of the machine mounting frame.

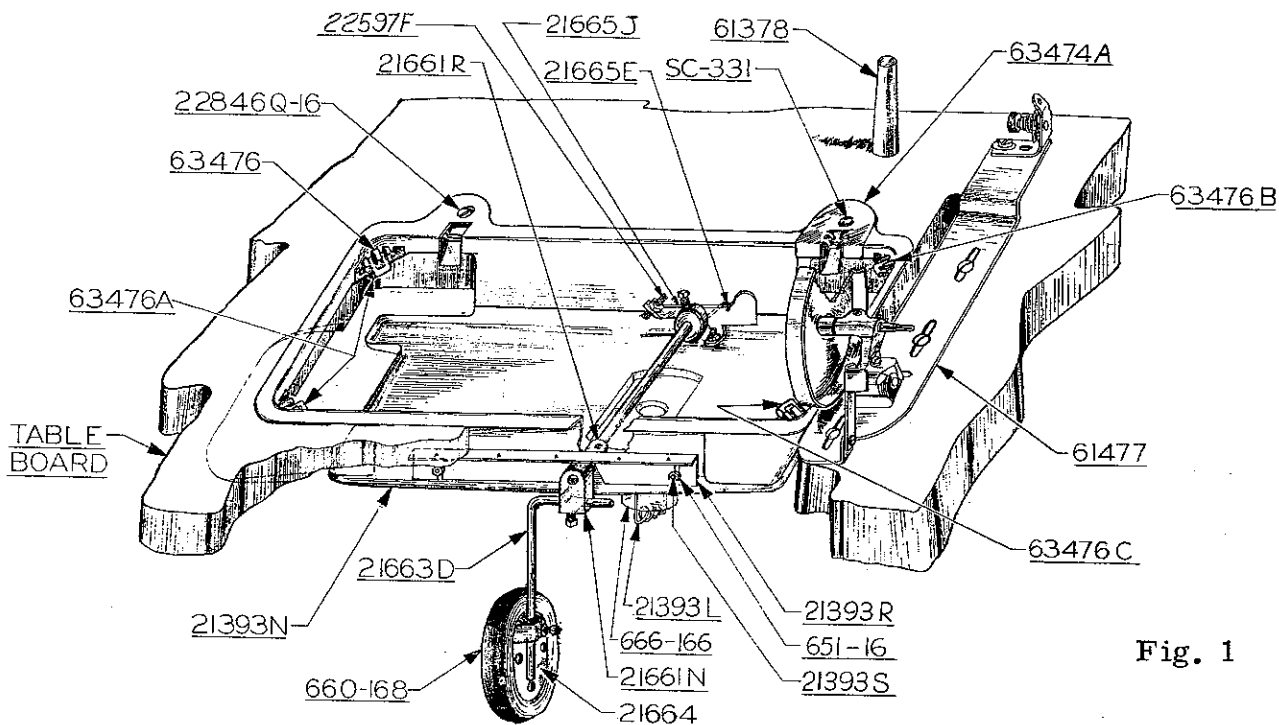

Fig. 1

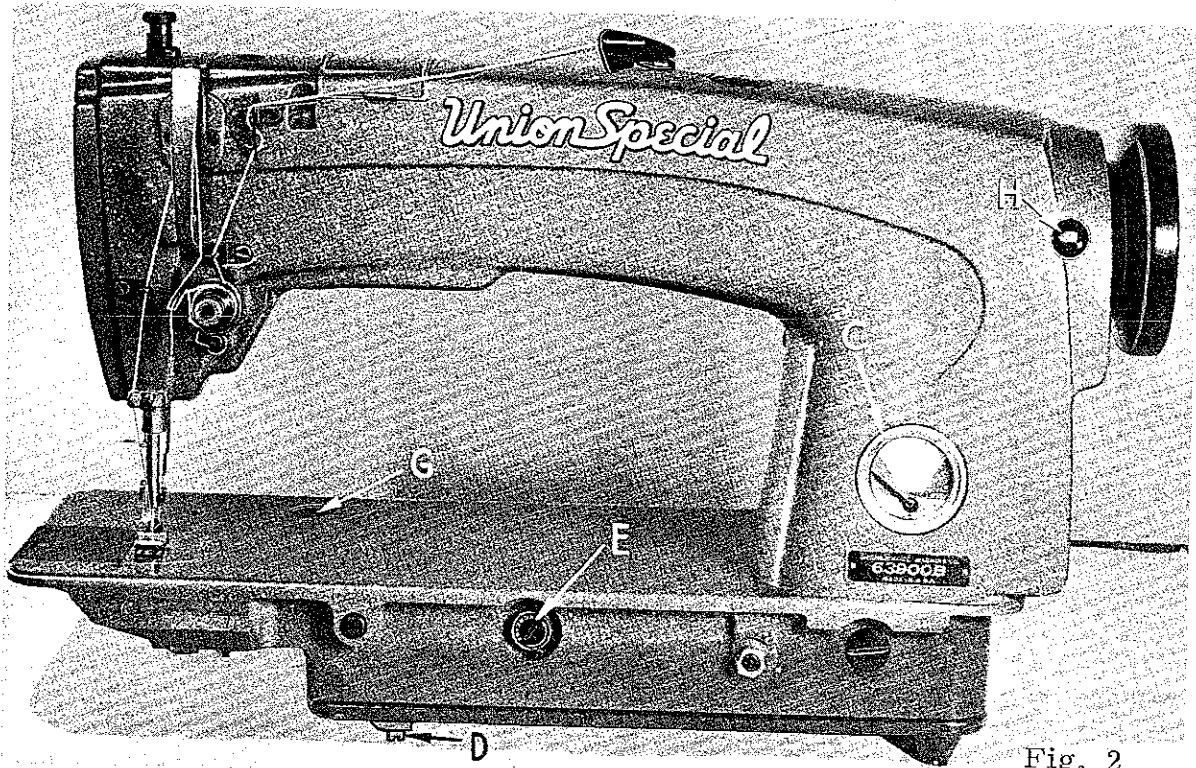
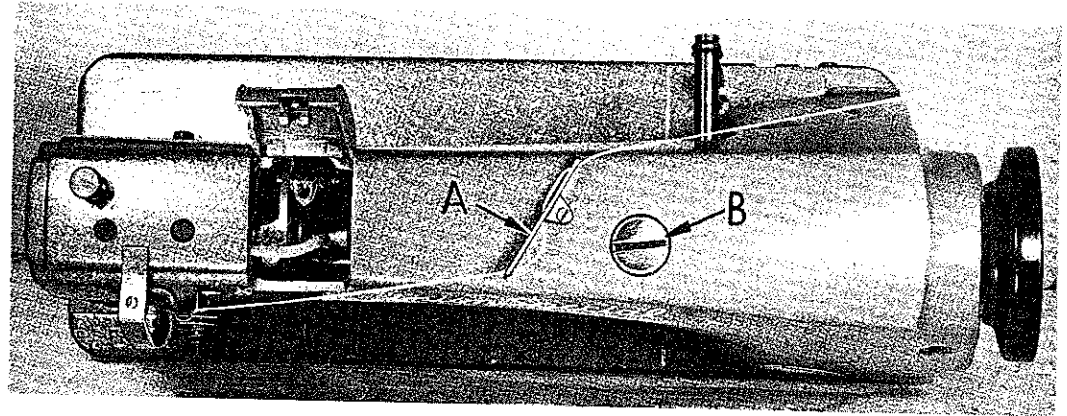
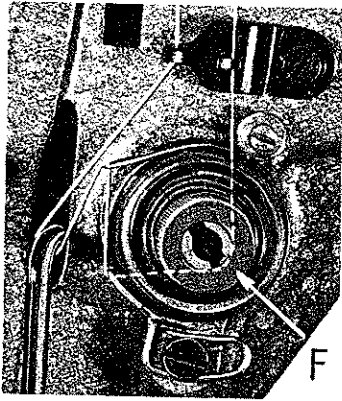

Fig. 2

MACHINE MOUNTING FRAME INSTALLATION

On a suitable tableboard, place machine mounting frame (21393 N) in the machine cut-out with the hinge lugs to the rear (Fig. 1). Insert the countersunk wood screw through left hinge pad and tighten securely. Assemble bed positioning spring (63474 A) over right hinge pad; insert round head wood screw and tighten securely. Assemble the retaining plate (21393 R) to outside front of pan section, as shown, and snug up nuts lightly.

Place sewing head in the frame mounting, and after being sure there is about 1/16 inch clearance between the cloth plate edge and the frame sides, rap the retaining plate smartly upward with a hammer to insure a good grip on the underside of the board and tighten locking nuts securely.

Tip machine back against rest pin, and assemble the knee press assembly as shown. All end play of the cross shaft should be taken up by the cone bearings, but must not bind.

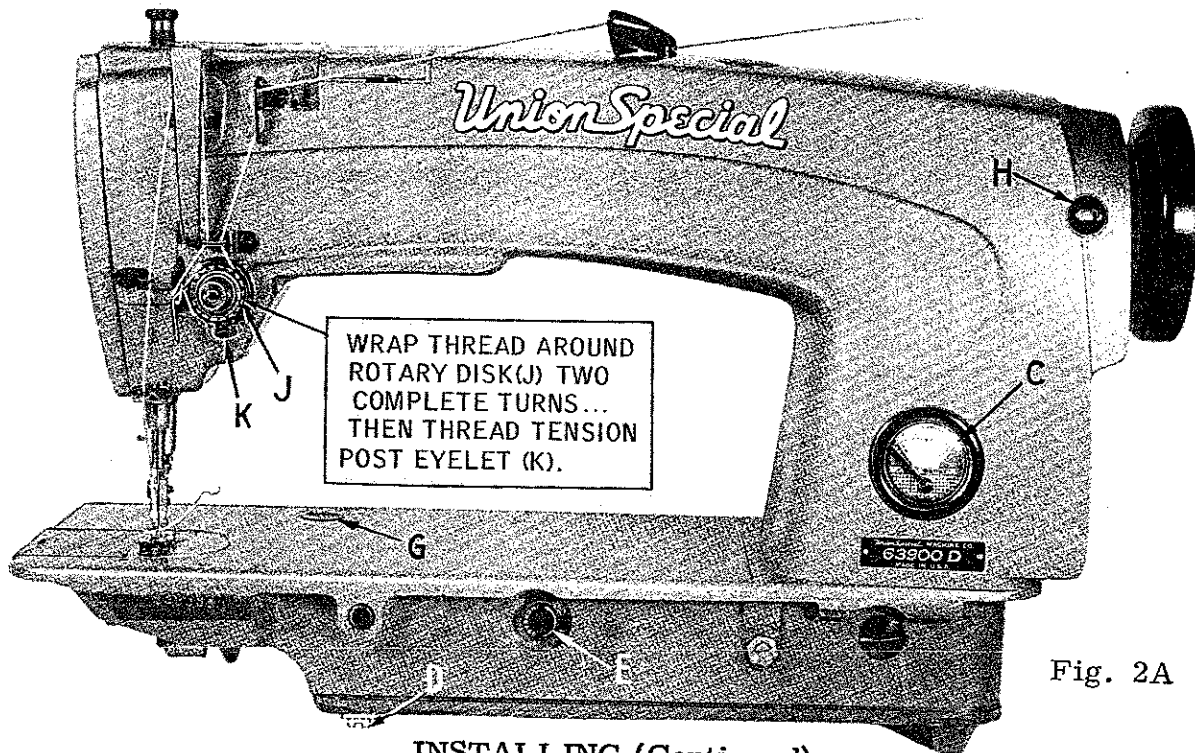
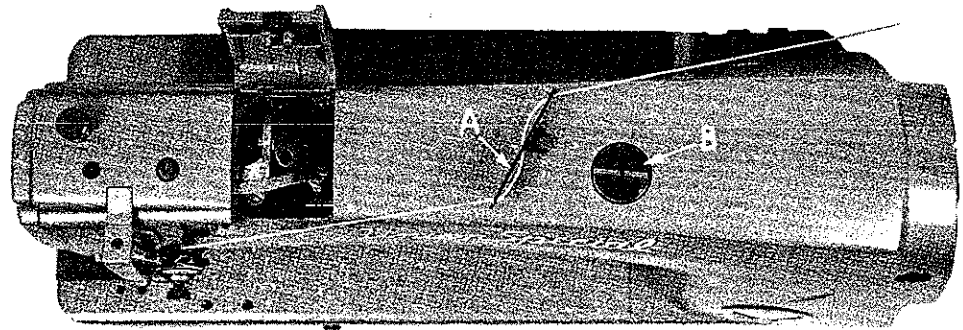
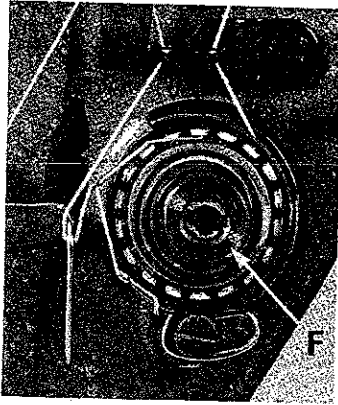

Fig. 2A

INSTALLING (Continued)

MACHINE MOUNTING FRAME INSTALLATION (Continued)

Before the machine is put into production, the bell crank (21665 J) of the knee lifter rod should be adjusted. The left stop screw (22597 F) should be set so that the maximum lift of the presser bar and its parts do not interfere with moving parts within the head. This may be done by setting the stop screw so that the presser bar raises approximately 5/16 inch.

BOBBIN WINDER

The bobbin winder should be secured to the table top so that its pulley will be located directly in front of the sewing machine belt and will bear against the belt when in operation. The base of the winder has two elongated attaching holes, which allow the mechanism to be moved closer to or farther away from the belt as needed. The pulley of the winder, when in operation, should exert only enough pressure against the belt to wind the bobbin. Regulation and operation of the bobbin winder is described under "Winding the Bobbin", under OPERATOR'S INSTRUCTIONS.

BELTS

These machines are equipped to use either #1 "Vee" or round belts.

THREADING

Thread machine Styles 63900 A and B as indicated in Fig. 2.

Thread machine Styles 63900 C, D and AL as indicated in Fig. 2A, noting that these machines are equipped with a rotary needle tension assembly, to insure proper thread handling, the thread should be wound TWICE around the rotary tension disc.

Threading at check spring has been enlarged in both Figures for clarity. Needle is threaded from left to right.

LUBRICATION

CAUTION! Oil has been drained from the main reservoir before shipment, so the reservoir must be filled before starting to operate.

Lubricate machine thoroughly, in accordance with instructions which follow, and run slowly for several minutes to distribute the oil to the various parts. Full speed operation can then be expected without damage.

RECOMMENDED OIL

Use a stainless water-white straight mineral oil of a Saybolt viscosity of 90 to 125 seconds at 100° Fahrenheit in the main reservoir. This is equivalent to Union Special specification No. 175. Fill main reservoir at plug screw (B, Fig. 2 or 2A) and check oil level at gauge (C). Oil is at maximum level when needle is in yellow band marked "FULL". Oil should be added when needle is in yellow band marked "LOW".

It is recommended that a new machine, or one that has been out of service for an extended period, be lubricated as follows: Remove the head cover and directly oil the bearings of the needle bar link, take-up and its lever and needle bar. Replace end cover as no further hand oiling will be required.

Oil may be drained from main reservoir by removing plug screw (D, Fig. 2 or 2A).

OIL GAUGE

The oil gauge is set at the factory to show the proper oil level in the reservoir. Should an adjustment become necessary, the following steps should be followed:

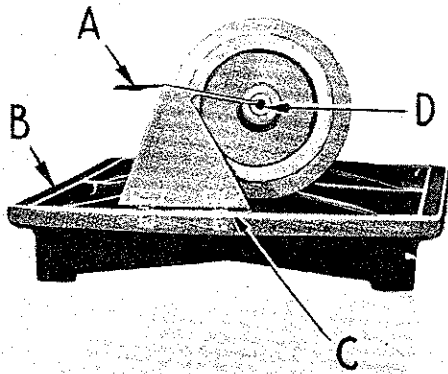

Fig. 3

1. Place the machine upright on a level table or bench.
2. Remove the reservoir plug screw (located below the handwheel and near the bottom of the machine).
3. Oil should be added or removed so that the oil level is approximately 1/8 inch below the bottom edge of the hole.
4. Loosen the lock nut on the calibrating screw, and turn the screw left or right so that the gauge needle rests on the yellow band marked "FULL" on gauge (C, Fig. 2 or 2A).
5. Tighten lock nut and replace plug screw.

Lubrication of the mechanism below the cloth plate is automatically accomplished through the feed driving shaft (D, Fig. 3), which is tubular. Oil is introduced into the shaft at the sprocket end by means of an oil distributing plate (A, Fig. 3) which is secured to the bottom cover (B) by means of two screws (C).

Should it become necessary to remove the reservoir cover, it is imperative that the adjustment of the oil distributing plate (A) be checked very carefully. This can be done by removing the large plug screw at the right end of the reservoir and looking through the hole. The low point of the oil distributing plate must be even with or slightly below the center of the shaft (D) and just touching it.

SELF-PRIMING HEAD OIL SIPHON

Class 63900 machines are equipped with a self-priming head oil siphon. When the machine is started, oil splashes on the priming cup felt, filters through the felt and trickles down the vertical oil tube, thus priming the siphon. Once the prime is established, it is maintained unless the felt is removed. The siphon operates twenty-four hours a day, removing oil at the rate of six to twelve drops per minute, which, of course, far exceeds the rate at which oil collects in the head.

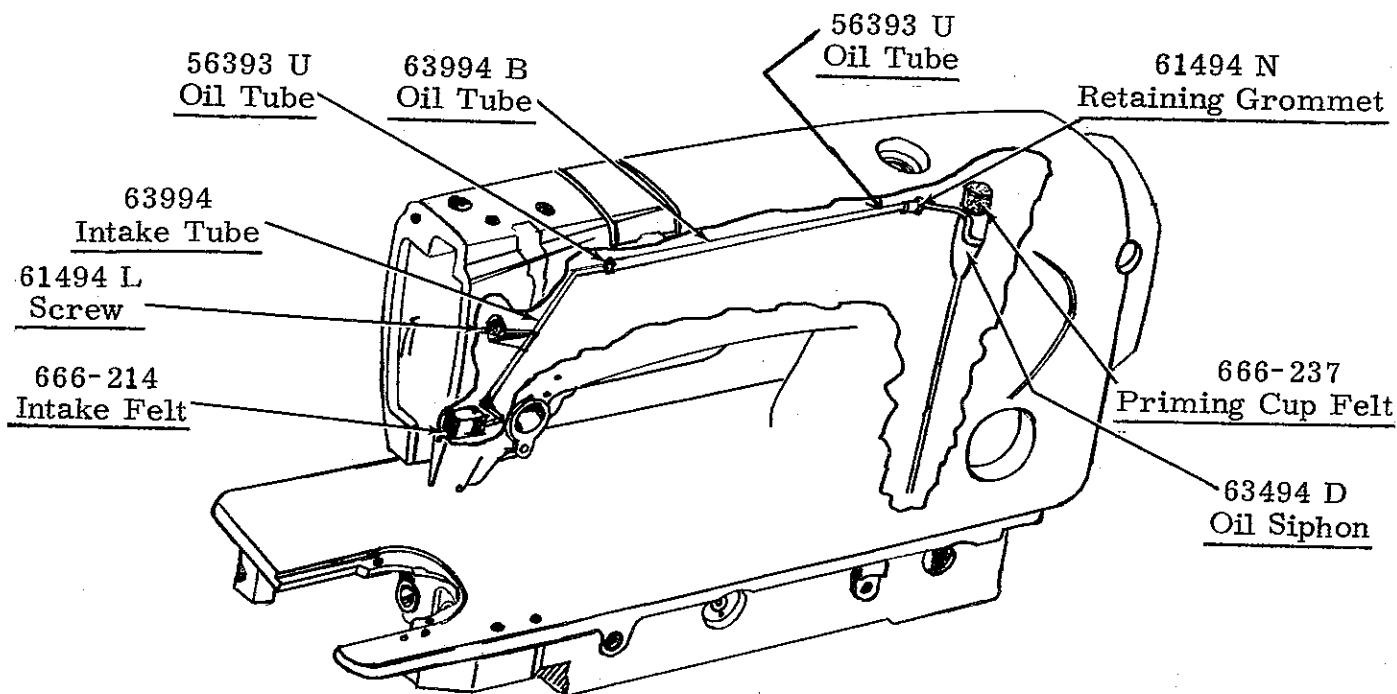

INSTALLING AND MAINTENANCE OF OIL SIPHON

A newly installed siphon starts its action within three to five minutes after the machine is operating. However, it may be twenty minutes or so before all the air is removed from the line and the siphon is in full operation. Within an hour, there should be a distinct reduction of the oil in the head sump. If the siphon does not function, determine if the siphon intake tube, located in the head, is inserted in the felt block and that the plastic tube is connected at both ends. If the above two items do not correct the siphon, replace the siphon felts as described below.

The felt in the priming cup is designed for a specific purpose. This felt, 666-237, is to meter the flow of priming oil and to prevent the entrance of air. The felt also acts as a filter and keeps the siphon clear of lint.

If the priming cup felt and the intake felt (666-214) becomes contaminated with an excessive amount of lint, it may be necessary to replace the felts. The priming cup felt is replaced by removing access plug at back of machine and replacing felt 666-237. For the best initial self-priming condition, the felt of the siphon should be installed dry. The intake felt is replaced by removing the end cover.

However, if for some reason the priming cup felt has been oiled before installing, the siphon may fail because air is trapped in the felt. As a precaution, remove the felt from the cup. Then, while squeezing the felt between the fingers, saturate it well with oil. In other words, squeeze out the air and replace it with oil. This prevents the trapping of air, and no trouble should be experienced when starting the siphon.

INSTRUCTIONS FOR OPERATORS

THREAD

While the direction of the twist in the bobbinthread is immaterial, the direction of the hook rotation favors the use of a left twist thread in the needle. To determine the direction of twist, grasp a short length of thread between thumb and forefinger of each hand. Turn the thread away from you with your right hand. If the strands unwind, it is a left twist, if not, it is a right twist.

REMOVING THE BOBBIN CASE

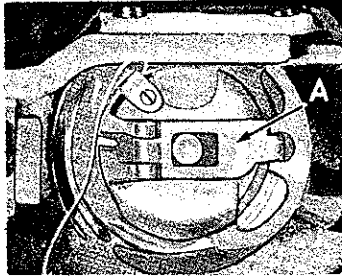

Fig. 4

To remove the bobbin case, turn handwheel in operating direction until the needle reaches its highest position. Using the left hand, reach under the table, open the bobbin case latch (A, Fig. 4), and pull the bobbin case out of the sewing hook.

Opening the latch retains the bobbin in the case. When the latch is closed, the bobbin is released and can readily be removed.

WINDING THE BOBBIN

Thread the bobbin winder by leading the thread from the supply down through the eyelet (A, Fig. 5), down between the tension discs, and under the tension post. Press an empty bobbin on the winder shaft (B) up to the stop, wind the end of thread around the bobbin a few turns in a clockwise direction, and press downwardly on hand lever (D) until pulley is moved into contact with machine belt, and is locked in that position. When the machine is operated, the bobbin will be rotated and filled until the thread engages the automatic throw-out member, which disengages the pulley. The extent to which the bobbin is filled can be varied by regulating the screw (C).

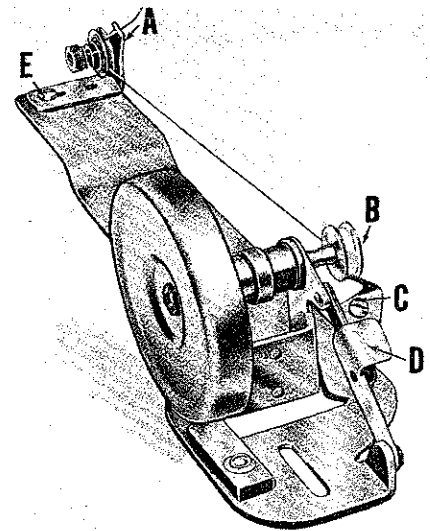

Fig. 5

The tension post bracket is mounted on the winder base, and can be shifted from left to right by loosening screw (E) so that any tendency of the bobbin to wind unevenly may be readily corrected.

The purpose of the bobbin winder is to assure an operator of a full bobbin at all times. When the bobbin in the machine is used up, replace it with the full one, and begin to wind the empty one immediately. Bobbins can be rewound while the machine is sewing.

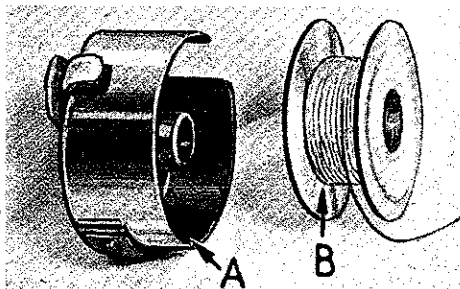

Fig. 6

THREADING THE BOBBIN CASE

The bobbin case should be held between the thumb, forefinger and second finger of the LEFT hand (A, Fig. 6).

The bobbin itself should be held between the thumb and forefinger of the right hand (B, Fig. 6) with thread coming off the bottom of the bobbin.

INSTRUCTIONS FOR OPERATORS (Continued)

THREADING THE BOBBIN CASE (Continued)

Place the bobbin in the bobbin case. In one continuous motion, with the thumb and forefinger of the right hand, draw the bobbin thread through the diagonal slot in bobbin case (A, Fig. 7) under the tension spring (B) and into self threading eyelet (C) on case. Note the direction of the rotation of the bobbin as the end of the thread is pulled when looking at the bobbin case from the back. The bobbin should rotate counterclockwise.

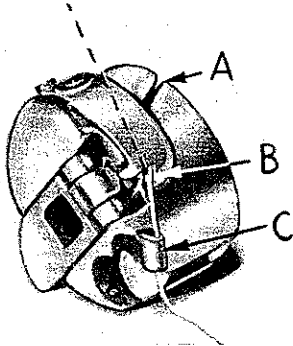

Fig. 7

REPLACING THE BOBBIN CASE

Have the needle bar at its highest position, allow about two and one half inches of thread to hang free. The bobbin case latch should be opened with the left hand, and by reaching under the table and through the opening in the table, it should be placed part way into the sewing hook. The latch should then be released and bobbin case snapped into position.

INSERTING THE NEEDLE

Insert the needle into the needle bar as far as it will go with the spot (sometimes called scarf) toward the right, facing the handwheel. Tighten set screw securely.

The cross hole in the needle bar, about 1/4 inch from the end (A, Fig. 8), is to show the operator when the needle has been inserted as far up as it will go, and to provide a means for cleaning the accumulated lint from needle hole so the needle will seat properly.

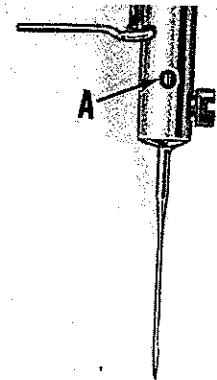

Fig. 8

THREADING THE NEEDLE

Threading diagram (Fig. 2) shows the places where the needle thread passes. Please note that the needle thread passes through the needle eye from left to right.

PREPARATION FOR SEWING

With your left hand, hold the end of the needle thread, leaving it slack, and turn the handwheel in operating direction until the needle moves down and up again to its highest position. Pull up the needle thread and the bobbin thread will come up with it through the needle hole in the throat plate. Draw both threads under the presser foot.

TENSIONS

A perfect stitch is one in which the needle thread and bobbin thread are locked together in the center of the material being sewed. A stitch of this kind is secured by regulating the tensions on both threads.

BOBBIN THREAD TENSION

The tension on the bobbin case is applied by means of a set screw (A, Fig. 9) which regulates tension spring (B). The tension on the spring is correct when it is just sufficient to hold the bobbin case and bobbin suspended by the bobbin thread. The thread should not be in the eyelet for this adjustment check.

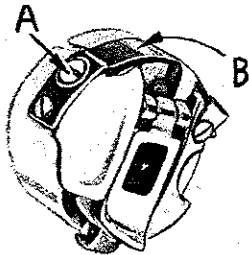

Fig. 9

INSTRUCTIONS FOR OPERATORS (Continued)

BOBBIN THREAD TENSION (Continued)

Remove the bobbin case from its holder and turn set screw in spring in a clockwise direction to apply more tension or counterclockwise to release tension.

When the bobbin thread tension is correct, it rarely becomes necessary to make any changes as varying the needle thread tension will usually attain a good stitch.

NEEDLE THREAD TENSION

The needle thread tension is varied by turning the tension regulating nut (F, Fig. 2). Turning the nut in a clockwise direction increases the tension, while counterclockwise decreases it. This should not be done when the presser foot is in its raised position, but is generally done while the machine is sewing on a piece of scrap material.

TO CHANGE THE STITCH LENGTH

Press plunger (G, Fig. 2) in firmly. While holding plunger in, turn handwheel in operating direction until stitch regulating finger is felt to drop into the slot of feed eccentric. Continuing to hold the plunger in, turn handwheel in operating direction to increase the stitch length and in opposite direction to decrease the stitch length.

Stitch lengths are indicated by graduations on the indicator dial and are viewed through the window in the belt guard (H, Fig. 2).

NOTE: The needle feed and the drop feed should move together. If not loosen nut (A, Fig. 10) and reposition connecting stud (B) forward or backward to a point where they are synchronized. Tighten nut (A) securely.

PRESSURE ON MATERIAL

The presser spring should exert only enough pressure to make the work feed uniformly. To increase the pressure on the presser foot, turn presser spring regulator (G, Fig. 16) in clockwise direction. Turning the regulator counterclockwise decreases the pressure.

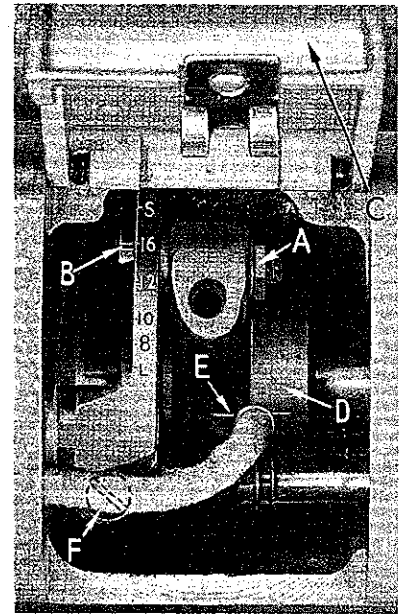

Fig. 10

INSTRUCTIONS FOR MECHANICS

SETTING THE NEEDLE BAR TO HEIGHT

The lower end of the needle bar frame, the one to which the needle bar is timed, is faced to height at the factory. The distance from the bottom of frame (A, Fig. 11) to the throat plate seat is $2 \frac{17}{64}$ inches.

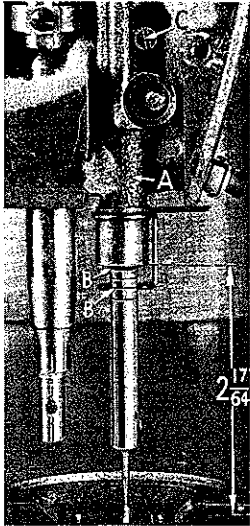

Fig. 11

The four lines engraved on the needle bar are used in setting needle bar to height, and are referred to as TIMING LINES. The two upper lines are used with the extra short length needle Type 183, which is recommended for Styles 63900 A, C and AL.

The two lower lines are used with the short length needle Type 180, which is recommended for Styles 63900 B and D.

When the needle bar is at its lowest position, the upper timing line (B, Fig. 11) (of the pair selected) dependent upon the needle used, should be EVEN with the lower edge of the lower needle bar frame (A).

To change the position of the needle bar, turn the handwheel until the bar is at its lowest position. Then, loosen the clamp screw (C) and move the bar to the proper timing line. Keeping the needle bar line at its lowest position, tighten screw securely.

The illustration (Fig. 11) shows the proper setting of the needle bar on Styles 63900 A, C or AL using extra short length needles, Type 183. The setting of the needle bar on Styles 63900 B or D using short length needles, Type 180, is accomplished in the same manner, except that the lower pair of timing marks on the

bar is used.

TIMING THE HOOK

Tip the machine back so that it rests on the rest pin in the table top. Insert a new needle. Loosen the two screws, and swing out the bobbin case positioning finger (A, Fig. 12). Loosen the three set screws (B) in the hook, and hold the hook and bobbin case holder in such a position as to prevent interference with the needle. Turn handwheel in operating direction until the needle bar is at its lowest position, and continue to turn the handwheel until the needle is ascending and the lower timing mark (of the pair selected) (Fig. 11) used in setting the needle bar is even with the lower edge of the needle bar frame (A).

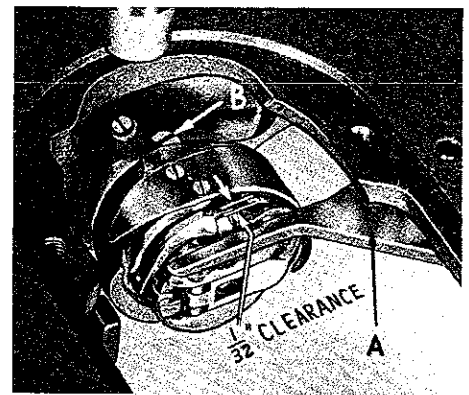

Fig. 12

Turn the hook on the shaft until the point of the hook is even with the center of the needle and as close to the needle as possible without deflecting it. A spacing of .003 to .005 inch between the needle and the point of the hook is satisfactory. With the hook in this position, tighten the set screw opposite the hook point securely. Then, tighten the two remaining screws securely, and recheck the timing of the hook with the needle. At the hook timing position the top of the eye of the needle should be about $\frac{1}{64}$ inch below the bottom of the hook point.

Adjust the bobbin case holder positioning finger by turning the bobbin case holder until the finger recess is at the top. Place the projection on the finger into the bobbin case holder recess and tighten the finger attaching screws securely, allowing $\frac{1}{32}$ inch clearance between the outside edge of projection and the inside edge of bobbin case recess (Fig. 12).

INSTRUCTIONS FOR MECHANICS (Continued)

NEEDLE GUARD INSTRUCTIONS FOR NO. 29474 S

In the hook, at the right side of the needle hole in the bobbin case holder (B, Fig. 13) is found a needle guarding surface (A, Fig. 13).

The purpose of this guarding surface is to prevent the hook point (C) from coming in contact with the needle (D) at loop-taking time, should the needle be deflected toward the hook point. The needle guard will deflect the needle slightly, when needle is at bottom of its vertical travel, if the hook is properly timed. (At loop-taking time, there should be little or no deflection of needle by the needle guard.)

For additional needle clearance, especially with use of size .048 and larger needles, removal of some needle guarding surface may be necessary.

Before metal removal from the guarding surface, all related settings should be checked as follows:

1. See that the needle bar is set to correct height.
2. Check for proper hook timing.
3. Rotate handwheel in operating direction by hand. Check for excessive needle deflection beyond what is cited above as a desirable condition.
4. If needle deflection is excessive, follow steps 1 and 2 below.

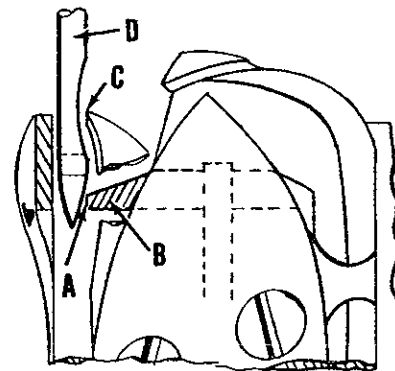

Fig. 13

(1) Remove bobbin case holder from hook.

(2) Remove excess metal from needle guarding surface. This may be done by using a 1/8 inch strip of fine emery cloth (#320), with one end secured to the bench and rubbing the guarding surface back and forth until sufficient metal is removed. When metal is being removed from needle guarding surface, the bobbin case holder should be re-inserted frequently and tested until proper needle guarding is obtained.

CAUTION! Damage to hook point may result if too much metal is removed from needle guarding surface.

The bobbin case holder should be thoroughly cleaned before re-assembly into hook base.

When altering needle guarding surface, it is suggested the hook NOT BE REMOVED or disturbed from its timed position.

Bobbin case holder only may be removed by removing gib screws and gib and by pulling on bobbin case stem as the handwheel is rocked backwards and forwards slightly.

HOOK LUBRICATION

CAUTION! Do not run the machine without the bobbin case in the hook as hook damage may result.

With the bobbin case in the hook, run the machine for a full minute. Place a piece of white paper directly under the hook and continue running the machine. After about five seconds, remove the paper and a definite and distinct pattern of oil spots should be observed.

HOOK LUBRICATION (Continued)

Should more or less oil be required, turn the oil control adjusting shaft (E, Fig. 2), located on the front of the machine just below the cloth plate surface, in the direction of the change required. After a change in the hook oil flow, the machine should be run about one minute before checking for the desired oil flow.

FEED DOG HEIGHT

In regulating the height of the feed dog, it should be at its highest position and the presser foot resting directly against it.

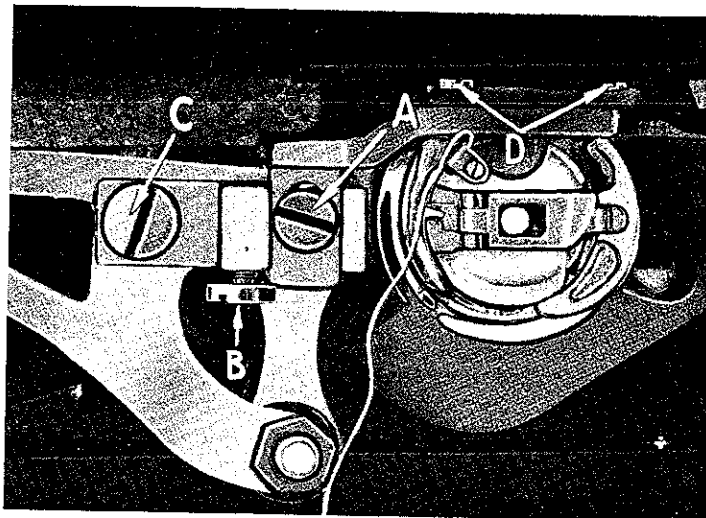

Fig. 14

The feed dog holder attaching screw (A, Fig. 14) should be loosened slightly, and regulating screw (B) should be turned either clockwise, to raise the feed dog, or counterclockwise to lower it. Make sure that the bottom of the shank of the feed dog holder rests against the head of the regulating screw.

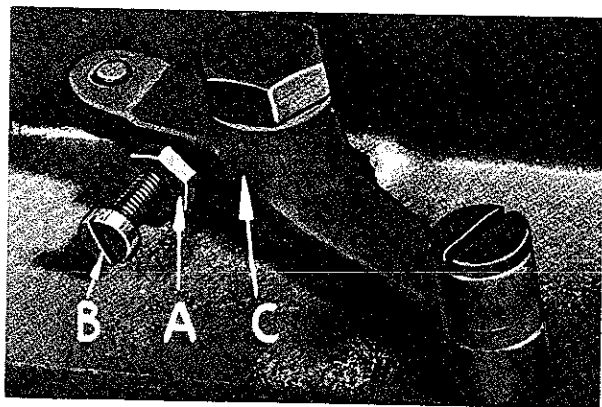

Fig. 15

A suggested initial setting is as follows: Feed dogs having 22 or more teeth per inch should show about 3/64 inch above the throat plate at highest point of travel. Those having 16 or less teeth per inch should show the depth of a full tooth above the throat plate. The feed dog can be tilted up or down as required by loosening screws (A and C).

dog, front to back or sideways in the throat plate.

Loosen feed dog holding screws (D) to space the feed

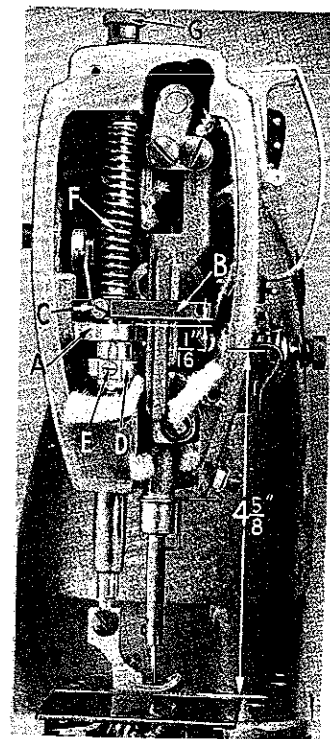

Fig. 16

PRESSER BAR CONNECTION (For Styles 63900 A, B)

The presser bar connection (A, Fig. 16) should be set so that it is about 1/16 inch below the presser bar guide (B). This is accomplished by tipping the machine back against the rest pin, loosening the lock nut (A, Fig. 15), and relocating the stop screw (B) on the lifter lever bell crank (C). By turning the stop screw to the right or left, the proper setting of the presser bar connection is accomplished. Tighten the lock nut (A) to lock the stop screw in place.

PRESSER BAR CONNECTION (For Styles 63900 C, D, AL)

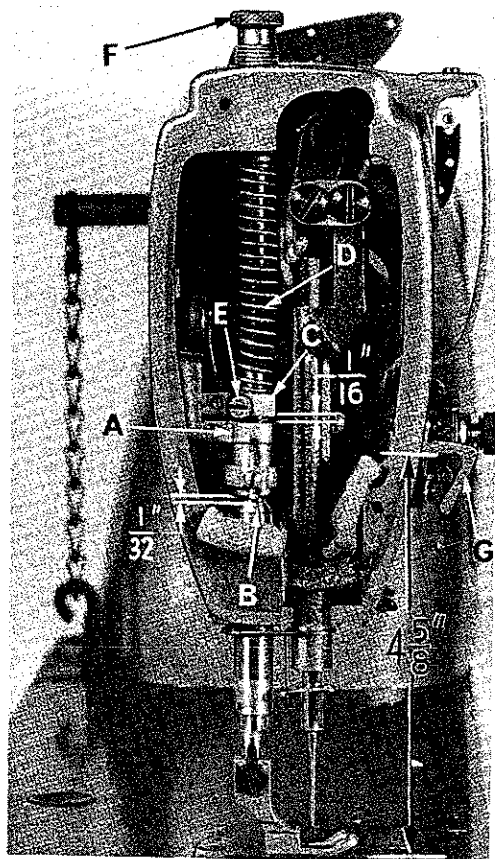

Fig. 16A

The presser bar connection (A, Fig. 16A) should be set so that it is approximately $\frac{1}{32}$ inch above the lower presser bar bushing (B, Fig. 16A). This is accomplished by tipping the machine back against the rest pin, loosening the lock nut (A, Fig. 15) and relocating the stop screw (B) on the lifter lever bell crank (C). By turning the stop screw to the right or left, the proper setting of the presser bar connection is accomplished. Tighten the lock nut (A) to lock the stop screw in place.

PRESSER BAR GUIDE (For Styles 63900 A, B)

When locating the presser bar guide (B, Fig. 16), the presser foot must rest directly against the throat plate with the feed dog in its lowest position. The guide is set properly when there is a $4 \frac{5}{8}$ inch space between the underside of the needle thread take-up wire and the top of a thin (.085 inch thick) throat plate (Fig. 16).

To obtain this setting, remove the pressure from the presser spring (F) and loosen set screw (C). Tap on presser foot to insure its being down on the throat plate. Set the guide to the $4 \frac{5}{8}$ inch dimension, center the foot by turning it so that the needle enters the middle of its slot and retighten screw (C) in guide. Now, apply pressure

to the presser foot by turning the presser spring regulator (G) clockwise.

PRESSER BAR GUIDE (For Styles 63900 C, D, AL)

When locating the presser bar guide (C, Fig. 16A) the presser foot must rest directly against the throat plate with the feed dog in its lowest position. The guide is set properly when there is a $\frac{1}{16}$ inch space between the guide (C) and the presser bar connection (A, Fig. 16A).

To obtain this setting, remove the pressure from the presser spring (D, Fig. 16A) and loosen set screw (E). Tap on presser foot to insure its being down on the throat plate. Set the guide to the $\frac{1}{16}$ inch dimension, center the foot by turning it so that the needle enters the middle of its slot and retighten screw (E) in the guide. Now apply pressure by turning the presser spring regulator (F) clockwise.

Set the needle thread pull-up bracket (G) so that the underside of the wire is $4 \frac{5}{8}$ inches above the throat plate (Fig. 16A).

PRESSER BAR

The presser bar No. 63457 J is designed primarily to receive Union Special presser feet. However, should feet of a different manufacture be required, the presser bar is adaptable.

INSTRUCTIONS FOR MECHANICS (Continued)

PRESSER BAR (Continued)

To adapt the machine to receive presser feet of other manufacture, proceed as follows:

1. Remove presser foot and presser foot screw from presser bar.
2. Insert presser foot screw in the presser bar so it screws in from right to left.
3. Loosen the set screw in the presser bar guide and rotate presser bar 180° using the screw as a handle.
4. Attach presser foot to the bar and align the needle hole or slot of the foot with the needle.
5. Check the presser bar guide for correct height and tighten set screw securely.

CAUTION! When presser feet other than of Union Special manufacture are used, the presser guide height must be checked and reset where necessary.

TENSION ASSEMBLY ADJUSTMENT

Test check spring tension (A, Fig. 17). There should be enough tension to assure a good returning snap when spring is depressed and released. Should it require adjusting, loosen set screw in the head located under arm and to the right of tension assembly, and remove tension assembly. Partially loosen tension post set screw (B) in tension post socket (C). Turn the tension post (D) counterclockwise until the check spring moves away from the upper stop (E) and has no tension on it. Turn the tension post (D) in a clockwise direction until the spring again touches the upper stop (E). Then, proceed further in the same direction until the desired tension is obtained. When correctly set, the tension post set screw (B) should be drawn up snugly, yet not forcefully. Further adjustment of the check spring tension can be made by inserting a screwdriver into the slotted end of the tension post (D) and turning in the required direction.

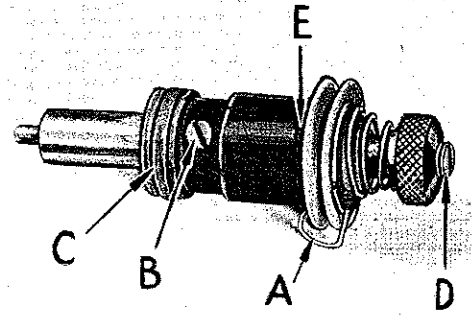

Fig. 17

Replace tension assembly with the check spring about $3/8$ inch above the thread take-up wire. While the tension post assembly is being replaced, the presser foot should be resting on the throat plate.

TENSION RELEASE

The tension release should be set so that it will not release when sewing over seams or when the presser foot is raised for back tacking. The adjustment of the tension release cam (D, Fig. 16) and the in and out position of the tension assembly are required for proper operation.

TENSION RELEASE (Continued)

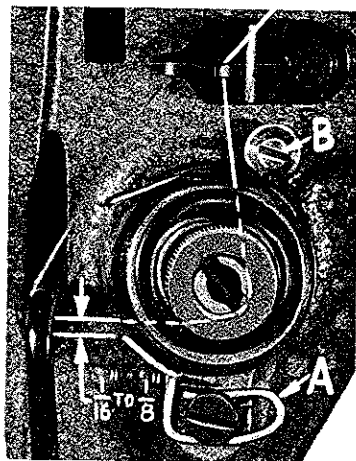

Fig. 18

The in and out position of the tension assembly is correct when the tension discs are in line with the check spring eyelet (A, Fig. 18). Set the stop screw (B, Fig. 18), so that when the flange of the tension assembly rests against it, this position is maintained. Tighten the tension assembly set screw.

The tension release cam (D, Fig. 16) should now be positioned by loosening set screw (E, Fig. 16) and then raising or lowering the cam to suit the sewing conditions. The average release point is between 1/4 and 5/16 inch of presser foot lift above the throat plate. Tighten tension release cam set screw securely.

THREAD CONTROL (For Styles 63900 A, B)

insure a good returning snap when spring (B, Fig. 19) is depressed and released. The check spring tension is adjusted from about 1 to 1 1/4 ounces when measured with a postal scale (C, Fig. 19). This is measured when the check spring is 1/32 to 1/16 inch from its stop. The tension post set screw should be drawn up snugly but not forcefully tightened (B, Fig. 17). The tension release pin should move freely in the tension post (D, Fig. 17). The check spring eyelet (A, Fig. 18), located just below the tension discs, should be set for correct height as follows:

With a thread running from the tension post to the thread wire in a straight line, the check spring eyelet should be set 1/16 to 1/8 inch below the thread line (Fig. 18). Be sure the eyelet is set close to the tension discs so that the check spring will pass freely over it without obstruction. After making this setting, proceed to thread machine as per threading diagram (Fig. 2).

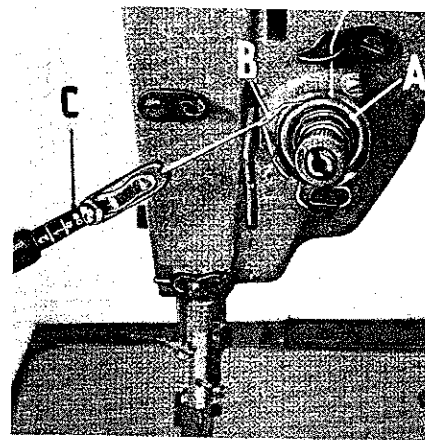

Fig. 19

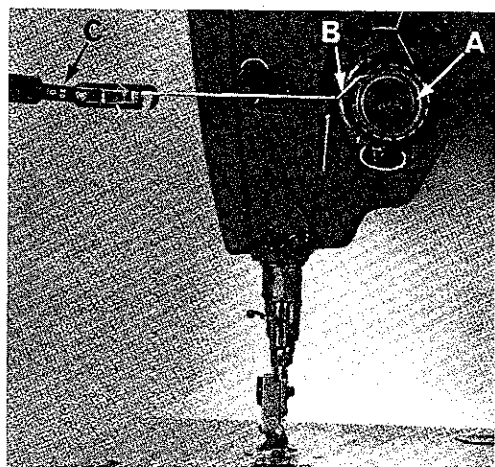

Fig. 19A

Sew slowly on a piece of material and observe the action of the check spring. The thread from the check spring to the take-up wire should be taut when the take-up is at the bottom of its stroke. Slight changes in needle thread tension may be necessary at this point, but a reasonable tension should be used to maintain a uniform and consistent stitch. The machines are sewn off with 3 to 4 ounces needle thread tension on 70-2 cord or similar thread, using a postal scale (A, Fig. 20). Depress check spring when checking the tension. The check spring will feel heavy to you when compared to Class 61900 adjustment, but this is a required setting for the Class 63900, and as a result, the disc tension can be reduced.

INSTRUCTIONS FOR MECHANICS (Continued)

THREAD CONTROL (For Styles 63900 C, D, AL)

Check the adjustment of tension assembly (A, Fig. 19A). Check spring tension. There should be enough tension to insure a good returning snap when spring (B) is depressed and released. The check spring tension is adjusted from about 1/2 to 1 ounce when measured with a postal scale (C). This is measured when the check spring is 1/32 to 1/16 inch from its stop. The tension post set screw should be drawn up snugly but not forcefully tightened. The tension release pin should move freely in the tension post.

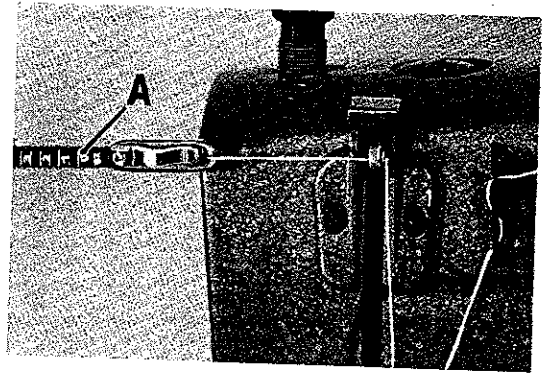

Fig. 20

NOTE: The machine is equipped with a rotary needle thread tension assembly. To insure proper thread handling, the thread is to be wound **TWICE** around the rotary tension disc.

The tension post socket eyelet should be set as far to the right as possible, being sure that the eyelet is set close to the rotary tension disc, in order for the check spring to pass freely over it without obstruction. After making this setting proceed to thread machine as per threading diagram (Fig. 2A).

Sew slowly on a piece of material and observe the action of the check spring. The thread from the check spring to the thread pull-up bracket should be taut when the take-up lever is at the top of its stroke. Slight changes in needle thread tension may be necessary at this point, but a reasonable tension should be used to maintain a uniform and consistent stitch. The machines are sewn off with 2 to 3 ounces needle thread tension on 70-2 cord or similar thread, using a postal scale. Depress check spring when checking the tension. The check spring will feel heavy to you when compared to Class 61900 adjustment, but this is a required setting for the Class 63900, and as a result, the disc tension can be reduced.

INSTRUCTIONS FOR MECHANICS (Continued)

BOTTOM COVER

Before removing the bottom cover, place the machine on bench so that the plug screw is accessible from underneath. Remove this plug screw and catch the reservoir oil in some convenient clean container. Tip the machine back, loosen and remove the two cover screws. The cover should be tapped free with a wooden block or mallet. Do not pry cover loose with any sharp instrument as the gasket may become damaged.

CAUTION! When the bottom cover is removed, care should be taken not to mar or scratch the gasket seat area of the machine bottom.

Before replacing the cover, the machine gasket seat should be wiped clean and free of all lint and dirt. The cover gasket should also be inspected for damage and cleaned of dirt. Two additional gaskets are used to seal the bolts and must be cleaned before assembly. Carefully set the cover in place and tighten the two bolts securely.

To replace a damaged cover gasket, proceed as follows:

1. Clean cover gasket recess of any foreign matter.
2. The gasket in cross section is triangular in shape with a groove in the top or widest part. With the cover resting as it does in the machine, oil distributing plate to your right, begin inserting the gasket in the middle of the back recess. The grooved wide edge of the gasket should be up and the long sloped edge inward. Continue pressing the gasket into the cover recess until gasket is in place.

The bolt sealing gaskets may have a tendency to fall out when installing the cover, but may be temporarily cemented in place by applying grease to their recesses.

HOOK SHAFT

The hook shaft (A, Fig. 21) is held in position by the pinion (B) and collar (C) thrusting against hard steel washers (D) between the long left hand bushing (E) and the short right hand bushing (F).

Should the hook shaft setting be disturbed, the left and right position can be determined by measuring from the hook end of the hook shaft to the point of a new needle (G) and reading $9/16$ inch on a scale.

To reposition the hook shaft, loosen the set screws of the pinion and collar and establish the $9/16$ inch dimension. Move the pinion and thrust washer against the left bushing, and after making certain one of the set screws is on the shaft FLAT, tighten both screws securely. Liberally coat the collar and its washer with oil and press the collar away from the pinion so as to remove all end play and tighten both set screws securely.

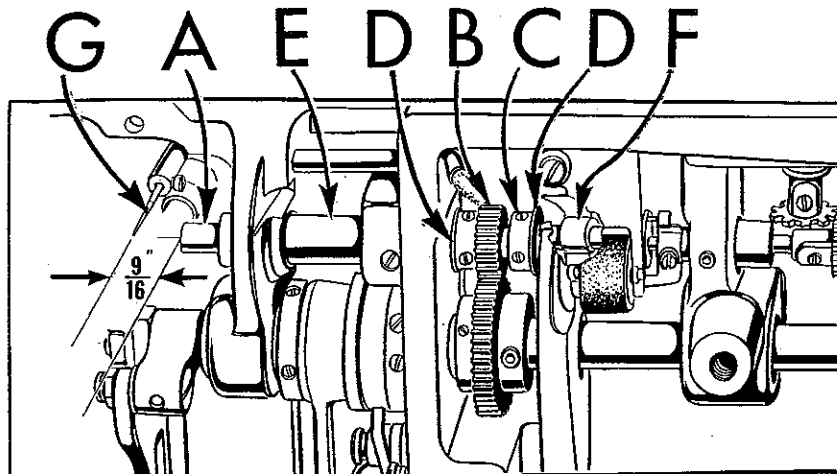

Fig. 21

Hook oiling is accomplished by a high speed rotary pump on the end of the hook shaft. The quantity of oil supplied to the hook is regulated by the longer or shorter path the oil is required to travel through the metering felt of metering cup (G, Fig. 22). (Increase or decrease of oil supply is controlled by a dial (P, Fig. 22) with an arrow marked "INCREASE", found below the cloth plate). The hook oil feed roller (A, Fig. 22) which rests against the metering cup felt serves not only to feed oil to the unit from the oil reservoir, but filters the oil as well.

REMOVAL OF OILING DEVICE

The following steps are necessary to remove hook oiling device:

1. Remove hook oil feed roller (A, Fig. 22).
2. Remove hook oil control finger (B).
3. Apply finger pressure to hook oil control shaft (D) to prevent loss of pump disc pivot pin (E); using Allen wrench, loosen set screw (C). Move assembly slowly to right, being careful not to drop pivot pin located in the end of the hook oil control shaft. When pivot pin is clear of pump disc (F), disc is free to fall.
4. Remove metering cup (G) along with oil supply felt (K) and air seal felt (J).
5. Remove cog (H) from hook oil control shaft.

INSTRUCTIONS FOR MECHANICS (Continued)

RE-ASSEMBLY OF OILING DEVICE

Before re-assembly, the end of the hook shaft, its spiral groove and the pump disc should be thoroughly cleaned. Remove any end play found in hook shaft and determine that the 35/64 inch dimension has been maintained (Fig. 21).

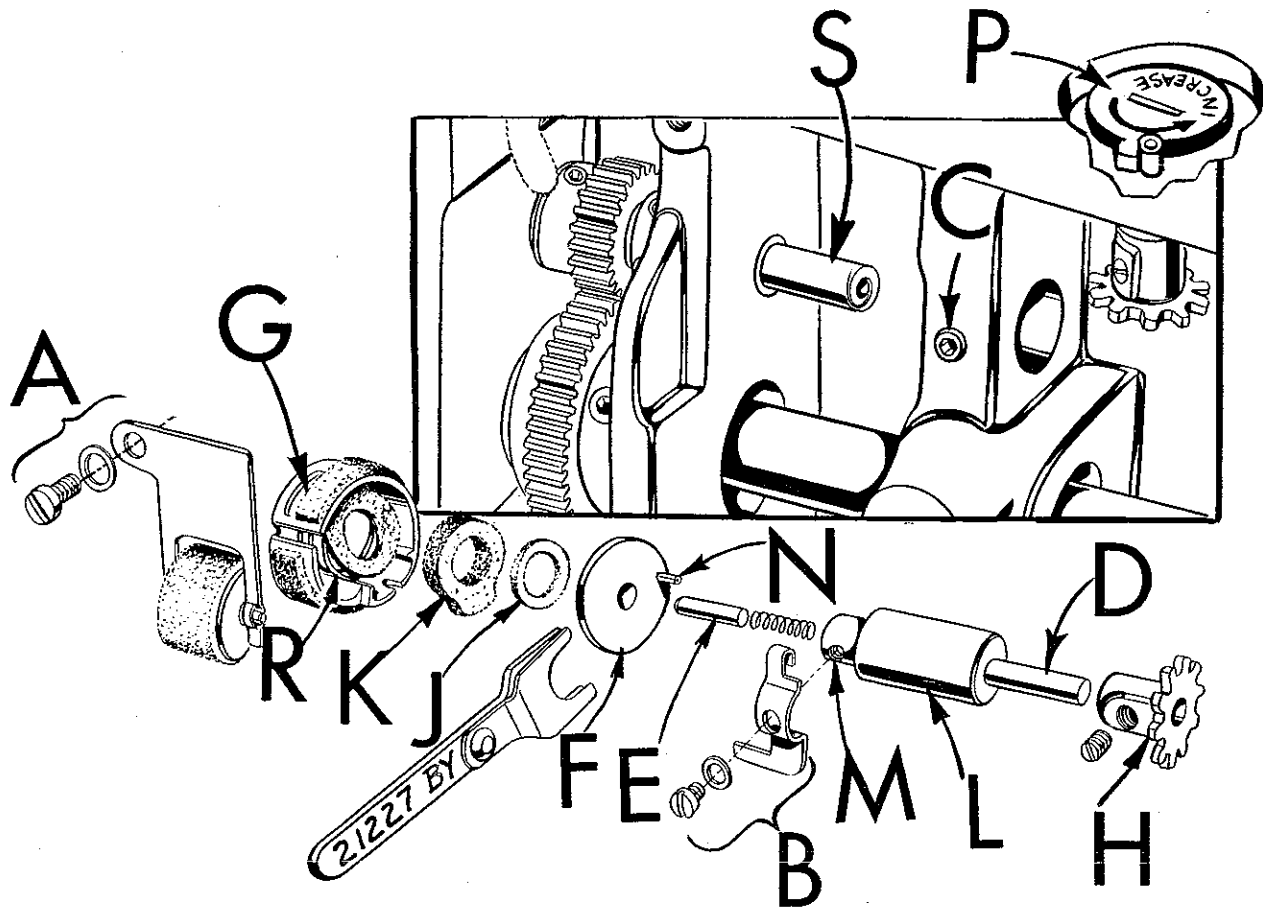

Fig. 22

The following steps are necessary to re-assemble the hook oiling device:

1. Remove and separate the air seal felt (J, Fig. 22) from oil supply felt (K).
2. Make sure small end of air seal spring (R) is located on boss of metering cup behind felt attached to cup. Position metering cup (G) and air seal spring on hook shaft (S) with open end toward handwheel end of machine (Fig. 22).

NOTE: The hook shaft should pass through hole of felt attached to metering cup.

3. Position oil supply felt (K, Fig. 23) on hook shaft making certain the felt's projection extends into dovetail of metering cup.
4. Position air seal felt (J) on hook shaft.
5. Insert pump disc (F) into assembly tool No. 21227 BY, with stop pin on the spring side of tool, 180° from handle. Insert disc approximately half way into spring and center in tool (Fig. 24).

INSTRUCTIONS FOR MECHANICS (Continued)

RE-ASSEMBLY OF OILING DEVICE (Continued)

6. Insert hook oil control shaft (D, Fig. 22) and its bushing (L) part way into its boss which is located directly behind the hook shaft, being careful NOT TO DROP the pump disc pivot pin (E).

7. A clearance cut on the edge of the metering cup, located between the dovetail and the long horizontal slot, has been provided for the pump disc tool and should be facing you (Fig. 24).

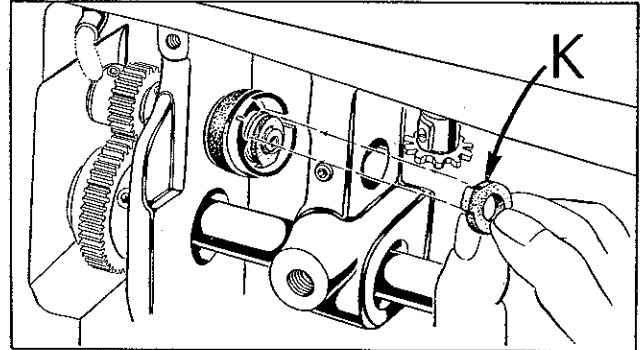

Fig. 23

8. With the fork of the tool in line with the metering cup clearance cut and centered about the hook shaft end, press the felts to the left with the tool until the pump disc is in contact with the end of the hook shaft.
9. Press hook oil control shaft bushing (L) to left until control shaft (D) is approximately 1/16 inch away from pump disc (F). Make sure the control shaft pivot pin (E) seats in the depression at the center of the pump disc. Tighten set screw (C, Fig. 24) and withdraw assembly tool. Be sure air seal felt (J) has seated against the pump disc.
10. Turn hook oil control shaft (D, Fig. 25) until screw hole (M) is accessible. Manually rotate pump disc (F) so its stop pin (N) is 90° above screw hole.
11. Rotate metering cup so the short slot (T) is 180° from the stop pin (N). Now, install the hook oil control finger (B) by first hanging the hooked portion of the finger over the stop pin (N) and lowering to insert the projection at bottom left into the short slot of the metering cup. Tighten finger (B) in place by means of screw and washer, making sure the hook oil control finger does not bind or distort the metering cup.

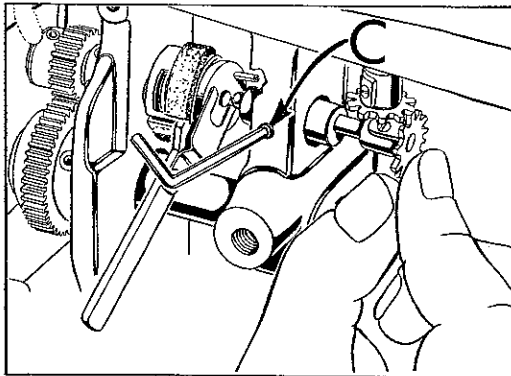

Fig. 24

12. Assemble the hook oil feed roller (A, Fig. 26), and rotate the metering cup so that the roller contacts the metering cup felt at point (U, Fig. 26). Turn the oil control adjusting shaft (P, Fig. 26) in the increase direction until projection stops against the stop pin (this is maximum oil supply) and install the cog (H, Fig. 26) on the hook oil control shaft. After meshing the teeth, tighten the set screw securely.

13. Check for proper contact of the hook oil feed roller and the metering cup by turning the oil control adjusting shaft through its complete travel and observe the feed roller turning as the metering cup turns. With the oil control adjusting shaft set at maximum, the feed roller point of contact with the metering cup felt should be at the mid-point of the slot that permits the metering cup felt to enter the metering cup.

NOTE: The feed roller should be in contact with the metering cup felt through its complete travel.

INSTRUCTIONS FOR MECHANICS (Continued)

UPPER MAIN SHAFT

In a high speed machine, the alignment of the take-up mechanism is extremely important and is controlled by the left and right position of the upper main shaft. Should the main shaft position be altered, it is imperative that the take-up alignment be checked before operating.

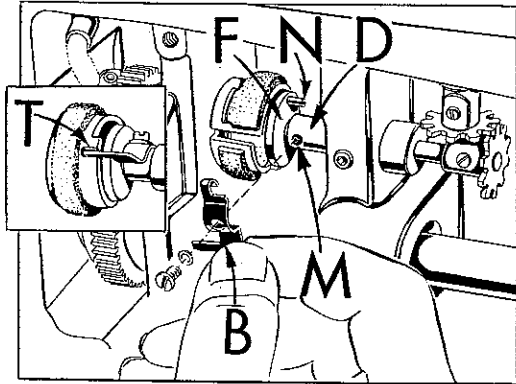

Fig. 25

TO CHECK FOR ALIGNMENT

1. Remove the presser bar spring and regulator screw.
2. Rotate the handwheel so that the needle bar is at the bottom of its stroke.
3. Remove the take-up lever pin.
4. With light inward finger pressure, move the take-up lever to the take-up lever boss. There should be a small amount of interference between the lever and the boss. With light outward finger pressure, move the lever across the boss face. There should be clearance between the boss face and lever. These two tests in effect are checking the lateral play of the take-up lever and provides

for operation of the take-up in the center of the lateral play. Now, line up the take-up lever hole with the hole in the lever boss. Insert the oil wick about 1/2 inch in the bore of the take-up lever. With the oil wick groove up, insert the take-up lever pin in the lever, making sure the wick is in the groove and press the pin into its hole in the arm. There should be no end play in the take-up lever after the set screw is securely tightened.

Should the alignment test show the main shaft is out of position, the upper sprocket and handwheel should be loosened and the shaft moved left or right as the conditions indicate. Re-tighten sprocket and handwheel so that there is no end play in the upper main shaft and repeat the alignment check.

HANDWHEEL

The handwheel is constructed so as to minimize noise and is therefore isolated from the pulley by shock mounts. If for any reason the handwheel is disassembled, the following steps should be used for re-assembly.

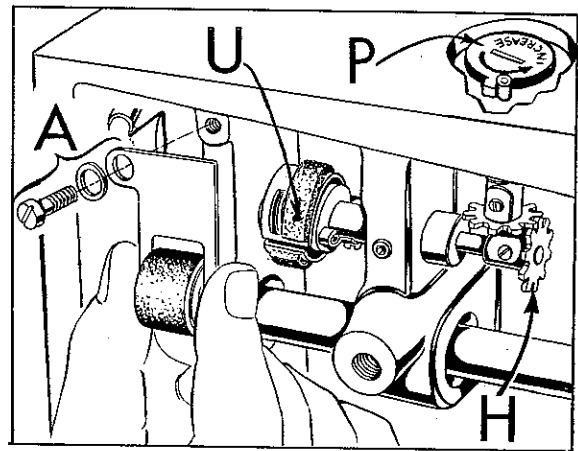

Fig. 26

1. Using the upper main shaft as a mandrel, assemble the pulley thrust face down so that at least 1 1/2 inches of the shaft protrudes above it. Tighten the two set screws.
2. Place the rubber isolator ring on the pulley face and align holes.
3. Carefully slide handwheel down the shaft to contact the isolator and align the three holes.

INSTRUCTIONS FOR MECHANICS (Continued)

HANDWHEEL (Continued)

4. Three plastic "O" rings are now inserted into their respective holes in the handwheel.
5. The outer isolator ring and cap are now assembled.
6. Insert the three screws that are run through the complete assembly and tighten lightly.
7. Loosen the two pulley screws and slowly revolve the whole assembly several times for good alignment. Now, gradually tighten the three screws, moving from one to the other until all are snug.
8. The assembly should run true as it revolves freely on the shaft. If any sidewise run-out is noted, it can be corrected by slight changes of screw pressure in the three isolator screws.

CAUTION! When replacing the handwheel assembly on the main shaft, care must be taken not to damage the oil seal located near the end of the shaft. The surface of the ring should be lightly oiled and the handwheel worked over the seal gently.

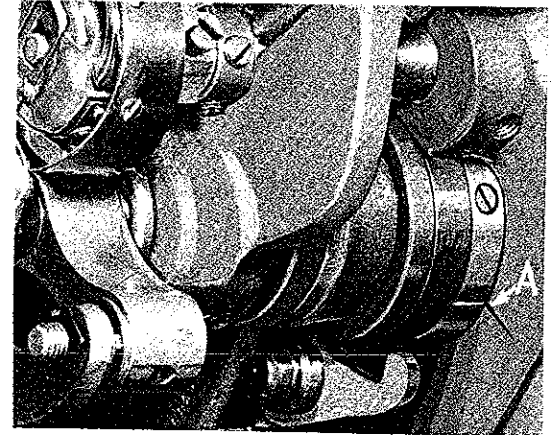

Fig. 27

STITCH LENGTH INDICATOR

After a feed timing change, the stitch length indicator will have to be re-adjusted to read accurately.

1. Depress the stitch length change button until it engages in the feed eccentric.
2. Turn the handwheel toward you until the stop is reached, indicating the longest stitch length.
3. Loosen the stitch length indicator set screws.
4. With the change button still engaged, set the indicator dial to read "L" in the window on the belt guard.
5. Tighten indicator dial set screws.

TIMING THE MACHINE

Tip the machine back against the rest pin and turn handwheel until the needle bar is at the bottom of its stroke. The timing line "9" on the feed drive eccentric should line up with the mark on the wall of the casting (A, Fig. 27).

TO SET THE FEED TIMING

1. Remove the needle from the needle bar.
2. Remove large plug screws below the oil gauge and below the handwheel.
3. Turn the handwheel until the needle bar is at the bottom of its stroke.
4. Loosen the lower sprocket screws through the hole below the oil gauge.

INSTRUCTIONS FOR MECHANICS (Continued)

TO SET THE FEED TIMING (Continued)

5. Hold the handwheel securely and turn the lower main shaft until the timing mark "9" on the adjustable feed driving eccentric and mark on the casting wall line up (A, Fig. 27).
6. Press the lower main shaft firmly toward the handwheel and with a screw driver, press the lower sprocket toward the head of the machine. Through the access hole, re-tighten the two sprocket screws securely. There should be no end play in the lower main shaft.
7. A small quantity of lead seal should be applied on the threads of both plug screws before they are replaced.

CAUTION! After any feed timing change, the hook must be retimed.

LOWER MAIN SHAFT

Should the lower main shaft position be altered, it is important that the collar (61432 J), located between the hook driving gear and the left lower main shaft bushing, be located .020 inch from the bushing.

The belt should be assembled on the lower sprocket so that the second set screw is accessible through the large plug screw.

NOTE: In all cases, the screws required to be placed on flats or spots are the screws which are the first to come into view as the handwheel is turned in the operating direction.

TIMING THE NEEDLE FEED WITH THE DROP FEED

1. Open the top cover (C, Fig. 10) at the top of the arm of the machine and loosen the needle frame drive segment locking nut (A). Set the connecting stud (B) to point of maximum number of stitches per inch of the needle feed. This would locate the connecting stud at the letter "S". Tighten nut (A).

NOTE: Keep connecting stud set at "S" throughout needle feed timing.

2. Loosen the two set screws in the needle frame drive eccentric (D) and rotate the handwheel until the needle bar is at the bottom of its stroke. Rotate the eccentric (D) only until the timing lines on the eccentric bearing (E) and on the hub of the eccentric coincide. Tighten all screws.

3. Remove presser foot, throat plate, feed dog and bed slide. Replace throat plate screws (A, Fig. 28). Rotate handwheel until needle bar (B) is at the bottom of its stroke. Turn bed slide (C) upside down and locate so that the screws fit into the cuts at the edge of the bed slide. This acts as a gauge for setting the needle bar frame (D). The needle should be in line with the notch in the bed slide. If not, loosen clamp screw (F, Fig. 10) and move needle bar frame forward or backward until needle is in line with gauge notch. Tighten screws.

NOTE: Be sure no end play exists in the needle bar frame rock shaft, between the thrust collar on left and the rock shaft driving lever on the right.

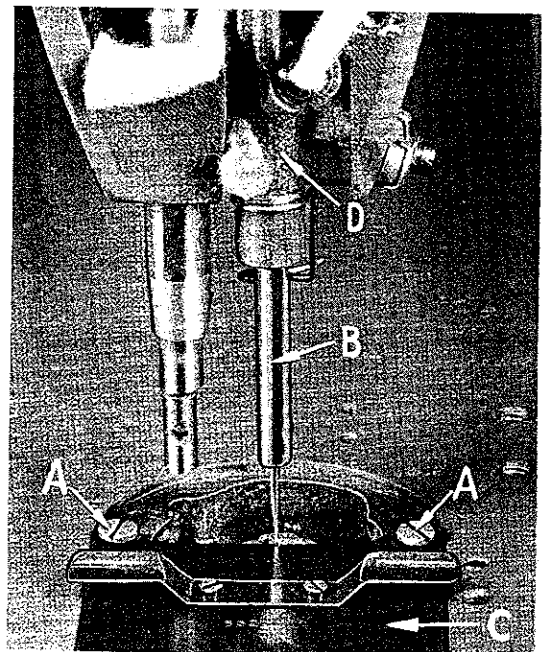
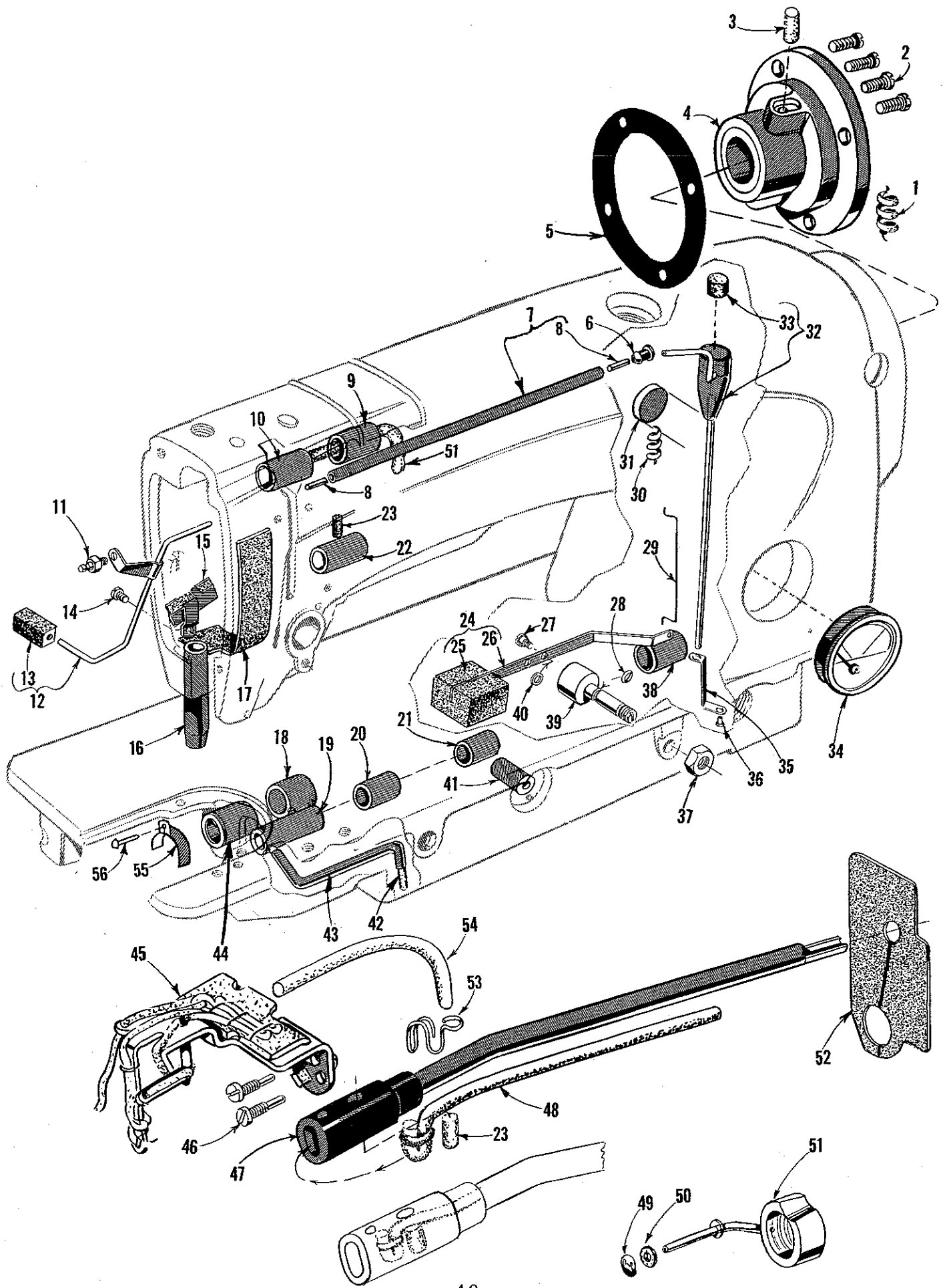

Fig. 28

EXPLODED VIEWS
AND
DESCRIPTION OF PARTS
FOR
63900 NEEDLE FEED
LOCKSTITCH MACHINES



MAIN FRAME, BUSHINGS AND HEAD OIL SIPHON PARTS

<u>Ref. No.</u>	<u>Part No.</u>	<u>Description</u>	<u>Amt. Req.</u>
1	666-221	Oil Wick, for bearing housing -----	1
2	22569 B	Screw -----	4
3	666-200	Oil Felt -----	1
4	61490 B	Main Shaft Bearing Housing, including bushing -----	1
5	63490 B	Bearing Housing Gasket -----	1
‡ 6	61494 N	Retaining Grommet -----	1
‡ 7	63994 B	Oil Siphon Connecting Tube -----	1
8	56393 AA	Oil Tube -----	2
* -	63494 N	Oil Siphon Connecting Tube (not shown) -----	1
	56393 AA	Oil Tube -----	2
	56393 G	Porex Filter -----	1
	63494 P	Oil Tube -----	1
9	61985 H	Needle Bar Frame Rocker Shaft Bushing, right -----	1
10	61985 G	Needle Bar Frame Rocker Shaft Bushing, left -----	1
11	61494 L	Stud -----	1
12	63994	Oil Siphon Head Tube -----	1
13	666-214	Oil Felt -----	1
14	22564	Screw -----	1
15	63953 A	Oil Shield -----	1
16	61457 K	Presser Bar Bushing, lower -----	1
17	666-234	Head Oil Attraction Felt -----	1
18	61432 E	Feed Driving Shaft Oil Retaining Bushing, left -----	1
19	61441	Hook Shaft Bushing, left -----	1
20	61441 A	Hook Shaft Bushing, right -----	1
21	61496 P	Hook Oil Control Shaft Bushing -----	1
22	61490 D	Upper Main Shaft Bushing, left -----	1
23	666-224	Roll Felt -----	2
24	63494 C	Oil Gauge Float Assembly -----	1
25	61494 D	Oil Gauge Float -----	1
26	61494 E	Oil Gauge Float Lever -----	1
27	21629 A	Screw -----	1
28	660-221	"O" Ring -----	1
29	61494 H	Oil Gauge Connecting Link -----	1
30	666-238	Bed Oil Drain Hole Felt -----	1
31	61293 N	Bed Plug -----	1
‡ 32	63494 D	Head Oil Siphon Assembly -----	1
33	666-237	Felt Plug -----	1
34	63494 K	Oil Gauge -----	1
‡ 35	63494	Siphon Primer Position Bracket -----	1
‡ 36	22564	Screw -----	1
37	11635 B	Nut -----	1
38	61432 B	Feed Driving Shaft Bushing, right -----	1
39	61494 F	Float Lever Pivot Stud -----	1
40	27-527 Blk.	Washer -----	1
41	61496 S	Hook Oiling Control Adjusting Bushing -----	1
42	666-212	Oil Felt -----	1
43	63493	Hook Shaft Bushing Oil Tube -----	1
44	63432 C	Feed Driving Shaft Bushing, left -----	1
45	63993 C	Head Oiler Assembly -----	1
46	22784 K	Screw -----	2
‡ 47	63993	Head Oil Supply Line -----	1
* -	63993 D	Head Oil Supply Tube (not shown) -----	1
48	666-225	Felt, for 63993 or 63993 D -----	1
* 49	660-456	Push-on Fastener -----	1
* 50	666-273	Felt Disc -----	1
* 51	63493 J	Oil Return Pump -----	1
52	666-254	Felt Baffle, for upper arm -----	1
53	63984 C	Spring Clip, for 666-223 -----	1
54	666-223	Roll Felt -----	1
55	63432 E	Hook Oil Shield -----	1
56	18-768	Drive Screw -----	1

* Used on new machines.

‡ Replaced by parts annotated with an asterisk (*) on new machines.

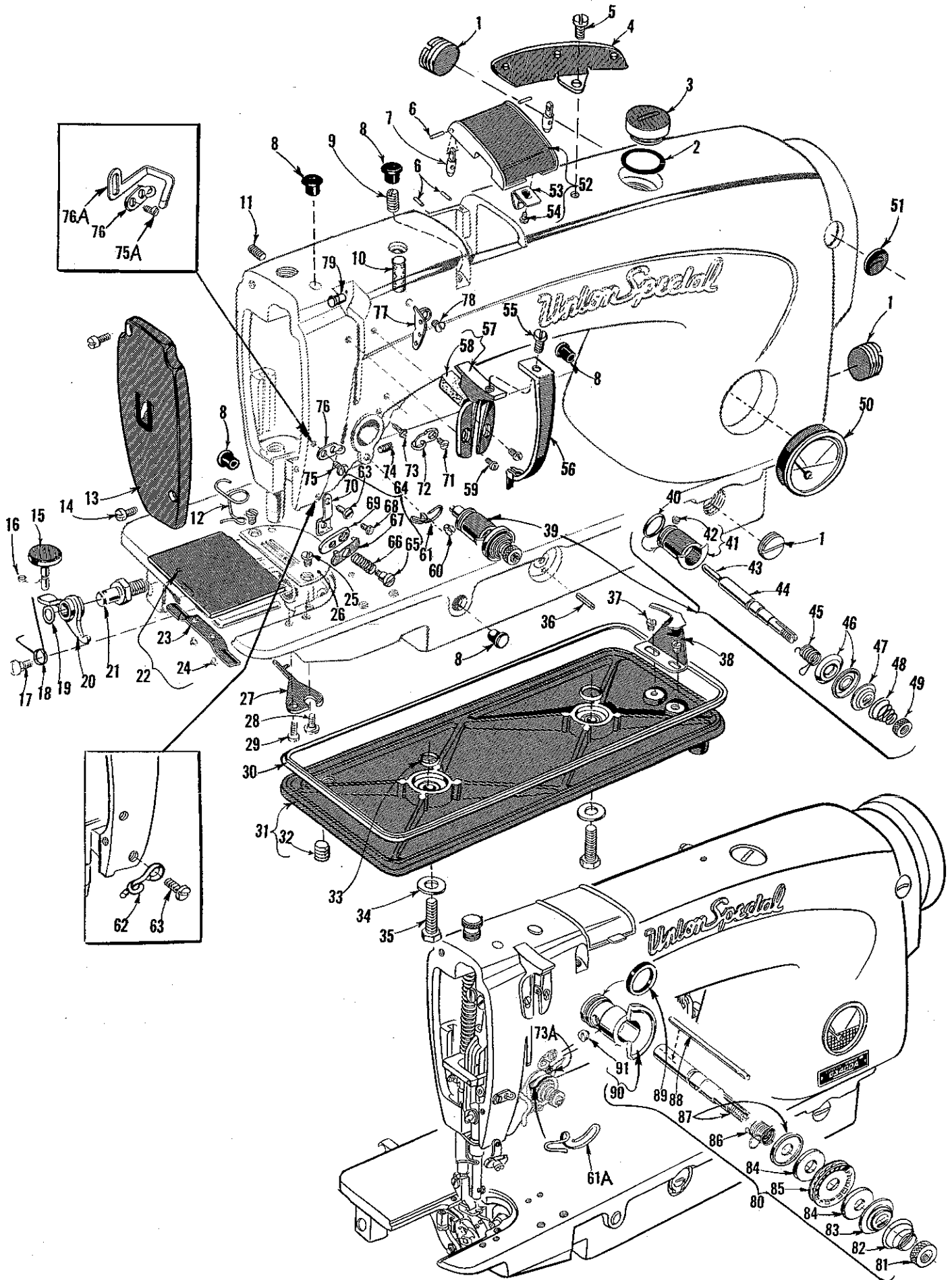

MAIN FRAME, MISCELLANEOUS COVERS AND NEEDLE TENSION PARTS

<u>Ref. No.</u>	<u>Part No.</u>	<u>Description</u>	<u>Amt. Req.</u>
1	22539 P	Plug Screw -----	3
2	63494 A	Gasket -----	1
3	22733 D	Plug Screw, for oil filler hole -----	1
4	61470 D	Frame Thread Eyelet -----	1
5	22570 A	Screw -----	1
6	61982 D	Top Cover Hinge Pin -----	4
7	61982 C	Top Cover Hinge -----	2
8	63494 B	Plastic Plug -----	5
9	22815	Screw -----	1
10	666-228	Oil Felt -----	1
11	22894 E	Screw -----	1
12	63470 B	Needle Bar Bushing Thread Guide -----	1
13	63982	Head Cover -----	1
14	22516	Screw -----	2
15	61449 V	Stitch Regulating Plunger -----	1
16	660-254 A	Retainer Ring -----	1
17	22504 A	Screw -----	1
18	61449 X	Pawl Plunger Spring -----	1
19	660-254 B	Retainer Ring -----	1
20	61449 U	Stitch Regulating Pawl -----	1
21	61449 Y	Stitch Regulating Pawl Stud -----	1
22	63902 A	Bed Slide Assembly -----	1
23	61273	Bed Slide Spring -----	1
24	91 A	Screw -----	2
25	376	Screw -----	2
26		Throat Plate (See Pages 55, 57, 59) -----	1
27	61414 A	Bobbin Case Holder Positioning Finger, for Styles 63900 A, B -----	1
	63914 A	Bobbin Case Holder Positioning Finger, for Styles 63900 C, D, AL -----	1
28	22742	Screw -----	1
29	22528	Screw -----	1
30	61482 J	Gasket -----	1
31	61482 H	Oil Reservoir Cover -----	1
32	22571 F	Plug Screw -----	1
33	660-204	"O" Ring -----	2
34	652-16	Washer -----	2
35	22644 K-48	Screw -----	2
36	660-219 A	Roll Pin -----	1
37	22570	Screw -----	2
38	61494 R	Oil Distributing Plate -----	1
39	29475 AS	Tension Assembly -----	1
40	660-269 A	Quad Ring -----	1
41	61492 E	Tension Post Socket -----	1
42	22560 G	Set Screw -----	1
43	61492 G	Tension Release Pin -----	1
44	61492 F	Tension Post -----	1
45	63453	Take-up Spring -----	1
46	109	Tension Disc -----	2
47	61492 H	Tension Release Washer -----	1
48	61392 F-9	Tension Spring -----	1
49	61292 C	Tension Nut -----	1
50 to 91		See following page	

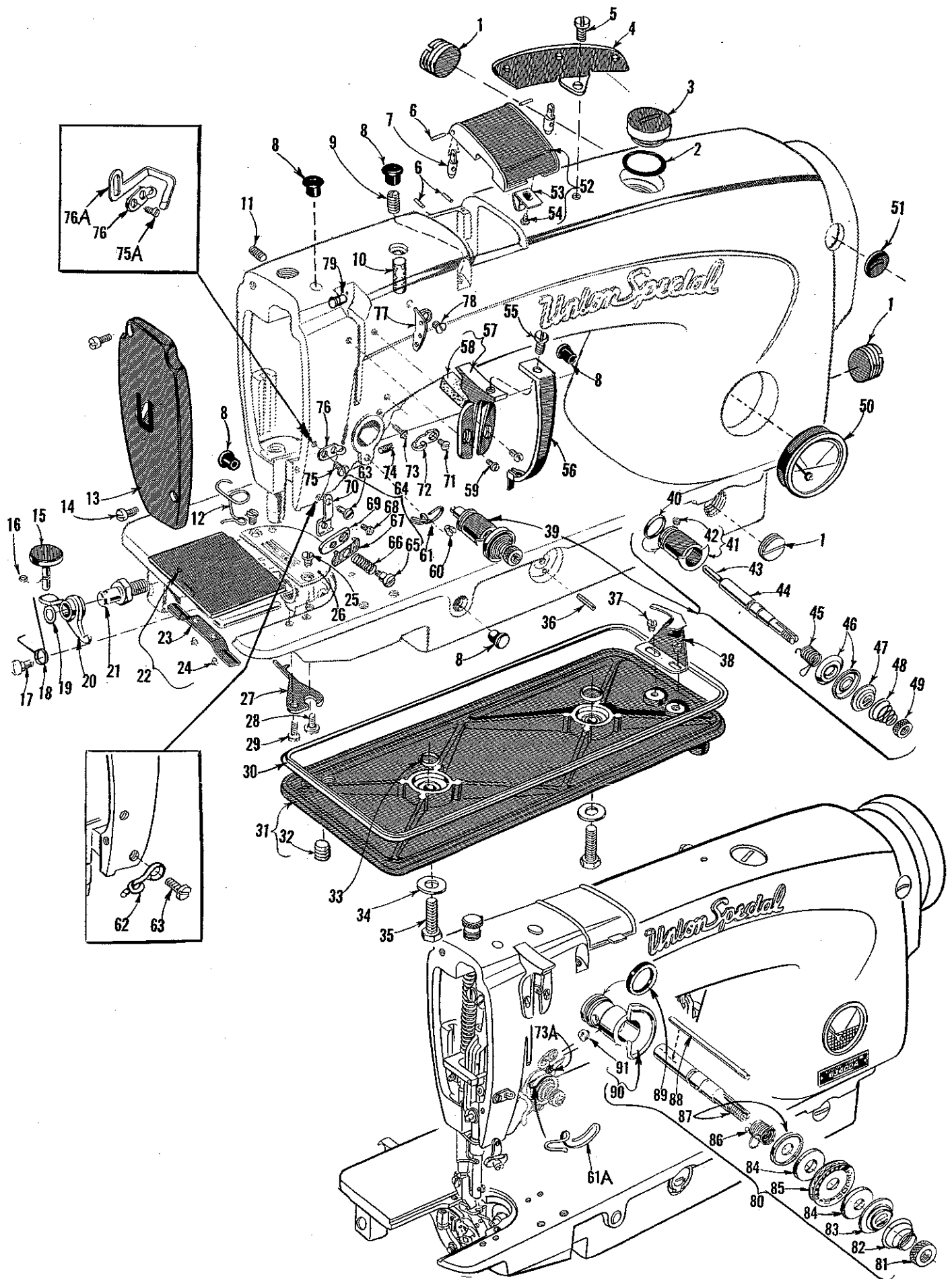

MAIN FRAME, MISCELLANEOUS COVERS AND NEEDLE TENSION PARTS

<u>Ref. No.</u>	<u>Part No.</u>	<u>Description</u>	<u>Amt. Req.</u>
1 to 49		See preceding page	
50	63494 K	Oil Gauge -----	1
51	61449 T	Stitch Length Indicator -----	1
52	63982 A	Top Cover -----	1
53	63982 F	Spring Latch -----	1
54	90	Screw -----	1
55	22564	Screw -----	1
56	63451	Take-up Shield -----	1
57	63971 A	Take-up Lever Hood -----	1
58	666-222	Felt Pad -----	1
59	22562	Screw -----	2
60	HS24 C	Screw -----	1
61	63492	Tension Post Socket Eyelet, for Styles 63900 A, B-----	1
61A	63992 A	Tension Post Socket Eyelet, for Styles 63900 C, D, AL-----	1
62	63470	Lower Needle Thread Eyelet-----	1
63	90	Screw -----	1
64	21390 BE	Nipper Spring Assembly -----	1
65	57 WD	Screw -----	1
66	57 WC	Nipper Spring -----	1
67	57 WB	Nipper Spring Plate -----	1
68	22564 B	Screw -----	1
69	63471	Nipper Base -----	1
70	63471 A	Nipper Spring Mounting Bracket-----	1
71	22766	Screw -----	1
72	61470 C	Thread Guide -----	1
73	22863 B	Stop Screw, for tension assembly, for Styles 63900 A, B ---	1
73A	12935 A	Stop Screw, for tension assembly, for Styles 63900 C, D, AL -----	1
74	22597 E	Set Screw, for tension assembly -----	1
75	222 D	Screw, for Styles 63900 A, B-----	1
75A	22766	Screw, for Styles 63900 C, D, AL -----	1
76	63470 A	Upper Thread Eyelet -----	1
76A	63970 A	Needle Thread Pull-off, for Styles 63900 C, D, AL -----	1
77	61471 A	Frame Thread Eyelet -----	1
78	22805	Screw -----	1
79	CO67 B	Plug, cork-----	1
80	29475 BE	Rotary Needle Tension Assembly, for Styles 63900 C, D, AL -----	1
81	61292 C	Tension Nut -----	1
82	63492 C-4	Tension Spring -----	1
83	61492 H	Tension Release Washer -----	1
84	61492 T	Felt Washer -----	2
85	61492 S	Rotary Tension Disc -----	1
86	63453 N	Take-up Spring-----	1
87	63492 A	Tension Post -----	1
88	63492 B	Tension Release Pin -----	1
89	660-269 A	Quad Ring -----	1
90	63992	Tension Post Socket -----	1
91	22560 G	Set Screw -----	1

NOTE: Reference Nos. 64 thru 70 are not assembled to machine but included with machine, for special operations.

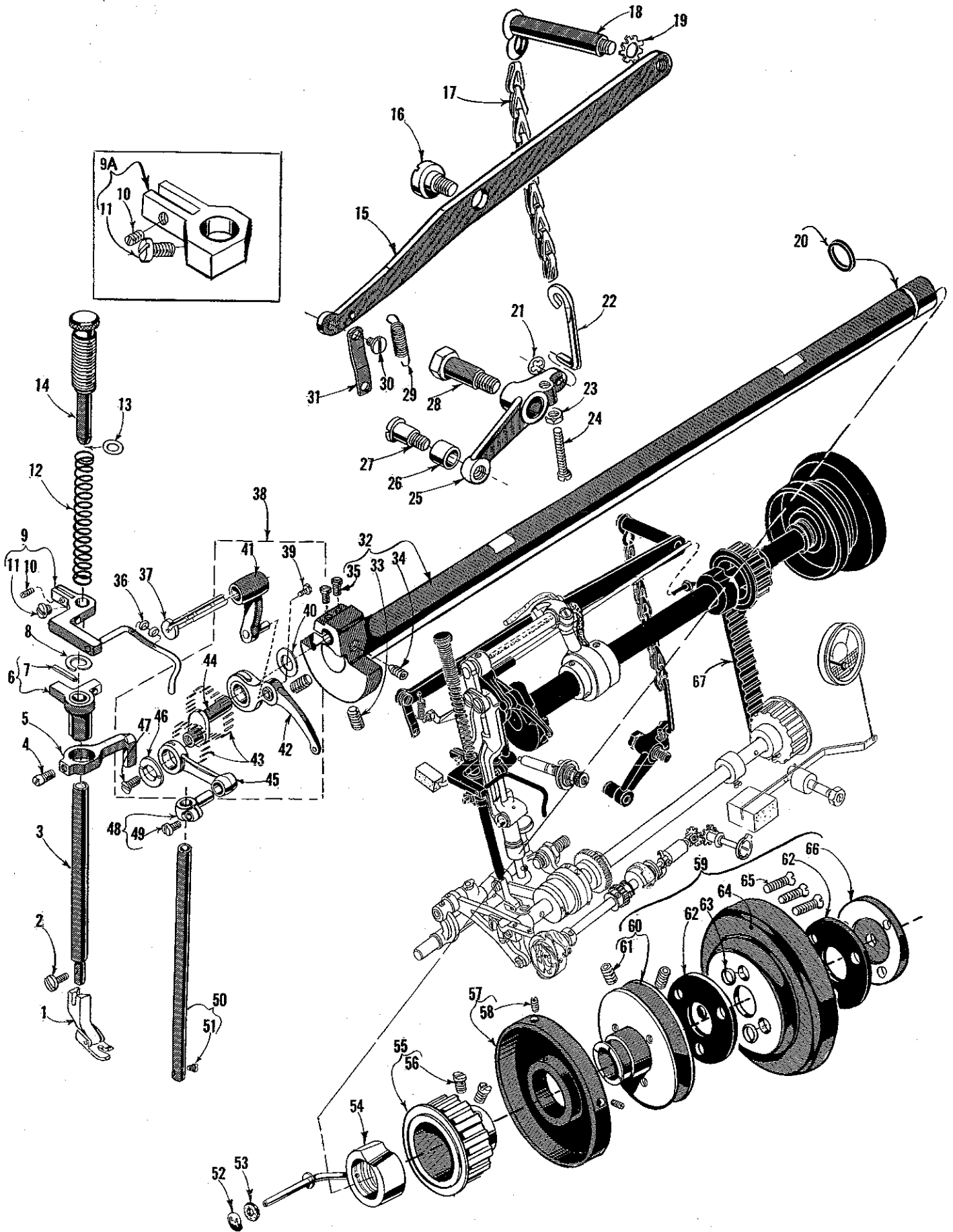

UPPER SHAFT, PRESSER BAR, NEEDLE BAR AND FOOT LIFTER MECHANISM

Ref. No.	Part No.	Description	Amt. Req.
1		Presser Foot (See Pages 59, 61, 63)	1
2	22775	Screw	1
3	63457 J	Presser Bar	1
4	230	Screw	1
5	61458 G	Tension Release Cam	1
6	61458 FA	Presser Bar Connection	1
7	660-219 B	Roll Pin	1
8	63457 R	Presser Bar Spring Washer	1
* 9	63959 A	Presser Bar Guide, for Styles 63900 A, B	1
9A	63459 B	Presser Bar Guide, for Styles 63900 C, D, AL	1
10	73 C	Screw	1
11	22570	Screw	1
12	63956	Presser Spring	1
13	61256 G	Presser Spring Washer	1
14	61457 B	Presser Spring Regulator	1
15	63466	Lifter Lever	1
16	22890 A	Screw, left thread	1
17	421 H	Lifter Lever Chain	1
18	61468 B	Lifter Lever Extension Stud and Hook	1
19	652 B-20	Lock Washer	1
20	660-269	Quad Ring	1
21	660-283 A	Spring Grip Fastener	1
22	61468 D	Chain Hook	1
23	9937	Nut	1
24	22874 F	Screw	1
25	61468 F	Lifter Lever Bell Crank	1
26	61468 E	Bell Crank Roller	1
27	22712 G	Screw	1
28	22817 A	Screw	1
29	15872 F	Lifter Lever Spring	1
30	22758 B	Screw	1
31	61467	Lifter Lever Link	1
32	29475 AM	Main Shaft Assembly, for Styles 63900 A, C, AL	1
	29475 AZ	Main Shaft Assembly, for Styles 63900 B, D	1
33	22894 V	Set Screw	2
34	22894 U	Spot Screw	1
35	22839	Screw	2
36	660-254 C	"O" Ring, for Styles 63900 A, B	2
37	61451 B	Take-up Lever Pin	1
38	29486 L	Take-up Lever and Needle Bar Link Assembly	1
39	22784 E	Screw	1
40	61351 C	Thrust Washer	1
41	61451 A	Take-up Lever Link	1
42	61451	Take-up Lever	1
43	61451 D-625	Needle Bearing, .0625 inch diameter	38
	61451 D-626	Needle Bearing, .0626 inch diameter	38
	61451 D-627	Needle Bearing, .0627 inch diameter	38
44	63452 A	Take-up Lever Crank Pin	1
45	61455	Needle Bar Link	1
46	63455	Thrust Washer	1
47	22757 D	Screw	1
48	61255	Needle Bar Connection	1
49	22562 B	Screw	1
50	63917	Needle Bar, marked "EG"	1
51	22768 A	Screw	1
52	660-456	Push-on Fastener	1
53	666-273	Felt Disc	1
54	63493 J	Oil Return Pump	1
55	61460	Main Shaft Driving Sprocket	1
56	22884	Set Screw	2
57	61421 F	Stitch Length Indicator	1
58	22565 C	Set Screw	2
59	61421 B	Handwheel Assembly	1
60	61421 D	Pulley	1
61	22894 V	Set Screw	2
62	61421 E	Handwheel Isolator	2
63	660-254 D	Isolator Washer	3
64	61421 C	Handwheel	1
65	22574 C	Screw	3
66	61421 G	Hub Washer	1
67	61460 B	Feed Driving Belt	1

* DISCONTINUED - REPLACED BY ONE EACH Nos. 63459 B and 63970 A.

NOTE: Do not tighten needle bar frame rock shaft connecting link (Det. 7) too tightly, as this will cause binds in the needle bar frame (Det. 5) and the needle bar rock shaft (Det. 9).

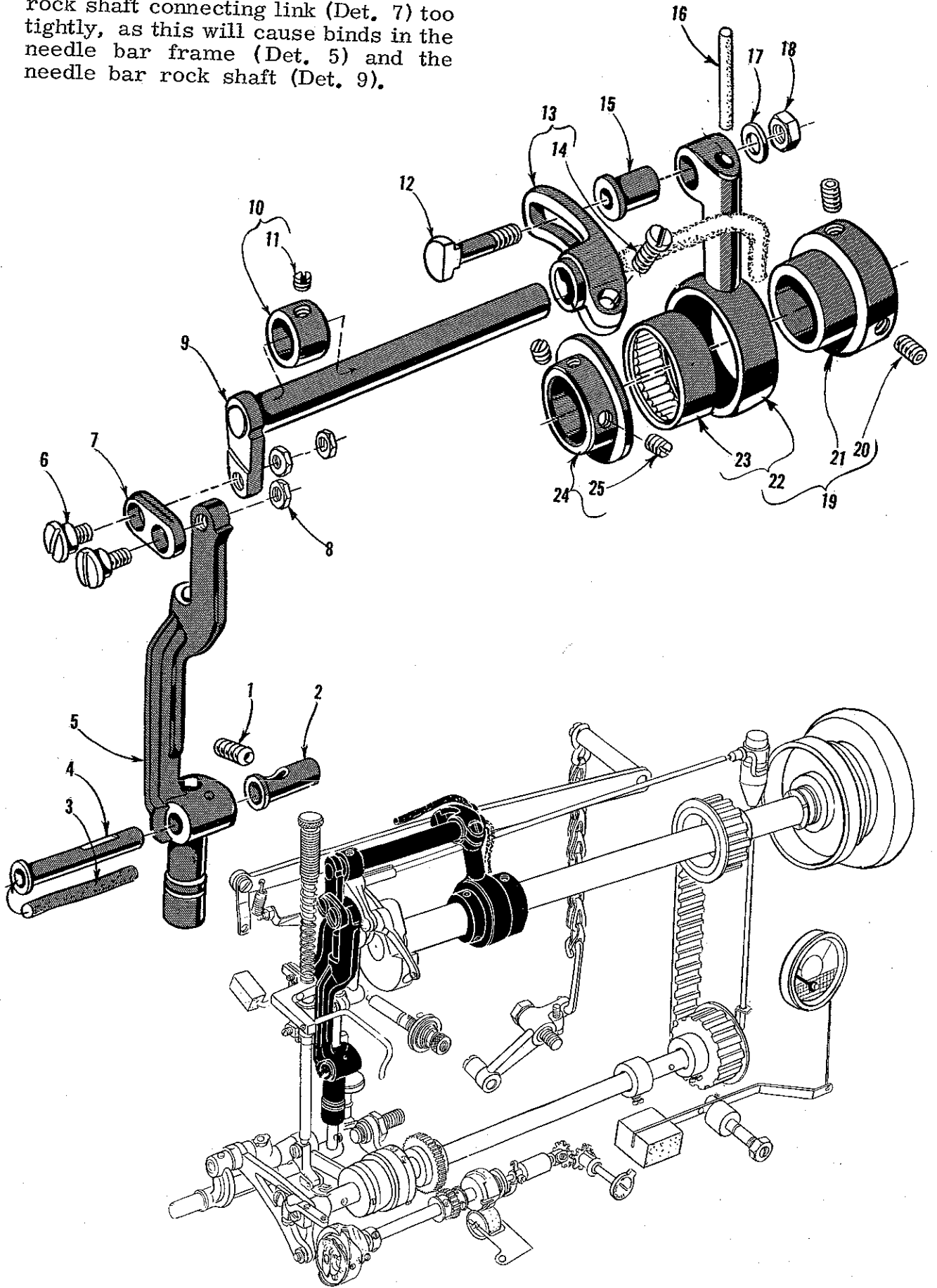

NEEDLE FEED DRIVING PARTS

<u>Ref. No.</u>	<u>Part No.</u>	<u>Description</u>	<u>Amt. Req.</u>
1	22894 E	Screw -----	1
2	61985 J	Needle Bar Frame Pivot Adjustable Bushing -----	1
3	666-139	Oil Wick -----	1
4	61985 A	Needle Bar Frame Pivot Stud -----	1
5	63985	Needle Bar Frame -----	1
6	22504 H	Screw -----	2
7	61985 D	Needle Bar Frame Rock Shaft Connecting Link -----	1
8	14077	Nut -----	3
9	61985 B	Needle Bar Frame Rock Shaft -----	1
10	51773	Collar -----	1
11	88 B	Screw -----	1
12	61984 C	Needle Bar Drive Eccentric Connecting Stud -----	1
13	61985 F	Needle Bar Frame Rock Shaft Driving Lever -----	1
14	22839	Screw -----	1
15	60038 G	Bearing Sleeve -----	1
16	666-173	Oil Wick -----	1
17	20	Washer -----	1
18	18	Nut -----	1
19	29126 EB	Needle Feed Drive Eccentric Assembly, for Styles 63900 C, D and AL -----	1
	29126 DW	Needle Feed Drive Eccentric Assembly, for Styles 63900 A and B -----	1
20	22894 J	Screw -----	2
21	63984	Needle Feed Driving Eccentric (.088 inch throw) for No. 29126 DW -----	1
	63984 E	Needle Feed Driving Eccentric (.094 inch throw) for No. 29126 EB -----	1
22	63984 B	Needle Feed Driving Eccentric Bearing -----	1
23	660-244	Needle Bearing -----	1
24	63984 A	Needle Bearing Retaining Collar -----	1
25	95	Screw -----	2

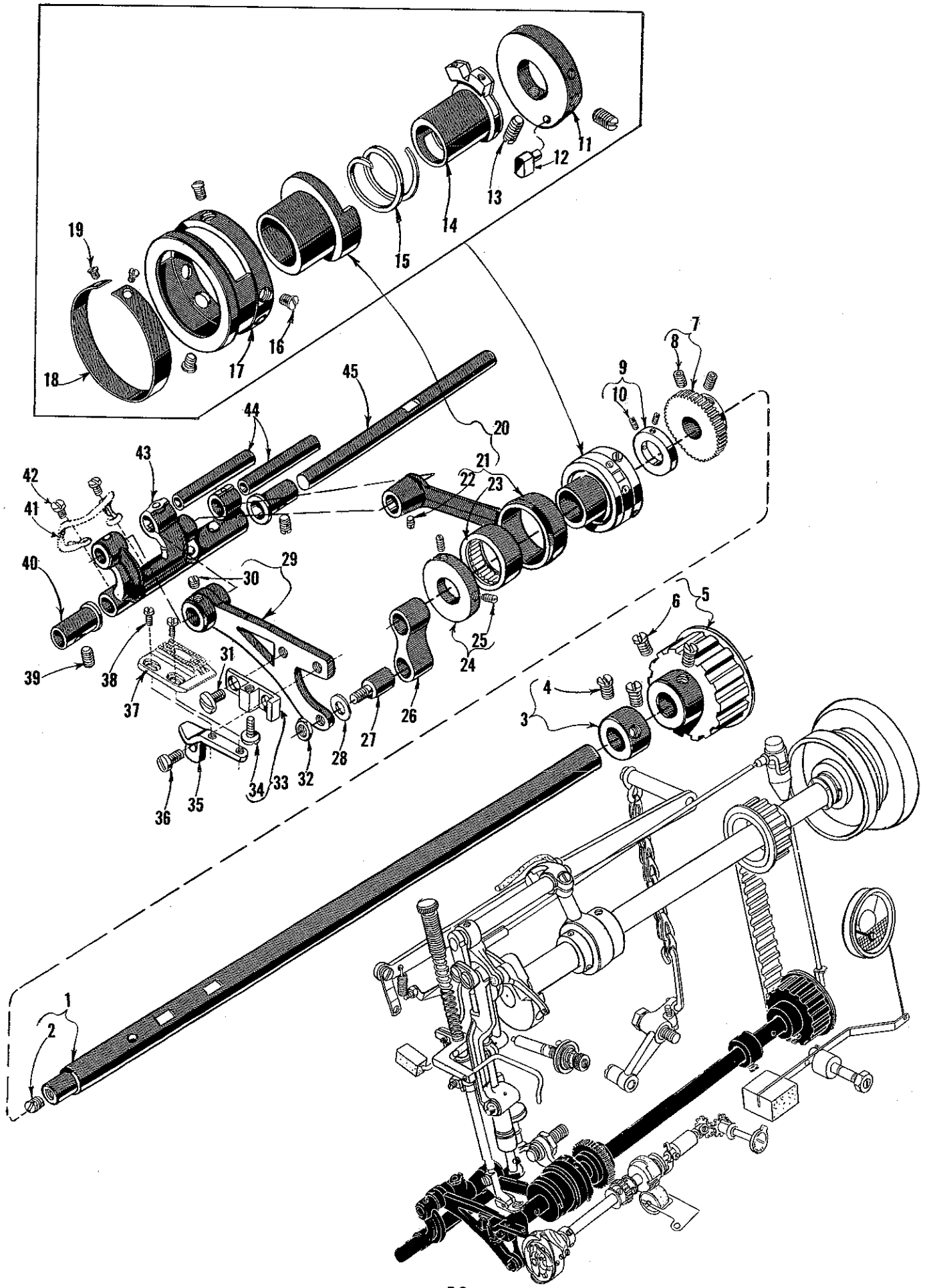

FEED DRIVING AND STITCH REGULATING MECHANISM

<u>Ref. No.</u>	<u>Part No.</u>	<u>Description</u>	<u>Amt. Req.</u>
1	63432 A	Feed Driving Shaft, .050 inch throw, for Style 63900 AL -----	1
	61432 H	Feed Driving Shaft, .070 inch throw, for all Styles except 63900 AL -----	1
2	22586	Plug Screw -----	1
3	61360 G	Thrust Collar -----	1
4	22884	Screw -----	2
5	61460 A	Feed Driving Shaft Sprocket -----	1
6	22653 D-6	Screw -----	2
7	63443	Hook Shaft Driving Gear -----	1
8	22894 C	Set Screw -----	2
9	61432 J	Collar -----	1
10	73 C	Set Screw -----	2
11	61437 A	Feed Driving Eccentric Timing Collar -----	1
12	61437 B	Feed Driving Eccentric Pivot Pin -----	1
13	719	Screw -----	2
14	61449 S	Stitch Regulating Eccentric -----	1
15	61449 B	Stitch Regulating Eccentric Thrust Spring -----	1
16	22564 H	Screw -----	3
17	61437 L	Feed Drive Eccentric Retainer Housing -----	1
18	61437 M	Retainer Housing Spring Cover -----	1
19	22716 A	Screw -----	2
20	29126 DD	Feed Driving Eccentric and Connecting Rod Assembly --	1
21	61438 B	Feed Driving Eccentric Connecting Rod -----	1
22	88	Set Screw -----	1
23	660-225	Needle Bearing -----	1
24	61437 N	Feed Driving Eccentric Thrust Collar -----	1
25	12935 A	Set Screw -----	2
26	63433 A	Feed Lift Link -----	1
27	22845 K	Feed Lift Link Stud -----	1
28	61434 G	Washer -----	1
29	63434 C	Feed Bar -----	1
30	89	Set Screw -----	1
31	88 D	Screw -----	1
32	15037 A	Nut -----	1
33	63439 AL	Feed Dog Holder Support -----	1
34	22775 A	Screw -----	1
35	63439 A	Feed Dog Holder -----	1
36	22528	Screw -----	1
37		Feed Dog (See Pages 55, 57, 59) -----	1
38	22768	Screw -----	2
39	22894 J	Screw -----	2
40	61336 U	Feed Rocker Shaft Bushing -----	2
41	61336 Y	Feed Rocker Oil Wick -----	1
42	90	Screw -----	2
43	61236	Feed Rocker -----	1
44	63435 A	Feed Bar Shaft -----	2
45	61236 G	Feed Rocker Shaft -----	1

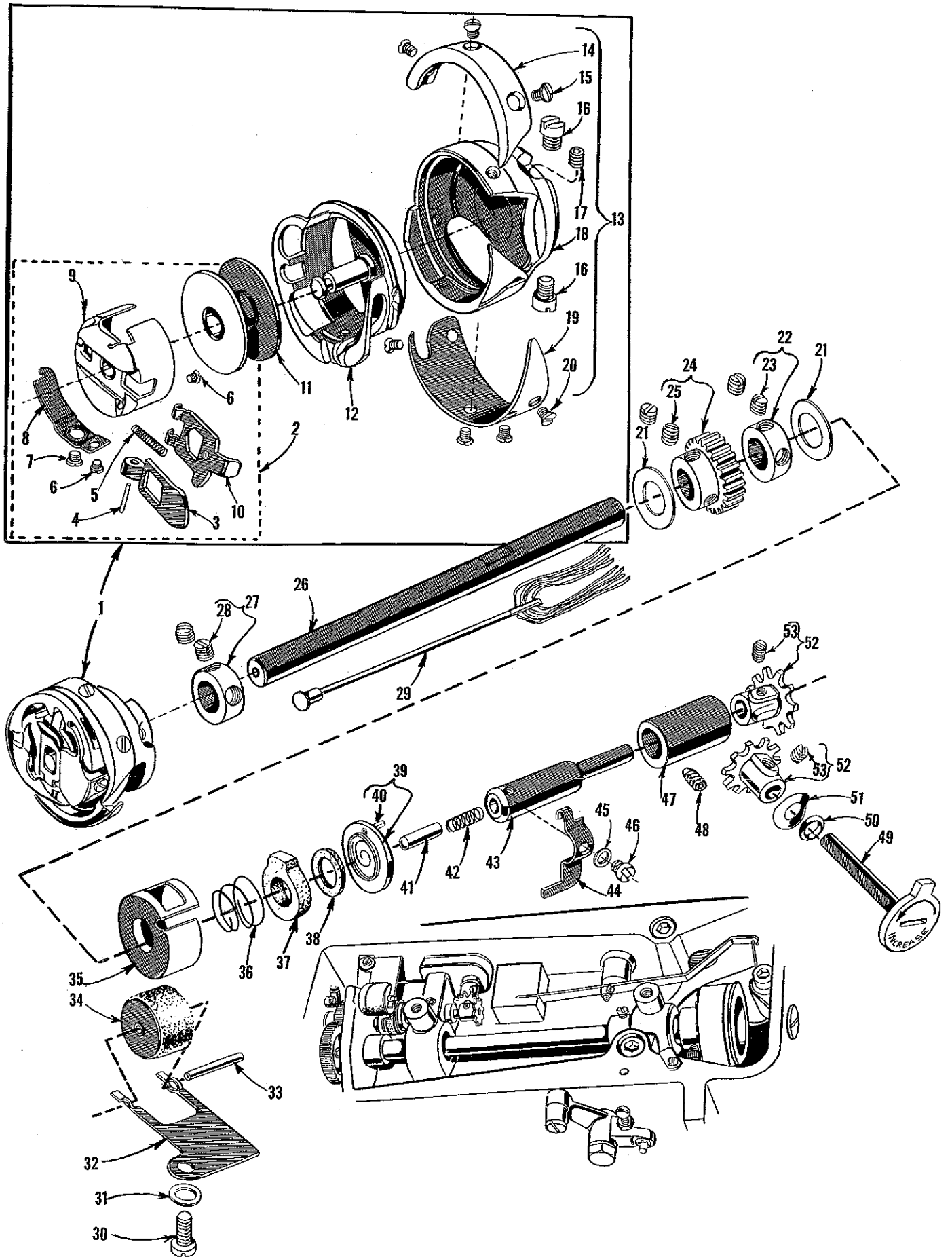

ROTATING HOOK ASSEMBLY AND HOOK OILING PARTS.

<u>Ref. No.</u>	<u>Part No.</u>	<u>Description</u>	<u>Amt. Req.</u>
1	29474 S	Rotating Hook Assembly -----	1
2	63913 A	Bobbin Case Assembly -----	1
3	61415 A	Bobbin Case Latch Lever -----	1
4	61216	Bobbin Case Latch Hinge Pin -----	1
5	61216 N	Bobbin Case Latch Spring -----	1
6	22564 E	Screw -----	2
7	22716 B	Tension Regulating Screw -----	1
8	61414 C	Bobbin Case Tension Spring -----	1
9	63913	Bobbin Case -----	1
10	61415	Bobbin Case Latch -----	1
11	61212	Bobbin -----	1
12	63914	Bobbin Case Holder -----	1
13	63907 A	Hook, Thread Retainer and Thread Deflector Assembly -----	1
14	61411 A	Hook Thread Retainer -----	1
15	22716 H	Screw -----	3
16	22569 H	Set Screw -----	2
17	22565 M	Screw -----	1
18	63908	Hook -----	1
19	63410	Hook Thread Deflector -----	1
20	22716 A	Screw -----	4
21	61351 C	Thrust Washer -----	2
22	12865	Thrust Collar -----	1
23	88	Screw -----	2
24	61444	Hook Shaft Pinion -----	1
25	89	Screw -----	2
26	61440	Hook Shaft -----	1
27	63432	Hook Shaft Collar, left -----	1
28	HA73 B	Screw -----	2
29	61496 V	Wick Inserting Rod Assembly -----	1
30	22516 B	Screw -----	1
31	53678 N	Washer -----	1
32	61496 F	Retaining Spring -----	1
33	61496 G	Pivot Pin -----	1
34	61496 E	Hook Oil Feed Roller -----	1
35	63496 B	Metering Cup -----	1
36	61496 J	Air Seal Spring -----	1
37	666-181	Oil Supply Felt -----	1
38	666-182	Air Seal Felt -----	1
39	61496 C	Pump Disc -----	1
40	660-219 D	Roll Pin -----	1
41	61496 D	Pump Disc Pivot Pin -----	1
42	35857 R	Spring -----	1
43	61496 L	Hook Oil Control Shaft -----	1
44	61496 K	Hook Oil Control Finger -----	1
45	27-527 Blk.	Washer -----	1
46	22819	Screw -----	1
47	61496 P	Hook Oil Control Shaft Bushing -----	1
48	22894 R	Screw -----	1
49	61496 N	Oil Control Adjusting Shaft -----	1
50	660-221	Oil Seal Ring -----	1
51	39198 D	Spring Washer -----	1
52	61496 M	Oil Control Cog -----	2
53	22743	Set Screw -----	1

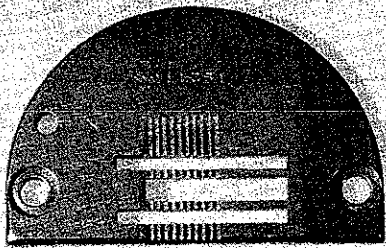

61924 K

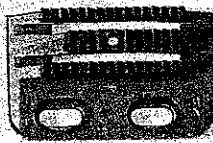

61905 K-073
61905 K-083

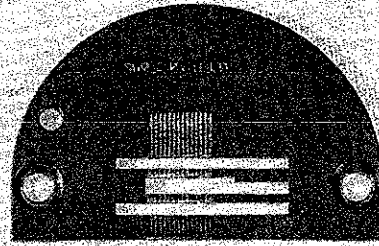

61924 J



61905 J-063

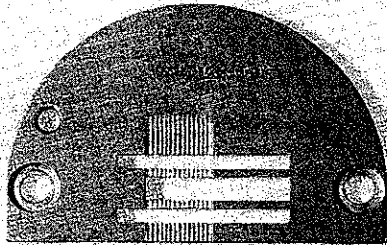

61924 C

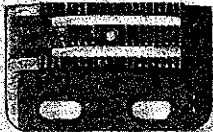

61905 F-063



61905 C-073

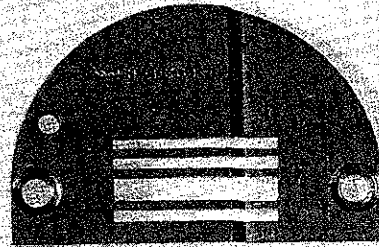

61924 H



61905 H-063
61905 H-083

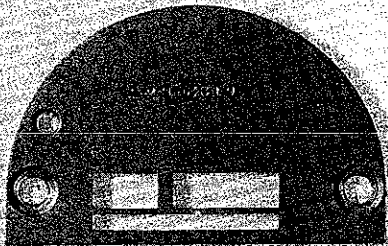

61924 B

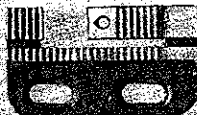

61905 B-063
61905 B-073
61905 B-083

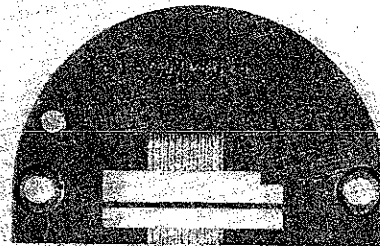

61924 E

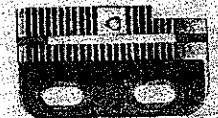

61905 M-063



61905 E-073

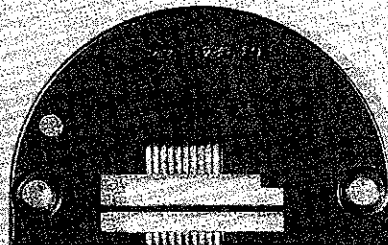

61924 G



61905 G-073
61905 G-083

THROAT PLATE - FEED DOG COMBINATIONS
NEEDLE HOLE IN FEED DOG

<u>Part No.</u>	<u>Description</u>
61905 B-063	Feed Dog, 22 teeth per inch and .063 inch diameter needle hole. For use with Throat Plate No. 61924 B on Style Nos. 5, 5A, 15.
61905 B-073	Feed Dog, 22 teeth per inch and .073 inch diameter needle hole. For use with Throat Plate No. 61924 B on Style Nos. 5, 5A, 15.
61905 B-083	Feed Dog, 22 teeth per inch and .083 inch diameter needle hole. For use with Throat Plate No. 61924 B on Style Nos. 5, 5A, 15.
61905 C-073	Feed Dog, 16 teeth per inch and .073 inch diameter needle hole. For use with Throat Plate No. 61924 C on Style Nos. 10, 10A, 11, 26.
61905 E-073	Feed Dog, 16 teeth per inch and .073 inch diameter needle hole. For use with Throat Plate No. 61924 E on Style Nos. 13, 20, 20A, 20B, 28, 28A.
61905 F-063	Feed Dog, 22 teeth per inch and .063 inch diameter needle hole. For use with Throat Plate No. 61924 C on Style No. 6.
61905 G-073	Feed Dog, 16 teeth per inch and .073 inch diameter needle hole. For use with Throat Plate No. 61924 G on Style No. 14.
61905 G-083	Feed Dog, 16 teeth per inch and .083 inch diameter needle hole. For use with Throat Plate No. 61924 G on Style No. 14.
61905 H-063	Feed Dog, 16 teeth per inch and .063 inch diameter needle hole. For use with Throat Plate No. 61924 H on Style No. 78.
61905 H-083	Feed Dog, 16 teeth per inch and .083 inch diameter needle hole. For use with Throat Plate No. 61924 H on Style No. 78.
61905 J-063	Feed Dog, 22 teeth per inch and .063 inch diameter needle hole. For use with Throat Plate No. 61924 J on Style Nos. 8, 9, 9A, 16, 29, 38.
61905 K-073	Feed Dog, 16 teeth per inch and .073 inch diameter needle hole. For use with Throat Plate No. 61924 K on Style Nos. 12, 12A, 12B, 24.
61905 K-083	Feed Dog, 16 teeth per inch and .083 inch diameter needle hole. For use with Throat Plate No. 61924 K on Style Nos. 12, 12A, 12B, 24.
61905 M-063	Feed Dog, 22 teeth per inch and .063 inch diameter needle hole. For use with Throat Plate No. 61924 E on Style No. 25.
61924 B	Throat Plate, .085 inch thick. For use with Feed Dog Nos. 61905 B-063, 61905 B-073 or 61905 B-083 on Style Nos. 5, 5A, 15.
61924 C	Throat Plate, .085 inch thick and serrations on top cut 32 teeth per inch. For use with Feed Dog No. 61905 F-063 on Style No. 6 and with Feed Dog No. 61905 C-073 on Style Nos. 10, 10A, 11, 26.
61924 E	Throat Plate, .085 inch thick and serrations on top cut 20 teeth per inch. For use with Feed Dog No. 61905 M-063 on Style No. 25 and with Feed Dog No. 61905 E-073 on Style Nos. 13, 20, 20A, 20B, 28, 28A.
61924 G	Throat Plate, .125 inch thick, beveled at front and serrations on top cut 20 teeth per inch. For use with Feed Dog No. 61905 G-073 or 61905 G-083 on Style No. 14.
61924 H	Throat Plate, .203 inch thick at back and .109 inch thick at front. For use with Feed Dog No. 61905 H-063 or 61905 H-083 on Style No. 78.
61924 J	Throat Plate, .085 inch thick and serrations on top cut 32 teeth per inch. For use with Feed Dog No. 61905 J-063 on Style Nos. 8, 9, 9A, 16, 29, 38.
61924 K	Throat Plate, .125 inch thick, beveled at front and serrations on top cut 20 teeth per inch. For use with Feed Dog No. 61905 K-073 or 61905 K-083 on Style Nos. 12, 12A, 12B, 24.

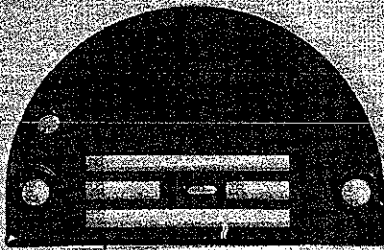

61928 H
61928 H-050

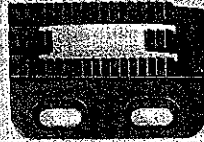

61926 H

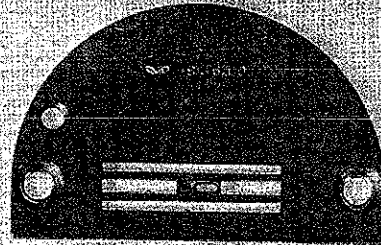

61928



61926



61926 T

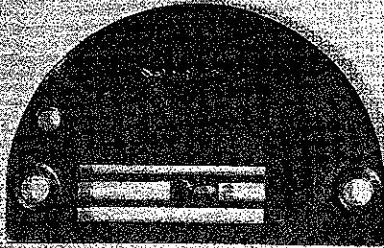

61928 B
61928 R



61926 D, 61926 R

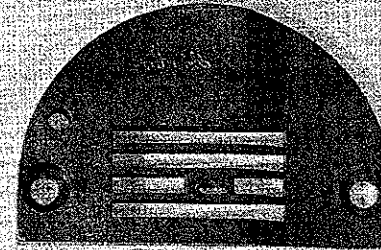

L581 A

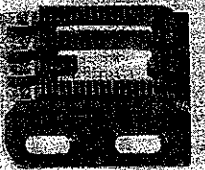

L582 A

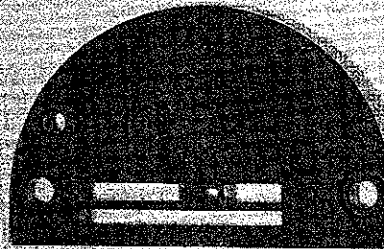

61928 C



61926 E

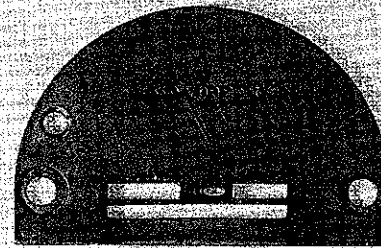

61928 A



61926 A



61926 F



L378 A



L379 A

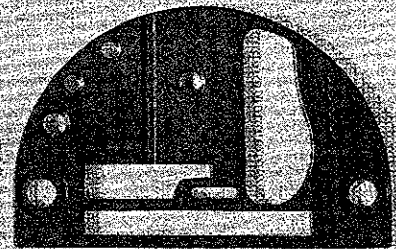

61928 M-073

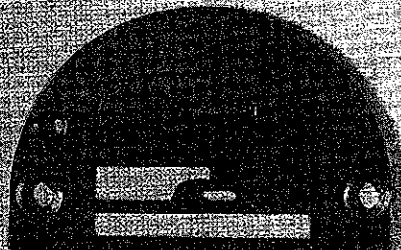

63928 E



61926 B

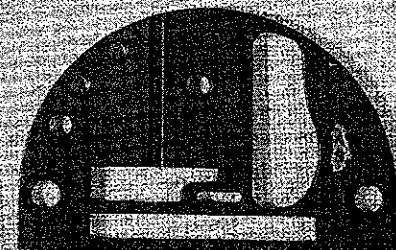

61928 M-053

THROAT PLATE - FEED DOG COMBINATIONS
NEEDLE HOLE IN THROAT PLATE

<u>Part No.</u>	<u>Description</u>
L378 A	Throat Plate, .063 inch wide needle slot and .085 inch thick. For use with Feed Dog No. L379 A on Style No. 84.
L379 A	Feed Dog, 22 teeth per inch. For use with Throat Plate No. L378 A on Style No. 84.
63928 E	Throat Plate, .073 inch wide needle slot and .085 inch thick. For use with Feed Dog No. 61926 B on Style No. 80.
L581 A	Throat Plate, .063 inch wide needle slot, .226 inch thick at back and .109 inch thick at front. For use with Feed Dog No. L582 A on Style Nos. 85, 86, 86A.
L582 A	Feed Dog, 22 teeth per inch. For use with Throat Plate No. L581 A on Style Nos. 85, 86, 86A.
61926	Feed Dog, 22 teeth per inch. For use with Throat Plate No. 61928 on Style Nos. 3, 3A, 7, 7A, 7B, 18, 18A, 19, 30, 30A, 31, 31A, 32, 77.
61926 A	Feed Dog, 22 teeth per inch. For use with Throat Plate No. 61928 A on Style Nos. 4, 4A, 4B, 4C, 76, 83.
61926 B	Feed Dog, 16 teeth per inch. For use with Throat Plate 63928 E on Style No. 80, with Throat Plate No. 61928 M-073 on Style No. 79 and with Throat Plate No. 61928 M-053 on Style Nos. 81, 82.
61926 C	Feed Dog, 16 teeth per inch. For use with Throat Plate No. 61928 B on Style Nos. 21, 21A, 21B, 21C, 22, 27, 36, 36A.
61926 D	Feed Dog, 22 teeth per inch. For use with Throat Plate No. 61928 B on Style Nos. 1, 2, 2A, 2B, 17, 37, 39.
61926 E	Feed Dog, 16 teeth per inch. For use with Throat Plate No. 61928 C on Style No. 33.
61926 F	Feed Dog, 22 teeth per inch. For use with Throat Plate No. 61928 C on Style No. 35.
61926 H	Feed Dog, 16 teeth per inch. For use with Throat Plate No. 61928 H or 61928 H-050 on Style Nos. 23, 23A.
61926 R	Feed Dog, 22 teeth per inch. For sewing at 7 stitches per inch. For use with Throat Plate No. 61928 R on Style No. 40.
61926 T	Feed Dog, 16 teeth per inch. For use with Throat Plate No. 61928 on Style No. 34.
61928	Throat Plate, .053 inch wide needle slot and .085 inch thick. For use with Feed Dog No. 61926 T on Style No. 34 and with Feed Dog No. 61926 on Style Nos. 3, 3A, 7, 7A, 7B, 18, 18A, 19, 30, 30A, 31, 31A, 32, 77.
61928 A	Throat Plate, .053 inch wide needle slot and .085 inch thick. For use with Feed Dog No. 61926 A on Style Nos. 4, 4A, 4B, 4C, 76, 83.
61928 B	Throat Plate, .053 inch wide needle slot and .085 inch thick. For use with Feed Dog No. 61926 C on Style Nos. 21, 21A, 21B, 21C, 22, 27, 36, 36A, and with 61926 D on Style Nos. 1, 2, 2A, 2B, 17, 37, 39.
61928 C	Throat Plate, .053 inch wide needle slot and .085 inch thick. For use with Feed Dog No. 61926 E on Style No. 33 and with Feed Dog No. 61926 F on Style No. 35.
61928 H	Throat Plate, .073 inch wide needle slot and .125 inch thick. For use with Feed Dog No. 61926 H on Style Nos. 23, 23A.
61928 H-050	Throat Plate, .050 inch wide needle slot and .125 inch thick. For use with Feed Dog No. 61926 H on Style Nos. 23, 23A.
61928 M-053	Throat Plate, .053 inch wide needle slot and .085 inch thick. For use with Feed Dog No. 61926 B on Style Nos. 81, 82.
61928 M-073	Throat Plate, .073 inch wide needle slot and .085 inch thick. For use with Feed Dog No. 61926 B on Style No. 79.
61928 R	Throat Plate, .053 inch wide needle slot and .085 inch thick. For sewing at 7 stitches per inch. For use with Feed Dog No. 61926 R on Style No. 40.

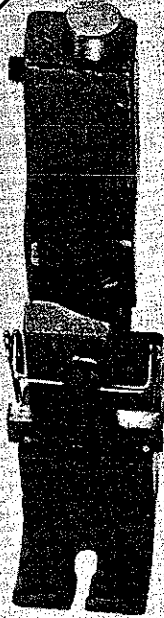

61920 K

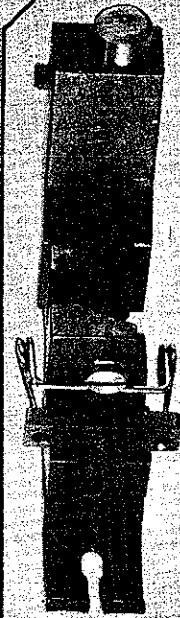

61920 G

29480 CN
29480 EP

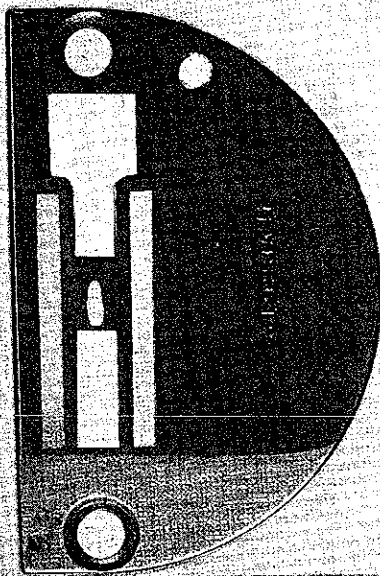

61928 K-050, 61928K-060

29480 CM
29480 EN

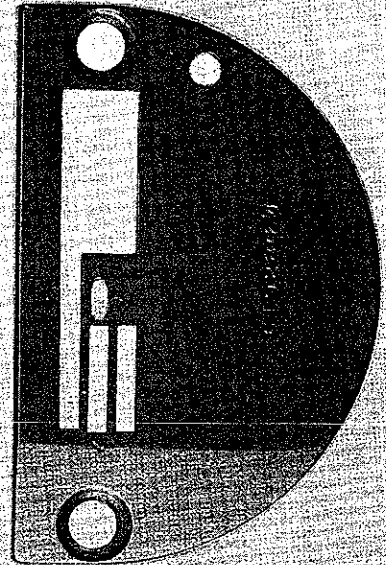

61928 G-050, 61928G-060

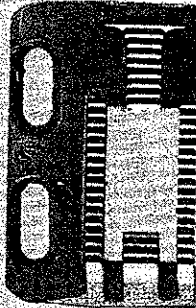

61405 AC

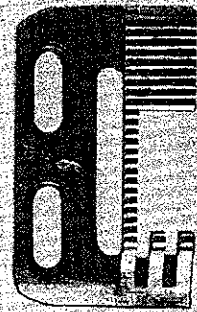

61926 G

AUTOMATIC CHAIN CUTTER ASSEMBLIES

<u>Part No.</u>	<u>Description</u>
29480 CM	Automatic Chain Cutter Assembly, 29/64 inch wide over-all, 7/32 inch margin to right of needle and with a .060 inch wide needle slot in throat plate; consists of Presser Foot No. 61920 G, Feed Dog No. 61926 G and Throat Plate No. 61928 G-060 on Style No. 88.
29480 CN	Automatic Chain Cutter Assembly, 37/64 inch wide over-all, 9/32 inch margin to right of needle and with a .060 inch wide needle slot in throat plate; consists of Presser Foot No. 61920 K, Feed Dog No. 61405 AC and Throat Plate No. 61928 K-060 on Style No. 89.
29480 EN	Automatic Chain Cutter Assembly, 29/64 inch wide over-all, 7/32 inch margin to right of needle and with a .050 inch wide needle slot in throat plate; consists of Presser Foot No. 61920 G, Feed Dog No. 61926 G and Throat Plate No. 61928 G-050 on Style No. 90.
29480 EP	Automatic Chain Cutter Assembly, 37/64 inch wide over-all, 9/32 inch margin to right of needle and with a .050 inch wide needle slot in throat plate; consists of Presser Foot No. 61920 K, Feed Dog No. 61405 AC and Throat Plate No. 61928 K-050 on Style No. 91.
61405 AC	Feed Dog, marked "AV", 22 teeth per inch. For use with Throat Plate No. 61928 K-060 on Style No. 89 and with Throat Plate No. 61928 K-050 on Style No. 91.
61920 G	Presser Foot, hinged compensating bottom, with chain cutter, 29/64 inch wide over-all and 7/32 inch margin to right of needle. For Style Nos. 88, 90.
61920 K	Presser Foot, hinged compensating bottom, with chain cutter, 37/64 inch wide over-all and 9/32 inch margin to right of needle. For Style Nos. 89, 91.
61926 G	Feed Dog, marked "BB", 22 teeth per inch. For use with Throat Plate No. 61928 G-060 on Style No. 88 and with Throat Plate No. 61928 G-050 on Style No. 90.
61928 G-050	Throat Plate, .050 inch wide needle slot and .125 inch thick. For use with Feed Dog No. 61926 G on Style No. 90.
61928 G-060	Throat Plate, .060 inch wide needle slot and .125 inch thick. For use with Feed Dog No. 61926 G on Style No. 88.
61928 K-050	Throat Plate, .050 inch wide needle slot and .125 inch thick. For use with Feed Dog No. 61405 AC on Style No. 91.
61928 K-060	Throat Plate, .060 inch wide needle slot and .125 inch thick. For use with Feed Dog No. 61405 AC on Style No. 89.



61920 M



L391 A



61420 BT



61920 C



61920 T



61420 H

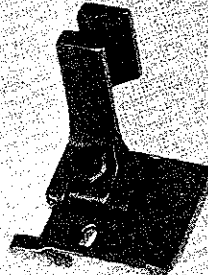

61420 CM



61420 AP

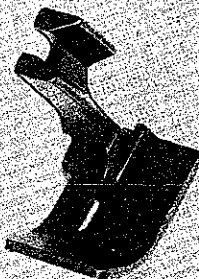

61220 K



61920 F



61920 U



L310 A



61920 D



61920 J



61420

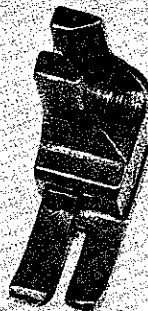

61920 P

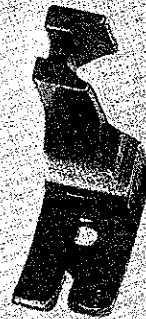

L471 A



L347 A

PRESSER FEET

<u>Part No.</u>	<u>Description</u>
L310 A	Presser Foot, hinged bottom, bottom relieved to the right and in back of needle hole, bottom 9/16 inch wide over-all, for hemming operation where turn is required. Similar to 61420 BN except lengthened needle hole. For Style No. 19.
L347 A	Presser Foot, rigid bottom, split bottom with yielding section on right side, 1/32 inch margin, bottom 11/32 inch wide over-all, for edge stitching operations. For Style No. 83.
L391 A	Presser Foot, hinged bottom, tilt adjusting screw in shank, bottom 15/32 inch wide over-all. For Style Nos. 80, 82.
L471 A	Presser Foot, hinged bottom, split bottom with yielding section on left side, bottom 17/32 inch wide over-all, for edge stitching operations. Similar to 61320 AH except lengthened needle hole. For Style Nos. 7A, 9A.
61220 K	Presser Foot, hinged spring bottom, bottom 3/4 inch wide over-all, for facing operations. For Style Nos. 78, 85.
61420	Presser Foot, hinged bottom, split bottom with both sides yielding bottom 17/32 inch wide over-all, for second operation of attaching collars to shirts. For Style No. 24.
61420 H	Presser Foot, hinged bottom, tilt adjusting screw in shank, bottom 7/8 inch wide over-all, for attaching sleeve facings to shirts. For Style No. 86A.
61420 AP	Presser Foot, hinged bottom, high turned up toe with notch on right side, bottom 5/8 inch wide over-all. For Style No. 31.
61420 BT	Presser Foot, hinged bottom, tilt adjusting screw in shank, bottom 7/16 inch wide over-all. For Style Nos. 5, 18, 20A, 25, 29, 37.
61420 CM	Presser Foot, hinged bottom, tilt adjusting screw in shank, bottom 7/8 inch wide over-all, flat bottom with guide on left hand side of toe, for facing operations. For Style No. 86.
61920 C	Presser Foot, hinged bottom, tilt adjusting screw in shank, bottom 17/32 inch wide over-all, for plain seaming and edging operations on medium to heavy weight work. For Style Nos. 11, 18A.
61920 D	Presser Foot, hinged bottom, split bottom with yielding section on left side, bottom 5/8 inch wide over-all, for shoulder joining, sleeve facing and similar operations on sport and dress shirts. For Style No. 39.
61920 F	Presser Foot, hinged spring bottom, bottom 17/32 inch wide over-all, step on left side of toe, for shoulder joining on shirts. For Style No. 6.
61920 J	Presser Foot, hinged bottom, split bottom with yielding section on right side, bottom 1/2 inch wide over-all, for setting pockets and edge stitching operations. Similar to 61420 A except lengthened needle hole. For Style Nos. 7, 9, 13, 14.
61920 M	Presser Foot, hinged bottom, hinge pin set back 1/8 inch more than standard, tilt adjusting screw in shank, return spring on side, bottom 1/2 inch wide over-all, for use on wash and wear material. For Style Nos. 2B, 22, 31A, 33, 35.
61920 P	Presser Foot, hinged bottom, split bottom with yielding section on left side, bottom 1/2 inch wide over-all, for edge stitching operations. Similar to 61420 B except lengthened needle hole. For Style Nos. 7B, 21.
61920 T	Presser Foot, hinged bottom, tilt adjusting screw in shank, bottom 17/32 inch wide over-all, for use with right angle binder. For Style Nos. 79, 81.
61920 U	Presser Foot, hinged bottom, 3/32 inch wide groove in bottom, bottom 15/32 inch wide over-all, for piping operations. For Style No. 84.
*63920 C	Presser Foot, hinged bottom, split toe, tilt adjusting screw in shank, bottom 13/32 inch wide over-all, with chain cutting knife and knife guard at the back. For sewing at 7 stitches per inch. For Style No. 40.

* Not shown on picture plate.



61420 BY

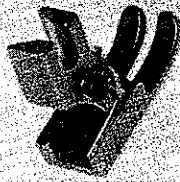

61920 L



61420 BV



61420 BU



61920 N



61920 A



61920 B



61920 S



L440 A



61920 R

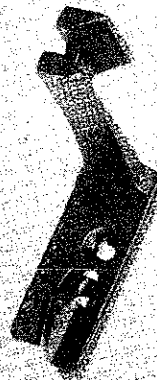

L460 A



L427 A



61320 P



61420 R



61927 A

PRESSER FEET

<u>Part No.</u>	<u>Description</u>
L427 A	Presser Foot, rigid bottom, for producing a 5/32 inch hem. For Style No. 77
L440 A	Presser Foot, hinged bottom, spring under shank for raising toe, 13/64 inch margin to right of needle, bottom 15/32 inch wide over-all, for plain seaming on light weight material. For Style Nos. 2A, 5A, 20B.
L460 A	Presser Foot, rigid bottom, for producing a 1/8 inch hem. For Style No. 76.
61320 P	Presser Foot, rigid bottom, 13/64 inch margin to right of needle, bottom 1/2 inch wide over-all. For Style Nos. 4A, 12B, 20.
61420 R	Presser Foot, rigid bottom, 3/32 inch margin to right of needle, bottom 5/16 inch wide over-all. For Style No. 4B.
61420 BU	Presser Foot, hinged bottom, tilt adjusting screw in shank, spring on left side for raising toe, 5/16 inch margin to right of needle, bottom 5/8 inch wide over-all, for sewing on wash and wear material. For Style Nos. 21C, 23.
61420 BV	Presser Foot, hinged bottom tilt adjusting screw in shank, spring on left side for raising toe, 1/4 inch margin to right of needle, bottom 1/2 inch wide over-all, for sewing on wash and wear material. Similar to 61920 L except toe longer in front. For Style No. 36.
61420 BY	Presser Foot, hinged bottom, spring on left side for raising toe, 1/8 inch margin to right of needle, bottom 11/32 inch wide over-all, for sewing on wash and wear material. For Style No. 36A.
61920 A	Presser Foot, hinged bottom, spring under shank for raising toe, 1/4 inch margin to right of needle, bottom 17/32 inch wide over-all, for plain seaming and edging operations. For Style Nos. 10, 12A, 15, 28A, 30A.
61920 B	Presser Foot, hinged bottom, spring under shank for raising toe, 3/16 inch margin to right of needle, bottom 7/16 inch wide over-all, for plain seaming and edging operations. For Style Nos. 3, 4C, 8, 26, 27, 28, 34.
61920 L	Presser Foot, hinged bottom, tilt adjusting screw in shank, spring on left side for raising toe, 1/4 inch margin to right of needle, bottom 1/2 inch wide over-all, for sewing on wash and wear material. For Style Nos. 1, 21B, 30, 38.
61920 N	Presser Foot, hinged bottom, tilt adjusting screw in shank, 7/64 inch margin to left and 1/4 inch margin to right of needle, bottom 23/64 inch wide over-all, for attaching pants flies and zippers. For Style No. 17.
61920 R	Presser Foot, hinged bottom, 13/64 inch margin to right of needle, bottom 15/32 inch wide over-all, for plain seaming on light weight material. For Style Nos. 16, 32.
61920 S	Presser Foot, hinged bottom, spring under shank for raising toe, 1/4 inch margin to right of needle, bottom 17/32 inch wide over-all, for plain seaming operations. For Style Nos. 2, 3A, 10A, 12, 21A, 23A.
61927 A	Presser Foot, rigid bottom, 1/16 inch margin to right of needle, bottom 17/64 inch wide over-all. For Style No. 4.

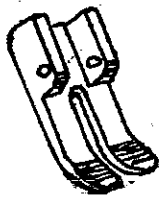

61930 A

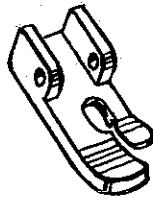

61930 T

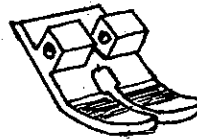

61930 N



61930 M

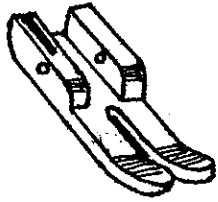

61930 D

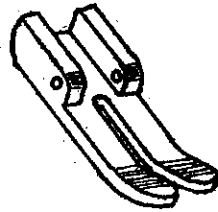

61930 B

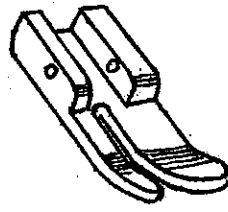

61930 R

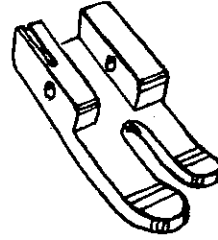

61430 AB

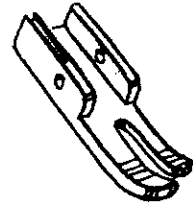

61430 AS

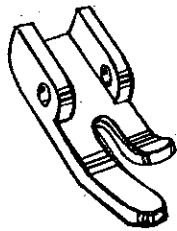

61330 Z

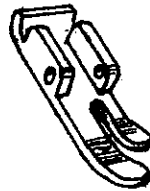

61930 S

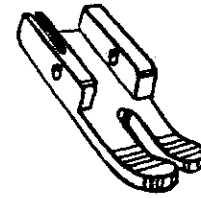

61430 AC



61930 L

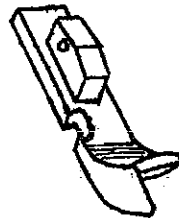

61930 K

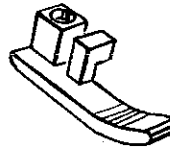

61330 AN

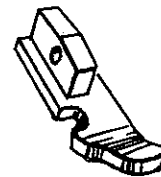

61330 AM

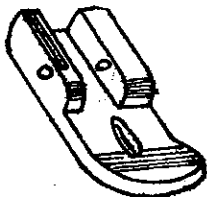

61930 E

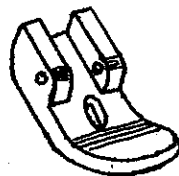

61930 C

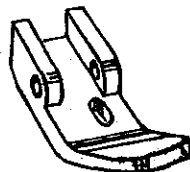

61430 Y

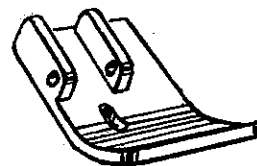

61330 AD

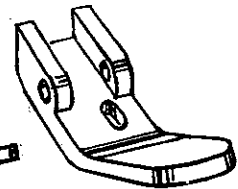

61330 Y

PRESSER FEET BOTTOMS AND YIELDING SECTIONS

<u>Part No.</u>	<u>Description</u>
61330 Y	Bottom, for presser foot No. L391 A
61330 Z	Bottom, for presser foot No. L440 A
61330 AD	Bottom, for presser foot No. 61220 K
61330 AM	Bottom, for presser foot No. L471 A
61330 AN	Yielding Section, for presser foot No. L471 A
61430 Y	Bottom, for presser foot No. 61420 BT
61430 AB	Bottom, for presser foot No. 61420 BU
61430 AC	Bottom, for presser foot No. 61420 BV
61430 AS	Bottom, for presser foot No. 61420 BY
61930 A	Bottom, marked "61920 A", for presser foot No. 61920 A
61930 B	Bottom, marked "61920 B", for presser foot No. 61920 B
61930 C	Bottom, marked "61920 C", for presser foot No. 61920 C
61930 D	Bottom, marked "61920 L", for presser foot No. 61920 L
61930 E	Bottom, for presser foot No. 61920 M
61930 K	Bottom, for presser foot No. 61920 D
61930 L	Yielding Section, for presser foot No. 61920 D
61930 M	Bottom, marked "U", for presser foot No. 61920 G
61930 N	Bottom, marked "V", for presser foot No. 61920 K
61930 R	Bottom, for presser foot No. 61920 N
61930 S	Bottom, for presser foot No. 61920 S
61930 T	Bottom, for presser foot No. 61920 R
*63930	Bottom, marked "63920 C", for presser foot No. 63920 C

* Not shown on picture plate.

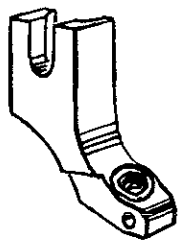

61330 AH

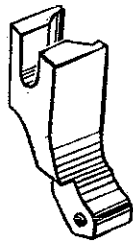

61330 AC

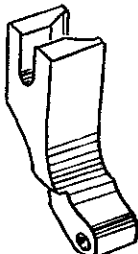

61330

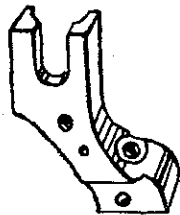

61430 AA

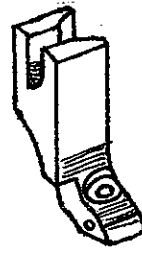

61930 P

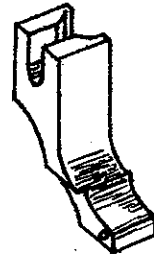

61930 J



61930 AT

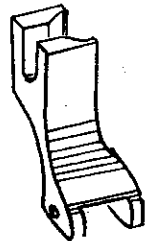

61230 S



61230 A-1/8



51930



61330 B
Specify
Length



61230 AK



61430 P

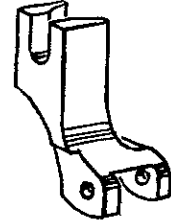

61330 AP



61430 A



61430 B



61430 CB

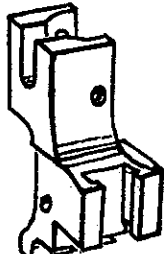

61430 AG

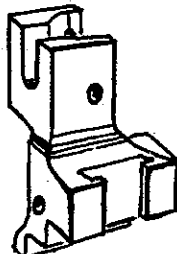

61430 AE



61430 AK



61430 AH



61430 AJ



61430 AP



61430 AN

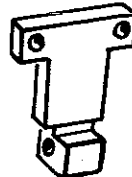

61430 AL



61430 CA



22565 E



22738



73A



22716 A



226



25B



605



22840 A



22565 D



51430 F



73C



HA73 B



28B



61430 BB

MISCELLANEOUS PRESSER FOOT COMPONENT PARTS

<u>Part No.</u>	<u>Description</u>
25 B	Screw, for presser foot No. L347 A
28 B	Screw, for presser foot No. 61920 G
73 A	Screw, for presser feet Nos. 61920 G, 61920 K, 63920 C
HA73 B	Screw, for presser foot No. 61920 K
73 C	Set Screw, for presser feet Nos. 61920 G, 61920 K
226	Spring Screw, for presser feet Nos. 61420 BU, 61420 BV, 61420 BY, 61920 L, 61920 M
605	Screw, for presser feet Nos. 61920 G, 61920 K
22565 D	Hinge Adjusting Screw, for presser feet Nos. L391 A, 61920 C
22565 E	Hinge Adjusting Screw, for presser feet Nos. 61420 BU, 61420 BV, 61920 L, 61920 M, 61920 N
22716 A	Screw, for presser foot No. L460 A
22738	Screw, for presser foot No. L427 A
22840 A	Hinge Adjusting Screw, for presser feet Nos. 61420 H, 61420 BT, 61420 CM, 61920 T, 63920 C
51430 F	Hinge Adjusting Screw Nut, for presser feet Nos. L391 A, 61420 H, 61420 BT, 61420 BU, 61420 BV, 61420 CM, 61920 C, 61920 L, 61920 M, 61920 N, 61920 T, 63920 C
51930	Presser Foot Fitting Spring, for presser feet Nos. L440 A, L471 A, 61220 K, 61920 A, 61920 B, 61920 D, 61920 F, 61920 S
61230 A-1/8	Hemmer Scroll, for presser foot No. L460 A
61230 S	Shank, for presser foot No. 61920 D
61230 AK	Spring, for presser foot No. 61920 U
61330	Shank, for presser feet Nos. L310 A, L440 A, 61420 AP, 61920 A, 61920 F, 61920 U
61330 B-29	Hinge Pin, 29/64 inch long
61330 B-31	Hinge Pin, 31/64 inch long
61330 B-35	Hinge Pin, 35/64 inch long
61330 B-39	Hinge Pin, 39/64 inch long
61330 AC	Shank, for presser feet Nos. 61220 K, 61920 R, 61920 S
61330 AH	Shank, for presser feet Nos. L391 A, 61420 H, 61420 BT, 61420 CM, 61920 C, 63920 C
61330 AP	Shank, for presser foot No. L471 A
61430 A	Chain Cutting Knife, for presser foot No. 63920 C
61430 B	Chain Cutting Knife Guard, for presser foot No. 63920 C
61430 P	Scroll, for presser foot No. L427 A
61430 AA	Shank, for presser feet Nos. 61420 BU, 61420 BV, 61920 L, 61920 M
61430 AE	Shank, for presser foot No. 61920 K
61430 AG	Shank, for presser foot No. 61920 G
61430 AH	Chain Cutter Spring, for presser feet Nos. 61920 G, 61920 K
61430 AJ	Torsion Spring, for presser feet Nos. 61920 G, 61920 K
61430 AK	Spring Guide, for presser feet Nos. 61920 G, 61920 K
61430 AL	Yielding Section, for presser feet Nos. 61920 G, 61920 K
61430 AN	Chain Cutter, marked "G", for presser foot No. 61920 K
61430 AP	Chain Cutter, marked "H", for presser foot No. 61920 G
61430 AT	Shank, for presser foot No. 61420 BY
61430 BB	Spring, for presser feet Nos. 61420 BU, 61420 BV, 61420 BY, 61920 L, 61920 M
61430 CA	Adjustment Slide, for presser feet Nos. 61920 G, 61920 K
61430 CB	Adjusting Pin, for presser feet Nos. 61920 G, 61920 K
61930 J	Shank, for presser foot No. 61920 B
61930 P	Shank, for presser foot No. 61920 N
*61930 U	Shank, for presser foot No. 61920 T

* Not shown on picture plate.

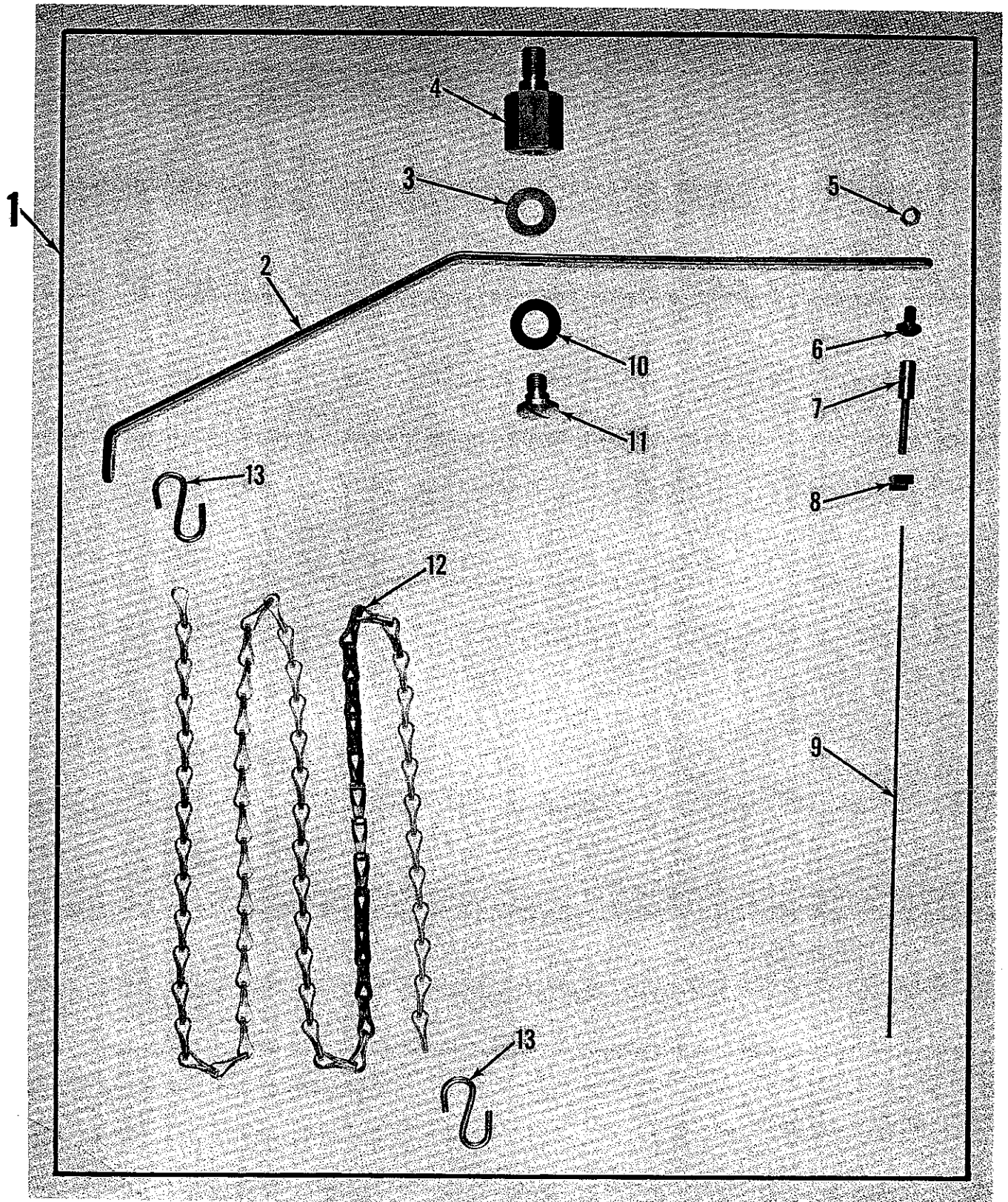

CHAIN CUTTING PRESSURE RELEASE ASSEMBLY

<u>Ref. No.</u>	<u>Part No.</u>	<u>Description</u>	<u>Amt. Req.</u>
1	29480 DY	Chain Cutting Pressure Release Assembly -----	1
2	61430 CC	Chain Cutting Control Lever -----	1
3	652 L-24	Washer, for 22712 N -----	1
4	21233 BY	Adapter Stud -----	1
5	12934 A	Nut, for 22848 A -----	1
6	22848 A	Screw (drilled), for chain cutter control -----	1
7	61430 CB	Adjusting Pin -----	1
8	61430 CA	Adjusting Slide -----	1
9	61430 CD	Chain Cutter Control -----	1
10	23144 B	Spring Washer, for 22712 N -----	1
11	22712 N	Screw -----	1
12	421 D-38	Lifter Lever Chain -----	1
13	660-264	"S" Hook -----	2

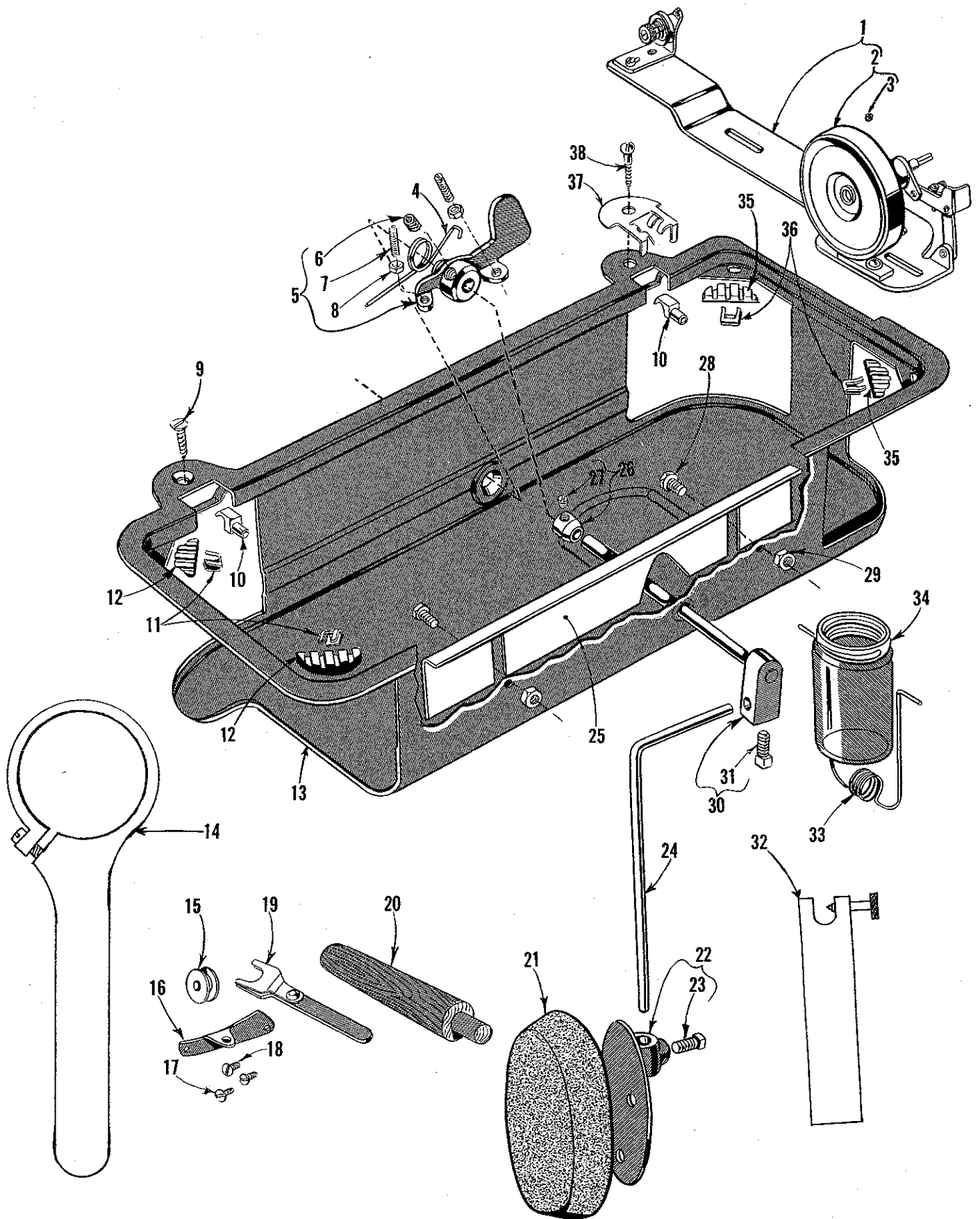

BOBBIN WINDER, KNEE PRESS AND OIL PAN ASSEMBLY

<u>Ref. No.</u>	<u>Part No.</u>	<u>Description</u>	<u>Amt. Req.</u>
1	61477 M	Bobbin Winder, complete -----	1
2	61377 Y	Pulley -----	1
3	22878	Set Screw -----	1
4	21665 E	Knee Press Spring -----	1
5	21665 J	Knee Press Lifter Lever -----	1
6	22509 B	Set Screw -----	1
7	22597 F	Screw -----	2
8	18	Nut -----	2
9	22846 Q-16	Wood Screw, countersunk head -----	1
10	61375	Hinge Stud -----	2
11	63476 A	Isolator Clip, left -----	2
12	63476	Isolator Pad, left -----	2
13	21393 N	Oil Drip Pan -----	1
*14	21388 AV	Bearing Housing Puller -----	1
15	61212	Bobbin -----	1
16	61470 D	Frame Thread Eyelet -----	1
17	22570 A	Screw, for No. 61470 D -----	1
18	22585 A	Screw, for miscellaneous attachments -----	2
*19	21227 BY	Felt Assembly Adapter -----	1
20	61378	Machine Rest Pin, wood -----	1
21	660-168	Knee Press Pad, rubber -----	1
22	21664	Knee Press Plate -----	1
23	69 FD	Screw -----	1
24	21663 D	Knee Lifter Plate Rod -----	1
25	21393 R	Retaining Plate -----	1
26	21661 R	Knee Press Rod Collar -----	1
27	88	Set Screw -----	1
28	21393 S	Bolt -----	2
29	651-16	Nut -----	2
30	21661 N	Knee Press Rod -----	1
31	69 FD	Screw -----	1
*32	21227 BZ	Take-up Eyelet Replacement Tool -----	1
33	21393 L	Oil Drain Jar Clamp Spring -----	1
34	666-166	Oil Drain Jar, glass -----	1
35	63476 B	Isolator Pad, right -----	2
36	63476 C	Isolator Clip, right -----	2
37	63474 A	Bed Positioning Spring -----	1
38	SC331	Wood Screw, round head -----	1

* Not furnished with machine, but may be ordered separately as an extra send and charge item.

NUMERICAL INDEX OF PARTS

<u>Part No.</u>	<u>Page No.</u>	<u>Part No.</u>	<u>Page No.</u>	<u>Part No.</u>	<u>Page No.</u>	<u>Part No.</u>	<u>Page No.</u>
18	49, 71	666-166	71	22570 A	43, 71	39198 D	53
18-768	41	666-173	49	22571 F	43	51430 F	67
20	49	666-181	53	22574 C	47	51773	49
HS24 C	45	666-182	53	22585 A	71	51930	67
25 B	67	666-200	41	22586	51	53678 N	53
27-527 Blk.	41, 53	666-212	41	22597 E	45	56393 G	41
28 B	67	666-214	41	22597 F	71	56393 AA	41
57 WB	45	666-221	41	22644 K	43	60038 G	49
57 WC	45	666-222	45	22653 D	51	61212	53, 71
57 WD	45	666-223	41	22712 G	47	61216	53
CO67 B	45	666-224	41	22712 N	69	61216 N	53
69 FD	71	666-225	41	22716 A	51, 53, 67,	61220 K	61
73 A	67	666-228	43	22716 B	53	61230 A-1/8	67
73 C	47, 51, 67	666-234	41	22716 H	53	61230 S	67
HA73 B	53, 67	666-237	41	22733 D	43	61230 AK	67
88	51, 53, 71	666-238	41	22738	67	61236	51
88 B	49	666-254	41	22742	43	61236 G	51
88 D	51	666-273	41, 47	22743	53	61255	47
89	51, 53	719	51	22757 D	47	61256 G	47
90	45, 51	9937	47	22758 B	47	61273	43
91 A	43	11635 B	41	22766	45	61292 C	43, 45
95	49	12865	53	22768	51	61293 N	41
109	43	12934 A	69	22768 A	47	61320 P	63
222 D	45	12935 A	45, 51	22775	47	61330	67
226	67	14077	49	22775 A	51	61330 B	67
230	47	15037 A	51	22784 E	47	61330 Y	65
L310 A	61	15872 F	47	22784 K	41	61330 Z	65
SC331	71	21227 BY	71	22805	45	61330 AC	67
L347 A	61	21227 BZ	71	22815	43	61330 AD	65
376	43	21233 BY	69	22817 A	47	61330 AH	67
L378 A	57	21388 AV	71	22819	53	61330 AM	65
L379 A	57	21390 BE	45	22839	49	61330 AN	65
L391 A	61	21393 L	71	22840 A	67	61330 AP	67
421 D-38	69	21393 N	71	22845 K	51	61336 U	51
421 H	47	21393 R	71	22846 Q	71	61336 Y	51
L427 A	63	21393 S	71	22848 A	69	61351 C	47, 53
L440 A	63	21629 A	41	22863 B	45	61360 G	51
L460 A	63	21661 N	71	22874 F	47	61375	71
L471 A	61	21661 R	71	22878	71	61377 Y	71
L581 A	57	21663 D	71	22884	47, 51	61378	71
L582 A	57	21664	71	22890 A	47	61392 F	43
605	67	21665 E	71	22894 C	51	61405 AC	59
651-16	71	21665 J	71	22894 E	43, 49	61411 A	53
652-16	43	22504 A	43	22894 J	49, 51	61414 A	43
652 B	47	22504 H	49	22894 R	53	61414 C	53
652 L-24	69	22509 B	71	22894 U	47	61415	53
660-168	71	22516	43	22894 V	47	61415 A	53
660-204	43	22516 B	53	22894 W	47	61420	61
660-219 A	43	22528	43, 51	23144 B	69	61420 H	61
660-219 B	47	22539 P	43	29126 DD	51	61420 R	63
660-219 D	53	22560 G	43, 45	29126 DW	49	61420 AP	61
660-221	41, 53	22562	45	29126 EB	49	61420 BT	61
660-225	51	22562 B	47	29474 S	53	61420 BU	63
660-244	49	22564	41, 45	29475 AM	47	61420 BV	63
660-254 A	43	22564 B	45	29475 AS	43	61420 BY	63
660-254 B	43	22564 E	53	29475 AZ	47	61420 CM	61
660-254 C	47	22564 H	51	29475 BE	45	61421 B	47
660-254 D	47	22565 C	47	29480 CM	59	61421 C	47
660-264	69	22565 D	67	29480 CN	59	61421 D	47
660-269	47	22565 E	67	29480 DY	69	61421 E	47
660-269 A	43, 45	22565 M	53	29480 EN	59	61421 F	47
660-283 A	47	22569 B	41	29480 EP	59	61421 G	47
660-456	41, 47	22569 H	53	29486 L	47	61430 A	67
666-139	49	22570	43, 47	35857 R	53	61430 B	67

NUMERICAL INDEX OF PARTS

<u>Part No.</u>	<u>Page No.</u>	<u>Part No.</u>	<u>Page No.</u>	<u>Part No.</u>	<u>Page No.</u>	<u>Part No.</u>	<u>Page No.</u>
61430 P	67	61468 F	47	61924 H	55	63455	47
61430 Y	65	61470 C	45	61924 J	55	63457 R	47
61430 AA	67	61470 D	43, 71	61924 K	55	63457 R	47
61430 AB	65	61471 A	45	61926	57	63459 B	47
61430 AC	65	61477 M	71	61926 A	57	63466	47
61430 AE	67	61482 H	43	61926 B	57	63470	45
61430 AG	67	61482 J	43	61926 C	57	63470 A	45
61430 AH	67	61490 B	41	61926 D	57	63470 B	43
61430 AJ	67	61490 D	41	61926 E	57	63471	45
61430 AK	67	61492 E	43	61926 F	57	63471 A	45
61430 AL	67	61492 F	43	61926 G	59	63474 A	71
61430 AN	67	61492 G	43	61926 H	57	63476	71
61430 AP	67	61492 H	43, 45	61926 R	57	63476 A	71
61430 AS	65	61492 S	45	61926 T	57	63476 B	71
61430 AT	67	61492 T	45	61927 A	63	63476 C	71
61430 BB	67	61494 D	41	61928	57	63490 B	41
61430 CA	67, 69	61494 E	41	61928 A	57	63492	45
61430 CB	67, 69	61494 F	41	61928 B	57	63492 A	45
61430 CC	69	61494 H	41	61928 C	57	63492 B	45
61430 CD	69	61494 L	41	61928 G	59	63492 C	45
61432 B	41	61494 N	41	61928 H	57	63493	41
		61494 R	43	61928 K	59	63493 J	41, 47
61432 E	41	61496 C	53	61928 M	57	63494	41
61432 H	51	61496 D	53	61928 R	57	63494 A	43
61432 J	51	61496 E	53	61930 A	65	63494 B	43
61434 G	51	61496 F	53	61930 B	65	63494 C	41
61437 A	51	61496 G	53	61930 C	65	63494 D	41
61437 B	51	61496 J	53	61930 D	65	63494 K	41, 45
		61496 K	53	61930 E	65	63494 N	41
61437 L	51	61496 L	53	61930 J	67	63494 P	41
61437 M	51	61496 M	53	61930 K	65	63496 B	53
61437 N	51	61496 N	53	61930 L	65	63902 A	43
61438 B	51	61496 P	41, 53	61930 M	65	63907 A	53
		61496 S	41	61930 N	65	63908	53
		61496 V	53	61930 P	67	63913	53
61440	53	61905 B	55	61930 R	65	63913 A	53
61441	41	61905 C	55	61930 S	65	63914	53
61441 A	41	61905 E	55	61930 T	65	63914 A	43
61444	53	61905 F	55	61930 U	67	63917	47
61449 B	51	61905 G	55	61982 C	43	63920 C	61
61449 S	51	61905 H	55	61982 D	43	63928 E	57
61449 T	45	61905 J	55	61984 C	49	63930	65
61449 U	43	61905 K	55	61985 A	49	63953 A	41
61449 V	43	61905 M	55	61985 B	49	63956	47
61449 X	43	61920 A	63	61985 D	49	63959 A	47
61449 Y	43	61920 B	63	61985 F	49	63970 A	45
61451	47	61920 C	61	61985 G	41	63971 A	45
61451 A	47	61920 D	61	61985 H	41	63982	43
61451 B	47	61920 F	61	61985 J	49	63982 A	45
61451 D	47	61920 G	59	63410	53	63982 F	45
		61920 J	61	63432	53	63984	49
61455	47	61920 K	59	63432 A	51	63984 A	49
61457 B	47	61920 L	63	63432 C	41	63984 B	49
61457 K	41	61920 M	61	63432 E	41	63984 C	41
		61920 N	63	63433 A	51	63984 E	49
61458 G	47	61920 P	61	63434 C	51	63985	49
61458 FA	47	61920 R	63	63435 A	51	63992	45
61460	47	61920 S	63	63439 A	51	63992 A	45
61460 A	51	61920 T	61	63439 AL	51	63993	41
61460 B	47	61920 U	61	63443	51	63993 C	41
61467	47	61924 B	55	63451	45	63993 D	41
61468 B	47	61924 C	55	63452 A	47	63994	41
61468 D	47	61924 E	55	63453	43	63994 B	41
61468 E	47	61924 G	55	63453 N	45		

Helpful, authoritative information on the most efficient types of equipment for making virtually any machine sewed article is available from Union Special's Sales Promotion Department. Among the many interesting, illustrated bulletins that are available without obligation are the following:

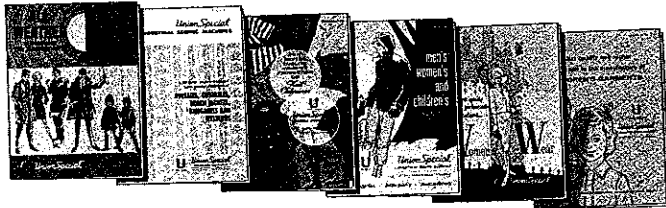

- No. 240, "Men's, Women's, Children's Footwear"
- No. 249, "Rainwear"
- No. 250, "Men's Dress Shirts"
- No. 251, "Service Shirts and Pants"
- No. 252, "Men's Shorts and Pajamas"
- No. 253, "Overalls, Coveralls, and Dungarees"
- No. 254, "Men's Knit Underwear"
- No. 256, "Knit Outerwear"
- No. 259, "Men's Sports Shirts"
- No. 260, "Work Gloves"
- No. 262, "Cotton, Burlap, Jute, and Multiwall Paper Bags"
- No. 263, "Men's Clothing"
- No. 264, "Men's Women's, Children's Jackets"
- No. 265, "Women's Wear"
- No. 266, "Women's Wear And High Fashion"
- No. 267, "Corsets, Girdles, Brassieres"
- No. 268, "Children's Wear"
- No. 269, "Mattresses, Slip Covers, Furniture Upholstery"
- No. 271, "Awnings, Canopies, Tents, Tarps"
- No. 273, "Curtains & Drapes"
- No. 610, "Klipp-it"
- No. 710, "MCS ForMation Unit"
- No. 730, "MCS Automatic Dual Underfront Shirt Hemmer"
- No. 740, "MCS Automatic Rib-Knit Cuff Machine"
- No. 750, "Fusing Presses"
- No. 1100, "Lewis Blindstitch, Chainstitch, Lockstitch, Machines"
- No. 1105, "Button Sewers—Ticket Tackers"
"Columbia Blindstitch, Saddle Stitch, and Tie Closing Machines"
- No. 1500, "Alteration Department Machines"



**UNION SPECIAL
CORPORATION**

**HERE ARE HELPFUL
BULLETINS and CATALOGS
TO HELP YOU SOLVE
SEWING PROBLEMS**



Union Special Wants to Help You Cut Sewing Machine Maintenance Costs

Union Special is offering two practical systems to help pinpoint and reduce your sewing machine maintenance costs: a record keeping system to help spot machines requiring abnormally high maintenance, and a parts inventory system to speed routine repairs.

Machine Maintenance Records

Repair-prone machines or inexperienced competent operators can eat up your maintenance dollars in short order. To help spot these problems, Union Special suggests two variations of a simple maintenance record keeping system using cards provided by Union Special.

The first system utilizes a "Machine Maintenance Record" card (Form 237) for each sewing machine in a plant. When a repair is required, the card is pulled from the file and the repair date, parts used, and their cost are entered in the spaces provided and the card is refiled.

The second system is normally used when more detailed information on repair costs is desired. Two record cards are used: a "Repair Request Card" (Form 234), and a "Machine Repair Record" (Form 233). When a machine requires service, the forelady or foreman fills out the top of a "Repair Request Card" and gives it to a mechanic. He fills in the time the repair work is started, the parts used and their cost,

and the completion time. This data is then transferred to the permanent "Machine Repair Record" kept in the office.

Whichever system is used, management now has an invaluable tool to reduce needless maintenance costs.

Repair Part Inventories

While record keeping tells management which machines require abnormally high maintenance, it does little to help reduce the downtime caused by routine repairs. To alleviate this situation, Union Special recommends that manufacturers establish a formal parts inventory system for each type of sewing machine they operate.

Excessive machine downtime and wasted hours by mechanics can be eliminated with an orderly in-plant inventory of the most commonly needed parts. There is no longer a need to cannibalize other machines for spare parts. Long waits for deliveries are avoided and machine downtime is kept to a minimum. The cost of a parts inventory is small when the overall savings are considered.

For free sample copies of the machine record cards and spare part inventory lists for a variety of the most popular machines, contact your local Union Special Representative or write direct to Union Special.

U Union Special

Style 63900 C - D

Suggested Minimum Spare Parts List*

Part Number	Description	Minimum Quantity Per 5 Machines	Part Number	Description	Minimum Quantity Per 5 Machines
61920 M	Presser foot (depending on operation)	1	29474 S	Rotating hook assembly	1
22775	Screw for presser foot	1	63913 A	Bobbin case assembly	1
61926 D	Feed dog (depending on operation)	1	61411 A	Hook thread retainer	1
22768	Screw for feed dog	2	22716 H	Screw for thread retainer	3
61928 B-053	Throat plate (depending on operation)	1	63410	Hook thread deflector	1
376	Screw for throat plate	2	22716 A	Screw for thread deflector	4
180 GX5	Needles (specify size)	100	61212	Bobbin	2
63453	Take up spring	4	63913	Bobbin case	1
61492	Tension post eyelet	1	61415	Bobbin case latch	1
61492 G	Tension release pin	1	22564 E	Screw for latch	4
22528	Screw for feed dog holder	1	61415 A	Bobbin case latch lever	1
222 D	Screw for thread eyelet	2	61216 N	Bobbin case latch spring	2
22768 A	Screw for needle	2	22716 B	Tension regulating screw	2
22562 B	Screw for needle bar connection	1	61414 C	Bobbin case tension spring	1
22528	Screw for bobbin case finger	2	29486 L	Take up lever	1
22775 A	Screw for feed dog height	2	63414	Bobbin case holder	1
88 D	Screw feed holder support	2	29484	Screw assortment	1

*The parts and quantities listed above are intended to assist you in setting up the initial inventory of spare parts. An efficient inventory can only be established according to actual usage. The nature of the sewing operation will determine actual usage.

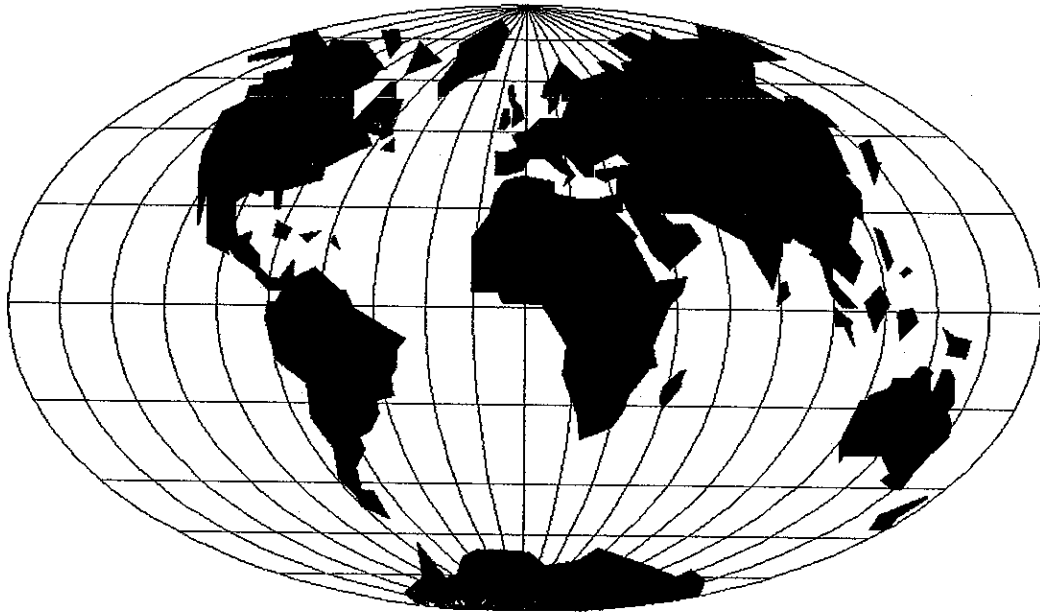

WORLDWIDE SALES AND SERVICE

Union Special Corporation maintains sales and service facilities throughout the world. These offices will aid you in the selection of the right sewing equipment for your particular operation. Union Special Corporation representatives and service technicians are factory trained and are able to serve your needs promptly and efficiently. Whatever your location, there is a qualified representative to serve you.

Brussels, Belgium
Charlotte, N.C.
El Paso, TX
Hong Kong, China
Huntley, IL
Leicester, England
Lille, France
Miami, FL
Milan, Italy
Mögingen, Germany
Montreal, Quebec
Osaka, Japan
Santa Fe Springs, CA

Other Representatives throughout
all parts of the world.



Union Special
INDUSTRIAL SEWING EQUIPMENT