

SINGER
116W1

PRICE LIST

OF

PARTS



MACHINE

No. 116 w 1

THE SINGER MANUFACTURING COMPANY

INDEX

	PAGE
ACCESSORIES.....	17
BOBBIN WINDER.....	17
FEED DRIVING CAM, FOR SHORT STITCH.....	22
MACHINE No. 116 w 1.....	7
NUMERICAL LIST OF PARTS.....	23
OBSOLETE PARTS.....	22
STARTING TREADLE PARTS.....	19
THREAD UNWINDER.....	18
UNDER DRIVER TRANSMITTER.....	20

INSTRUCTIONS FOR ORDERING

In ordering from this list, use **ONLY** the **PART** number in the **FIRST** column.

The number stamped on a Sewing Machine Part is the number of the Single Part only, except when the part includes Set Screws, Clamping Screws, Studs and Rollers Spun on, Small Wires riveted, or Parts soldered together, etc., which it is necessary to furnish in combination.

Every combination of parts sent out has its specific number which, although not stamped on Parts (except in above cases) must be used when ordering the combination.

Each number always indicates the **SAME PART** in whatever list it appears, or for whatever Machine.

The letters after some of the numbers indicate the style of finish only, as follows:

- A. Hardened, Polished and Plated.
- B. Polished and Plated.
- C. Hardened only.
- D. Polished only.
- E. Soft, not polished.
- F. Hardened and Polished.
- H. Blued.

These letters **MUST BE USED** when they appear in the list and **AFTER** the number, as in the list.

In this series

200001 to 201500 are Screw Numbers.

201501 to 201800 are Nut Numbers.

201801 to 202000 are Roller Numbers.

202001 and upward are numbers of Machine Parts.

The figures in the second column refer only to the plate in which the illustration of the part is shown and are **NOT TO BE USED** in ordering.

Two or more numbers over a cut indicate that the difference between such parts is not visible in an illustration.

Parts marked with an asterisk (*) are furnished only when repairs are made at the factory.

LIST OF PARTS COMPLETE

FOR

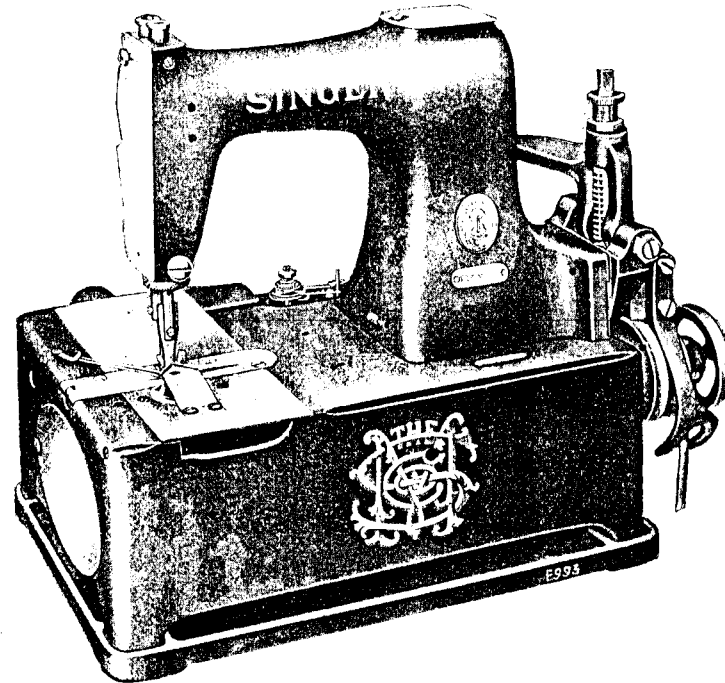

MACHINE No. 116 w 1

Makes an Overcast Blind Stitch Over the Buttonhole Cord, Finishing the Cord or Gimp that Extends from Buttonhole to Buttonhole on Button Flies of Shoes.
Has Stop Motion.

No.	Plate	Name	Each
*222801	—	Arm with 202135	\$ —
222803	12601	" Cap	35
200278H	12602	" " Screw	05
202248H	12602	" " " Washer	05
204235	12602	" Position Pin (2)	02
200963E	12602	" Screw (3)	06
222804	12601	Balance Wheel with two 200317c	75
200347c	12321	" " Set Screw	03
*222805	—	Bed with 202135	—
203184	12621	" Clamp	50
200262H	12613	" " Hinge Screw	10

Parts for Machine No. 116w1

No.	Plate	Name	Each
200729B	12621	Bed Clamp Thumb Screw	\$ 12
202629	12621	" " Washer	10
222938	12621	" " "	10
222806	12601	" End Cover Plate	60
200203D	12602	" " " " Hinge Screw	05
202248H	12602	" " " " " Washer	05
202135	12602	" " " " Stop Pin	01
222807	12601	" Plate (back)	1 60
222945	12610	" " (front)	2 25
222811	12602	" " " Thrum Guide	30
200177D	12602	" " " " Screw (2)	04
222810	12602	" " Latch Plunger (2)	10
222953	12602	" " " " Spring (2)	03
200357E	12602	" " " " " Stop Screw (2)	03
204178	12603	Bobbin	05
222916	12603	" Case with 204181	60
204181	—	" " Position Finger	01
204182	12603	" " Tension Spring	10
200598F	12603	" " " " Adjusting Screw	02
200592F	12603	Bobbin Case Tension Spring Screw	02
222917	12603	Bobbin Case complete, Nos. 200592F, 200598F, 204182 and 222916	75
204251	12604	Depressing Bar (hollow) with 200074F	80
222813	12619	" " Driving Connection with 202277 and two 200027E	1 50
222908	12602	Depressing Bar Driving Connection Crank with 200038c and 200438c	25
200973c	12602	Depressing Bar Driving Connection Crank Hinge Screw	25
201515E	12602	Depressing Bar Driving Connection Crank Hinge Screw Nut	03
200038c	12602	Depressing Bar Driving Connection Crank Pinch Screw	05
200438c	12621	Depressing Bar Driving Connection Crank Position Screw	06
202277	—	Depressing Bar Driving Connection Oil Packing (wick)	01
200027E	12602	Depressing Bar Driving Connection Screw	04
222940	12621	Depressing Bar Driving Eccentric with 1299c and 200378c	2 50
1299c	12602	Depressing Bar Driving Eccentric Position Screw	03
200378c	12602	Depressing Bar Driving Eccentric Set Screw	02
222814	12604	Depressing Bar Driving Shaft	50
222904	—	" " " " 222814 with 40025 and 222817	1 25

Parts for Machine No. 116w1

No.	Plate	Name	Each
222815	12602	Depressing Bar Driving Shaft Bushing (back)	\$ 30
200335c	12602	Depressing Bar Driving Shaft Bushing (back) Set Screw	04
222816	12605	Depressing Bar Driving Shaft Bushing (front)	35
200352c	12613	Depressing Bar Driving Shaft Bushing (front) Set Screw	03
222817	12605	Depressing Bar Driving Shaft Crank with 202277	75
202277	—	Depressing Bar Driving Shaft Crank Oil Packing (wick)	01
40025	12605	Depressing Bar Driving Shaft Crank Position Pin	01
222818	12605	Depressing Bar Lifting Collar with 200050c	45
200050c	12605	Depressing Bar Lifting Collar Pinch Screw	03
233518	12621	Depressing Bar Lifting Sleeve with 202277	1 00
222820	—	Depressing Bar Lifting Sleeve Friction Washer (rawhide) (2)	05
233519	12621	Depressing Bar Lifting Sleeve Link	60
202277	—	" " " " Oil Packing (wick)	01
222822	12605	Depressing Bar Position Guide with 200042F	1 00
200042F	12605	Depressing Bar Position Guide Pinch Screw	05
201169c	12605	Depressing Bar Screw Bushing (lower)	75
201170c	12605	" " " " " "	12
202355	12605	Depressing Bar Screw Bushing (lower) Thumb Set Screw Packing (brass)	01
201067B	12606	Depressing Bar Screw Bushing (upper)	20
200363c	12605	" " " " " " Set Screw	03
202355	12605	Depressing Bar Screw Bushing (upper) Set Screw Packing (brass)	01
222937	12621	Depressing Bar Spring	10
222939	12605	" Blade	30
200074F	12605	" " Screw	03
222825	12619	Driving Shaft with 200382c, 200386c, 200842b, 201142e and three 202423	2 00
222826	12606	Driving Shaft Bushing (back) with 202299	35
202299	—	Driving Shaft Bushing (back) Oil Packing (wick)	01
200363c	12605	Driving Shaft Bushing (back) Position Screw Check Screw	03

Parts for Machine No. 116w1

No.	Plate	Name	Each
222827	12606	Driving Shaft Bushing (front)	30
200363c	12605	" " " " Position	
		Screw Check Screw	03
200019E	12606	Driving Shaft Bushing Clamp Screw (4)	06
200441c	12606	" " " " Position Screw	
		(2)	04
202423	—	Driving Shaft Oil Packing (wick) (3)	01
201142E	12606	" " " " Stop Screw	02
200382c	12606	" " " " " "	02
200386c	12606	" " " " " "	02
200842b	12606	" " " " " "	10
222830	12604	Face Plate	60
202135	12602	" " Position Pin	01
200462B	12606	" " Thumb Screw	10
222831	—	Feed Bar with 222838	1 00
222946	12601	" " 222831 with 201060b, 201827 and 203060	1 25
201069c	12606	Feed Bar Hinge Screw Stud	40
201522E	12606	" " " " Nut	03
204443	12606	" " Spring	05
203060	12606	" " Hook	03
222832	12607	" Dog	1 20
201063E	12606	" " Screw (2)	02
222942	12604	" Driving Cam with 1299c and 200378c	1 25
1299c	12602	Feed Driving Cam Position Screw	03
201827	12606	" " Roller	12
222834	—	" " Stud	15
200378c	12602	" " Set Screw	02
222835	12619	" Rock Shaft	1 75
202305c	12606	" " Center (2)	06
200346c	12606	" " " " Set Screw (2)	03
222836	12604	Feed Driving Rock Shaft Crank with 200019E and 222834	1 75
200019E	12606	Feed Driving Rock Shaft Crank Pinch Screw	06
222837	12606	Feed Lifting Cam with 200442c and three 200386c	1 00
200442c	12606	Feed Lifting Cam Position Screw	04
201827	12606	" " Roller	12
201060b	12606	" " Cap Screw	04
222838	—	" " Stud	15
200386c	12606	" " Set Screw	02
222839	12603	Hook (sewing) with 204217	1 60
204217	—	" Bobbin Case Stud	10
222840	12609	" Bracket with 200379c, two 200380c and three 204234	80
222841	—	Hook Bracket 222840 with 204226c, 222849, two each 201068b and 222850	1 50

Parts for Machine No. 116w1

No.	Plate	Name	Each
200380c	12381	Hook Bracket Adjusting Screw (back)	02
200379c	12603	" " " (front)	02
222842	12610	" " Base with 200386c	2 50
222843	—	" " " 222842 with 200576b, 201061H, 222844, 222872 and 222873	4 00
222844	12603	Hook Bracket Base Plate	20
200576H	12603	" " " " Screw (left)	04
201061H	12603	" " " " (right)	04
205508	12603	" " Position Pin (2)	02
200029c	12603	" " Screw (2)	05
201064c	12603	" " Screw (back)	03
200085c	12603	" " " (front)	03
222845	—	Hook Bracket complete, Nos. 222839 and 222841	3 25
222846	12608	Hook Driver with 204242 and 204243	1 50
222847	12608	" " Bevel Gear with two 200378c	75
200378c	12602	Hook Driver Bevel Gear Set Screw	02
204243	12603	" " Pin	01
204242	12603	" " Washer	01
222848	12608	" Driving Bevel Gear Shaft	1 75
208246	—	" " Crank (left or right)	40
222905	12603	" " (left) 208246 with 200348c, 200382c, 200662c, 201012c and 201530e	60
222929	—	Hook Driving Crank (right) 208246 with 200348c, 200382c, 200439c, 200662c and 201530e	60
204241	12603	Hook Driving Crank Link	25
200662c	12603	" " " " Hinge Screw	07
201530E	12603	" " " " " " Nut	04
201012c	12606	Hook Driving Crank Position Screw (left)	03
200439c	12606	Hook Driving Crank Position Screw (right)	05
200348c	12606	Hook Driving Crank Set Screw	03
200382c	12606	" " " " " "	02
204226c	12609	" Race .156 in. thick, 1.906 in. diam.	40
222849	12609	" " Cap (steel)	15
222850	12606	" " Spring	10
201068b	12606	" " " " Screw	06
204234	12606	" " Position Pin	01
222851	12608	Needle Bar	55
222852	12608	" " Connecting Link	80
200101b	12608	" " " " Stop Screw	04
222853	12608	" " " " Stud with 200072c	50
200072c	12608	" " " " Pinch Screw	03
222854	12610	" " Driving Connection with two 200046c	1 25

No.	Plate	Name	Each
222855	12608	Needle Bar Driving Connection Crank with 200025c and 202277	\$1 00
202277	—	Needle Bar Driving Connection Crank Oil Packing (wick)	01
200025c	12608	Needle Bar Driving Connection Crank Pinch Screw	05
200046c	12611	Needle Bar Driving Connection Screw	03
222856	12611	" " " Crank	75
40025	12605	" " " " Position Pin.	01
222857	12610	" " " " Shaft	50
222858	—	" " " " 222857 with 40025, 200101b, 222852, 222853 and 222856	2 60
222859	12611	Needle Bar Driving Shaft Bushing (back)	30
222860	12611	Needle Bar Driving Shaft Bushing (front)	35
200347c	12321	Needle Bar Driving Shaft Bushing Set Screw (2)	03
222861	12610	Needle Bar Frame	1 00
222862	12611	" " " " Hinge Stud (eccentric)	60
200444c	—	Needle Bar Frame Hinge Stud Position Screw	04
200363c	12605	Needle Bar Frame Hinge Stud Set Screw	03
222863	12610	" " " " Pitman	75
222864	—	" " " " 222863 with 222865, 222919 and two 200098F	1 60
222865	12611	Needle Bar Frame Pitman Connection (adjustable)	75
222919	12611	Needle Bar Frame Pitman Connection Clamp Washer	05
201059c	12611	Needle Bar Frame Pitman Connection Hinge Screw	08
200098F	—	Needle Bar Frame Pitman Connection Screw	03
200235c	12611	Needle Bar Frame Pitman Hinge Screw	10
*222866	—	" " " " Support with 200363c and 203060	—
205510	12611	Needle Bar Frame Support Position Pin (2)	03
200019E	12606	Needle Bar Frame Support Screw (2)	06
222918	12610	" " " " Guard	30
200030H	12611	" " " " Screw	05
222867	12611	" " " " Clamp with 201092F	1 50
201092F	12611	" " " " Pinch Screw	08
200076D	12611	" " " " Screw	03
222868	12612	" " " " Guard	1 00
201177D	12611	" " " " Screw	02
222930	12611	" " " " Stop	30

No.	Plate	Name	Each
222869	12612	Needle Support	\$1 00
200334c	12611	" " " " Adjusting Screw	04
200351c	12611	" " " " " Set Screw	03
222870	12612	" " " " Cam with 200378c and 200403c	1 00
200378c	12602	Needle Support Cam Set Screw	02
200403c	12612	" " " " " " "	03
200651E	12612	" " " " Hinge Screw	05
222872	12612	" " " " Lifting Bell Crank with 200334c, 200351c and 201882	1 00
222873	12612	Needle Support Lifting Bell Crank Hinge Pin	15
200386c	12606	Needle Support Lifting Bell Crank Hinge Pin Set Screw	02
201881	—	Needle Support Lifting Bell Crank Roller	15
201882	—	" " " " " " " " " 201881 with 200274D	20
200274D	12612	Needle Support Lifting Bell Crank Roller Screw	06
222874	12612	Needle Support Spring	05
222875	12612	" " " " Vibrating Cam with 1285c and 200347c	1 50
204918	12612	Needle Vibrating Cam Follower	35
1285c	12612	" " " " Position Screw	04
200347c	12321	" " " " " Set Screw	03
222876	12610	" " " " Lever	75
200224c	12612	" " " " " Hinge Screw	12
204251	12604	Presser Bar (hollow) with 200074F	80
202336	12613	" " " " Bushing	35
200352c	12613	" " " " " Set Screw	03
202339	12613	" " " " Lifter	25
200653c	12613	" " " " " Hinge Screw	06
204253	12613	" " " " Lifting Bracket with 200086c	40
200086c	12613	" " " " " " Pinch Screw	03
213667	12613	" " " " " " Position Guide with 200075D and 203551	40
200075D	12613	Presser Bar Lifting Bracket Position Guide Screw	02
203551	12613	Presser Bar Lifting Bracket Position Guide Screw Bushing	05
200362c	12613	Presser Bar Lifting Bracket Position Guide Set Screw	03
204258	12613	Presser Bar Spring	10
200494B	12613	" " " " Thumb Screw (pressure regulating)	25
200363c	12605	Presser Bar Thumb Screw Set Screw	03
202355	12605	" " " " " " " " " Packing (brass)	01
222928	12613	Presser Foot	2 00
222878	12619	" " " " Lifting Lever	25

Parts for Machine No. 116w1

No.	Plate	Name	Each
222879	12613	Presser Foot Lifting Lever Connecting Link	\$ 50
201062F	12613	Presser Foot Lifting Lever Connecting Link Hinge Screw (2)	10
201533E	12613	Presser Foot Lifting Lever Connecting Link Hinge Screw Nut (upper)	03
200262H	12613	Presser Foot Lifting Lever Hinge Screw	10
200074F	12605	" " Screw	03
23497	12614	Pulley (loose)	1 75
40024	12614	" (tight)	2 50
40025	12605	" " Pin	01
222880	12614	Starting Lever	3 50
222881	—	" " 222880 with 913c, 1638E, 2022, 21650, 21651, 222889 and 222890	5 25
222882	12614	Starting Lever Belt Shifter	75
200019E	12606	" " " " Screw (2)	06
222883	12614	" " " Bracket	1 00
204235	12602	" " " Position Pin	02
200019E	12606	" " " " Screw (2)	06
222884	12614	" " " Rod	15
222885	12615	" " " " Connecting Block	50
222886	12615	" " " " " Link	60
201062F	12613	" " " " " Hinge Screw (2)	10
222887	12615	Starting Lever Rod Position Bracket	30
200035D	12615	" " " " " " Screw (2)	05
222888	12615	Starting Lever Rod Spring	10
227227	12615	" " " " " Collar with 200113F	15
200113F	12615	Starting Lever Rod Spring Collar Set Screw	03
564c	12615	Starting Lever Screw Center (2)	12
1508c	12615	" " " " " Nut (2)	06
39628	12615	Stop Cam with 39629	1 50
222889	12616	" " " " " Interlocking Rod	50
222890	12615	" " " " " " Guide	75
2022	—	" " " " " " Position Pin	01
21650	—	Stop Cam Interlocking Rod Guide Washer (rawhide)	02 1/2
21651	12615	Stop Cam Interlocking Rod Spring	10
913c	12617	" " " " " " Regulating Thumb Screw	40
1638E	12617	Stop Cam Interlocking Rod Spring Regulating Thumb Screw Nut	12
39629	—	Stop Cam Pin	15
23515	12617	" " " Spring (long)	08
23516	12617	" " " " (short)	05
222892	12616	" " " " Cover with two 9780	50

Parts for Machine No. 116w1

No.	Plate	Name	Each
9780	12617	Stop Cam Spring Cover Position Pin	\$ 01
997E	12617	" " " " " Screw (2)	05
39637	12617	" " " " " Stop Block	30
1349c	12617	" " " " " " Screw	04
39638	12617	" " " " " " Block	30
457c	12617	" " " " " " Set Screw	02
222893	12616	Take-up Cam with 454c, 1285c and 200335c	1 50
1285c	12612	" " " " " Position Screw	04
454c	—	" " " " " " Check Screw	02
200335c	12602	" " " " " Set Screw	04
222959	—	" " " " " Lever with 201816 and 222103	1 10
201248c	—	" " " " " Hinge Screw	30
201623c	12617	" " " " " " Nut	15
201816	12617	" " " " " Roller	12
222103	—	" " " " " Cap	08
222932	12617	" " " " " Thread Retaining Spring	10
201132D	12617	" " " " " " " Screw	05
222960	12616	Take-up Lever complete, Nos. 201248c, 222932, 222959 and two 201132D	1 55
202402	12617	Tension Disc (back)	05
202403	12617	" " (front)	10
202407	12617	" " " Spring	05
200625B	12617	" " " Stud with 204925	15
200326c	12617	" " " Set Screw	05
204925	12617	" " " Washer	01
201572B	12617	" " " Thumb Nut	04
222895	12618	" " " Washer	15
222906	12618	Tension complete, Nos. 200625B, 201572B, 202402, 202403, 202407, 222895 and 222907	60
222907	12618	Thread Controller Spring (Per 100 \$3.50)	05
202411	12618	" " " " " Stop	10
200132E	12618	" " " " " " Screw	02
222933	12618	" " " " " Cutter	15
200139D	—	" " " " " " Screw	02
222896	12618	" " " " " Guide	05
222897	12618	" " " " " " "	02
222898	12618	" " " " " " "	02
222899	12618	" " " " " Leader Bracket	30
200576H	12603	" " " " " " " Screw	04
202098	12618	" " " " " Roller	05
222900	12618	" " " " " " Guard	10
200581H	12618	" " " " " " " Screw	02
202084	12618	" " " " " " " Washer	01
201065H	12618	" " " " " " " Screw	03
222901	12618	Thread Leader complete, Nos. 200581H, 201065H, 202084, 202098, 222899 and 222900	50
210958	—	Thread Retainer Collar	08

No.	Plate	Name	Each
210993	12618	Thread Retainer Sleeve	\$ 05
210992	12618	" " Spring	01
210957	—	" " Stud	12
200330c	12618	" " " Set Screw	04
222954	12607	Throat Plate	6 50
222955	—	" " 222954 with 200651E, 201177D, 222868, 222869 and 222874	8 50
200565E	12618	Throat Plate Screw (2)	05

ACCESSORIES

No.	Plate	Name	Each
204178	12603	Bobbin (5)	\$ 05
225497	10776	" Case Screw Driver	10
222952	12605	Depressing Blade	30
116 x 1	—	Needles, six, size 1	Per doz.
222909	—	Bed Cushion (felt)	05
222920	—	Drip Pan with four each 222909 and wood screws 1 in. No. 13 F. H. B.	1 25
36578	10776	Oiler with 36579	10
36579	10776	" Spout, 3 in. long	06
225498	10776	Screw Driver, 7½ in. long	15
222956	—	Thread Unwinder Spool Weight	20
222958	—	" " " " 222956 with 200011E, 202483, 222957 and two 202482	35
202482	12381	Thread Unwinder Spool Weight Tension Disc (lower or upper)	02
200011E	12381	Thread Unwinder Spool Weight Tension Disc Screw	05
202483	12381	Thread Unwinder Spool Weight Tension Disc Spring (brass)	01
222957	—	Thread Unwinder Spool Weight Thread Guide	05
225554	10776	Wrench (steel)	10
202511	12616	"	06
25086	12616	"	10

BOBBIN WINDER

Swing Automatic Left Hand.

227149	11157	Bobbin Winder Base (left)	15
227209	11157	" " Frame (left) with 200125c	15
227152	12381	Bobbin Winder Frame Hinge Pin	02
227153	12381	" " " Spring	02
200125c	12381	" " " Stop Screw	02
227154	11157	" " Pulley (large) with 200380c	20
200380c	12381	" " " Set Screw	02
227156	12381	" " Spindle	15
227157	11157	" " Stop Latch (left)	10
227159	12381	" " " Hinge Pin	02
227160	12381	" " " " Spring	01

No.	Plate	Name	Each
227048	11157	Bobbin Winder complete (large pulley), Nos. 227149, 227152 to 227154, 227156, 227157, 227159, 227160, 227209 and two round head wood screws 1½ in. No. 14 .	\$ 85
202480	11157	Bobbin Winder Spool Holder Base with 200355H and 202484	15
202481	11157	Bobbin Winder Spool Holder Base Spool Pin	05
202482	12381	Bobbin Winder Spool Holder Tension Disc (lower or upper)	02
200011E	12381	Bobbin Winder Spool Holder Tension Disc Screw	05
200355H	12381	Bobbin Winder Spool Holder Tension Disc Screw Set Screw	03
202483	12381	Bobbin Winder Spool Holder Tension Disc Spring (brass)	01
202484	12381	Bobbin Winder Spool Holder Tension Disc Thread Guide	01
202485	11157	Bobbin Winder Spool Holder complete, Nos. 200011E, 202480, 202481, 202483, two 202482 and one wood screw, 1 in. No. 13H	35
227514	—	Bobbin Winder and Spool Holder complete, Nos. 202485 and 227048	1 20

THREAD UNWINDER

202486	—	Spool Pin	03
202487	—	" Rest	25
202488	10278	" " 202487 with 200363c, 200383c and two 202486	35
202489	10278	Spool Rest Rod	05
200383c	12618	" " " Set Screw	02
200383c	12618	" " Set Screw	02
202490	10278	" Stand with 200383c	20
202491	10278	" Washer (steel)	02
202492	10278	" Weight with 202493	25
202493	—	" " Center with 202793 and 203163	10
203163	—	Spool Weight Center Bushing	03
202793	10278	" " Thread Guide	05
202794	10278	Thread Eyelet Rod	15
200363c	12605	" " " Set Screw	03
202795	10278	Thread Unwinder complete, Nos. 202488 to 202490, 202794, two each 202491, 202492 and three wood screws, 1 in. No. 13	1 25

STARTING TREADLE

No.	Plate	Name	Each
222911	12616	Starting Lever Operating Lever	\$ 75
222912	12616	" " " " Bracket with two wood screws 1 in. No. 13	30
222913	—	Starting Lever Operating Lever Bracket 222912 with 200973H, 201515E and 222911	1 35
200973H	12602	Starting Lever Operating Lever Hinge Screw	25
201515E	12602	Starting Lever Operating Lever Hinge Screw Nut	03
222914	12616	Starting Lever Operating Lever Rod 4½ in. long. with 202456	06
*202456	—	Starting Lever Operating Lever Rod Cap or Oil Guard	—
222921	12618	Starting Lever Operating Lever Rod Stop Collar with 200530c	25
200530c	12321	Starting Lever Operating Lever Rod Stop Collar Set Screw	05
227976	12619	Starting Treadle with 200540b	45
227977	12619	" " 227976 with 227978	60
227978	12619	" " Adjustable Connecting Slide	15
200540b	12613	Starting Treadle Adjustable Connecting Slide Set Screw	10
202468	12619	Starting Treadle Pitman Rod (lower)	05
204698	12619	" " " " (upper) with 202302	08
204126	12321	Starting Treadle Pitman Rod Clamp with two 200530c	20
200530c	12321	Starting Treadle Pitman Rod Clamp Set Screw	05
202302	12321	Starting Treadle Pitman Rod Cotter Pin	01
222934	12619	" " Stand with five wood screws 1 in. No. 13	65
222935	—	Starting Treadle Pitman complete, Nos. 202468, 204698 and two 204126	55
222927	—	Starting Treadle and Pitman complete, Nos. 222926 and 222935	1 80
222926	—	Starting Treadle and Stand complete, Nos. 222934 and 227977	1 25

UNDER DRIVER TRANSMITTER

No.	Plate	Name	Each
204099	10416	Cone Pulley (grooved), three speed, 4, 4½ and 5 in. belt diam., with 227194 and 227553	\$1 00
25362	12321	Cone Pulley Ball, size ¾ inch	02
204100	12321	" " " Bearing Cup	12
204101	12321	" " " Cap	02
204102	12321	" " " Retaining Spring	05
227553	12322	Cone Pulley Ball Cup complete, Nos. 204100 to 204102 and thirteen 25362 ..	45
227194	—	Cone Pulley Counterbalance	05
215591	12620	Driving Pulley, 6 in. diam., with 204104 and 204105	60
204104	10416	Driving Pulley Friction Ring (leather)..	05
204105	12321	" " " " Stop Pin ..	01
227742	12620	" " Shaft (hollow) with 204109, 204110, 204112 and two 204111	55
204106	10416	Driving Pulley Shaft 227742 with 204107, 204108 and eleven 25303	1 00
25303	12321	Driving Pulley Shaft Ball, size ¼ inch ...	03
204107	12321	" " " " Cup	10
204108	12321	" " " " Cap	02
204109	—	" " " Oil Plug	01
204110	—	" " " Oiling Leather	02
204111	—	" " " " " Pin (leather)	01
204112	12322	Driving Pulley Shaft Oiling Wick	01
200524c	12321	" " " Set Screw	06
204113	12321	" " " Thimble	10
204114	10416	Frame	80
204115	10416	" Dress Guard with 200524c	15
200524c	12321	" " " Set Screw	06
202499	12620	Lever Brake with 200524c, 204122 and two 200363c	35
204122	12322	Lever Brake Leather	05
200363c	12605	" " " Set Screw	03
200524c	12321	" " Set Screw	06
222931	12616	" " Spring	05
222922	12620	Starting Handle (compression) with 227746, two each 200524c and 202845	70
227746	—	Starting Handle (compression) Plate	10
202845	12321	" " " " Rivet	01
200524c	12321	Starting Handle Set Screw	06

Under Driver Transmitter

No.	Plate	Name	Each
206813	—	Starting Lever Compression Shaft	\$ 20
204119	10416	" " " " 206813 with 204120	30
204120	12618	Starting Lever Compression Shaft Collar with 200363c	10
200363c	12605	Starting Lever Compression Shaft Collar Set Screw	03
222923	12620	Under Driver Transmitter complete, Nos. 202499, 204099, 204106, 204113 to 204115, 204119, 215591, 222923, 222931 and three wood screws 1½ in. No. 15	3 50

FEED DRIVING CAM

FOR SHORT STITCH

No.	Plate	Name	Each
222833	12604	Feed Driving Cam with 1299c and 200378c	\$1 25

OBSOLETE PARTS

222808	12604	Bed Plate (front)	2 25
222812	12602	Depressing Bar Driving Eccentric with 1299c and 200378c	2 50
222819	12605	Depressing Bar Lifting Sleeve with 202277	75
222941	12621	Depressing Bar Lifting Sleeve with 202277	1 00
222821	12605	Depressing Bar Lifting Sleeve Link ..	60
222823	12605	" " Spring	10
222824	12605	" " Blade	30

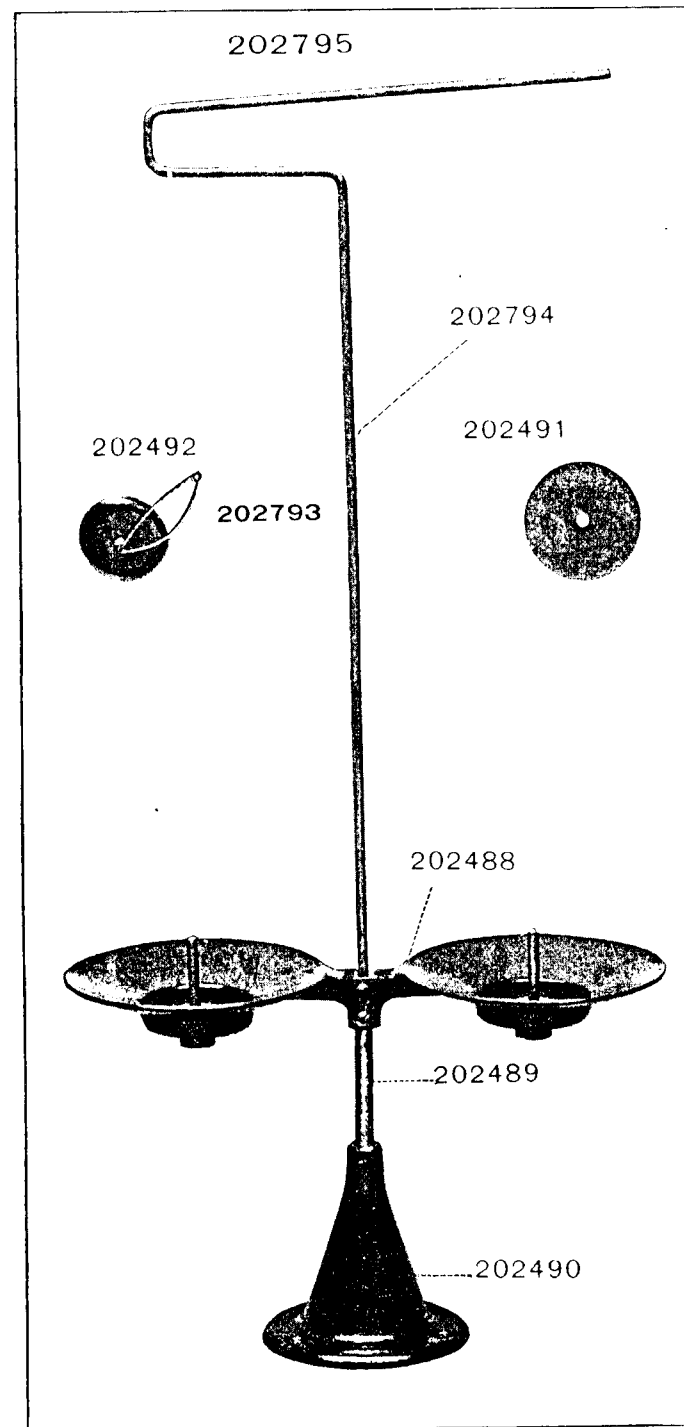
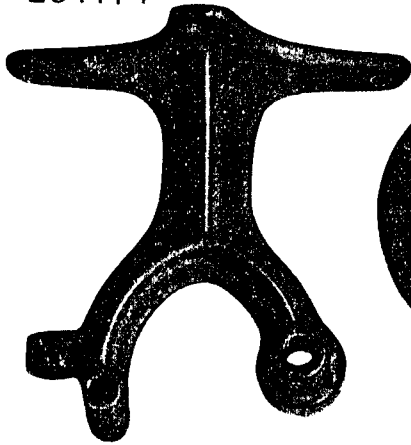
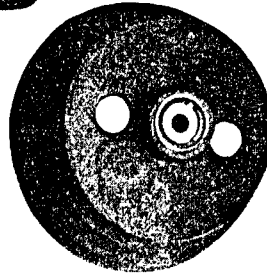

PLATE 10416—ONE-FOURTH SIZE

204114



204099



204115

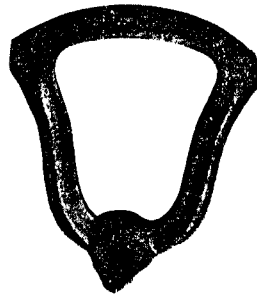

204106



204119



204104



PLATE 10776—ONE-HALF SIZE

36578

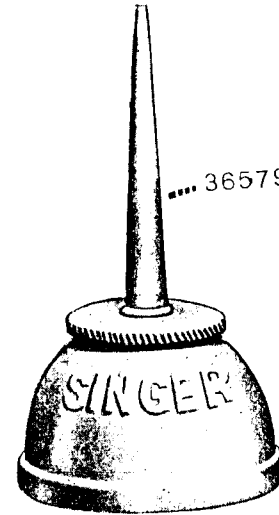

36579

225498

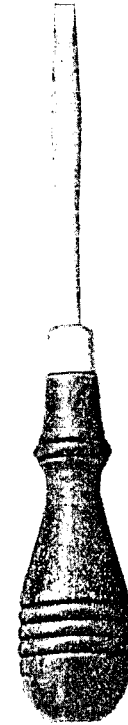

225497



225554



PLATE 11157 ONE-HALF SIZE

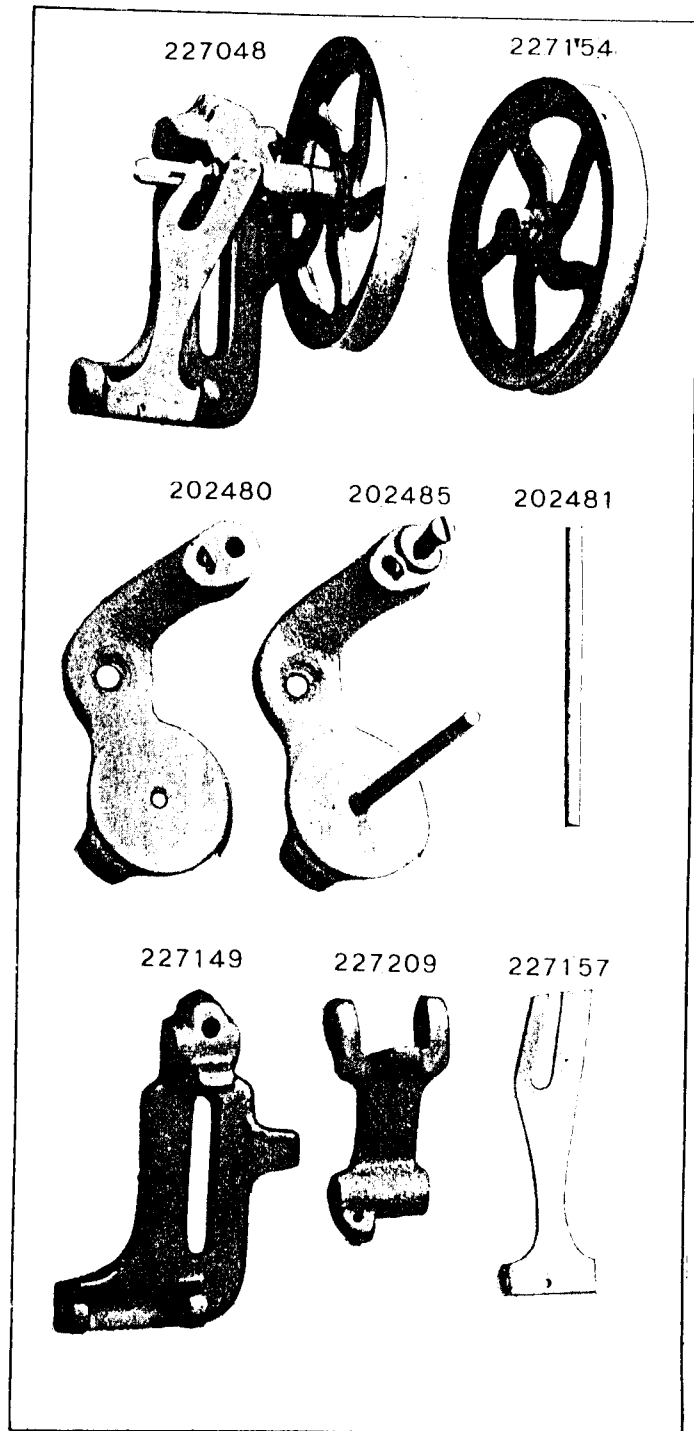

PLATE 12321-FULL SIZE

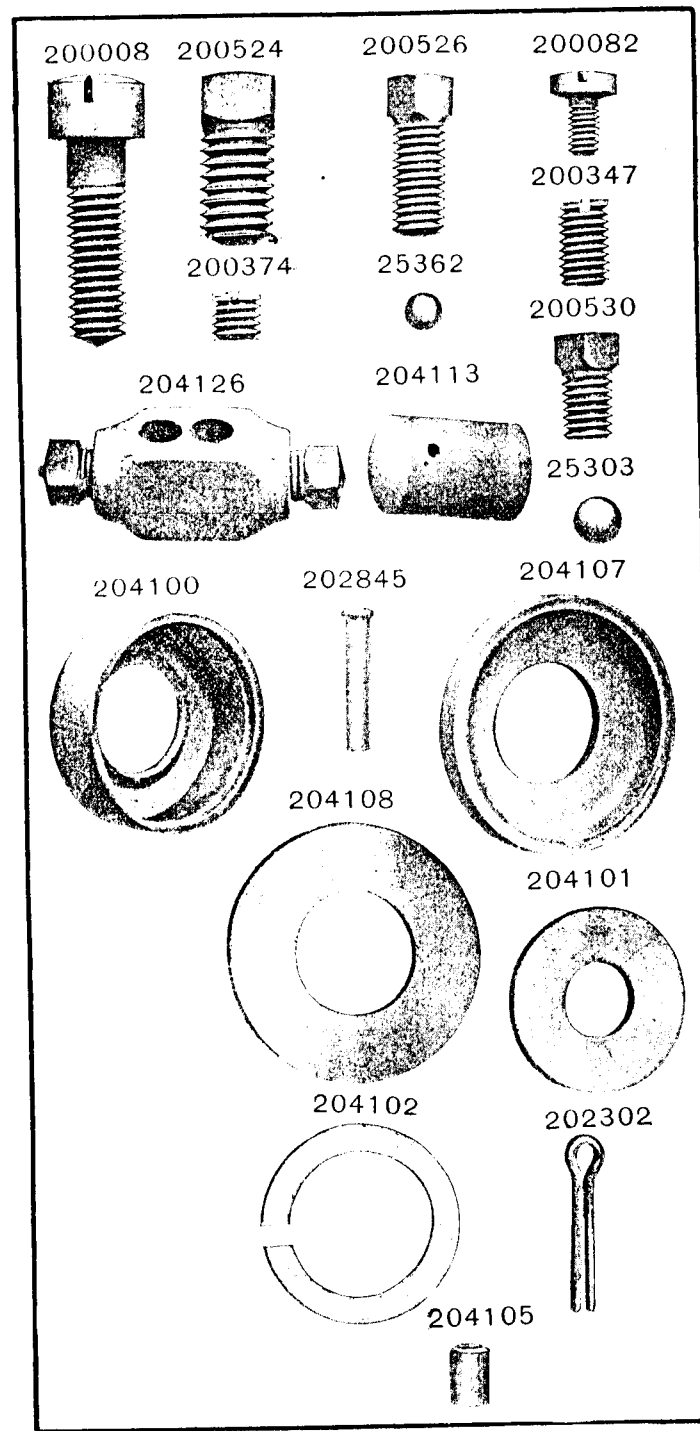

PLATE 12322-FULL SIZE

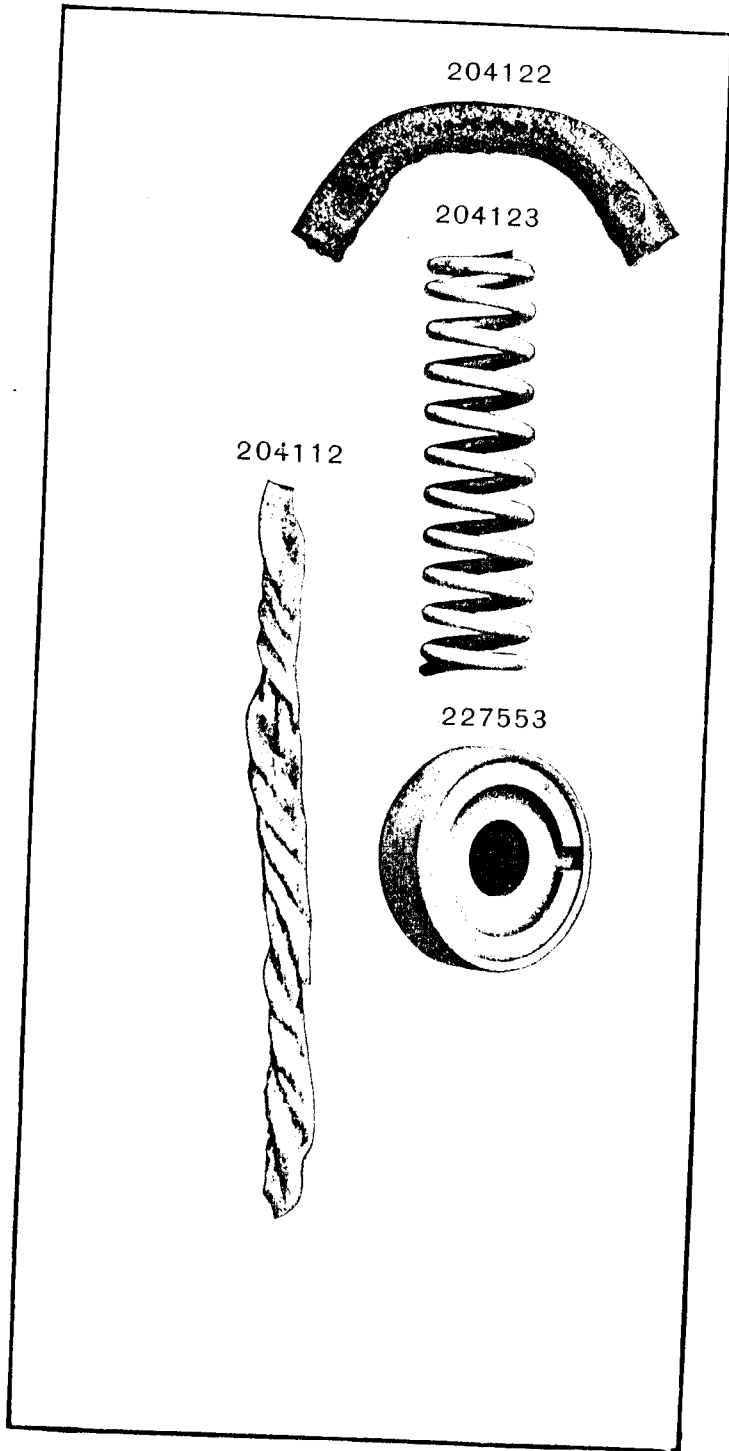

PLATE 12381-FULL SIZE

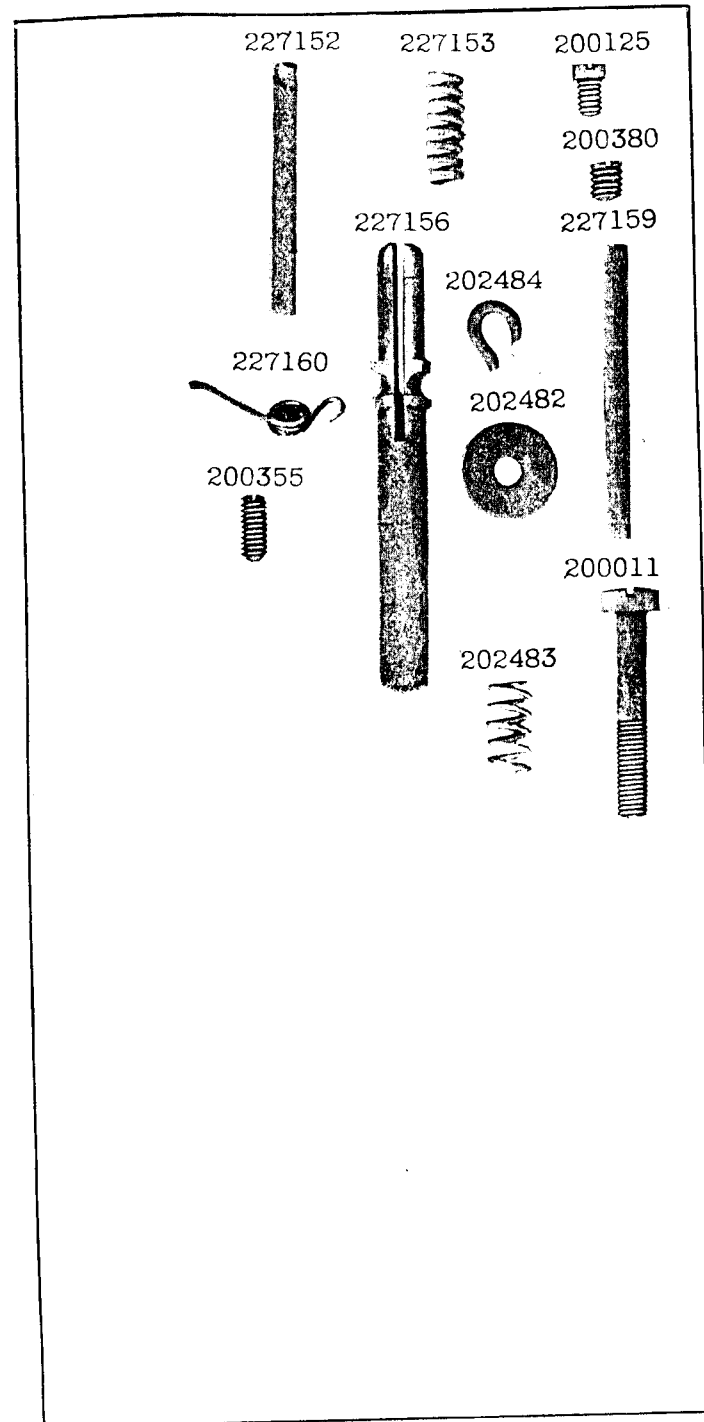

PLATE 12601-ONE-HALF SIZE

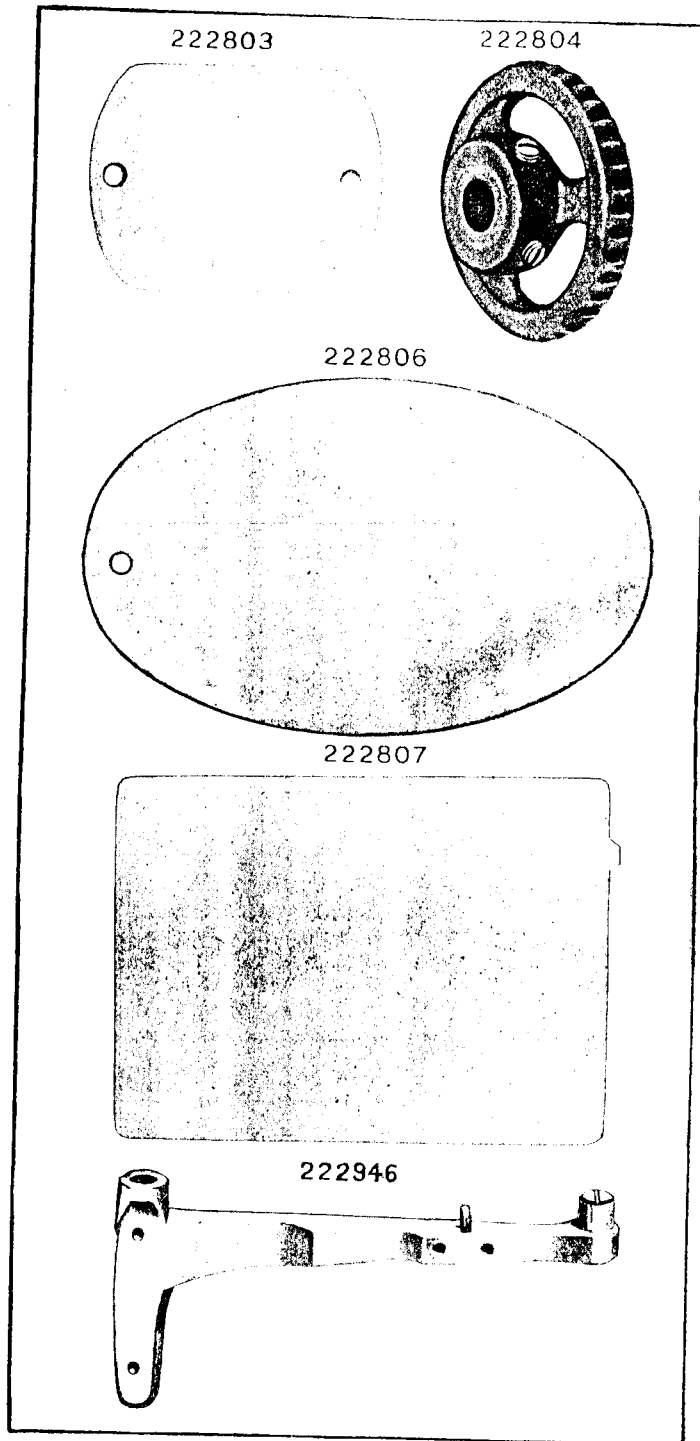

PLATE 12602 -FULL SIZE

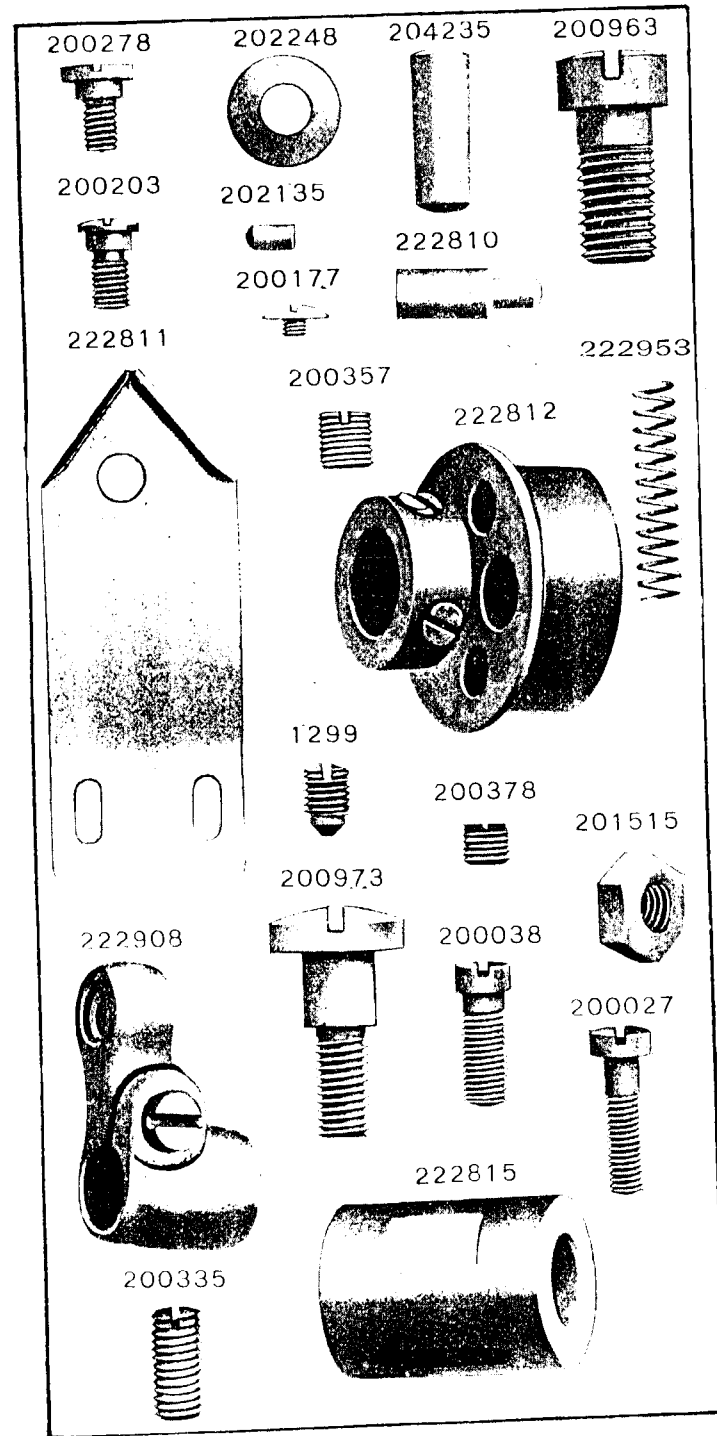

PLATE 12603-FULL SIZE

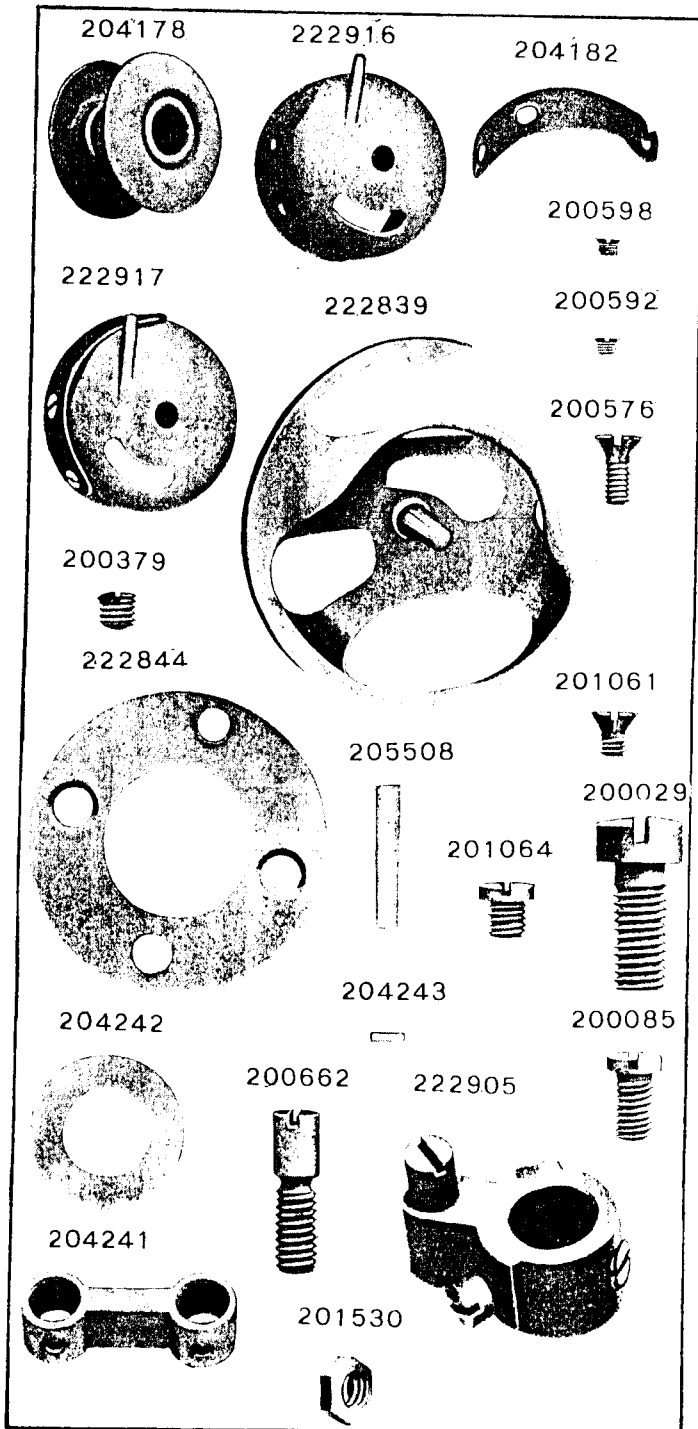

PLATE 12604-ONE-HALF SIZE

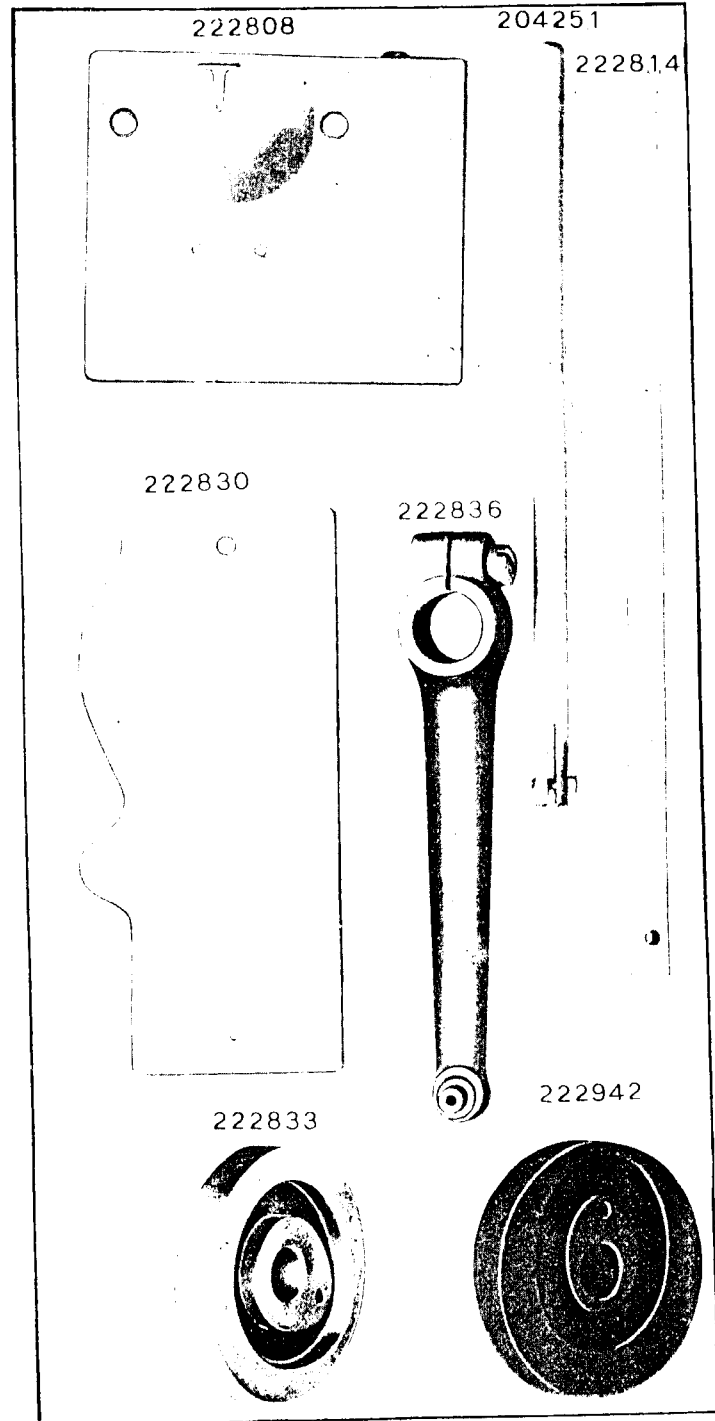

PLATE 12605-FULL SIZE

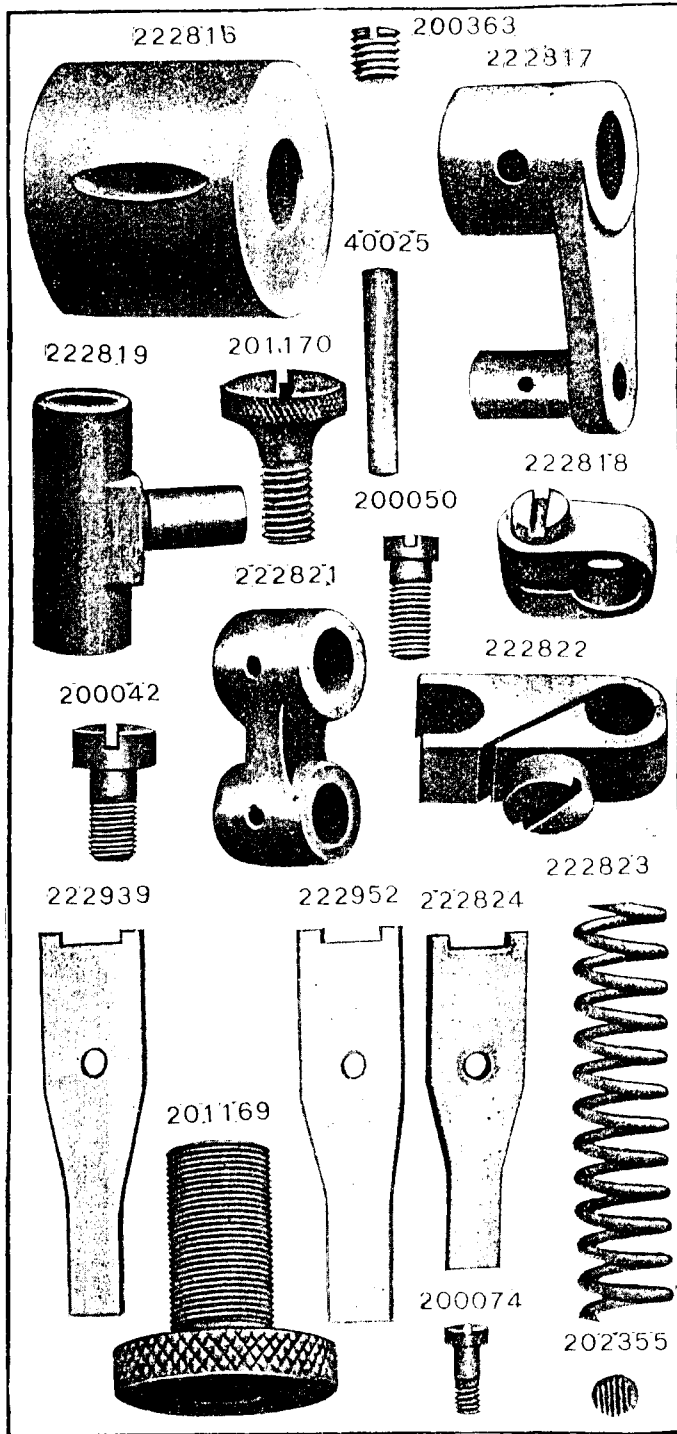

PLATE 12606-FULL SIZE

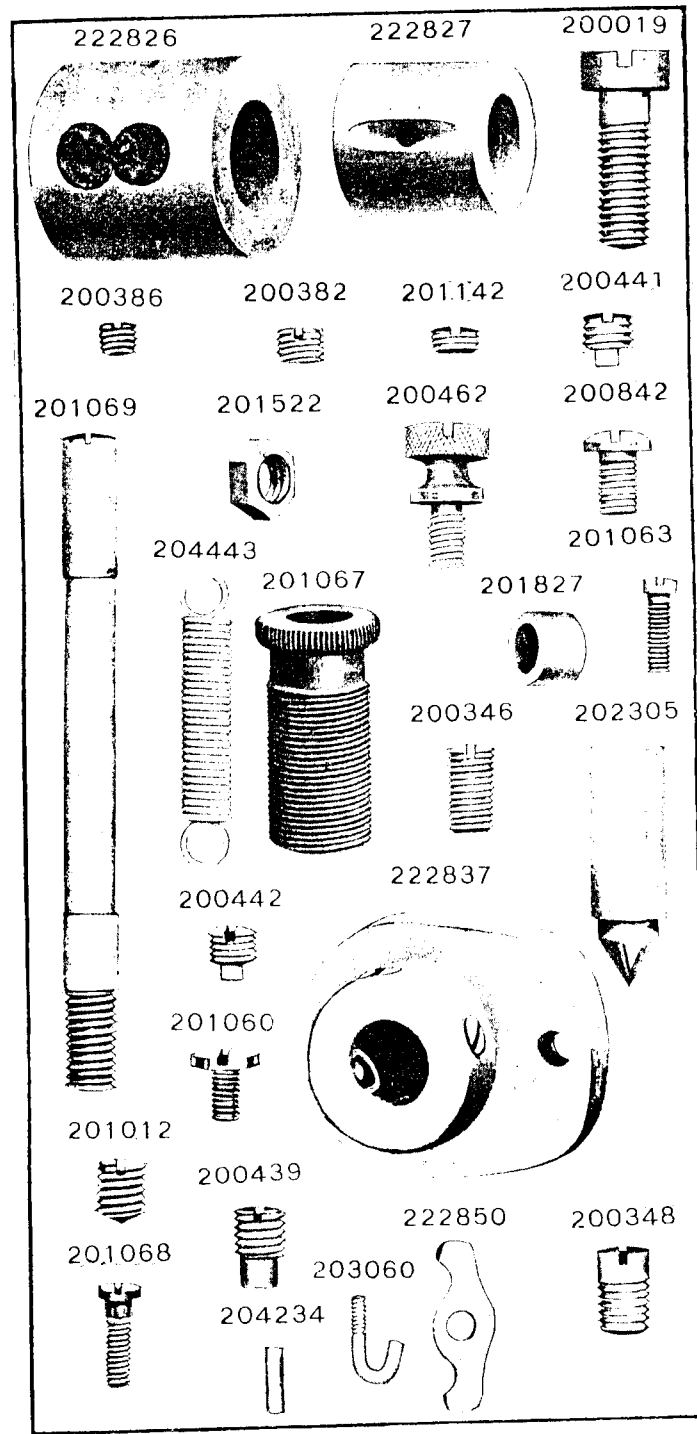

PLATE 12607 -FULL SIZE

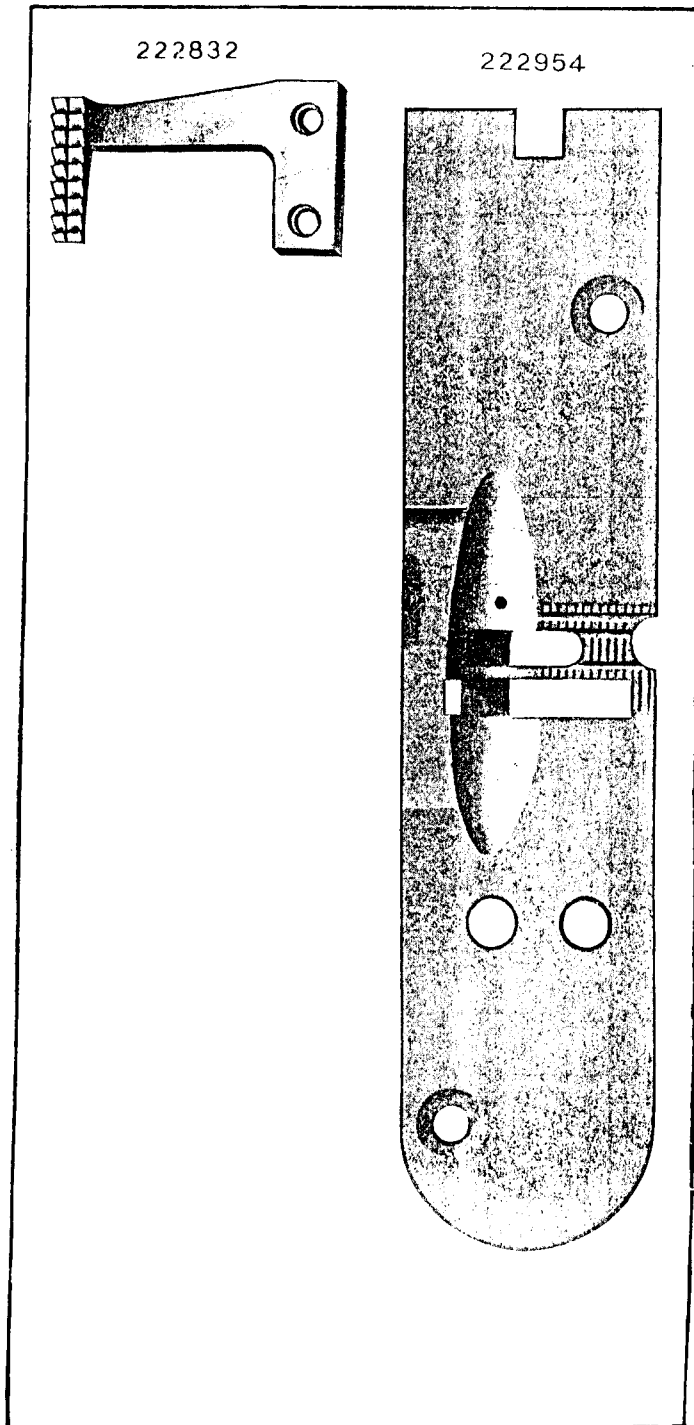

PLATE 12608 -FULL SIZE

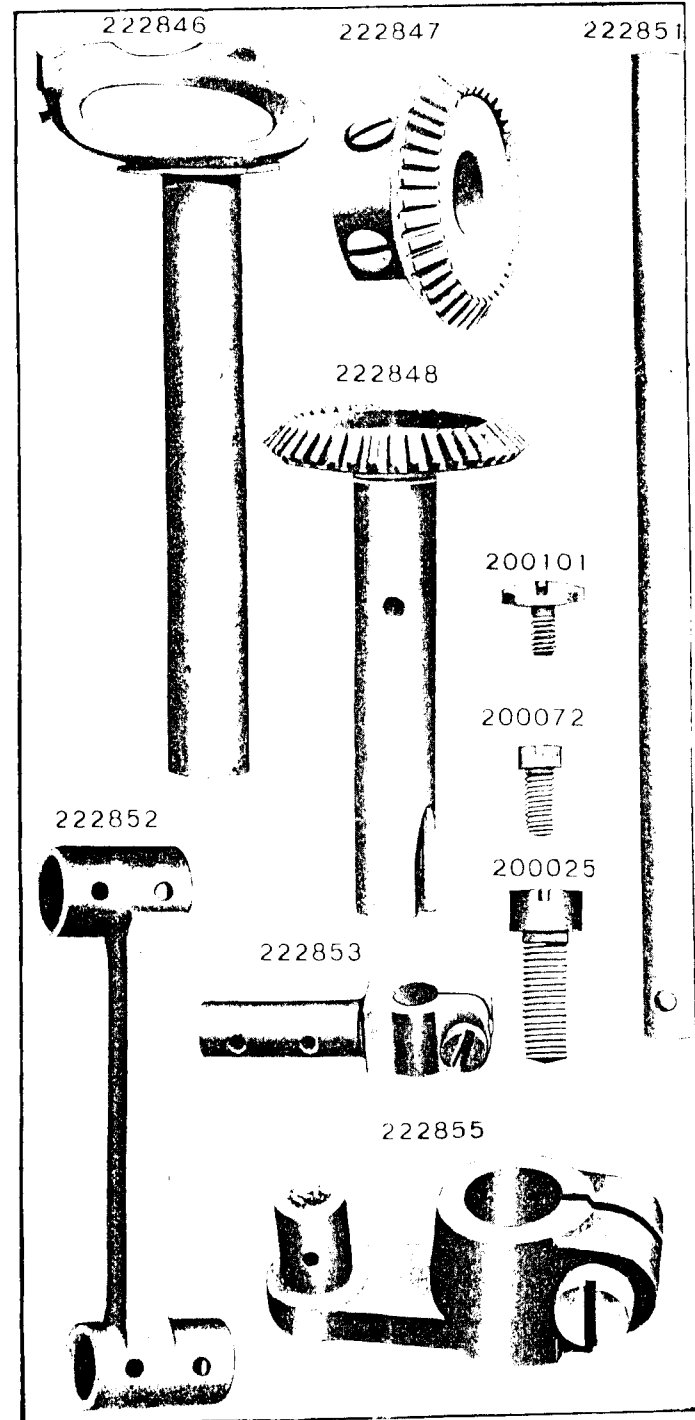

PLATE 12609 -FULL SIZE

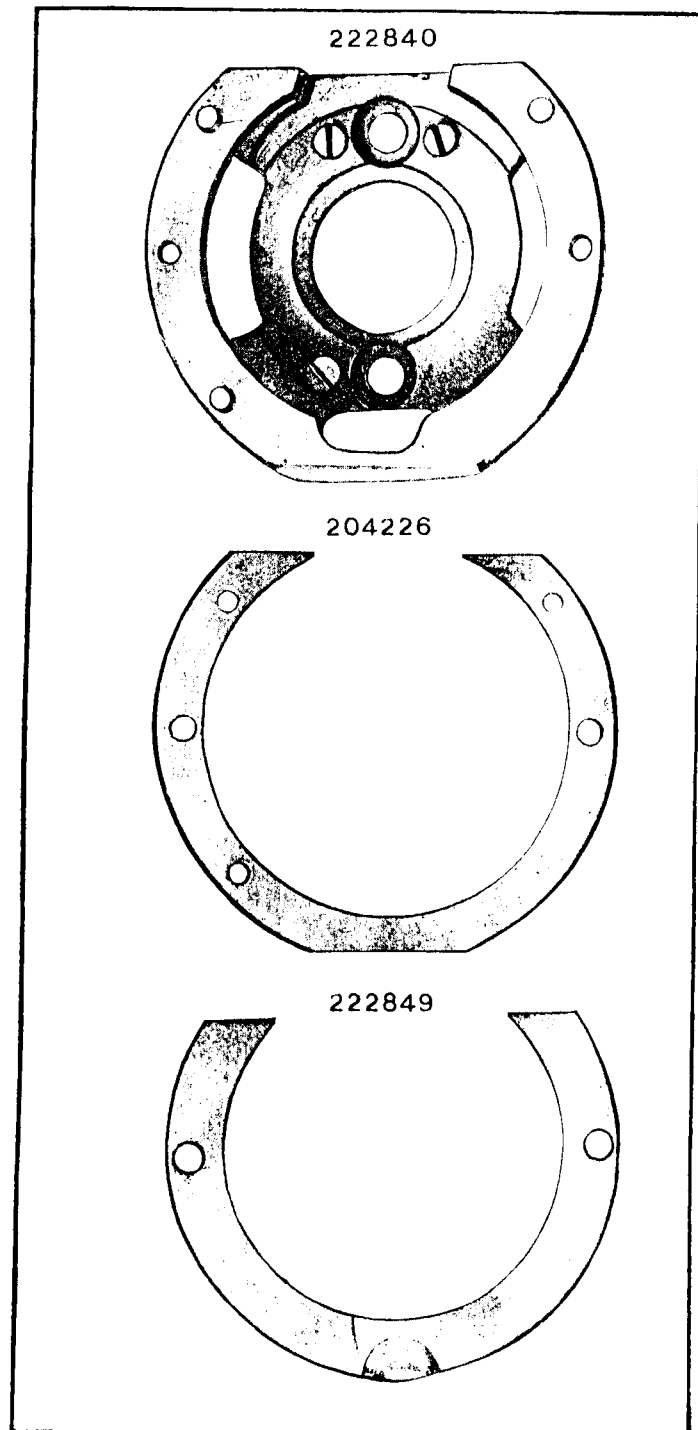

PLATE 12610 -ONE-HALF SIZE

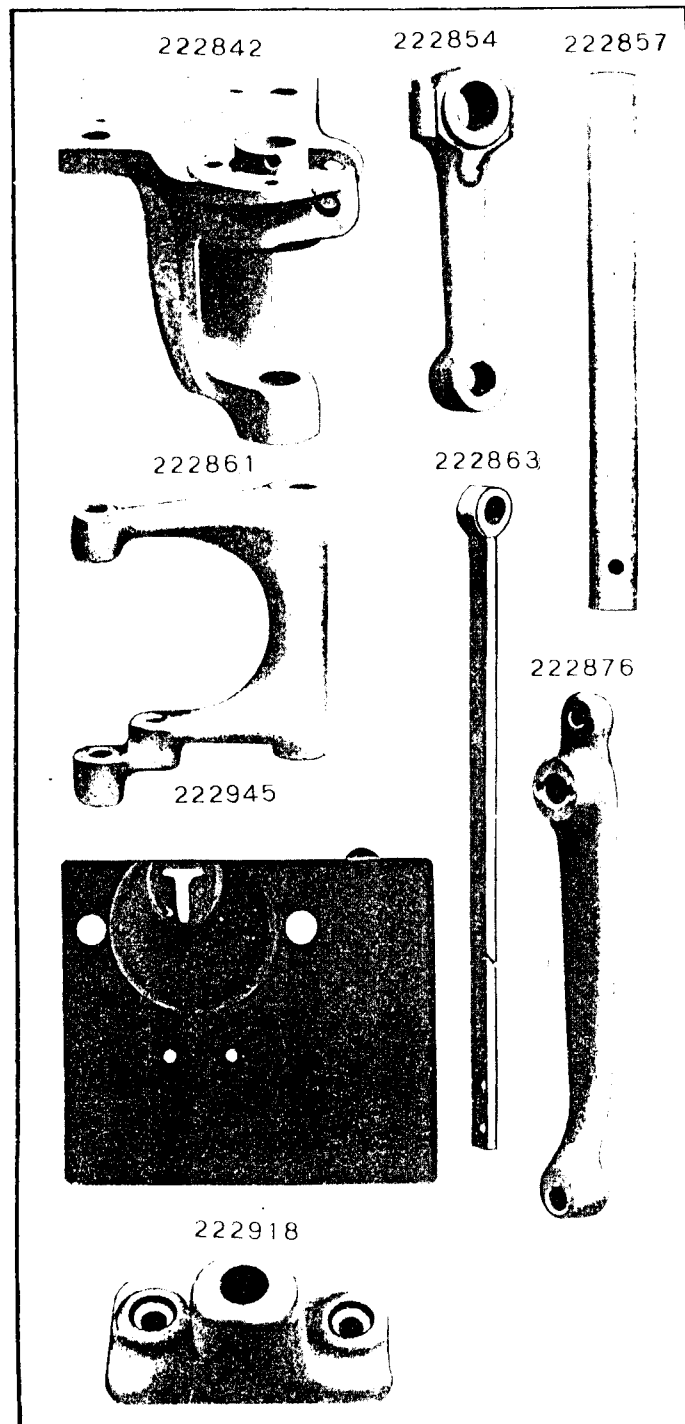

PLATE 12611 -FULL SIZE

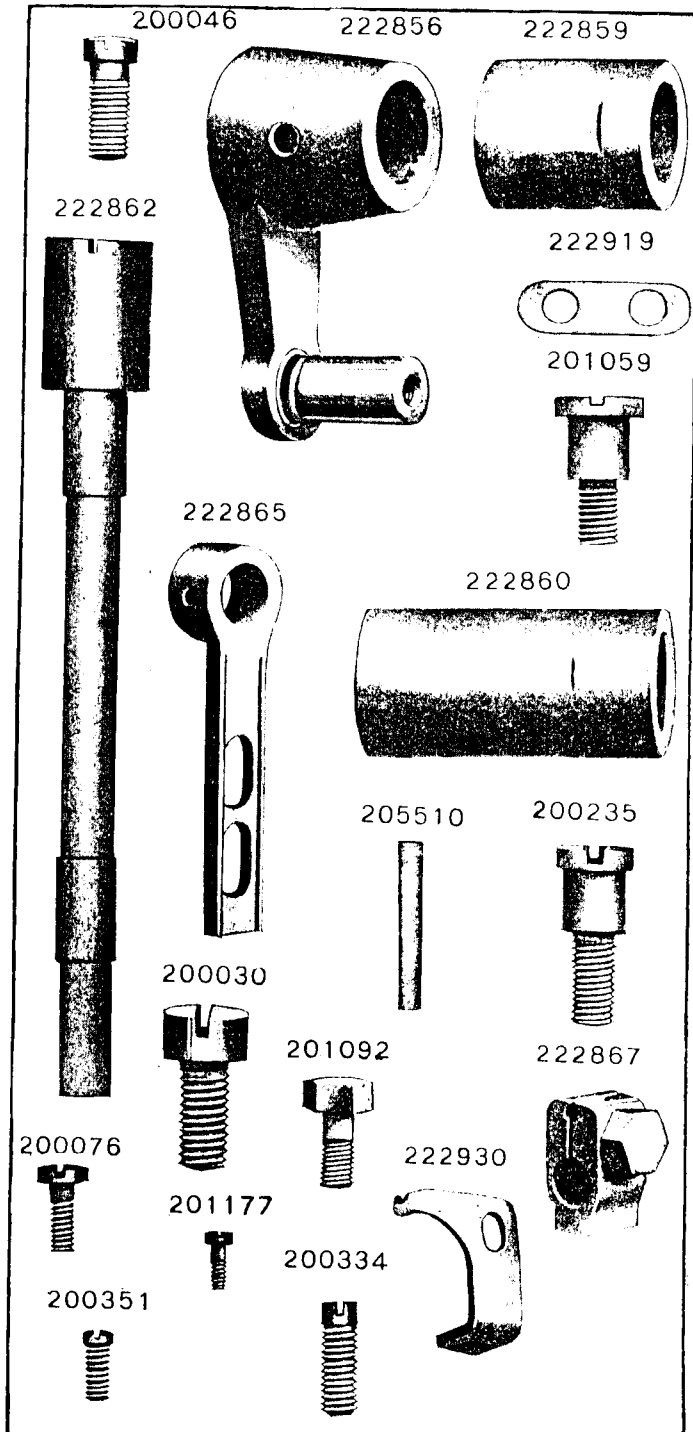

PLATE 12612 -FULL SIZE

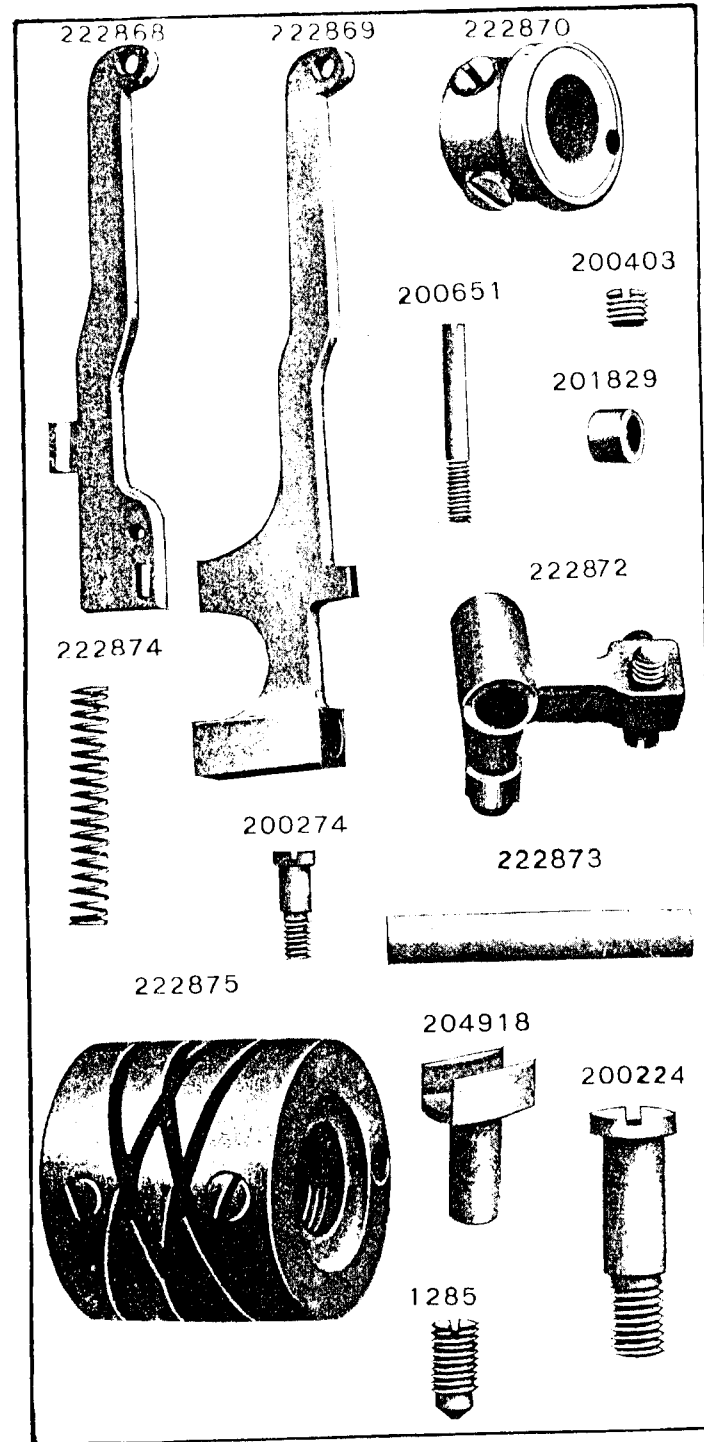

PLATE 12613 -FULL SIZE

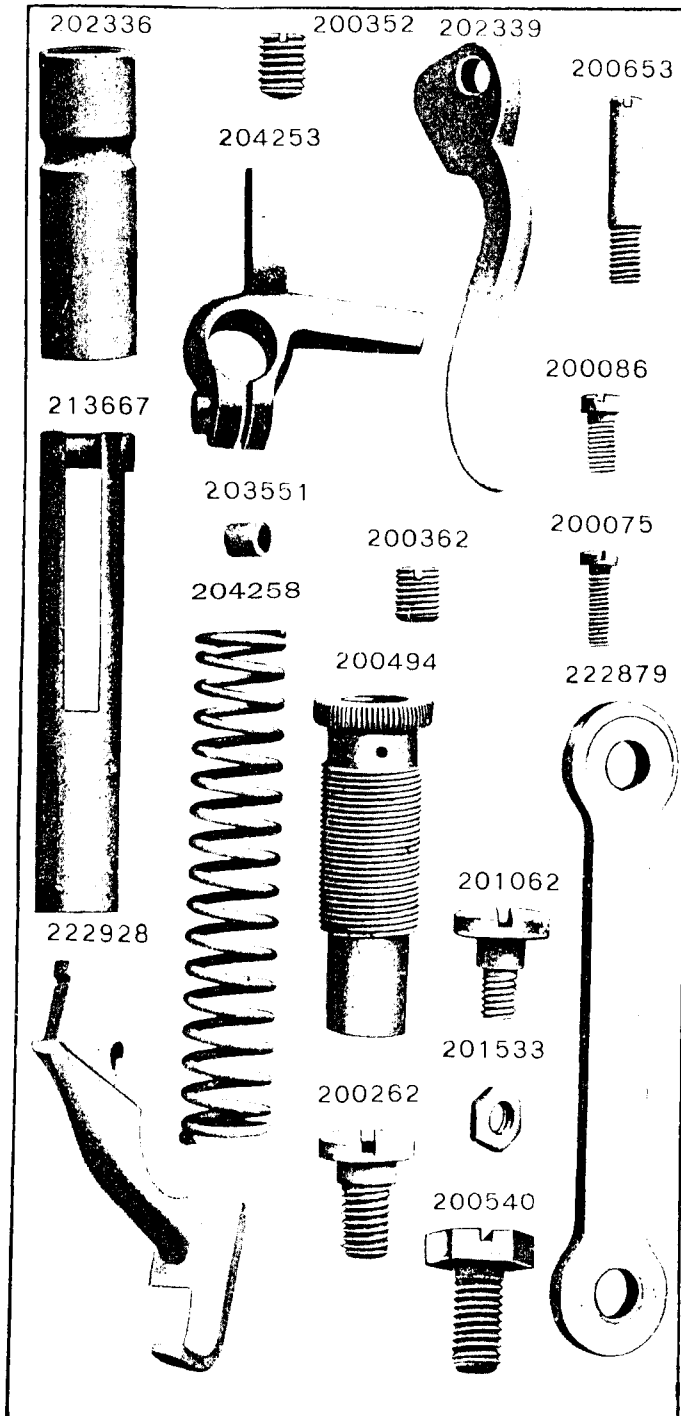

PLATE 12614 -ONE-HALF SIZE

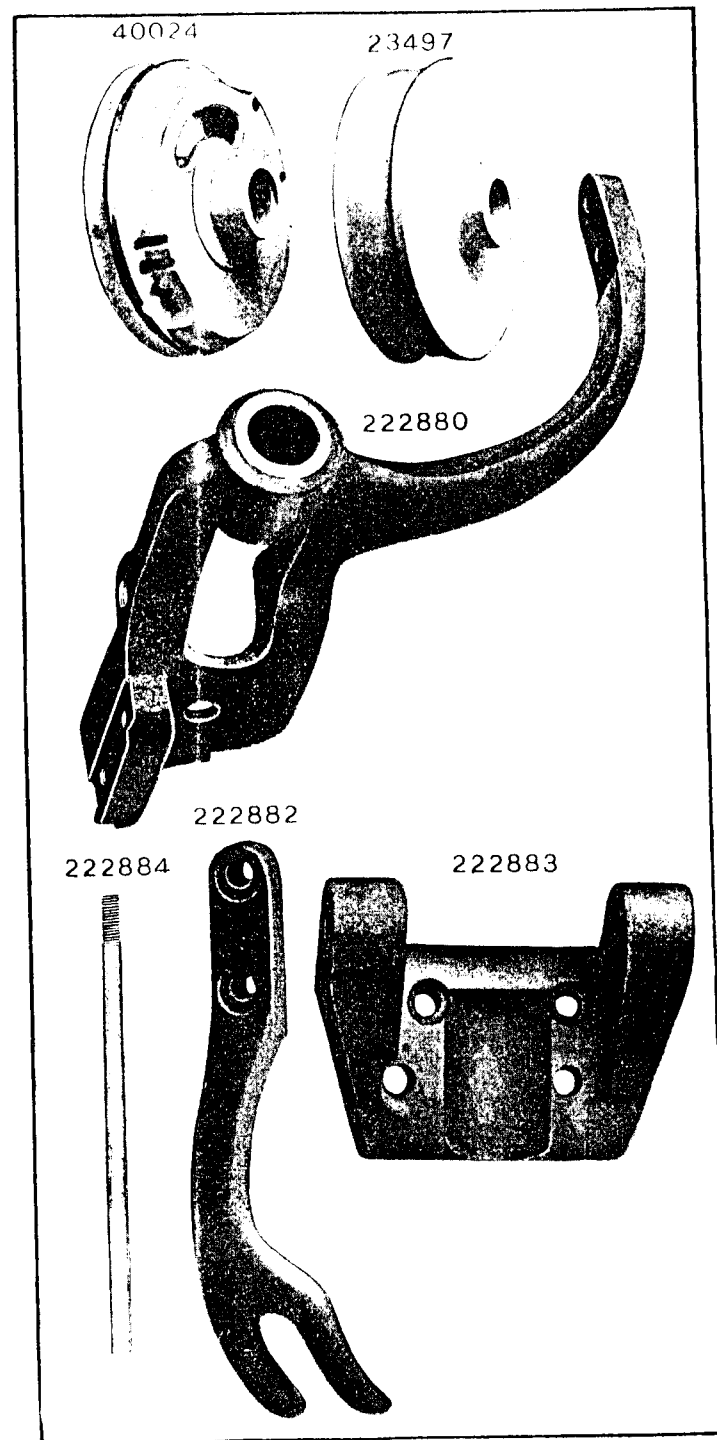

PLATE 12617 -FULL SIZE

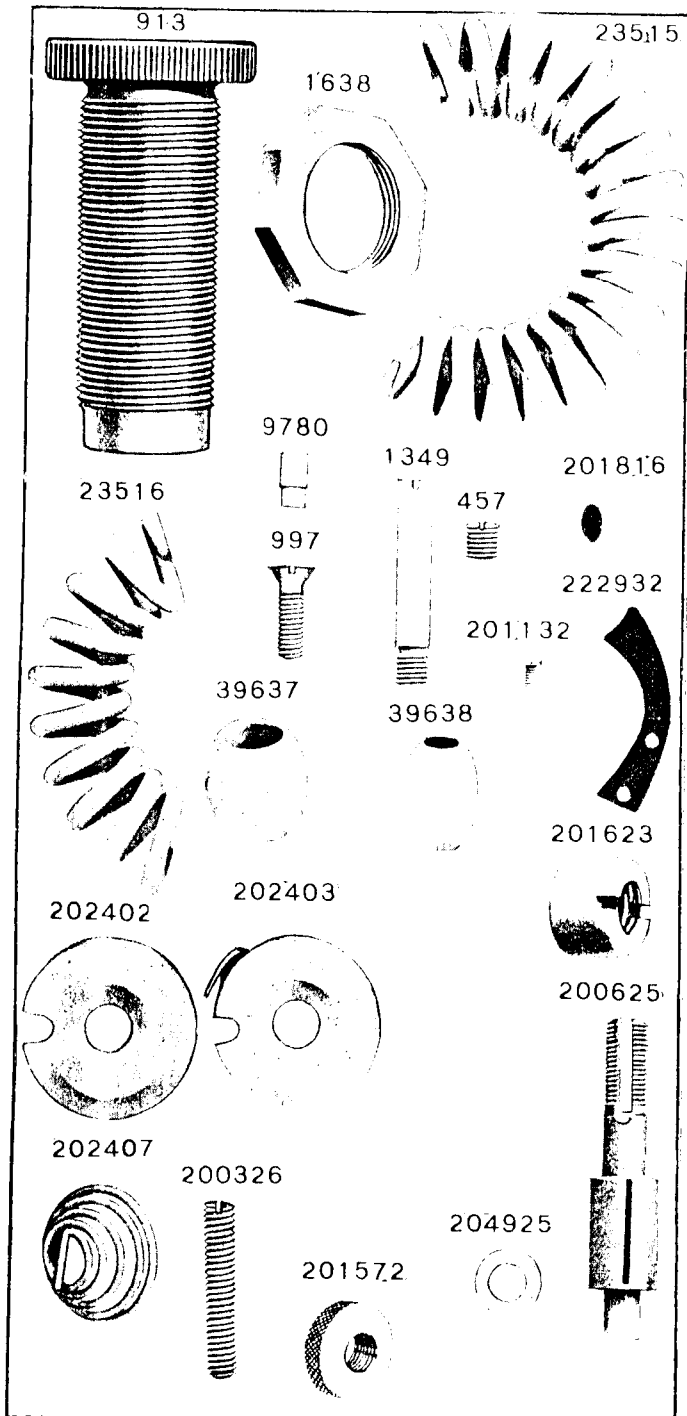

PLATE 12618 -FULL SIZE

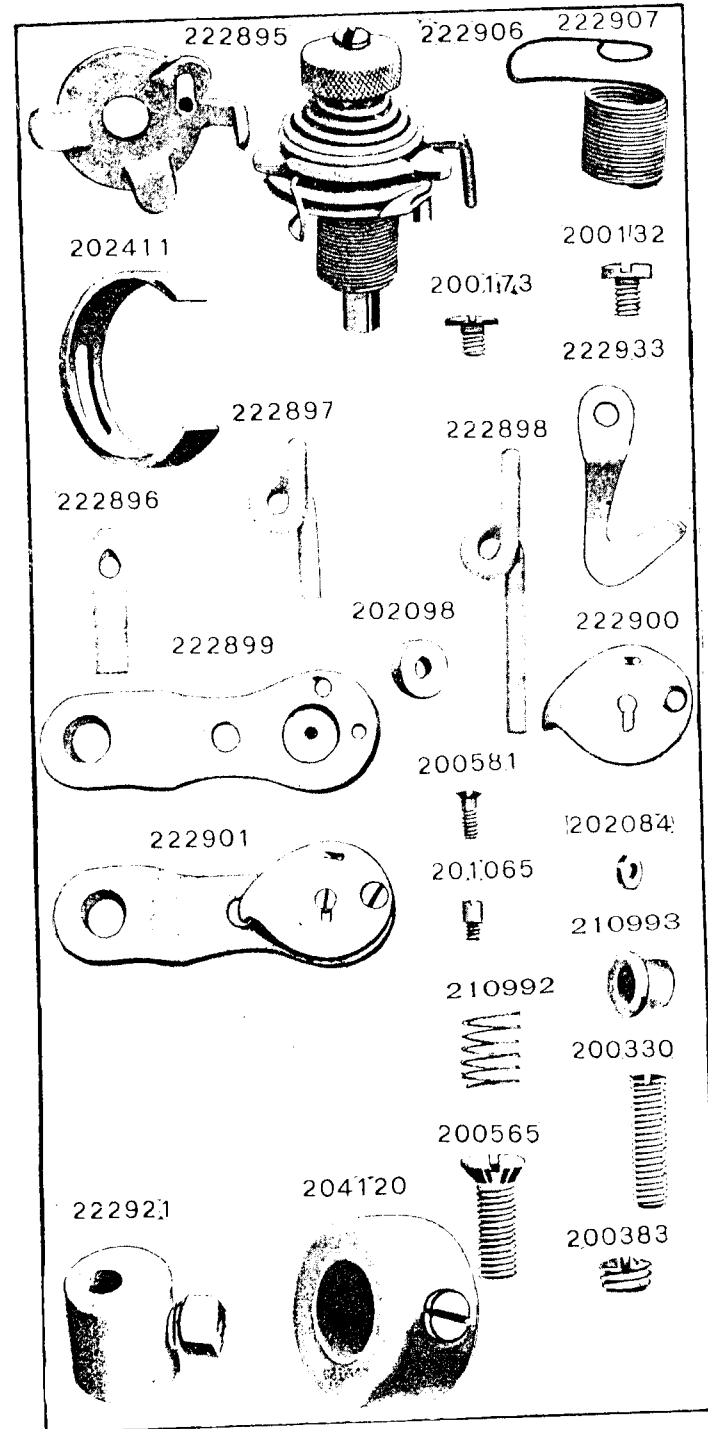

PLATE 12619-ONE-FOURTH SIZE

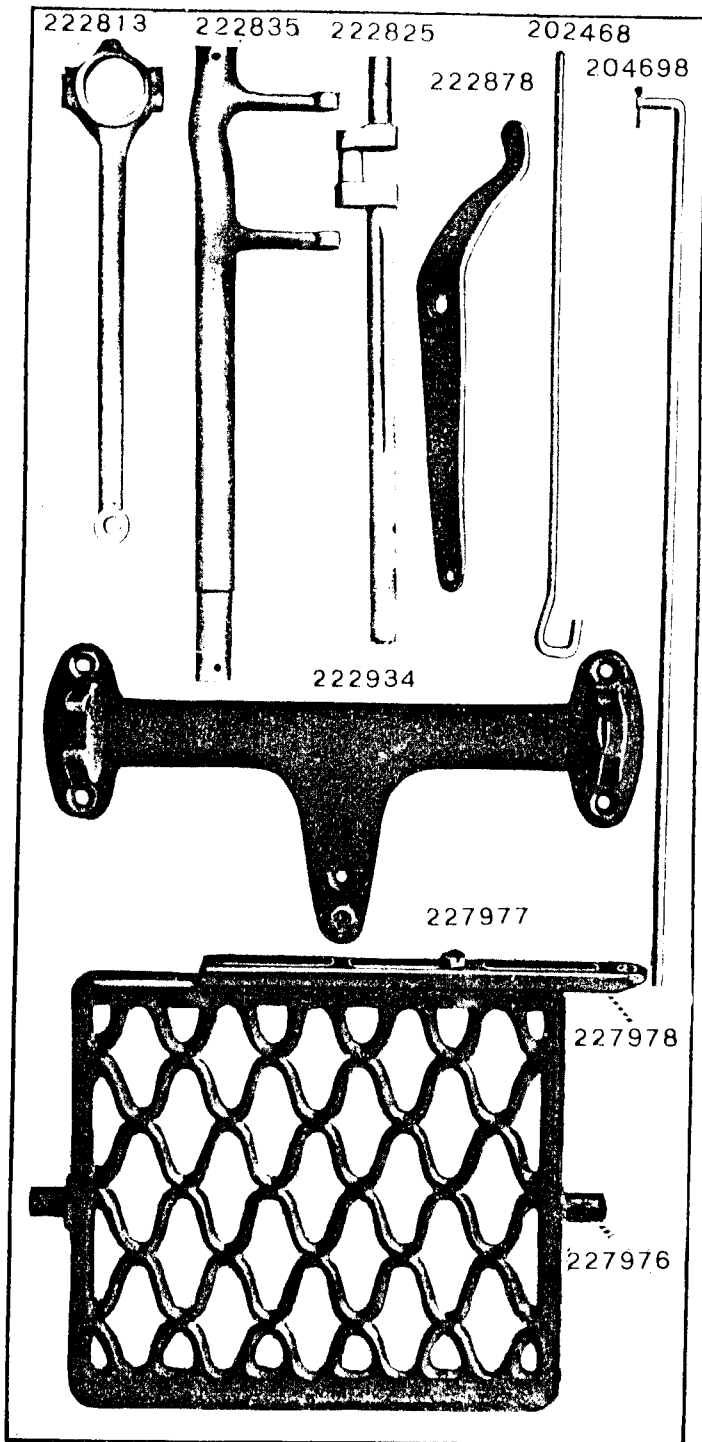

PLATE 12620-ONE-FOURTH SIZE

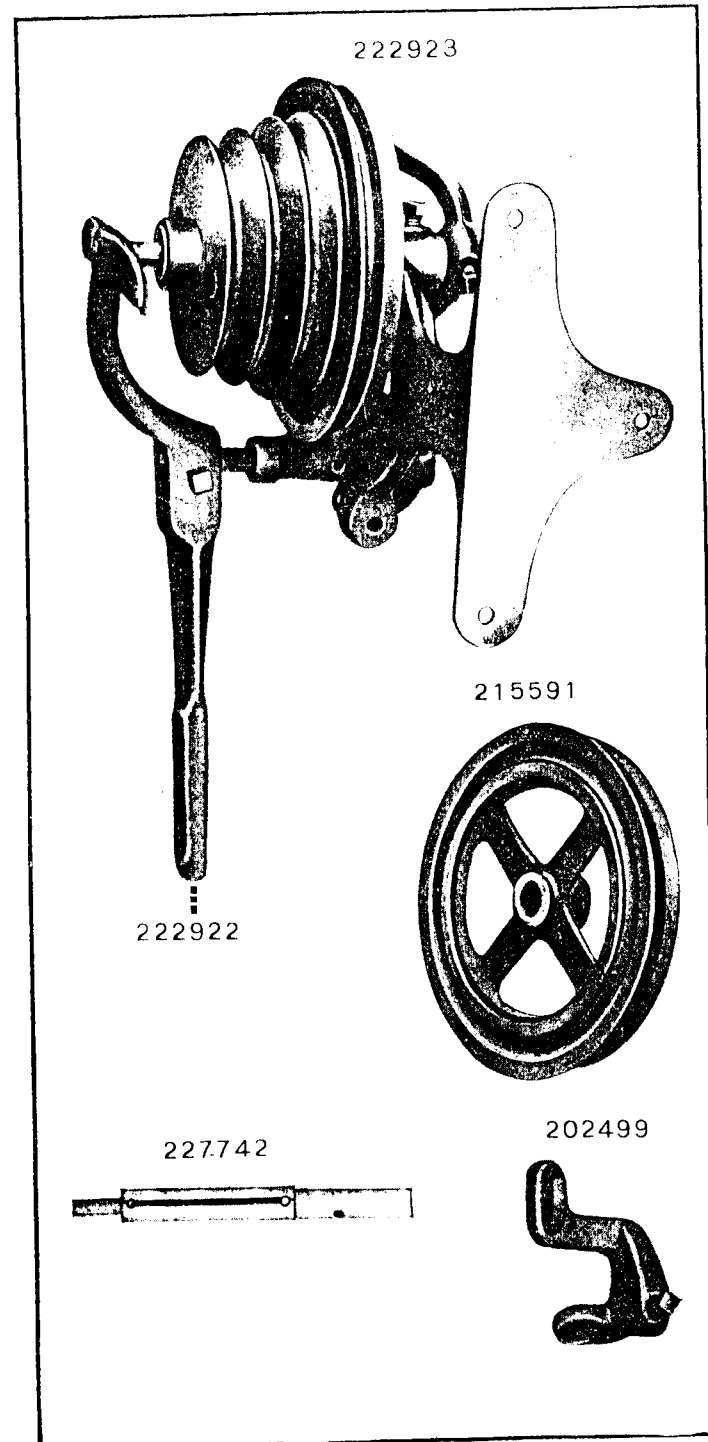

PLATE 12621-FULL SIZE

