

SINGER
47W11

LIST OF PARTS



MACHINE No. 47w11

INDEX

	PAGE
ACCESSORIES	15
BINDERS	22
BOBBIN WINDER	15
FEED DOGS	17
FOOT LIFTER	16
MACHINE No. 47w11	7
NUMERICAL LIST OF PARTS	27
OBsolete PARTS	24
PRESSER FEET	17
THROAT PLATES	21

THE SINGER MANUFACTURING COMPANY

Instructions for Ordering

In ordering from this list, use **ONLY** the **PART** number in the **FIRST** column.

The number stamped on a Sewing Machine Part is the number of the Single Part only, except when the part includes Set Screws, Clamping Screws, Studs and Rollers Spun on, Small Wires riveted, or Parts soldered together, etc., which it is necessary to furnish in combination.

Every combination of parts sent out has its specific number which, although not stamped on Parts (except in above cases) must be used when ordering the combination.

Each number always indicates the **SAME PART** in whatever list it appears, or for whatever Machine.

The letters after some of the numbers indicate the style of finish only, as follows:

- A. Hardened, Polished and Plated.
- B. Polished and Plated.
- C. Hardened only.
- D. Polished only.
- E. Soft, not polished.
- F. Hardened and Polished.
- H. Blued.

These letters **MUST BE USED** when they appear in the list and **AFTER** the number, as in the list.

In this series

200001 to 201500 are Screw Numbers.

201501 to 201800 are Nut Numbers.

201801 to 202000 are Roller Numbers.

202001 and upward are numbers of Machine Parts.

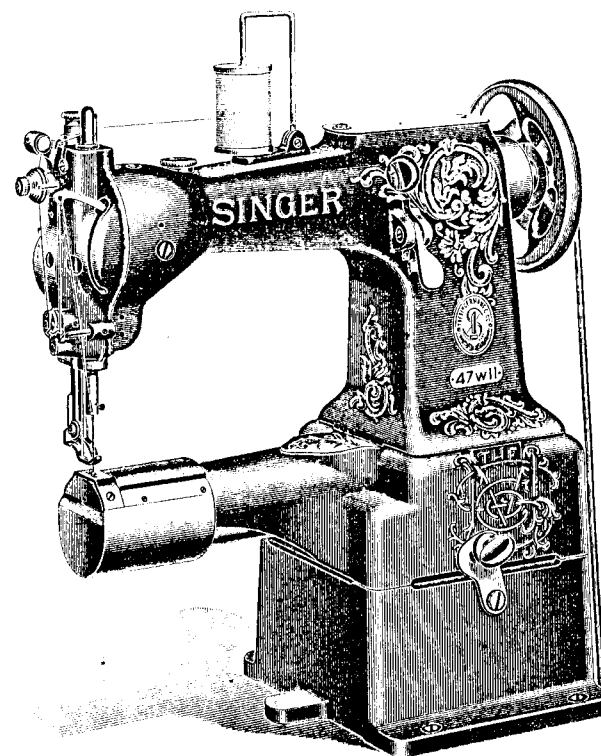
The figures in the second column refer only to the plate in which the illustration of the part is shown and are **NOT TO BE USED** in ordering.

Two or more numbers over a cut indicate that the difference between such parts is not visible in an illustration.

Parts marked with an asterisk (*) are furnished only when repairs are made at the factory.

LIST OF PARTS COMPLETE

FOR



MACHINE No. 47w11

DROP FEED. CYLINDER BED. ALTERNATING

PRESSERS

For Tailoring

No.	Plate	Name
*215766	---	Arm
213144	11150	" Cap
200278H	12311	" " Screw
202248H	11151	" " " Washer
204235	12481	" Position Pin
200963E	12311	" Screw (3)

No.	Plate	Name
202005	11151	Arm Screw Washer (3)
213366	12482	" Shaft
213602	—	" " 213366 with 200244b, 200245b, 213349 to 213351, 213354, 213654, 213655 and two 201528e
204801	11150	Arm Shaft Bushing (back) with 202260
202260	—	Arm Shaft Bushing (back) Oil Packing (wick)
200338c	11151	Arm Shaft Bushing (back) Set Screw
213299	11150	Arm Shaft Bushing (center) with 202260
202260	—	Arm Shaft Bushing (center) Oil Packing (wick)
200341c	11151	Arm Shaft Bushing (center) Set Screw
213781	12483	Arm Shaft Bushing (front) with 202036 and 202260
202260	—	Arm Shaft Bushing (front) Oil Packing (wick)
200502b	11151	Arm Shaft Bushing (front) Oil Packing Thumb Screw
202036	12481	Arm Shaft Bushing (front) Posi- tion Pin
200352c	11151	Arm Shaft Bushing (front) Set Screw
204804	12482	Arm Shaft Connection with four 200054E (2)
200054E	11151	Arm Shaft Connection Screw
204805	12482	Balance Wheel, 5½ in. diam. (belt groove 2¾ in. diam.), with 200328c and 200335c
200062H	12311	Balance Wheel Adjusting Screw ..
200328c	12311	" " Position Screw
200335c	12311	" " Set Screw
*213369	—	Bed (cylinder) with 200439c, 213314, 213380 and two 200516E
213786	11150	Bed (cylinder) Cap
200574D	12481	" " " Screw (2)
213787	11150	" " End Cover
213353	—	" " Base (high)
213890	—	" " (low)
		Note: High Bed Base 213353 furnished only when ordered.
203184	11060	Bed Clamp
200262H	11060	" " Hinge Screw
202622	11151	" " Packing Washer
200728B	11060	" " Thumb Screw

No.	Plate	Name
203185	11060	Bed Clamp Washer
202618	13482	" Hinge
200030H	12473	" " Screw (6)
213338	11150	" Slide (back)
213685	12481	" " Clamp Plate
215781	—	" " " "
200582H	11151	" " " " Screw (4) ..
200459D	12481	" " " " Thumb Screw
226071	12481	" " " " " "
		Spring Washer
233939 (203208)	11228	Bobbin
203210	11228	" Case Base with 202056, 203211 to 203213 and 203216
203211	11151	Bobbin Case Base Latch
*202056	—	" " " " Pin
203212	11151	" " " " Plunger ..
203213	11151	" " " " Spring
203209	11228	" " Cap with 200984c, 203214, 203215 and two 200594c
203214	11228	Bobbin Case Tension Spring
200984c	11151	" " " " Regu- lating Screw
200594c	11228	Bobbin Case Tension Screw
203215	11228	" " Thread Guide
200594c	11228	" " " " Screw ..
203216	11228	" " Washer (cloth)
203217	11228	Bobbin Case complete, Nos. 203209 and 203210
204473	12482	Face Plate with 200366H, 200368H, 200685E, 202087, 202090, 204185, 204281 and two 200397H
200053c	12311	Face Plate Screw
204185	11151	" " Thread Guide
200397H	11151	" " " " Set Screw
204474	12482	Face Plate complete, Nos. 200309E, 200577H, 202088, 204059, 204272, 204280, 204473 and 204486
213295	11060	Feed Bar with 200544E and 213610
213298	12481	" " Connecting Link with two 200072c
200072c	11151	Feed Bar Connecting Link Pinch Screw
200935E	11151	Feed Bar Connecting Link Screw Stud
201532E	11151	Feed Bar Connecting Link Screw Stud Nut
213610	11151	Feed Bar Connecting Link Stud ..
212281	12177	" Dog

No.	Plate	Name
200544E	12481	Feed Dog Screw
213349	12483	" Driving Eccentric (adjustable)
213350	12483	" " " Adjusting Disc
213351	12483	" " " Flange with 200378c and 200437c
200437c	12311	Feed Driving Eccentric Flange Position Screw
200378c	12311	Feed Driving Eccentric Flange Set Screw
213655	11151	Feed Driving Eccentric Friction Spring Washer
200245D	11151	Feed Driving Eccentric Friction Spring Washer Screw
201528E	11151	Feed Driving Eccentric Friction Spring Washer Screw Nut
200244D	11151	Feed Driving Eccentric Fulcrum Screw
201528E	11151	Feed Driving Eccentric Fulcrum Screw Nut
213300	12482	Feed Driving Rock Shaft
213302	—	" " " " 213300 with 200583u, 200935E, 201532E, 213295, 213296, 213298 and 213748
203244	11151	Feed Driving Rock Shaft Collar with two 200393c
200393c	11151	Feed Driving Rock Shaft Collar Set Screw
213354	12482	Feed Driving Rock Shaft Connection with 200054e and 202277 ...
213654	11151	Feed Driving Rock Shaft Connection Collar
200919c	11060	Feed Driving Rock Shaft Connection Hinge Screw
201522E	11151	Feed Driving Rock Shaft Connection Hinge Screw Nut
202277	—	Feed Driving Rock Shaft Connection Oil Packing (wick)
200054E	11151	Feed Driving Rock Shaft Connection Pinch Screw
213301	11060	Feed Driving Rock Shaft Crank with 200050c
200050c	12481	Feed Driving Rock Shaft Crank Pinch Screw
213296	12473	Feed Lifting Cam with 200392c and 200447c
200447c	11151	Feed Lifting Cam Position Screw
213748	12473	" " " Retainer
200583u	11151	" " " " Screw ..

No.	Plate	Name
200392c	12481	Feed Lifting Cam Set Screw
213161	12473	" Regulating Lever with 213657
200665c	11151	" " " Hinge Screw
213656	11151	" " " Spring
213657	—	" " " " Pin ..
227461	12482	Foot Lifter Lifting Lever
227789	—	" " " " 227461 with 200262u
200262u	11060	Foot Lifter Lifting Lever Hinge Screw
221145	12481	Foot Lifter Lifting Lever Position Spring (right)
200835D	12481	Foot Lifter Lifting Lever Position Spring Screw
*203239	—	Hook (sewing)
203240	11228	" 203239 with 201253E, 201376E and 203251
203290	11228	Hook and Bobbin Case complete, Nos. 203217 and 203240
203549	11254	Hook Bevel Gear Socket, 18 teeth
200556u	12473	" " " " Screw ...
213319	12473	" " Pinion with two 200386c
200386c	11151	" " " Set Screw
221171	12482	" Driving Shaft
213314	11150	" " " Bearing
202126	11151	" " " " Position Pin (2)
200516E	12311	Hook Driving Shaft Bearing Screw
213380	11151	" " " Bushing
200439c	12311	" " " " Position Screw
204246	12473	Hook Driving Shaft Collar (back) with two 200383c
200383c	12311	Hook Driving Shaft Collar (back) Set Screw
203244	11151	Hook Driving Shaft Collar (front) with two 200393c
200393c	11151	Hook Driving Shaft Collar (front) Set Screw
203251	11228	Hook Gib
201376E	12481	" " Hinge Screw
201253E	12481	" " Screw
203552	11254	" Saddle (right) with 202299 ..
202299	—	" " Oil Packing (wick) ...
200541E	12473	" " Screw (2)
225837	11151	" " " Washer (2)
203254	11228	" Washer
203554	11254	Hook Saddle (right) complete, Nos. 200556u, 203254, 203290, 203549 and 203552

No.	Plate	Name
204475	10483	Lifting Lever with 200122H
208389	—	" " 204475 with 200935F, 201534E, 204478 and 206659
213004	12473	Lifting Lever Driving Crank
204478	10483	" " " " Link
200122H	10483	" " " " " "
		Stop Screw
200400C	12473	Lifting Lever Driving Crank Position Screw
200387C	12376	Lifting Lever Driving Crank Position Screw Set Screw
204479	12473	Lifting Lever Driving Crank Position Screw Set Screw Packing (brass)
200181D	10483	Lifting Lever Stop Screw
204480	10483	" " Stud Lifting Bracket with 200086C and 200181D
208390	—	Lifting Lever Stud Lifting Bracket 204480 with 208389
200086C	12481	Lifting Lever Stud Lifting Bracket Pinch Screw
229626	13037	Lifting Presser Foot
200074F	12481	" " " Screw
204483	12483	Needle Bar (hollow) with 200125F, 200587E and 204487
204418	—	Needle Bar Connecting Link
204249	12481	" " " Stud with 200072C and 202277
202277	—	Needle Bar Connecting Stud Oil Packing (wick)
200072C	11151	Needle Bar Connecting Stud Pinch Screw
204326	—	Needle Bar Packing Cord (2)
200504E	12481	" " Screw Bushing (lower)
200503B	12481	" " " " (upper)
204487	10483	" " Thread Guide
200587E	10483	" " " Screw
200125F	12481	" Set Screw
204251	12483	Presser Bar (hollow) with 200074F
204252	12481	" " Lifter
200550C	12311	" " " Hinge Screw
204481	12473	" " Lifting Bracket Position Guide
200362C	12311	Presser Bar Lifting Bracket Position Guide Set Screw
204327	—	Presser Bar Packing Washer (felt)
200504E	12481	" " Screw Bushing (lower)
204482	12473	" " Spring

No.	Plate	Name
200491R	12481	Presser Bar Thumb Screw (pressure regulating)
201506B	12376	Presser Bar Thumb Screw Check Nut
202068	12483	Spool Holder Base
200575H	12311	" " " Screw
204296	12483	" " Wire
200079H	12311	" " " Hinge Screw
204297	12483	Spool Holder complete, Nos. 200079H, 202068 and 204296
213925	12483	Take-up Cam with 200347C, 200383C, 200387C, 200400C, 200430C and 204479
203172	10445	Take-up Cam Friction Washer
200430C	12311	" " Position Screw
200383C	12311	" " " " Check Screw
200347C	12376	Take-up Cam Set Screw
213005	12483	Take-up Cam complete, Nos. 204418, 213004 and 213925
204262	10445	Take-up Lever
206556	—	" " 204262 with 204263
204263	10445	" " Bearing with 204264
204264	10445	" " " Position Pin
200042F	12311	" " " Screw
201816	10445	" " Roller
204266	10445	Take-up Lever complete, Nos. 200042F, 201816 and 206556
202402	12309	Tension Disc
202090	12309	" " Position Pin
204486	10483	" Release Lever
200685E	10483	" " " Position Screw
200309E	10483	" " " Screw
202075	12309	" " Plunger
204416	12481	" " Slide with 204269
204269	12481	" " " Spring
202407	10881	" Spring
200632B	12309	" Stud
200397H	11151	" Stud Set Screw
201572B	10881	" Thumb Nut
204271	12309	" Washer
204272	12309	Tension complete, Nos. 200632B, 201572B, 202075, 202407, 204271 and two 202402
204274	12309	Thread Controller Plate
200577H	12311	" " " Screw
202098	12309	" " Roller
204275	12309	" " " Guard
202084	12309	" " " " Washer

No.	Plate	Name
200300c	12309	Thread Controller Roller Screw ...
204276	12309	" " Spring
204333	12309	" " " Guard
200581H	12309	" " " " Screw
202087	12473	" " " Stop
202088	10483	" " " Stud with 204925
200366H	12309	Thread Controller Spring Stud Set Screw
204925	12481	Thread Controller Spring Stud Washer
205987	12309	Thread Controller complete, Nos. 200300c, 200581H, 202084, 202098, 204274, 204275 and 204333
204280	12309	Thread Controller and Spring com- plete, Nos. 204276 and 205987 ..
202413	12481	Thread Guide
204281	12309	" Retainer Guide Wire
202091	12309	" " Sleeve
202092	12309	" " Spring
204058	12309	" " Stud
200368H	12309	" " " Set Screw
204059	12309	Thread Retainer complete, Nos. 202091, 202092 and 204058
212280	12177	Throat Plate, 46 needle hole, for needle sizes 16 and 18
200577H	12311	Throat Plate Screw (2)
206660	—	Vibrating Presser Bar
206659	12376	" " " " 206660 with 204493 and two 200138D
200935F	11151	Vibrating Presser Bar Hinge Screw
201534E	12481	" " " " " " Nut
229838	12376	Vibrating Presser Bar Position Stop
200053C	12311	" " " " " " Screw
204493	12376	Vibrating Presser Bar Spring
200138D	12473	" " " " " Screw
204620	12376	" " Foot
200098F	12473	" " " Screw
203357	12473	" " " " Washer

ACCESSORIES

No.	Plate	Name
203208	11228	Bobbin (5)
*225482	—	" Case Screw Driver Blade ...
*225483	—	" " " " Handle ..
225497	11156	Bobbin Case Screw Driver com- plete, Nos. 225482 and 225483 ...
204033	11150	Wrench
126 x 3	—	Needles, two each, sizes 16, 18 and 20
227104	—	Drip Pan with one wood screw 1½ in., No. 14
41401	11156	Machine Rest Pin (wood)
36578	11156	Oiler with 36579
36579	11156	" Spout, 3½ in. long, with 120117
120117	—	" " Washer
*225484	—	Screw Driver Blade
*225485	—	" " Handle
225498	11156	Screw Driver complete (7¼ in. long), Nos. 225484 and 225485 ..
225554	11156	Wrench (steel)
225487	12484	Roller Presser Hinge Screw Nut Wrench

BOBBIN WINDER

Swing Automatic, Right Hand

*225451	—	Bobbin Holder
225453	10882	Frame with 202277 and 225438
225454	10882	" Hinge Pin
202277	—	" Oil Packing (wick)
225438	10882	" " Well Cap
225455	10882	" Spring
225456	10882	" " Plunger
202473	10883	Pulley with 200380c
200380c	12319	" Set Screw
*225443	—	Spindle
225452	10882	" 225443 with 225451
225444	10882	Stop Latch
200056E	10882	" " Screw
225458	10882	" " Thumb Lever
225459	10882	" " " " Hinge Stud
225460	10882	" " " " Joint Stud
202478	10882	" " Trip Lever
200299H	10882	" " " " Hinge Screw

No.	Plate	Name
225461	10881	Tension Bracket with 201499B
200082D	10881	" " Screw
202104	10881	" " " Washer
2102	10881	" Disc
202407	10881	" Spring
201499B	10881	" Stud
201572B	10881	" " Thumb Nut
225462	10881	Bobbin Winder Tension Bracket complete, Nos. 201572B, 202407, 225461 and two 2102
225463	10883	Bobbin Winder and Tension Bracket Base
225436	10883	Universal Bobbin Winder complete, Nos. 200056E, 200082D, 200299H, 202104, 202473, 202478, 225444, 225452 to 225456, 225458 to 225460, 225462, 225463 and two wood screws $\frac{3}{4}$ in., No. 13, R.H.B.

FOOT LIFTER

227952	11156	Foot Lifter Lever with 227954
227678	11156	" " " Chain, 48 in. long, with 202784
227954	12484	Foot Lifter Lever Chain Hook (lower)
202784	12484	Foot Lifter Lever Chain Hook (upper)
225016	12484	Foot Lifter Lever Hinge Pin
227953	11156	" " " Stand with two wood screws 1 in., No. 13
227955	11156	Foot Lifter Lever complete, Nos. 225016, 227678, 227952 and 227953 (Other Foot Lifter Parts are listed with Parts of machine head.)

FEED DOGS

No.	Plate	Name
212285	12485	Feed Dog, for 221183
212258	12485	" " " 212256 and 212257 ..
212281	12177	" " " 212279 and 212280 ..
212282	12177	" " " 212279 and 212280 ..
212290	12179	" " " 212288 and 212289 ..
212220	12485	" " " 212291 to 212296 ...
212221	12485	" " " 212291 to 212296 ...
212298	12485	" " " 212297

PRESSER FEET

204601	13034	Lifting Presser Foot, for 206707 and 206716
204602	13034	Lifting Presser Foot, for 206672, 206673, 206707 and 206715 to 206717
204603	13034	Lifting Presser Foot, for 206672, 206673, 206707 and 206715 to 206717
204604	13034	Lifting Presser Foot, for 206668, 206675, 206678, 206714 and 206719
204605	13034	Lifting Presser Foot, for 206668, 206675, 206678, 206714 and 206719
204606	13034	Lifting Presser Foot, for 206676, 206699 and 206700
204607	13034	Lifting Presser Foot, for 206707 and 206716
204609	13034	Lifting Presser Foot, for 206672, 206673, 206681, 206707 and 206715 to 206717

Presser Feet

No.	Plate	Name
204610	13035	Lifting Presser Foot, for 206676, 206699 and 206700
204595	12376	Lifting Presser Foot, for 204620 ..
204611	13035	" " " " 204620, 204634, 206698, 206705, 206706 and 229620
204612	13035	Lifting Presser Foot, for 204620, 204634, 206698, 206705, 206706 and 229620
206674	13035	Lifting Presser Foot, 46 needle hole, for 206668, 206675, 206678, 206714 and 206719
221182	13035	Lifting Presser Foot, for 204620, 204634, 206698 and 229620, for use with 230656
206697	13035	Lifting Presser Foot, for 204620, 204634, 206698, 206701 and 229620
229625	13035	Lifting Presser Foot, for 204620, 204634, 206698, 206705, 206706 and 229620
229633	13035	Lifting Presser Foot, for 206672, 206673, 206707 and 206715 to 206717
206695	13037	Lifting Presser Foot, for 204620, 204634, 206698 and 229620
206694	13037	Lifting Presser Foot, for 204621, 206692 and 206693
204640	13037	Lifting Presser Foot, for 204620, 204634, 206698 and 229620
229626	13037	Lifting Presser Foot, for 204620, 204634, 206698 and 229620
206662	13037	Lifting Presser Foot, 46 needle hole, for 206663
206664	13037	Lifting Presser Foot (grooved), 46 needle hole, for heavy cording, for 206665
206696	13037	Lifting Presser Foot, 46 needle hole, for 204620, 204634, 206698 and 229620
229628	13037	Lifting Presser Foot, for 204621, 206692 and 206693
229629	13037	Lifting Presser Foot, for 206691 and 229630
206702	13035	Lifting Presser Foot, for 206703 and 206704
204634	13036	Lifting Presser Foot, for 204611, 204612, 204640, 206695 to 206697, 221182, 229625 and 229626

Presser Feet

No.	Plate	Name
206663	13036	Vibrating Presser Foot, for 206662
206678	13036	" " " " 204604, 204605 and 206674
206672	13036	Vibrating Presser Foot, for 204602, 204603, 204609 and 229633
206673	13036	Vibrating Presser Foot, for 204602, 204603, 204609 and 229633
206675	13036	Vibrating Presser Foot, for 204604, 204605 and 206674
206691	13036	Vibrating Presser Foot, for 229629
206692	13036	" " " " 206694 and 229628
206700	13036	Vibrating Presser Foot, for 204606 and 204610
206703	13036	Vibrating Presser Foot, for 206702
206705	13036	" " " " 204611, 204612 and 229625
206706	13036	Vibrating Presser Foot, for 204611, 204612 and 229625
206714	13036	Vibrating Presser Foot, for 204604, 204605 and 206674
206719	13036	Vibrating Presser Foot, for 204604, 204605 and 206674
206698	13036	Vibrating Presser Foot, for 204611, 204612, 204640, 206695 to 206697, 221182, 229625 and 229626
229630	13036	Vibrating Presser Foot, for 229629
204621	13038	" " " " 206694 and 229628
229620	13038	Vibrating Presser Foot, for 204611, 204612, 204640, 206695 to 206697, 221182, 229625 and 229626
206704	13038	Vibrating Presser Foot, for 206702
206701	13038	" " " " bind- ing slippers, for 206697
206716	13038	Vibrating Presser Foot, for 204601 to 204603, 204607, 204609 and 229633
206665	13038	Vibrating Presser Foot, for 206664
206668	13038	" " " " 204604, 204605 and 206674
206681	13038	Vibrating Presser Foot, for 204609
206676	13038	" " " " 204606 and 204610
206715	13038	Vibrating Presser Foot, for 204602, 204603, 204609 and 229633
206699	13038	Vibrating Presser Foot, for 204606 and 204610

No.	Plate	Name
206707	13038	Vibrating Presser Foot, for 204601 to 204603, 204607, 204609 and 229633
206693	13038	Vibrating Presser Foot, for 206694 and 229628
206717	13038	Vibrating Presser Foot, for 204602, 204603, 204609 and 229633
204620	12376	Vibrating Presser Foot, for 204595, 204611, 204612, 204640, 206695 to 206697, 221182, 229625 and 229626

THROAT PLATES

No.	Plate	Name
212256	12485	Throat Plate, 50 needle hole, for needle sizes 14 and 15, for 212258
212257	12485	Throat Plate, 46 needle hole, for needle sizes 16 and 18, for 212258
212279	12177	Throat Plate, 50 needle hole, for needle sizes 14 and 15, for 212281 and 212282
212280	12177	Throat Plate, 46 needle hole, for needle sizes 16 and 18, for 212281 and 212282
212288	12179	Throat Plate, 50 needle hole, for needle sizes 14 and 15, for 212290
212289	12179	Throat Plate, 46 needle hole, for needle sizes 16 and 18, for 212290
212291	12179	Throat Plate, 50 needle hole, for needle sizes 14 and 15, for 212220 and 212221
212292	12179	Throat Plate, 46 needle hole, for needle sizes 16 and 18, for 212220 and 212221
212293	12179	Throat Plate, 50 needle hole, for needle sizes 14 and 15, for 212220 and 212221
212294	12179	Throat Plate, 46 needle hole, for needle sizes 16 and 18, for 212220 and 212221
212295	12179	Throat Plate, 50 needle hole, for needle sizes 14 and 15, for 212220 and 212221
212296	12179	Throat Plate, 46 needle hole, for needle sizes 16 and 18, for 212220 and 212221
212297	12485	Throat Plate, 50 needle hole, for needle sizes 14 and 15, for 212298 and 230402
221183	12485	Throat Plate, 50 needle hole, for needle sizes 14 and 15, for 212285

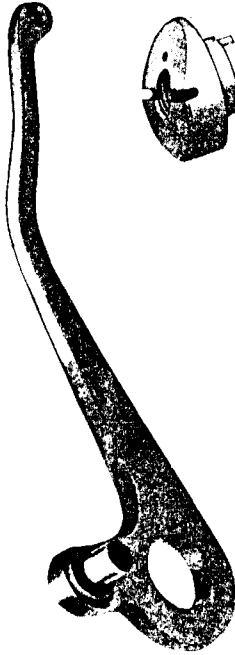
OBSOLETE PARTS

No.	Plate	Name
202470	12320	Bobbin Winder Base
202471	12320	“ “ Frame
202472	12319	“ “ “ Spring
202474	12320	“ “ Spindle
202480	12320	Bobbin Winder Spool Holder Base with 200355H and 202484
202481	12320	Bobbin Winder Spool Holder Base Spool Pin
202482	12319	Bobbin Winder Spool Holder Ten- sion Disc (lower or upper)
202483	12319	Bobbin Winder Spool Holder Ten- sion Disc Spring (brass)
202484	12319	Bobbin Winder Spool Holder Ten- sion Disc Thread Guide
202485	12320	Bobbin Winder Spool Holder com- plete, Nos. 200011E, 202480, 202481, 202483, two 202482 and one wood screw 1 in., No. 13
227522	12319	Bobbin Winder Stop Latch
202477	12319	“ “ Stop Latch Thumb Lever
227523	12320	Bobbin Winder complete, Nos. 200056E, 200161D, 200221D, 201537H, 202470 to 202474, 202477, 202478, 227523, three 200299H and two round head wood screws 1 in., No. 13
212278	12177	Feed Dog, for 212276 and 212277 ..
212276	12177	Throat Plate, 50 needle hole, for needle sizes 14 and 15, for 212278
212277	12177	Throat Plate, 46 needle hole, for needle sizes 16 and 18, for 212278
212286	12486	Throat Plate, 50 needle hole, for needle sizes 14 and 15, for 212285
212287	12486	Throat Plate, 46 needle hole, for needle sizes 16 and 18, for 212285
215612	—	Vibrating Presser Bar
204489	13041	“ “ “ 215612 with 204493 and two 200138D
215628	—	Vibrating Presser Bar
204488	13041	“ “ “ 215628 with 204493 and two 200138D
204492	13041	Vibrating Presser Bar Position Guide

No.	Plate	Name
204623	13041	Vibrating Presser Foot, for 204488, 204602 and 204603
204624	13041	Vibrating Presser Foot, for 204488, 204601 and 204607
204625	13041	Vibrating Presser Foot, for 204489 and 204604
204627	13041	Vibrating Presser Foot, for 204488 and 204609
204630	13041	Vibrating Presser Foot, for 204602 and 204603
204631	13041	Vibrating Presser Foot, for 204489 and 204604
229632	13041	Vibrating Presser Foot, for 204488 and 204603

PLATE 10445-FULL SIZE

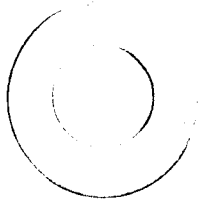
204262



204263



203172



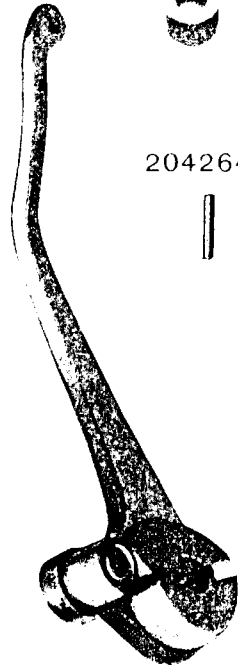
200042



200430



204266



201816

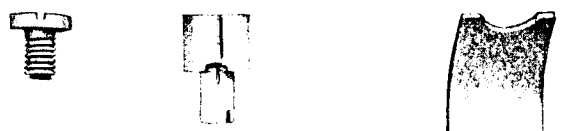


204264

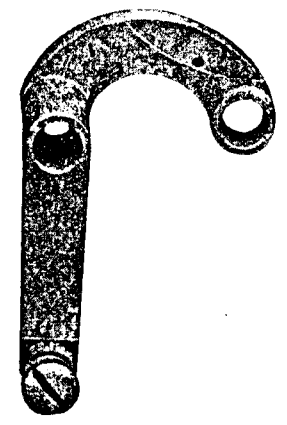


PLATE 10483—FULL SIZE

200181 202088 204486



204475



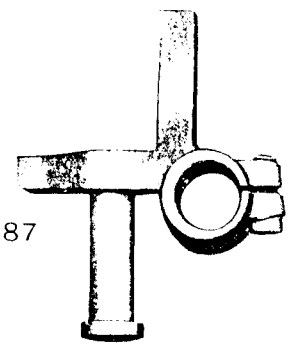
200309



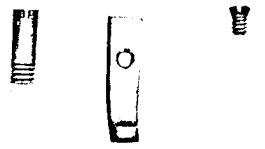
200122 200188



204480



200685 204487 200587

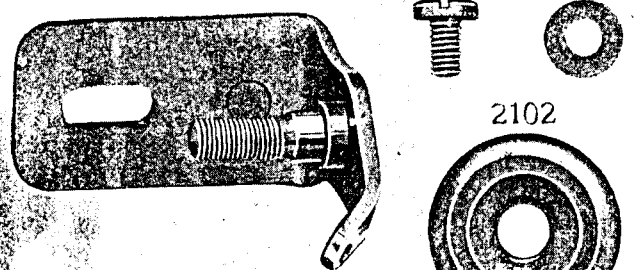


204478

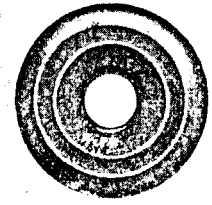


PLATE 10881—FULL SIZE

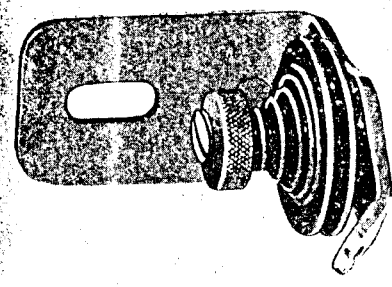
225461 200082 202104



2102



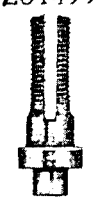
225462



202407



201499



201572



PLATE 10882—FULL SIZE

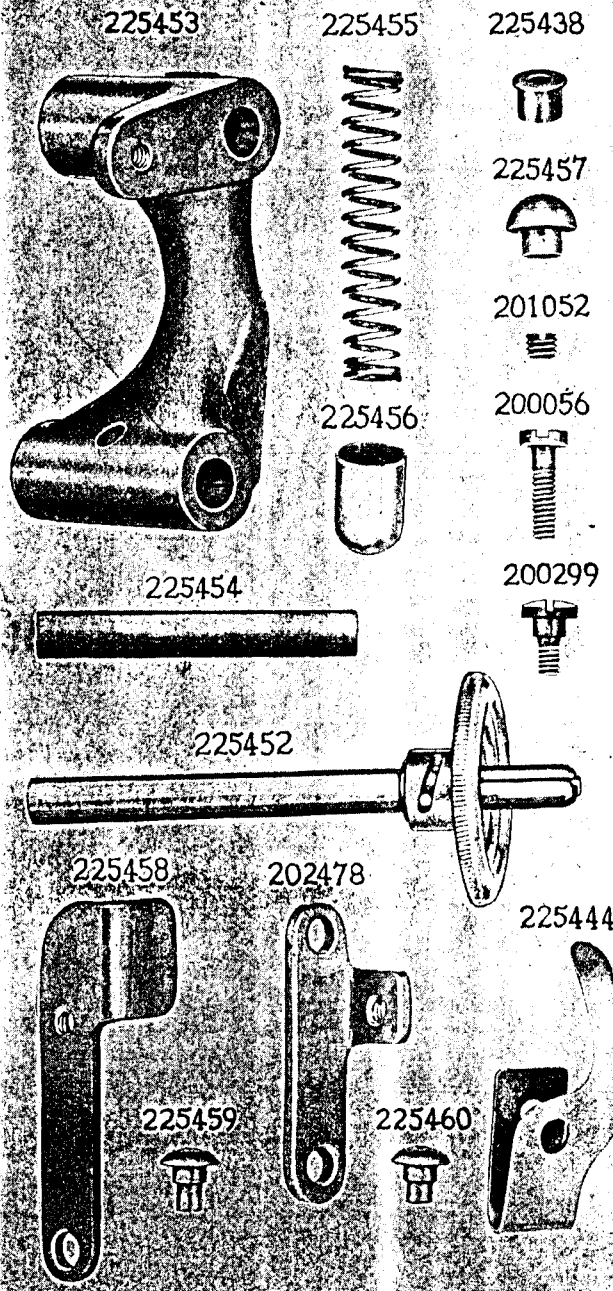


PLATE 10883—ONE-FOURTH SIZE

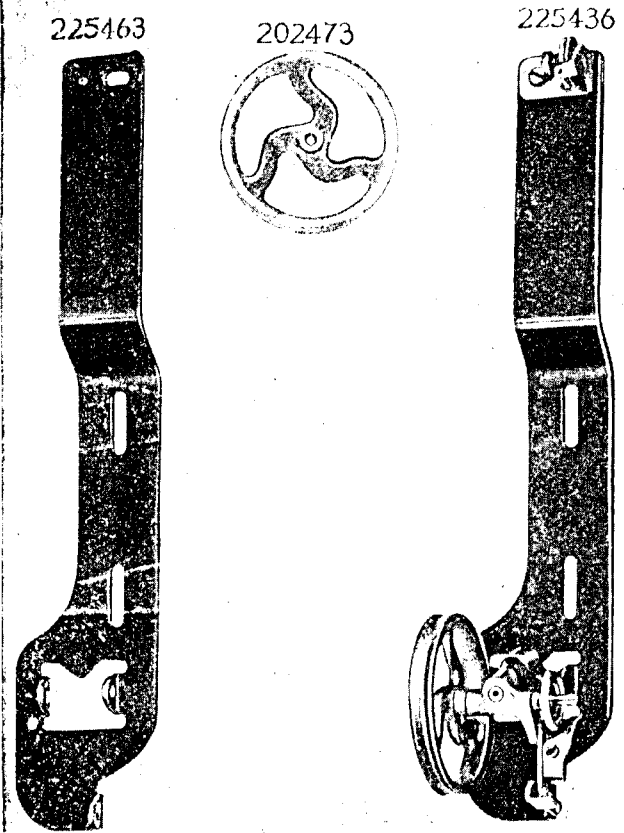


PLATE 11060-FULL SIZE

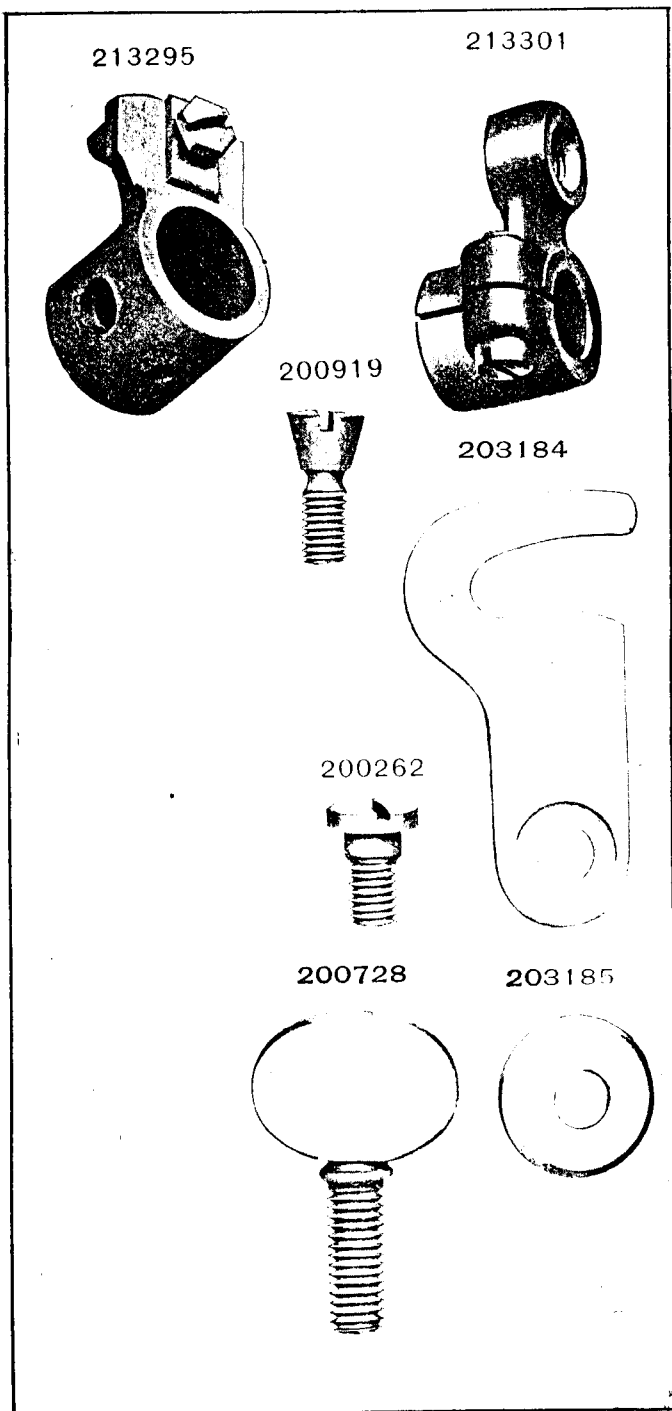


PLATE 11150 -ONE-HALF SIZE

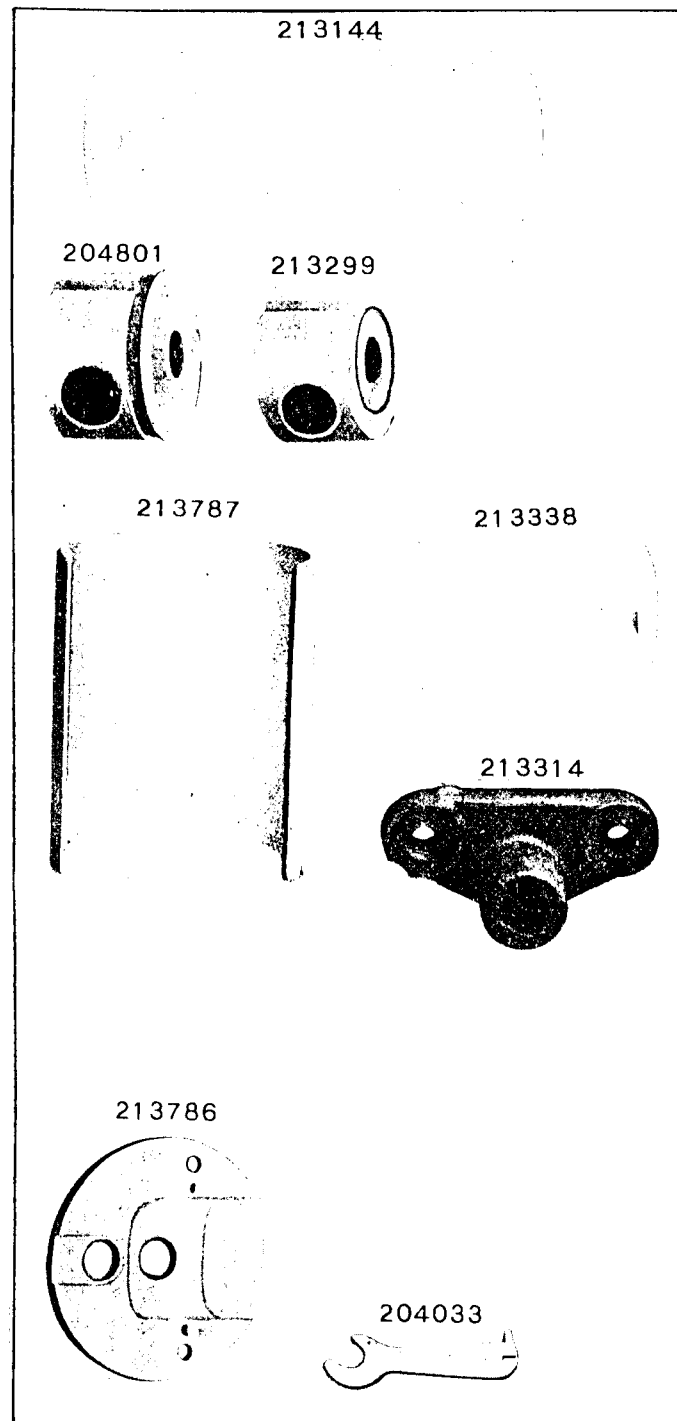


PLATE 11151 - FULL SIZE

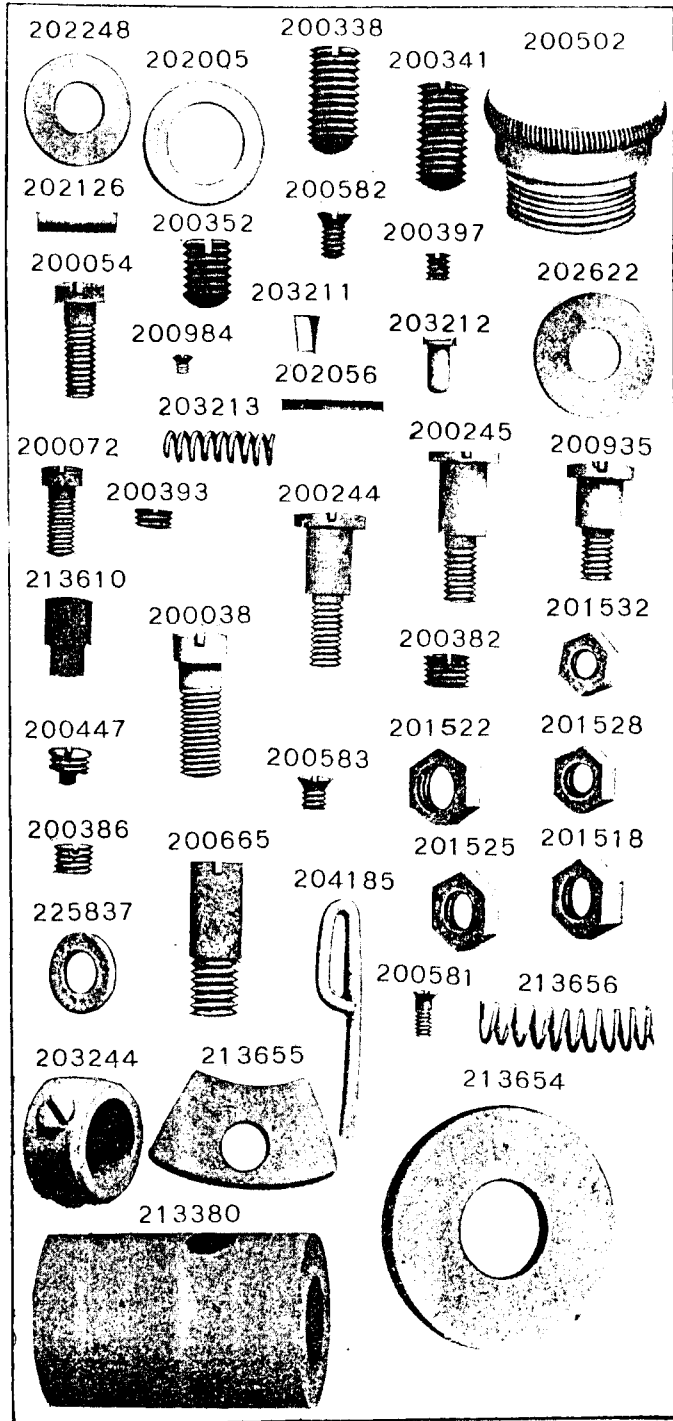


PLATE 11156 - ONE-FOURTH SIZE

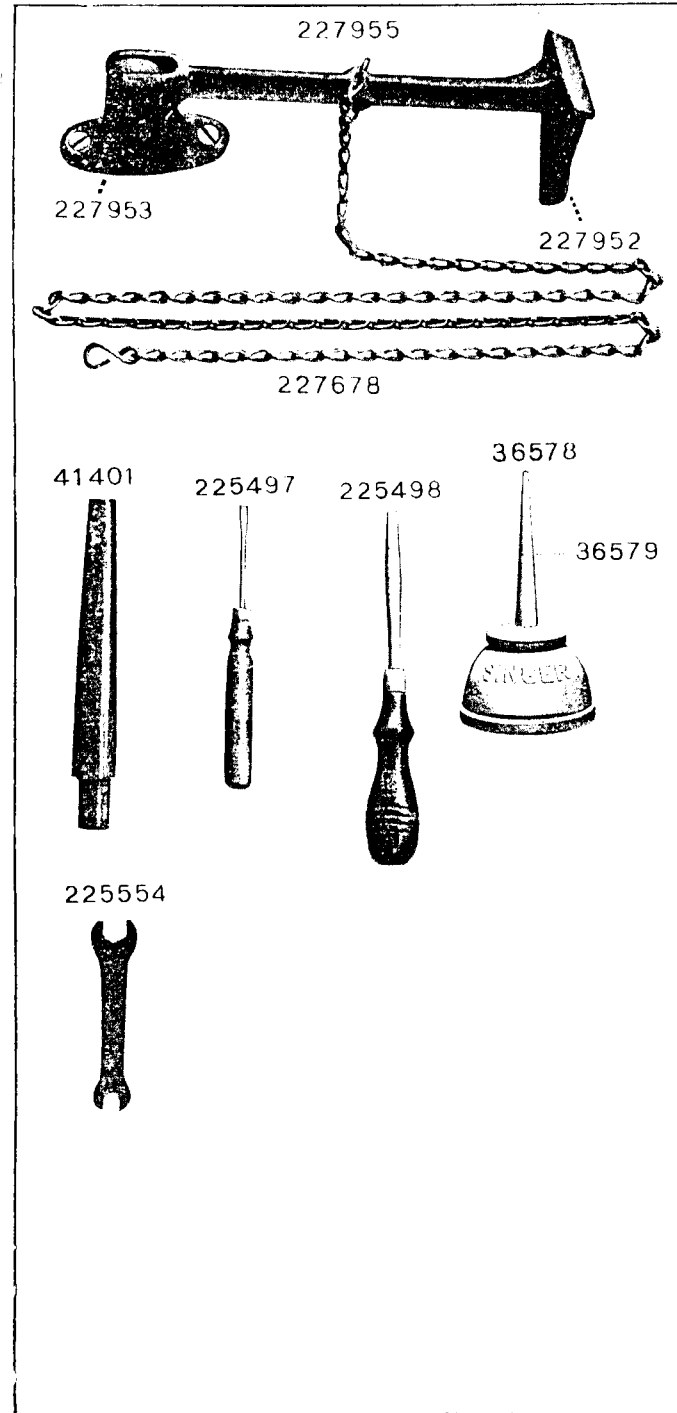


PLATE 11161 - FULL SIZE

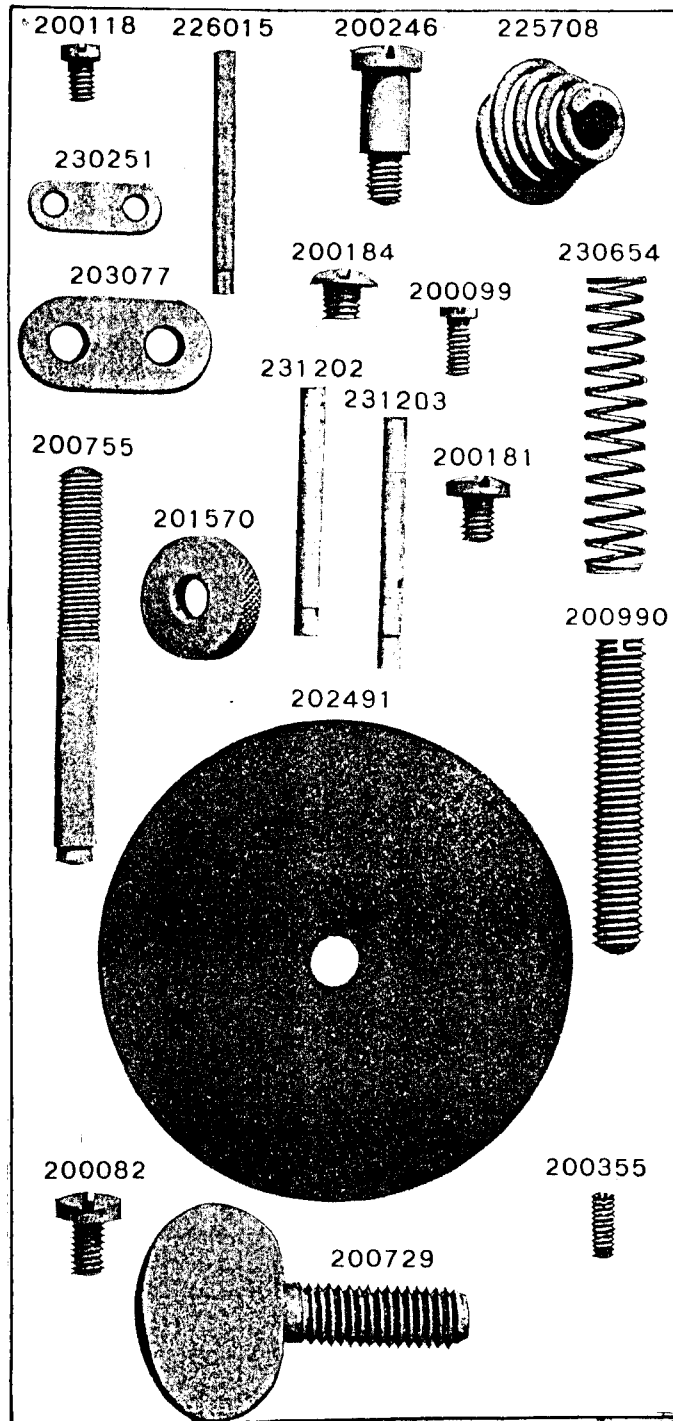


PLATE 11228 - FULL SIZE

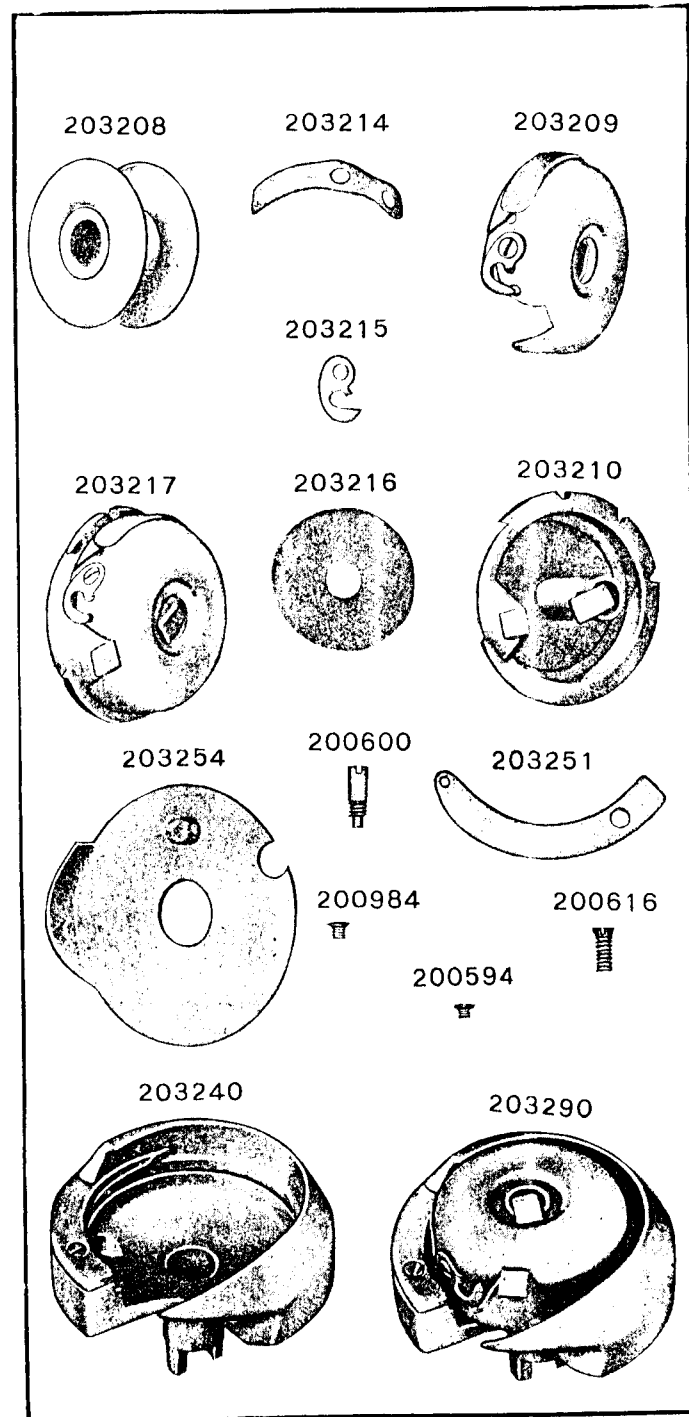


PLATE 11254--ONE-HALF SIZE

203208



203209



203210



203549



203554

Nº 2 OUTFIT

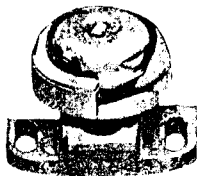
203240



203552



203554



203254



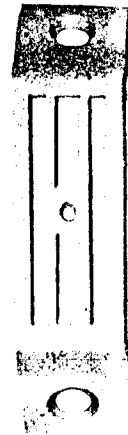
203254



PLATE 12177--FULL SIZE

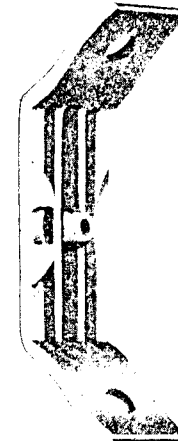
212276

212277

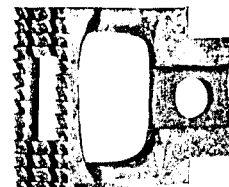


212276

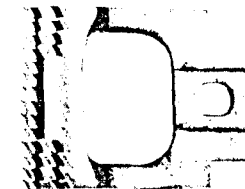
212277



212278

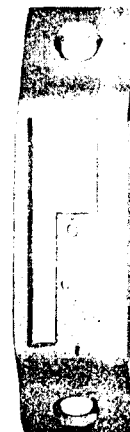


212278

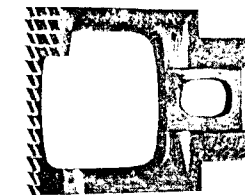


212279

212280



212281



212282

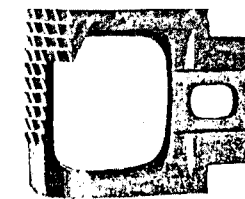


PLATE 12179—FULL SIZE

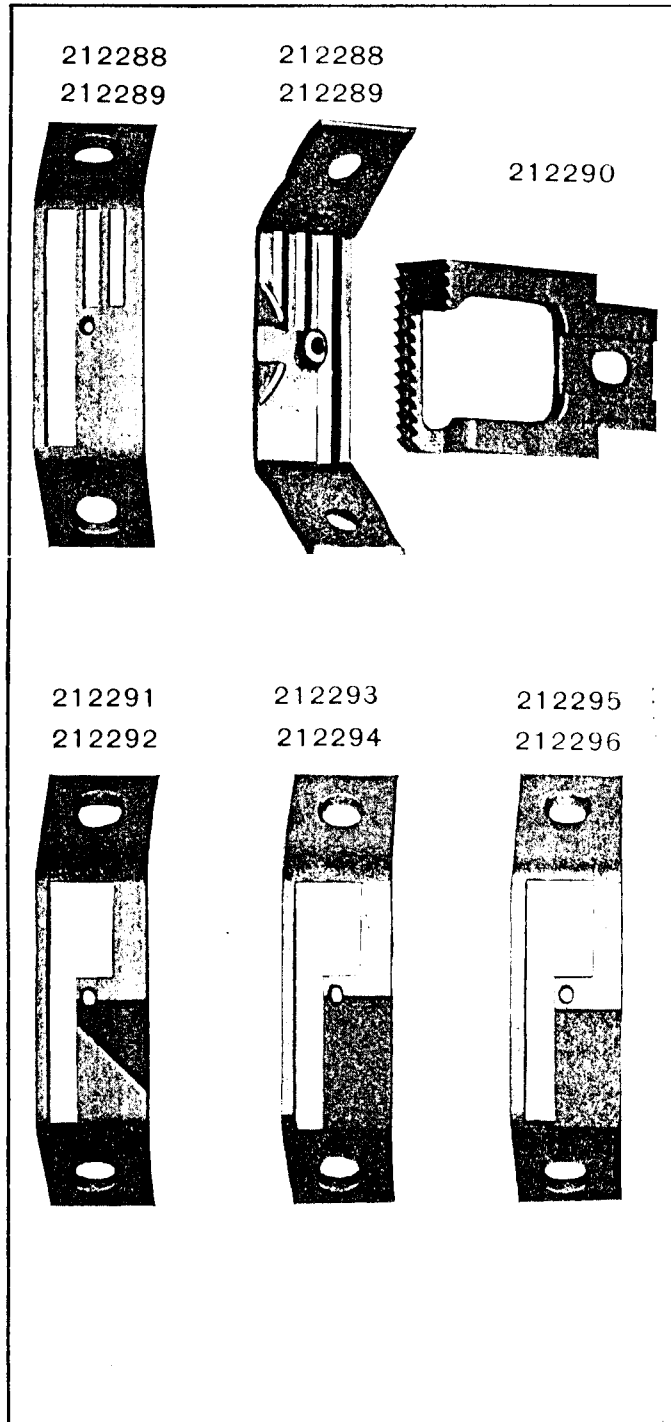


PLATE 12309 —FULL SIZE

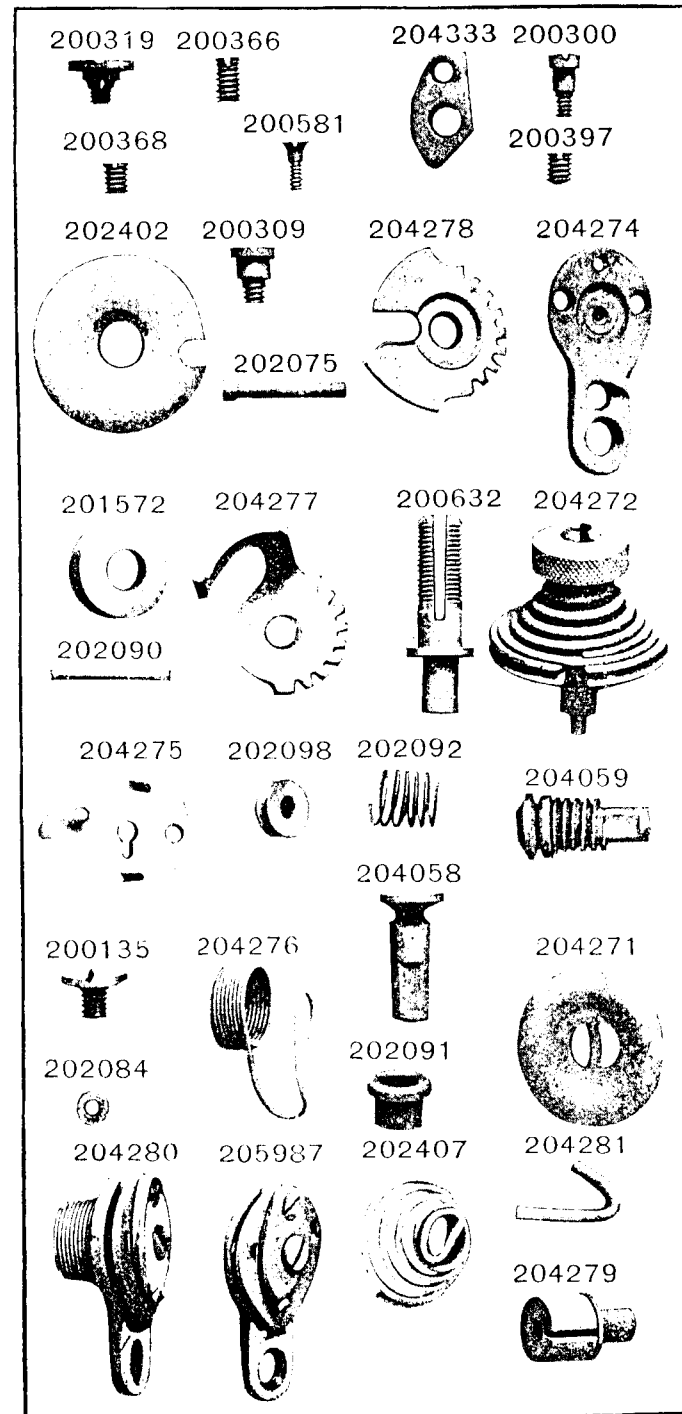


PLATE 12311-FULL SIZE

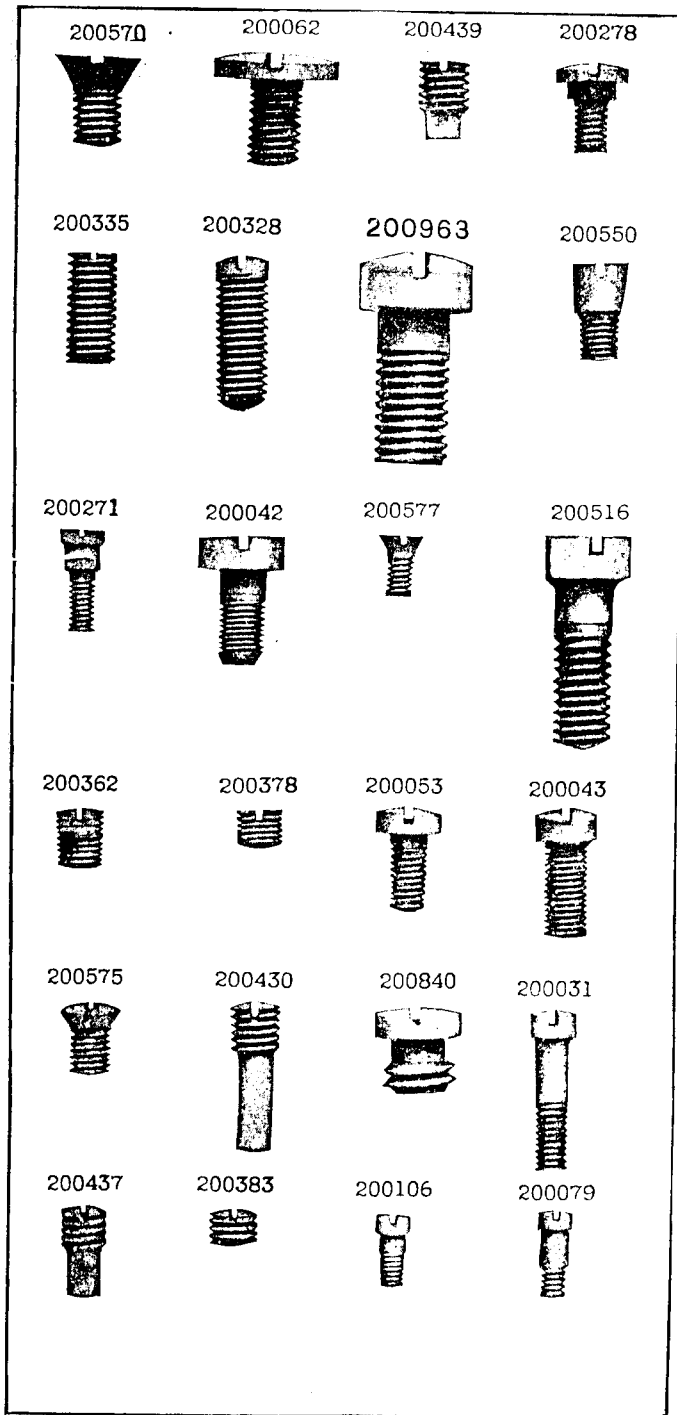


PLATE 12319 -FULL SIZE

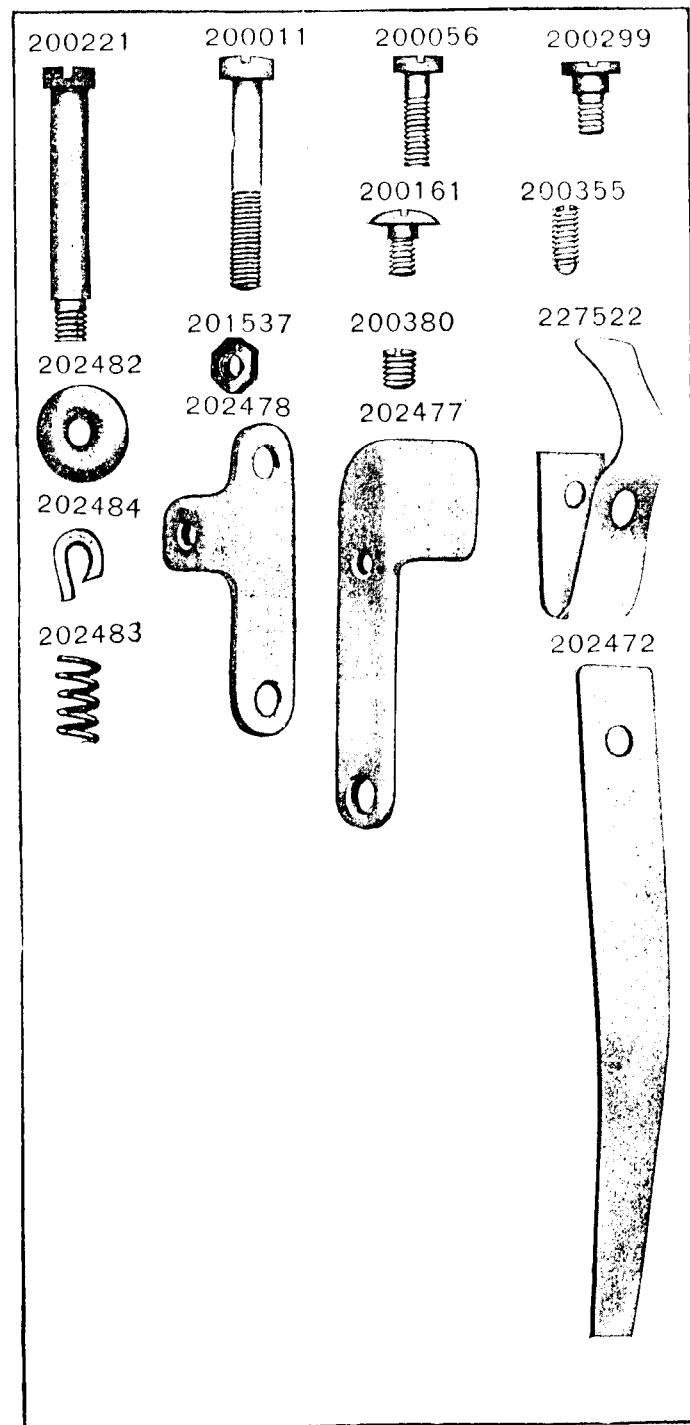


PLATE 12320-ONE-HALF SIZE

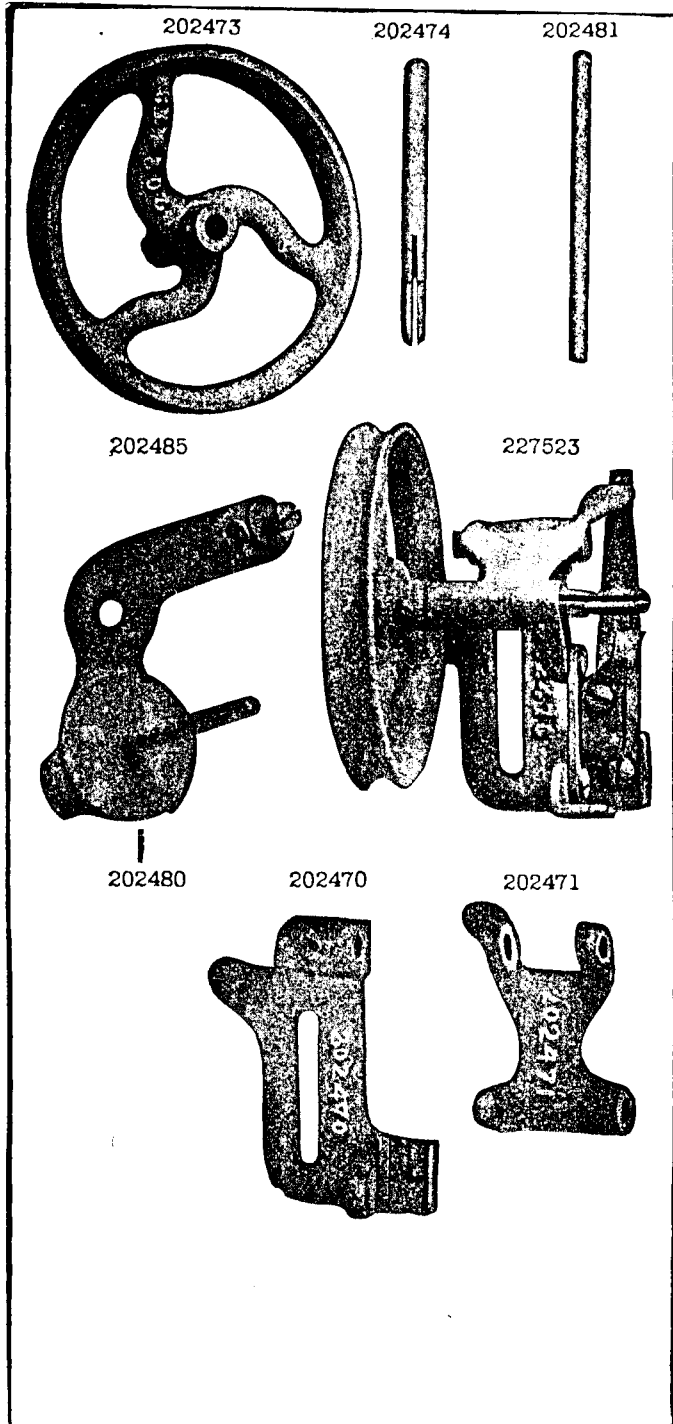


PLATE 12376-FULL SIZE

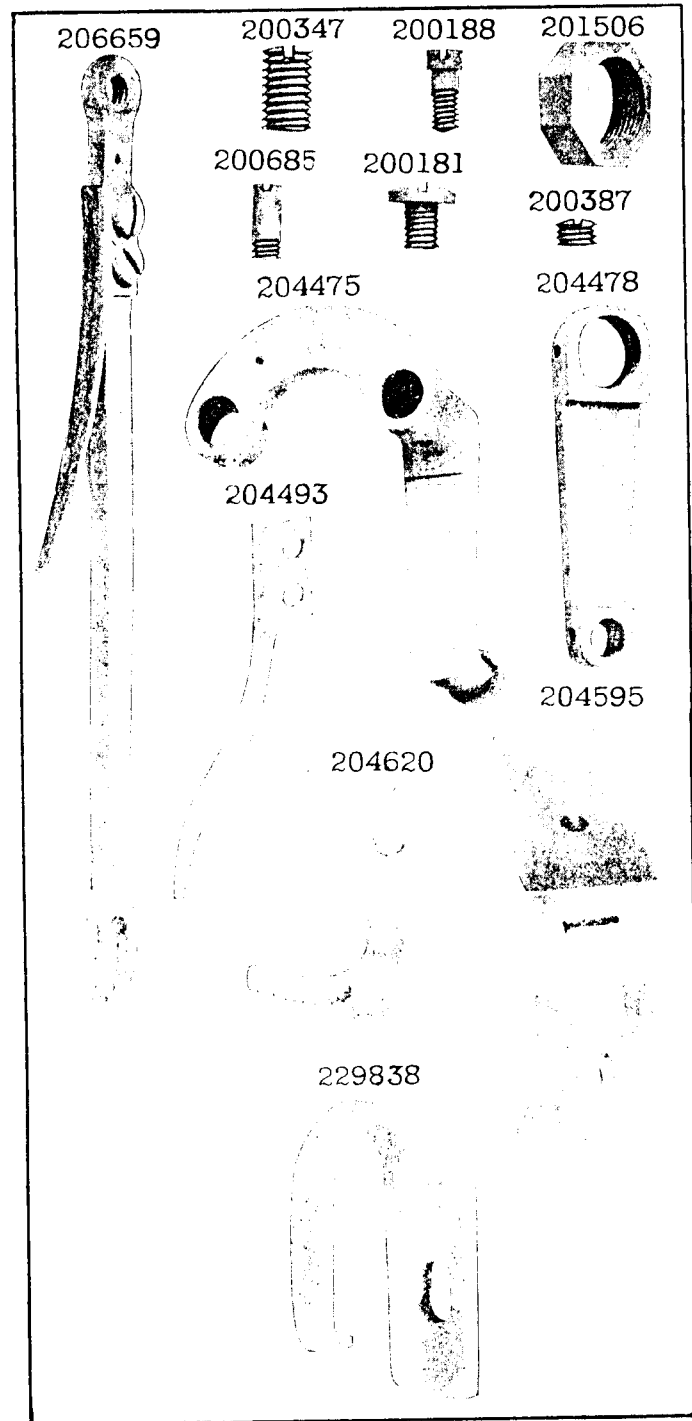


PLATE 12473-FULL SIZE

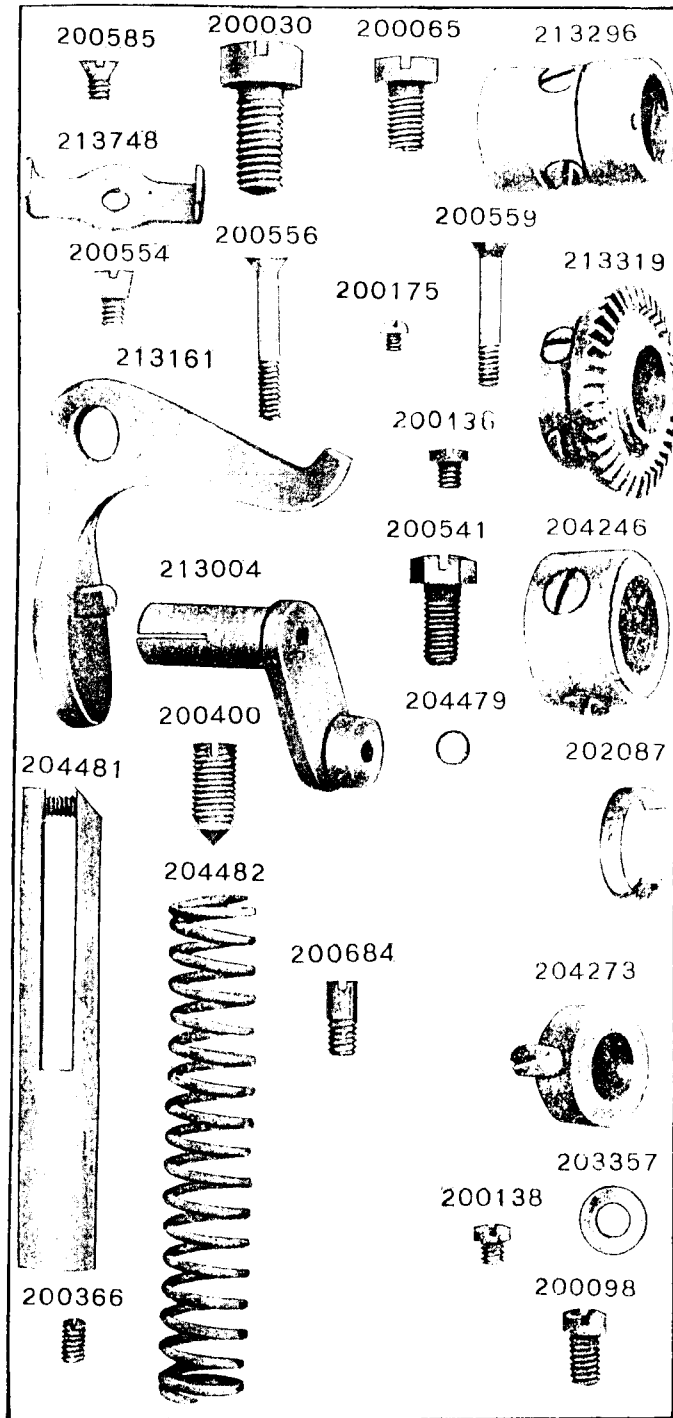


PLATE 12480-ONE-HALF SIZE

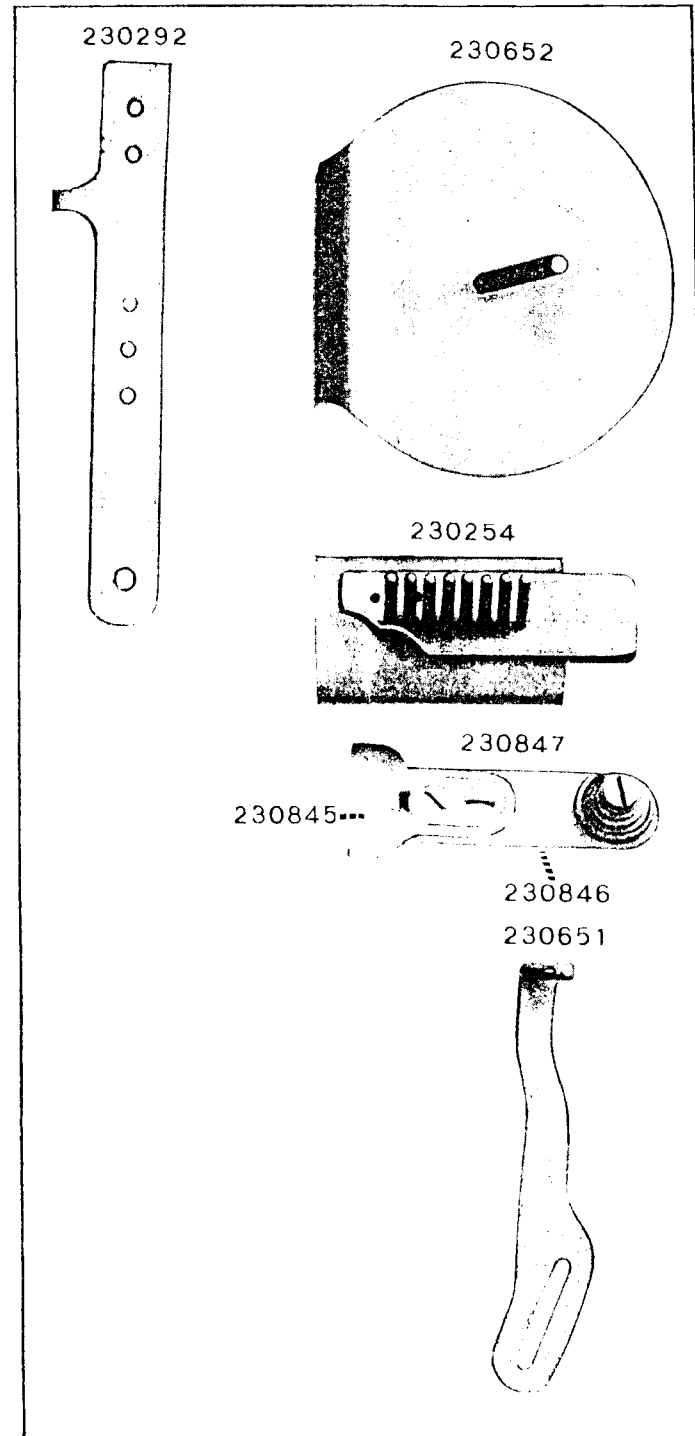


PLATE 12481—FULL SIZE

221145

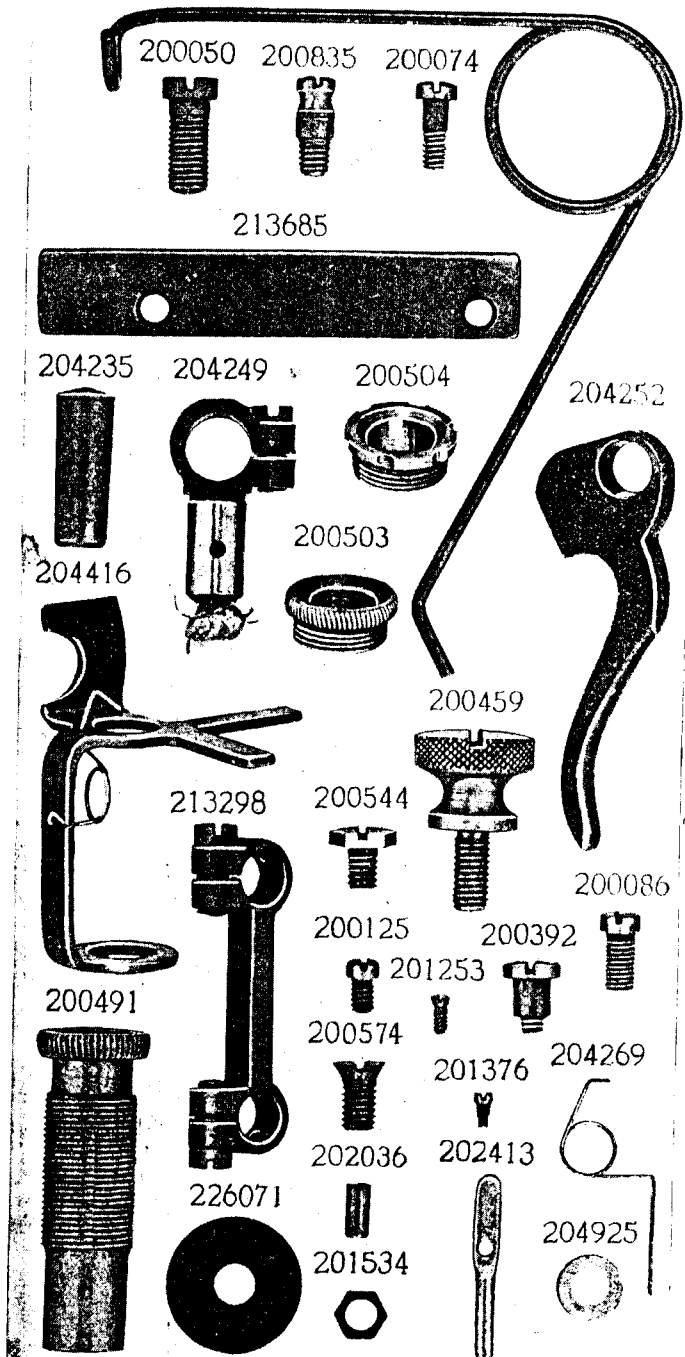


PLATE 12482—ONE-FOURTH SIZE

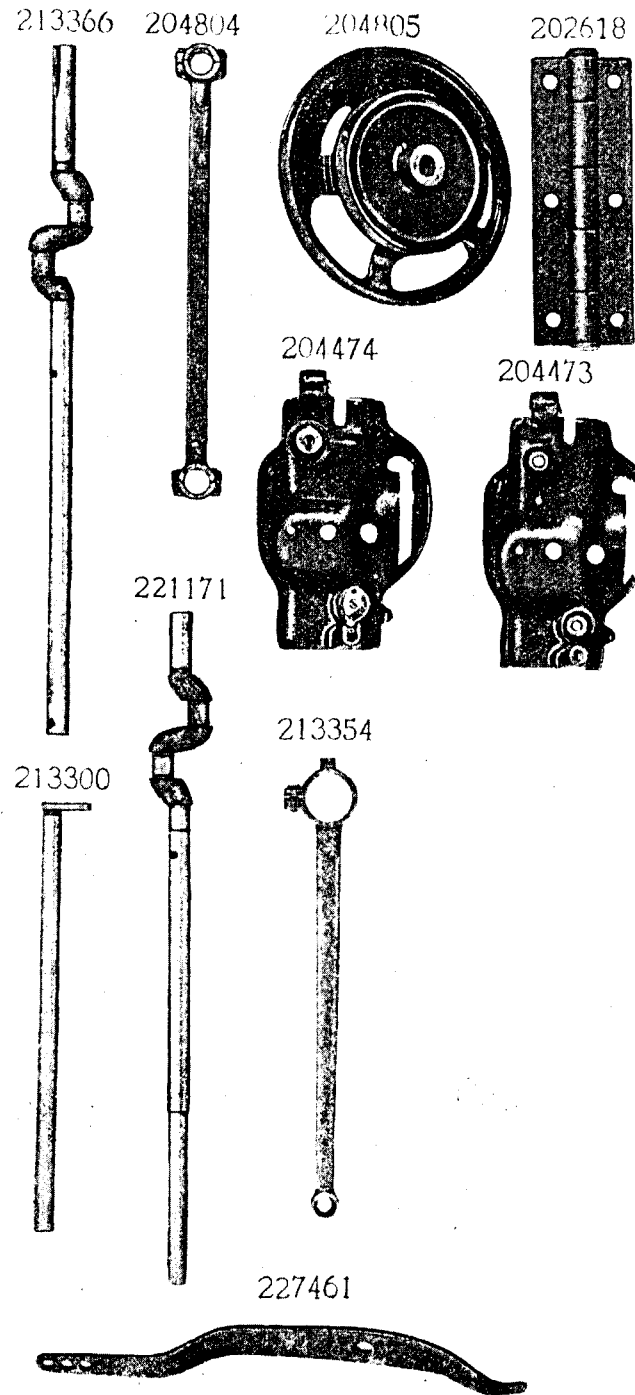


PLATE 12483—ONE-HALF SIZE

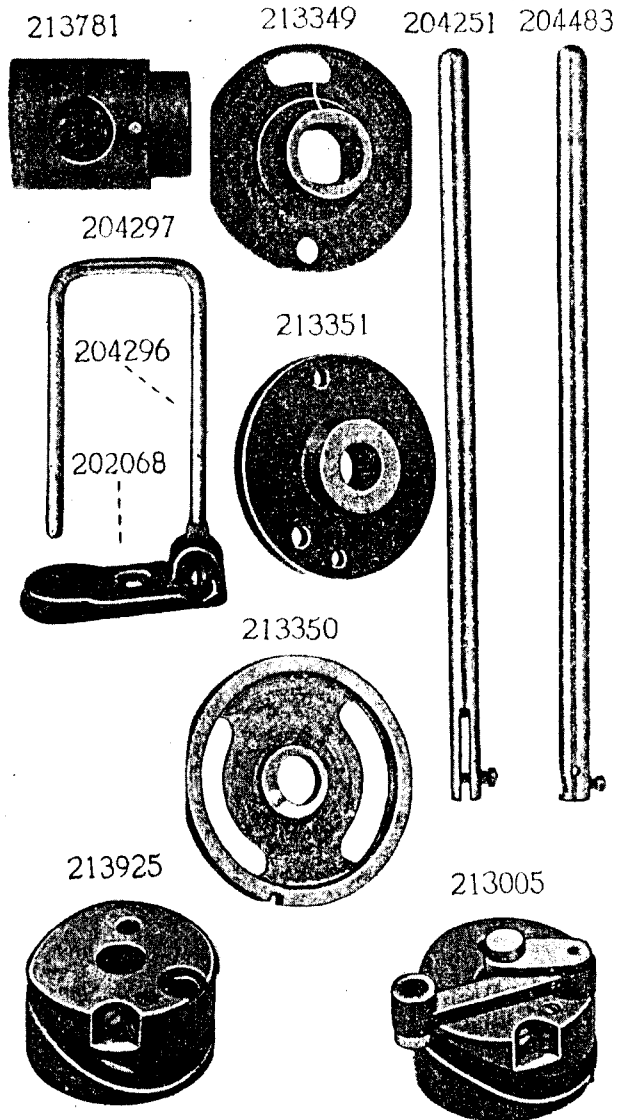


PLATE 12484—FULL SIZE

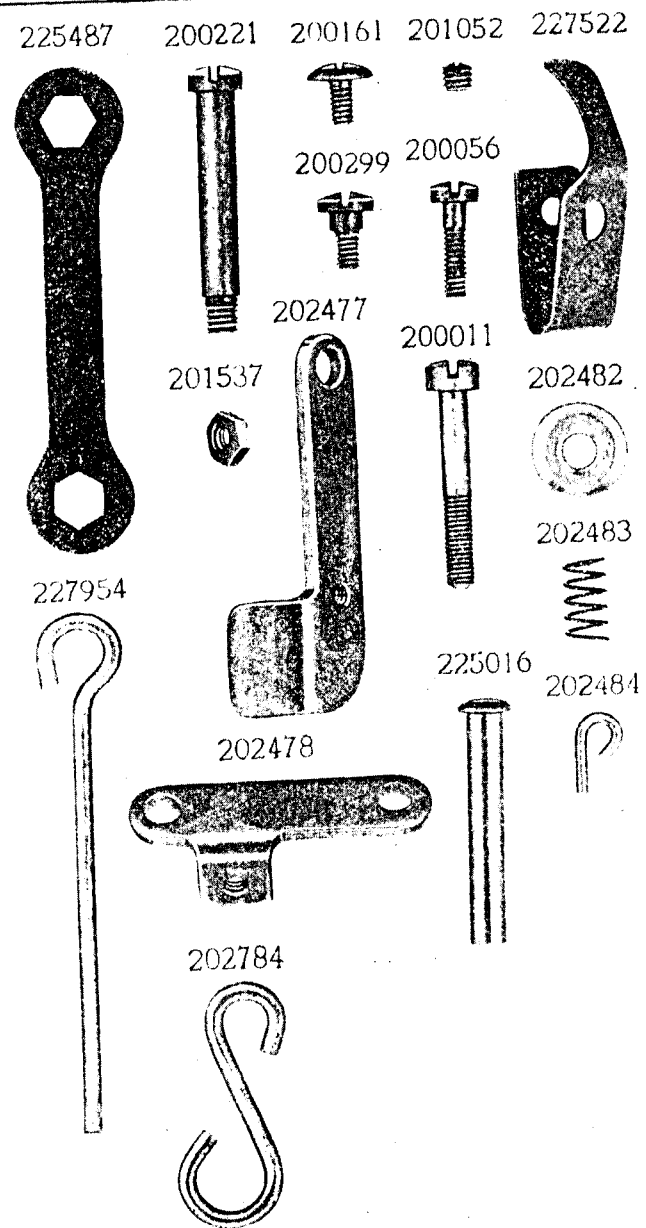
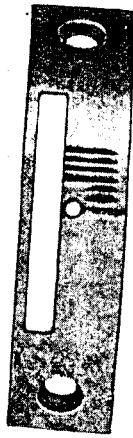


PLATE 12485-FULL SIZE

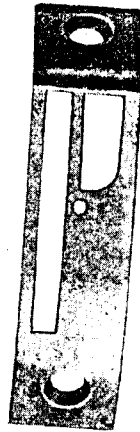
212256
212257



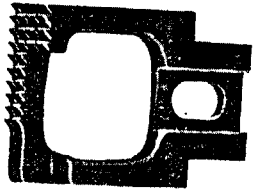
212297



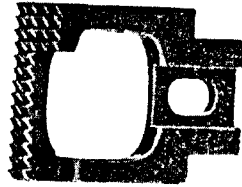
221183



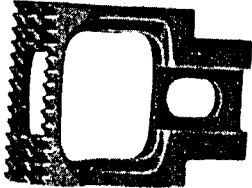
212220



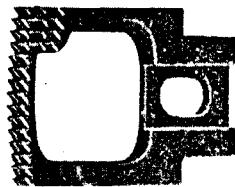
212221



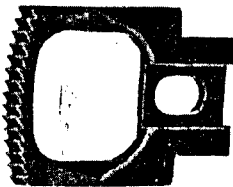
212258



212285



212298



212316

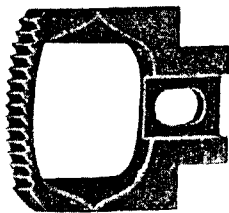


PLATE 12486-FULL SIZE

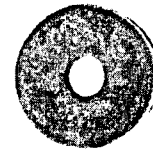
200925



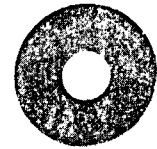
201526



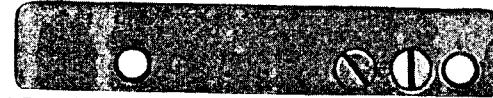
230294



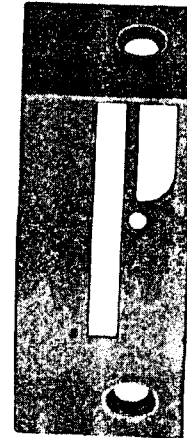
230293



230648



212286
212287



200469



200137



230649



212302



225689



PLATE 13034-FULL SIZE

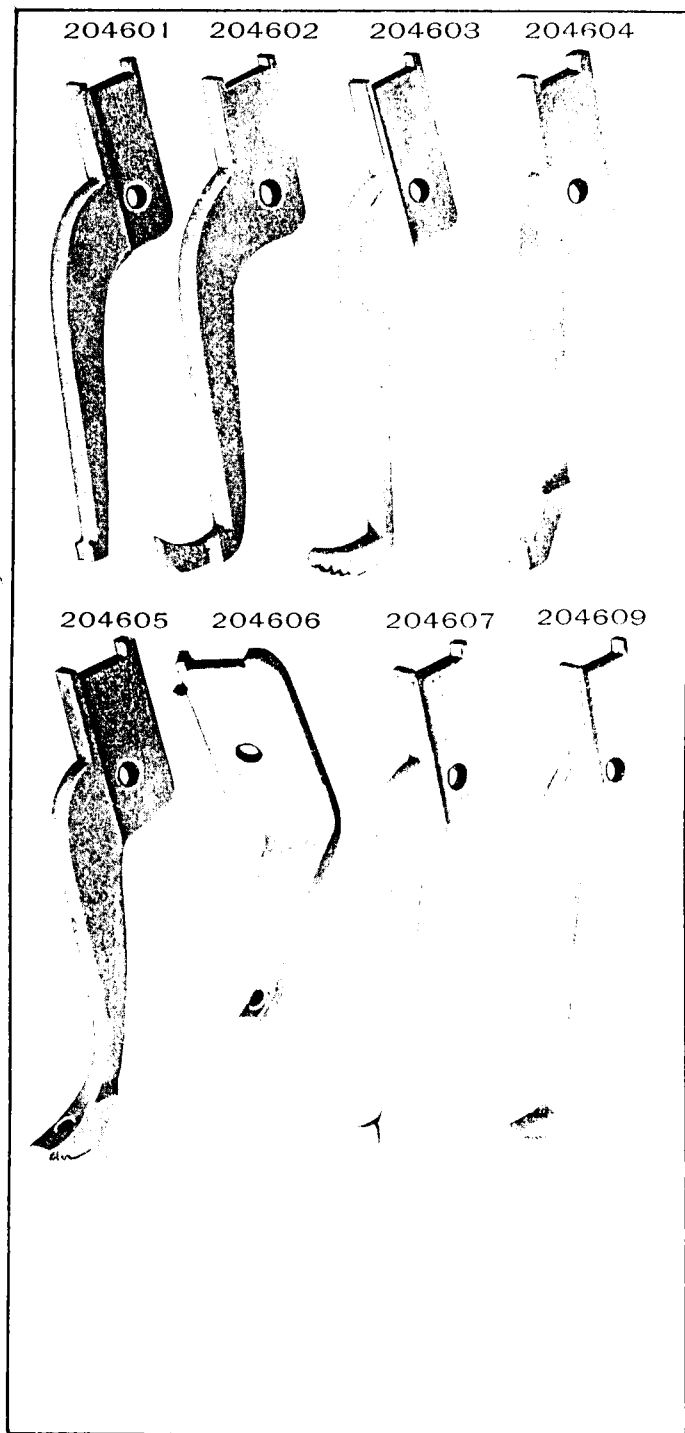


PLATE 13035-FULL SIZE

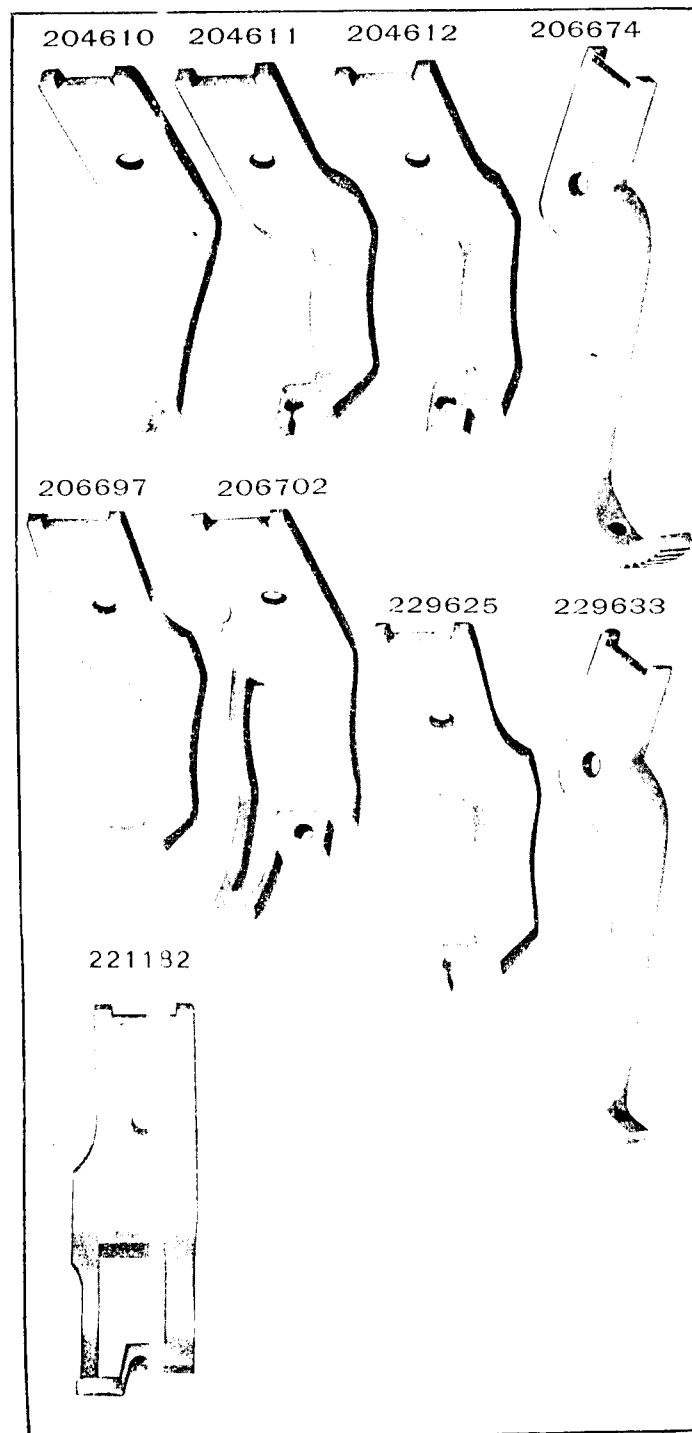


PLATE 13036-FULL SIZE

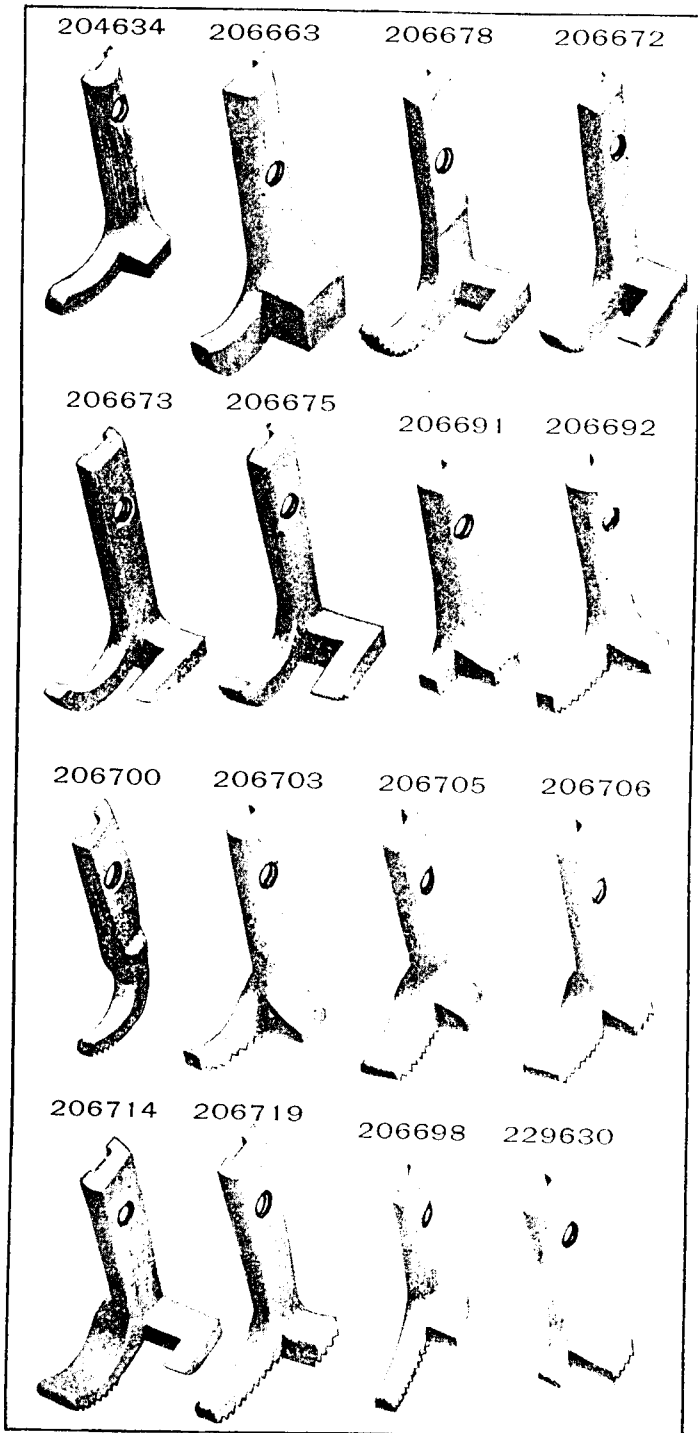


PLATE 13037-FULL SIZE

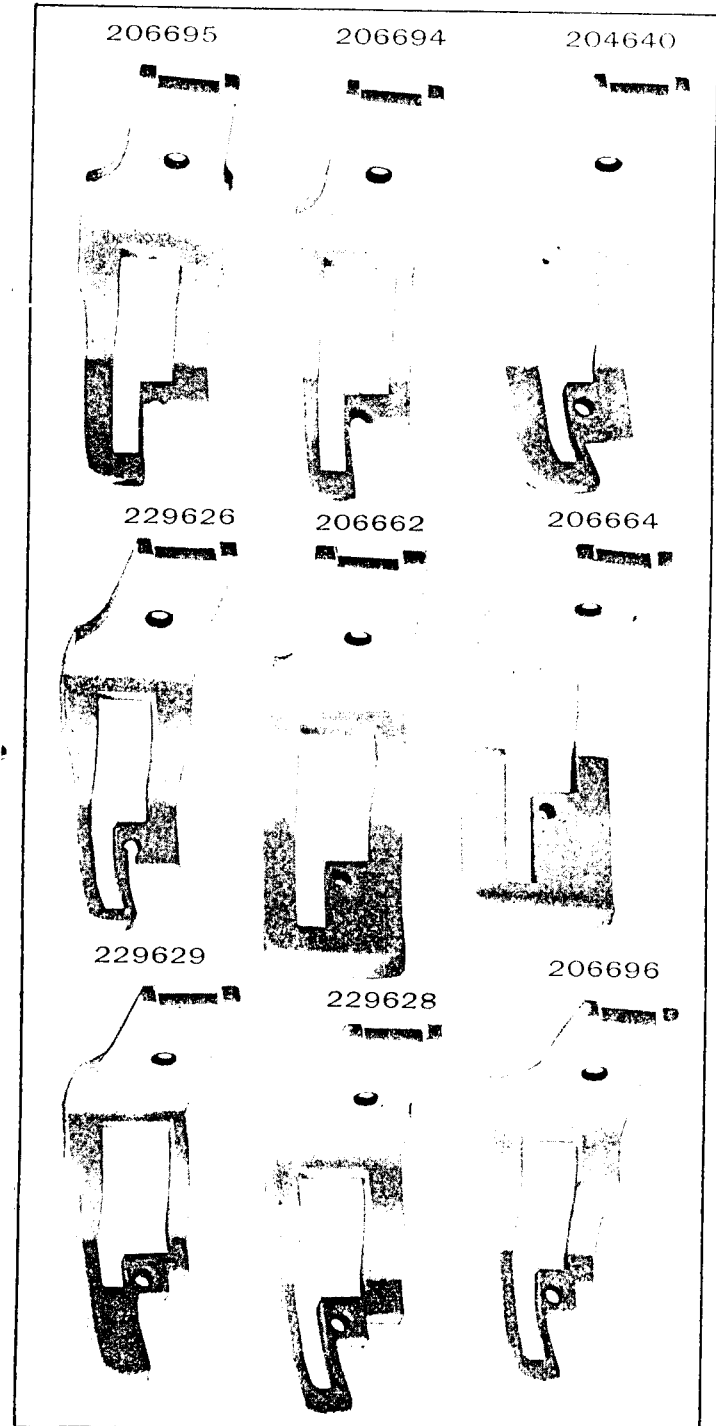


PLATE 13038-FULL SIZE

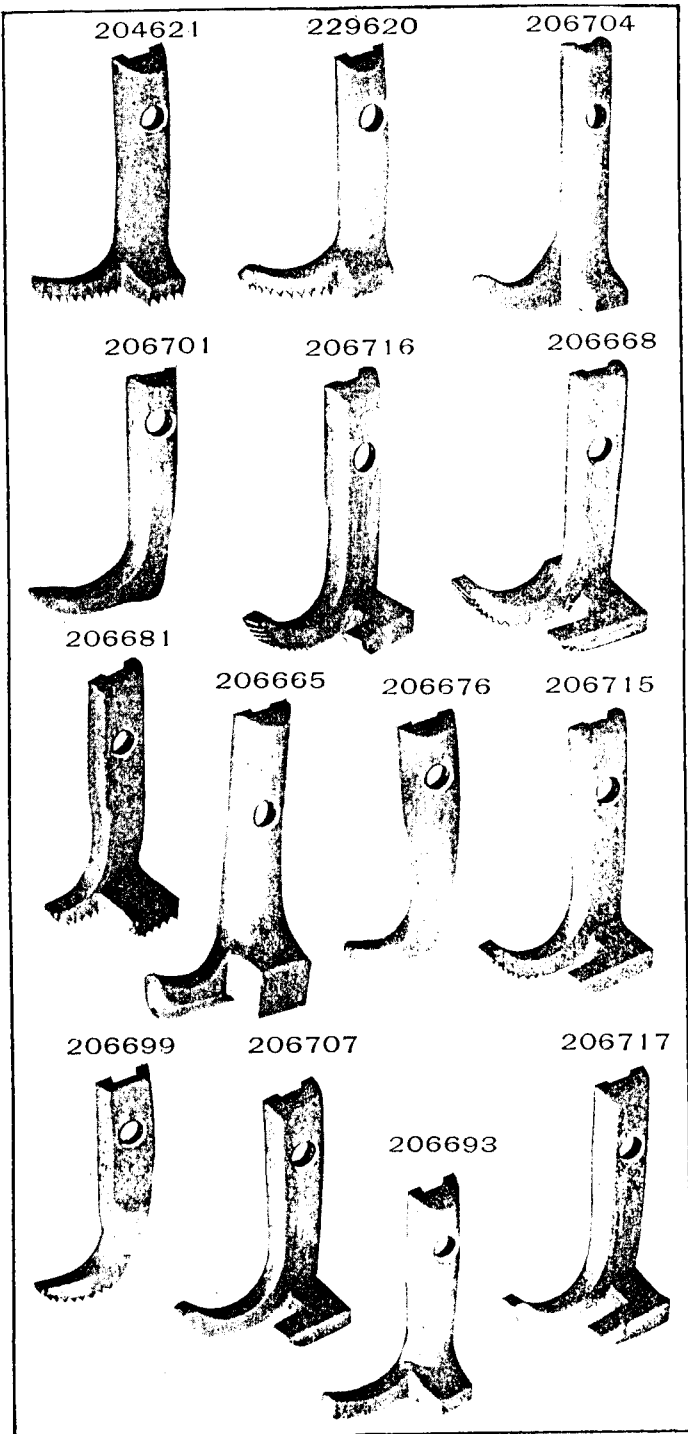


PLATE 13041-FULL SIZE

