

SINGER
400W15

LIST OF PARTS



MACHINE No. 400w15

THE SINGER MANUFACTURING COMPANY

INDEX

	PAGE
ACCESSORIES	13
BELT GUARD	19
BINDERS	15
BOBBIN HOLDER	18
BOBBIN WINDERS	14 & 18
CORDER	19
FINGER GUARD	20
FITTINGS	29
GUIDE	20
HEMMERS	20
KNEE LIFTER	13
MACHINE NO. 400w15	5
MISCELLANEOUS PARTS	25
NUMERICAL LIST OF PARTS	37
PIPING ATTACHMENT	22
PRESSER FEET	22
PULLER FEED	26
THREAD UNWINDER	27
TUCKER	27
WOOD BASE	29

INSTRUCTIONS FOR ORDERING

In ordering from this list, use ONLY the PART number in the FIRST column.

The number stamped on a Sewing Machine Part is the number of the Single Part only, except when the part includes Set Screws, Clamping Screws, Studs and Rollers Spun on, Small Wires riveted, or Parts soldered together, etc., which it is necessary to furnish in combination.

Every combination of parts sent out has its specific number which, although not stamped on Parts (except in above case), must be used when ordering the combination.

Each number always indicates the SAME PART in whatever list it appears, or for whatever Machine.

The letters after some of the numbers indicate the style of finish only, as follows:

- A. Hardened, Polished, Nickel Plated and Buffed.
- B. Polished, Nickel Plated and Buffed.
- C. Hardened only.
- D. Polished only.
- E. Soft, not polished.
- F. Hardened and Polished.
- H. Blued.
- J. Nickel Plated only.
- R. Merlized.
- X. Black Oxide, for Iron and Steel.
- XC. Hardened and Black Oxide, for Iron or Steel.
- Y. Black Nickel Plated only.

These letters MUST BE USED when they appear in the list and AFTER the number, as in the list.

In this series

1 to 1500, 200001 to 201500 and 350001 to 351500 are Screw Numbers.
 1501 to 1800, 201501 to 201800 and 351501 to 351800 are Nut Numbers.
 1801 to 2000, 201801 to 202000 and 351801 to 352000 are Roller Numbers.
 2001 to 50000 and 202001 to 350000 are Numbers of Machine Parts.

The figures in the second column refer only to the plate in which the illustration of the part is shown and are NOT TO BE USED in ordering.

Two or more numbers over a cut indicate that the difference between such parts is not visible in an illustration.

Parts marked with an asterisk (*) are furnished only when repairs are made at the factory.

LIST OF PARTS COMPLETE

FOR

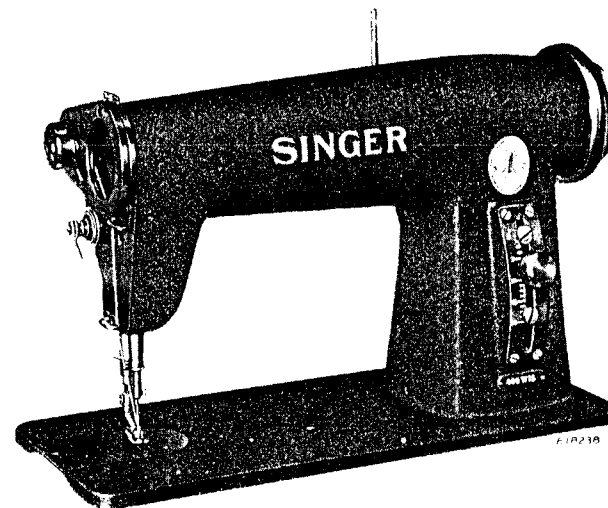

MACHINE No. 400w15

HIGH SPEED

DOUBLE ROTARY DISC TAKE-UP.

SINGLE NEEDLE. LOCK STITCH. DROP FEED.

ONE HAND STITCH REGULATOR.

FOR STITCHING LIGHT AND MEDIUM WEIGHT FABRICS

No.	Plate	Name
*270801	----	Arm
270002	18381	" Cover Plate (back)
200041X	18381	" " " Screw (2)
204235	18381	" Position Pin (2)
350390E	18381	" Screw (long)
200004E	18381	" " (short) (2)
202005	18381	" " Washer (3)
*270084	18371	" Shaft
270177	18371	" " 270084 with 200353C, 200378C, 270005 and 270099
270004	18371	Arm Shaft Ball Bearing (back)
270005	18371	" " " " (front)
270167	18371	" " Connection Belt
270168	18371	" " " " Pulley and Rotary Take-up Driving Pulley with 200363AL, 350492C and three 214206
350492C	18371	Arm Shaft Connection Belt Pulley Position Screw

No.	Plate	Name
200363AL	18371	Arm Shaft Connection Belt Pulley Set Screw
214206	18371	Arm Shaft Connection Belt Pulley Spring Flange
270189	18371	Balance Wheel (aluminum alloy casting) for 5/16" round belt (diam. of belt groove 1-13/16 in.) (rim diam. 4 in.) with 201346AL and 350107AL
270190	18371	Balance Wheel 270189 with 270004
270187	18371	" " (aluminum alloy casting) for "V" belt (outside diam. of belt groove 2.9 in.) (rim diam. 4 in.) with 201346AL and 350107AL
270188	18371	Balance Wheel 270187 with 270004
Note: Balance Wheel 270188 is furnished with this machine unless otherwise specified on order.		
350107AL	18371	Balance Wheel Position Screw
201346AL	18371	" " Set Screw
*270802	-----	Bed
270009	18381	" Slide
270144	18380	Face Plate
350503H	18380	" " Screw (5)
143030	18383	Feed Bar
270012	18383	" " Center (2)
200394C	18383	" " Set Screw
235706	18383	" " Oiling Wick
270138	18383	" " " " Holder
270139	18383	" " " " " 270138 with 235706
52266	18383	Feed Bar Slide Block
52267	18383	" " " " 52266 with 125060
*125060	18383	" " " " Stud
52031	18364	" Dog, 19 teeth (22 teeth to the inch)
50117E	18364	Feed Dog Screw (2)
270805	18383	" Driving Connection
270804	18383	" " " 270803 with 270016
270805	18383	Feed Driving Connection Crank with 200040E
270806	18383	Feed Driving Connection Crank 270805 with 270653
350507C	18383	Feed Driving Connection Crank Hinge Screw
201531E	18383	Feed Driving Connection Crank Hinge Screw Nut
270653	18383	Feed Driving Connection Crank Needle Bearing
200040E	18383	Feed Driving Connection Crank Pinch Screw
270807	18383	Feed Driving Connection Link
270808	18383	" " " " Hinge Pin
200394C	18383	" " " " " " Set Screw
270016	18383	Feed Driving Connection Needle Bearing

No.	Plate	Name
270809	18382	Feed Driving Eccentric with 200382C and 201220C
201220C	18382	Feed Driving Eccentric Position Screw
200382C	18382	" " " " Set Screw
270021	18383	" " " " Rock Shaft with two 200394C
270022	18383	Feed Driving Rock Shaft Center (2)
350277C	18383	" " " " " " Set Screw (2)
270827	18383	Feed Lifting Connection
270828	18383	" " " " 270827 with 270016
270015	18383	Feed Lifting Connection Crank with 200040E
200040E	18383	Feed Lifting Connection Crank Pinch Screw
200545C	18383	Feed Lifting Connection Hinge Screw
201522E	18383	" " " " " " Nut
270016	18383	" " " " Needle Bearing
270023	18382	" " " " Eccentric with 200382C and 201220C
201220C	18382	Feed Lifting Eccentric Position Screw
200382C	18382	" " " " Set Screw
270024	18383	" " " " Rock Shaft with 52267
270027	18383	" " " " Center (2)
350277C	18383	" " " " " " Set Screw (2)
270045	18306	Knee Lifter Lifting Link
270285	18381	" " " " " " Connection
200427C	18381	" " " " " " " Set Screw
200293C	18306	Knee Lifter Lifting Link Hinge Screw
270094	18381	" " " " " " Rod
270048	18381	" " " " " " Connection
200434C	18381	" " " " " " " " Set Screw
270049	18381	Knee Lifter Rock Shaft with 200427C and 200434C
270050	18306	Needle Bar with 350445F
270124	18306	" " Bushing (lower)
270261	18306	" " " " (upper)
350499AL	18306	" " " " " " Set Screw
270053	18306	" " Connecting Link
270054	18306	" " " " " " 270053 with 270043
270055	18306	Needle Bar Connecting Link Guide Block
200054E	18306	" " " " " " " " Screw (2)
270143	18306	Needle Bar Connecting Link Hinge Stud with 222598 and 270161
222598	18306	Needle Bar Connecting Link Hinge Stud Oil Packing (wick)
200374C	18371	Needle Bar Connecting Link Hinge Stud Set Screw
270043	18306	Needle Bar Connecting Link Needle Bearing

No.	Plate	Name
270100	18306	Needle Bar Connecting Link Thrust Washer
270057	18306	Needle Bar Connecting Stud with 200086C and 202330
202330	18306	Needle Bar Connecting Stud Oil Packing (wick)
200086C	18306	Needle Bar Connecting Stud Pinch Screw
*270099	18371	" " Crank with 200374C
200333C	18371	" " " Position Screw
200378C	18371	" " " " Check Screw
270058	18306	Needle Bar Oiling Felt
350445F	18306	" Set Screw
270059	18306	Presser Bar with 176J
270060	18306	" " Bushing
270061	18306	" " Lifter
350442C	18306	" " Hinge Screw
270062	18306	" " Lifting Releasing Lever Bracket
270095	18306	Presser Bar Lifting Releasing Lever Bracket Spring
270063	18306	Presser Bar Position Guide with 200196E and 350411C
350411C	18306	Presser Bar Position Guide Pinch Screw
270064	18381	" " Spring
350435C	18381	" " " Screw (pressure regulating)
350499XC	18381	Presser Bar Spring Screw Stud
62527	18364	" Foot Hinge Pin
62925	18364	" " Plate
62926	18364	" " Shank
26231	18364	" " Spring
62927	18364	Presser Foot (spring hinged) complete, Nos. 26231, 62527, 62925 and 62926
176J	18306	Presser Foot Screw
270826	18380	Rotary Take-up (large)
270161	18306	" " " Position Pin
401D	18380	" " " Screw (2)
271032	18380	" " " Thread Guide
270906	18378	" " (small) with 270147 and 350418C
270068	18378	Rotary Take-up (small) Driving Shaft
270032	18378	" " " " "
270069	18378	Ball Bearing (2)
270072	18378	Rotary Take-up (small) Driving Shaft Connection Belt
200382C	18378	Rotary Take-up (small) Driving Shaft Pulley with two 200382C
350418C	18378	Rotary Take-up (small) Driving Shaft Pulley Set Screw
270147	18378	Rotary Take-up (small) Set Screw
270148	18380	" " " Thread Cast-off Pin
270148	18380	Rotary Take-up Guard

No.	Plate	Name
350503H	18380	Rotary Take-up Guard Screw (3)
270868	18379	Rotating Hook with 143301 and two 1253AL
270869	18379	Rotating Hook 270868 with 270874 and four 1053E
270870	18379	Rotating Hook 270869 with 270872, 270876 and three 1367E
270871	18379	Rotating Hook 270870 with 52237
270010	18379	" " Bobbin
52235	18379	" " Case
52236	18379	" " " 52235 with 591F, 1380E and 40394
40393	18379	Rotating Hook Bobbin Case Hinge Nos. 2974, 40392 and 125320
270872	18379	Rotating Hook Bobbin Case Holder (chromium plated)
52018	18379	Rotating Hook Bobbin Case Holder Position Bracket
200077D	18379	Rotating Hook Bobbin Case Holder Position Bracket Screw
40392	18379	Rotating Hook Bobbin Case Latch
125320	18379	" " " " " " Lever
2974	18379	" " " " " " "
2975	18379	Fulcrum Pin
592E	18379	Rotating Hook Bobbin Case Latch Spring
40394	18379	" " " " " " Stop Screw
591F	18379	Rotating Hook Bobbin Case Tension Spring
1380E	18379	Rotating Hook Bobbin Case Tension Spring Regulating Screw
52237	18379	Rotating Hook Bobbin Case Tension Spring Screw
270873	18379	Rotating Hook Bobbin Case complete, Nos. 592E, 2975, 40393 and 52236
270813	18382	Rotating Hook Bobbin Case 52237 with 270872
270032	18382	Rotating Hook Driving Shaft
271062	18382	" " " " " Ball Bearing
222598	18382	Rotating Hook Driving Shaft Bushing
200362C	18382	Rotating Hook Driving Shaft Bushing with 222598
270169	18382	Rotating Hook Driving Shaft Bushing Oil Packing (wick)
200070C	18382	Rotating Hook Driving Shaft Bushing Set Screw
214206	18382	Rotating Hook Driving Shaft Connection Belt Pulley with 214206 and two 200070C
270035	18382	Rotating Hook Driving Shaft Connection Belt Pulley Set Screw
214206	18382	Rotating Hook Driving Shaft Connection Belt Pulley Spring Flange
270035	18382	Rotating Hook Driving Shaft Gear (internal teeth) with 200382C and 201220C

No.	Plate	Name
201220C	18382	Rotating Hook Driving Shaft Gear Position Screw
200382C	18382	Rotating Hook Driving Shaft Gear Set Screw
270036	18382	Rotating Hook Driving Shaft Oil Lead Wire
270038	18381	Rotating Hook Oil Reservoir Cover
270039	18381	" " " " "
200041X	18381	Gasket Rotating Hook Oil Reservoir Cover Screw (6)
270155	18382	Rotating Hook Oil Reservoir Oil Gauge
143301	18379	" " " Wick (felt)
270876	18379	" " Section
1367E	18379	" " Screw
1253AL	18379	" " Set Screw
270162	18382	" " Shaft
270163	18382	" " Bushing
268258	18382	" " " " Oil Packing (wick)
350277C	18382	Rotating Hook Shaft Bushing Set Screw
270164	18382	" " " End Bearing
201215D	18382	" " " " Screw (?)
202423	18382	" " " Oil Filter Wick
143349	18382	" " " " "
270176	18382	Holder Rotating Hook Shaft Oil Filter complete, Nos. 143349 and 202423
350498E	18382	Rotating Hook Shaft Oil Regulating Screw
270044	18382	Rotating Hook Shaft Thrust Washer
270166	18382	Rotating Hook Shaft Bushing complete, Nos. 268258, 270044, 270162 to 270164, 270176, 350498E and two 201215D
270874	18379	Rotating Hook Thread Guard
1053E	18379	" " " " Screw
202248	18383	Stitch Regulating Adjusting Screw Washer
270815	18383	Stitch Regulating Adjusting Screw Washer (leather)
350508X	18383	Stitch Regulating Adjusting Thumb Screw
270816	18383	Stitch Regulating Index Plate
270829	18383	" " " " 270816 with two each 200996C and 270819
691F	18383	Stitch Regulating Index Plate Screw (4)
270317	18383	Stitch Regulating Lever
270818	18383	" " " Connection
350509C	18383	" " " " Hinge Screw (2)
201520H	18383	Stitch Regulating Lever Connection Hinge Screw Nut (2)
204020	18383	Stitch Regulating Lever Cushion (leather)

No.	Plate	Name
203850H	18383	Stitch Regulating Lever Hinge Screw
270819	18383	" " " Stop Block with 204020
200996C	18383	Stitch Regulating Lever Stop Block Screw
270820	18383	Stitch Regulating Shaft
270821	18383	" " " Bushing (split)
200043C	18383	Stitch Regulating Shaft Bushing Set Screw
201524E	18383	Stitch Regulating Shaft Bushing Set Screw Nut
270822	18383	Stitch Regulating Shaft Crank with 200040E
270823	18383	Stitch Regulating Shaft Crank 270822 with two 270853
270825	18383	Stitch Regulating Shaft Crank Hinge Stud
200394C	18383	Stitch Regulating Shaft Crank Hinge Stud Set Screw
270824	18383	Stitch Regulating Shaft Crank Link with two 200394C
270653	18383	Stitch Regulating Shaft Crank Needle Bearing
200040E	18383	Stitch Regulating Shaft Crank Pinch Screw
2102	18380	Tension Disc
270076	18306	" Releaser (adjustable)
200132E	18306	" " Screw
32572	18380	" Releasing Disc
270086	18380	" " Pin
13710	18380	" Spring
50304C	18380	" Stud
52098	18380	" " 50304C with 1560C
50305C	18380	" " Set Screw
1560C	18380	" Thumb Nut
270087	18380	Tension complete, Nos. 13710, 32572, 52082, 52083, 52098, 270086 and two 2102
270096	18380	Thread Guide
236245	18380	" " (lower)
270077	18306	" " (on needle bar bushing)
350503H	18380	" " Screw (2)
270079	18306	" Pull-off
200196E	18306	" " Set Screw
270080	18380	" Retainer
200355H	18380	" " Set Screw
270150	18380	" Severing Finger
270151	18380	" " " Guard
350486XC	18380	" " " " Hinge Screw
270156	18380	" " " " " "
200567H	18380	Spring Washer
52082	18380	Thread Severing Finger Screw
52083	18380	" Take-up Spring
		" " " Regulator with 50305C

No.	Plate	Name
446C	18380	Thread Take-up Spring Regulator Set Screw
143272XC	18364	Throat Plate (medium needle hole)
691F	18364	" " Screw (2)

Genuine SINGER Needles should be used in SINGER Machines. These Needles and their Containers are marked with the Company's Trade-Mark "SIMANCO." 1

Needles in Containers marked "FOR SINGER MACHINES" are NOT SINGER made needles. 2

ACCESSORIES

No.	Plate	Name
50190W	18381	Attachment Thumb Screw
2587B	18310	Guide
270010	18379	Rotating Hook Bobbin (2)
250522	18310	Screw Driver (for needle set screw)
88 x 1	- - -	Needles, six, size 16
228372	18311	Drip Pan, with four 3/4 in. wire nails
12361	18310	Machine Hinge Connection (2)
41400	18310	Machine Rest Pin (wood)
120342	18310	Oiler (copper plated) with 120343
120343	18310	" Spout (3-1/2 in. long)
259477	18310	Screw Driver, 5 in. long

KNEE LIFTER

228486	18311	Rock Lever Bracket with 200347C and three wood screws 7/8 in., No. 12
228361	18311	Rock Lever Bracket 228486 with 228359, 228363, 228367, 228386 and 228455
228359	18311	Rock Lever with two 350231C
228370	18311	" " Extension with 200529C
350231C	18311	" " " Set Screw
228363	18311	" " Hinge Pin
228364	18311	" " Knee Plate with 350231C
228388	18311	" " " " Arm
350231C	18311	" " " " Set Screw
350231C	18311	" " " " Set Screw
228455	18311	" " Position Spring
228365	18311	" " Rod
200529C	18311	" " " Set Screw
228386	18311	" " Spring
228367	18311	" " Stop Stud
200347C	18311	" " " " Set Screw
228371	18311	Knee Lifter Rock Lever complete, Nos. 228361, 228364, 228365, 228370 and 228388

(Other Knee Lifter parts are listed with parts of machine head).

BOBBIN WINDER

(SWINGING AUTOMATIC, RIGHT HAND)

FOR "V" BELT DRIVE

No.	Plate	Name
259428	18312	Brake (leather)
259429	18312	" Clamp
200113F	18312	" " Screw
225453	18312	Frame with 202277 and 259660
225454	18312	" Hinge Pin
202277	18312	" Oil Packing (wick)
259660	18312	" " Well Washer
225455	18312	" Spring
225456	18312	" Plunger
259461	18312	Pulley with 200380C
200380C	18312	" Set Screw
225381	18312	Spindle
225444	18312	Stop Latch
200056E	18312	" " Screw
225458	18312	" " Thumb Lever
225459	18312	" " " " Hinge Stud
225459	18312	" " " " Joint Stud
202478	18312	" " Trip Lever
200299H	18312	" " " " Hinge Screw
225461	18312	Tension Bracket with 201499H
200082D	18312	" " Screw
228026	18312	" " " Washer
2102	18312	" Disc
13710	18312	" Spring
201499H	18312	" Stud
201572H	18312	" " Thumb Nut
225462	18312	Bobbin Winder Tension Bracket complete, Nos. 13710, 201572H, 225461 and two 2102
259662	18312	Bobbin Winder and Tension Bracket Base
259462	18312	Universal Bobbin Winder complete, Nos. 200056E, 200082D, 200113F, 200299H, 202478, 225381, 225444, 225453 to 225456, 225458, 225462, 228026, 259428, 259429, 259461, 259662, two each 225459 and wood screws 3/4 in., No. 12, R.H.B.

BINDERS

BINDER (English)

FOR GAUGES UP TO 9/16 INCH

No.	Plate	Name
121444	23226	Feed Dog, 13 teeth (16 teeth to the inch)
25721	23226	Folder
207F	23226	" Screw
7071	23226	" " Washer
25983	23226	Presser Foot
25722	23226	Ribbon Tension
190D	23226	" " Screw
7071	23226	" " " Washer
121445XC	23226	Throat Plate
26250	23226	Binder complete, Nos. 190D, 207F, 25721, 25722, 25983, 121444, 121445 and two 7071

BINDER (English)

FOR HEAVY WORK

12370	18359	Feed Dog, 15 teeth (16 teeth to the inch)
28334	18359	Folder
193D	18359	" Screw
7071	18359	" " Washer
28676	18359	Presser Foot
28337	18359	Ribbon Tension
233J	18359	" " Screw
28775XC	18359	Throat Plate
28776	18359	Binder complete, Nos. 193D, 7071, 12370, 28334, 28337, 28676, 28775 and two 233J

BINDER ON SHANK

35208	23228	Binder on Shank to turn in both edges, for bias or straight binding, for skirts, wrappers, shirt waists, etc.
26603	23228	Feed Dog, 20 teeth (16 teeth to the inch), for 26605 and 26606
52055	23228	Presser Foot

No.	Plate	Name
26605XC	23228	Throat Plate (large needle hole), for 26603
26606XC	-----	Throat Plate (small needle hole), for 26603

BINDER (Bias)

(WITH TAPE REEL)

FOR GENERAL WORK

FOR 7/8 IN. BIAS BINDING

259778	18373	Binder, for 7/8 in. binding
259779	18373	" Bracket
350511D	18373	" " Thumb Screw
225604H	18373	" " " " Washer
200126F	18373	" Screw
202603	18373	" " Washer
259780	18373	Feed Dog
202090	18373	Presser Foot Hinge Pin
259781	18373	" " Plate
270643	18373	" " Shank
26231	18373	" " Spring
259782	18373	Presser Foot (spring hinged) complete, Nos. 26231, 202090, 259781 and 270643
121412	18373	Tape Reel Arm with 8879, 23263 and 120537
207D	18373	Tape Reel Arm Screw
23263	18373	" " " Steady Pin
120536	18373	" " Disc with 120538 and 120539
120537	18373	" " " Pin
8879	18373	" " " " Washer (cloth)
120538	18373	" " " Stud (wood)
120539	18373	" " " " Sleeve (brass)
259783	18373	Throat Plate
259784	18373	Binder complete, for 7/8 in. bias binding, Nos. 207D, 120536, 121412, 200126F, 202603, 225604H, 259778 to 259780, 259782, 259783 and 350511D

**BINDER (Transverse) ON SHANK
FOR FOLDED OR UNFOLDED BIAS BINDING**

(WITH TAPE REEL)

FOR GENERAL WORK

FOR 3/4 IN., 7/8 IN. AND 1 IN. TAPE

No.	Plate	Name
121167	22919	Binder Folder on Shank
43525	22919	" Steady Pin
51097J	22919	" Thumb Screw
3146	22919	" " " Washer
121397	22919	Feed Dog, 18 teeth (16 teeth to the inch)
121169	22919	Presser Foot
121412	22919	Tape Reel Arm with 8879, 23263 and 120537
23263	22919	Tape Reel Arm Steady Pin
51097J	22919	" " " Thumb Screw
120536	22919	" " Disc with 120538 and 120539
120537	22919	" " " Pin
8879	22919	" " " " Washer (cloth)
120538	22919	" " " Stud (wood)
120539	22919	" " " " Sleeve (brass)
121398XC	22919	Throat Plate with 43525
121168	22919	Binder (transverse) on Shank complete, Nos. 3146, 120536, 121167, 121169, 121397, 121398, 121412 and two 51097J

**BINDER (Transverse) ON THROW-OUT ARM
FOR FOLDED OR UNFOLDED BIAS BINDING**

(WITH TAPE REEL)

FOR GENERAL WORK

FOR 3/4 IN., 7/8 IN. AND 1 IN. TAPE

121732	23229	Binder (transverse)
121735	23229	" Releasing Lever
724F	23229	" " " Hinge Screw
121736	23229	" " " Spring
192349	23229	" " " " Position
		Stud
1443J	23229	Binder Screw

BINDERS

No.	Plate	Name
121733	23229	Binder Throw-out Arm with 192349
121734	23229	" " " Bracket Rivet
940F	23229	" " " Hinge Screw
35610	23229	" Washer
121738	23229	Feed Dog, 17 teeth (16 teeth to the inch)
121169	23229	Presser Foot
120536	23229	Tape Reel Disc with 120538 and 120539
120538	23229	" " " Stud (wood)
120539	23229	" " " Sleeve (brass)
120740	23229	" " Pin
121938XC	23229	Throat Plate with two 121734
121737	23229	Binder (transverse) with Throw-out Arm complete, Nos. 724F, 940F, 35610, 120536, 120740, 121169, 121732, 121733, 121735, 121736, 121738, 121938XC and two 1443J

BOBBIN HOLDER

225434	18316	Bobbin Holder
--------	-------	---------------

BOBBIN WINDER

(SWINGING AUTOMATIC, RIGHT HAND)

FOR 5/16" ROUND BELT DRIVE

259428	18312	Brake (leather)
259429	18312	" Clamp
200113F	18312	" " Screw
225453	18312	Frame with 202277 and 259660
225454	18312	" Hinge Pin
202277	18312	" Oil Packing (wick)
259660	18312	" " Well Washer
225455	18312	" Spring
225456	18312	" " Plunger
225368	18312	Pulley with 200380C
200380C	18312	" Set Screw
225381	18312	Spindle
225444	18312	Stop Latch
200056E	18312	" " Screw
225458	18312	" " Thumb Lever
225459	18312	" " " " Hinge Stud
225459	18312	" " " " Joint Stud
202478	18312	" " Trip Lever
200299H	18312	" " " " Hinge Screw
225461	18312	Tension Bracket with 201499H
200082D	18312	" " Screw

BOBBIN WINDER

No.	Plate	Name
228026	18312	Tension Bracket Screw Washer
2102	18312	" Disc
13710	18312	" Spring
201499H	18312	" Stud
201572H	18312	" " Thumb Nut
225462	18312	Bobbin Winder Tension Bracket complete, Nos. 13710, 201572H, 225461 and two 2102
259430	18312	Bobbin Winder and Tension Bracket Base
259431	18312	Universal Bobbin Winder complete, Nos. 200056E, 200082D, 200113F, 200299H, 202478, 225368, 225381, 225444, 225453 to 225456, 225458, 225462, 228026, 259428 to 259430, two each 225459 and wood screws 3/4 in., No. 12, R.H.B.

CORDER (Adjustable)

FOR SHORT TURNS ON CUSHIONS

WHEN ORDERING STATE SIZE OR NUMBER

OF CORDS TO THE INCH

26795	23228	Cord Guide
26796	23228	" " Arm
1044D	23228	" " " Hinge Screw
120206	23228	" " Bed with 457AL
457AL	23228	" " " Leveling Screw
190D	23228	" " Screw
120207	23228	Corder complete, Nos. 190D, 1044D, 26795, 26796 and 120206
121446	23228	Feed Dog, spiked teeth, 13 teeth (10 teeth to the inch), for 121447
120208	23228	Presser Foot (grooved)
121447XC	23228	Throat Plate, for 121446

BELT GUARD

270153	18375	Belt Guard Bracket
350328H	18375	" " " Screw (2)
200362C	18375	" " Set Screw (2)
270152	18375	" " with two 200362C
270154	18375	Belt Guard complete, Nos. 270152, 270153 and two 350328H

FINGER GUARD

No.	Plate	Name
259502	18359	Finger Guard

GUIDE

26682	18360	Guide (combination)
-------	-------	---------------------

HEMMERS

HEMMERS (Foot)

225423	18316	Hemmer (foot), for 5/64 in.hem
120938	23230	" " " 3/32 in.hem
225421	18316	" " " 3/32 in.hem
225424	18316	" " " 1/8 in.hem
120803	23230	" " " 1/8 in.hem
270120	18360	" " " 1/8 in.hem, for hemming shirts
225425	18316	Hemmer (foot), for 9/64 in.hem
120804	23230	" " " 5/32 in.hem
225422	18316	" " " 5/32 in.hem
120805	23230	" " " 3/16 in.hem
225426	18316	" " " 3/16 in.hem
36122	23230	" " " 7/32 in.hem
225427	18316	" " " 7/32 in.hem
120806	23230	" " " 1/4 in.hem
225428	18316	" " " 1/4 in.hem
120807	23230	" " " 5/16 in.hem
121761	23230	" " " with 121981, for 1/8 in. hem, for hemming shirts
121762	23230	Hemmer (foot) with 121981, for 5/32 in. hem
121760	23230	Hemmer (foot), for 1/8 in.hem, for hemming shirts
121758	23230	Feed Dog, 13 teeth (16 teeth to the inch), for 121759
270121	18360	Feed Dog, for 270122
121759XC	23230	Throat Plate (large needle hole), for 121758
270122	18360	Throat Plate (small needle hole), for 270121
35710	23230	Hemmer (foot), for 3/32 in.hem with guide on bottom to the right of needle hole

No.	Plate	Name
35682	23230	Hemmer (foot), for 1/8 in.hem with guide on bottom to the right of needle hole
36524	23230	Hemmer (foot), for 5/32 in.hem with guide on bottom to the right of needle hole
35997	23230	Hemmer (foot), for 3/16 in.hem with guide on bottom to the right of needle hole
36309	23230	Hemmer (foot), for 7/32 in.hem with guide on bottom to the right of needle hole
36072	23230	Hemmer (foot), for 1/4 in.hem with guide on bottom to the right of needle hole
120898	23230	Hemmer (foot), for 1/16 in. to 1/8 in. hem, for China Silk, etc.
120911	23230	Hemmer (foot), for 5/32 in. to 1/4 in. hem, for China Silk, etc.
36413	23230	Hemmer (foot), plain bottom, for 1/16 in.hem
36414	23230	Hemmer (foot), plain bottom, for 3/32 in.hem
36480	23230	Hemmer (foot), plain bottom, for 5/32 in.hem
36416	23230	Hemmer (foot), plain bottom, for 3/16 in.hem
120837	23230	Hemmer (foot), plain bottom, for 1/8 in.hem, slotted, for lace
121981	-----	Hemmer Tongue, for 121761, 121762 and 121763

Note: When ordering No. 121981, state width of hem and number of Hemmer for which it is required.

HEMMERS ON SHANK

20163	23231	Feed Dog, 16 teeth (16 teeth to the inch), for 1/16 in. stitch, for 20123
35926	23231	Hemmer
590D	23231	" Adjusting Screw
1443B	23231	" Screw
35927	23231	" Shank
35540	23231	Hemmer on Shank complete with right hand lower guide, for lace, Nos. 1443B, 35926, 35927 and two 590D
62527	23231	Presser Foot Hinge Pin
40316	23231	" " Plate
40317	23231	" " Shank
40318	23231	Presser Foot (hinged) complete, for lace running, Nos. 40316, 40317 and 62527

HEMMERS

No.	Plate	Name
20123XC	23231	Throat Plate, for 20163
26603	23231	Feed Dog, 20 teeth (16 teeth to the inch), for 26605 and 26606
35236	23231	Hemmer on Shank, for 7/16 in. hem
52055	23231	Presser Foot
26605XC	23231	Throat Plate (large needle hole), for 26603
26606XC	-----	Throat Plate (small needle hole), for 26603
26603	23232	Feed Dog, 20 teeth (16 teeth to the inch), for 26605 and 26606
28627	23232	Hemmer on Shank, for 1/8 in. to 5/8 in. gauges
28628	23232	Presser Foot, for 3/8 in. to 5/8 in. gauges
26605XC	23232	Throat Plate (large needle hole), for 26603
26606XC	-----	Throat Plate (small needle hole), for 26603
120991	23232	Hemmer on Shank, for 1/16 in. to 1/4 in. hem
120367	23232	Hemmer on Shank, for handkerchief work

PIPING ATTACHMENT

44253	18315	Feed Dog, 16 teeth (16 teeth to the inch), for 44255 and 44256
120977	18315	Piping Attachment
1443J	18315	" " Screw
35245	18315	Piping Attachment complete, for piping house dresses, Nos. 1443J and 120977
52056	18315	Presser Foot
44256XC	18315	Throat Plate (large needle hole), for 44253
44255XC	-----	Throat Plate (small needle hole), for 44253

PRESSER FEET

36464	23236	Presser Foot Spring Guide
665J	23236	" " " Screw
36465	23236	Presser Foot (right hand spring guide) with 665J and 36464, for 1/32 in. to 5/16 in. gauges

Note: When ordering No. 36464 or No. 36465, state required distance from edge of goods to seam.

PRESSER FEET

No.	Plate	Name
28726	18372	Presser Foot (right hand spring guide) with 665J and 28725, for 1/32 in. to 1/4 in. gauges
28725	18372	Presser Foot Spring Guide
Note: When ordering No. 28725 or No. 28726, state required distance from edge of goods to seam.		
26638	18372	Presser Foot (double toe), for gathering
12335	23236	Presser Foot (narrow)
12435	23236	" " with 228J (with needle hole on right hand side)
228J	23236	Presser Foot Extension Screw
36714	23236	" " with 233D
36715	23236	" " Guide (right) with 36716
233D	23236	" " Set Screw
36716	23236	" " Stud
36717	23236	Presser Foot complete with Adjustable Guide (right), Nos. 36714 and 36715
270195	18372	Presser Foot, for gathering
270196	18372	" " " slide fasteners
36773	23236	" " " braiding
35528	23236	" " (wide)
120828	23236	" " (single toe), for gathering, for fine work
121763	23236	Presser Foot with 121981 with Hemmer with Yielding Top Scroll
20343	23236	Presser Foot with guide on bottom to the right of needle hole
12462	23236	Presser Foot, for 1/8 in. to 1 in. gauges
Note: When ordering No. 12462, give width of turned edge from seam.		
12463	23236	Presser Foot with Strip Guide
36654	23236	" " for tucking shirt bosoms
40315	23236	" " " long stitch for general work
40322	23236	Presser Foot (narrow)
26276	23236	" " Hinge Pin
20133	23236	" " Plate
19223	23236	" " Shank
20134	23236	Presser Foot (hinged) complete, for 3/16 in. to 1/4 in. gauges for collar and cuff work, Nos. 19223, 20133 and 26276
7298	23236	Presser Foot Hinge Pin
20360	23236	" " Plate
19335	23236	" " Shank
20361	23236	Presser Foot (hinged) plain bottom complete, Nos. 7298, 19335 and 20360
18055	18372	Presser Foot Hinge Pin
143213	18372	" " Plate
143216	18372	" " "
143209	18372	" " Shank
143217	18372	" " "
143317	18372	" " Yielding Plate
143318	18372	" " "
143320	18372	" " " Spring

PRESSER FEET

No.	Plate	Name
143215	18372	Presser Foot (hinged) long toes, with left hand Yielding Plate complete, Nos. 18055, 143209, 143213, 143317 and 143320
143219	18372	Presser Foot (hinged) long toes, with right hand Yielding Plate complete, Nos. 18055, 143216, 143217, 143318 and 143320

PRESSER FEET

WITH GRADUATED ADJUSTABLE GUIDES

35134	18359	Presser Foot with 36696
35002	18359	" " Extension
35003	18359	" " Graduated Adjustable Guide (long, left)
35004	18359	Presser Foot Graduated Adjustable Guide (long, right)
35005	18359	Presser Foot Graduated Adjustable Guide (short, right)
35006	18359	Presser Foot Graduated Adjustable Guide (short, right) flush
35135	18359	Presser Foot Graduated Adjustable Guide Clamp
35136	18359	Presser Foot Graduated Adjustable Guide Clamp Lever
337B	18359	Presser Foot Graduated Adjustable Guide Clamp Screw
36696	18359	Presser Foot Graduated Adjustable Guide Clamp Steady Pin
35137	18359	Presser Foot with Extension and Graduated Adjustable Guides complete, Nos. 337B, 35002, to 35006 and 35134 to 35136

PRESSER FOOT EXTENSIONS

62527	23236	Presser Foot Hinge Pin
20155	23236	" " Plate
20156	23236	" " Shank
20157	23236	Presser Foot (hinged) complete, Nos. 228J, 20155, 20156 and 62527
26279	23236	Presser Foot Extension, 1/16 inch
26280	23236	" " " 1/8 inch
26281	23236	" " " 1/4 inch
26282	23236	" " " 3/8 inch
26283	23236	" " " 1/2 inch
228J	23236	" " " Screw

MISCELLANEOUS PARTS

No.	Plate	Name
143185	18347	Feed Bar Body with two each 1607C and 51220AL
51220AL	18347	Feed Bar Body Adjusting Screw
1607C	18347	" " " " " Lock Nut
704C	18347	" " " Screw
143186	18347	" " Shank
143187	18347	Feed Bar (tilting adjustable) complete, Nos. 704C, 143185 and 143186
228394	18347	Spool Pin

USED IN CONJUNCTION WITH THREAD UNWINDER

259370	18362	Spool Pin
259378	18362	" " Arm with 217E and 259379
448AL	18362	" " " Set Screw
232896	18362	" " " Bracket with two 448AL
448AL	18362	" " " Set Screw
259371	18362	" " Cap (bakelite)
1010F	18362	" " " Hinge Screw
259379	18362	" " Retaining Spring
217E	18362	" " " Screw
259372	18362	" " Washer
259373	18362	Spool Pin complete, Nos. 1010F and 259370 to 259372
60913	18362	Spool Weight with 60914
60914	18362	" " Center Pin
225377	18362	" Wire, for small spools
27739	18362	Thread Cone (wood)
225390	18362	" " Holder

PULLER FEED

No.	Plate	Name
259463	18313	Balance Wheel, belt grooves 2-1/8 and 1 in. diam. with 201346AL and 350107AL
259464	18313	Balance Wheel 259463 with 270004
259465	18313	" " belt grooves 2.9 in. outside diam., for 3/8 in. "v" belt and 1 in. bottom diam., for round belt with 201346AL and 350107AL
259466	18313	Balance Wheel 259465 with 270004
350107AL	18313	" " Position Screw
201346AL	18313	" " Set Screw
259467	18313	Puller Feed Base with 200364C, 259061 two each 200902D and 205796
259055	18313	Puller Feed Base Block (wood) (for use where attachment is not set into the table)
200710	18313	Puller Feed Base Bolt
9842R	18313	" " " " Washer
225190	18313	" " Driving Belt size 1/4 in. diam. length 39-1/2 in., with 25128
25128	18313	Puller Feed Driving Belt Hook
237751	18313	" " " Gear with 200382C and 201220C
201220C	18313	Puller Feed Driving Gear Position Screw
200382C	18313	Puller Feed Driving Gear Set Screw
259057	18313	" " " Pinion
200095B	18313	" " " Cap Screw
259468	18313	" " " Pulley (belt groove 4-1/4 in. diam.) with 200373C
200373C	18313	Puller Feed Driving Pulley Set Screw
259469	18313	" " " " Shaft
259470	18313	" " " " " Collar with 201188C
201188C	18313	Puller Feed Driving Pulley Shaft Collar Set Screw
200364C	18313	Puller Feed Driving Pulley Shaft Set Screw
259471	18313	Puller Feed Roll and Shaft (lower) with 200364C
259470	18313	Puller Feed Roll and Shaft (lower) Collar with 201188C
201188C	18313	Puller Feed Roll and Shaft (lower) Collar Set Screw
200364C	18313	Puller Feed Roll and Shaft (lower) Extension Set Screw
259472	18313	Puller Feed Roll and Shaft (upper)
*259061	-----	" " " " " " Bearing

PULLER FEED

No.	Plate	Name
200902D	18313	Puller Feed Roll and Shaft (upper) Bearing Screw
205796	18313	Puller Feed Roll and Shaft (upper) Bearing Spring
259063	18313	Puller Feed Roll and Shaft Gear with 200394C
200394C	18313	Puller Feed Roll and Shaft Gear Set Screw
259064	18313	Puller Feed Work Guide (wood)
259474	18313	Puller Feed Device complete, Nos. 200095B, 225190, 237751, 259055, 259057, 259064, 259464, 259467 to 259469, 259471, 259472, two each 9842R, 200710, 259063 and 259470

Note: Balance Wheel No. 259466, for machines with "v" belt drive will be furnished with this device complete in place of Balance Wheel No. 259454 if so specified on order.

THREAD UNWINDER

225257	18362	Spool Rest (for two spools) (flat) with 201018C
150203	18362	Spool Rest Cushion (felt)
225388	18362	" " Rod
200383C	18362	" " " Set Screw
201018C	18362	" " Set Screw
259658	18362	" Stand with 200383C
225391	18362	Thread Guide
201696H	18362	" " Lock Nut
225326	18362	" " Position Cup
225324	18362	" " Rod with 208AL and 225322
208AL	18362	" " " Screw
225322	18362	" " " Washer
225258	18362	Thread Unwinder (for two spools) complete, Nos. 201696H, 225257, 225324, 225326, 225388, 259658, two each 105203, 225391 and three wood screws 7/8 in., No. 12

TUCKER (Long Arm)

259541	18343	Presser Foot, 50 needle hole
259542	18343	" " 53 needle hole, 1/16 in. gauge to left of needle hole
259543	18343	Presser Foot, 53 needle hole, 3/32 in. gauge to left of needle hole

No.	Plate	Name
259544	18343	Presser Foot,53 needle hole,1/8 in. gauge to left of needle hole
259545	18343	Presser Foot,53 needle hole,5/32 in. gauge to left of needle hole
36387	18343	Space Guide
259529	18343	Space Guide Base with 35512,35514, 201525E,225708,350472H and two 1426E
350472H	18343	Space Guide Base Hinge Screw
201525E	18343	" " " " " Nut
225708	18343	" " " Spring
35511	18343	" " Indicator
35512	18343	" " Pin
35513	18343	" " Stop (left)
35514	18343	" " " Guide Pin
1426E	18343	" " " Screw Stud
1657D	18343	" " " Thumb Nut
17718	18343	" " " " " Washer
35515	18343	" " " (right)
1426E	18343	" " " Screw Stud
1657D	18343	" " " Thumb Nut
17718	18343	" " " " " Washer
50053W	18343	" " " Thumb Screw
259530	18343	Space Guide complete,Nos.35511,35513, 35515,36387,50053W,259529,two each 1657D and 17718
35517	18343	Tuck Guide Arm
1177J	18343	" " " Screw
35518	18343	" " Base
50134E	18343	" " " Screw Stud
36389	18343	" " Bracket
307C	18343	" " " Screw Center
56814	18343	" " " " " 307C with 1513J
1513J	18343	Tuck Guide Bracket Screw Center Nut
36390	18343	" " " Spring
36391	18343	" " " " Plate
9D	18343	" " " " Screw
423C	18343	" " " Stop Screw
1520J	18343	" " " " Nut
36392	18343	" " Frame
36393	18343	" " " Spring
1510E	18343	" " " Nut
35524	18343	" " " Washer
803C	18343	" " " Stop Screw
1520J	18343	" " " " Nut
35511	18343	" " Indicator
35525	18343	" " Plate
1115F	18343	" " Screw
36394	18343	Tuck Guide complete,Nos.9D,423C,803C, 1510E,35511,35517,35518,35524,35525, 36389 to 36393,50134E,two each 1115F,1177J,1520J,56814 and three wood screws 1-1/4 in.,No.10
259532	18343	Tucker (long arm) complete,Nos.36394, 259530 and 259541

WOOD BASE

For Use with Tuck Folder

No.	Plate	Name
228395	18361	Auxiliary Knee Lifter Rock Lever Rod with 227785
228396	18361	Auxiliary Knee Lifter Rock Lever Rod Bracket
*227785	-----	Auxiliary Knee Lifter Rock Lever Rod Cap
79627	18361	Bench Stand Section (back) with two each 20022,27878,150962 and wood screws 3-1/2 in.,No.14
79626	18361	Bench Stand Section (front) with wood screw 1-1/2 in.,No.12,two each 20022,27878 and wood screws 3-1/2 in.,No.14
44243	18361	Machine Hinge Connection
2809	18361	" " " Hinge Pin
33887	18361	" " Plate
150962	18361	Machine Hinge complete,Nos.2809,33887, 44243 and wood screw 1 in.,No.14, F.H.blacked
20022	18361	Machine Rest (felt)
27878	18361	" " Rivet
79628	18361	Bench Stand (sectional) complete,Nos. 79626 and 79627

FITTINGS

FOR BUTTON STAYS

26603	18315	Feed Dog,20 teeth (16 teeth to the inch),for 26605 and 26606
121653	18315	Hammer on Shank,for 9/16 in.hem
7298	18315	Presser Foot Hinge Pin
120143	18315	" " Plate
19335	18315	" " Shank
120144	18315	Presser Foot (hinged) complete,Nos. 7298,19335 and 120143
26605XC	18315	Throat Plate (large needle hole),for 26603
26606XC	-----	Throat Plate (small needle hole),for 26603

FOR CHAINING OFF

No.	Plate	Name
142057	18374	Feed Dog, 21 teeth (22 teeth to the inch), for 142060 and 142061
142062	18374	Feed Dog, 17 teeth (18 teeth to the inch), for general and shirt work, for 142060 and 142061
62527	18374	Presser Foot Hinge Pin
142058	18374	" " Plate
121944	18374	" " Shank
121945	18374	" " Spring
142059	18374	Presser Foot (spring hinged) complete, Nos. 62527, 121944, 121945 and 142058
142060	18374	Throat Plate (small needle hole), for 142057 and 142062
142061	18374	Throat Plate (large needle hole), for 142057 and 142062

FOR COLLAR WORK

(FIRST STITCHING)

20164	23219	Feed Dog, 16 teeth (16 teeth to the inch), for 1/8 in. stitch, for 52190
52189	23219	Presser Foot (solid)
52190XC	23219	Throat Plate, for 20164

FOR COLLAR WORK

(SECOND STITCHING)

121646	23219	Feed Dog, 12 teeth (16 teeth to the inch), for 121649
121647	23219	Presser Foot with 121648 and two 337J, for 3/16 in., 7/32 in., 1/4 in., 9/32 in. and 5/16 in. gauges
121648	23219	Presser Foot Edge Guide, for 3/16 in., 7/32 in., 1/4 in., 9/32 in. and 5/16 in. gauges
337J	23219	Presser Foot Edge Guide Screw
121649XC	23219	Throat Plate, for 121646

FOR COLLAR AND CUFF WORK

No.	Plate	Name
20163	23219	Feed Dog, 16 teeth (16 teeth to the inch), for 1/16 in. stitch
20164	23219	Feed Dog, 16 teeth (16 teeth to the inch), for 1/8 in. stitch
52188	23219	Presser Foot (solid), for cuff work
52189	23219	" " " " collar work
20123XC	23219	Throat Plate, for 20163 and 20164

FOR CUFF WORK

20164	23220	Feed Dog, 16 teeth (16 teeth to the inch), for 1/8 in. stitch, for 52190
52188	23220	Presser Foot (solid)
52190XC	23220	Throat Plate, for 20164

FOR CURTAIN WORK

143165	23220	Feed Dog, 18 teeth (14 teeth to the inch)
26276	23220	Presser Foot Hinge Pin
143166	23220	" " Plate
143167	23220	" " Shank
52544	23220	" " Spring
143168	23220	Presser Foot (spring hinged) complete, Nos. 26276, 52544, 143166 and 143167
143169XC	23220	Throat Plate (large needle hole)

FOR GENERAL WORK

143174	23220	Feed Dog, 17 teeth (14 teeth to the inch), for 143175
143175XC	23220	Throat Plate (large needle hole), for 143174
52031	23221	Feed Dog, 19 teeth (22 teeth to the inch), for 52032 and 52033
62527	23221	Presser Foot Hinge Pin
24544	23221	" " Plate
24982	23221	" " Shank
26231	23221	" " Spring

FITTINGS

No.	Plate	Name
24983	23221	Presser Foot (spring hinged) complete, Nos.24544,24982,26231 and 62527
52032XC	-----	Throat Plate (large needle hole),for 52031
52033XC	23221	Throat Plate (small needle hole),for 52031
127229	23221	Feed Dog,17 teeth (14 teeth to the inch),for 127238
62527	23221	Presser Foot Hinge Pin
127233	23221	" " Plate
52390	23221	" " Shank
26231	23221	" " Spring
127234	23221	Presser Foot (spring hinged) complete, Nos.26231,52390,62527 and 127233
131256	23221	Presser Foot Hinge Pin
127257	23221	" " Plate
127258	23221	" " Shank with 665J
127259	23221	" " Thread Cutter
239E	23221	" " " " Screw
127260	23221	Presser Foot (hinged) complete with Thread Cutter,Nos.239E,127257 to 127259 and 131256
127238XC	23221	Throat Plate,for 127229
127087	23221	Feed Dog,19 teeth (16 teeth to the inch),for 127106 and 127107
127106XC	23221	Throat Plate (large needle hole),for 127087
127107XC	-----	Throat Plate (small needle hole),for 127087
121446	23222	Feed Dog,spiked teeth,13 teeth (10 teeth to the inch),for 20356,20357 and 270128
20356XC	23222	Throat Plate (large needle hole),for 121446
20357XC	-----	Throat Plate (small needle hole),for 121446
44158	23222	Feed Dog,15 teeth (14 teeth to the inch),for 44162
26276	23222	Presser Foot Hinge Pin
44159	23222	" " Plate
44160	23222	" " Shank
44161	23222	Presser Foot (hinged) complete,Nos. 26276,44159 and 44160
44162XC	23222	Throat Plate,for 44158
20117	18345	Feed Dog,for shirt work,beveled,for hemmer,16 teeth (16 teeth to the inch)
20124XC	18345	Throat Plate (large needle hole),for 20117
127087	23221	Feed Dog,19 teeth (16 teeth to the inch),for 270127
270127	18345	Throat Plate (large needle hole),for 127087
121446	23228	Feed Dog,spiked teeth,13 teeth (10 teeth to the inch),for 270128
270128	18345	Throat Plate (large needle hole),for 121446

FITTINGS

No.	Plate	Name
44252	23224	Feed Dog,12 teeth (12 teeth to the inch),for 270129
44253	23224	Feed Dog,16 teeth (16 teeth to the inch),for 270129
270129	18345	Throat Plate (large needle hole),for 44252 and 44253
270130	18345	Throat Plate (large needle hole),for 26603

FOR HEMMING BOTTOM OF DRESS SHIRTS

270121	18374	Feed Dog,for 270122
270120	18374	Hemmer Foot,1/8 in.hem
270134	18374	" " 5/32 in.hem
270136	18374	" " 3/16 in.hem
270122	18374	Throat Plate,small needle hole,for 270121

FOR QUILTING

270114	18359	Presser Bar Bushing (for use with Quilter 120485)
120479	18359	Quilter Guide (left)
120480	18359	" " (right)
120481	18359	" " Bracket
120482	18359	" " " 120481 with 120483 and two 209AL
209AL	18359	Quilter Guide Bracket Screw
120483	18359	" " Disengaging Sleeve
209AL	18359	" " " " Set Screw
120484	18359	Quilter Guide Disengaging Sleeve Spring
602D	18359	Quilter Guide Disengaging Sleeve Spring Screw
120485	18359	Quilter complete,Nos.602D,120479, 120480,120482 and 120484

FOR SHIRT WORK

143170	23222	Feed Dog,16 teeth (16 teeth to the inch),for 143171
143171XC	23222	Throat Plate (large needle hole),for 143170
20159	18316	Feed Dog,16 teeth (16 teeth to the inch),for 20160

FITTINGS

No.	Plate	Name
143172	18316	Feed Dog, 18 teeth (18 teeth to the inch), for 20160
143173	18316	Feed Dog, 20 teeth (20 teeth to the inch), for 20160
20160XC	18316	Throat Plate (large needle hole), for 20159, 143172 and 143173
26603	23224	Feed Dog, 20 teeth (16 teeth to the inch), for 26605, 26606 and 270130
7298	23224	Presser Foot Hinge Pin
19334	23224	" " Plate
19335	23224	" " Shank
19336	23224	Presser Foot (hinged) complete, Nos. 7298, 19334 and 19335
26605XC	23224	Throat Plate (large needle hole), for 26603
26606XC	-----	Throat Plate (small needle hole), for 26603
142057	18360	Feed Dog, 21 teeth (22 teeth to the inch), for 142060
62527	18360	Presser Foot Hinge Pin
142058	18360	" " Plate
121944	18360	" " Shank
121945	18360	" " Spring
142059	18360	Presser Foot (spring hinged) complete, Nos. 62527, 121944, 121945 and 142058
142060	18360	Throat Plate (small needle hole), for 142057

FOR SHOULDER JOININGS

26603	23224	Feed Dog, 20 teeth (16 teeth to the inch), for 26605 and 26606
121662	23224	Joining Attachment with 121844
121844	-----	" " Shank, for 121662
121663	23224	Presser Foot
26605XC	23224	Throat Plate (large needle hole), for 26603
26606XC	-----	Throat Plate (small needle hole), for 26603

FOR SLEEVE PLACKETS (Facing)

121655	23225	Binder on Shank
26603	23225	Feed Dog, 20 teeth (16 teeth to the inch), for 26605 and 26606
121656	23225	Presser Foot
26605XC	23225	Throat Plate (large needle hole), for 26603
26606XC	-----	Throat Plate (small needle hole), for 26603

FOR TAILOR WORK

No.	Plate	Name
44252	23224	Feed Dog, 12 teeth (12 teeth to the inch), for 44255 and 44256
44253	23224	Feed Dog, 16 teeth (16 teeth to the inch), for 44255 and 44256
36574	23224	Presser Foot
36575	23224	" " 36574 with 36576 and two 50202J
36576	23224	Presser Foot Finger Guard
50202J	23224	" " " " Screw
44256XC	23224	Throat Plate (large needle hole), for 44252 and 44253
44255XC	-----	Throat Plate (small needle hole), for 44252 and 44253
44136	23225	Feed Dog, 15 teeth (16 teeth to the inch), for 44137
12142	23225	Presser Foot
20458	23225	" "
44137XC	23225	Throat Plate, for 44136
52462	23226	Feed Dog, 19 teeth (22 teeth to the inch), for 52463
52463XC	23226	Throat Plate, for 52462

FOR YOKING

121658	23226	Edge Folder with Edge Guide on Shank
26603	23226	Feed Dog, 20 teeth (16 teeth to the inch), for 26605 and 26606
7298	23226	Presser Foot Hinge Pin
121659	23226	" " Plate
19223	23226	" " Shank
121660	23226	Presser Foot (hinged) complete, Nos. 7298, 19223 and 121659
26605XC	23226	Throat Plate (large needle hole), for 26603
26606XC	-----	Throat Plate (small needle hole), for 26603

Genuine SINGER Needles should be
used in SINGER Machines.
These Needles and their Containers
are marked with the
Company's Trade-Mark "SIMANCO." 1

Needles in Containers marked
"FOR SINGER MACHINES"
are NOT **SINGER** made needles. 2

NUMERICAL
LIST
OF PARTS

NUMERICAL LIST OF PARTS

No.	Plate	Name
9D	18343	Tucker Tuck Guide Bracket Spring Screw, for 36394
176J	18306	Presser Foot Screw, for 270059
190D	23226	Binder Ribbon Tension Screw, for 26250
190D	23228	Corder Cord Guide Screw, for 120207
193D	18359	Binder Folder Screw, for 28776
207F	23226	" " " " 26250
207D	18373	Tape Reel Arm Screw, for 259784
208AL	18362	Thread Unwinder Thread Guide Rod Screw, for 225324
209AL	18359	Quilter Guide Bracket Screw, for 120482
209AL	18359	" " Disengaging Sleeve Set Screw, for 120482
217E	18362	Thread Unwinder Spool Pin Retaining Spring Screw, for 259378
228J	23236	Presser Foot Extension Screw, for 12435 and 20157
233J	18359	Binder Ribbon Tension Screw, for 28776
233D	23236	Presser Foot Guide Set Screw, for 36714
239E	23221	" " Thread Cutter Screw, for 127260
307C	18343	Tucker Tuck Guide Bracket Screw Center, for 56814
337J	23219	Presser Foot Edge Guide Screw, for 121647
337B	18359	Presser Foot Graduated Adjustable Guide Clamp Screw, for 35137
401D	18380	Rotary Take-up (large) Screw
423C	18343	Tucker Tuck Guide Bracket Stop Screw, for 36394
446C	18380	Thread Take-up Spring Regulator Set Screw
448AL	18362	Thread Unwinder Spool Pin Arm Bracket Set Screw, for 232896
448AL	18362	Thread Unwinder Spool Pin Arm Set Screw, for 232896
457AL	23228	Corder Cord Guide Bed Leveling Screw, for 120206
590D	23231	Hemmer Adjusting Screw, for 35540
591F	18379	Rotating Hook Bobbin Case Tension Spring Regulating Screw, for 52236
592E	18379	Rotating Hook Bobbin Case Latch Stop Screw, for 52237
602D	18359	Quilter Guide Disengaging Sleeve Spring Screw, for 120485
665J	18372	Presser Foot Spring Guide Screw, for 28726, 36465 and 127258

NUMERICAL LIST OF PARTS

No.	Plate	Name
691F	18383	Stitch Regulating Index Plate Screw
691F	18364	Throat Plate Screw
704C	18347	Feed Bar Body Screw, for 143187
724F	23229	Binder Releasing Lever Hinge Screw, for 121737
803C	18343	Tucker Tuck Guide Frame Stop Screw, for 36394
940F	23229	Binder Throw-out Arm Hinge Screw, for 121737
1010F	18362	Thread Unwinder Spool Pin Cap Hinge Screw, for 259373
1044D	23228	Corder Cord Guide Arm Hinge Screw, for 120207
1053E	18379	Rotating Hook Thread Guard Screw, for 270869
1115F	18343	Tucker Tuck Guide Screw, for 36394
1177J	18343	" " " Arm Screw, for 36394
1253AL	18379	Rotating Hook Set Screw, for 270868
1367E	18379	" " Section Screw, for 270870
1380E	18379	" " Bobbin Case Tension Spring Screw, for 52236
1426E	18343	Tucker Space Guide Stop (left) Screw Stud, for 259529
1426E	18343	Tucker Space Guide Stop (right) Screw Stud, for 259529
1443J	23229	Binder Screw, for 121737
1443B	23231	Hemmer Screw, for 35540
1443J	18315	Piping Attachment Screw, for 35245
1510E	18343	Tucker Tuck Guide Frame Spring Nut, for 36394
1513J	18343	Tucker Tuck Guide Bracket Screw Center Nut, for 56814
1520J	18343	Tucker Tuck Guide Bracket Stop Screw Nut, for 36394
1520J	18343	Tucker Tuck Guide Frame Stop Screw Nut, for 36394
1560C	18380	Tension Thumb Nut, for 52098
1607C	18347	Feed Bar Body Adjusting Screw Lock Nut, for 143185
1657D	18343	Tucker Space Guide Stop (left) Thumb Nut, for 259530
1657D	18343	Tucker Space Guide Stop (right) Thumb Nut, for 259530
2102	18312	Bobbin Winder Tension Disc, for 225462
2102	18380	Tension Disc, for 270087
2809	18361	Machine Hinge Connection Hinge Pin, for 150962
2974	18379	Rotating Hook Bobbin Case Latch Lever Fulcrum Pin, for 40393
2975	18379	Rotating Hook Bobbin Case Latch Spring, for 52237
3146	22919	Binder Thumb Screw Washer, for 121168
7071	18359	Binder Folder Screw Washer for 26250 and 28776
7071	23226	Binder Ribbon Tension Screw Washer, for 26250

NUMERICAL LIST OF PARTS

No.	Plate	Name
7298	18315	Presser Foot Hinge Pin for 19336, 20361, 120144 and 121660
8879	18373	Tape Reel Disc Pin Washer (cloth), for 121412
9842R	18313	Puller Feed Base Bolt Washer, for 259474
12142	23225	Presser Foot
12335	23236	" " (narrow)
12361	18310	Machine Hinge Connection
12370	18359	Feed Dog, 15 teeth (16 teeth to the inch), for 28776
12435	23236	Presser Foot with 228J (with needle hole on right hand side)
12462	23236	Presser Foot, for 1/8 in. to 1 in. gauges
12463	23236	Presser Foot with Strip Guide
13710	18312	Bobbin Winder Tension Spring, for 225462
13710	18380	Tension Spring, for 270087
17718	18343	Tucker Space Guide Stop (left) Thumb Nut Washer, for 259530
17718	18343	Tucker Space Guide Stop (right) Thumb Nut Washer, for 259530
18055	18372	Presser Foot Hinge Pin, for 143215 and 143219
19223	23236	Presser Foot Shank, for 20134 and 121660
19334	23224	Presser Foot Plate, for 19336
19335	23224	" " Shank, for 19336, 20361 and 120144
19336	23224	Presser Foot (hinged) complete, Nos. 7298, 19334 and 19335
20022	18361	Machine Rest (felt), for 79626 and 79627
20117	18345	Feed Dog, for Shirt Work, beveled, for Hemmer, 16 teeth (16 teeth to the inch), for 20124
20123XC	23231	Throat Plate, for 20163 and 20164
20124XC	18345	" " (large needle hole), for 20117
20133	23236	Presser Foot Plate, for 20134
20134	23236	Presser Foot (hinged) complete, for 3/16 in. to 1/4 in. gauges, for Collar and Cuff Work, Nos. 19223, 20133 and 26276
20155	23236	Presser Foot Plate, for 20157
20156	23236	" " Shank, for 20157
20157	23236	Presser Foot (hinged) complete, Nos. 228J, 20155, 20156 and 62527
20159	18316	Feed Dog, 16 teeth (16 teeth to the inch), for Shirt Work, for 20160
20160XC	18316	Throat Plate (large needle hole), for 20159, 143172 and 143173
20163	23231	Feed Dog, 16 teeth (16 teeth to the inch), for 1/16 in. stitch, for 20123

NUMERICAL LIST OF PARTS

No.	Plate	Name
20164	23219	Feed Dog, 16 teeth (16 teeth to the inch) for 1/8 in. stitch, for 20123 and 52190, for Collar and Cuff Work
20343	23236	Presser Foot with guide on bottom to the right of needle hole
20356XC	23222	Throat Plate (large needle hole), for 121446
20357XC	-----	Throat Plate (small needle hole), for 121446
20360	23236	Presser Foot Plate, for 20361
20361	23236	Presser Foot (hinged) plain bottom, complete, Nos. 7298, 19335 and 20360
20458	23225	Presser Foot
23263	18373	Tape Reel Arm Steady Pin, for 121412
24544	23221	Presser Foot Plate, for 24983
24982	23221	" " Shank, for 24983
24983	23221	Presser Foot (spring Hinged) complete, Nos. 24544, 24982, 26231 and 62527
25128	18313	Puller Feed Driving Belt Hook, for 225190
25721	23226	Binder Folder, for 26250
25722	23226	" Ribbon Tension, for 26250
25878	18310	Guide
25983	23226	Presser Foot, for 26250
26231	18364	" " Spring, for 24983, 62927, 127234 and 259782
26250	23226	Binder (English) complete, for gauges up to 9/16 in., Nos. 190D, 207F, 25721, 25722, 25983, 121444, 121445 and two 7071
26276	23236	Presser Foot Hinge Pin for 20134, 44161 and 143168
26279	23236	Presser Foot Extension, 1/16 inch
26280	23236	" " " 1/8 inch
26281	23236	" " " 1/4 inch
26282	23236	" " " 3/8 inch
26283	23236	" " " 1/2 inch
26603	23228	Feed Dog, 20 teeth (16 teeth to the inch), for 26605, 26606 and 270130
26605XC	23228	Throat Plate (large needle hole), for 26603
26606XC	-----	Throat Plate (small needle hole), for 26603
26638	18372	Presser Foot (double toe), for gathering
26682	18360	Guide (combination)
26795	23228	Corder Cord Guide, for 120207
26796	23228	" " " Arm, for 120207
27739	18362	Thread Unwinder Thread Cone (wood)
27878	18361	Machine Rest Rivet, for 79626 and 79627
28334	18359	Binder Folder, for 28776
28337	18359	" Ribbon Tension, for 28776
28627	23232	Hemmer on Shank, for 1/8 in. to 5/8 in. gauges

NUMERICAL LIST OF PARTS

No.	Plate	Name
28628	23232	Presser Foot, for 3/8 in. to 5/8 in. gauges
28676	18359	Presser Foot, for 28776
28725	18372	" " Spring Guide, for 28726
28726	18372	" " (right hand spring guide) with 665J and 28725, for 1/32 in. to 1/4 in. gauges
28775XC	18359	Throat Plate, for 28776
28776	18359	Binder (English) complete, for heavy work, Nos. 193D, 7071, 12370, 28334, 28337, 28676, 28775 and two 233J
32572	18380	Tension Releasing Disc, for 270087
33887	18361	Machine Hinge Plate, for 150962 Nos. 35002 to 35006, for 35137
35002	18359	Presser Foot Extension
35003	18359	" " Graduated Adjustable Guide (long, left)
35004	18359	Presser Foot Graduated Adjustable Guide (long, right)
35005	18359	Presser Foot Graduated Adjustable Guide (short, right)
35006	18359	Presser Foot Graduated Adjustable Guide (short, right) flush Nos. 35134 to 35136, for 35137
35134	18359	Presser Foot with 36696
35135	18359	" " Graduated Adjustable Guide Clamp
35136	18359	Presser Foot Graduated Adjustable Guide Clamp Lever
35137	18359	Presser Foot with Extension and Graduated Adjustable Guides complete, Nos. 337B, 35002 to 35006 and 35134 to 35136
35208	23228	Binder on Shank to turn in both edges, for bias or straight binding, for skirts, wrappers, shirt waists, etc
35236	23231	Hemmer on Shank, for 7/16 in. hem
35245	18315	Piping Attachment complete, for piping house dresses, Nos. 1443J and 120977
35511	18343	Tucker Space Guide Indicator, for 259530
35511	18343	Tucker Tuck Guide Indicator, for 36394
35512	18343	" Space Guide Pin, for 259529
35513	18343	" " " Stop (left), for 259530
35514	18343	Tucker Space Guide Stop (left) Guide Pin, for 259529
35515	18343	Tucker Space Guide Stop (right), for 259530
35517	18343	Tucker Tuck Guide Arm, for 36394
35518	18343	" " " Base, for 36394
35524	18343	" " " Frame Spring Washer, for 36394
35525	18343	Tucker Tuck Guide Plate, for 36394
35528	23236	Presser Foot (wide)

NUMERICAL LIST OF PARTS

No.	Plate	Name
35540	23231	Hemmer on Shank complete with right hand lower guide, for lace, Nos. 1443B, 35926, 35927 and two 590D
35610	23229	Binder Washer, for 121737
35682	23230	Hemmer (foot), for 1/8 in. hem, with guide on bottom to the right of needle hole
35710	23230	Hemmer (foot), for 3/32 in. hem, with guide on bottom to the right of needle hole
35926	23231	Hemmer, for 35540
35927	23231	" Shank, for 35540
35997	23230	" (foot), for 3/16 in. hem, with guide on bottom to the right of needle hole
36072	23230	Hemmer (foot), for 1/4 in. hem, with guide on bottom to the right of needle hole
36122	23230	Hemmer (foot), for 7/32 in. hem
36309	23230	" " " " " with guide on bottom to the right of needle hole
36387	18343	Tucker Space Guide, for 259530 Nos. 36389 to 36393, for 36394
36389	18343	Tucker Tuck Guide Bracket
36390	18343	" " " " Spring
36391	18343	" " " " Plate
36392	18343	" " " " Frame
36393	18343	" " " " Spring
36394	18343	Tucker Tuck Guide complete, for 259532, Nos. 9D, 423C, 803C, 1510E, 35511, 35517, 35518, 35524, 35525, 36389 to 36393, 50134E, two each 1115F, 1177J, 1520J, 56814 and three wood screws 1-1/4 in., No. 10
36413	23230	Hemmer (foot), plain bottom, for 1/16 in. hem
36414	23230	Hemmer (foot), plain bottom, for 3/32 in. hem
36416	23230	Hemmer (foot), plain bottom, for 3/16 in. hem
36464	23236	Presser Foot Spring Guide, for 36465
36465	23236	" " (right hand spring guide) with 665J and 36464, for 1/32 in. to 5/16 in. gauges
36480	23230	Hemmer (foot), plain bottom, for 5/32 in. hem
36524	23230	Hemmer (foot), for 5/32 in. hem with guide on bottom to the right of needle hole
36574	23224	Presser Foot, for 36575
36575	23224	" " 36574 with 36576 and two 50202J
36576	23224	Presser Foot Finger Guard, for 36575
36654	23236	" " , for tucking shirt bosoms
36696	18359	" " Graduated Adjustable Guide Clamp Steady Pin, for 35134

NUMERICAL LIST OF PARTS

No.	Plate	Name
36714	23236	Presser Foot with 233D, for 36717
36715	23236	" " Guide (right) with 36716, for 36717
36716	23236	Presser Foot Guide Stud, for 36715
36717	23236	" " complete with Adjustable Guide (right), Nos. 36714 and 36715
36773	23236	Presser Foot, for braiding
40315	23236	" " " long stitch, for general work
40316	23231	Presser Foot Plate, for 40318
40317	23231	" " Shank, for 40318
40318	23231	Presser Foot (hinged) complete, for lace running, Nos. 40316, 40317 and 62527
40322	23236	Presser Foot (narrow)
40392	18379	Rotating Hook Bobbin Case Latch, for 40393
40393	18379	Rotating Hook Bobbin Case Hinge Nos. 2974, 40392, and 125320, for 52237
40394	18379	Rotating Hook Bobbin Case Tension Spring, for 52236
41400	18310	Machine Rest Pin (wood)
43525	22919	Binder Steady Pin, for 121398
44136	23225	Feed Dog, 15 teeth (16 teeth to the inch), for 44137
44137XC	23225	Throat Plate (large needle hole), for 44136
44158	23222	Feed Dog, 15 teeth (14 teeth to the inch), for 44162
44159	23222	Presser Foot Plate, for 44161
44160	23222	" " Shank, for 44161
44161	23222	Presser Foot (hinged) complete, Nos. 26276, 44159 and 44160
44162XC	23222	Throat Plate, for 44158
44243	18361	Machine Hinge Connection, for 150962
44252	23224	Feed Dog, 12 teeth (12 teeth to the inch), for 44255, 44256 and 270129
44253	18315	Feed Dog, 16 teeth (16 teeth to the inch), for 44255, 44256 and 270129
44255XC	-----	Throat Plate (small needle hole), for 44252 and 44253
44256XC	18315	Throat Plate (large needle hole), for 44252 and 44253
50053W	18343	Tucker Space Guide Thumb Screw, for 259530
50117E	18364	Feed Dog, Screw
50134E	18343	Tucker Tuck Guide Base Screw Stud, for 36394
50190W	18381	Attachment Thumb Screw
50202J	23224	Presser Foot Finger Guard Screw, for 36575
50304C	18380	Tension Stud, for 52098
50305C	18380	" " Set Screw, for 52083
51097J	22919	Binder Thumb Screw, for 121168
51097J	22919	Tape Reel Arm Thumb Screw, for 121168
51220AL	18347	Feed Bar Body Adjusting Screw, for 143185

NUMERICAL LIST OF PARTS

No.	Plate	Name
52018	18379	Rotating Hook Bobbin Case Holder Position Bracket
52031	18364	Feed Dog, 19 teeth (22 teeth to the inch), for 52032, 52033 and 143272
52032XC	18364	Throat Plate (large needle hole), for 52031
52033XC	18364	Throat Plate (small needle hole), for 52031
52055	23228	Presser Foot
52056	18315	" "
52082	18380	Thread Take-up Spring, for 270087
52083	18380	" " " " Regulator with 50305C, for 270087
52098	18380	Tension Stud 50304C with 1560C, for 270087
52188	23219	Presser Foot (solid), for Cuff Work
52189	23219	" " " " Collar Work
52190XC	23219	Throat Plate, for 20164
52235	18379	Rotating Hook Bobbin Case, for 52236
52236	18379	" " " " 52235 with 591F, 1380E and 40394, for 52237
52237	18379	Rotating Hook Bobbin Case complete, Nos. 592E, 2975, 40393 and 52236, for 270871 and 270873
52266	18383	Feed Bar Slide Block, for 52267
52267	18383	" " " " 52266 with 125060, for 270024
52390	23221	Presser Foot Shank, for 127234
52462	23226	Feed Dog, 19 teeth (22 teeth to the inch), for 52463
52463XC	23226	Throat Plate, for 52462
52544	23220	Presser Foot Spring, for 143168
56814	18343	Tucker Tuck Guide Bracket Screw Center 307C with 1513J, for 36394
60913	18362	Thread Unwinder Spool Weight with 60914
60914	18362	Thread Unwinder Spool Weight Center Pin, for 60913
62527	18364	Presser Foot Hinge Pin, for 20157, 24983, 40318, 62927, 127234 and 142059
62925	18364	Presser Foot Plate, for 62927
62926	18364	" " Shank, for 62927
62927	18364	Presser Foot (spring hinged) complete, Nos. 26231, 62527, 62925 and 62926
79626	18361	Bench Stand Section (front) with wood screw 1-1/2 in., No. 12, two each 20022, 27878 and wood screws 3-1/2 in., No. 14, for 79628
79627	18361	Bench Stand Section (back) with two each 20022, 27878, 150962 and wood screws 3-1/2 in., No. 14, for 79628
79628	18361	Bench Stand (Sectional) complete, Nos. 79626 and 79627
120143	18315	Presser Foot Plate, for 120144
120144	18315	Presser Foot (hinged) complete, for Button Stays, Nos. 7298, 19335 and 120143

NUMERICAL LIST OF PARTS

No.	Plate	Name
120206	23228	Corder Cord Guide Rod with 457AL, for 120207
120207	23228	Corder (adjustable) complete, for short turns on cushions, Nos. 190D, 1044D, 26795, 26796, and 120206
120208	23228	Presser Foot (grooved)
120342	18310	Oiler (copper plated) with 120343
120343	18310	" Spout (3-1/2 in. long), for 120342
120367	23232	Hemmer on Shank, for handkerchief work
120479	18359	Quilter Guide (left), for 120485
120480	18359	" " (right), for 120485
120481	18359	" " Bracket, for 120482
120482	18359	" " " " 120481 with 120483 and two 209AL, for 120485
120483	18359	Quilter Guide Disengaging Sleeve, for 120482
120484	18359	Quilter Guide Disengaging Sleeve Spring, for 120485
120485	18359	Quilter complete, Nos. 602D, 120479, 120480, 120482 and 120484
120536	18373	Tape Reel Disc with 120538 and 120539, for 121168, 121737 and 259784
120537	18373	Tape Reel Disc Pin, for 121412
120538	18373	" " " Stud (wood), for 120536
120539	18373	" " " " Sleeve (brass), for 120536
120740	23229	Tape Reel Pin, for 121737
120803	23230	Hemmer (foot), for 1/8 in. hem
120804	23230	" " " 5/32 in. hem
120805	23230	" " " 3/16 in. hem
120806	23230	" " " 1/4 in. hem
120807	23230	" " " 5/16 in. hem
120828	23236	Presser Foot (single toe), for gathering, for fine work
120837	23230	Hemmer (foot), plain bottom, for 1/8 in. hem, slotted for lace
120898	23230	Hemmer (foot), for 1/16 in. to 1/8 in. hem, for China Silk, etc.
120911	23230	Hemmer (foot), for 5/32 in. to 1/4 in. hem, for China Silk, etc.
120938	23230	Hemmer (foot), for 3/32 in. hem
120977	18315	Piping Attachment, for 35245
120991	23232	Hemmer on Shank, for 1/16 in. to 1/4 in. hem
121167	22919	Binder Folder on Shank, for 121168
121168	22919	Binder (transverse) on Shank complete, for folded or unfolded bias binding (with tape reel), for general work, for 3/4 in., 7/8 in. and 1 in. tape, Nos. 3146, 120536, 121167, 121169, 121397, 121398, 121412 and two 51097J
121169	22919	Presser Foot, for 121168 and 121737
121397	22919	Feed Dog, 18 teeth (16 teeth to the inch), for 121168
121398XC	22919	Throat Plate with 43525, for 121168
121412	18373	Tape Reel Arm with 8879, 23263 and 120537, for 121168 and 259784

No.	Plate	Name
121444	23226	Feed Dog,13 teeth (16 teeth to the inch),for 26250
121445XC	23226	Throat Plate,for 26250
121446	23228	Feed Dog,spiked teeth,13 teeth (10 teeth to the inch),for 20356, 20357,121447 and 270128
121447XC	23228	Throat Plate,for 121446
121646	23219	Feed Dog,12 teeth (16 teeth to the inch),for Collar Work (second stitching),for 121649
121647	23219	Presser Foot with 121648 and two 337J,for 3/16 in.,7/32 in.,1/4 in., 9/32 in. and 5/16 in. gauges,for Collar Work (second stitching)
121648	23219	Presser Foot Edge Guide,for 3/16 in., 7/32 in.,1/4 in.,9/32 in. and 5/16 in.gauges,for 121647
121649XC	23219	Throat Plate,for 121646
121653	18315	Hemmer on Shank,for 9/16 in. hem,for Button Stays on Shirts
121655	23225	Binder on Shank,for Facing Sleeve Plackets,for 121656
121656	23225	Presser Foot,for Facing Sleeve Plackets,for 121655
121658	23226	Edge Folder with Edge Guide on Shank, for Yoking
121659	23226	Presser Foot Plate,for 121660
121660	23226	Presser Foot (hinged) complete,for Yoking,Nos.7298,19223, and 121659
121662	23224	Joining Attachment with 121844,for Shoulder Joining,for 121663
121663	23224	Presser Foot,for Shoulder Joining,for 121662
121732	23229	Binder (transverse),for 121737
121733	23229	" Throw-out Arm with 192349,for 121737
121734	23229	Binder Throw-out Arm Bracket Rivet,for 121938
121735	23229	Binder Releasing Lever,for 121737
121736	23229	" " " Spring,for 121737
121737	23229	Binder (transverse) with Throw-out Arm complete,for folded or unfolded bias binding (with tape reel),for general work,for 3/4 in.,7/8 in. and 1 in. tape,Nos.724F,940F,35610, 120536,120740,121169,121732,121733, 121735,121736,121738,121938XC and two 1443J
121738	23229	Feed Dog,17 teeth (16 teeth to the inch),for 121737
121758	23230	Feed Dog,13 teeth (16 teeth to the inch),for Hemming Shirts,for 121759
121759XC	23230	Throat Plate (large needle hole),for Hemming Shirts,for 121758
121760	23230	Hemmer (foot),for 1/8 in.hem,for Hemming Shirts,for 121758 and 121759

No.	Plate	Name
121761	23230	Hemmer (foot),with 121981,for 1/8 in. hem,for Hemming Shirts
121762	23230	Hemmer (foot),with 121981,for 5/32 in. hem,for Hemming Shirts
121763	23236	Presser Foot with 121981 with Hemmer with Yielding Top Scroll
121844	-----	Joining Attachment Shank,for 121662
121938XC	23229	Throat Plate with two 121734,for 121737
121944	18360	Presser Foot Shank,for 142059
121945	18360	Presser Foot Spring,for 142059
121981	-----	Hemmer Tongue,for 121761,121762 and 121763
*125060	18383	Feed Bar Slide Block Stud,for 52267
125320	18379	Rotating Hook Bobbin Case Latch Lever, for 40393
127087	23221	Feed Dog,19 teeth (16 teeth to the inch),for 127106,127107 and 270127
127106XC	23221	Throat Plate (large needle hole),for 127087
127107XC	-----	Throat Plate (small needle hole),for 127087
127229	23221	Feed Dog,17 teeth (14 teeth to the inch),for 127238
127233	23221	Presser Foot Plate,for 127234
127234	23221	Presser Foot (spring hinged) complete, Nos.26231,52390,62527 and 127233
127238XC	23221	Throat Plate,for 127229
127257	23221	Nos.127257 to 127259,for 127260
127257	23221	Presser Foot Plate
127258	23221	" " Shank with 665J
127259	23221	" " Thread Cutter
127260	23221	Presser Foot (hinged) complete with Thread Cutter,Nos.239E,127257 to 127259 and 131256
131256	23221	Presser Foot Hinge Pin,for 127260
142057	18360	Feed Dog,21 teeth (22 teeth to the inch),for Shirt Work,for 142060 and 142061
142058	18360	Presser Foot Plate,for 142059
142059	18360	Presser Foot (spring hinged)complete, for Shirt Work,Nos.62527,121944, 121945 and 142058
142060	18360	Throat Plate (small needle hole),for Shirt Work,for 142057 and 142062
142061	18374	Throat Plate (large needle hole),for Shirt Work,for 142057 and 142062
142062	18374	Feed Dog,17 teeth (18 teeth to the inch),for general and shirt work,for 142060 and 142061
143030	18383	Feed Bar
143165	23220	Feed Dog,18 teeth (14 teeth to the inch),for Curtain Work,for 143169
143166	23220	Presser Foot Plate,for 143168
143167	23220	" " Shank,for 143168

No.	Plate	Name
143168	23220	Presser Foot (spring hinged) complete, for Curtain Work, Nos. 26276, 52544, 143166 and 143167
143169XC	23220	Throat Plate (large needle hole) for Curtain Work, for 143165
143170	23222	Feed Dog, 16 teeth (16 teeth to the inch), for Shirt Work, for 143171
143171XC	23222	Throat Plate (large needle hole), for Shirt Work, for 143170
143172	18316	Feed Dog, 18 teeth (18 teeth to the inch), for Shirt Work, for 20160
143173	18316	Feed Dog, 20 teeth (20 teeth to the inch), for Shirt Work, for 20160
143174	23220	Feed Dog, 17 teeth (14 teeth to the inch), for General Work, for 143175
143175XC	23220	Throat Plate (large needle hole), for General Work, for 143174
143185	18347	Feed Bar Body with two each 1607C and 51220AL, for 143187
143186	18347	Feed Bar Shank, for 143187
143187	18347	Feed Bar (tilting adjustable) complete, Nos. 704C, 143185 and 143186
143209	18372	Presser Foot Shank, for 143215
143213	18372	Presser Foot Plate, for 143215
143215	18372	Presser Foot (hinged) long toes, with left hand Yielding Plate complete, Nos. 18055, 143209, 143213, 143317 and 143320
143216	18372	Presser Foot Plate, for 143219
143217	18372	" " Shank, for 143219
143219	18372	Presser Foot (hinged) long toes, with right hand Yielding Plate complete, Nos. 18055, 143216, 143217, 143318 and 143320
143272XC	18364	Throat Plate (medium needle hole), for 52031
143301	18379	Rotating Hook Oil Wick (felt), for 270868
143317	18372	Presser Foot Yielding Plate, for 143215
143318	18372	" " " " " 143219
143320	18372	" " " " Spring, for 143215 and 143219
143349	18382	Rotating Hook Shaft Oil Filter Wick Holder, for 270176
150203	18362	Thread Unwinder Spool Rest Cushion (felt), for 225258
150962	18361	Machine Hinge complete, Nos. 2809, 33887, 44243 and wood screw 1 in., No. 14, F.H. blacked, for 79627
192349	23229	Binder Releasing Lever Spring Position Stud, for 121733
200004E	18381	Arm Screw (short)
200040E	18383	Feed Driving Connection Crank Pinch Screw, for 270805
200040E	18383	Feed Lifting Connection Crank Pinch Screw, for 270015

No.	Plate	Name
200040E	18383	Stitch Regulating Shaft Crank Pinch Screw, for 270822
200041X	18381	Arm Cover Plate Screw
200041X	18381	Rotating Hook Oil Reservoir Cover Screw
200043C	18383	Stitch Regulating Shaft Bushing Set Screw
200054E	18306	Needle Bar Connecting Link Guide Block Screw
200056E	18312	Bobbin Winder Stop Latch Screw, for 259431 and 259462
200070C	18382	Rotating Hook Driving Shaft Connection Belt Pulley Set Screw, for 270169
200077D	18379	Rotating Hook Bobbin Case Holder Position Bracket Screw
200082D	18312	Bobbin Winder Tension Bracket Screw, for 259431 and 259462
200086C	18306	Needle Bar Connecting Stud Pinch Screw, for 270057
200095B	18313	Puller Feed Driving Pinion Cap Screw, for 259474
200113F	18312	Bobbin Winder Brake Clamp Screw, for 259431 and 259462
200126F	18373	Binder Screw, for 259784
200132E	18306	Tension Releaser Screw
200196E	18306	Thread Pull-off Set Screw, for 270063
200293C	18306	Knee Lifter Lifting Link Hinge Screw
200299H	18312	Bobbin Winder Stop Latch Trip Lever Hinge Screw, for 259431 and 259462
200333C	18371	Needle Bar Crank Position Screw, for 270177
200347C	18311	Knee Lifter Rock Lever Stop Stud Set Screw, for 228486
200355H	18380	Thread Retainer Set Screw
200362C	18375	Belt Guard Set Screw, for 270152
200362C	18382	Rotating Hook Driving Shaft Bushing Set Screw
200363AL	18371	Arm Shaft Connection Belt Pulley Set Screw, for 270168
200364C	18313	Puller Feed Driving Pulley Shaft Set Screw, for 259467
200364C	18313	Puller Feed Roll and Shaft (lower) Extension Set Screw, for 295471
200373C	18313	Puller Feed Driving Pulley Set Screw, for 259468
200374C	18371	Needle Bar Connecting Link Hinge Stud Set Screw, for 270099
200378C	18371	Needle Bar Crank Position Screw Check Screw, for 270177
200380C	18312	Bobbin Winder Pulley Set Screw, for 225368 and 259461
200382C	18382	Feed Driving Eccentric Set Screw, for 270809
200382C	18382	Feed Lifting Eccentric Set Screw, for 270023

NUMERICAL LIST OF PARTS

No.	Plate	Name
200382C	18313	Puller Feed Driving Gear Set Screw, for 237751
200382C	18378	Rotary Take-up (small) Driving Shaft Pulley Set Screw, for 270072
200382C	18382	Rotating Hook Driving Shaft Gear Set Screw, for 270035
200383C	18362	Thread Unwinder Spool Rest Rod Set Screw, for 259658
200394C	18383	Feed Bar Center Set Screw, for 270021
200394C	18383	Feed Driving Connection Link Hinge Pin Set Screw
200394C	18313	Puller Feed Roll and Shaft Gear Set Screw, for 259063
200394C	18383	Stitch Regulating Shaft Crank Hinge Stud Set Screw, for 270824
200427C	18381	Knee Lifter Lifting Link Connection Set Screw, for 270049
200434C	18381	Knee Lifter Lifting Rod Connection Set Screw, for 270049
200529C	18311	Knee Lifter Rock Lever Rod Set Screw, for 228370
200545C	18383	Feed Lifting Connection Hinge Screw
200567H	18380	Thread Severing Finger Screw
200650H	18383	Stitch Regulating Lever Hinge Screw
200710	18313	Puller Feed Base Bolt, for 259474
200902D	18313	" " Roll and Shaft (upper) Bearing Screw, for 259467
200996C	18383	Stitch Regulating Lever Stop Block Screw, for 270829
201018C	18362	Thread Unwinder Spool Rest Set Screw, for 225257
201188C	18313	Puller Feed Driving Pulley Shaft Collar Set Screw, for 259470
201188C	18313	Puller Feed Roll and Shaft (lower) Collar Set Screw, for 259470
201215D	18382	Rotating Hook Shaft End Bearing Screw, for 270166
201220C	18382	Feed Driving Eccentric Position Screw, for 270809
201220C	18382	Feed Lifting Eccentric Position Screw, for 270023
201220C	18313	Puller Feed Driving Gear Position Screw, for 237751
201220C	18382	Rotating Hook Driving Shaft Gear Position Screw, for 270035
201346AL	18371	Balance Wheel Set Screw, for 259463, 259465, 270187 and 270189
201499H	18312	Bobbin Winder Tension Stud, for 225461
201520H	18383	Stitch Regulating Lever Connection Hinge Screw Nut
201522E	18383	Feed Lifting Connection Hinge Screw Nut
201524E	18383	Stitch Regulating Shaft Bushing Set Screw Nut
201525E	18343	Tucker Space Guide Base Hinge Screw Nut, for 259529
201531E	18383	Feed Driving Connection Crank Hinge Screw Nut

NUMERICAL LIST OF PARTS

No.	Plate	Name
201572H	18312	Bobbin Winder Tension Stud Thumb Nut, for 225462
201696H	18362	Thread Unwinder Thread Guide Lock Nut, for 225258
202005	18381	Arm Screw Washer
202090	18373	Presser Foot Hinge Pin, for 259782
202248	18383	Stitch Regulating Adjusting Screw Washer
202277	18312	Bobbin Winder Frame Oil Packing (wick), for 225453
202330	18306	Needle Bar Connecting Stud Oil Packing (wick), for 270057
202423	18382	Rotating Hook Shaft Oil Filter Wick, for 270176
202478	18312	Bobbin Winder Stop Latch Trip Lever, for 259431 and 259462
202603	18373	Binder Screw Washer, for 259784
204020	18383	Stitch Regulating Lever Cushion (leather), for 270819
204235	18381	Arm Position Pin
205796	18313	Puller Feed Roll and Shaft (upper) Bearing Spring, for 259467
214206	18371	Arm Shaft Connection Belt Pulley Spring Flange, for 270168
214206	18382	Rotating Hook Driving Shaft Connection Belt Pulley Spring Flange, for 270169
222598	18306	Needle Bar Connecting Link Hinge Stud Oil Packing (wick), for 270143
222598	18382	Rotating Hook Driving Shaft Bushing Oil Packing (wick), for 271062
225190	18313	Puller Feed Driving Belt, size 1/4 in. diam., length 39-1/2 in., with 25128, for 259474
225257	18362	Thread Unwinder Spool Rest (for two spools) (flat) with 201018C, for 225258
225258	18362	Thread Unwinder (for two spools) complete, Nos. 201696H, 225257, 225324, 225326, 225388, 259658, two each 150203, 225391 and three wood screws 7/8 in., No. 12
225322	18362	Thread Unwinder Thread Guide Rod Washer, for 225324
225324	18362	Thread Unwinder Thread Guide Rod with 208AL and 225322, for 225258
225326	18362	Thread Unwinder Thread Guide Position Cup, for 225258
225368	18312	Bobbin Winder Pulley with 200380C, for 259431
225377	18362	Thread Unwinder Spool Wire, for small spools
225381	18312	Bobbin Winder Spindle, for 259431 and 259462
225388	18362	Thread Unwinder Spool Rest Rod, for 225258

No.	Plate	Name
225390	18362	Thread Unwinder Thread Cone Holder
225391	18362	" " " Guide, for
		225258
225421	18316	Hemmer (foot), for 3/32 in. hem
225422	18316	" " " 5/32 in. hem
225423	18316	" " " 5/64 in. hem
225424	18316	" " " 1/8 in. hem
225425	18316	" " " 9/64 in. hem
225426	18316	" " " 3/16 in. hem
225427	18316	" " " 7/32 in. hem
225428	18316	" " " 1/4 in. hem
225434	18316	Bobbin Holder
225444	18312	" Winder Stop Latch, for 259431 and 259462
		Nos. 225453 to 225456, for 259431 and 259462
225453	18312	Bobbin Winder Frame with 202277 and 259660
225454	18312	Bobbin Winder Frame Hinge Pin
225455	18312	" " " Spring
225456	18312	" " " " Plunger
225458	18312	" " " Stop Latch Thumb Lever, for 259431 and 259462
225459	18312	Bobbin Winder Stop Latch Thumb Lever Hinge Stud, for 259431 and 259462
225459	18312	Bobbin Winder Stop Latch Thumb Lever Joint Stud, for 259431 and 259462
225461	18312	Bobbin Winder Tension Bracket with 201499H, for 225462
225462	18312	Bobbin Winder Tension Bracket complete, Nos. 13710, 201572H, 225461 and two 2102, for 259431 and 259462
225604H	18373	Blinder Bracket Thumb Screw Washer, for 259784
225708	18343	Tucker Space Guide Base Spring, for 259529
*227785	-----	Auxiliary Knee Lifter Rock Lever Rod Cap, for 228395
228026	18312	Bobbin Winder Tension Bracket Screw Washer, for 259431 and 259462
228359	18311	Knee Lifter Rock Lever with two 350231C, for 228361
228361	18311	Knee Lifter Rock Lever Bracket 228486 with 228359, 228363, 228367, 228386 and 228455, for 228371
228363	18311	Knee Lifter Rock Lever Hinge Pin, for 228361
228364	18311	Knee Lifter Rock Lever Knee Plate with 350231C, for 228371
228365	18311	Knee Lifter Rock Lever Rod, for 228371
228367	18311	" " " " Stop Stud, for 228361
228370	18311	Knee Lifter Rock Lever Extension with 200529C, for 228371
228371	18311	Knee Lifter Rock Lever complete, Nos. 228361, 228364, 228365, 228370 and 228388

No.	Plate	Name
228372	18311	Drip Pan, with four 3/4 in. wire nails
228386	18311	Knee Lifter Rock Lever Spring, for 228361
228388	18311	Knee Lifter Rock Lever Knee Plate Arm, for 228371
228394	18347	Spool Pin
228395	18361	Auxiliary Knee Lifter Rock Lever Rod with 227785
228396	18361	Auxiliary Knee Lifter Rock Lever Rod Bracket
228455	18311	Knee Lifter Rock Lever Position Spring, for 228361
228486	18311	Knee Lifter Rock Lever Bracket with 200347C and three wood screws 7/8 in., No. 12
232896	18362	Thread Unwinder Spool Pin Arm Bracket with two 448AL
235706	18383	Feed Bar Oiling Wick, for 270139
236245	18380	Thread Guide (lower)
237751	18313	Puller Feed Driving Gear with 200382C and 201220C, for 259474
250522	18310	Screw Driver (for needle set screw)
259055	18313	Puller Feed Base Block (wood) (for use where attachment is not set into the table), for 259474
259057	18313	Puller Feed Driving Pinion, for 259474
*259061	-----	Puller Feed Roll and Shaft (upper) Bearing, for 259467
259063	18313	Puller Feed Roll and Shaft Gear with 200394C, for 259474
259064	18313	Puller Feed Work Guide (wood), for 259474
		Nos. 259370 to 259372, for 259373
259370	18362	Thread Unwinder Spool Pin
259371	18362	" " " " Cap (bake-lite)
259372	18362	Thread Unwinder Spool Pin Washer
259373	18362	Thread Unwinder Spool Pin complete, Nos. 1010F and 259370 to 259372
259378	18362	Thread Unwinder Spool Pin Arm with 217E and 259379
259379	18362	Thread Unwinder Spool Pin Retaining Spring, for 259378
		Nos. 259428 to 259430, for 259431
259428	18312	Bobbin Winder Brake (leather), also for 259462
259429	18312	Bobbin Winder Brake Clamp, also for 259462
259430	18312	Bobbin Winder and Tension Bracket Base
259431	18312	Universal Bobbin Winder complete, Nos. 200056E, 200082D, 200113F, 200299H, 202478, 225368, 225381, 225444, 225453 to 225456, 225458, 225462, 228026, 259428 to 259430, two each 225459 and wood screws 3/4 in., No. 12, R.H.B.

NUMERICAL LIST OF PARTS

No.	Plate	Name
259461	18312	Bobbin Winder Pulley with 200380C, for 259462
259462	18312	Universal Bobbin Winder complete (for "V" belt drives), Nos. 200056E, 200082D, 200113F, 200299H, 202478, 225381, 225444, 225453 to 225456, 225458, 225462, 228026, 259428, 259429, 259461, 259662, two each 225459 and wood screws 3/4 in., No. 12, R.H.B.
259463	18313	Balance Wheel, belt grooves 2-1/8 and 1 in. diam., with 201346AL and 350107AL, for 259464
259464	18313	Balance Wheel 259463 with 270004, for 259474
259465	18313	Balance Wheel, belt grooves 2.9 in. outside diam. for 3/8 in. "V" belt and 1 in. bottom diam. for round belt, with 201346AL and 350107AL, for 259466
259466	18313	Balance Wheel 259465 with 270004 Nos. 259467 to 259472, for 259474
259467	18313	Puller Feed Base with 200364C, 259061, two each 200902D and 205796
259468	18315	Puller Feed Driving Pulley (belt groove 4-1/4 in. diam.) with 200373C
259469	18313	Puller Feed Driving Pulley Shaft
259470	18313	" " " " " "
259470	18313	Collar with 201188C
259470	18313	Puller Feed Roll and Shaft (lower) Collar with 201188C
259471	18313	Puller Feed Roll and Shaft (lower) with 200364C
259472	18313	Puller Feed Roll and Shaft (upper)
259474	18313	Puller Feed Device complete, Nos. 200095B, 225190, 237751, 259055, 259057, 259064, 259464, 259467 to 259469, 259471, 259472, two each 9842R, 200710, 259063 and 259470
259477	18310	Screw Driver, 5 in. long
259502	18359	Finger Guard
259529	18343	Tucker Space Guide Base with 35512, 35514, 201525E, 225708, 350472H and two 1426E, for 259530
259530	18343	Tucker Space Guide complete, Nos. 35511, 35513, 35515, 36387, 50053W, 259529, two each 1657D and 1771B, for 259532
259532	18343	Tucker (long arm) complete, Nos. 36394, 259530 and 259541
259541	18343	Presser Foot, 50 needle hole, for 259532
259542	18343	Presser Foot, 53 needle hole, 1/16 in. gauge to left of needle hole
259543	18343	Presser Foot, 53 needle hole, 3/32 in. gauge to left of needle hole
259544	18343	Presser Foot, 53 needle hole, 1/8 in. gauge to left of needle hole

NUMERICAL LIST OF PARTS

No.	Plate	Name
259545	18343	Presser Foot, 53 needle hole, 5/32 in. gauge to left of needle hole
259658	18362	Thread Unwinder Spool Stand with 200383C, for 225258
259660	18312	Bobbin Winder Frame Oil Well Washer, for 225453
259662	18312	Bobbin Winder and Tension Bracket Base, for 259462
259778	18373	Nos. 259778 to 259780, for 259784
259779	18373	Binder, for 7/8 in. binding
259780	18373	" Bracket
259781	18373	Feed Dog
259782	18373	Presser Foot Plate, for 259782
259782	18373	Presser Foot (spring hinged) complete, Nos. 26231, 202090, 259781 and 270643, for 259784
259783	18373	Throat Plate, for 259784
259784	18373	Binder complete, for 7/8 in. bias binding, Nos. 207D, 120536, 121412, 200126F, 202603, 225604H, 259778 to 259780, 259782, 259783 and 350511D
268258	18382	Rotating Hook Shaft Bushing Oil Packing (wick), for 270166
270002	18381	Arm Cover Plate (back)
270004	18371	Arm Shaft Ball Bearing (back), for 259464, 259466, 270188 and 270190
270005	18371	Arm Shaft Ball Bearing (front), for 270177
270009	18381	Bed Slide
270010	18379	Rotating Hook Bobbin
270012	18383	Feed Bar Center
270015	18383	Feed Lifting Connection Crank with 200040E
270016	18383	Feed Driving Connection Needle Bearing, for 270804
270016	18383	Feed Lifting Connection Needle Bearing, for 270828
270021	18383	Feed Driving Rock Shaft with two 200394C
270022	18383	Feed Driving Rock Shaft Center
270022	18383	Feed Lifting Rock Shaft Center
270023	18382	" " Eccentric with 200382C and 201220C
270024	18383	Feed Lifting Rock Shaft with 52267
270032	18378	Rotary Take-up (small) Driving Shaft Ball Bearing
270032	18382	Rotating Hook Driving Shaft Ball Bearing
270035	18382	Rotating Hook Driving Shaft Gear (internal teeth) with 200382C and 201220C
270036	18382	Rotating Hook Driving Shaft Oil Lead Wire
270038	18381	Rotating Hook Oil Reservoir Cover
270039	18381	" " " " " "
		Gasket

No.	Plate	Name
270043	18306	Needle Bar Connecting Link Needle Bearing, for 270054
270044	18382	Rotating Hook Shaft Thrust Washer, for 270166
270045	18306	Knee Lifter Lifting Link
270048	18381	" " " Rod Connection
270049	18381	" " Rock Shaft with 200427C and 200434C
270050	18306	Needle Bar with 350445F
270053	18306	" " Connecting Link, for 270054
270054	18306	" " " " 270053 with 270043
270055	18306	Needle Bar Connecting Link Guide Block
270057	18306	Needle Bar Connecting Stud with 200086C and 202330
270058	18306	Needle Bar Oiling Felt
270059	18306	Presser Bar with 176J
270060	18306	" " Bushing
270061	18306	" " Lifter
270062	18306	" " Lifting Releasing Lever Bracket
270063	18306	Presser Bar Position Guide with 200196E and 350411C
270064	18381	Presser Bar Spring
270068	18378	Rotary Take-up (small) Driving Shaft
270069	18378	" " " " " " Connection Belt
270072	18378	Rotary Take-up (small) Driving Shaft Pulley with two 200382C
270076	18306	Tension Releaser (adjustable)
270077	18306	Thread Guide (on needle bar bushing)
270079	18306	Thread Pull-off
270080	18380	Thread Retainer
*270084	18371	Arm Shaft, for 270177
270086	18380	Tension Releasing Pin, for 270087
270087	18380	Tension complete, Nos. 13710, 32572, 52082, 52083, 52098, 270086 and two 2102
270094	18381	Knee Lifter Lifting Rod
270095	18306	Presser Bar Lifting Releasing Lever Bracket Spring
270096	18380	Thread Guide
*270099	18371	Needle Bar Crank with 200374C, for 270177
270100	18306	Needle Bar Connecting Link Thrust Washer
270114	18359	Presser Bar Bushing (for use with Quilter 120485)
270120	18360	Hemmer (foot), for 1/8 in. hem, for hemming shirts
270121	18360	Feed Dog, for 270122
270122	18360	Throat Plate (small needle hole), for 270121
270124	18306	Needle Bar Bushing (lower)
270127	18345	Throat Plate (large needle hole), for 127087

No.	Plate	Name
270128	18345	Throat Plate (large needle hole), for 121446
270129	18345	Throat Plate (large needle hole), for 44252 and 44253
270130	18345	Throat Plate (large needle hole), for 26603
270134	18374	Hemmer Foot, for 5/32 in. hem
270136	18374	" " " 3/16 in. hem
270138	18383	Feed Bar Oiling Wick Holder, for 270139
270139	18383	" " " " " 270138 with 235706
270143	18306	Needle Bar Connecting Link Hinge Stud with 222598 and 270161
270144	18380	Face Plate
270147	18378	Rotary Take-up (small) Thread Cast-off Pin, for 270906
270148	18380	Rotary Take-up Guard
270150	18380	Thread Severing Finger
270151	18380	" " " Guard
270152	18375	Belt Guard with two 200362C, for 270154
270153	18375	" " Bracket, for 270154
270154	18375	Belt Guard complete, Nos. 270152, 270153 and two 350328H
270155	18382	Rotating Hook Oil Reservoir Oil Gauge
270156	18380	Thread Severing Finger Guard Hinge Screw Spring Washer
270161	18306	Rotary Take-up (large) Position Pin, for 270143
		Nos. 270162 to 270164, for 270166
270162	18382	Rotating Hook Shaft
270163	18382	" " " Bushing
270164	18382	" " " End Bearing
270166	18382	Rotating Hook Shaft Bushing complete, Nos. 268258, 270044, 270162 to 270164, 270176, 350498E and two 201215D
270167	18371	Arm Shaft Connection Belt
270168	18371	" " " " Pulley and Rotary Take-up Driving Pulley with 200363AL, 350492C and three 214206
270169	18382	Rotating Hook Driving Shaft Connection Belt Pulley with 214206 and two 200070C
270176	18382	Rotating Hook Shaft Oil Filter complete, Nos. 143349 and 202423, for 270166
270177	18371	Arm Shaft 270084 with 200333C, 200378C, 270005 and 270099
270187	18371	Balance Wheel (aluminum alloy casting) for "V" Belt (outside diam. of belt groove 2.9 in.) (rim diam. 4 in.) with 201346AL and 350107AL, for 270188
270188	18371	Balance Wheel 270187 with 270004

No.	Plate	Name
270189	18371	Balance Wheel (aluminum alloy casting) for 5/16" round belt (diam. of belt groove 1-13/16 in.) (rim diam. 4 in.) with 201346AL and 350107AL, for 270190
270190	18371	Balance Wheel 270189 with 270004
270195	18372	Presser Foot, for gathering
270196	18372	" " " Slide Fasteners
270261	18306	Needle Bar Bushing (upper)
270285	18381	Knee Lifter Lifting Link Connection
270643	18373	Presser Foot Shank, for 259782
270653	18383	Feed Driving Connection Crank Needle Bearing, for 270806
270653	18383	Stitch Regulating Shaft Crank Needle Bearing, for 270823
*270801	-----	Arm
*270802	-----	Bed
270803	18383	Feed Driving Connection, for 270804
270804	18383	" " " 270803 with 270016
270805	18383	Feed Driving Connection Crank with 200040E, for 270806
270806	18383	Feed Driving Connection Crank 270805 with 270653
270807	18383	Feed Driving Connection Link
270808	18383	" " " " Hinge Pin
270809	18382	" " Eccentric with 200382C and 201220C
270813	18382	Rotating Hook Driving Shaft
270815	18383	Stitch Regulating Adjusting Screw Washer (leather)
270816	18383	Stitch Regulating Index Plate, for 270829
270817	18383	Stitch Regulating Lever
270818	18383	" " " Connection
270819	18383	" " " Stop Block with 204020, for 270829
270820	18383	Stitch Regulating Shaft
270821	18383	" " " Bushing (split)
270822	18383	Stitch Regulating Shaft Crank with 200040E, for 270823
270823	18383	Stitch Regulating Shaft Crank 270822 with two 270653
270824	18383	Stitch Regulating Shaft Crank Link with two 200394C
270825	18383	Stitch Regulating Shaft Crank Hinge Stud
270826	18380	Rotary Take-up (large)
270827	18383	Feed Lifting Connection, for 270828
270828	18383	" " " 270827 with 270016
270829	18383	Stitch Regulating Index Plate 270816 with two each 200996C and 270819
270868	18379	Rotating Hook with 143301 and two 1253AL, for 270869

No.	Plate	Name
270869	18379	Rotating Hook 270868 with 270874 and four 1053E, for 270870
270870	18379	Rotating Hook 270869 with 270872, 270876 and three 1367E, for 270871
270871	18379	Rotating Hook 270870 with 52237
270872	18379	" " Bobbin Case Holder (chromium plated), for 270870 and 270873
270873	18379	Rotating Hook Bobbin Case 52237 with 270872
270874	18379	Rotating Hook Thread Guard, for 270869
270876	18379	" " Section, for 270870
270906	18378	Rotary Take-up (small) with 270147 and 350418C
271032	18380	Rotary Take-up (large) Thread Guide
271062	18382	Rotating Hook Driving Shaft Bushing with 222598
350107AL	18371	Balance Wheel Position Screw, for 259463, 259465, 270187 and 270189
350231C	18311	Knee Lifter Rock Lever Extension Set Screw, for 228359
350231C	18311	Knee Lifter Rock Lever Knee Plate Arm Set Screw, for 228359
350231C	18311	Knee Lifter Rock Lever Knee Plate Set Screw, for 228364
350277C	18383	Feed Driving Rock Shaft Center Set Screw
350277C	18383	Feed Lifting Rock Shaft Center Set Screw
350277C	18382	Rotating Hook Shaft Bushing Set Screw
350328H	18375	Belt Guard Bracket Screw, for 270154
350390E	18381	Arm Screw (long)
350411C	18306	Presser Bar Position Guide Pinch Screw, for 270063
350418C	18378	Rotary Take-up (small) Set Screw, for 270906
350435C	18381	Presser Bar Spring Screw (pressure regulating)
350442C	18306	Presser Bar Lifter Hinge Screw
350445F	18306	Needle Set Screw, for 270050
350472H	18343	Tucker Space Guide Base Hinge Screw, for 259529
350486XC	18380	Thread Severing Finger Guard Hinge Screw
350489AL	18306	Needle Bar Bushing (upper) Set Screw
350492C	18371	Arm Shaft Connection Belt Pulley Position Screw, for 270168
350498E	18382	Rotating Hook Shaft Oil Regulating Screw, for 270166
350499XC	18381	Presser Bar Spring Screw Stud
350503H	18380	Face Plate Screw
350503H	18380	Rotary Take-up Guard Screw
350503H	18380	Thread Guide Screw
350507C	18383	Feed Driving Connection Crank Hinge Screw
350508X	18383	Stitch Regulating Adjusting Thumb Screw

NUMERICAL LIST OF PARTS

No.	Plate	Name
350509C	18383	Stitch Regulating Lever Connection Hinge Screw
350511D	18373	Binder Bracket Thumb Screw, for 259784

Genuine SINGER Needles should be
used in SINGER Machines.
These Needles and their Containers
are marked with the
Company's Trade-Mark "SIMANCO." 1

Needles in Containers marked
"FOR SINGER MACHINES"
are NOT **SINGER** made needles. 2

ILLUSTRATIONS
OF
PARTS.

18306 - 1/2

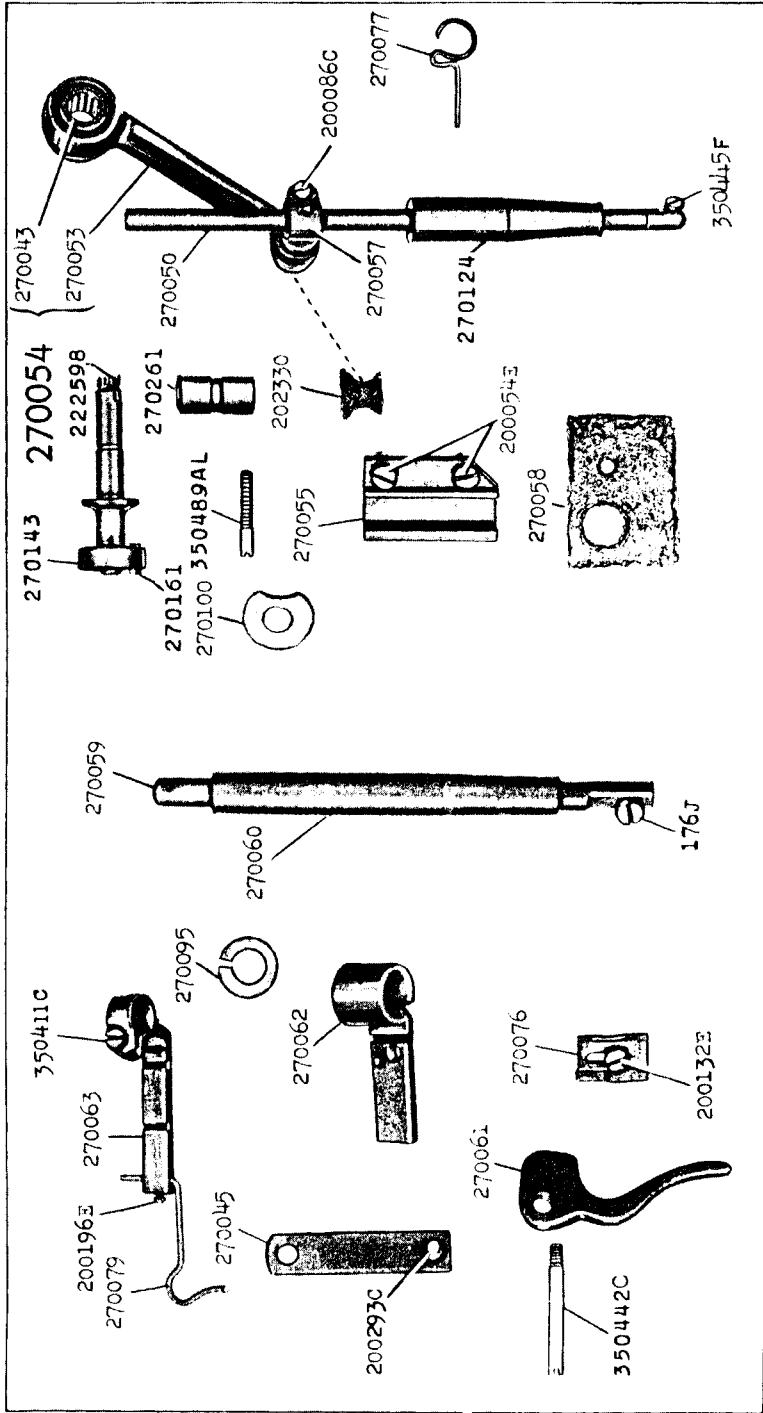

18310 - 1/2

250522



259477



41400



120342

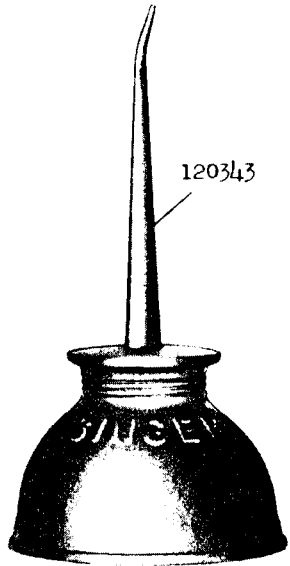

25878

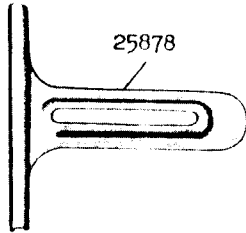

12361

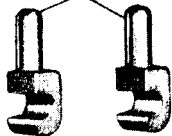

18311 - 1/4

228372

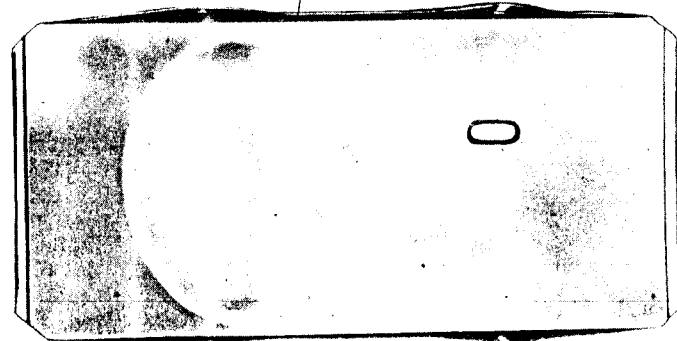

228371

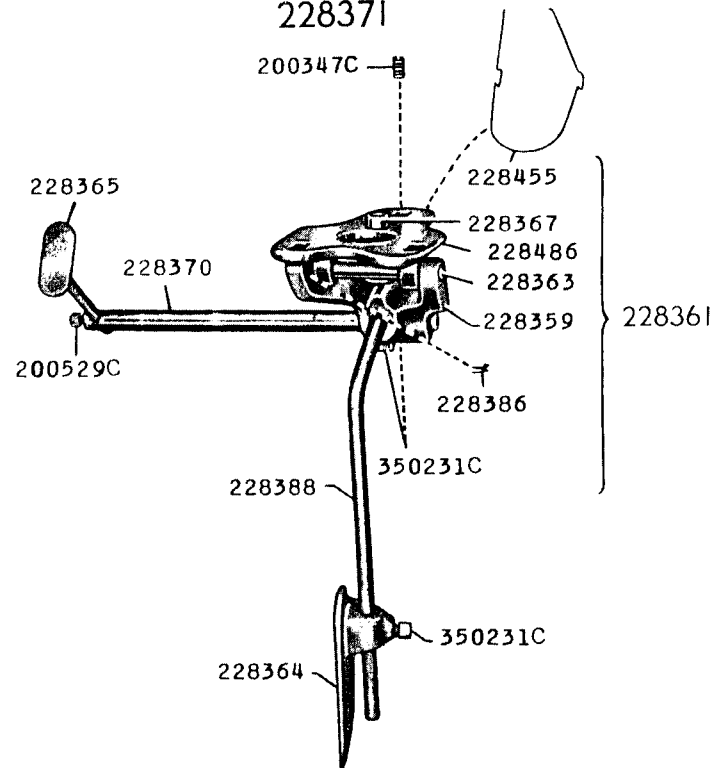

18312 - 3/8

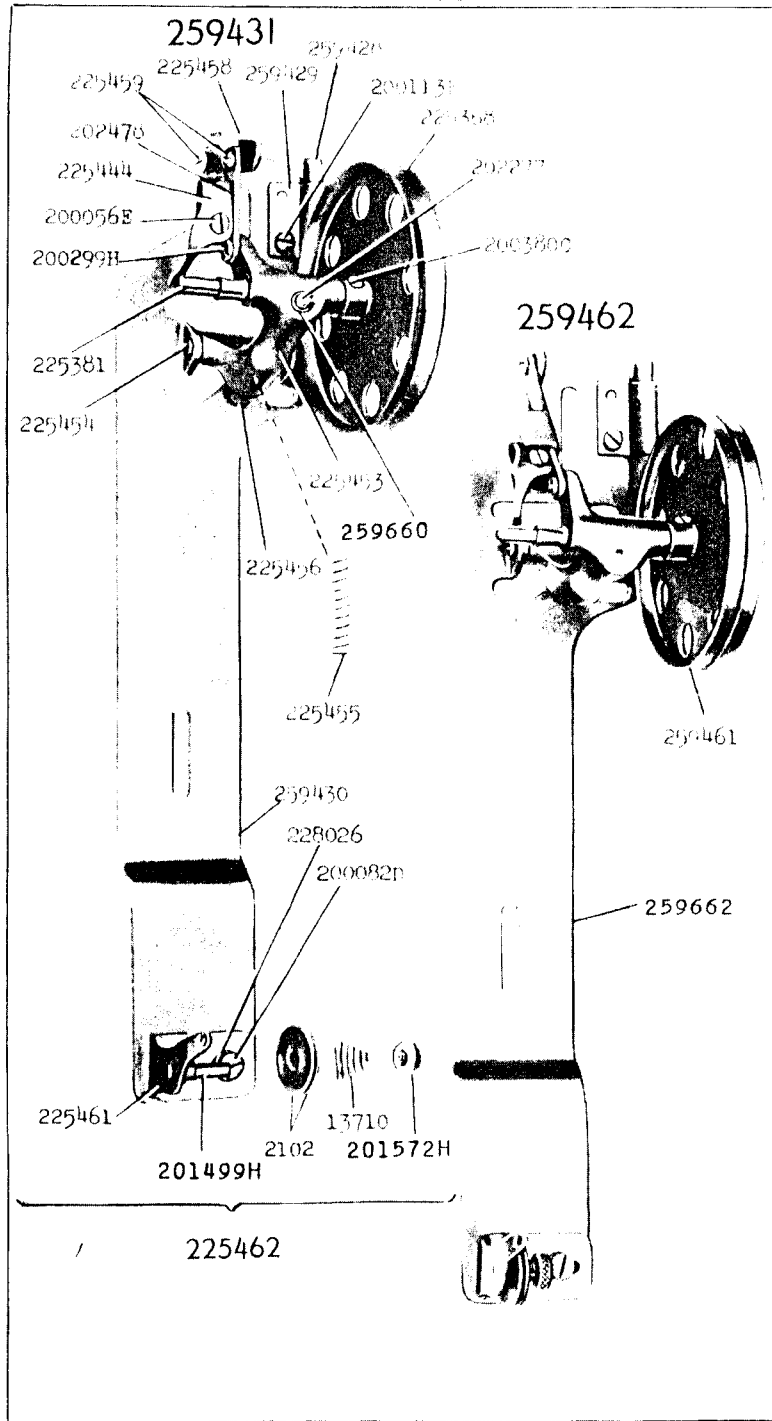

18313 - 1/3

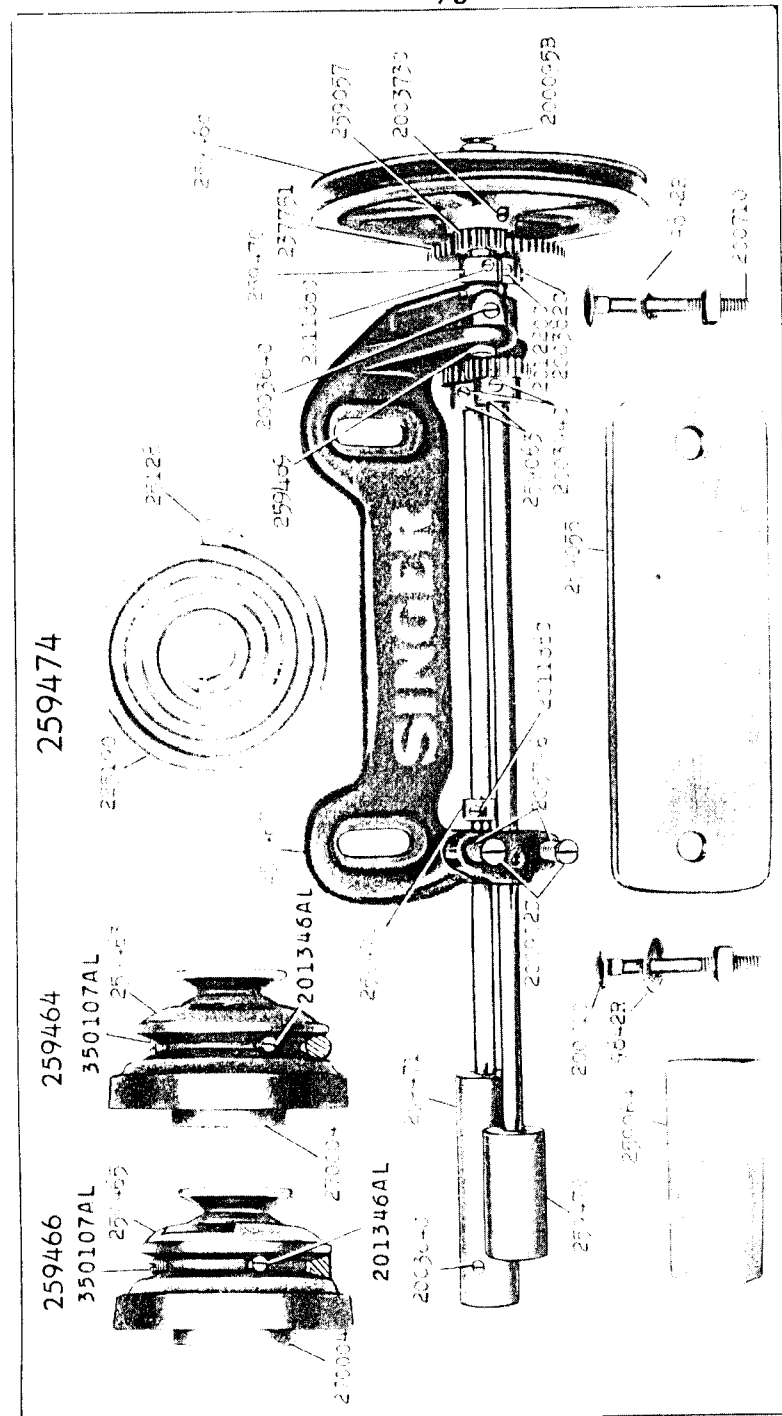

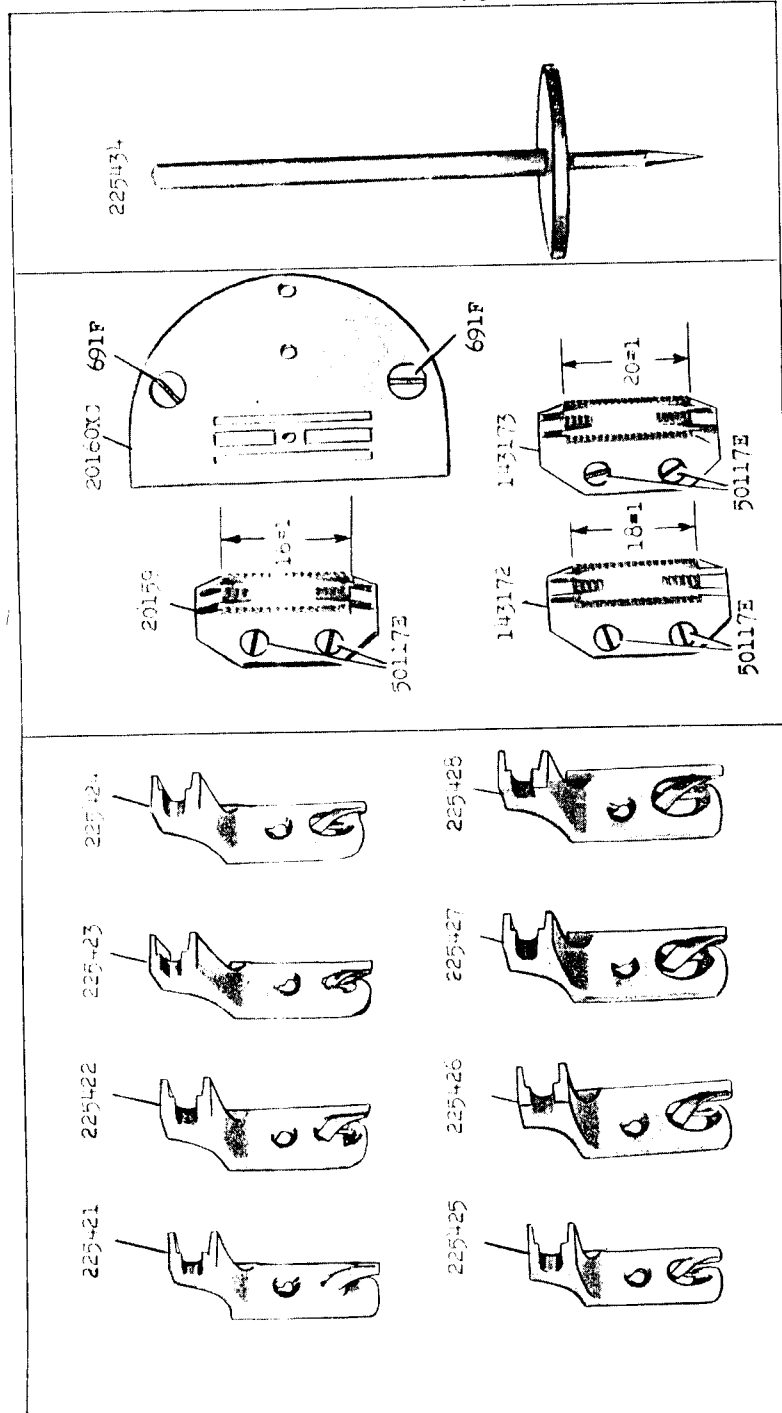
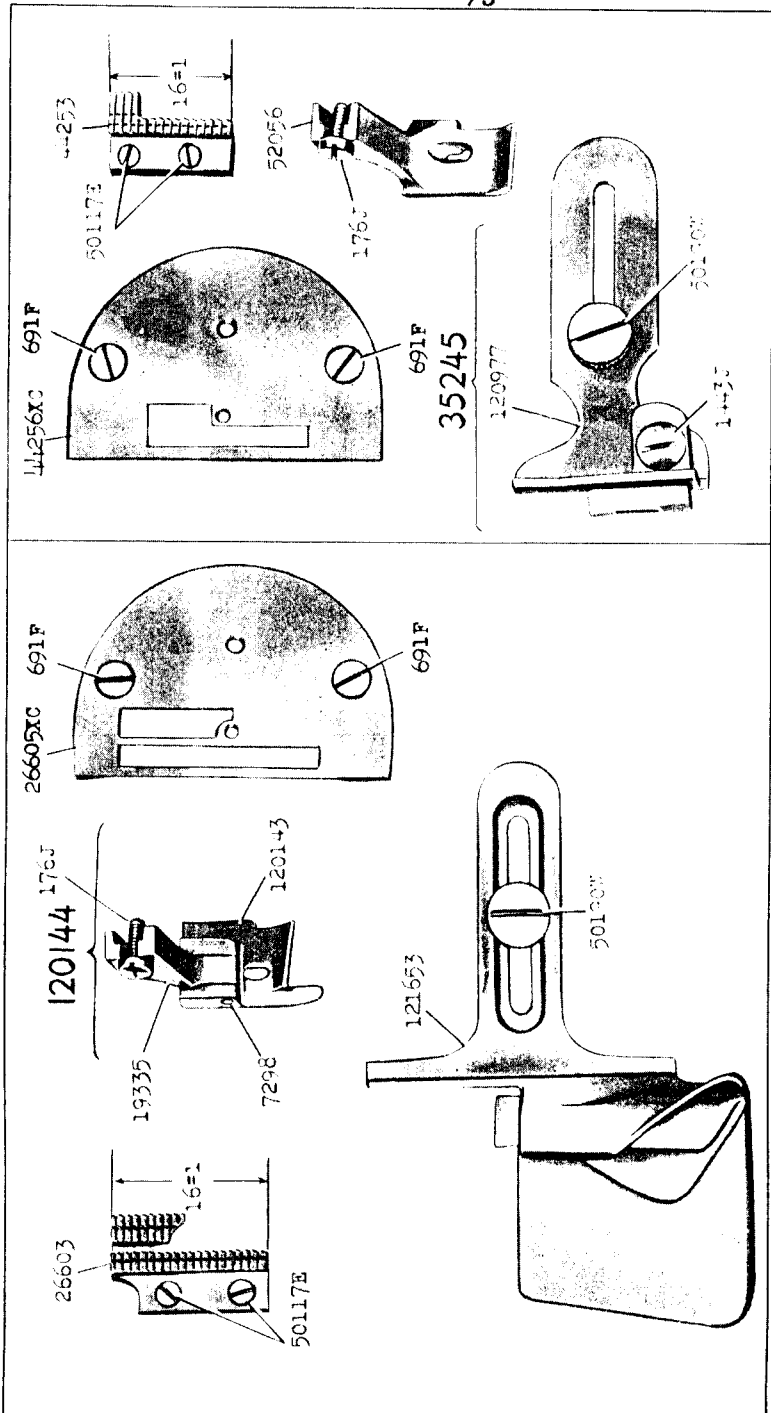

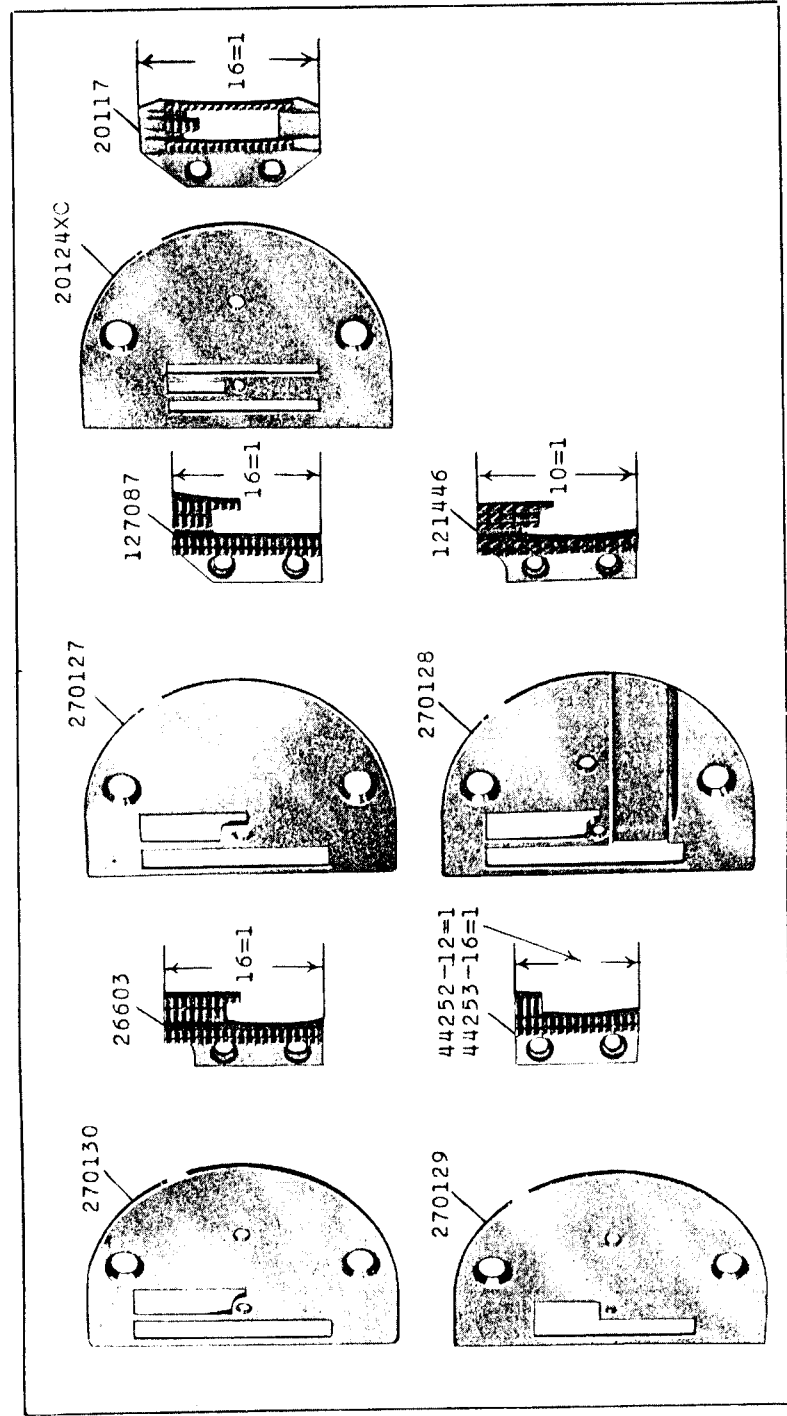
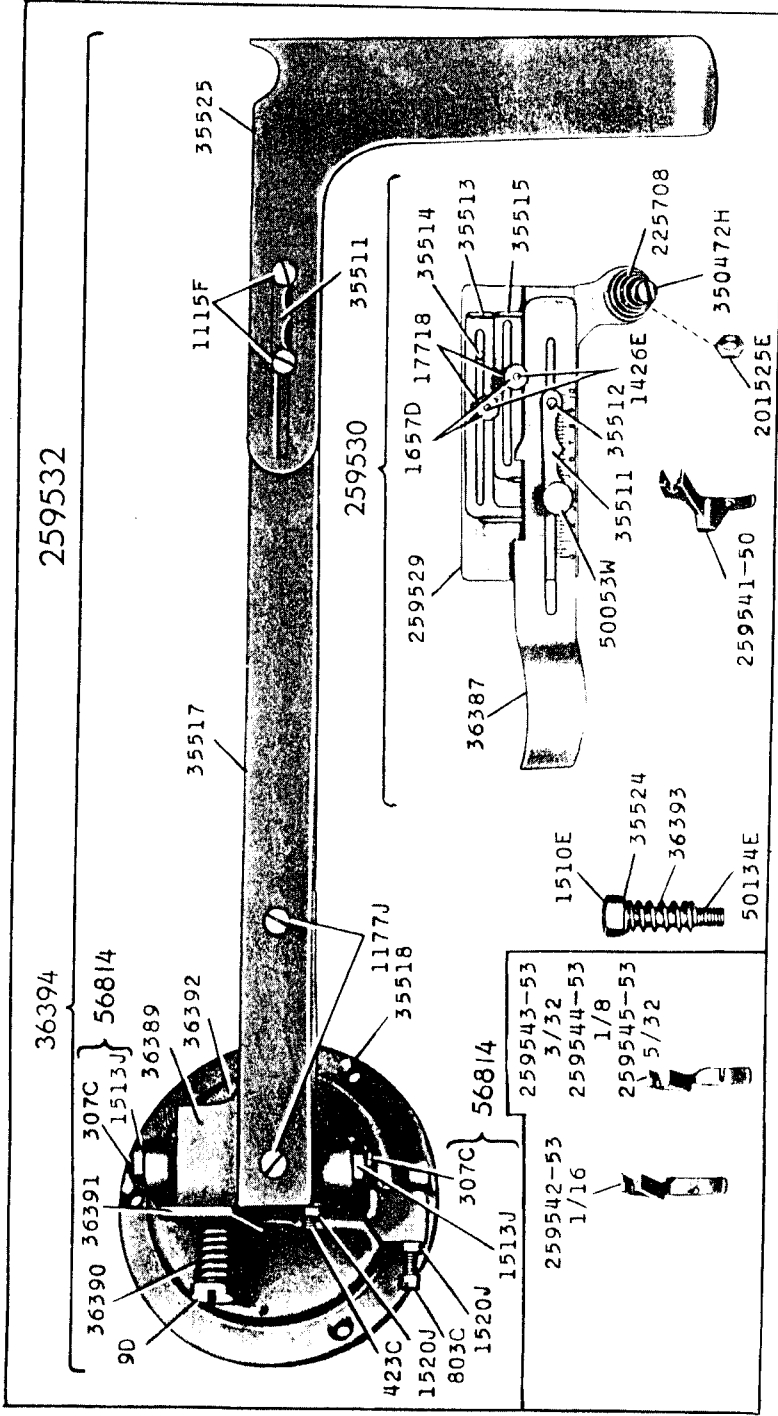

18347

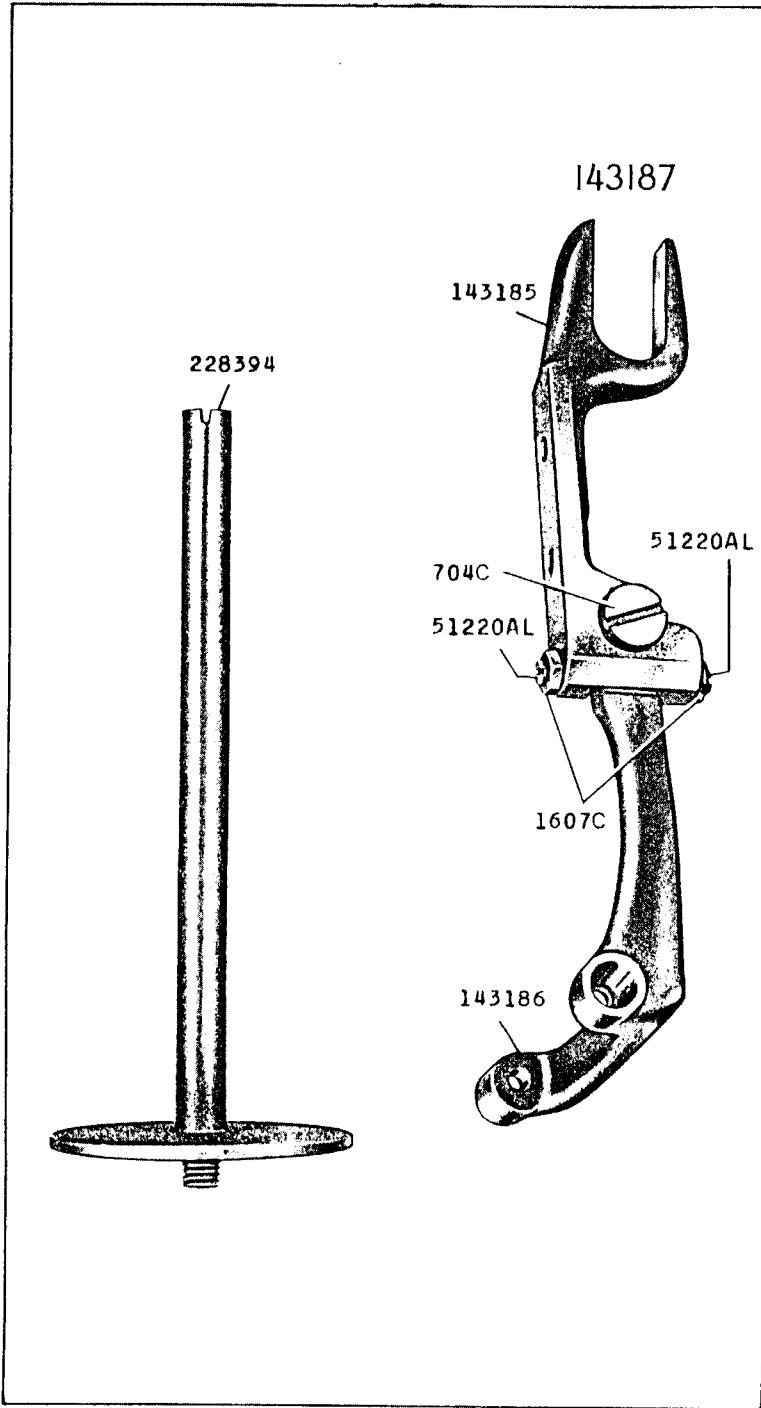

18359 - 1/2

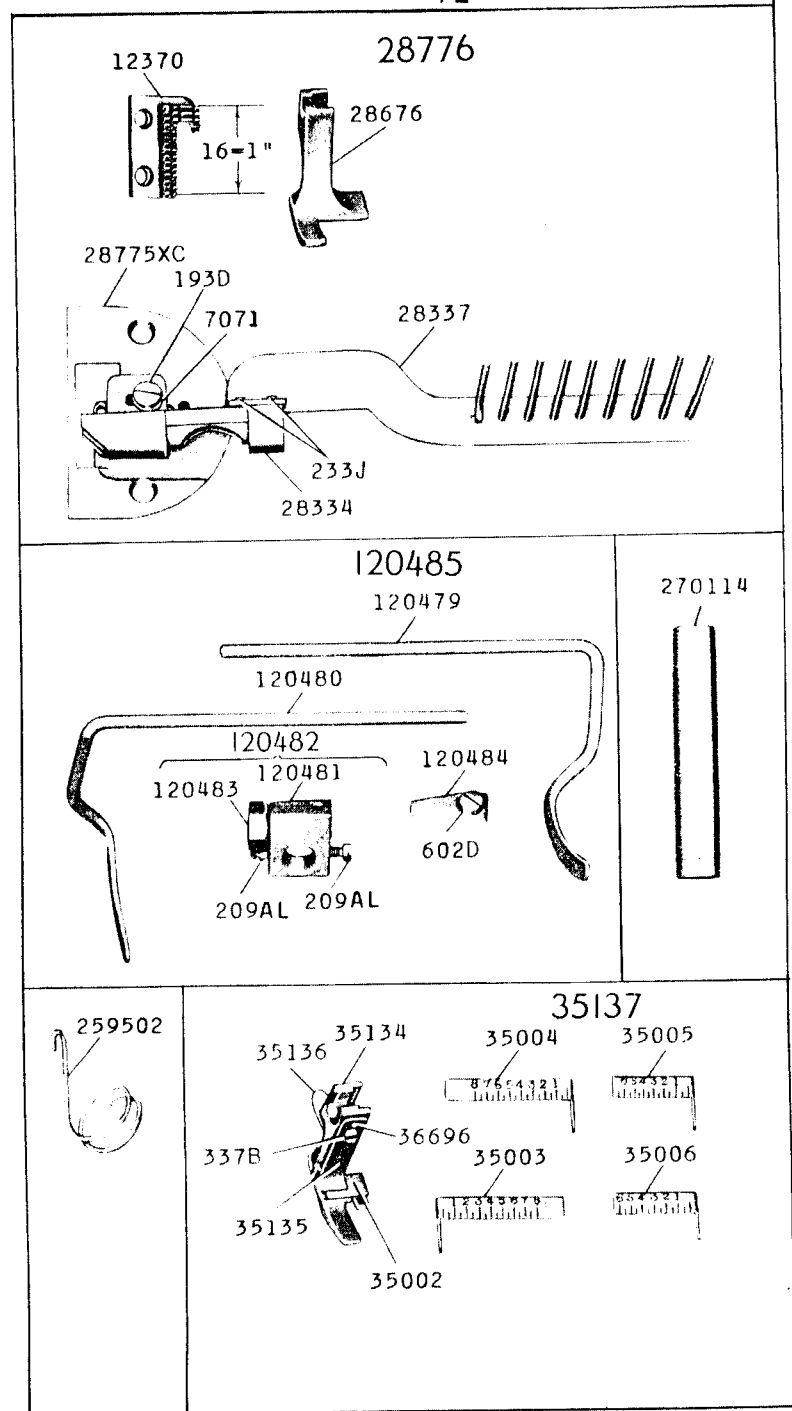

18360 - 2/3

142059

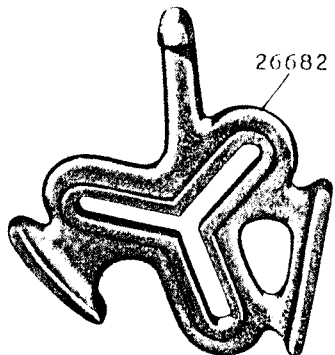
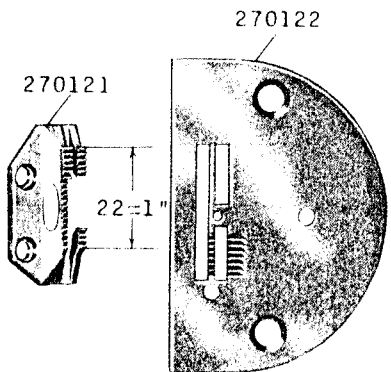
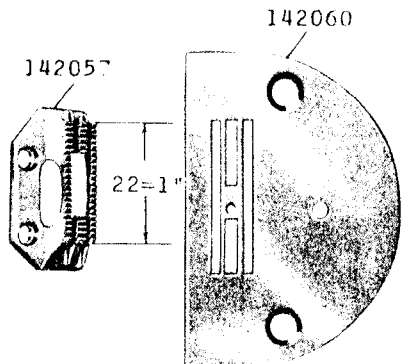
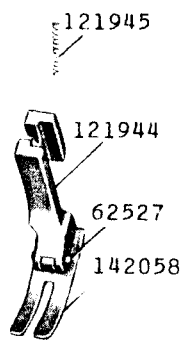

18361 - 1/4

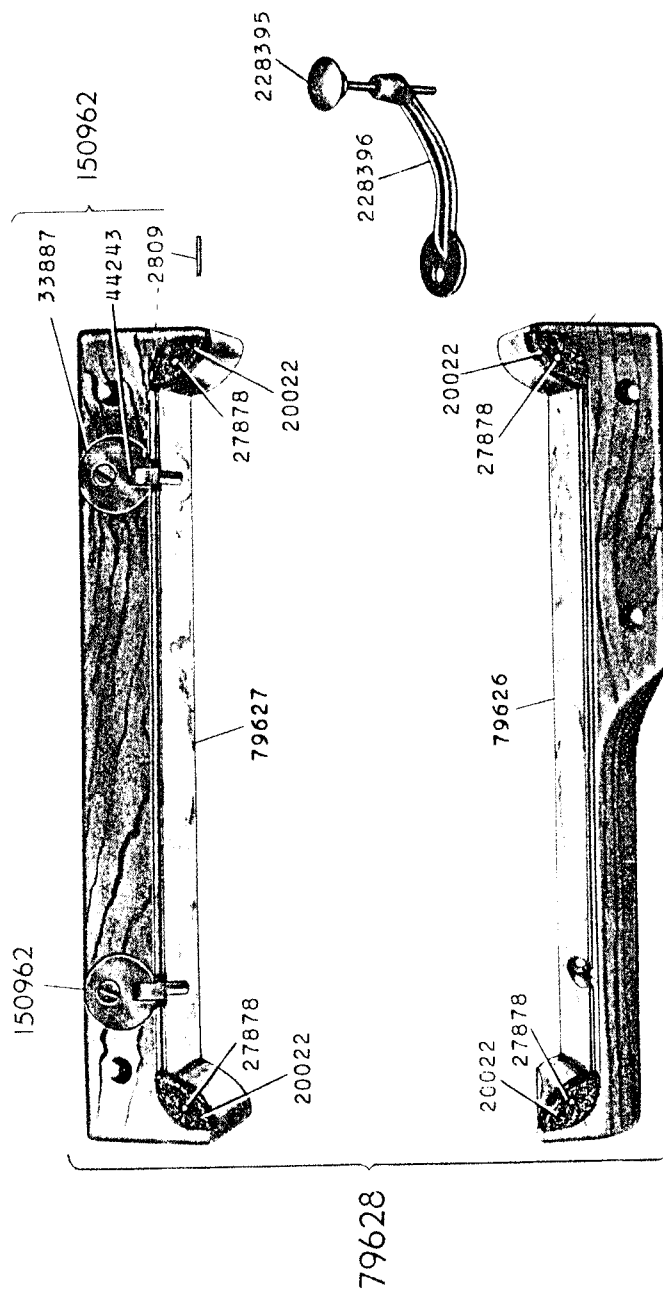

18362 - 1/6

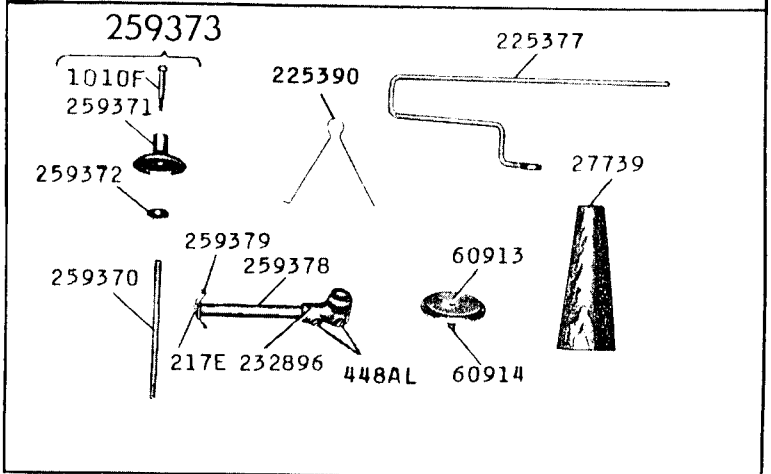
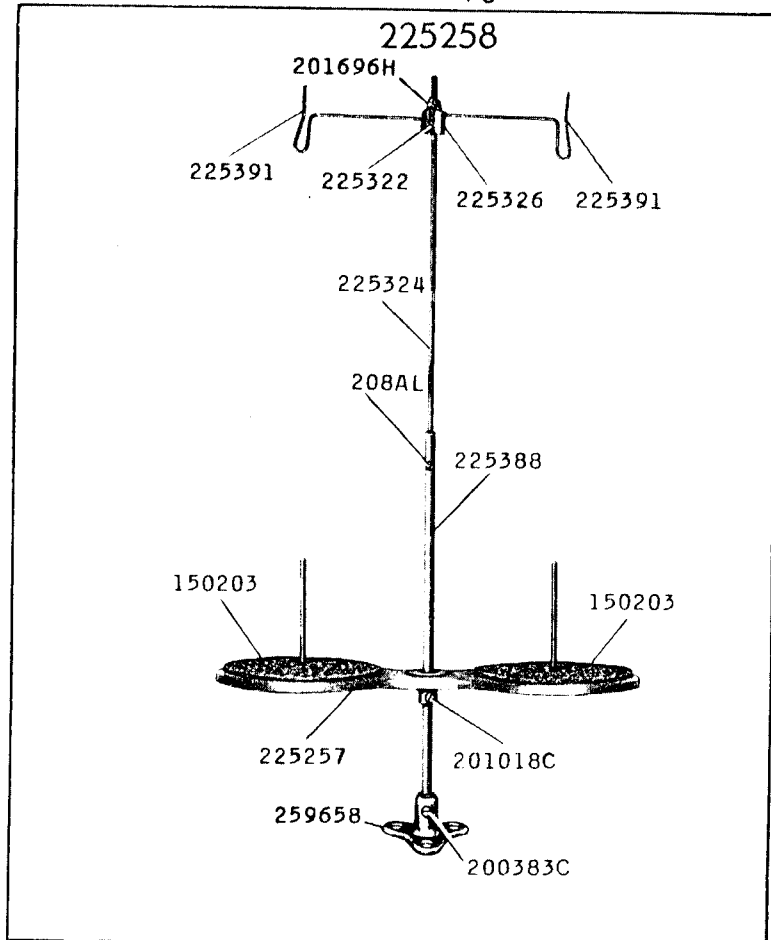

18364

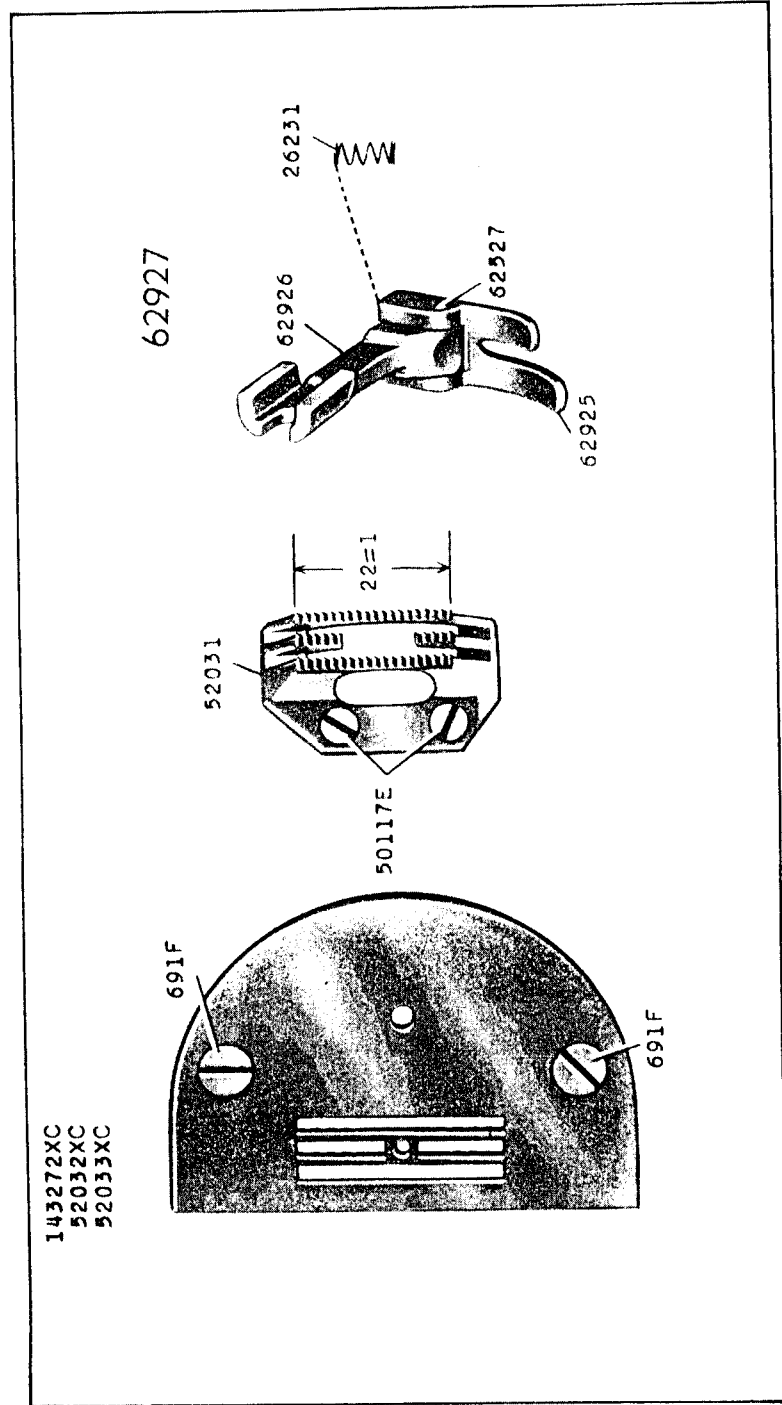

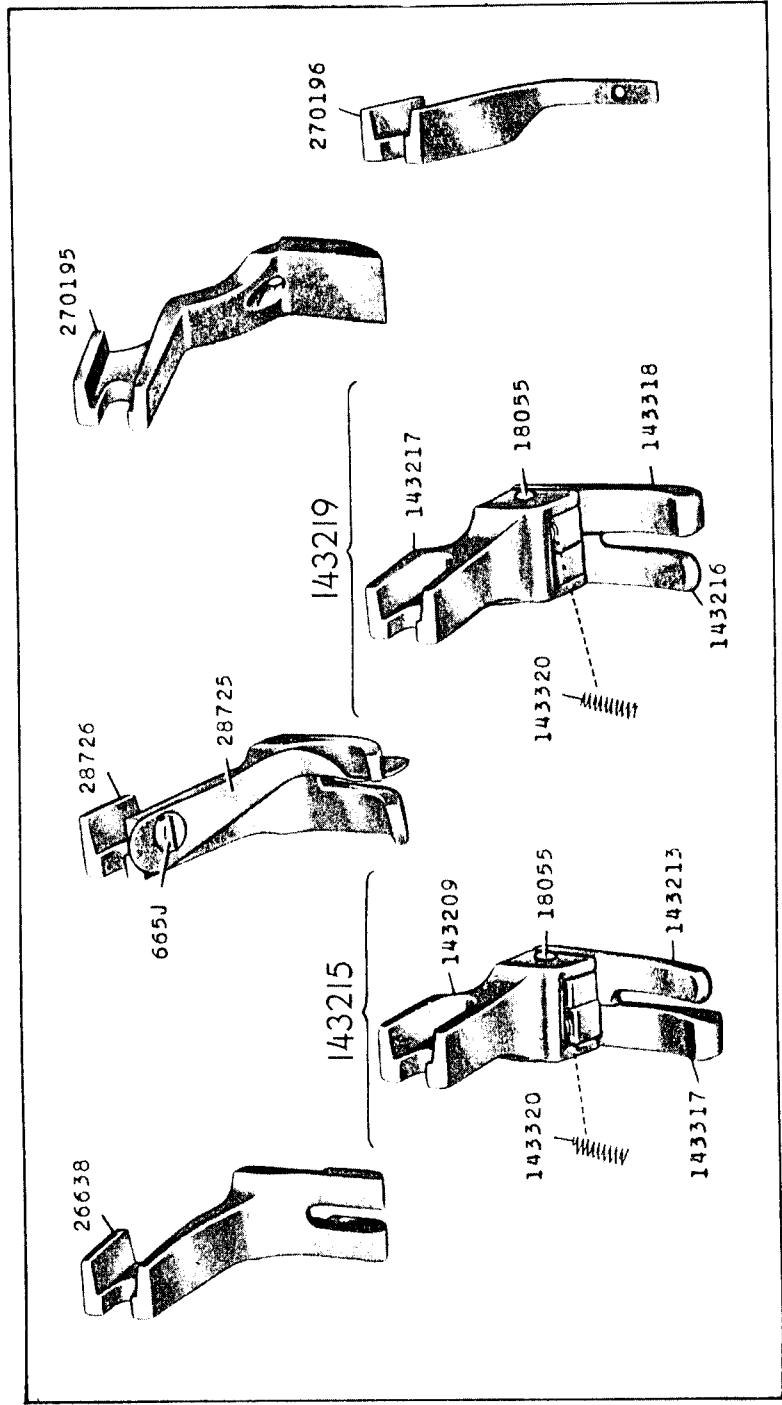
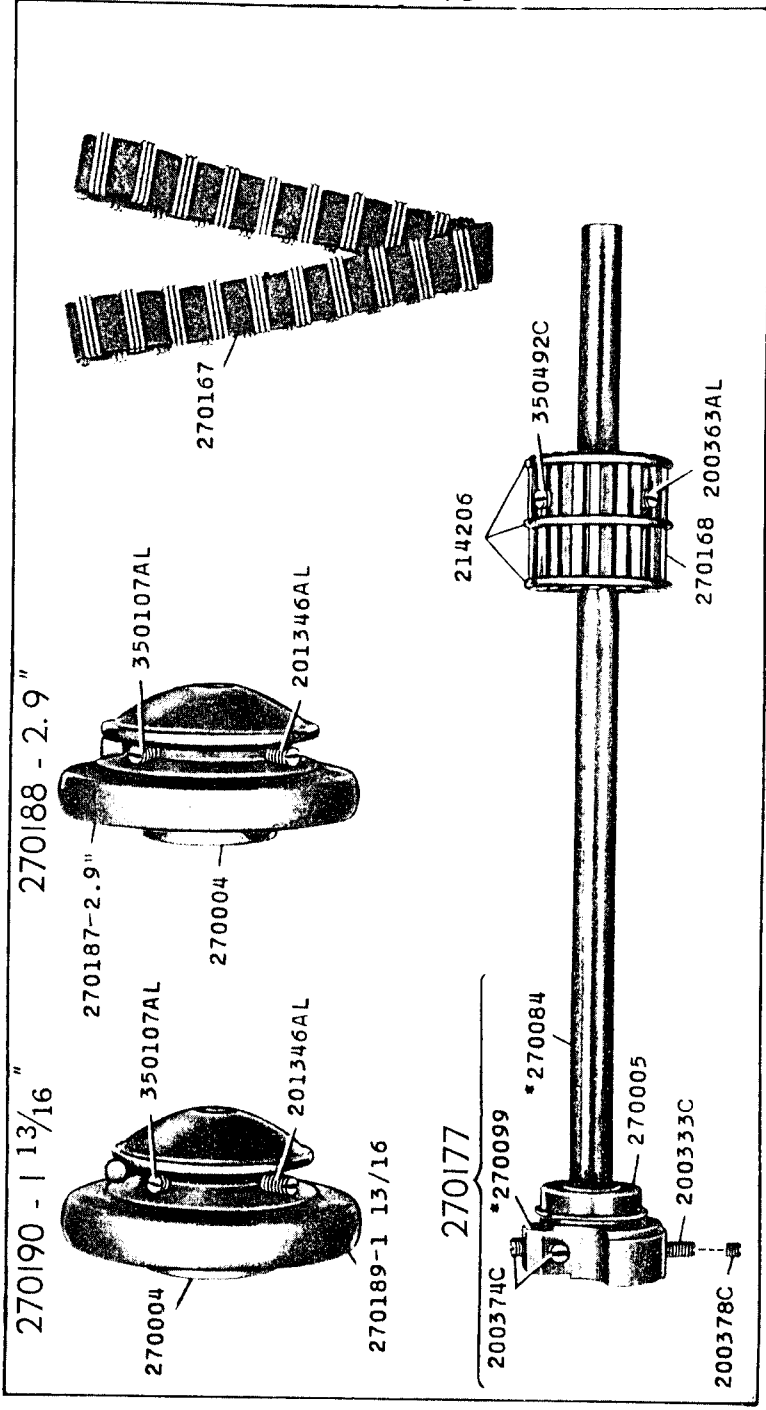

259784

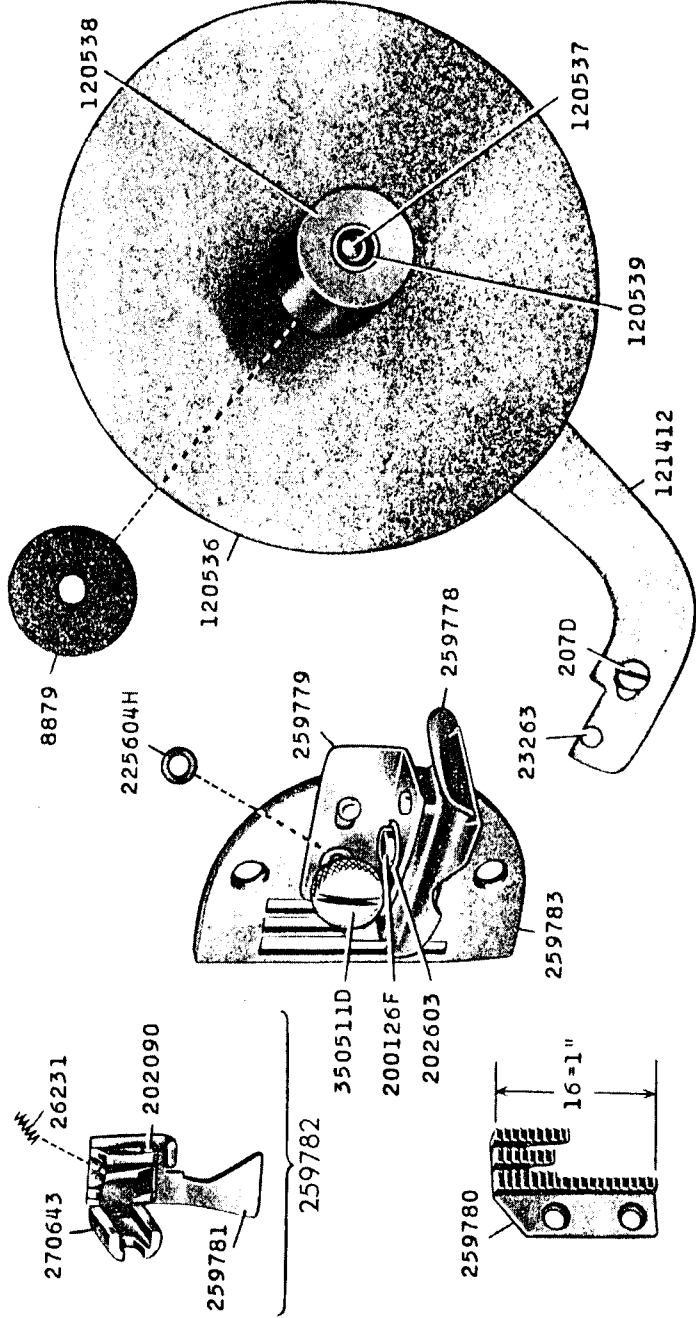

142059

270120-1/8" 270134-5/32" 270136-3/16"

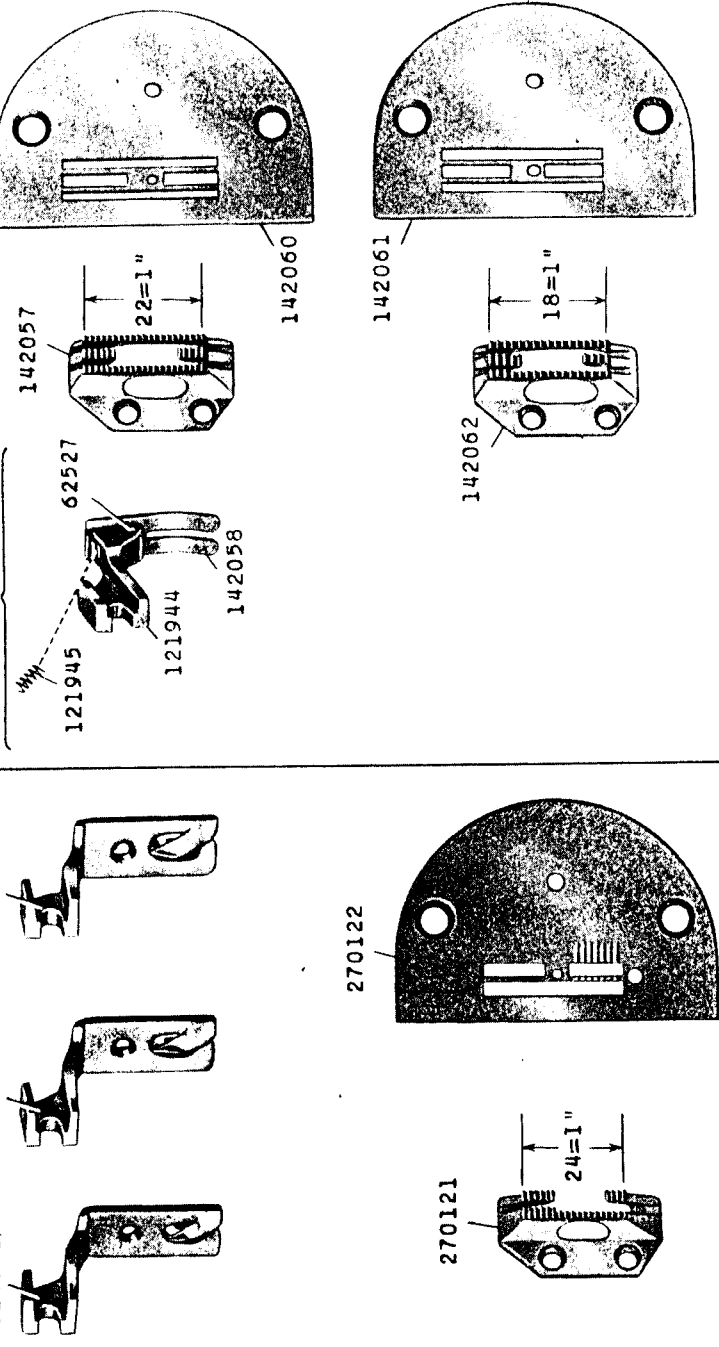

18375 - 2/3

270154

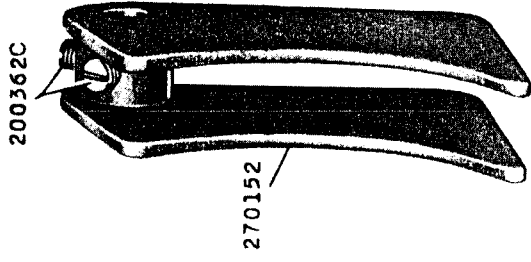
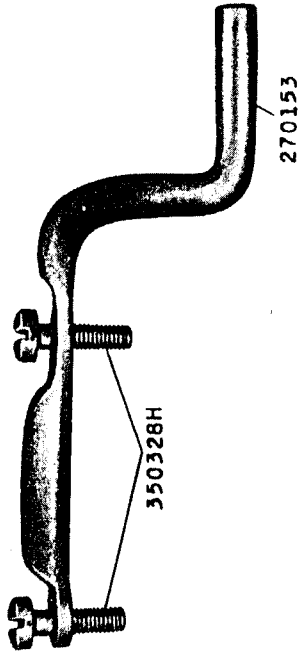

18378 - 1/2

