

FORM 8858
JULY, 1923

LIST OF PARTS

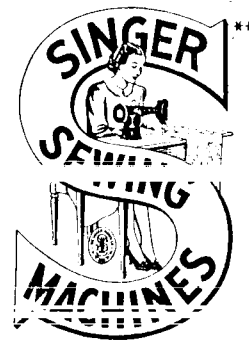

SINGER**
MACHINES
Nos. 114-5 to 114-8

THE SINGER MANUFACTURING COMPANY

***A Trade Mark of THE SINGER MANUFACTURING COMPANY

INSTRUCTIONS FOR OILING

To ensure easy running and prevent unnecessary wear of the parts which are in movable contact, the machine requires oiling and when in continuous use, "TYPE B" or "TYPE D" OIL, sold by Singer Sewing Machine Company, should be applied at least twice each day to all oil holes marked "OIL", as instructed in Form 8428.

"TYPE D" OIL should be used when an oil is desired which will produce a minimum of stain on fabrics, even after a long period of storage.

Copyright, U. S. A., 1917, 1920, 1921 and 1922,
by The Singer Manufacturing Company
All Rights Reserved for all Countries

INDEX

	PAGE
ATTACHMENTS AND ACCESSORIES	33
MACHINE No. 114-5	7
" " 114-6	19
" " 114-7	20
" " 114-8	33
NUMERICAL LIST OF PARTS	39
OBSOLETE PARTS	37
PROTECTOR	34
STAND	35
TABLE BELT GUIDE	36
THREAD UNWINDER	36

INSTRUCTIONS FOR ORDERING

In ordering from this list, use **ONLY** the part NUMBER in the **FIRST** column.

The number stamped on a Sewing Machine part is in **every** case the number of the single part only.

Every combination of parts sent out as such has its specific number, which, although not stamped on the parts, must be used when ordering the combination.

Each number always indicates the **SAME PART** in whatever list it appears, or for whatever machine.

The letters after some of the numbers indicate the **style** of finish only, as follows:

- A. Hardened, Polished and Plated.
- B. Polished and Plated
- C. Hardened only.
- D. Polished only.
- E. Soft, not Polished.
- G.
- H. Blued
- J. Plated only.
- K. Hardened and Plated.
- L. Brass or Gilt.
- M. Oxidized
- P. Japanned.
- R. Parkerized.

These letters **MUST BE USED** when they appear in the list, and **AFTER** the number **as** in the list.

In this series

- 1 to 1500 and 50001 to 51500 are Screw Numbers.
- 1501 to 1800 are Nut Numbers.
- 1801 to 2000 are Roller Numbers.
- 2001 to 50000 and 52001 and upward are numbers of Machine Parts.

The figures in the second column refer only to the plates, illustrating the parts, and are **NOT TO BE USED** in ordering.

Parts marked with an asterisk (*) are furnished only when repairs are made at factory.

LIST OF PARTS COMPLETE

FOR

MACHINE No. 114-5

FOR SEWING TWO OR FOUR-HOLE BUTTONS ON SHIRTS, WAISTS AND UNDERWEAR. SMALL BUTTONS ONLY. MAKES TWO PARALLEL BARS IN FOUR-HOLE BUTTONS. MAKES FOURTEEN STITCHES, INCLUDING THE FASTENING STITCH; FITTED WITH IMPROVED THREAD CONTROLLING MECHANISM AND THREAD NIPPING DEVICE TO HOLD THE END OF THE THREAD UNTIL THE FIRST STITCH IS MADE.

NO.	PLATE	NAME
*62295	—	Arm with 4449, 124606 and two 164E.....
16532	6976	" Dowel Pin.....
4448	6976	" Oil Tube, for intermediate bearing...
56015	6976	" " " " oiling 59705 and 59706...
59702	6975	" Shaft (horizontal).....
17703	6981	" " " " Bushing (back)....
50333c	6998	" " " " " " Ad-justing Screw.....
15306	6994	Arm Shaft (horizontal) Bushing (back) Ad-justing Screw Nut.....
*4449	—	Arm Shaft (horizontal) Bushing (front)...
59703	6976	" " " " Gear with two 1036c
1036c	6976	" " " " Set Screw....
59701	6976	" " (upright).....
59705	6976	" " " " Bushing (lower).....
435c	7015	" " " " " " Set Screw.....
59706	6976	Arm Shaft (upright) Bushing (upper).....
448c	6992	" " " " " " Set Screw.....
59707	6976	Arm Shaft (upright) Gear (lower) with two 1253c.....
1253c	6976	Arm Shaft (upright) Gear (lower) Set Screw.....
59708	6976	Arm Shaft (upright) Gear (upper) with two 1253c.....
1253c	6976	Arm Shaft (upright) Gear (upper) Set Screw.....
124674	7020	" Side Cover.....

NO.	PLATE	NAME
286D	6980	Cylinder Top Cover Thumb Screw.....
59711	6981	Face Plate.....
59712	—	Face Plate complete, Nos. 208D, 9544, 9545, 59711 and two each 229D, 2107 and 9543
164D	6990	Face Plate Screw.....
2107	6980	“ “ Thread Guard.....
229D	6978	“ “ “ “ Screw.....
9513	6980	“ “ “ “ Nipper Disc.....
9514	6980	“ “ “ “ “ Cover.....
208D	6980	“ “ “ “ “ “ Screw
9545	6980	“ “ “ “ “ “ Spring.....
62115	6982	Feed Across Connection Adjusting Stud
1649C	6982	“ “ “ “ “ “
		Nut (left).....
1650C	6982	Feed Across Connection Adjusting Stud Nut (right).....
62116	6982	Feed Across Knuckle Joint.....
1772S	6982	“ “ “ “ Connection.....
1184E	6982	“ “ “ “ “ “ Hinge Screw.....
59713	6984	Feed Across Lever with 1185C and 50150C.
1185C	6982	“ “ “ “ “ “ Set Screw.....
59714	—	Feed Across Lever complete, Nos. 59713, 59715 and 59721.....
59715	6983	Feed Across Lever Extension with 1952 and 51011.....
59716	6983	Feed Across Lever Extension Disengaging Eccentric.....
59717	6983	Feed Across Lever Extension Disengaging Eccentric Connection.....
999D	6983	Feed Across Lever Extension Disengaging Eccentric Connection Hinge Screw.....
59718	6983	Feed Across Lever Extension Disengaging Eccentric Connection Spring.....
193D	6983	Feed Across Lever Extension Disengaging Eccentric Connection Spring Screw.....
238D	6983	Feed Across Lever Extension Disengaging Eccentric Connection Stop Screw.....
2273	6983	Feed Across Lever Extension Disengaging Eccentric Pin.....
59719	6983	Feed Across Lever Extension Disengaging Eccentric Shaft.....
59720	6983	Feed Across Lever Extension Disengaging Handle.....
2273	6983	Feed Across Lever Extension Disengaging Handle Pin.....

NO.	PLATE	NAME
51814	6983	Feed Across Lever Extension Guiding Roller and Screw Stud.....
59721	6983	Feed Across Lever Extension Hinge Pin
50150C	6991	“ “ “ “ “ “ Set Screw.....
59722	6984	Feed Across Lever Extension Position Arm
2022	6983	“ “ “ “ “ “ Pin.....
59723	6983	Feed Across Lever Extension Position Arm Support.....
1404D	6983	Feed Across Lever Extension Position Arm Support Screw.....
9525	6983	Feed Across Lever Extension Position Arm Support Screw Washer.....
1952	6983	Feed Across Lever Extension Roller and Stud.....
430C	6994	Feed Across Lever Extension Stop Screw
1520E	6994	“ “ “ “ “ “ Nut.....
59724	6987	Feed Across Lever Hinge Stud.....
160D	6998	“ “ “ “ “ “ Clamping
62118	6985	Feed Across Lever Plate with 17741.....
62119	6985	“ “ “ “ “ Cover.....
1094F	6985	“ “ “ “ “ Screw.....
55300	6985	“ “ “ “ “ Steady Pin.....
17733	6982	“ “ “ “ “ Socket Bearing.....
17734	6982	“ “ “ “ “ “ Block (two pieces).....
145F	6982	Feed Across Lever Socket Bearing Block Set Screw.....
1528J	6982	Feed Across Lever Socket Bearing Block Set Screw Nut.....
62120	6984	Feed Across Regulator.....
1187E	6982	“ “ “ “ Adjusting Stud.....
1676C	6982	“ “ “ “ “ Nut
17738	6982	“ “ “ “ “ “ Washer.....
17739	6982	Feed Across Regulator Adjusting Stud Sleeve.....
1188D	6998	Feed Across Regulator Hinge Screw.....
62121	6985	“ “ “ “ Link.....
50324E	6985	“ “ “ “ “ Screw Stud
1655E	6985	“ “ “ “ “ “ Nut.....
14017	6985	Feed Across Regulator Link Screw Stud Nut Washer.....

NO.	PLATE	NAME
59746	6991	Looper Shaft Coupling with two 50150c...
50150c	6991	" " " " Set Screw.....
62197	7015	" " " " Ball with two 624c.....
62132	6991	" " " " Connection with 59752 and two 171E.....
*59752	—	Looper Shaft Ball Connection Cap.....
171E	6991	" " " " " " Screw..
62133	6991	" " " " " " Stud (eccen- tric).....
1095F	6991	Looper Shaft Ball Connection Stud Cap Screw.....
1259c	6991	Looper Shaft Ball Connection Stud Set Screw.....
624c	6991	Looper Shaft Ball Set Screw.....
62134	6991	" " " " Slide Block.....
62135	6991	" " " " " " Cap.....
1186c	6991	" " " " " " " " Screw.....
34418	6991	" " " " " " Washer.....
62299	7020	Needle Bar with 1072F.....
39203	6992	" " " " " " Connecting Link.....
377c	6992	" " " " " " " " Hinge Screw
1718c	6992	" " " " " " " " " " "
		Nut.....
2052	6992	Needle Bar Connecting Stud with 155c...
155c	6992	" " " " " " " " Set Screw...
59757	6992	" " " " " " Crank Wheel with 448c and 1993c.....
1295c	6992	Needle Bar Crank Wheel Position Screw..
448c	6992	" " " " " " " " Set Screw.....
124603	7019	" " " " " " Thread Retainer Bracket with 460c.....
460c	7019	Needle Bar Thread Retainer Bracket Set Screw.....
42348	7019	Needle Bar Thread Retainer Disc (inside).
10106	7019	" " " " " " " " (outside)
10107	7019	" " " " " " " " Spring
93c	7019	" " " " " " " " " " "
		Screw.....
124604	7019	Needle Bar Thread Retainer Thread Guide
124605	—	Needle Bar Thread Retainer complete, Nos. 93c, 10106, 10107, 42348, 124603 and 124604.....
62300	7019	Needle Guard.....
124601	7019	" " " " " " Cam with two 465c.....
465c	6991	" " " " " " " " Set Screw.....
2273	6983	" " " " " " " " Pin.....
59760	6989	" " " " " " " " Shaft.....

NO.	PLATE	NAME
59761	6993	Needle Guard Shaft Collar with two 465c.
465c	6991	" " " " " " " " Set Screw.....
124602	7019	" " " " " " Crank with 51812 and two 465c.....
51812	6993	Needle Guard Shaft Crank Roller and Stud
465c	6991	" " " " " " " " Set Screw.....
59763	6993	" " " " " " " " End Bearing.....
59764	6989	" " " " " " " " " " Bracket
2022	6983	" " " " " " " " " " "
		Dowel Pin.....
965D	6993	Needle Guard Shaft End Bearing Bracket Screw.....
1480H	6993	Needle Guard Shaft End Bearing Cap Screw.....
59765	6993	Needle Guard Shaft Spring.....
59766	6993	" " " " " " " " Collar with 624c.....
624c	6991	Needle Guard Shaft Spring Collar Set Screw.....
233D	6995	Needle Guard Shaft Spring Screw.....
1072F	6993	" " " " " " " " Set Screw.....
		" " " " " " " " " " "
17841	6992	" " " " " " Collar with two 196F.....
196F	6992	" " " " " " " " " " Set Screw.....
17842	6992	" " " " " " Guide Bracket with 453c.....
453c	6987	" " " " " " " " " " Set Screw.....
194931	7020	" " " " " " " " Lifting Lever.....
124606	7020	" " " " " " " " " " Bracket.....
164E	6990	" " " " " " " " " " Screw..
1201D	7006	" " " " " " " " " " Hinge Screw....
17845	6984	" " " " " " " " " " Rod.....
17846	—	" " " " " " " " " " Chain.....
8414	6989	" " " " " " " " Spring.....
17941	6977	Pulley (loose) 2 $\frac{7}{8}$ in. diam.....
17848	6977	" " " " " " " " Bushing.....
2269	6994	" " " " " " " " " " Position Pin.....
1202D	6998	" " " " " " " " " " Cap Screw.....
17942	6977	" " (tight) 2 $\frac{7}{8}$ in. diam., with 2269....
2022	6983	" " " " " " " " " " Pin.....
17955	—	Pulleys complete, Nos. 1202D, 1206c, 17848, 17854, 17941 and 17942.....
17853	6994	Starting Lever.....
1262c	6998	" " " " " " " " Hinge Screw.....
1662c	6999	" " " " " " " " " " Nut.....
17886	6984	" " " " " " " " " " Pitman.....
17854	6994	Stop Cam.....
17855	6994	" " " " " " " " " " Interlocking Rod.....

NO.	PLATE	NAME
62136	6977	Stop Cam Interlocking Rod Case with 59771 and two 193b
62159	-----	Stop Cam Interlocking Rod Case 62136 with 1318b, 17855, 17863, 17864, 39222, 39223 and two 1255b
59769	6977	Stop Cam Interlocking Rod Case Bracket
62186	-----	Stop Cam Interlocking Rod Case Bracket complete, Nos. 1182e, 1196c, 1204e, 1254c, 1262c, 1508e, 1662c, 17853, 17859, 17861, 17862, 17872, 17873, 59769, 62159 and two 898b
62137	---	Stop Cam Interlocking Rod Case Bracket 62186 with 39343, 39344 and two 1186b
21828	6976	Stop Cam Interlocking Rod Case Bracket Dowel Pin
50372b	7015	Stop Cam Interlocking Rod Case Bracket Screw
1201e	6998	Stop Cam Interlocking Rod Case Hinge Screw
17859	6977	Stop Cam Interlocking Rod Case Socket Joint
808a	6998	Stop Cam Interlocking Rod Case Socket Joint Cap Screw
39343	6981	Stop Cam Interlocking Rod Case Spring (flat)
430c	6994	Stop Cam Interlocking Rod Case Spring Adjusting Screw
1520e	6994	Stop Cam Interlocking Rod Case Spring Adjusting Screw Nut
39344	6994	Stop Cam Interlocking Rod Case Spring Bracket with 430c and 1520e
1186b	6991	Stop Cam Interlocking Rod Case Spring Bracket Screw
17861	6991	Stop Cam Interlocking Rod Case Stop Stud
1254c	6998	" " " " " " " "
1508e	6999	Stop Cam Interlocking Rod Case Stop Stud Screw Bushing Lock Nut
17862	6994	Stop Cam Interlocking Rod Case Stop Stud Spring
59771	6994	Stop Cam Interlocking Rod Case Wearing Block
193b	6983	Stop Cam Interlocking Rod Case Wearing Block Screw
17863	6994	Stop Cam Interlocking Rod Spring
17864	6994	" " " " Stop
1318d	6994	" " " " " Screw

NO.	PLATE	NAME
3012	7019	Stop Cam Fin
1206c	6994	" " Screw
2102	6995	Tension Disc
1560c	6995	" Regulating Thumb Nut
50148c	6995	" Screw Stud
42336	6995	" Spring
13915	6995	" Bushing
10145	6995	" Thread Guide
124609	7023	Thread Controller Sleeve
124607	7023	" " Spring
124608	7023	" " " Collar with 1477F
1477F	6980	" " " " Set Screw
124610	7023	" " Stud with 56549 and 124631
*124631	---	Thread Controller Stud Collar
56549	---	" " " " Pin
457c	7023	" " " Set Screw
124611	---	Thread Controller complete, Nos. 124607 to 124610
*124612	---	Thread Nipper (lower) Blade
*124613	---	" " " " Carrier with 124619
124614	7023	Thread Nipper (lower) Blade Carrier Cap Screw
665J	7023	Thread Nipper (lower) Blade Carrier Cap Screw
124615	7023	Thread Nipper (lower) Blade Carrier Hinge Rivet
6037	7023	Thread Nipper (lower) Blade Rivet
124616	7020	" " " Cam
335J	7023	" " " " Screw
124653	7020	" " " Connection
124618	7023	" " " " Extension
99K	7023	Thread Nipper (lower) Connection Extension Hinge Screw
206J	7024	Thread Nipper (lower) Connection Extension Screw
124619	7023	Thread Nipper (lower) Connection Hinge Stud
124620	7020	Thread Nipper (lower) Driving Arm
8554	7019	" " " " " Pin
124621	7020	" " " " Lever with 237K
124622	7020	" " " " Guide
335J	7023	" " " " " Screw
8554	7019	" " " " " Pin
237K	7009	" " " " " Set Screw

LIST OF PARTS COMPLETE FOR

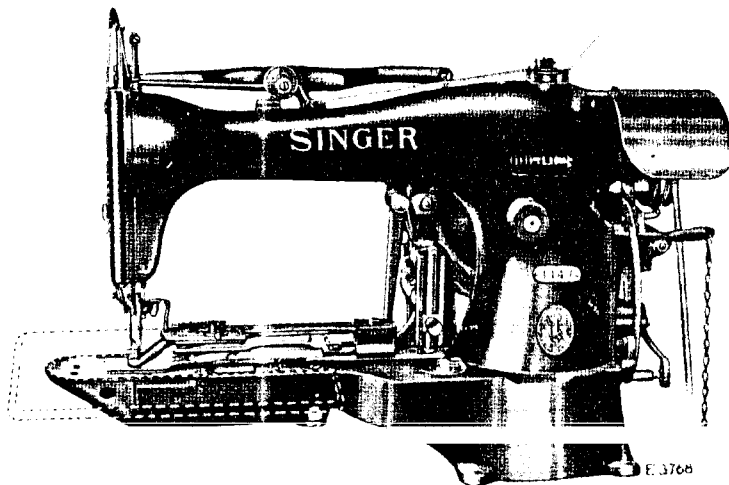

MACHINE No. 114-7

FOR SEWING TWO OR FOUR-HOLE BUTTONS ON SHIRTS, WAISTS AND UNDERWEAR. SMALL BUTTONS ONLY. MAKES CROSS STITCHES IN FOUR-HOLE BUTTONS AND AND CAN BE ADJUSTED FOR TWO-HOLE AND BAR BUTTONS. MAKES FOURTEEN STITCHES, INCLUDING THE FASTENING STITCH; FITTED WITH IMPROVED THREAD CONTROLLING MECHANISM AND THREAD NIPPING DEVICE TO HOLD THE END OF THE THREAD UNTIL THE FIRST STITCH IS MADE.

NO.	PLATE	NAME
*62295	---	Arm with 4449, 124606 and two 164E.....
16532	6976	" Dowel Pin.....
4448	6976	" Oil Tube for intermediate bearing....
56015	6976	" " " " oiling 59705 and 59706.
880E	6998	" Screw.....
59702	6975	" Shaft (horizontal).....
17703	6981	" " " " Bushing (back)....
50333c	6998	" " " " " " Ad-justing Screw.....

NO.	PLATE	NAME
1520E	6994	Arm Shaft (horizontal) Bushing (back) Adjusting Screw Nut.....
*4449	---	Arm Shaft (horizontal) Bushing (front)...
59703	6976	" " " " Gear with two 1036c.....
1036c	6976	Arm Shaft (horizontal) Gear Set Screw....
59704	6976	" " (upright).....
59705	6976	" " " " Bushing (lower)....
435c	7015	" " " " " " Set Screw.....
59706	6976	Arm Shaft (upright) Bushing (upper)....
448c	6992	" " " " " " Set Screw.....
59707	6976	Arm Shaft (upright) Gear (lower) with two 1253c.....
1253c	6976	Arm Shaft (upright) Gear (lower) Set Screw.....
59708	6976	Arm Shaft (upright) Gear (upper) with two 1253c.....
1253c	6976	Arm Shaft (upright) Gear (upper) Set Screw.....
124674	7020	Arm Side Cover.....
190b	6990	" " " " Screw.....
18498	6975	Belt Cover.....
59795	6977	" " Bracket with 184E and 59796..
184E	6998	" " " " Screw Stud.....
59796	7019	" " " " Stud.....
217D	6998	" " " " Screw.....
39222	6977	" Shifter.....
39223	6976	" " Clamp.....
1255D	6976	" " " " Screw.....
39238	7017	Button Clamp (left) with 9311 and 17723
39239	7017	" " (right) with 9311 and 17723
63927	7017	" " Arm with 17714 and 63788
17710	6978	" " " " Hinge Plate.....
1176J	6978	" " " " " " Screw....
63788	7015	" " " " Hook.....
1175J	6978	" " " " Hinge Screw.....
59710	6979	" " " " Lifter.....
176b	7009	" " " " " " Screw.....
124677	7019	" " " " Locking Device Latch with 704J.....
704J	7019	Button Clamp Locking Device Latch Clamping Screw.....
124678	7020	Button Clamp Locking Device Latch Shaft.....

NO.	PLATE	NAME
124679	7019	Button Clamp Locking Device Latch Shaft Crank.....
124680	7019	Button Clamp Locking Device Latch Shaft Crank Connection.....
1282c	7019	Button Clamp Locking Device Latch Shaft Crank Connection Hinge Screw (lower).....
1282c	7019	Button Clamp Locking Device Latch Shaft Crank Connection Hinge Screw (upper).....
2269	6994	Button Clamp Locking Device Latch Shaft Crank Pin.....
39241	6978	Button Clamp Pressure Spring.....
17713	6978	" " " " Bracket
1177d	6978	" " " " " "
		Screw.....
17714	6978	Button Clamp Pressure Spring Guide Block
1178j	6978	" " " " " Screw.....
39242	6978	" " " " Spreader.....
17717	6979	" " " " Lever.....
50237k	6979	" " " " " Hinge Screw
1180j	6979	" " " " " Locking
		Thumb Screw.....
17718	6979	Button Clamp Spreader Lever Locking Thumb Screw Washer.....
1182j	6978	Button Clamp Spreader Screw.....
17719	7019	" " " " Spring.....
1181i	7019	" " " " " Screw
17720	6979	" " " " " Steady Pin.....
39244	7017	" " " " Spring (left) for flat buttons
39245	7017	" " " " (right) for flat buttons.....
39246	6978	Button Clamp Spring (left) for stud back buttons.....
39247	6978	Button Clamp Spring (right) for stud back buttons.....
229j	6978	Button Clamp Spring Screw.....
9311	7017	" " " " Steady Pin.....
39248	6979	" " " " Stop with two 17720.....
1183j	6979	" " " " Screw.....
17723	6979	" " " " Stud.....
63928	7018	Button Clamp (universal) complete, for 10 to 50 line thin buttons, Nos. 1180j, 1181j, 1182j, 1183j, 17717 to 17719, 39238, 39239, 39242, 39244 or 39246, 39245 or 39247, 39248, 50237k, 63927 and two each 229j and 1175j.....
*62101	—	Cloth Plate.....

NO.	PLATE	NAME
62102	6980	Cloth Plate Guide Block (left).....
742f	6980	" " " " " " Screw.....
1517d	6980	" " " " " " Nut.....
62103	6980	" " " " " (right).....
3021	6980	" " " " " Rivet.....
190b	6990	" " " " " Screw.....
62104	6980	" " " " " Stop.....
26770	6980	" " " " " Rivet.....
62105	6975	Cloth Plate complete, Nos. 742f, 1517d, 26770, 62101 to 62104 and two 3021.....
*62177	—	Cylinder.....
62183	7020	" " " " Bottom Cover.....
62108	6981	" " " " End Cover.....
62184	—	" " " " 62108 with 1034b, 62111 to 62113, 62183, 62185 and four 1177d.....
62185	6980	Cylinder End Cover Bracket.....
62111	6980	" " " " " Hinge Pin.....
1177d	6980	" " " " " " Screw.....
62112	6980	" " " " " Hinge.....
1177d	6980	" " " " " " Screw.....
		" " " " " " Screw.....
1034b	6980	" " " " " " Screw.....
62114	6980	" " " " " Top Cover.....
286d	6980	" " " " " Thumb Screw.....
59711	6981	Face Plate.....
59712		Face Plate complete Nos. 999a, 9544, 9545, 59711 and two each 229d, 2107 and 9543
161d	6990	Face Plate Screw.....
2107	6980	Face Plate Thread Guard.....
229d	6978	" " " " " " Screw.....
9543	6980	" " " " " " Nipper Disc.....
9544	6980	" " " " " " " Cover.....
208d	6980	" " " " " " " " Screw
9545	6980	" " " " " " " Spring.....
62115	6982	Feed Across Connection Adjusting Stud
1649c	6982	" " " " " " " " " Nut (left).....
1650c	6982	Feed Across Connection Adjusting Stud Nut (right).....
62116	6982	Feed Across Knuckle Joint.....
17728	6982	" " " " " " " Connection.....
1184e	6982	" " " " " " " " Hinge Screw.....
59713	6984	Feed Across Lever with 1185c and 50150c.
17730	6982	" " " " " " " Ball Stud.....
1185c	6982	" " " " " " " " Set Screw.....

NO.	PLATE	NAME
1518E	6992	Needle Bar Connecting Link Hinge Screw Nut.....
2052	6992	Needle Bar Connecting Stud with 155c.....
155c	6992	" " " " Set Screw....
59757	6992	" " Crank Wheel with 448c and 1293c.....
1293c	6992	Needle Bar Crank Wheel Position Screw..
448c	6992	" " " " Set Screw.....
124603	7019	" " Thread Retainer Bracket with 460c.....
460c	7019	Needle Bar Thread Retainer Bracket Set Screw.....
42348	7019	Needle Bar Thread Retainer Disc (inside).
10106	7019	" " " " " (outside)
10107	7019	" " " " " Spring.
93c	7019	" " " " " " Screw.....
124604	7019	Needle Bar Thread Retainer Thread Guide
124605	—	Needle Bar Thread Retainer complete, Nos. 93c, 10106, 10107, 42348, 124603 and 124604.....
62200	7019	Needle Guard
59759	6993	" " Cam with two 465c.....
465c	6991	" " " " Set Screw.....
2273	6983	" " Pin.....
59760	6989	" " Shaft.....
59761	6993	" " " " Collar with two 465c.....
465c	6991	" " " " " Set Screw.....
59762	6993	" " " " Crank with 51812 and two 465c.....
51812	6993	Needle Guard Shaft Crank Roller and Stud
465c	6991	" " " " " Set Screw.....
59763	6993	" " " " End Bearing.....
59764	6989	" " " " " Bracket
2022	6983	" " " " " " Dowel Pin.....
965d	6993	Needle Guard Shaft End Bearing Bracket Screw.....
1480H	6993	Needle Guard Shaft End Bearing Cap Screw.....
59765	6993	Needle Guard Shaft Spring.....
59766	6993	" " " " " Collar with 624c.....
624c	6991	Needle Guard Shaft Spring Collar Set Screw.....
233d	6995	Needle Guard Shaft Spring Screw.....
1072F	6993	" " Set Screw.....

NO.	PLATE	NAME
2058	6989	Presser Bar.....
17841	6992	" " Collar with two 196F.....
196F	6992	" " " " Set Screw.....
17842	6992	" " Guide Bracket with 453c.....
453c	6987	" " " " " Set Screw.....
124681	7020	" " Lifting Lever.....
124606	7020	" " " " Bracket.....
164E	6990	" " " " " Screw...
1201D	7006	" " " " " Hinge Screw....
17845	6984	" " " " " Rod.....
17846	—	" " " " " Chain.....
8414	6989	" " Spring.....
17941	6977	Pulley (loose) 2 $\frac{7}{8}$ in. diam.....
17848	6977	" " Bushing.....
2269	6994	" " " " Position Pin.....
1202D	6998	" " Cap Screw.....
17942	6977	" (tight) 2 $\frac{7}{8}$ in. diam., with 2269....
2022	6983	" " Pin.....
17955	—	Pulleys complete, Nos. 1202D, 1206c, 17848, 17854, 17941 and 17942.....
17853	6994	Starting Lever.....
1662c	6999	" " " " " Nut.....
17886	6984	" " Pitman.....
17854	6994	Stop Cam.....
17855	6994	" " Interlocking Rod.....
62136	6977	" " " " " Case with 59771 and two 193D.....
62159	—	Stop Cam Interlocking Rod Case 62136 with 1318D, 17855, 17863, 17864, 39222, 39223 and two 1255D.....
59769	6977	Stop Cam Interlocking Rod Case Bracket
62186	—	Stop Cam Interlocking Rod Case Bracket complete, Nos. 1182E, 1196c, 1204E, 1254c, 1262c, 1508E, 1662c, 17853, 17859, 17861, 17862, 17872, 17873, 59769, 62159 and two 898D.....
62137	—	Stop Cam Interlocking Rod Case Bracket 62186 with 39343, 39344 and two 1186D
21828	6976	Stop Cam Interlocking Rod Case Bracket Dowel Pin.....
50372D	7015	Stop Cam Interlocking Rod Case Bracket Screw.....
1201E	6998	Stop Cam Interlocking Rod Case Hinge Screw.....
17859	6977	Stop Cam Interlocking Rod Case Socket Joint.....

NO.	PLATE	NAME
898D	6998	Stop Cam Interlocking Rod Case Socket Joint Cap Screw
39343	6981	Stop Cam Interlocking Rod Case Spring (flat)
430c	6994	Stop Cam Interlocking Rod Case Spring Adjusting Screw
1520E	6994	Stop Cam Interlocking Rod Case Spring Adjusting Screw Nut
39314	6994	Stop Cam Interlocking Rod Case Spring Bracket with 430c and 1520E
1186D	6991	Stop Cam Interlocking Rod Case Spring Bracket Screw
17861	6994	Stop Cam Interlocking Rod Case Stop Stud
1254c	6998	" " " " " " " " Screw Bushing
1508E	6999	Stop Cam Interlocking Rod Case Stop Stud Screw Bushing Lock Nut
17862	6994	Stop Cam Interlocking Rod Case Stop Stud Spring
59771	6994	Stop Cam Interlocking Rod Case Wearing Block
		Block Screw
17863	6994	Stop Cam Interlocking Rod Spring
17864	6994	" " " " Stop
1318D	6994	" " " " Screw
3012	7019	" " Pin
1206c	6994	" " Screw
2102	6995	Tension Disc
1560c	6995	" Regulating Thumb Nut
50148c	6995	" Screw Stud
42336	6995	" Spring
13915	6995	" " Bushing
10145	6995	" Thread Guide
124609	7023	Thread Controller Sleeve
124607	7023	" " Spring
124608	7023	" " " Collar with 1477F
1477F	6980	Thread Controller Spring Collar Set Screw
124610	7023	" " Stud with 56549 and 124631
*124631	---	Thread Controller Stud Collar
56549	---	" " " " Pin
457c	7023	" " " Set Screw
124611	---	Thread Controller complete, Nos. 124607 to 124610
*124612	---	Thread Nipper (lower) Blade

NO.	PLATE	NAME
*124613	---	Thread Nipper (lower) Blade Carrier with 124619
124614	7023	Thread Nipper (lower) Blade Carrier 124613 with 124612 and two 6037
665J	7023	Thread Nipper (lower) Blade Carrier Cap Screw
124615	7023	Thread Nipper (lower) Blade Carrier Hinge Stud
6037	7023	Thread Nipper (lower) Blade Rivet
124616	7020	" " " Cam
335J	7023	" " " " Screw
124653	7020	" " " Connection
124618	7023	" " " " Extension
99K	7023	Thread Nipper (lower) Connection Extension Hinge Screw
206J	7024	Thread Nipper (lower) Connection Extension Screw
124619	7023	Thread Nipper (lower) Connection Hinge Stud
124620	7020	Thread Nipper (lower) Driving Arm
8774	7010	" " " " " Pin
124621	7020	" " " " Lever with 237K
124622	7020	" " " " Guide
335J	7023	" " " " " Screw
8554	7019	" " " " Pin
237K	7009	" " " " Set Screw
124623	7020	" " " " " Shaft
*124682	7020	" " " " " Bracket
1177J	6978	" " " " " " Screw
1743D	6979	Thread Nipper (upper) Adjusting Thumb Nut
59773	6995	Thread Nipper (upper) Body
621c	6991	" " " " Set Screw
59774	6995	" " " " Cam with two 50150c
50150c	6991	Thread Nipper (upper) Cam Set Screw
2921	6995	" " " " Disc
12162	6995	" " " " Guide Pin
62169	6979	" " " " Spring
59775	6995	" " " " Eyelet
1527D	6995	" " " " Lock Nut
59776	6995	" " " " Stud with 13538
13538	6995	" " " " Position Pin
13539	6995	" " " " Roller
13540	6995	" " " " " Pin

NO.	PLATE	NAME
6439	---	Starting Lever Chain, length 36 in. to 45 in., with 56864 and 56865

Note: When ordering 5670 or 6439 give length required

56864	7025	Chain Hook (large)
56865	7006	" " (small)

TABLE BELT GUIDE

NO.	PLATE	NAME
39218	7005	Belt Guide with two 168E
168E	6998	" " Set Screw
17892	7005	Bracket with two 153E
17893	7005	Pulley
39219	7005	" Shaft (long) with 17896
39220	7005	" " (short) with 17896
17896	7006	" " Plug
153E	6998	" " Set Screw
39221	-----	Table Belt Guide complete, Nos. 17892, 39219, 39220, two each 17893, 39218 and three wood screws 1 1/4 in. No. 12

THREAD UNWINDER

FOR ONE LARGE SPOOL OR ONE LARGE CONE
OF THREAD

NO.	PLATE	NAME
27623	2836	Spool Pin
155c	6992	" " Set Screw
41526	2836	" Rest
60701	---	" " 41526 with 155c and 4149c
41527	---	" " 60701 with 27623
4149c	6998	" " Set Screw
27940	2836	" Stand with 453c
41514	2836	" Weight, 4 in. diam., with 41515
41515	7006	" " Centre Pin
27739	2836	Thread Cone (wood)
41630	2836	" Guard with 208E and 41569
41569	7006	" " Eyelet
41637	2836	" " Rod (lower)
41638	2836	" " " (upper)
41639	2836	" " " Coupling with two 456c
456c	6998	" " " Set Screw
41640	---	Thread Guard Rod complete, 30 in. long, Nos. 41637 to 41639

NO.	PLATE	NAME
453c	6987	Thread Guard Rod Set Screw
208E	6980	" " Screw
41529	2836	Thread Unwinder complete, Nos. 27739, 27940, 41514, 41527, 41630, 41640 and three wood screws 1 in. No. 12
60771	7006	Thread Guide
60772	---	" " 60771 with 41635
41635	7006	" " Bracket with 175D
175D	7006	" " " Set Screw
60773	---	Thread Unwinder with Thread Guide complete, Nos. 41529 and 60772

OBSOLETE PARTS

NO.	PLATE	NAME
59722	6984	Feed Across Lever Extension Position Arm for 114-7 Machine
124668	---	Feed Cam with two 1192c, three each 190b, 17874, 124669, 124670 and twelve 335j, for 114-7 Machine
124671	---	Feed Cam with two each 190b, 1192c, 17874, 124669, 124672 and eight 335j, for 114-8 Machine, use 124688
59758	6993	Needle Guard for 114-7 and 114-8 Machines
124669	6991	Nipper Bar Lifting Lever
124669	7025	Thread Nipper (lower) Cam for 124668 and 124671
124670	7025	Thread Nipper (lower) Lever Guide for 124668
124672	7025	Thread Nipper (lower) Lever Guide for 124671
124624	7025	Thread Nipper (lower) Lever Shaft Bracket

SINGER Needles should be used
in SINGER Machines
These Needles and their Containers
are marked with the
Company's Trade Mark "SIMANCO.**" 1

Needles in Containers marked
"FOR SINGER MACHINES"
are NOT SINGER made needles. 2

PLATE 2836—ONE-FOURTH SIZE

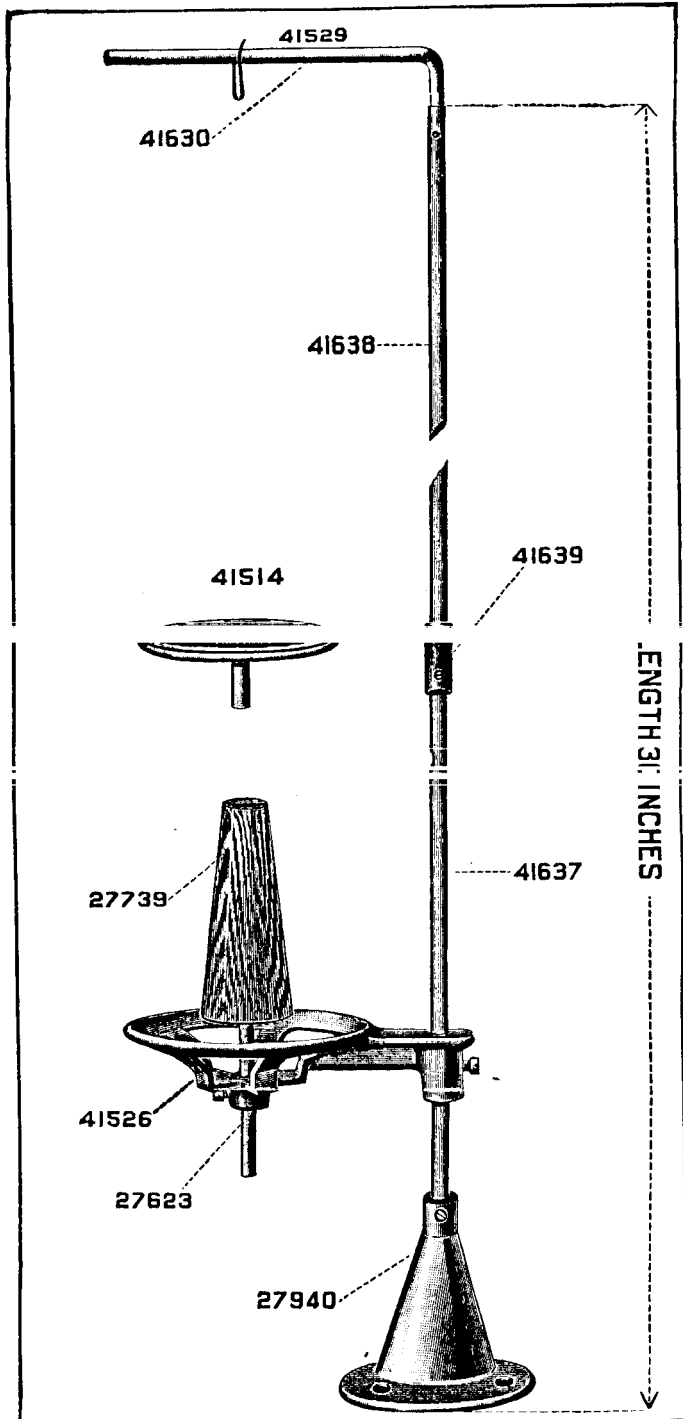

PLATE 6975—ONE-FOURTH SIZE

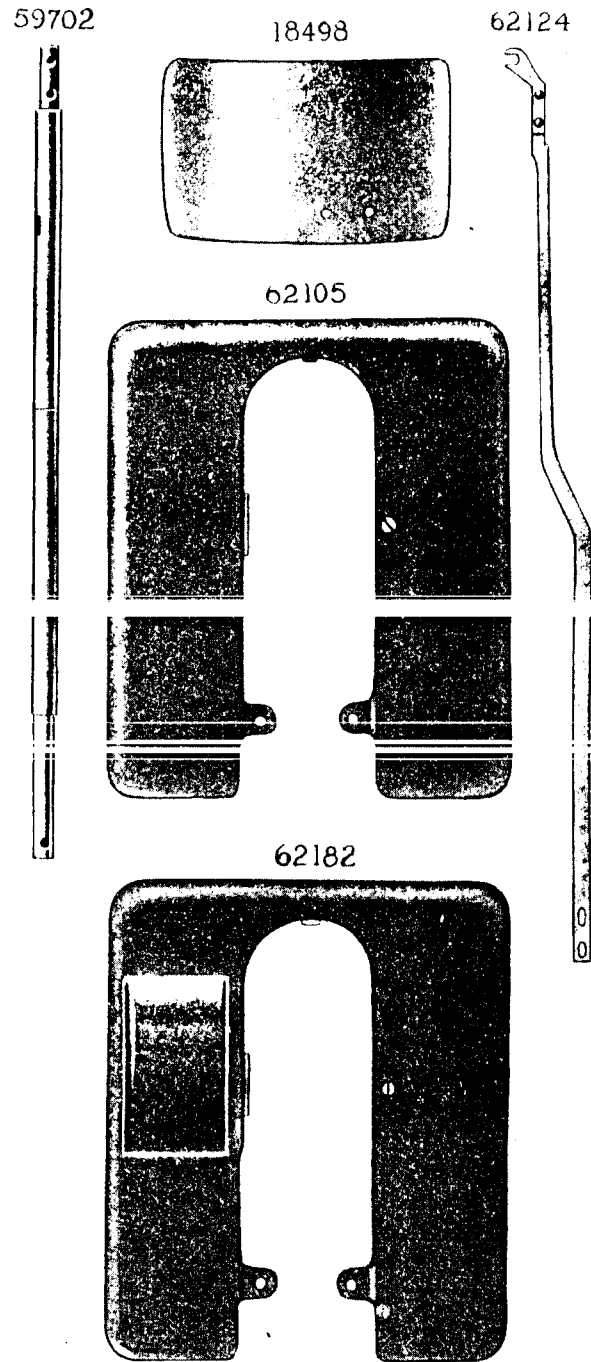

PLATE 6976—FULL SIZE

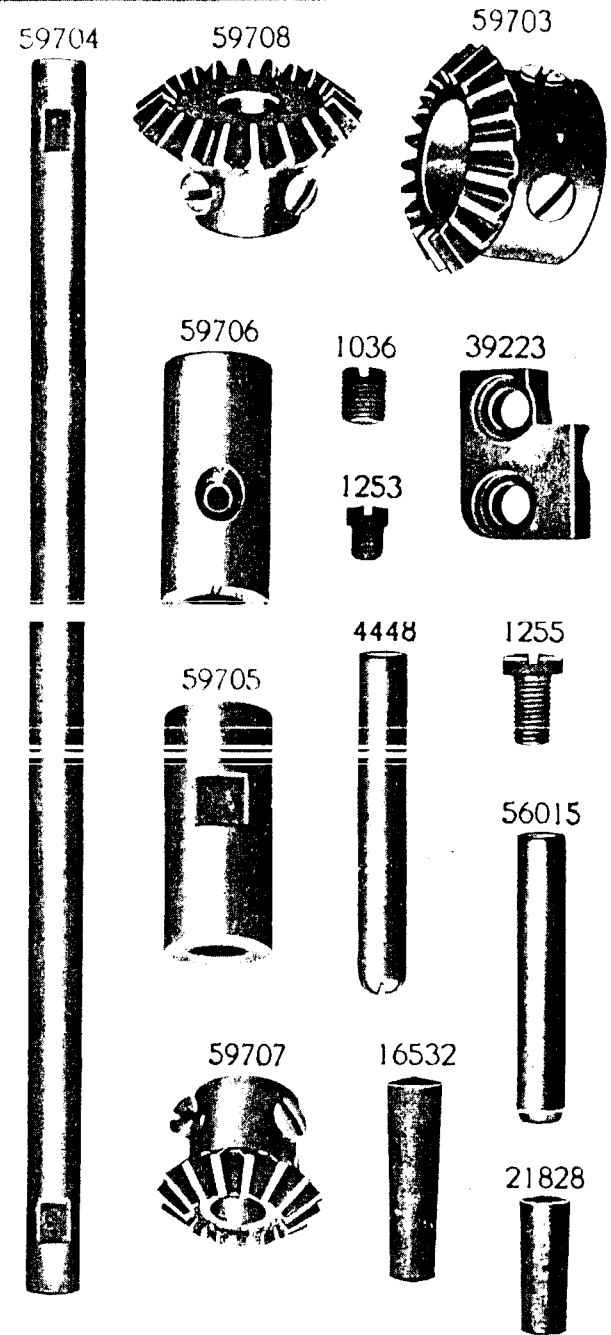

PLATE 6977—ONE-HALF SIZE

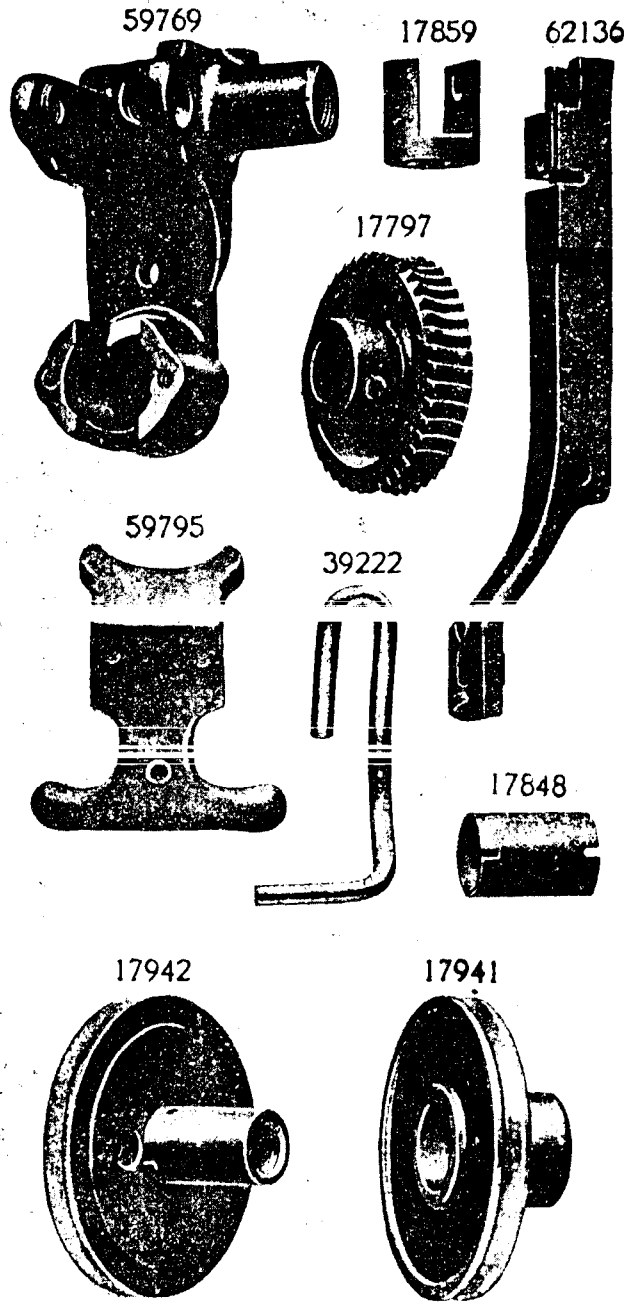

PLATE 6978—FULL SIZE

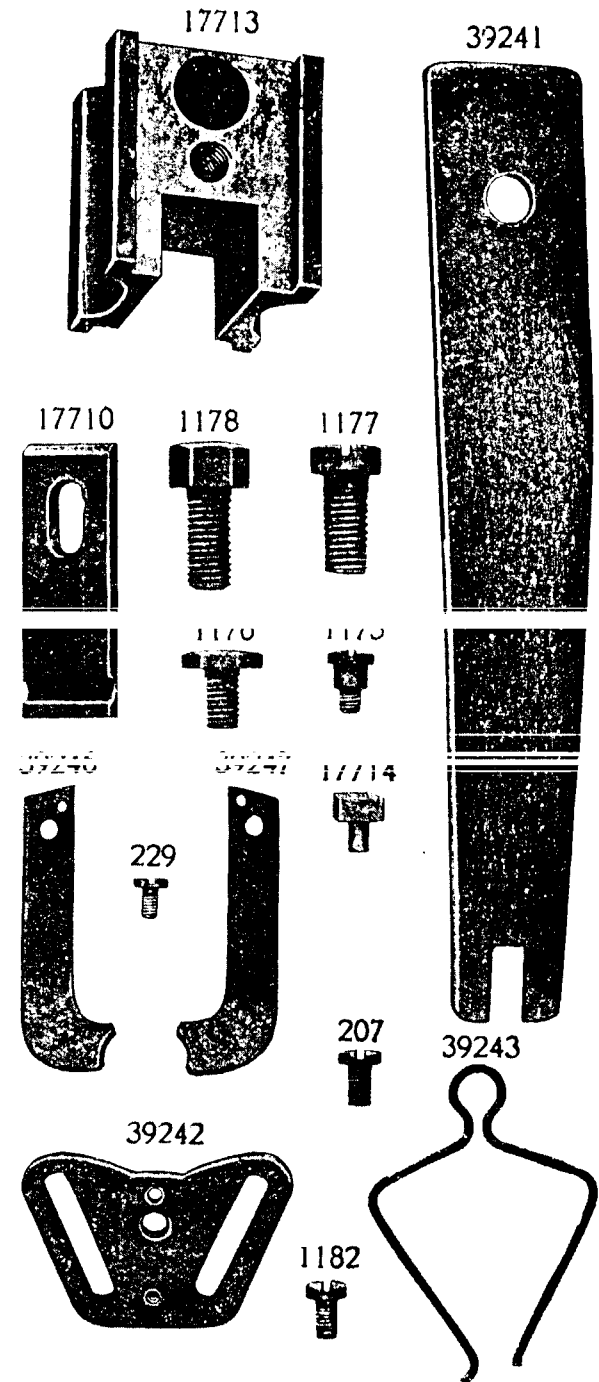

PLATE 6979—FULL SIZE

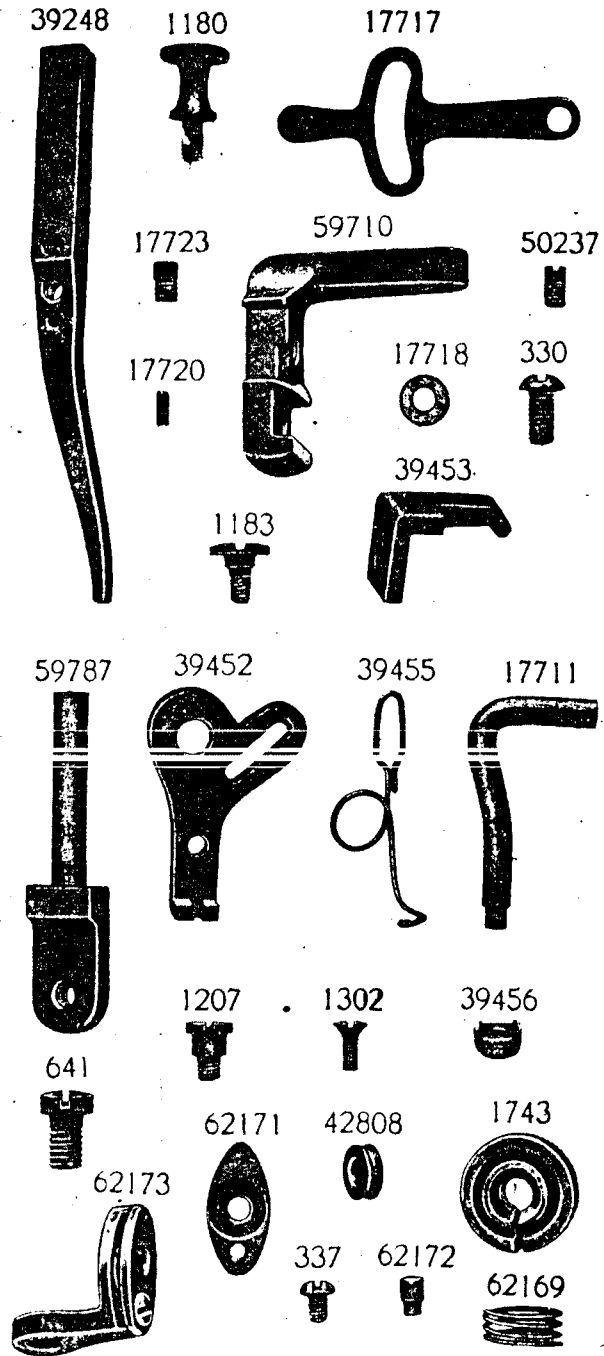

PLATE 6980—FULL SIZE

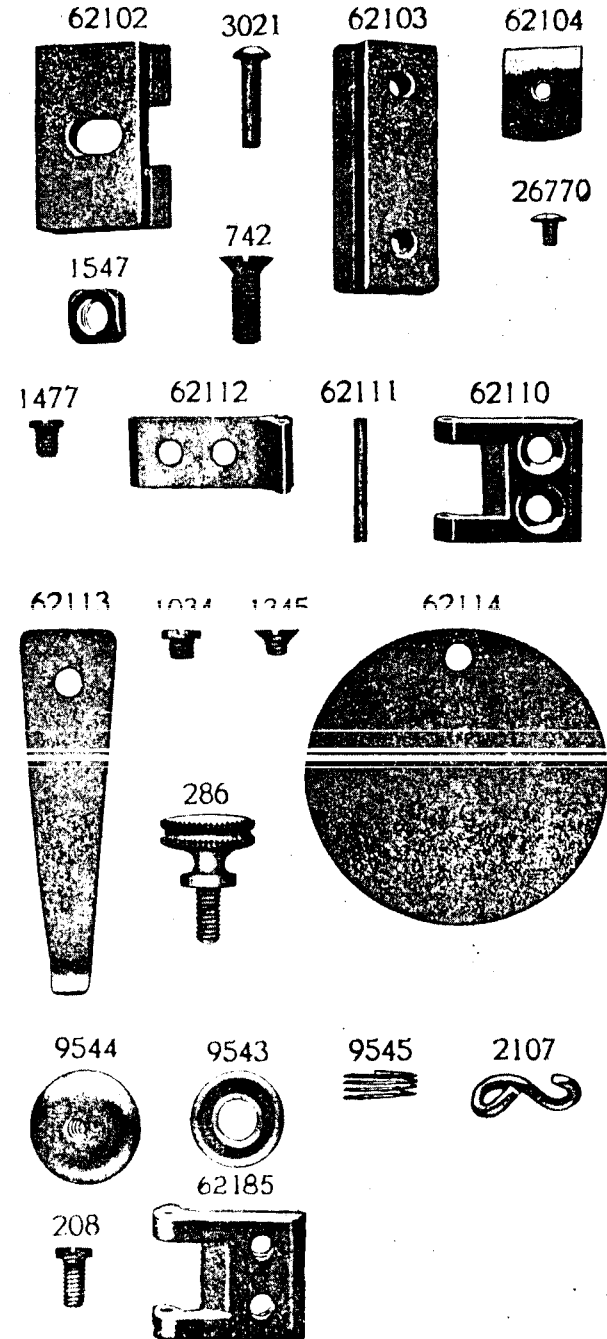

PLATE 6981—ONE-HALF SIZE

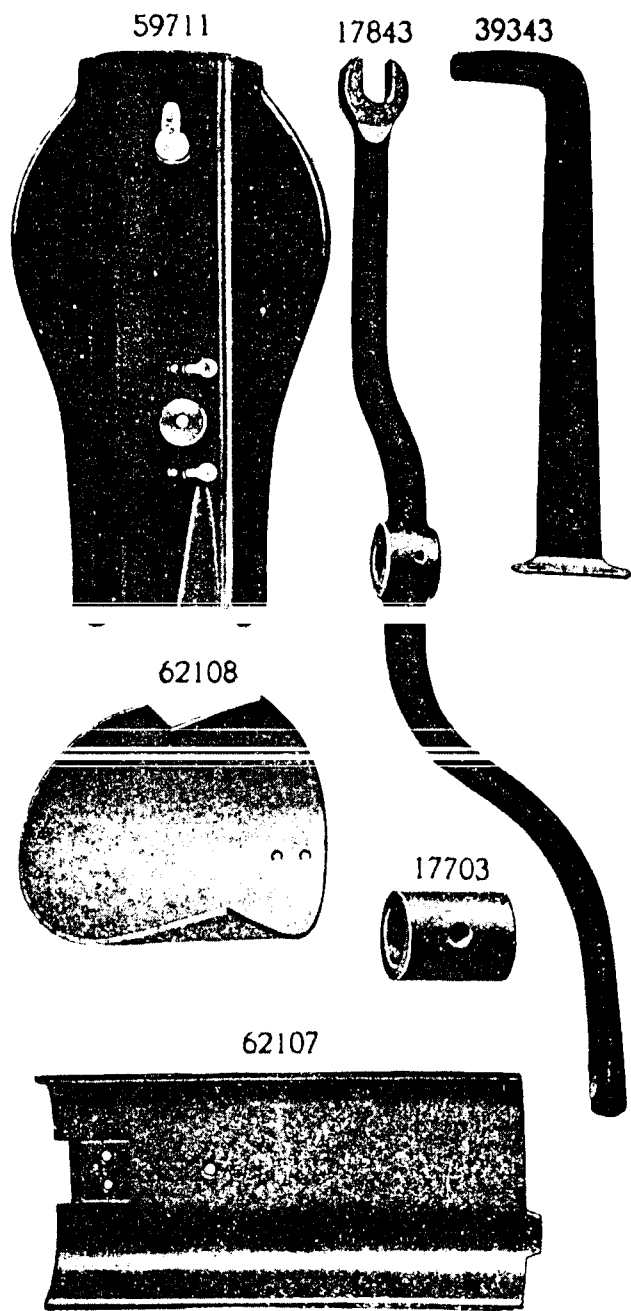

PLATE 6982—FULL SIZE

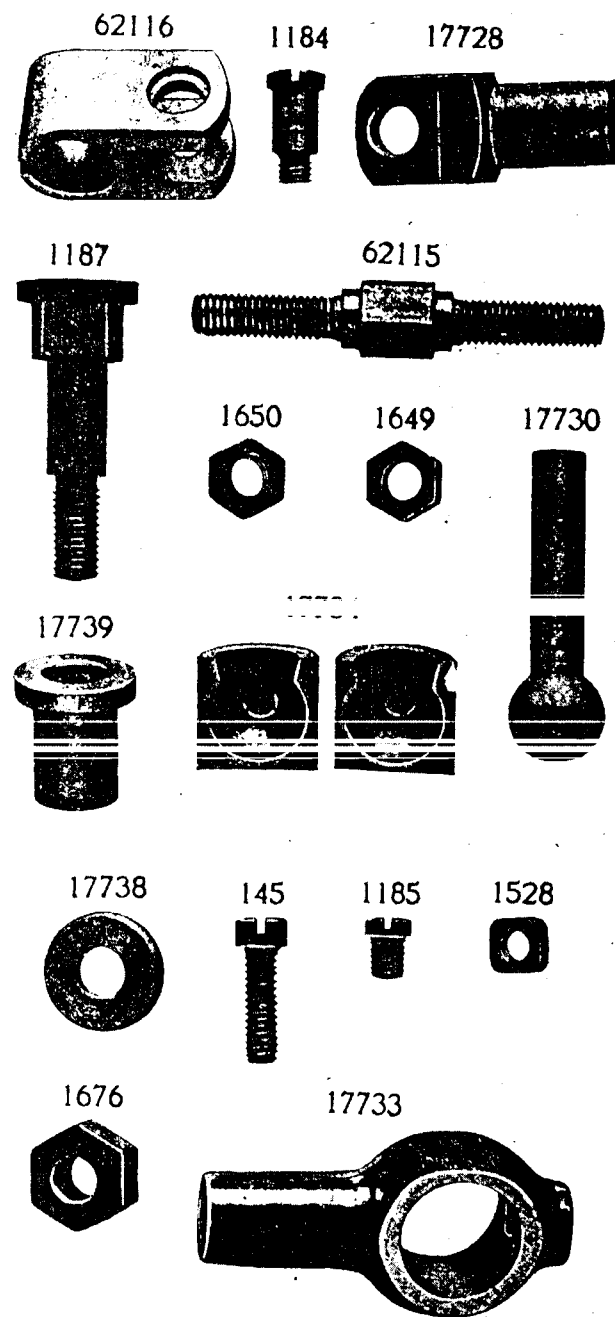

PLATE 6983—FULL SIZE

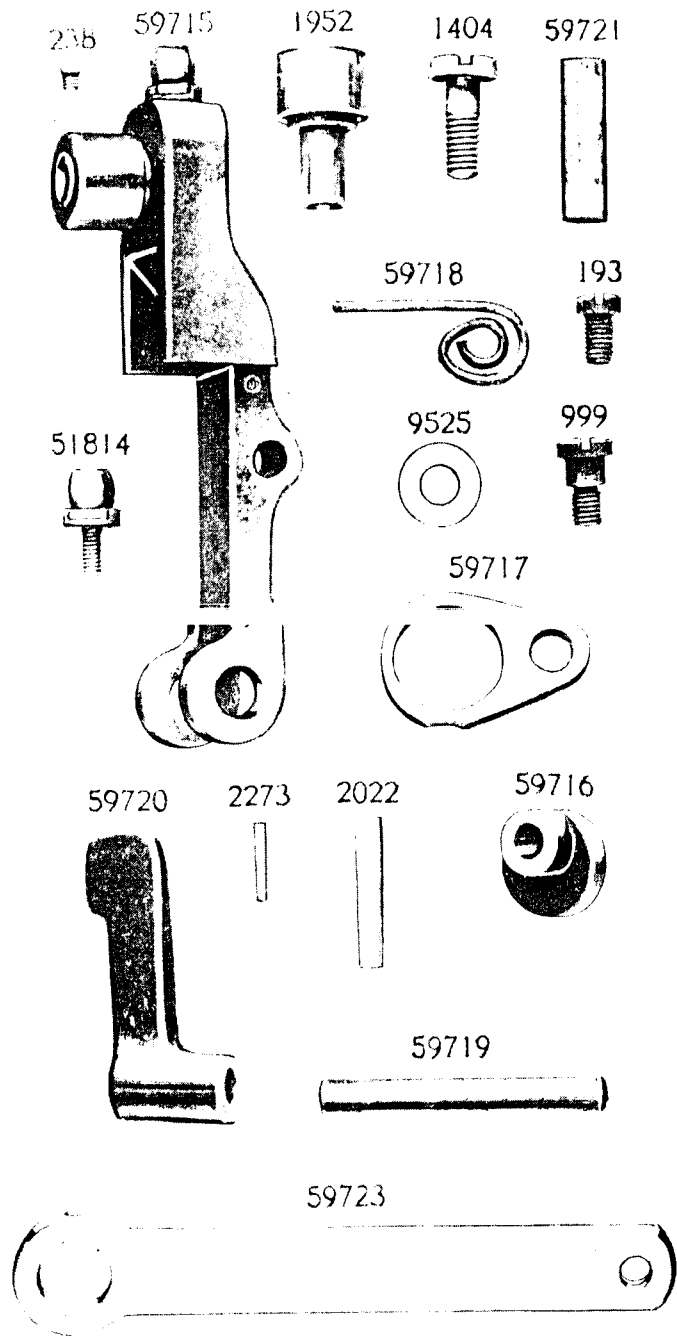

PLATE 6984—ONE-HALF SIZE

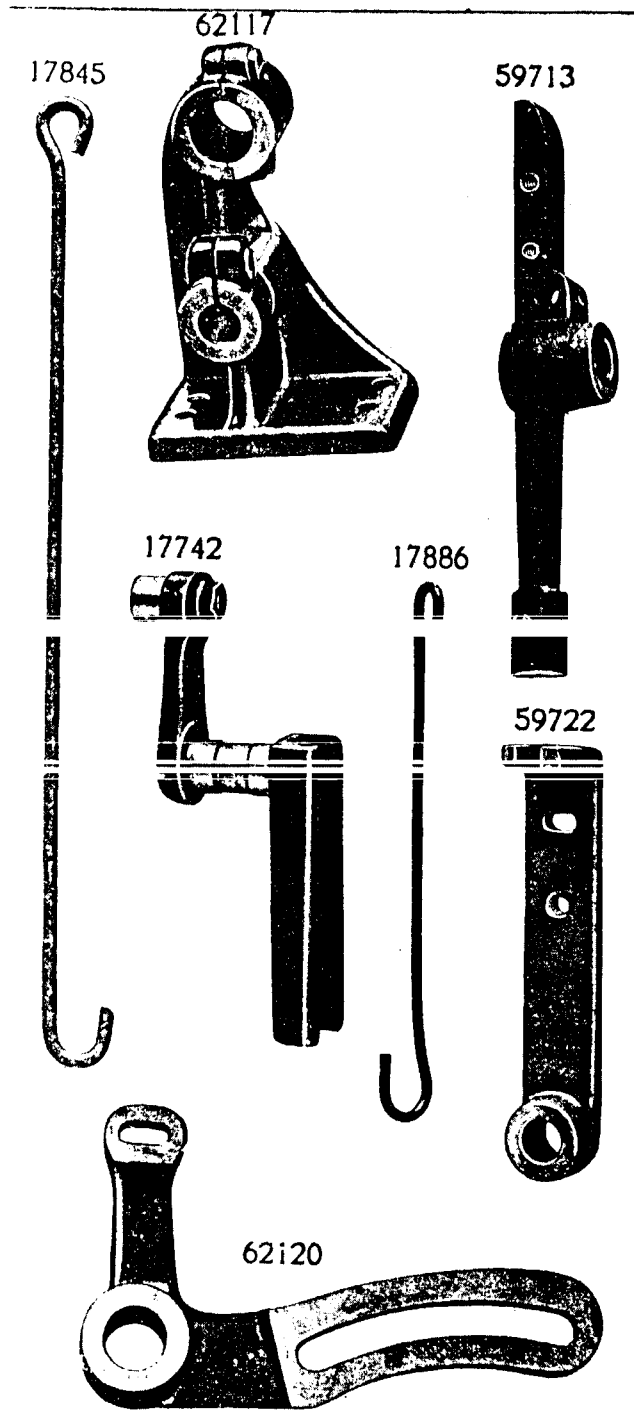
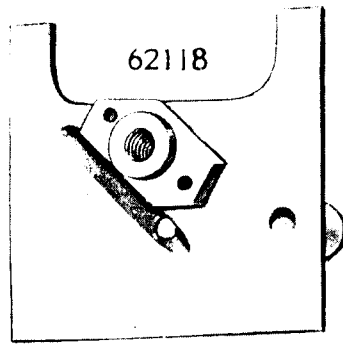

PLATE 6985—FULL SIZE



1094



55300



62119

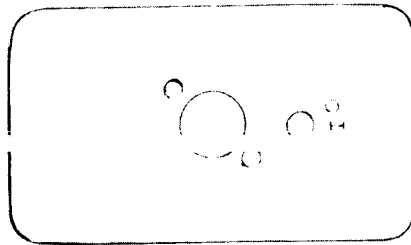

17741



50324



62121

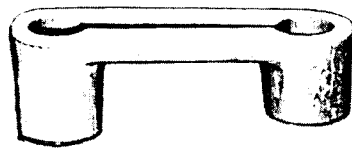

14017



1655



PLATE 6987—FULL SIZE

18415

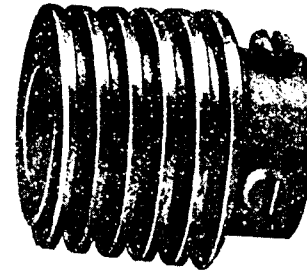

1442



1441



453



1192



59724



17743



1191



17744



17745



1190



59730



50306



934



18368

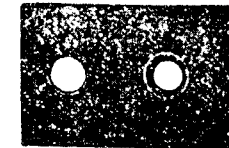

17874



62138



PLATE 6989—ONE-HALF SIZE

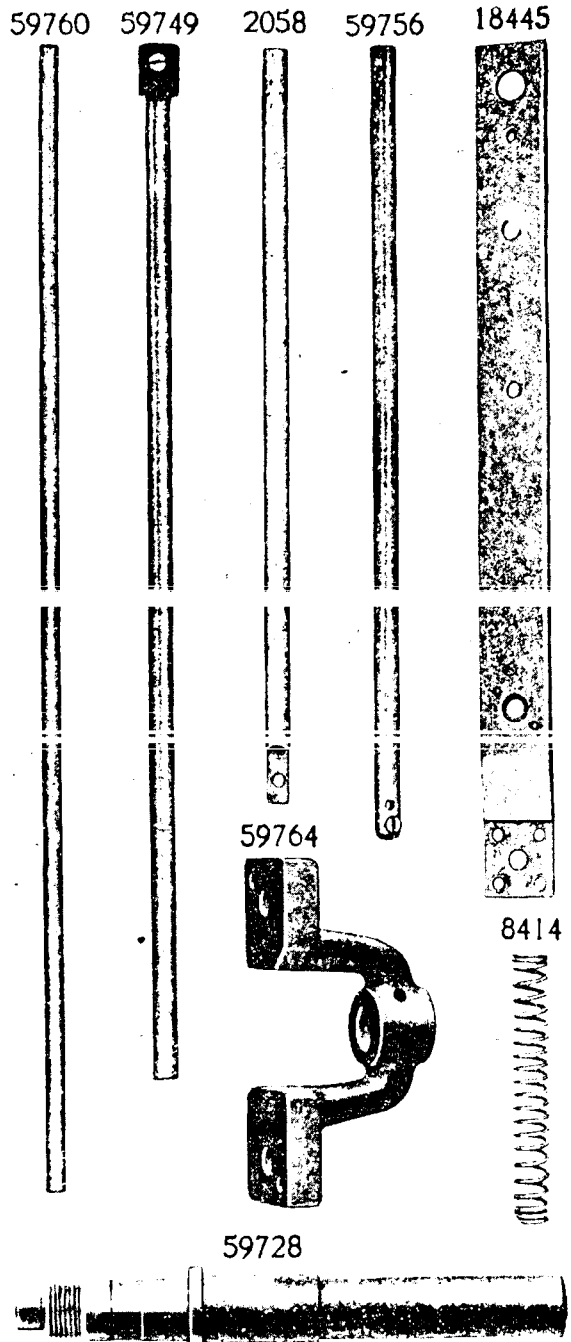

PLATE 6990—FULL SIZE

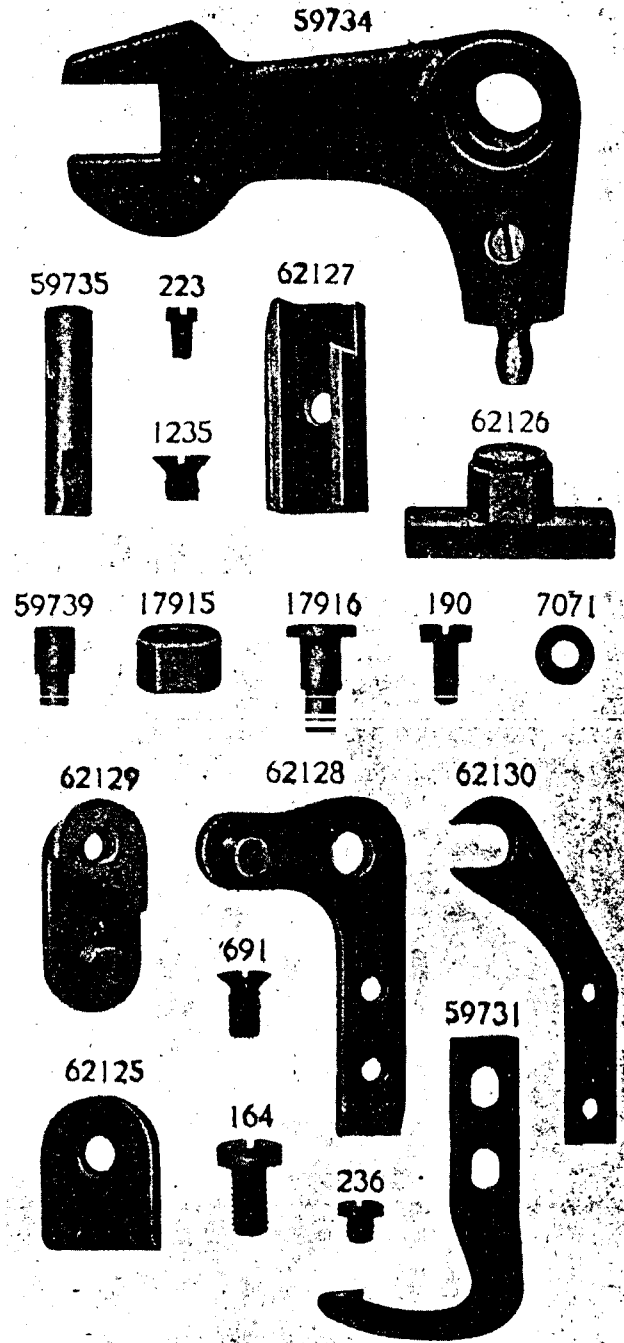

PLATE 6991—FULL SIZE

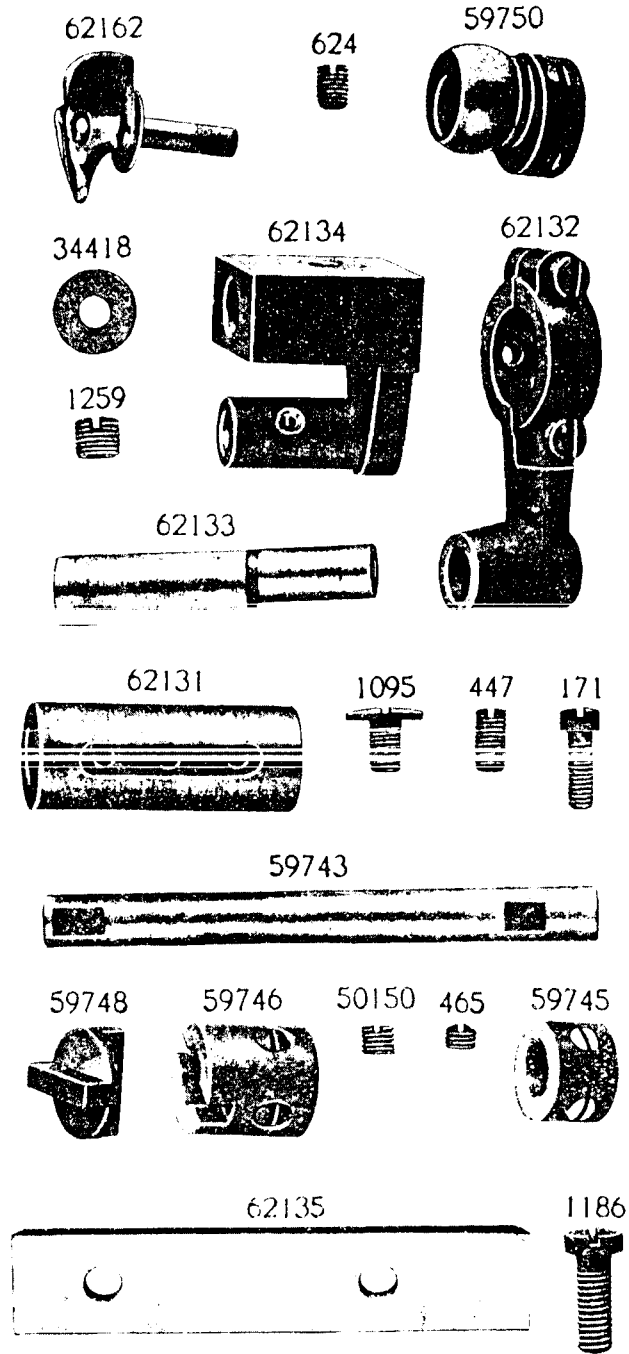

PLATE 6992—FULL SIZE

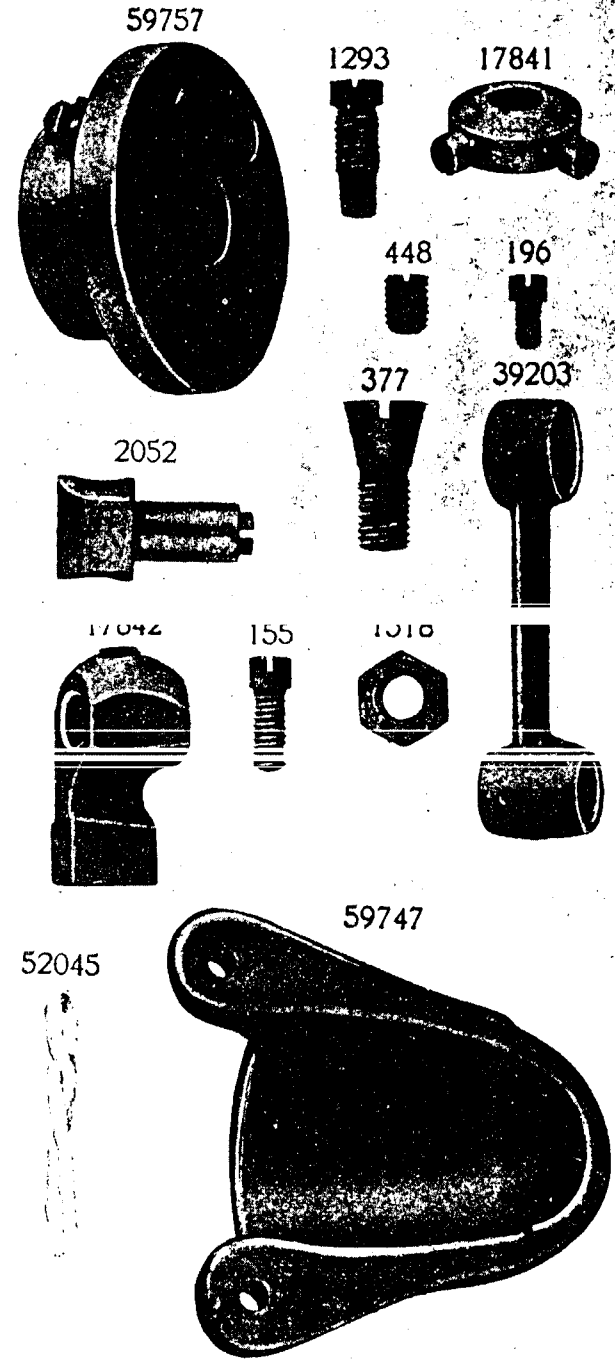

PLATE 6993—FULL SIZE

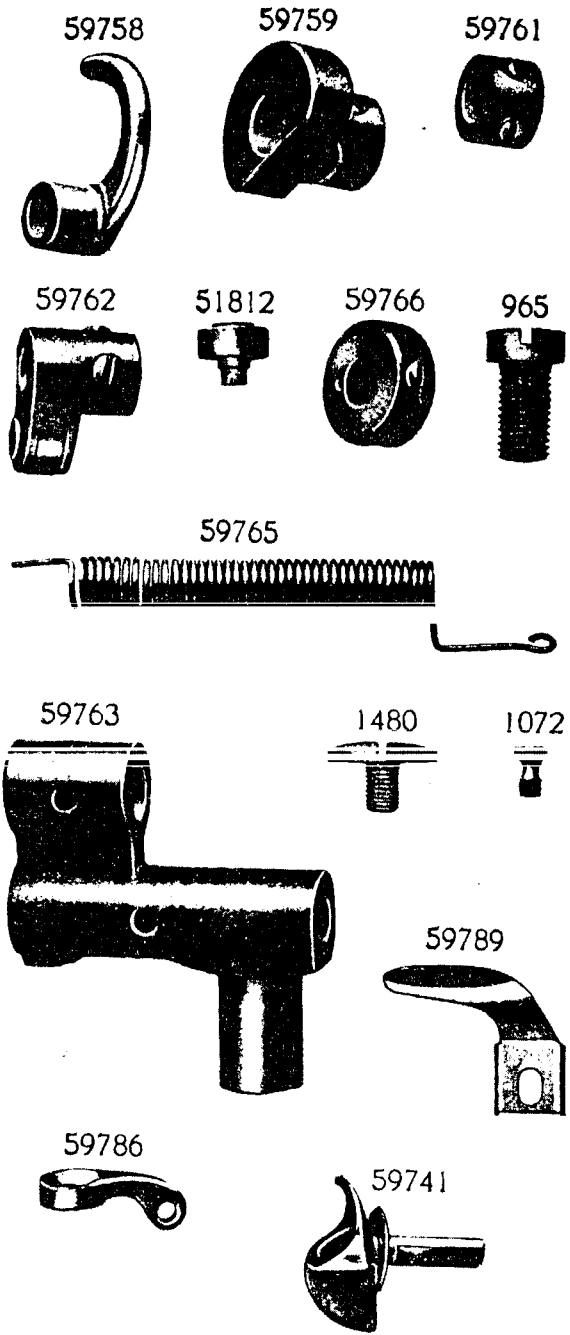

PLATE 6994—FULL SIZE

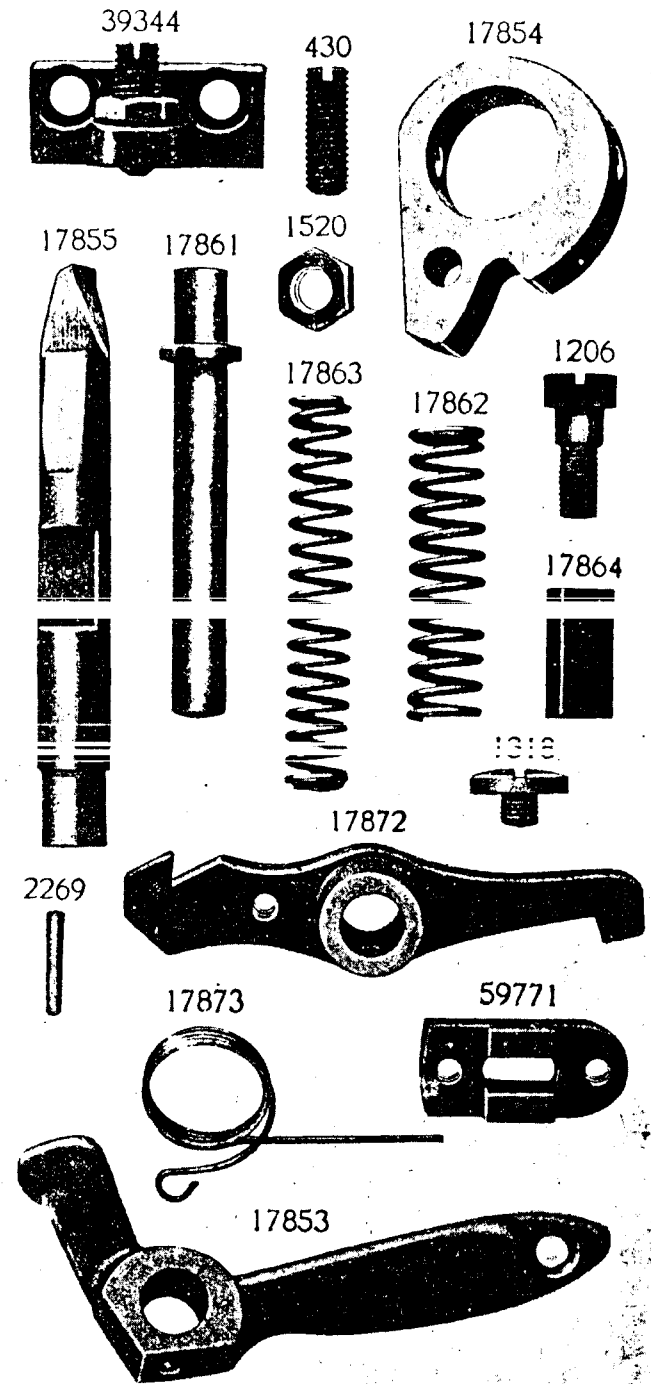

PLATE 6995—FULL SIZE

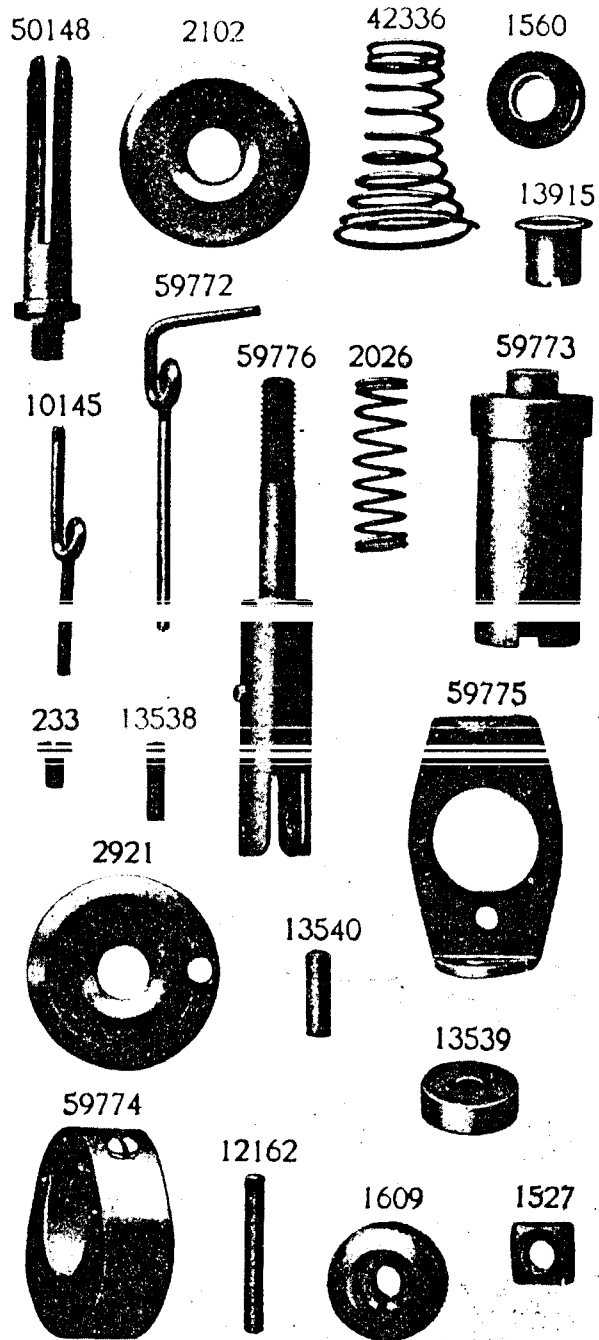

PLATE 6998—FULL SIZE

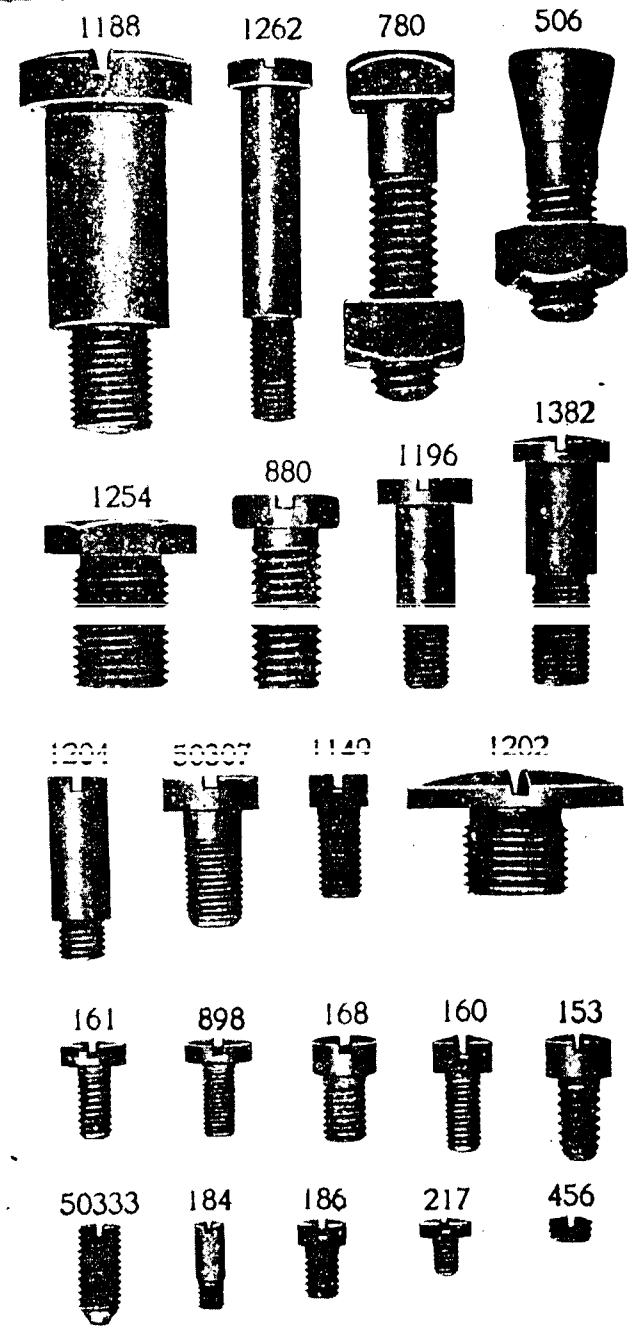

PLATE 6999—FULL SIZE

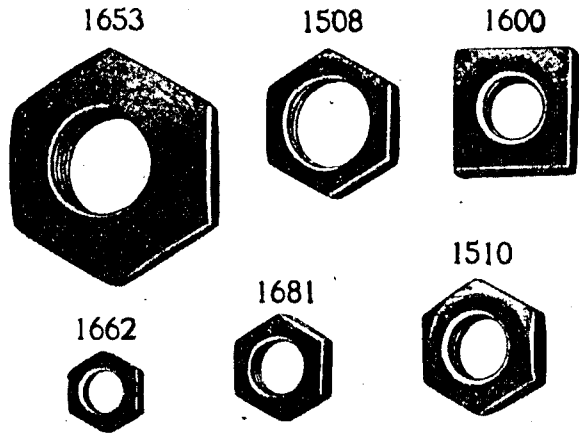

PLATE 7005—ONE-FOURTH SIZE

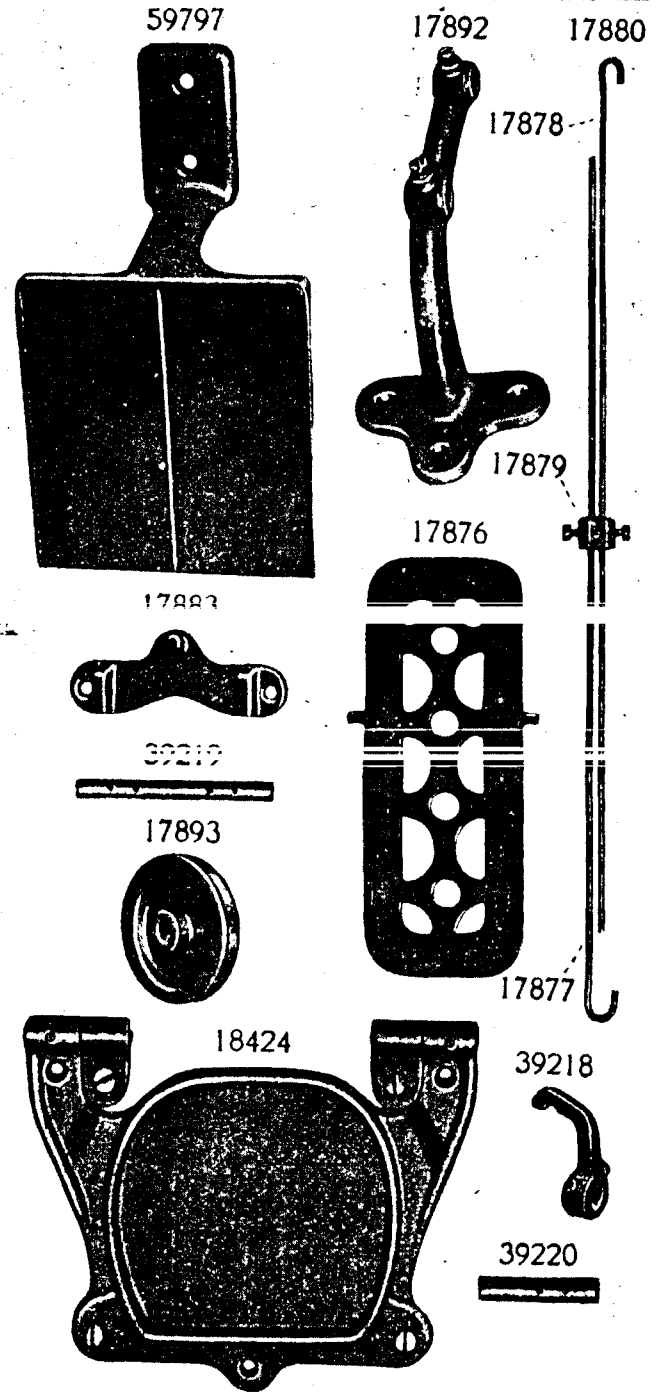

PLATE 7006--FULL SIZE

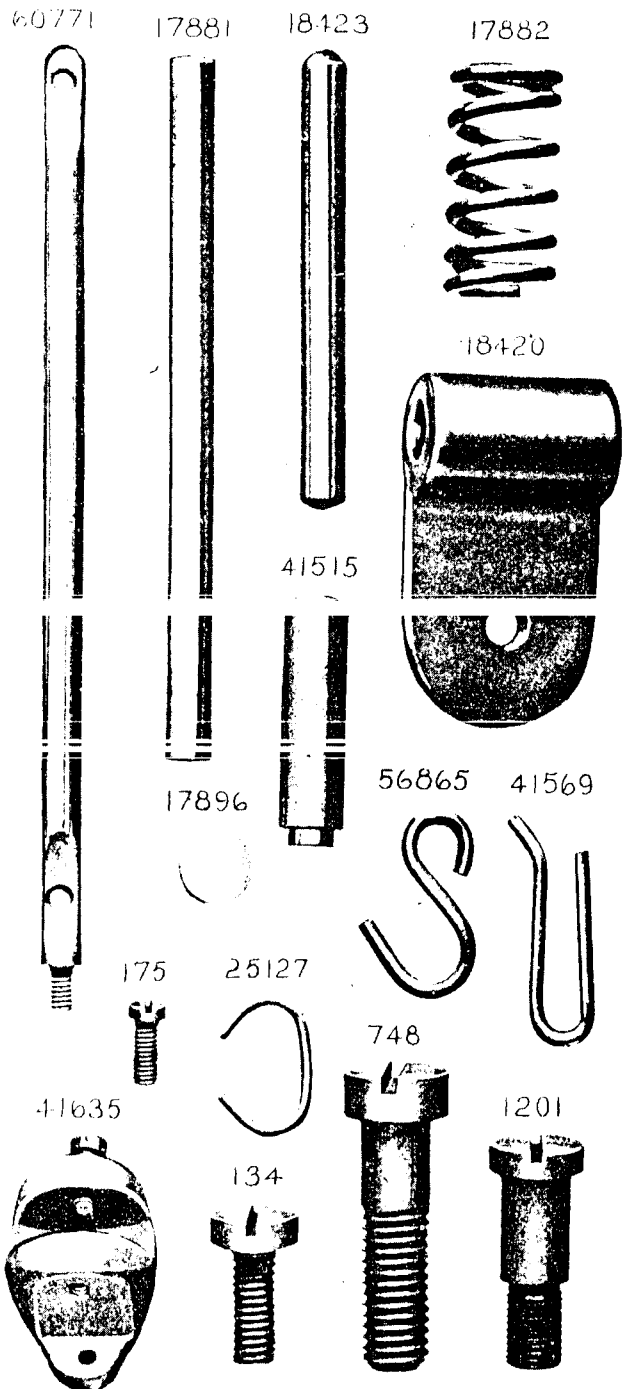

PLATE 7007--ONE-HALF SIZE

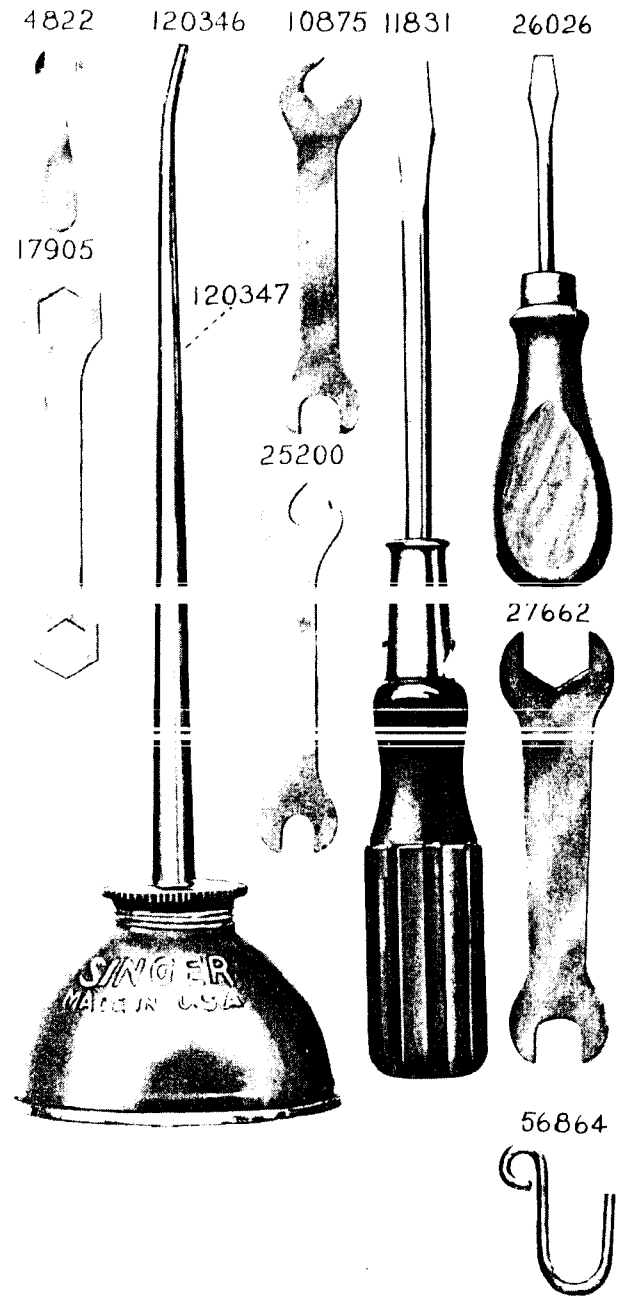

PLATE 7008--ONE-HALF SIZE

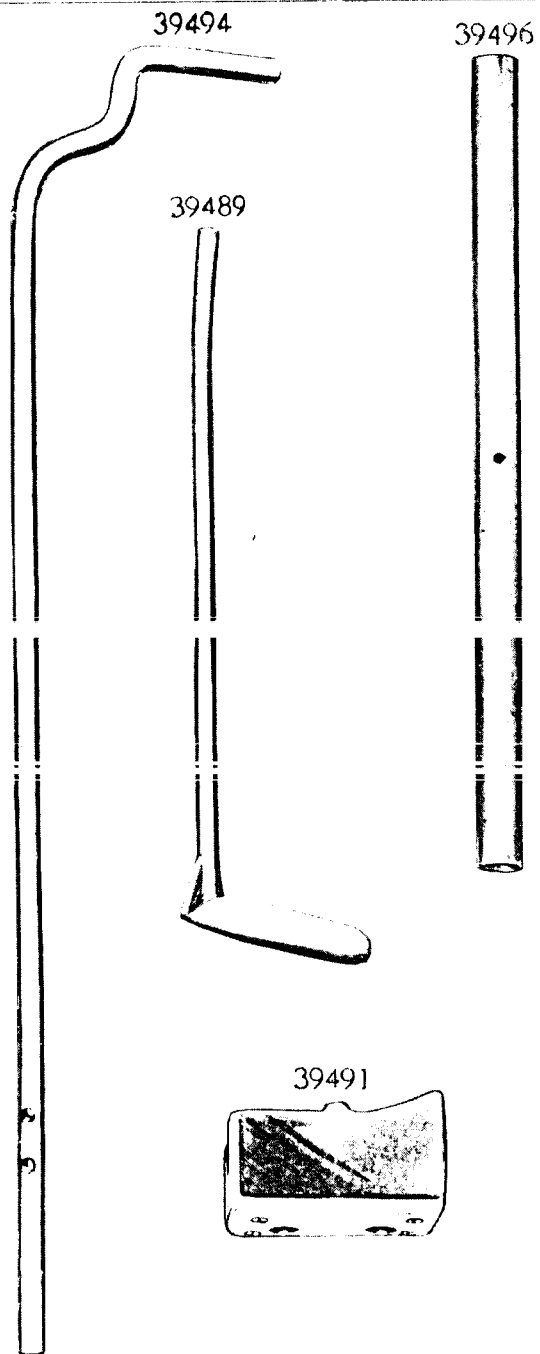

PLATE 7009--FULL SIZE

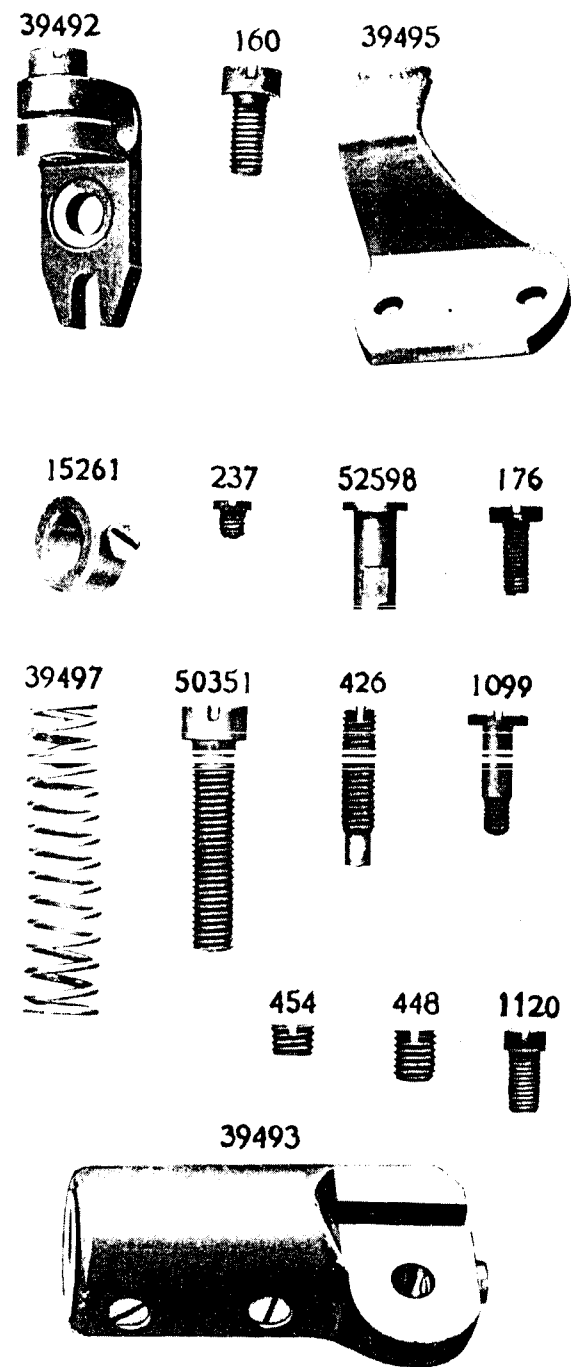

PLATE 7015—FULL SIZE

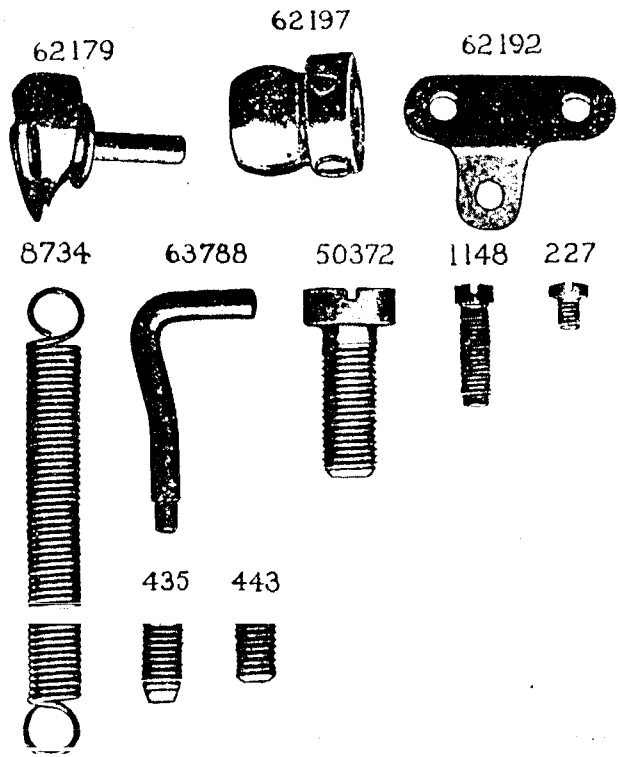

PLATE 7017—FULL SIZE

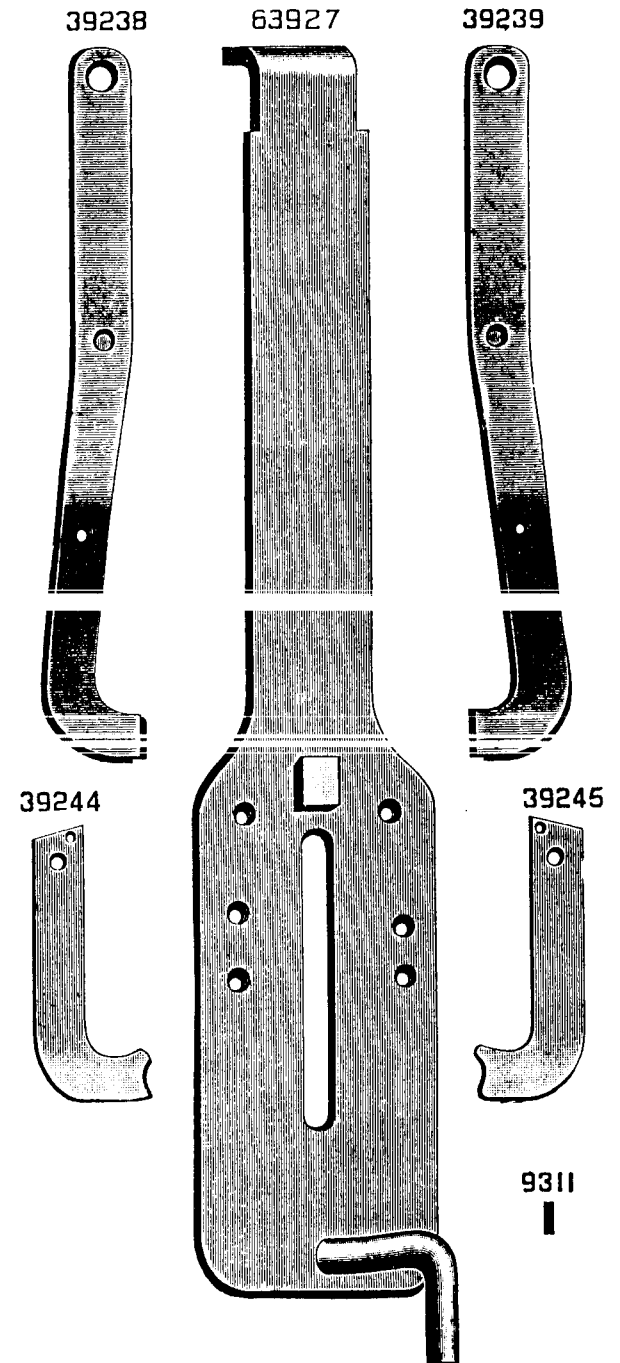

PLATE 7018—FULL SIZE

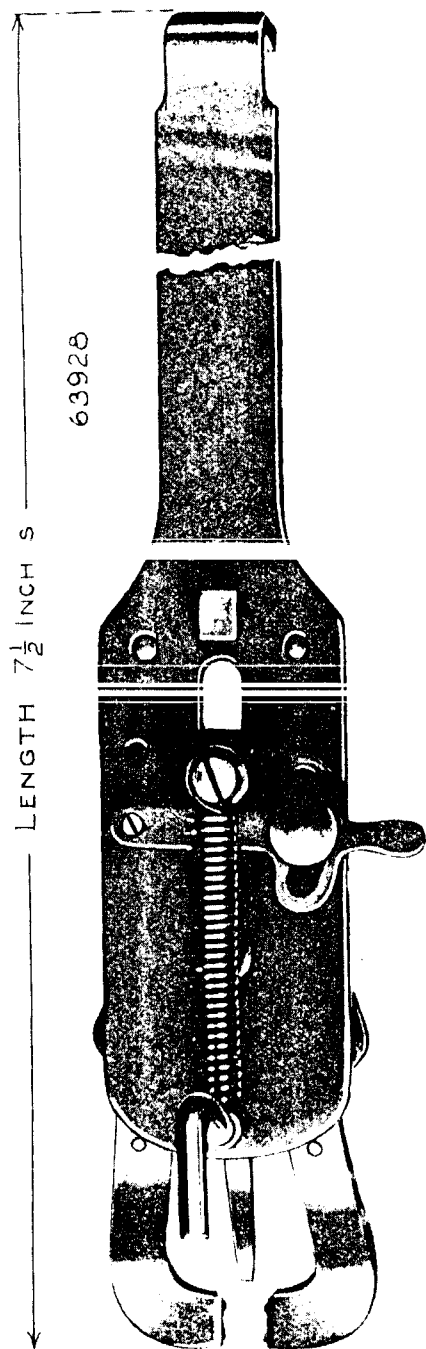

PLATE 7019—FULL SIZE

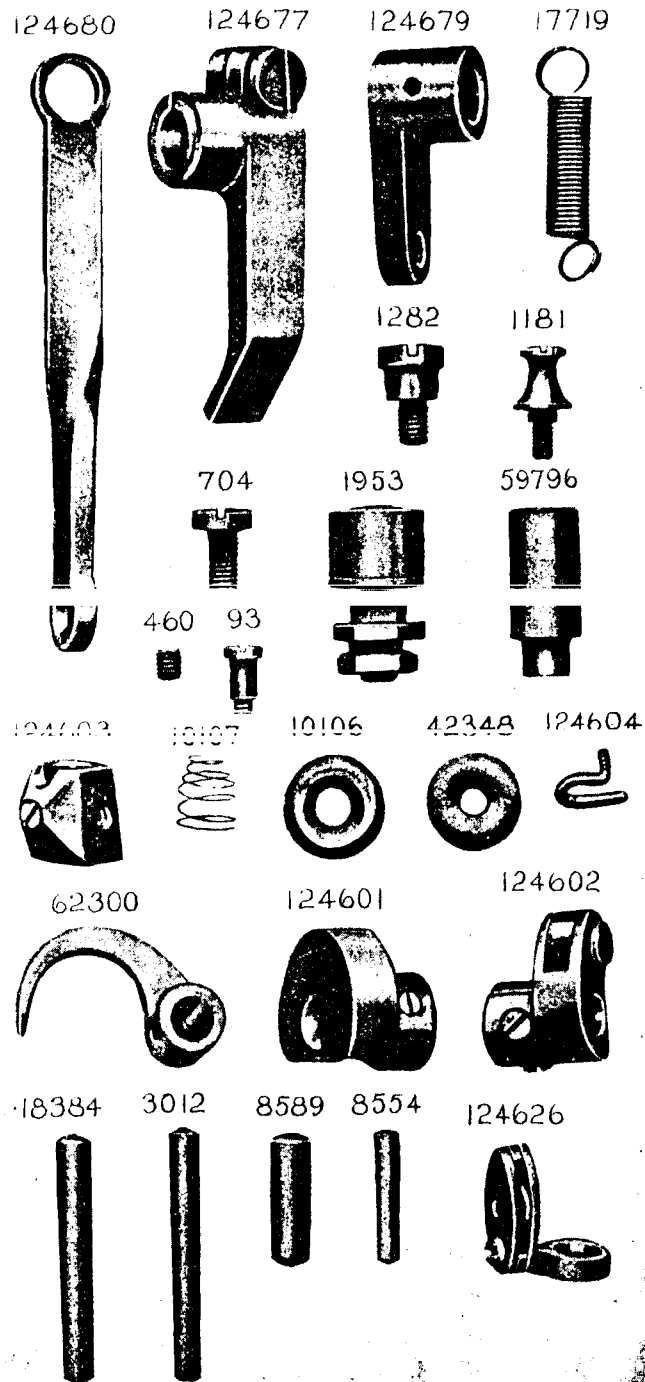

PLATE 7020—ONE-HALF SIZE

124678 62299 124630 124681 62183

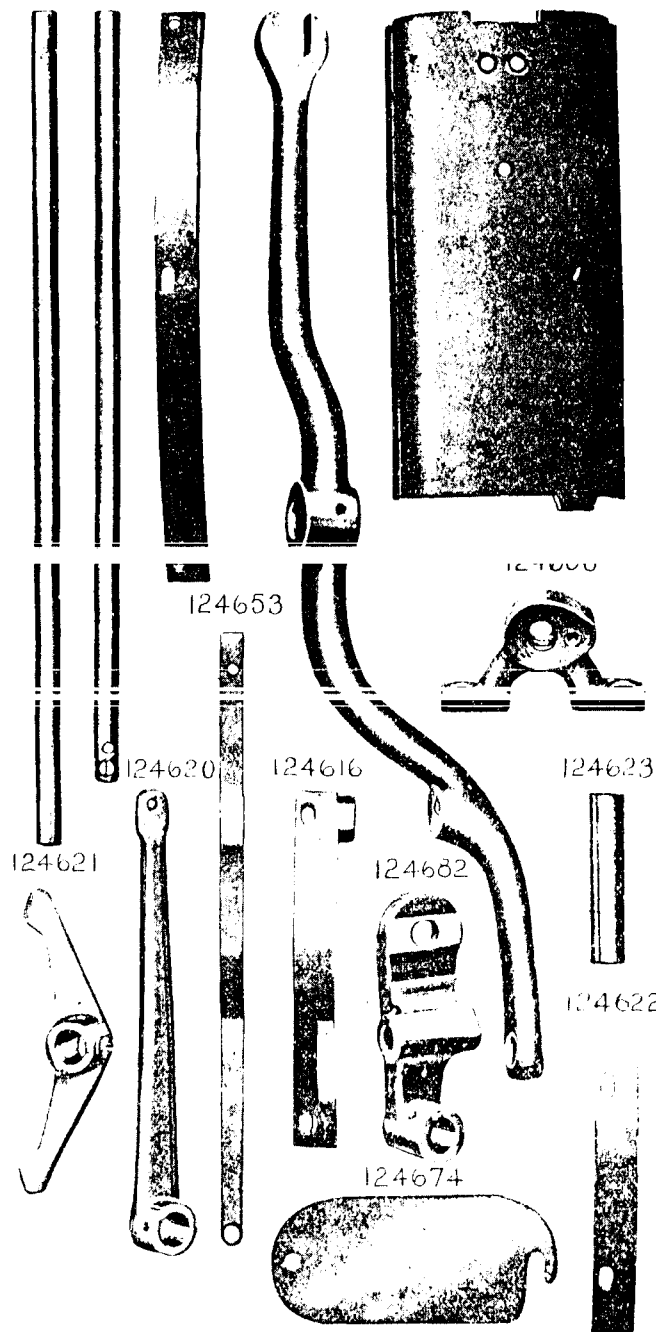
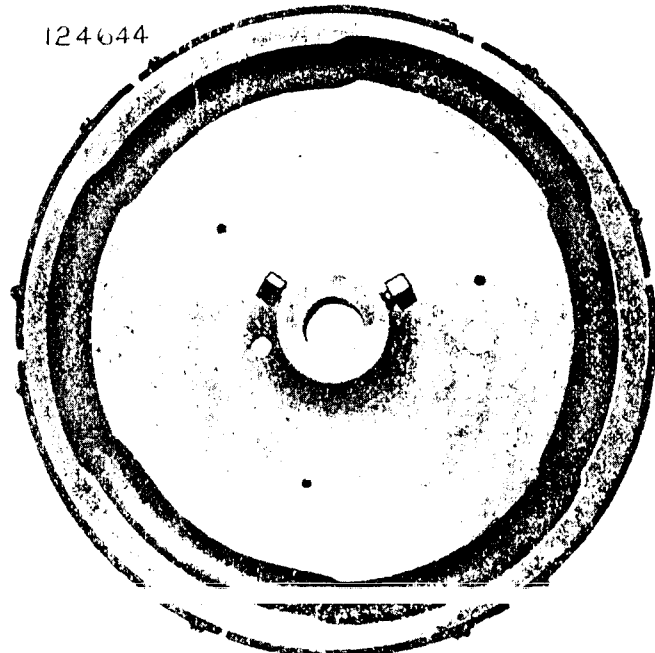

PLATE 7021—ONE-HALF SIZE

124644



124645

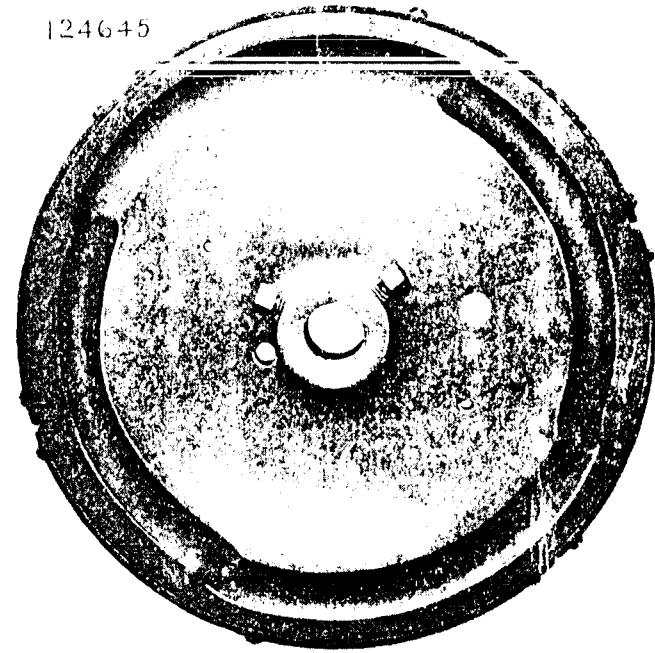
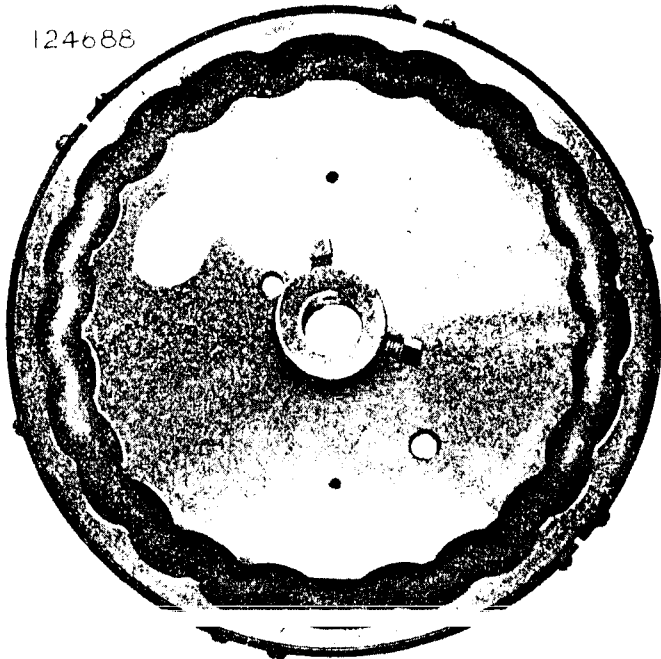

PLATE 7022—ONE-HALF SIZE

124688



124690

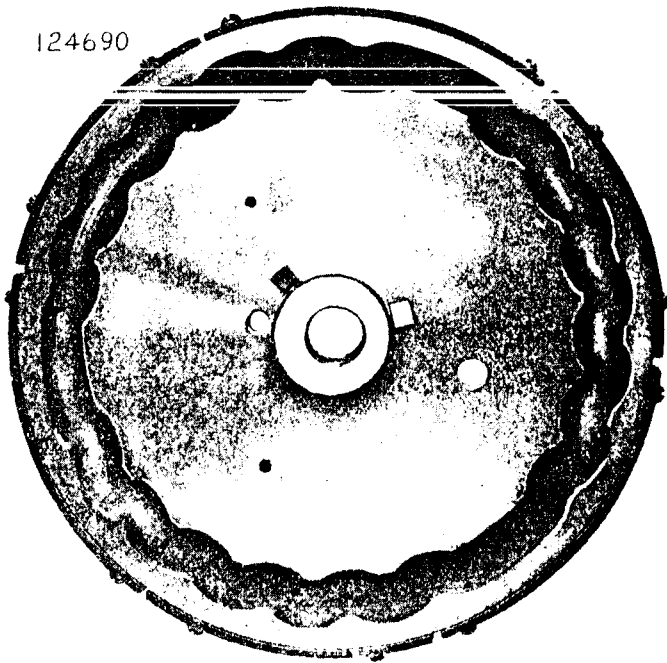
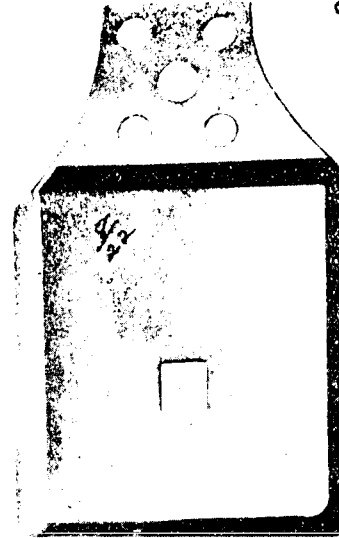

PLATE 7023—FULL SIZE

62297



124666

1195



124610



1654



457



124619



17806



124607



124608



124609



124615



6037



335



62298

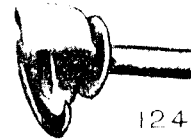

665



124683

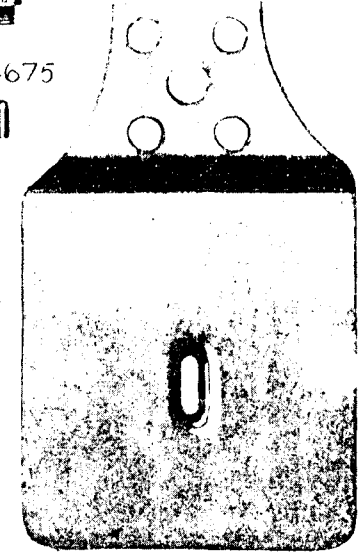

124675



124618



124614

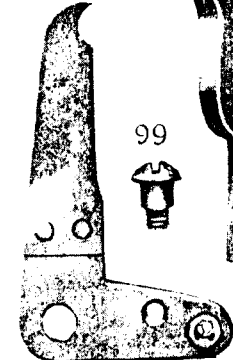

99

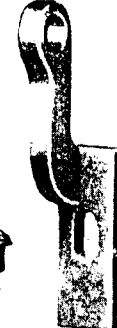

PLATE 7024—FULL SIZE

124627



124628



59790



59799



206



PLATE 7025—ONE-HALF SIZE

124689 124670 124672 124669 124624



25086



1882



4883

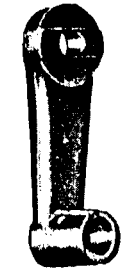

120117



4879



56864

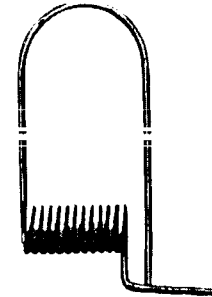

PLATE 7219—ONE-EIGHTH SIZE

82973

46617

