

Singer 17-1
Singer 17-2
Singer 17-3
Singer 17-4
Singer 17-5
Singer 17-6
Singer 17-7
Singer 17-8
Singer 17-9
Singer 17-10
Singer 17-11
Singer 17-12
Singer 17-13
Singer 17-14
Singer 17-15
Singer 17-16
Singer 17-17
Singer 17-18
Singer 17-19
Singer 17-21

Singer 17-22
Singer 17-23
Singer 17-24
Singer 17-25
Singer 17-26
Singer 17-27
Singer 17-28
Singer 17-29
Singer 17-30

FORM 8884—REVISED
JULY, 1933
PRINTED IN U. S. A.

LIST OF PARTS



MACHINES

Nos. 17-1 to 17-30

** A TRADE-MARK OF
THE SINGER MANUFACTURING COMPANY

INSTRUCTIONS FOR OILING

To ensure easy running and prevent unnecessary wear of the parts which are in movable contact, the machine requires oiling and when in continuous use, "TYPE B" or "TYPE D" OIL, sold only by Singer Sewing Machine Company, should be applied at least twice each day to all oil holes marked "OIL", as instructed in Form 7946.

"TYPE D" OIL is stainless.

COPYRIGHT, U. S. A.,
1914, 1916, 1922, 1923, 1928 AND 1933,
BY THE SINGER MANUFACTURING CO.
ALL RIGHTS RESERVED FOR ALL COUNTRIES

INDEX

	PAGE
ACCESSORIES.....	171
BINDER.....	172
BINDERS ON SHANK.....	172
BOBBIN WINDERS.....	173
FOOT LIFTER PARTS.....	180
KNEE LIFTER PARTS.....	181
KNIFE GRINDER.....	177
MACHINE BASE.....	171
" No. 17-1.....	9
" " 17-2.....	15
" " 17-3.....	16
" " 17-4.....	21
" " 17-5.....	26
" " 17-6.....	31
" " 17-7.....	37
" " 17-8.....	45
" " 17-9.....	51
" " 17-10.....	56
" " 17-11.....	62
" " 17-12.....	68
" " 17-13.....	74
" " 17-14.....	79
" " 17-15.....	80
" " 17-16.....	86
" " 17-17.....	93
" " 17-18.....	98
" " 17-19.....	103
" " 17-20.....	108
" " 17-21.....	113
" " 17-22.....	121
" " 17-23.....	127
" " 17-24.....	133
" " 17-25.....	138
" " 17-26.....	143
" " 17-27.....	149
" " 17-28.....	154
" " 17-29.....	159
" " 17-30.....	166
NUMERICAL LIST OF PARTS.....	195
OBSOLETE PARTS.....	184
ROLLER PRESSER (BALL BEARING).....	178
TAPE HOLDER (STRAIGHT).....	172
THREAD LUBRICATOR.....	179
" UNWINDERS.....	183

INSTRUCTIONS FOR ORDERING

In ordering from this list, use ONLY the part NUMBER in the FIRST column.

The number stamped on a Sewing Machine Part is in every case the number of the single part only.

Every combination of parts sent out as such has its specific number, which, although not stamped on the parts, must be used when ordering the combination.

Each number always indicates the SAME PART in whatever list it appears, or for whatever machine.

The letters after some of the numbers indicate the style of finish only, as follows:

- A—Hardened, Polished, Nickel Plated and Buffed
- B—Polished, Nickel Plated and Buffed
- C—Hardened Only
- D—Polished Only
- E—Soft, Not Polished
- F—Hardened and Polished
- H—Blued
- J—Nickel Plated Only
- K—Hardened and Nickel Plated
- L—Brass Plated
- M—Oxidized
- N—Japanned, Dull
- P—Japanned, Bright
- R—Merlized
- T—Copper Plated
- T. A.—Hardened, Polished, Copper and Nickel Plated and Buffed
- T. B.—Copper and Nickel Plated and Polished
- T. J.—Copper and Nickel Plated Only
- T. K.—Hardened, Copper and Nickel Plated
- T. M.—Copper Plated and Oxidized
- T. L.—Copper and Brass Plated
- U—Zinc Plated
- V—Silver Plated
- W—Polished and Nickel Plated
- Y—Black Nickel Plated Only
- Z—Chromium Plated
- Z. B.—Polished, Nickel Plated, Buffed and Chromium Plated
- Z. J.—Nickel and Chromium Plated

These letters MUST BE USED when they appear in the list; and AFTER the number as in the list.

In this series:

- 1 to 1500 and 50001 to 51500 are Screw Numbers
- 1501 to 1800 and 51501 to 51800 are Nut Numbers
- 1801 to 2000 and 51801 to 52000 are Roller Numbers
- 2001 to 50000 and 52001 and upward are numbers of Machine Parts

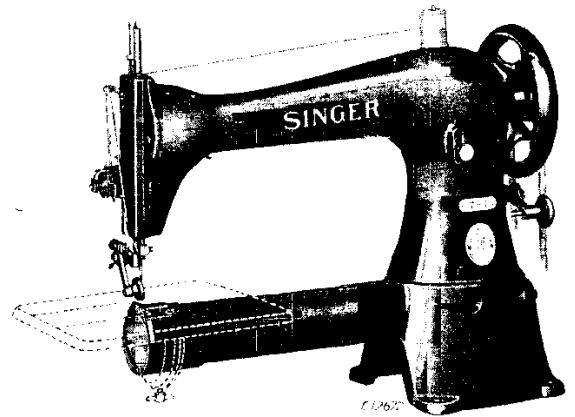
The figures in the second column refer only to the plates, illustrating the parts, and are NOT TO BE USED in ordering.

Parts marked with an asterisk (*) are furnished only when repairs are made at factory.

When ordering parts which differ as to Gauge (the distance between seams) the Gauge, as well as the Number must be given on order.

LIST OF PARTS COMPLETE

FOR



MACHINE No. 17-1

FOR SHOES. DROP FEED ACROSS ARM AT LEFT OF NEEDLE. ROLLER PRESSER

NO.	PLATE	NAME
*6001	—	Arm with 4448, 4449, 15404 and two 15405.....
4389	3383	Arm Dowel Pin.....
4448	3383	" Oil Tube for intermediate bearing..
123E	312	" Screw.....
4368	364	" Shaft.....
3005	259	" " Bushing (back).....
448c	379	" " " " Set Screw....
*4449	—	" " " (front).....
144D	3384	" " Screw.....
4288	368	" Side Cover.....
286D	3385	" " " Thumb Screw.....
12403	377	" Spool Pin and Thread Eyelet.....
11241	382	" " " Washer (cloth).....
4370	364	Balance Wheel, heavy rim, 2¾ in. pulley, with two 418c.....

10 PARTS FOR MACHINE No. 17-1

NO.	PLATE	NAME
2802	364	Balance Wheel, heavy rim, 3 in. pulley for 3022.....
448c	379	Balance Wheel Set Screw.....
2139	366	" " Speed Pulley, 1 $\frac{1}{8}$ in. diam., with 451c.....
2140	366	Balance Wheel Speed Pulley, 2 $\frac{3}{16}$ in. diam., with 437c.....
451c	3385	Balance Wheel Speed Pulley Set Screw for 2139.....
437c	3385	Balance Wheel Speed Pulley Set Screw for 2140.....
256J	259	Clamp Stop Motion Clamp Screw.....
248A	3385	" " " " Stop Screw..
2020	259	" " " " Washer.....
*3023	—	" " " " Flanged Bushing...
4933	259	" " " " " 3023 with two 462c.....
2022	221	Clamp Stop Motion Flanged Bushing Pin.....
462c	3385	Clamp Stop Motion Flanged Bushing Set Screw.....
3022	—	Clamp Stop Motion complete, Nos. 248A, 256J, 2020 and 4933.....
6054	365	Cloth Plate.....
6008	365	" " Bracket with 345c.....
345c	379	" " " " Set Screw.....
389F	312	" " " " Screw.....
6009	368	" " Slide.....
3286	368	" " " " Spring.....
725J	312	" " " " " Screw.....
6005	365	Cloth Plate complete, Nos. 3286, 6009, 6054 and two 725J.....
6004	—	Cloth Plate with Bracket complete, Nos. 6005, 6008 and two 389F.....
4292	364	Crank Connecting Rod.....
145E	3384	" " " " Cap Screw.....
375c	312	" " " " Hinge Screw....
1518J	312	" " " " " " Nut
*6002	—	Cylinder, 2 $\frac{1}{8}$ in. diam.....
4343	365	Face Plate.....
56796	—	" " 4343 with 2105.....
56775	—	Face Plate complete, Nos. 448c, 460c, 2107, 2111, 2127, 2269, 4369, 56791, 56796 and two 233J.....
164J	312	Face Plate Screw.....
2107	221	" " Thread Guard.....
233J	3384	" " " " " Screw.....

PARTS FOR MACHINE No. 17-1 11

NO.	PLATE	NAME
3032	259	Feed Cam with 446c.....
446c	312	" " Set Screw.....
3033	259	" " Connecting Link.....
375c	312	" " " " Hinge Screw....
1518J	312	" " " " " " Nut
6011	372	" Dog, 12 teeth, for 6040 and 16603.
6016	366	" " Carrier.....
225c	379	" " Screw.....
3037	364	" Forked Connection.....
375c	312	" " " " Hinge Screw...
1518J	312	" " " " " " Nut
3039	259	" Regulator.....
58E	312	" " Hinge Screw.....
818D	379	" " Thumb Screw.....
6017	364	" Rock Shaft.....
6018	366	" " " " Crank with 207F.....
156F	379	" " " " Position Screw..
207F	3384	" " " " Set Screw.....
4264	301	Needle Bar.....
*3045	301	" " Connecting Link.....
56773	—	" " " " " 3045 with 2052.....
377c	312	Needle Bar Connecting Link Hinge Screw.....
1518J	312	Needle Bar Connecting Link Hinge Screw Nut.....
2052	374	Needle Bar Connecting Stud with 155c..
155c	3384	" " " " Set Screw..
290E	3385	" " Screw Bushing.....
7524	3383	" Clamp with 196F, 651J and 7525.
196F	3383	" " Screw.....
7525	3383	" " Thread Guide.....
651J	3383	" " " " " Screw.....
*6022	367	Oscillating Rock Shaft with 4781.....
16806	—	Oscillating Rock Shaft complete, Nos. 6022 and 56812.....
3052	367	Oscillating Rock Shaft Hinge Pin.....
56812	—	" " " " " " 3052 with 1513J.....
1513J	379	Oscillating Rock Shaft Hinge Pin Nut...
4784	3383	" " " " Oil Pad.....
6023	364	" Shaft.....
*6056	—	" " Crank with 460c and 1813.....
6024	377	Oscillating Shaft Crank with 1813 and two 462c.....
2049	221	Oscillating Shaft Crank Pin.....

NO.	PLATE	NAME
1813	221	Oscillating Shaft Crank Roller and Stud.
460c	3379	" " " " Set Screw for 6056
462c	3385	Oscillating Shaft Crank Set Screw for 6024
3054	301	Presser Bar
52016	20879	" " " Lifter
689c	312	" " " " Screw
1520E	379	" " " " Nut
5608	259	" " " Lifting Bracket with 453c
453c	3385	" " " " Set Screw
290E	3385	" " " Screw Bushing
3056	301	" " " Spring (heavy)
2308	301	" " " " (light)
2070	221	" " " " Washer
2180	372	" " " Foot
190J	3384	" " " Screw
262J	312	Pressure Regulating Thumb Screw
1868	231	Roller, 7/8 in. diam., coarse, with 652D and 1528J, for 2196
1841	---	Roller, 7/8 in. diam., fine, with 652D and 1528J, for 2197
1839	231	Roller, 1 1/4 in. diam., coarse, with 386D and 1528J, for 16099
1869	---	Roller, 1 1/4 in. diam., fine, with 386D and 1528J, for 16100
2203	231	Roller Arm for 2196 and 2197
16098	3371	" " " " 16099 and 16100
440F	231	" " " Adjusting Screw
1547J	231	" " " " Nut
2206	231	" " " Bracket for 2196 and 2197
4282	3371	" " " " 16099 and 16100
316F	231	" " " " Screw Center
15444	---	" " " " " " 316F with 1547J
1547J	231	Roller Arm Bracket Screw Center Nut
2205	231	" " " Lock Spring
176J	231	" " " " " Screw
1549J	231	" " " " " " Nut
2196	3371	Roller Presser complete, 7/8 in. coarse roller, Nos. 176J, 440F, 1547J, 1549J, 1868, 2203, 2205, 2206 and two 15444
2197	---	Roller Presser complete, 7/8 in. fine roller, Nos. 176J, 440F, 1547J, 1549J, 1841, 2203, 2205, 2206 and two 15444

NOTE: No. 2197 is sent with this machine unless another Roller Presser is specified on order.

NO.	PLATE	NAME
16099	3371	Roller Presser complete, 1 1/4 in. coarse roller, Nos. 176J, 440F, 1547J, 1549J, 1839, 2205, 4282, 16098 and two 15444
16100	---	Roller Presser complete, 1 1/4 in. fine roller, Nos. 176J, 440F, 1547J, 1549J, 1869, 2205, 4282, 16098 and two 15444
190J	3384	Roller Presser Screw
652D	3385	" " " " " Screw for 1841 and 1868
386D	3385	" " " " " " 1839 and 1869
1528J	3386	" " " " " Nut
2073	217	Shuttle Bobbin
2211	217	" " " Retaining Spring
2212	217	" " " " " Rivet
*6058	---	Shuttle Body with 398E, 2082, 2084, 2211 and two 2212
*15458	---	Shuttle Cover
125017	---	" " " 15458 with 112E, 466H, 2078, 2080, 2086 and 2090
2076	217	Shuttle Cover Hinge Pin
2078	217	" " " Delivery Eye Thread Guard
2080	217	" " " " " " Rivet
2082	217	" " " Main Spring
398E	217	" " " " " Screw
2084	217	" " " " " Steady Pin
466H	217	" " " Tension Regulating Screw
2086	217	" " " " " Spring
2090	217	" " " " " Plate
112E	217	" " " " " " Screw
16892	20880	Shuttle (high point) complete, Nos. 2073, 2076, 6058 and 125017
6029	367	Shuttle Driver and Feed Lifting Cam
2049	221	" " " " " " " Pin
6057	---	" " " Race Ring
6032	367	" " " " " 6057 with 65059 and two 337J
16688	---	Shuttle Race Ring Cover
16689	382	" " " " " 16688 with 16242 and two 725J
16242	20880	Shuttle Race Ring Cover Latch
725J	312	" " " " " " Screw
50250J	3388	" " " " " " Screw
175J	3384	" " " " " " Screw
65059	20879	" " " " " Thread Protector
337J	3385	" " " " " " Screw
2102	377	Tension Disc
1560c	379	" " " Regulating Thumb Nut

NO.	PLATE	NAME
4369	377	Tension Releaser.....
2269	377	" " Hinge Pin.....
600c	379	" " Screw Stud.....
16202	—	" " " 600c with 1560c....
448c	379	" " " Set Screw.....
2103	377	" Spring.....
2105	377	" Thread Guard.....
56791	—	Tension complete, Nos. 2103, 2124, 16202 and two 2102.....
2112	221	Thread Retaining Disc with 2113.....
2113	221	" " " Steady Pin.....
2114	221	" " " Spring.....
2115	221	" " " Stud.....
460c	3379	" " " Set Screw.....
2111	221	Thread Retainer Guide complete, Nos. 2112, 2114 and 2115.....
*56831	—	Thread Take-up Cam.....
3280	382	" " " 56831 with 446c...
3012	297	" " " Pin.....
446c	312	" " " Set Screw.....
*3072	259	" " Lever with 1819.....
56855	—	" " " 3072 with 1088c
1088c	3388	" " " Hinge Screw.....
1819	379	" " " Roller and Stud
2124	221	" " Spring.....
2127	221	" " " Regulator Plate
233r	3384	" " " " " "
		Adjusting Screw.....
6040	372	Throat Plate, large needle hole, for 6011
16603	—	" " " small needle hole, for 6011
401d	3385	" " " Screw.....
6053	380	Drip Pan.....
*15404	—	Trade Mark.....
15405	20883	" " Rivet.....

SINGER Needles should be used in **SINGER** Machines. These Needles and their Containers are marked with the Company's Trade-Mark "**SIMANCO**."** 1

Needles in Containers marked "**FOR SINGER MACHINES**" are NOT **SINGER** made needles. 2

MACHINE No. 17-2

FOR SHOES. DROP FEED ACROSS ARM AT RIGHT OF NEEDLE. ROLLER PRESSER

This Machine is the same as No. 17-1 with the following exceptions:

NO.	PLATE	NAME
6068	371	Feed Dog, 12 teeth, for leather, for 6075, in place of 6011.....
16642	382	Needle Bar with 10160, in place of 4264.
16643	385	" " Thread Guard, in place of 7525.....
240r	385	Needle Bar Thread Guard Screw, in place of 651r.....
16644	385	Needle Clamp with 1112r, in place of 7524.....
1112r	385	Needle Clamp Screw, in place of 196r...
10160	3383	" Stop Pin.....
2062	301	Presser Bar Lifter, in place of 52016.....
6069	376	" Foot, in place of 2180.....
6072	389	Roller Arm for 6070 and 6071, in place of 2203.....
16625	385	Roller Arm for 16623 and 16624, in place of 16098.....
6073	385	Roller Arm Bracket, in place of 2206 and 4282.....
6070	—	Roller Presser complete, 7/8 in. coarse roller, Nos. 176r, 440r, 1547r, 1549r, 1868, 2205, 6072, 6073 and two 15444, in place of 2196.....
6071	378	Roller Presser complete, 3/8 in. fine roller, Nos. 176r, 440r, 1547r, 1549r, 1841, 2205, 6072, 6073 and two 15444, in place of 2197.....
<p>NOTE: No. 6071 is sent with this machine unless another Roller Presser is specified on order.</p>		
16623	385	Roller Presser complete, 1 1/4 in. coarse roller, Nos. 176r, 440r, 1547r, 1549r, 1839, 2205, 6073, 16625 and two 15444, in place of 16099.....
16624	—	Roller Presser complete, 1 1/4 in. fine roller, Nos. 176r, 440r, 1547r, 1549r, 1869, 2205, 6073, 16625 and two 15444, in place of 16100.....
6075	371	Throat Plate for 6068, in place of 6040 and 16603.....

LIST OF PARTS COMPLETE

FOR

MACHINE No. 17-3

WHEEL FEED AT RIGHT OF NEEDLE.

ROLLER PRESSER. FOR SHOE WORK.

NO.	PLATE	NAME
*6001	---	Arm with 4448, 4449, 15404 and two 15405.....
4389	3383	Arm Dowel Pin.....
4448	3383	" Oil Tube for intermediate bearing
123E	312	" Screw.....
4368	364	" Shaft.....
3005	259	" " Bushing (back).....
448c	379	" " " " Set Screw....
*4449	---	" " " " (front).....
144d	3384	" " Screw.....
4288	368	" Side Cover.....
286d	3385	" " " Thumb Screw.....
12403	377	" Spool Pin and Thread Eyelet.....
11241	382	" " " Washer (cloth).....
4370	364	Balance Wheel, heavy rim, 2 $\frac{3}{4}$ in. pulley, with two 448c.....
2862	364	Balance Wheel, heavy rim, 3 in. pulley, for 3022.....
448c	379	Balance Wheel Set Screw.....
2139	366	" " Speed Pulley, 1 $\frac{1}{2}$ in. diam., with 451c.....
2140	366	Balance Wheel Speed Pulley, 2 $\frac{1}{4}$ in. diam., with 437c.....
451c	3385	Balance Wheel Speed Pulley Set Screw for 2139.....
437c	3385	Balance Wheel Speed Pulley Set Screw for 2140.....
256J	259	Clamp Stop Motion Clamp Screw.....
248A	3385	" " " " Stop Screw..
2020	259	" " " " Washer.....
*3023	---	" " " Flanged Bushing..
4933	259	" " " " " 3023 with two 462c.....
2022	221	Clamp Stop Motion Flanged Bushing Pin.....
462c	3385	Clamp Stop Motion Flanged Bushing Set Screw.....

NO.	PLATE	NAME
3022	---	Clamp Stop Motion complete, Nos. 248A, 256J, 2020 and 4933.....
16768	365	Cloth Plate.....
6083	365	" " Bracket with two 345c.....
345c	379	" " " Set Screw.....
389F	312	" " Screw.....
6009	368	" " Slide.....
3286	368	" " " Spring.....
725J	312	" " " " Screw.....
6082	365	Cloth Plate complete, Nos. 3286, 6009, 16768 and two 725J.....
6081	---	Cloth Plate with Bracket complete, Nos. 6082, 6083 and two 389F.....
4292	364	Crank Connecting Rod.....
145E	3384	" " " Cap Screw.....
375c	312	" " " Hinge Screw....
1518J	312	" " " " " Nut
*6080	---	Cylinder, 2 $\frac{1}{4}$ in. diam.....
4343	365	Face Plate.....
56796	---	" " 4343 with 2105.....
56775	---	Face Plate complete, Nos. 448c, 460c, 2107, 2111, 2127, 2269, 4369, 56791, 56796 and two 233J.....
164J	312	Face Plate Screw.....
2107	221	" " Thread Guard.....
233J	3384	" " " " Screw.....
3033	259	Feed Connecting Link.....
375c	312	" " " Hinge Screw....
1518J	312	" " " " " Nut
3074	259	" Eccentric with 446c.....
446c	312	" " Set Screw.....
3037	364	" Forked Connection.....
375c	312	" " " Hinge Screw....
1518J	312	" " " " " Nut
3039	259	" Regulator.....
58E	312	Feed Regulator Hinge Screw.....
818D	379	" " Thumb Screw.....
6085	364	" Rock Shaft.....
6018	366	" " " Crank with 207F.....
156F	379	" " " " Position Screw..
207F	3384	" " " " Set Screw.....
6086	367	" Wheel.....
6087	366	" " Driver.....
6088	375	" " " Spring.....
207F	3384	" " " " Screw.....
6089	377	" " Friction Spring.....
207F	3384	" " " " Screw.....

NO.	PLATE	NAME
16642	382	Needle Bar with 10160.....
*3045	301	" " Connecting Link.....
56773	—	" " " " 3045 with 2052.....
377c	312	Needle Bar Connecting Link Hinge Screw.....
1518j	312	Needle Bar Connecting Link Hinge Screw Nut.....
2052	374	Needle Bar Connecting Stud with 155c..
155c	3384	" " " " Set Screw..
290E	3385	" " Screw Bushing.....
16643	385	" " Thread Guard.....
665j	3384	" " " " Screw.....
16644	385	" Clamp with 1112F.....
1112F	385	" " Screw.....
10160	3383	" Stop Pin.....
*6022	367	Oscillating Rock Shaft with 4784.....
16806	—	Oscillating Rock Shaft complete, Nos. 6022 and 56812.....
3052	367	Oscillating Rock Shaft Hinge Pin.....
56812	—	" " " " " 3052 with 1513j.....
1513j	379	Oscillating Rock Shaft Hinge Pin Nut...
4784	3383	" " " Oil Pad.....
6023	364	" Shaft.....
*6056	—	" " Crank with 460c and 1813.....
6024	377	Oscillating Shaft Crank with 1813 and two 462c.....
2049	221	Oscillating Shaft Crank Pin.....
1813	221	" " " Roller and Stud
460c	3379	" " " Set Screw for 6056.....
462c	3385	Oscillating Shaft Crank Set Screw for 6024.....
3054	301	Presser Bar.....
52016	20879	" " Lifter.....
689c	312	" " " Screw.....
1520E	379	" " " Nut.....
5608	259	" " Lifting Bracket with 453c...
453c	3385	" " " Set Screw...
290E	3385	" " Screw Bushing.....
3056	301	" " Spring (heavy).....
2308	301	" " " (light).....
2070	221	" " Washer.....
6069	376	" Foot.....
190j	3384	" " Screw.....

NO.	PLATE	NAME
202j	312	Pressure Regulating Thumb Screw.....
1868	231	Roller, $\frac{7}{8}$ in. diam., coarse, with 652D and 1528j, for 6070.....
1841	—	Roller, $\frac{7}{8}$ in. diam., fine, with 652D and 1528j, for 6071.....
6072	389	Roller Arm.....
440F	231	" " Adjusting Screw.....
1547j	231	" " " " Nut.....
6073	385	" " Bracket.....
316F	231	" " " Screw Center.....
15444	—	" " " " " 316F with 1547j.....
1547j	231	Roller Arm Bracket Screw Center Nut..
2205	231	" " Lock Spring.....
176j	231	" " " " Screw.....
1549j	231	" " " " " Nut.....
6070	—	Roller Presser complete, $\frac{7}{8}$ in. coarse roller, Nos. 176j, 440F, 1547j, 1549j, 1868, 2205, 6072, 6073 and two 15444.
6071	378	Roller Presser complete, $\frac{1}{4}$ in. fine roller, Nos. 176j, 440F, 1547j, 1549j, 1841, 2205, 6072, 6073 and two 15444.....
NOTE: No. 6071 is sent with this machine unless another Roller Presser is specified on order.		
190j	3384	Roller Presser Screw.....
652D	3385	" Screw.....
1528j	3386	" " Nut.....
2073	217	Shuttle Bobbin.....
2211	217	" " Retaining Spring.....
2212	217	" " " Rivet..
*6058	—	" Body with 398E, 2082, 2084, 2211 and two 2212.....
*15458	—	Shuttle Cover.....
125017	—	" " 15458 with 112E, 466H, 2078, 2080, 2086 and 2090.....
2076	217	Shuttle Cover Hinge Pin.....
2078	217	" Delivery Eye Thread Guard....
2080	217	" " " " Rivet
2082	217	" Main Spring.....
398E	217	" " " Screw.....
2084	217	" " " Steady Pin.....
466H	217	" Tension Regulating Screw.....
2086	217	" " Spring.....
2090	217	" " " Plate.....
112E	217	" " " " Screw.....

NO.	PLATE	NAME
16892	20880	Shuttle (high point) complete, Nos. 2073, 2076, 6058 and 125017.....
16640	385	Shuttle Driver.....
2049	221	" " Pin.....
6090	367	" Race and Throat Ring.....
198J	312	" " " " " Screw....
2102	377	Tension Disc.....
1560c	379	" Regulating Thumb Nut.....
4369	377	" Releaser.....
2269	377	" " Hinge Pin.....
600c	379	" Screw Stud.....
16202	—	" " " 600c with 1560c....
448c	379	" " " Set Screw.....
2103	377	" Spring.....
2105	377	" Thread Guard.....
56791	—	Tension complete, Nos. 2103, 2124, 16202 and two 2102.....
2112	221	Thread Retaining Disc with 2113.....
2113	221	" " " Steady Pin.....
2114	221	" " Spring.....
2115	221	" " Stud.....
460c	3379	" " " Set Screw.....
2111	221	Thread Retainer Guide complete, Nos. 2112, 2114 and 2115.....
*56831	—	Thread Take-up Cam.....
3280	382	" " " 56831 with 446c..
3012	297	" " " Pin.....
446c	312	" " " Set Screw.....
*3072	259	" " Lever with 1819.....
56855	—	" " " 3072 with 1088c
1088c	3388	" " " Hinge Screw.....
1819	379	" " " Roller and Stud
2124	221	" " Spring.....
2127	221	" " " Regulator Plate
233J	3384	" " " " " "
		Adjusting Screw.....
6053	380	Drip Pan.....
*15404	—	Trade Mark.....
15405	20883	" " Rivet.....

LIST OF PARTS COMPLETE

FOR

MACHINE No. 17-4

WHEEL FEED AT RIGHT OF NEEDLE. EXCLUSIVELY FOR STITCHING IN ENDS OF CYLINDRICAL BOXES

NO.	PLATE	NAME
*6001	—	Arm with 4448, 4449, 15404 and two 15405.....
4389	3383	Arm Dowel Pin.....
4448	3383	" Oil Tube for intermediate bearing
123E	312	" Screw.....
4368	364	" Shaft.....
3005	259	" " Bushing (back).....
448c	379	" " " " Set Screw....
*4449	—	" " " (front).....
144D	3384	" " Screw.....
4288	368	" Side Cover.....
286D	3385	" " " Thumb Screw.....
12403	377	" Spool Pin and Thread Eyelet.....
11241	382	" " " Washer (cloth).....
4370	364	Balance Wheel, heavy rim, 2 $\frac{3}{4}$ in. pulley, with two 448c.....
2862	364	Balance Wheel, heavy rim, 3 in. pulley, for 3022.....
448c	379	Balance Wheel Set Screw.....
2139	366	" " Speed Pulley, 1 $\frac{1}{8}$ in. diam., with 451c.....
2140	366	Balance Wheel Speed Pulley, 2 $\frac{3}{8}$ in. diam., with 437c.....
451c	3385	Balance Wheel Speed Pulley Set Screw for 2139.....
437c	3385	Balance Wheel Speed Pulley Set Screw for 2140.....
6091	369	Box Support (left).....
6092	369	" " (right).....
233J	3384	" " Screw.....
256J	259	Clamp Stop Motion Clamp Screw.....
248A	3385	" " " " Stop Screw..
2020	259	" " " " Washer....
*3023	—	" " " Flanged Bushing...
4933	259	Clamp Stop Motion Flanged Bushing 3023 with two 462c.....
2022	221	Clamp Stop Motion Flanged Bushing Pin.....

NO.	PLATE	NAME
462c	3385	Clamp Stop Motion Flanged Bushing Set Screw.....
3022	—	Clamp Stop Motion complete, Nos. 248A, 256J, 2020 and 4933.....
4292	364	Crank Connecting Rod.....
145E	3384	" " " Cap Screw.....
375c	312	" " " Hinge Screw.....
1518J	312	" " " " " Nut
*6093	—	Cylinder, 2½ in. diam.....
4343	365	Face Plate.....
56796	—	" " 4343 with 2105.....
56775	—	Face Plate complete, Nos. 448c, 460c, 2107, 2111, 2127, 2269, 4369, 56791, 56796 and two 233J.....
164J	312	Face Plate Screw.....
2107	221	" " Thread Guard.....
233J	3384	" " " " Screw.....
3033	259	Feed Connecting Link.....
375c	312	" " " Hinge Screw.....
1518J	312	" " " " " Nut.
3074	259	" Eccentric with 446c.....
446c	312	" " Set Screw.....
3037	364	" Forked Connection.....
375c	312	" " " Hinge Screw.....
1518J	312	" " " " " Nut
3039	259	" Regulator.....
58E	312	" " Hinge Screw.....
818D	379	" " Thumb Screw.....
6085	364	" Rock Shaft.....
6018	366	" " Crank with 207F.....
156F	379	" " " " Position Screw..
207F	3384	" " " " Set Screw.....
6094	—	" Wheel.....
6095	367	" " 6094 with 6096.....
6087	366	" " Driver.....
6088	375	" " " Spring.....
207F	3384	" " " " Screw.....
6089	377	" " Friction Spring.....
207F	3384	" " " " Screw.....
6096	382	" " Guide Ring.....
6099	369	Guide Bracket for 6097.....
6100	369	" " " 6098.....
381D	379	" " Screw.....
6101	369	" Rod.....
6102	369	" " Holder.....
1593D	3386	" " " Thumb Nut.....
42523	3388	" " " Washer.....

NO.	PLATE	NAME
286D	3385	Guide Rod Thumb Screw.....
6104	369	" Roller.....
6097	—	Guide complete, for machine, Nos. 286D, 1593D, 6099, 6101, 6102, 6104, 42523 and two 381b.....
6098	—	Guide complete, for table, Nos. 286D, 1593D, 6100 to 6102, 6104, 42523 and two wood screws 1 in. No. 12.....
16642	382	Needle Bar with 10160.....
*3045	301	" " Connecting Link.....
56773	—	" " " " 3045 with 2052.....
377c	312	Needle Bar Connecting Link Hinge Screw.....
1518J	312	Needle Bar Connecting Link Hinge Screw Nut.....
2052	374	Needle Bar Connecting Stud with 155c..
155c	3384	" " " " Set Screw..
290E	3385	" " Screw Bushing.....
16643	385	" " Thread Guard.....
240J	385	" " " " Screw.....
16644	385	" Clamp with 1112F.....
1112F	385	" " Screw.....
10160	3383	" Stop Pin.....
*6022	367	Oscillating Rock Shaft with 4784.....
16806	—	Oscillating Rock Shaft complete, Nos. 6022 and 56812.....
3052	367	Oscillating Rock Shaft Hinge Pin....
56812	—	" " " " " 3052 with 1513J.....
1513J	379	Oscillating Rock Shaft Hinge Pin Nut...
4784	3383	" " " Oil Pad.....
6023	364	" Shaft.....
*6056	—	" " Crank with 460c and 1813.....
6024	377	Oscillating Shaft Crank with 1813 and two 462c.....
2049	221	Oscillating Shaft Crank Pin.....
1813	221	" " " Roller and Stud
460c	3379	" " " Set Screw for 6056.....
462c	3385	Oscillating Shaft Crank Set Screw for 6024.....
3054	301	Presser Bar.....
52016	20879	" " Lifter.....
689c	312	" " " Screw.....
1520E	379	" " " " Nut.....

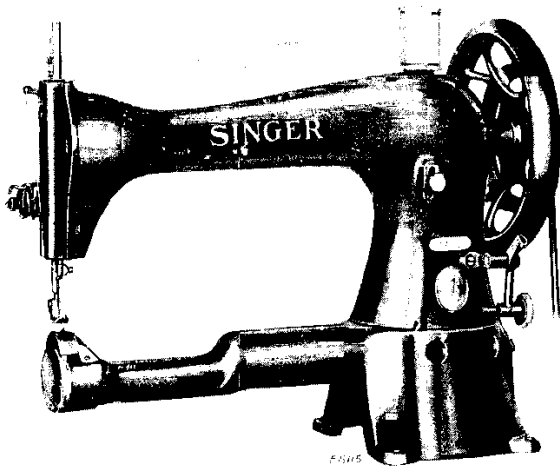
NO.	PLATE	NAME
5608	259	Presser Bar Lifting Bracket with 453c...
453c	3385	" " " " Set Screw...
290e	3385	" " Screw Bushing.....
3056	301	" " Spring (heavy).....
2308	301	" " " (light).....
2070	221	" " " Washer.....
6105	374	" Foot.....
190j	3384	" " Screw.....
262j	312	Pressure Regulating Thumb Screw.....
2073	217	Shuttle Bobbin.....
2211	217	" " Retaining Spring.....
2212	217	" " " " Rivet..
*6058	—	" Body with 398e, 2082, 2084, 2211 and two 2212.....
*15458	—	Shuttle Cover.....
125017	—	" " 15458 with 112e, 466n, 2078, 2080, 2086 and 2090.....
2076	217	Shuttle Cover Hinge Pin.....
2078	217	" Delivery Eye Thread Guard.....
2080	217	" " " " Rivet
2082	217	" Main Spring.....
398e	217	" " " Screw.....
2084	217	" " " Steady Pin.....
466n	217	" Tension Regulating Screw.....
2086	217	" " Spring.....
2090	217	" " " Plate.....
112e	217	" " " " Screw.....
16892	20880	Shuttle (high point) complete, Nos. 2073, 2076, 6058 and 125017.....
16640	385	Shuttle Driver.....
2049	221	" " Pin.....
6106	367	" Race and Throat Ring.....
198j	312	" " " " Screw....
2102	377	Tension Disc.....
1560c	379	" Regulating Thumb Nut.....
4369	377	" Releaser.....
2269	377	" " Hinge Pin.....
600c	379	" Screw Stud.....
16202	—	" " " 600c with 1560c....
448c	379	" " " Set Screw.....
2103	377	" Spring.....
2105	377	" Thread Guard.....
56791	—	Tension complete, Nos. 2103, 2124, 16202 and two 2102.....
2112	221	Thread Retaining Disc with 2113.....
2113	221	" " " Steady Pin.....
2114	221	" " Spring.....

NO.	PLATE	NAME
2115	221	Thread Retaining Stud.....
460c	3379	" " " Set Screw.....
2111	221	" Retainer Guide complete, Nos. 2112, 2114 and 2115.....
*56831	—	Thread Take-up Cam.....
3280	382	" " " 56831 with 446c...
3012	297	" " " Pin.....
446c	312	" " " Set Screw.....
*3072	259	" " Lever with 1819.....
56855	—	" " " 3072 with 1088c
1088c	3388	" " " Hinge Screw.....
1819	379	" " " Roller and Stud
2124	221	" " Spring.....
2127	221	" " " Regulator Plate
233j	3384	" " " " " " Adjusting Screw.....
6053	380	Drip Pan.....
*15404	—	Trade Mark.....
15405	20883	" " Rivet.....

SINGER Needles should be used in SINGER Machines. These Needles and their Containers are marked with the Company's Trade-Mark "SIMANCO." 1

Needles in Containers marked "FOR SINGER MACHINES" are NOT SINGER made needles. 2

**LIST OF PARTS COMPLETE
FOR**



MACHINE No. 17-5

**FOR HORSE BOOTS AND OTHER CONCAVE
ARTICLES IN LEATHER. DROP FEED
ACROSS ARM.**

NO.	PLATE	NAME
*65021	—	Arm with 4448, 4449, 15404 and two 15405.....
4389	3383	Arm Dowel Pin.....
4448	3383	" Oil Tube for intermediate bearing
123E	312	" Screw.....
6109	364	" Shaft for 3011.....
6107	364	" " " 5977.....
3005	259	" " Bushing (back).....
448c	379	" " " " Set Screw....
*4449	—	" " " (front).....
144D	3384	" " Screw.....
4288	368	" Side Cover.....
286D	3385	" " " Thumb Screw.....

PARTS FOR MACHINE No. 17-5

NO.	PLATE	NAME
12403	377	Arm Spool Pin and Thread Eyelet.....
11241	382	" " " Washer (cloth).....
3011	3364	Balance Wheel (two speed) 3 in. and 5 in. pulleys, with two 448c.....
5977	3364	Balance Wheel (two speed) 3 in. and 5 in. pulleys, for 5981.....
448c	379	Balance Wheel Set Screw.....
4292	364	Crank Connecting Rod.....
145E	3384	" " " Cap Screw.....
375c	312	" " " Hinge Screw....
1518J	312	" " " " " Nut
*6110	—	Cylinder, 2 1/8 in. diam.....
6111	382	" " Feed Cover.....
337J	3385	" " " Screw.....
5978	366	Driving Flange with two 435c.....
5993	—	Driving Flange complete, Nos. 136F, 330J and 5978 to 5980.....
5979	377	Driving Flange Latch.....
136F	379	" " " Hinge Screw.....
5980	377	" " " Spring.....
330J	379	" " " " Screw.....
435c	379	" " " Set Screw.....
5981	—	Loose Wheel Attachment complete, Nos. 5977 and 5993.....
4343	365	Face Plate.....
56796	—	" " 4343 with 2105.....
56775	—	Face Plate complete, Nos. 448c, 460c, 2107, 2111, 2127, 2269, 4369, 56791, 56796 and two 233J.....
164J	312	Face Plate Screw.....
2107	221	" " Thread Guard.....
233J	3384	" " " " Screw.....
3032	259	Feed Cam with 446c.....
446c	312	" " Set Screw.....
3033	259	" Connecting Link.....
375c	312	" " " Hinge Screw....
1518J	312	" " " " " Nut
6112	371	" Dog, 12 teeth, for 6120 and 6449..
6113	366	" " Carrier.....
225c	379	" " Screw.....
3037	364	" Forked Connection.....
375c	312	" " " Hinge Screw....
1518J	312	" " " " " Nut
3039	259	" Regulator.....
58E	312	" " Hinge Screw.....
818D	379	" " Thumb Screw.....
6114	364	" Rock Shaft.....

NO.	PLATE	NAME
6018	366	Feed Rock Shaft Crank with 207F.....
156F	379	" " " " Position Screw..
207F	3381	" " " " Set Screw.....
4264	301	Needle Bar.....
*3045	301	" " Connecting Link.....
56773	—	" " " " 3045 with 2052.....
377c	312	Needle Bar Connecting Link Hinge Screw.....
1518J	312	Needle Bar Connecting Link Hinge Screw Nut.....
2052	374	Needle Bar Connecting Stud with 155c..
155c	3384	" " " " Set Screw..
290E	3385	" " Screw Bushing.....
7524	3383	" Clamp with 196c, 651J and 7525.
196F	3383	" " Screw.....
7525	3383	" " Thread Guide.....
651J	3383	" " " " Screw.....
*6022	367	Oscillating Rock Shaft with 4784.....
16806	—	Oscillating Rock Shaft complete, Nos. 6022 and 56812.....
3052	367	Oscillating Rock Shaft Hinge Pin.....
56812	—	" " " " " 3052 with 1513J.....
1513J	379	Oscillating Rock Shaft Hinge Pin Nut...
4784	3383	" " " " Oil Pad.....
6023	364	" Shaft.....
*6056	—	" " Crank with 460c and 1813.....
6024	377	Oscillating Shaft Crank with 1813 and two 462c.....
2049	221	Oscillating Shaft Crank Pin.....
1813	221	" " " " Roller and Stud
460c	3379	" " " " Set Screw for 6056.....
462c	3385	Oscillating Shaft Crank Set Screw for 6024.....
3054	301	Presser Bar.....
52016	20879	" " Lifter.....
689c	312	" " " " Screw.....
1520E	379	" " " " Nut.....
5608	259	" " Lifting Bracket with 453c...
453c	3385	" " " " Set Screw...
290E	3385	" " Screw Bushing.....
3056	301	" " Spring (heavy).....
2308	301	" " " (light).....
2070	221	" " " Washer.....

NO.	PLATE	NAME
6117	374	Presser Foot.....
190J	3384	" " " " Screw.....
262J	312	Pressure Regulating Thumb Screw.....
2073	217	Shuttle Bobbin.....
2211	217	" " Retaining Spring.....
2212	217	" " " " Rivet...
*6058	—	" " Body with 398E, 2082, 2084, 2211 and two 2212.....
*15458	—	Shuttle Cover.....
125017	—	" " 15458 with 112E, 466H, 2078, 2080, 2086 and 2090.....
2076	217	Shuttle Cover Hinge Pin.....
2078	217	" Delivery Eye Thread Guard....
2080	217	" " " " Rivet
2082	217	" Main Spring.....
398E	217	" " " " Screw.....
2084	217	" " " " Steady Pin.....
466H	217	" Tension Regulating Screw.....
2086	217	" " Spring.....
2090	217	" " " " Plate.....
112E	217	" " " " Screw.....
16892	20880	Shuttle (high point) complete, Nos. 2073, 2076, 6058 and 125017.....
6029	367	Shuttle Driver and Feed Lifting Cam...
2049	221	" " " " " Pin
16769	—	" Race Ring.....
6118	367	" " " 16769 with 6119 and two 241J.....
16771	—	Shuttle Race Ring Cover.....
16772	382	" " " " 16771 with 16242 and two 240J.....
16242	20880	Shuttle Race Ring Cover Latch.....
240J	385	" " " " " Screw..
50250J	3388	" " " " " Screw.....
175J	3384	" " " " " Screw.....
6119	375	" " " " Thread Protector....
241J	3384	" " " " " " Screw
2102	377	Tension Disc.....
1560c	379	" Regulating Thumb Nut.....
4369	377	" Releaser.....
2269	377	" " Hinge Pin.....
600c	379	" Screw Stud.....
16202	—	" " " 600c with 1560c....
448c	379	" " " " Set Screw.....
2103	377	" Spring.....
2105	377	" Thread Guard.....

NO.	PLATE	NAME
56791	—	Tension complete, Nos. 2103, 2124, 16202 and two 2102.....
2112	221	Thread Retaining Disc with 2113.....
2113	221	" " " Steady Pin.....
2114	221	" " " Spring.....
2115	221	" " " Stud.....
460c	3379	" " " Set Screw.....
2111	221	Thread Retainer Guide complete, Nos. 2112, 2114 and 2115.....
*56831	—	Thread Take-up Cam.....
3280	382	" " " 56831 with 446c...
3012	297	" " " Pin.....
446c	312	" " " Set Screw.....
*3072	259	" " " Lever with 1819.....
56855	—	" " " 3072 with 1088c
1088c	3388	" " " Hinge Screw.....
1819	379	" " " Roller and Stud
2124	221	" " " Spring.....
2127	221	" " " Regulator Plate
233j	3384	" " " " " "
		Adjusting Screw.....
6120	371	Throat Plate, large needle hole, for 6112.
6449	—	" " " small needle hole, for 6112.
223D	312	" " " Screw.....
6053	330	Drip Pan.....
*15404	—	Trade Mark.....
15405	20883	" " " Rivet.....

SINGER Needles should be used
in SINGER Machines.
These Needles and their Containers
are marked with the
Company's Trade-Mark "SIMANCO.***" 1

Needles in Containers marked
"FOR SINGER MACHINES"
are NOT **SINGER** made needles. 2

LIST OF PARTS COMPLETE

FOR

MACHINE No. 17-6

DROP FEED UP THE ARM. FOR STITCHING
TUBULAR OR CYLINDRICAL ARTICLES
IN CLOTH OR LEATHER.

NO.	PLATE	NAME
*6001	—	Arm with 4448, 4449, 15404 and two 15405.....
4389	3383	Arm Dowel Pin.....
4448	3383	" Oil Tube for intermediate bearing..
123E	312	" Screw.....
4368	364	" Shaft.....
3005	259	" " Bushing (back).....
448c	379	" " " " Set Screw...
*4449	—	" " " " (front).....
144D	3384	" " Screw.....
4288	368	" Side Cover.....
286D	3385	" " " Thumb Screw.....
12403	377	" Spool Pin and Thread Eyelet.....
11241	382	" " " Washer (cloth).....
4370	364	Balance Wheel, heavy rim, 2 $\frac{3}{4}$ in. pulley, with two 448c.....
2862	364	Balance Wheel, heavy rim, 3 in. pulley, for 3022.....
448c	379	Balance Wheel Set Screw.....
2139	366	" " Speed Pulley, 1 $\frac{1}{8}$ in. diam., with 451c.....
2140	366	Balance Wheel Speed Pulley, 2 $\frac{1}{8}$ in. diam., with 437c.....
451c	3385	Balance Wheel Speed Pulley Set Screw for 2139.....
437c	3385	Balance Wheel Speed Pulley Set Screw for 2140.....
250j	259	Clamp Stop Motion Clamp Screw.....
248A	3385	" " " " Stop Screw..
2020	259	" " " " Washer....
*3023	—	" " " Flanged Bushing...
4933	259	" " " " " 3023 with two 462c.....
2022	221	Clamp Stop Motion Flanged Bushing Pin.....
462c	3385	Clamp Stop Motion Flanged Bushing Set Screw.....

NO.	PLATE	NAME
3022	---	Clamp Stop Motion complete, Nos. 248A, 256J, 2020 and 4933.....
6127	365	Cloth Plate for 6163, 6164, 6173 and 6174
6115	365	" " " 6123 and 6124.....
401D	3385	" " Screw.....
4292	364	Crank Connecting Rod.....
145E	3384	" " " Cap Screw.....
375c	312	" " " Hinge Screw.....
1518J	312	" " " " " Nut
*6126	---	Cylinder, 2¼ in. diam.....
4343	365	Face Plate.....
56796	---	" " 4343 with 2105.....
56775	---	Face Plate complete, Nos. 448c, 460c, 2107, 2111, 2127, 2269, 4369, 56791, 56796 and two 233J.....
164J	312	Face Plate Screw.....
2107	221	" " Thread Guard.....
233J	3384	" " " " Screw.....
3032	259	Feed Cam with 446c.....
446c	312	" " Set Screw.....
3033	259	" Connecting Link.....
375c	312	" " " Hinge Screw.....
1518J	312	" " " " " Nut..
6156	373	" Dog, 13 teeth (16 teeth to the inch) for cloth, for 6163 and 6173.....

NOTE: No. 6156 is sent with this machine unless another Feed Dog is specified on order.

6121	376	Feed Dog, 15 teeth, (16 teeth to the inch) horse shoe, for cloth, for 6123 and 6124
6157	373	Feed Dog, 12 teeth (16 teeth to the inch) for leather, for 6164 and 6174.....
185H	379	Feed Dog Screw.....
6158	370	" Forked Connection.....
375c	312	" " " Hinge Screw...
1518J	312	" " " " " Nut
6132	374	" " " Universal Joint
212E	379	" " " " " Cap Screw.....
23c	379	Feed Forked Connection Universal Joint Hinge Screw.....
3039	259	Feed Regulator.....
58E	312	" " Hinge Screw.....
818D	379	" " Thumb Screw.....
6137	370	" Rock Shaft.....
16767	382	" " " Arm with 453c.....
6166	377	" " " " Pin.....

NO.	PLATE	NAME
453c	3385	Feed Rock Shaft Arm Set Screw.....
300c	3384	" " " Screw Center.....
1513J	379	" " " " " Nut.....
6161	364	" Rod.....
657F	3384	" " Hinge Screw.....
16884	3389	" " Lifting Block.....
207F	3384	" " " " Screw.....
16639	385	" " Spring.....
233J	3384	" " " Screw.....
4264	301	Needle Bar.....
*3045	301	" " Connecting Link.....
56773	---	" " " " 3045 with 2052.....
377c	312	Needle Bar Connecting Link Hinge Screw.....
1518J	312	Needle Bar Connecting Link Hinge Screw Nut.....
2052	374	Needle Bar Connecting Stud with 155c..
155c	3384	" " " " Set Screw..
290E	3385	" " Screw Bushing.....
7524	3383	" Clamp with 196F, 651J and 7525.
196F	3383	" " Screw.....
7525	3383	" " Thread Guide.....
651J	3383	" " " " Screw.....
*6022	367	Oscillating Rock Shaft with 4784.....
16806	---	Oscillating Rock Shaft complete, Nos. 6022 and 56812.....
3052	367	Oscillating Rock Shaft Hinge Pin.....
56812	---	" " " " " 3052 with 1513J.....
1513J	379	Oscillating Rock Shaft Hinge Pin Nut...
4784	3383	" " " Oil Pad.....
6023	364	" Shaft.....
*6056	---	" " Crank with 460c and 1813.....
6024	377	Oscillating Shaft Crank with 1813 and two 462c.....
2049	221	Oscillating Shaft Crank Pin.....
1813	221	" " " Roller and Stud
460c	3379	" " " " Set Screw for 6056.....
462c	3385	Oscillating Shaft Crank Set Screw for 6024.....
3054	301	Presser Bar.....
52016	20879	" " Lifter.....
689c	312	" " " Screw.....
1520E	379	" " " " Nut.....

NO.	PLATE	NAME
5608	259	Presser Bar Lifting Bracket with 453c...
453c	3385	" " " " Set Screw...
290E	3385	" " Screw Bushing.....
3056	301	" " Spring (heavy).....
2308	301	" " " (light).....
2070	221	" " " Washer.....
6139	374	" Foot (long shank) for 6156 and 6157.....
6140	374	Presser Foot (short shank) for 6156 and 6157.....
6122	376	Presser Foot (long shank) for 6121.....
190J	3384	" " Screw.....
262J	312	Pressure Regulating Thumb Screw.....
1868	231	Roller, $\frac{3}{8}$ in. diam., coarse, with 652D and 1528J, for 6141.....
1841	—	Roller, $\frac{3}{8}$ in. diam., fine, with 652D and 1528J, for 6142.....
1839	231	Roller, $1\frac{1}{4}$ in. diam., coarse, with 386D and 1528J, for 6143.....
1869	—	Roller, $1\frac{1}{4}$ in. diam., fine, with 386D and 1528J, for 6144.....
6145	378	Roller Arm for 6141 and 6142.....
6146	378	" " " 6143 and 6144.....
440F	231	" " Adjusting Screw.....
1547J	231	" " " " Nut.....
2206	231	" " Bracket for 6141 and 6142...
4282	3371	" " " " 6143 and 6144...
316F	231	" " " " Screw Center.....
15444	—	" " " " " 3 1 6 F with 1547J.....
1547J	231	Roller Arm Bracket Screw Center Nut..
2205	231	" " Lock Spring.....
176J	231	" " " " Screw.....
1549J	231	" " " " " Nut.....
6141	378	Roller Presser complete, $\frac{3}{8}$ in. coarse roller, Nos. 176J, 440F, 1547J, 1549J, 1868, 2205, 2206, 6145 and two 15444
6142	—	Roller Presser complete, $\frac{3}{8}$ in. fine roller, Nos. 176J, 440F, 1547J, 1549J, 1841, 2205, 2206, 6145 and two 15444.....
NOTE: No. 6142 is sent with this machine unless another Roller Presser is specified on order.		
6143	378	Roller Presser complete, $1\frac{1}{4}$ in. coarse roller, Nos. 176J, 440F, 1547J, 1549J, 1839, 2205, 4282, 6146 and two 15444

NO.	PLATE	NAME
6144	—	Roller Presser complete, $1\frac{1}{4}$ in. fine roller, Nos. 176J, 440F, 1547J, 1549J, 1869, 2205, 4282, 6146 and two 15444
190J	3384	Roller Presser Screw.....
652D	3385	" Screw for 1841 and 1868.....
386D	3385	" " " 1839 and 1869.....
1528J	3386	" " Nut.....
2073	217	Shuttle Bolbin.....
2211	217	" " Retaining Spring.....
2212	217	" " " " Rivet..
*6058	—	" Body with 39SE, 2082, 2084, 2211 and two 2212.....
*15458	—	Shuttle Cover.....
125017	—	" " 15458 with 112E, 466H, 2078, 2080, 2086 and 2090.....
2076	217	Shuttle Cover Hinge Pin.....
2078	217	" Delivery Eye Thread Guard....
2080	217	" " " " " Rivet
2082	217	" Main Spring.....
398E	217	" " " Screw.....
2084	217	" " " Steady Pin.....
466H	217	" Tension Regulating Screw.....
2086	217	" " Spring.....
2090	217	" " " Plate.....
112E	217	" " " " Screw.....
16892	20880	Shuttle (high point) complete, Nos. 2073, 2076, 6058 and 125017.....
6147	370	Shuttle Driver and Feed Lifting Cam...
2049	221	" " " " " " Pin
6168	—	" Race Ring.....
6148	366	" " " 6168 with 6153 and two 590E.....
6149	—	Shuttle Race Ring complete, Nos. 6148 and 6150.....
6150	366	Shuttle Race Ring Cover with 6151 and two 8505.....
6151	375	Shuttle Race Ring Cover Hinge.....
8505	3383	" " " " " Rivet...
7177	377	" " " " " Spring.....
330J	379	" " " " " Screw..
198J	312	" " " " " Screw.....
6153	375	" " " " " Thread Protector....
590E	379	" " " " " Screw
2102	377	Tension Disc.....
1560c	379	" Regulating Thumb Nut.....
4369	377	" Releaser.....
2269	377	" " " Hinge Pin.....

NO.	PLATE	NAME
600c	379	Tension Screw Stud.....
16202	—	“ “ “ 600c with 1560c....
448c	379	“ “ “ Set Screw.....
2103	377	“ Spring.....
2105	377	“ Thread Guard.....
56791	—	Tension complete, Nos. 2103, 2124, 16202 and two 2102.....
2112	221	Thread Retaining Disc with 2113.....
2113	221	“ “ “ Steady Pin.....
2114	221	“ “ Spring.....
2115	221	“ “ Stud.....
460c	3379	“ “ “ Set Screw.....
2111	221	Thread Retainer Guide complete, Nos. 2112, 2114 and 2115.....
*56831	—	Thread Take-up Cam.....
3280	382	“ “ “ 56831 with 446c..
3012	297	“ “ “ Pin.....
446c	312	“ “ “ Set Screw.....
*3072	259	“ “ Lever with 1819.....
56855	—	“ “ “ 3072 with 1088c.
1088c	3388	“ “ “ Hinge Screw.....
1819	379	“ “ “ Roller and Stud
2124	221	“ “ Spring.....
2127	221	“ “ “ Regulator Plate
233J	3384	“ “ “ “ “
		Adjusting Screw.....
6173	—	Throat Plate, large needle hole, for 6156
6163	373	“ “ small needle hole, for 6156
6123	376	“ “ large needle hole, for 6121
6124	—	“ “ small needle hole, for 6121
6174	—	“ “ large needle hole, for 6157
6164	373	“ “ small needle hole, for 6157
401D	3385	“ “ Screw.....
6053	380	Drip Pan.....
*15404	—	Trade Mark.....
15405	20883	“ “ Rivet.....

LIST OF PARTS COMPLETE

FOR

MACHINE No. 17-7

FOR CLOTH OR LEATHER. TWO NEEDLES, TWO
SHUTTLES, GAUGES $\frac{1}{2}$ INCH TO $\frac{3}{4}$ INCH
DROP FEED ACROSS ARM

NO.	PLATE	NAME
*6001	—	Arm with 4448, 4449, 15404 and two 15405.....
4389	3383	Arm Dowel Pin.....
4448	3383	“ Oil Tube for intermediate bearing..
123E	312	“ Screw.....
4368	364	“ Shaft.....
3005	259	“ “ Bushing (back).....
448c	379	“ “ “ “ Set Screw....
*4449	—	“ “ “ (front).....
144D	3384	“ “ Screw.....
4288	368	“ Side Cover.....
286D	3385	“ “ “ Thumb Screw.....
2415	366	“ Spool Bracket.....
15063	366	“ “ “ 2415 with two 12403
145J	3384	“ “ “ Screw.....
12403	377	“ “ “ Spool Pin and Thread Eyelet.....
11241	382	Arm Spool Bracket Spool Pin Washer (cloth).....
4370	364	Balance Wheel, heavy rim, $2\frac{3}{4}$ in. pulley, with two 448c.....
2862	364	Balance Wheel, heavy rim, 3 in. pulley, for 3022.....
448c	379	Balance Wheel Set Screw.....
2139	366	“ “ Speed Pulley, $1\frac{1}{8}$ in. diam., with 451c.....
2140	366	Balance Wheel Speed Pulley, $2\frac{1}{8}$ in. diam., with 437c.....
451c	3385	Balance Wheel Speed Pulley Set Screw for 2139.....
437c	3385	Balance Wheel Speed Pulley Set Screw for 2140.....
256J	259	Clamp Stop Motion Clamp Screw.....
248A	3385	“ “ “ “ Stop Screw..
2020	259	“ “ “ “ Washer.....
*3023	—	“ “ “ Flanged Bushing... “ “ “ “ “ 3023
4933	259	with two 462c.....

NO.	PLATE	NAME
2022	221	Clamp Stop Motion Flanged Bushing Pin.....
462c	3385	Clamp Stop Motion Flanged Bushing Set Screw.....
3022	—	Clamp Stop Motion complete, Nos. 248A, 256J, 2020 and 4933.....
4202	364	Crank Connecting Rod.....
145E	3384	" " " " Cap Screw.....
375c	312	" " " " Hinge Screw.....
1518J	312	" " " " " " " Nut
*6181	—	Cylinder, 2 $\frac{7}{8}$ in. diam.....
4376	3364	Face Plate with Tension Bracket (solid).
56797	—	" " 4376 with 2105.....
4856	—	Face Plate complete, Nos. 86D, 330J, 448c, 808F, 809c, 2107, 2127, 2248, 2410, 2411, 4377, 56797, two each 233J, 1500c, 2103 and four 2102.....
164J	312	Face Plate Screw.....
2107	221	" " Thread Guard.....
233J	3384	" " " " Screw.....
3032	259	Feed Cam with 446c.....
446c	312	" " Set Screw.....
3033	259	" Connecting Link.....
375c	312	" " " " Hinge Screw.....
1518J	312	" " " " " " " Nut
6182	376	" Dog, 12 teeth (one row of teeth) for $\frac{1}{2}$ in. to $\frac{3}{4}$ in. gauges, for leather, for 65035.....
6183	3353	Feed Dog, 12 teeth (two rows of teeth) for $\frac{3}{8}$ in. to $\frac{1}{2}$ in. gauges, for general work, for 6248.....
6184	3353	Feed Dog, 12 teeth (three rows of teeth) for $\frac{2}{5}$ in. to $\frac{1}{2}$ in. gauges, for general work, for 6254.....
16762	3353	Feed Dog, 12 teeth (four rows of teeth) for $\frac{1}{2}$ in. to $\frac{5}{8}$ in. gauges for general work, for 16763.....
16764	3354	Feed Dog, 12 teeth (five rows of teeth) for $\frac{3}{4}$ in. to $\frac{3}{4}$ in. gauges, for general work, for 16765.....
6016	366	Feed Dog Carrier.....
225c	379	" " Screw.....
3037	364	" Forked Connection.....
375c	312	" " " " Hinge Screw.....
1518J	312	" " " " " " " Nut
3039	259	" Regulator.....
58E	312	" " Hinge Screw.....

NO.	PLATE	NAME
818D	379	Feed Regulator Thumb Screw.....
6017	364	" Rock Shaft.....
6018	366	" " " " Crank with 207F.....
156F	379	" " " " " Position Screw..
207F	3384	" " " " " Set Screw.....
4344	3365	Needle Bar.....
*3045	301	" " Connecting Link.....
56773	—	" " " " " 3045 with 2052.....
377c	312	Needle Bar Connecting Link Hinge Screw.....
1518J	312	Needle Bar Connecting Link Hinge Screw Nut.....
2052	374	Needle Bar Connecting Stud with 155c..
155c	3384	" " " " " Set Screw..
3214	374	" " Guide with 400c and 453c...
400c	312	" " " " Adjusting Screw.....
453c	3385	" " " " Set Screw.....
290E	3385	" " Screw Bushing.....
4783	377	" Clamp with two 336F, for $\frac{1}{2}$ in. to $\frac{5}{8}$ in. gauges.....
4496	377	Needle Clamp with two 460c, for $\frac{1}{2}$ in. gauge and above.....
2273	3383	Needle Clamp Pin.....
336F	3384	" Set Screw for 4783.....
460c	3379	" " " " 4496.....
*6022	367	Oscillating Rock Shaft with 4784.....
16806	—	Oscillating Rock Shaft complete, Nos. 6022 and 56812.....
3052	367	Oscillating Rock Shaft Hinge Pin.....
56812	—	" " " " " 3052 with 1513r.....
1513r	379	Oscillating Rock Shaft Hinge Pin Nut...
4784	3383	" " " " Oil Pad.....
7044	3366	" Shaft.....
*6520	—	" " Crank with 1813.....
6532	377	" " " " 6520 with two 462c.....
2049	221	Oscillating Shaft Crank Pin.....
1813	221	" " " " Roller and Stud.
462c	3385	" " " " Set Screw.....
7299	3365	Presser Bar.....
52016	20879	" " Lifter.....
689c	312	" " " " Screw.....
1520E	379	" " " " Nut.....
5611	382	" " Lifting Bracket with 453c and 5613.....

NO.	PLATE	NAME
453C	3385	Presser Bar Lifting Bracket Set Screw...
290E	3385	" " Screw Bushing.....
3056	301	" " Spring (heavy).....
2308	301	" " " (light).....
2070	221	" " " Washer.....
3364	302	" Foot (long shank) $\frac{3}{8}$ in. gauge and above.....
3765	302	Presser Foot (long shank) $\frac{3}{8}$ in. gauge and above, for outside stays and strips.....
3374	302	Presser Foot (long shank) $\frac{1}{8}$ in. gauge and above, for inside stays (shoes)....
190J	3384	Presser Foot Screw.....
262J	312	Pressure Regulating Thumb Screw.....
1854	3372	Roller, $1\frac{1}{2}$ in. diam., with 634D and 1528J.....
3222	3372	Roller Arm.....
440F	231	" " Adjusting Screw.....
1547J	231	" " " " Nut.....
4785	3372	" " Bracket.....
316F	231	" " " Screw Center.....
15444	—	" " " " " 316F with 1547J.....
1547J	231	Roller Arm Bracket Screw Center Nut..
7556	3372	" " Lock Spring.....
176J	231	" " " " Screw.....
1549J	231	" " " " " Nut.....
4786	3372	" Needle Guard (flat).....
207F	3384	" " " " Screw.....
4789	3372	" " " (round).....
171F	312	" " " " Screw.....
4790	3372	Roller Presser complete, $1\frac{1}{2}$ in. roller, Nos. 171F, 176J, 207F, 440F, 1547J, 1549J, 1854, 3222, 4785, 4786, 4789, 7556 and two 15444.....
190J	3384	Roller Presser Screw.....
634D	3385	" Screw.....
1528J	3386	" " Nut.....
2210	217	Shuttle (inside) Bobbin.....
3230	302	" " " Retaining Spring
2212	217	" " " " " Rivet.....
*3231	—	Shuttle (inside) Body with 398E, 2084 and 3239, for 3225.....
*3232	—	Shuttle (inside) Body with 398E, 2084, 3230, 3239 and two 2212, for 3226.....
*3382	—	Shuttle (inside) Body with 398E, 2084 and 3239, for 3380.....

NO.	PLATE	NAME
*3383	—	Shuttle (inside) Body with 398E, 2084, 3230, 3239 and two 2212, for 3381.....
*3236	—	Shuttle (inside) Cover.....
56755	—	" " " 3236 with 112E, 466H, 2080, 3238, 3241 and 3242.....
2076	217	Shuttle (inside) Cover Hinge Pin.....
3238	302	" " Delivery Eye Thread Guard.....
2080	217	Shuttle (inside) Delivery Eye Thread Guard Rivet.....
3239	302	Shuttle (inside) Main Spring.....
398E	217	" " " " Screw.....
2084	217	" " " " Steady Pin
466H	217	" " Tension Regulating Screw.....
3241	302	Shuttle (inside) Tension Spring.....
3242	302	" " " " Plate.....
112E	217	" " " " " Screw
3225	3376	Shuttle (inside) complete, for $\frac{1}{2}$ in. to $\frac{5}{8}$ in. and $\frac{1}{4}$ in. to $\frac{3}{4}$ in. gauges, Nos. 2076, 2210, 3231 and 56755.....
3226	3376	Shuttle (inside) complete, for $\frac{1}{2}$ in. to $\frac{5}{8}$ in. and $\frac{1}{4}$ in. to $\frac{3}{4}$ in. gauges, Nos. 2076, 2210, 3232 and 56755.....
3380	6235	Shuttle (inside) complete, for $\frac{3}{8}$ in. to $\frac{1}{2}$ in. and $\frac{5}{16}$ in. gauges and above, Nos. 2076, 2210, 3382 and 56755.....
3381	6235	Shuttle (inside) complete, for $\frac{3}{8}$ in. to $\frac{1}{2}$ in. and $\frac{5}{16}$ in. gauges and above, Nos. 2076, 2210, 3383 and 56755.....
2210	217	Shuttle (outside) Bobbin.....
3230	302	" " " Retaining Spring
2212	217	" " " " " Rivet.....
*3233	—	Shuttle (outside) Body with 398E, 2084 and 3240, for 3227.....
*4649	—	Shuttle (outside) Body with 398E, 2084, 3230, 3240 and two 2212, for 4648.....
*3234	—	Shuttle (outside) Body with 398E, 2084 and 3240, for 3228.....
*3235	—	Shuttle (outside) Body with 398E, 2084, 3230, 3240 and two 2212, for 3229.....
*3522	—	Shuttle (outside) Body with 398E, 2084 and 3240, for 3519.....
*4798	—	Shuttle (outside) Body with 398E, 2084, 3230, 3240 and two 2212, for 4729.....

NO.	PLATE	NAME
*3523	—	Shuttle (outside) Body with 398E, 2084 and 3240, for 3520.....
*3524	—	Shuttle (outside) Body with 398E, 2084, 3230, 3240 and two 2212, for 3521....
*3237	—	Shuttle (outside) Cover for 56754.....
56754	—	" " " 3237 with 112E, 466H, 2078, 2080, 2086 and 2090, for 3228, 3229, 3520 and 3521.....
*4582	—	Shuttle (outside) Cover for 56753.....
56753	—	" " " 4582 with 112E, 466H, 2078, 2080, 2086 and 2090, for 3227, 3519, 4648 and 4729.....
2076	217	Shuttle (outside) Cover Hinge Pin.....
2078	217	" " Delivery Eye Thread Guard.....
2080	217	Shuttle (outside) Delivery Eye Thread Guard Rivet.....
3240	302	Shuttle (outside) Main Spring.....
398E	217	" " " " Screw....
2084	217	" " " " S t e a d y Pin.....
466H	217	Shuttle (outside) Tension Regulating Screw.....
2086	217	Shuttle (outside) Tension Spring.....
2090	217	" " " " P l a t e
112E	217	" " " " "
		Screw.....
3227	6234	Shuttle (outside) complete, for $\frac{1}{2}$ in. and $\frac{3}{4}$ in. gauges, Nos. 2076, 2210, 3233 and 56753.....
4648	6234	Shuttle (outside) complete, for $\frac{1}{2}$ in. and $\frac{3}{4}$ in. gauges, Nos. 2076, 2210, 4649 and 56753.....
3228	3376	Shuttle (outside) complete, for $\frac{1}{4}$ in. to $\frac{1}{2}$ in. gauges, Nos. 2076, 2210, 3234 and 56754.....
3229	3376	Shuttle (outside) complete, for $\frac{1}{8}$ in. to $\frac{1}{4}$ in. gauges, Nos. 2076, 2210, 3235 and 56754.....
3519	6235	Shuttle (outside) complete, for $\frac{1}{4}$ in. gauge only, Nos. 2076, 2210, 3522 and 56753.....
4729	3376	Shuttle (outside) complete, for $\frac{1}{4}$ in. gauge only, Nos. 2076, 2210, 4798 and 56753.....

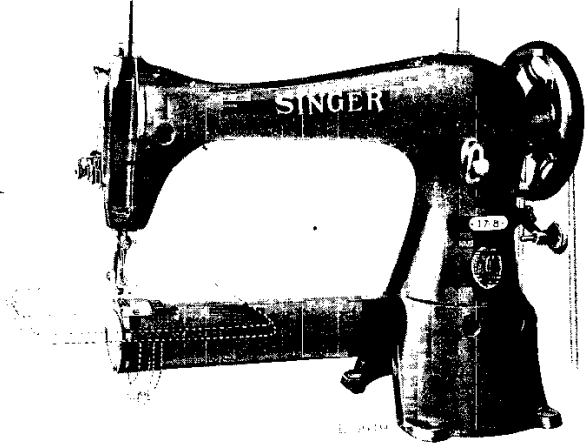
NO.	PLATE	NAME
3520	6235	Shuttle (outside) complete for $\frac{1}{4}$ in. gauge and above, Nos. 2076, 2210, 3523 and 56754.....
3521	6235	Shuttle (outside) complete, for $\frac{1}{4}$ in. gauge and above, Nos. 2076, 2210, 3524 and 56754.....
65024	3389	Shuttle Driver and Feed Lifting Cam...
2049	221	" " " " " " Pin
16742	—	" Race Body (two pieces) with 629D
2049	221	" " Dowel Pin.....
629D	379	" " Hinge Screw.....
6223	376	" " Lock Pin.....
400F	312	" " " " Screw.....
6224	376	" " " " Spring.....
6225	374	" " Loop Separator, for $\frac{1}{2}$ in. to $\frac{3}{4}$ in. gauges, for 6206.....
6235	374	Shuttle Race Loop Separator, for $\frac{1}{2}$ in. to $\frac{3}{4}$ in. gauges, for 6213.....
665J	3384	Shuttle Race Loop Separator Screw.....
6206	370	Shuttle Race complete, for $\frac{1}{2}$ in. to $\frac{3}{4}$ in. gauges, Nos. 665J, 6225 and 16742..
6213	—	Shuttle Race complete, for $\frac{1}{2}$ in. to $\frac{3}{4}$ in. gauges, Nos. 665J, 6235 and 16742....
738J	379	Shuttle Race Screw, for $\frac{1}{2}$ in. to $\frac{3}{4}$ in. gauges.....
50170J	3384	Shuttle Race Screw, for $\frac{1}{2}$ in. to $\frac{3}{4}$ in. gauges.....
6297	368	Shuttle Race Cover.....
50250J	3388	" " " " Screw.....
2102	377	Tension Disc.....
1560c	379	" Regulating Thumb Nut.....
3267	369	" Releaser.....
5613	3383	" " Pin.....
809c	379	" Stud (double).....
808F	379	" " Set Screw.....
2103	377	" Spring.....
4377	3383	" Thread Eyelet (double).....
330J	379	" " " " Screw.....
2410	221	Thread Guiding Roller.....
86D	3385	" " " " Screw.....
2411	221	" " " " Stud.....
448c	379	" " " " Set Screw..
2105	377	" " " " Thread Guard...
*56831	—	" Take-up Cam.....
3280	382	" " " " 56831 with 446c..
3012	297	" " " " Pin.....
446c	312	" " " " Set Screw.....

NO.	PLATE	NAME
3281	259	Thread Take-up Lever with 1819.....
56869	—	“ “ “ 3281 with 1088c...
1088c	3388	“ “ “ Hinge Screw.....
1819	379	“ “ “ Roller and Stud...
2248	221	“ “ “ Spring with closed eyelet
2127	221	“ “ “ Regulator Plate
233j	3384	“ “ “ “ “
		Adjusting Screw.....
65035	3389	Throat Plate for 6182.....
6248	3353	“ “ “ 6183.....
6254	3353	“ “ “ 6184.....
16763	3353	“ “ “ 16762.....
16765	3354	“ “ “ 16764.....
401d	3385	“ “ “ Screw.....
6053	380	Drip Pan.....
*15404	—	Trade Mark.....
15405	20883	“ “ “ Rivet.....

SINGER Needles should be used in SINGER Machines. These Needles and their Containers are marked with the Company's Trade-Mark "SIMANCO. 4**" 1

Needles in Containers marked "FOR SINGER MACHINES" are NOT **SINGER** made needles. 2

LIST OF PARTS COMPLETE FOR



MACHINE No. 17-8

FOR CLOTH OR LEATHER. DROP FEED ACROSS ARM, ALTERNATING PRESSERS

NO.	PLATE	NAME
*6271	—	Arm with 4448, 4449, 15404 and two 15405.....
4389	3383	Arm Dowel Pin.....
4448	3383	“ Oil Tube for intermediate bearing..
123E	312	“ Screw.....
4359	3364	“ Shaft.....
3005	259	“ “ Bushing (back).....
448c	379	“ “ “ “ Set Screw....
*4449	—	“ “ “ “ (front).....
144d	3384	“ “ “ Screw.....
4288	368	“ Side Cover.....
286d	3385	“ “ “ Thumb Screw.....
12403	377	“ Spool Pin and Thread Eyelet.....
11241	382	“ “ “ Washer (cloth).....

46 PARTS FOR MACHINE No. 17-8

NO.	PLATE	NAME
4370	364	Balance Wheel, heavy rim, 2¾ in. pulley, with two 448c.....
2862	364	Balance Wheel, heavy rim, 3 in. pulley, for 3022.....
448c	379	Balance Wheel Set Screw.....
2139	366	Balance Wheel Speed Pulley, 1¼ in. diam., with 451c.....
2140	366	Balance Wheel Speed Pulley, 2⅛ in. diam., with 437c.....
451c	3385	Balance Wheel Speed Pulley Set Screw for 2139.....
437c	3385	Balance Wheel Speed Pulley Set Screw for 2140.....
256j	259	Clamp Stop Motion Clamp Screw.....
248A	3385	" " " " Stop Screw..
2020	259	" " " " Washer.....
*3023	—	" " " " Flanged Bushing...
4933	259	" " " " " " 3023 with two 462c.....
2022	221	Clamp Stop Motion Flanged Bushing Pin.....
462c	3385	Clamp Stop Motion Flanged Bushing Set Screw.....
3022	—	Clamp Stop Motion complete, Nos. 248A, 256j, 2020 and 4933.....
6054	365	Cloth Plate.....
6008	365	" " Bracket with 345c.....
345c	379	" " " " Set Screw.....
389F	312	" " " " Screw.....
6009	368	" " " " Slide.....
3286	368	" " " " Spring.....
725j	312	" " " " " " Screw.....
6005	365	Cloth Plate complete, Nos. 3286, 6009, 6054 and two 725j.....
6004	—	Cloth Plate with Bracket complete, Nos. 6005, 6008 and two 389F.....
4292	364	Crank Connecting Rod.....
145E	3384	" " " " Cap Screw.....
375c	312	" " " " " " Hinge Screw.....
1518j	312	" " " " " " " " Nut
*16649	—	Cylinder, 2⅞ in. diam.....
56871	20876	Face Plate.....
56872	—	" " 56871 with 2105.....
56873	—	Face Plate complete, Nos. 448c, 460c, 2111, 2127, 2269, 4378, 56791, 56870, 56872 and two 233j.....

PARTS FOR MACHINE No. 17-8 47

NO.	PLATE	NAME
175j	3384	Face Plate Screw.....
56870	20879	" " " " Thread Guard.....
233j	3384	" " " " " " Screw.....
3032	259	Feed Cam with 446c.....
446c	312	" " " " Set Screw.....
3033	259	" " " " Connecting Link.....
375c	312	" " " " " " Hinge Screw.....
1518j	312	" " " " " " " " Nut
65067	20879	" " " " " " " " Dog, 12 teeth (16 teeth to the inch) for 65070.....

NOTE: No. 65067 is sent with this machine unless another Feed Dog is specified on order.

6272	371	Feed Dog, 12 teeth, for 6273 and 16622
6016	366	" " " " Carrier.....
225c	379	" " " " " " Screw.....
16638	382	" " " " Forked Connection.....
375c	312	" " " " " " Hinge Screw...
1518j	312	" " " " " " " " Nut
3039	259	" " " " " " Regulator.....
58E	312	" " " " " " Hinge Screw.....
818D	379	" " " " " " Thumb Screw.....
6017	364	" " " " " " Rock Shaft.....
6019	366	" " " " " " Crank with 207F.....
156F	379	" " " " " " Position Screw..
207F	3384	" " " " " " Set Screw.....
26589	3362	Guide.....
3126	259	" " " " " " Bar.....
*56752	—	" " " " 3126 with 2361 and two 2362.
56844	—	" " " " 56752 with 337j and 3137....
4730	—	Guide Bar complete, Nos. 810D, 810E, 3134, 4723, 4897, 56844 and three 404j
4854	389	Guide Bar Driving Crank with 1862 and 3131.....
1862	297	Guide Bar Driving Crank Roller (roller only).....
3131	297	Guide Bar Driving Crank Roller Cap...
3094	297	" " " " " " Wedge.....
690E	312	" " " " " " " " Screw
4723	389	" " " " " " Lifting Bracket.....
404j	3385	" " " " " " " " Screw.....
284D	3385	" " " " " " Thumb Screw.....
2058	3365	Lifting Presser Bar.....
3133	259	" " " " " " Bracket with 641E and 1823.....
641E	3384	Lifting Presser Bar Bracket Clamping Screw.....

NO.	PLATE	NAME
1823	221	Lifting Presser Bar Bracket Roller and Stud.....
4855	3366	Lifting Presser Bar Lifter.....
598c	3385	" " " " Screw.....
4725	3365	" " " " Lifting Bracket.....
4726	3383	" " " " " Guide Pin.....
3100	301	Lifting Presser Bar Spring.....
2070	221	" " " " Washer.....
2358	259	" " Foot.....
193j	20883	" " " " Screw.....
4264	301	Needle Bar.....
*4898	3367	" " Connecting Link with 390e..
56764	—	" " " " 4898 with 15472.....
390E	3385	Needle Bar Connecting Link Adjusting Screw.....
15472	3389	Needle Bar Connecting Stud with 155c..
155c	3384	" " " " Set Screw..
4265	302	" Clamp with 196f.....
4865	3383	Needle Clamp complete, Nos. 651j, 4265 and 4266.....
196f	3383	Needle Clamp Screw.....
4266	302	" " Thread Guide.....
651j	3383	" " " " Screw.....
*6022	367	Oscillating Rock Shaft with 4784.....
16806	—	Oscillating Rock Shaft complete, Nos. 6022 and 56812.....
3052	367	Oscillating Rock Shaft Hinge Pin.....
56812	—	" " " " " 3052 with 1513j.....
1513j	379	Oscillating Rock Shaft Hinge Pin Nut..
4784	3383	" " " " Oil Pad.....
6023	364	" Shaft.....
*6056	—	" " Crank with 460c and 1813.....
6024	377	Oscillating Shaft Crank with 1813 and two 462c.....
2049	221	Oscillating Shaft Crank Pin.....
1813	221	" " " " Roller and Stud
460c	3379	" " " " Set Screw for 6056.....
462c	3385	Oscillating Shaft Crank Set Screw for 6024.....
262j	312	Pressure Regulating Thumb Screw.....
2073	217	Shuttle Bobbin.....
2211	217	" " Retaining Spring.....

NO.	PLATE	NAME
2212	217	Shuttle Bobbin Retaining Spring Rivet.
*6058	—	" " Body with 398e, 2082, 2084, 2211 and two 2212.....
*15458	—	Shuttle Cover.....
125017	—	" " 15458 with 112e, 466u, 2078, 2080, 2086 and 2090.....
2076	217	Shuttle Cover Hinge Pin.....
2078	217	" Delivery Eye Thread Guard.....
2080	217	" " " " " Rivet
2082	217	" Main Spring.....
398E	217	" " " " Screw.....
2084	217	" " " " Steady Pin.....
466H	217	" Tension Regulating Screw.....
2086	217	" " Spring.....
2090	217	" " " " Plate.....
112E	217	" " " " " Screw.....
16892	20880	Shuttle (high point) complete, Nos. 2073, 2076, 6058 and 125017.....
6029	367	Shuttle Driver and Feed Lifting Cam...
2049	221	" " " " " " Pin
16651	387	" Race.....
16688	—	" " Cover.....
16689	382	" " " " 16688 with 16242 and two 725j.....
16242	20880	Shuttle Race Cover Latch.....
725j	312	" " " " " Screw.....
50250j	3388	" " " " Screw.....
198j	312	" " " " Screw.....
2102	377	Tension Disc.....
1560c	379	" Regulating Thumb Nut.....
4378	3367	" Releaser.....
2269	377	" " Hinge Pin.....
600c	379	" " Screw Stud.....
16202	—	" " " " 600c with 1560c...
448c	379	" " " " Set Screw.....
2103	377	" Spring.....
2105	377	" Thread Guard.....
56791	—	Tension complete, Nos. 2103, 2124, 16202 and two 2102.....
2112	221	Thread Retaining Disc with 2113.....
2113	221	" " " " Steady Pin.....
2114	221	" " " " Spring.....
2115	221	" " " " Stud.....
460c	3379	" " " " Set Screw.....
2111	221	Thread Retainer Guide complete, Nos. 2112, 2114 and 2115.....

NO.	PLATE	NAME
*65068	—	Thread Take-up Cam.....
65069	20877	" " " 65068 with 446c...
3012	297	" " " Pin.....
446c	312	" " " Set Screw.....
*3072	259	" " Lever with 1819.....
56855	—	" " " 3072 with 1088c.
1088c	3388	" " " Hinge Screw.....
1819	379	" " " Roller and Stud..
2124	221	" " Spring.....
2127	221	" " " Regulator Plate
233J	3384	" " " " " "
		Adjusting Screw.....
65070	20879	Throat Plate for 65067.....
16622	—	" " large needle hole, for 6272
6273	371	" " small needle hole, for 6272
401D	3385	" " Screw.....
3134	259	Vibrating Presser Bar.....
2361	259	" " " Hinge Bracket....
2362	221	" " " " Rivet
810D	379	" " " Cap Screw.
4897	3365	" " " Lifting Bell Crank
810E	379	" " " " " "
		Hinge Cap Screw.....
3137	259	Vibrating Presser Bar Spring.....
337J	3385	" " " " Screw.....
3136	259	" " Foot.....
217J	3384	" " " Screw.....
6053	380	Drip Pan.....
*15404	—	Trade Mark.....
15405	20883	" " Rivet.....

SINGER Needles should be used
 in **SINGER** Machines.
 These Needles and their Containers
 are marked with the
 Company's Trade-Mark "**SIMANCO**."** 1

Needles in Containers marked
 "**FOR SINGER MACHINES**"
 are NOT **SINGER** made needles. 2

**LIST OF PARTS COMPLETE
FOR
MACHINE No. 17-9**

**WHEEL FEED, ALTERNATING PRESSERS,
CLOTH OR LEATHER.**

NO.	PLATE	NAME
*6271	—	Arm with 4448, 4449, 15404 and two 15405.....
4389	3383	Arm Dowel Pin.....
4448	3383	" Oil Tube for intermediate bearing..
123E	312	" Screw.....
4359	3364	" Shaft.....
3005	259	" " Bushing (back).....
448c	379	" " " " Set Screw....
*4449	—	" " " (front).....
144D	3384	" " Screw.....
4288	368	" Side Cover.....
286D	3385	" " " Thumb Screw.....
12403	377	" Spool Pin and Thread Eyelet.....
11241	382	" " " Washer (cloth).....
4370	364	Balance Wheel, heavy rim, 2 3/4 in. pulley, with two 448c.....
2862	364	Balance Wheel, heavy rim, 3 in. pulley, for 3022.....
448c	379	Balance Wheel Set Screw.....
2139	366	" " Speed Pulley, 1 1/8 in. diam., with 451c.....
2140	366	Balance Wheel Speed Pulley, 2 3/8 in. diam., with 437c.....
451c	3385	Balance Wheel Speed Pulley Set Screw for 2139.....
437c	3385	Balance Wheel Speed Pulley Set Screw for 2140.....
256J	259	Clamp Stop Motion Clamp Screw.....
248A	3385	" " " " Stop Screw..
2020	259	" " " " Washer....
*3023	—	" " " Flanged Bushing...
4933	259	" " " " " 3023 with two 462c.....
2022	221	Clamp Stop Motion Flanged Bushing Pin.....
462c	3385	Clamp Stop Motion Flanged Bushing Set Screw.....

NO.	PLATE	NAME
3022	—	Clamp Stop Motion complete, Nos. 248A, 256J, 2020 and 4933.....
16768	365	Cloth Plate.....
6083	365	" " Bracket with two 345c.....
345c	379	" " " Set Screw.....
389F	312	" " " Screw.....
6009	368	" " " Slide.....
3286	368	" " " Spring.....
725J	312	" " " " Screw.....
6082	365	Cloth Plate complete, Nos. 3286, 6009, 16768 and two 725J.....
6081	—	Cloth Plate with Bracket complete, Nos. 6082, 6083 and two 389F.....
4292	364	Crank Connecting Rod.....
145E	3384	" " " Cap Screw.....
375c	312	" " " Hinge Screw.....
1518J	312	" " " " " Nut
*6080	—	Cylinder, 2¼ in. diam.....
56871	20876	Face Plate.....
56872	—	" " 56871 with 2105.....
56873	—	Face Plate complete, Nos. 448c, 460c, 2111, 2127, 2269, 4378, 56791, 56870, 56872 and two 233J.....
175J	3384	Face Plate Screw.....
56870	20879	" " Thread Guard.....
233J	3384	" " " " Screw.....
3033	259	Feed Connecting Link.....
375c	312	" " " Hinge Screw.....
1518J	312	" " " " Nut..
3074	259	" Eccentric with 446c.....
446c	312	" " Set Screw.....
3037	364	" Forked Connection.....
375c	312	" " " Hinge Screw...
1518J	312	" " " " " Nut
3039	259	" Regulator.....
58E	312	" " Hinge Screw.....
818D	379	" " Thumb Screw.....
6085	364	" Rock Shaft.....
6018	366	" " " Crank with 207F.....
156F	379	" " " Position Screw..
207F	3384	" " " " Set Screw.....
6086	367	" Wheel.....
6087	366	" " Driver.....
6088	375	" " " Spring.....
207F	3384	" " " " Screw.....
6089	377	" " Friction Spring.....
207F	3384	" " " " Screw.....

NO.	PLATE	NAME
3126	259	Guide Bar.....
*56752	—	" " 3126 with 2361 and two 2362.
56844	—	" " 56752 with 337J and 3137....
4730	—	Guide Bar complete, Nos. 810D, 810E, 3134, 4723, 4897, 56844 and three 404J
4854	389	Guide Bar Driving Crank with 1862 and 3131.....
1862	297	Guide Bar Driving Crank Roller (roller only).....
3131	297	Guide Bar Driving Crank Roller Cap....
3094	297	" " " " Wedge.....
690E	312	" " " " " Screw
4723	389	" " Lifting Bracket.....
404J	3385	" " " " " Screw.....
20583	365	Lifting Presser Bar.....
31333	259	" " " Bracket with 641E and 1823.....
641E	384	Lifting Presser Bar Bracket Clamping Screw.....
1823	221	Lifting Presser Bar Bracket Roller and Stud.....
4855	3366	Lifting Presser Bar Lifter.....
598c	3385	" " " " " Screw.....
4725	3365	" " " Lifting Bracket....
4726	3383	" " " " " Guide Pin.....
3100	301	Lifting Presser Bar Spring.....
2070	221	" " " " Washer.....
2358	259	" " Foot.....
193J	20883	" " " Screw.....
4264	301	Needle Bar.....
*4898	3367	" " Connecting Link with 390E..
56764	—	" " " " 4898 with 15472.....
390E	3385	Needle Bar Connecting Link Adjusting Screw.....
15472	3389	Needle Bar Connecting Stud with 155c..
155c	3384	" " " " " Set Screw..
7524	3383	" Clamp with 196F, 651J and 7525.
196F	3383	" " " Screw.....
7525	3383	" " Thread Guide.....
651J	3383	" " " " " Screw.....
*6022	367	Oscillating Rock Shaft with 4784.....
16806	—	Oscillating Rock Shaft complete, Nos. 6022 and 56812.....
3052	367	Oscillating Rock Shaft Hinge Pin....

NO.	PLATE	NAME
56812	—	Oscillating Rock Shaft Hinge Pin 3052 with 1513j.....
1513j	379	Oscillating Rock Shaft Hinge Pin Nut....
4784	3383	" " " Oil Pad.....
6023	364	" Shaft.....
*6056	—	" " Crank with 460c and 1813.....
6024	377	Oscillating Shaft Crank with 1813 and two 462c.....
2049	221	Oscillating Shaft Crank Pin.....
1813	221	" " Roller and Stud
460c	3379	" " " Set Screw for 6056.....
462c	3385	Oscillating Shaft Crank Set Screw for 6024.....
262j	312	Pressure Regulating Thumb Screw.....
2073	217	Shuttle Bobbin.....
2211	217	" " Retaining Spring.....
2212	217	" " " Rivet..
*6058	—	" Body with 398E, 2082, 2084, 2211 and two 2212.....
*15458	—	Shuttle Cover.....
125017	—	" " 15458 with 112E, 466H, 2078, 2080, 2086 and 2090.....
2076	217	Shuttle Cover Hinge Pin.....
2078	217	" Delivery Eye Thread Guard.....
2080	217	" " " Rivet
2082	217	" Main Spring.....
398E	217	" " " Screw.....
2084	217	" " " Steady Pin.....
466H	217	" Tension Regulating Screw.....
2086	217	" " Spring.....
2090	217	" " " Plate.....
112E	217	" " " Screw....
16892	20880	Shuttle (high point) complete, Nos. 2073, 2076, 6058 and 125017.....
16640	385	Shuttle Driver.....
2049	221	" " Pin.....
6090	367	" Race and Throat Ring.....
198j	312	" " " " " Screw....
2102	377	Tension Disc.....
1560c	379	" Regulating Thumb Nut.....
4378	3367	" Releaser.....
2269	377	" " Hinge Pin.....
600c	379	" Screw Stud.....
16202	—	" " " 600c with 1560c....
448c	379	" " " Set Screw.....

NO.	PLATE	NAME
2103	377	Tension Spring.....
2105	377	" Thread Guard.....
56791	—	Tension complete, Nos. 2103, 2124, 16202 and two 2102.....
2112	221	Thread Retaining Disc with 2113.....
2113	221	" " " Steady Pin.....
2114	221	" " Spring.....
2115	221	" " Stud.....
460c	3379	" " " Set Screw.....
2111	221	Thread Retainer Guide complete, Nos. 2112, 2114 and 2115.....
*56843	—	Thread Take-up Cam.....
3104	370	" " " 56843 with 446c... Pin.....
3012	297	" " " Set Screw.....
446c	312	" " " Set Screw.....
*3072	259	" " Lever with 1819.....
56855	—	" " " 3072 with 1088c.....
1088c	3388	" " " Hinge Screw.....
1819	379	" " " Roller and Stud.
2124	221	" " Spring.....
2127	221	" " " Regulator Plate
233j	3384	" " " " " " Adjusting Screw.....
3134	259	Vibrating Presser Bar.....
2361	259	" " " Hinge Bracket....
2362	221	" " " " Rivet
810D	379	" " " Cap Screw
4897	3365	" " " Lifting Bell Crank
810E	379	" " " " " " " " Hinge Cap Screw.....
3137	259	Vibrating Presser Bar Spring.....
337j	3385	" " " " " " Screw.....
16621	385	" " " Foot.....
217j	3384	" " " " " " " " Screw.....
6053	380	Drip Pan.....
*15404	—	Trade Mark.....
15405	20883	" " Rivet.....

LIST OF PARTS COMPLETE

FOR

MACHINE No. 17-10

DROP FEED UP THE ARM AND REVERSE.
CLOTH OR LEATHER.

NO.	PLATE	NAME
*6125	—	Arm with 4448, 4449, 6169, 15404 and two each 145j and 15405.....
4389	3383	Arm Dowel Pin.....
4448	3383	" Oil Tube for intermediate bearing..
123E	312	" Screw.....
4368	364	" Shaft.....
3005	259	" " Bushing (back).....
448c	379	" " " " Set Screw....
*4449	—	" " " (front).....
144D	3384	" " Screw.....
4288	368	" Side Cover.....
286D	3385	" " " Thumb Screw.....
12403	377	" Spool Pin and Thread Eyelet.....
11241	382	" " " Washer (cloth).....
4370	364	Balance Wheel, heavy rim, 2¾ in. pulley, with two 448c.....
2862	364	Balance Wheel, heavy rim, 3 in. pulley, for 3022.....
448c	379	Balance Wheel Set Screw.....
2139	366	" " Speed Pulley, 1½ in. diam., with 451c.....
2140	366	Balance Wheel Speed Pulley, 2⅞ in. diam., with 437c.....
451c	3385	Balance Wheel Speed Pulley Set Screw for 2139.....
437c	3385	Balance Wheel Speed Pulley Set Screw for 2140.....
256J	259	Clamp Stop Motion Clamp Screw.....
248A	3385	" " " " Stop Screw..
2020	259	" " " " Washer.....
*3023	—	" " " Flanged Bushing...
4933	259	" " " " " 3023 with two 462c.....
2022	221	Clamp Stop Motion Flanged Bushing Pin.....
462c	3385	Clamp Stop Motion Flanged Bushing Set Screw.....

PARTS FOR MACHINE No. 17-10

57

NO.	PLATE	NAME
3022	—	Clamp Stop Motion complete, Nos. 248A, 256J, 2020 and 4933.....
6127	365	Cloth Plate for 6163, 6164, 6172 to 6174 and 6280.....
401D	3385	Cloth Plate Screw.....
4292	364	Crank Connecting Rod.....
145E	3384	" " " Cap Screw.....
375c	312	" " " " Hinge Screw....
1518J	312	" " " " " " Nut
*6126	—	Cylinder, 2¼ in. diam.....
4343	365	Face Plate.....
56796	—	" " 4343 with 2105.....
56775	—	Face Plate complete, Nos. 448c, 460c, 2107, 2111, 2127, 2269, 4369, 56791, 56796 and two 233J.....
164J	312	Face Plate Screw.....
2107	221	" " Thread Guard.....
233J	3384	" " " " Screw.....
3032	259	Feed Cam with 446c.....
446c	312	" " Set Screw.....
3033	259	" Connecting Link.....
375c	312	" " " Hinge Screw....
1518J	312	" " " " " Nut.
6281	376	" Dog, for cloth.....
NOTE: 6281 is sent with this machine unless another Feed Dog is specified on order.		
6282	376	Feed Dog, for leather.....
6283	373	" " two rows of teeth.....
185H	379	" " Screw.....
16770	3368	" Forked Connection.....
375c	312	" " " Hinge Screw...
1518J	312	" " " " " Nut
6132	374	" " " Universal Joint
212E	379	" " " " " " Cap Screw.....
23c	379	Feed Forked Connection Universal Joint Hinge Screw.....
14647	3367	Feed Regulator Crank with two 448c....
448c	379	" " " Set Screw.....
6808	368	" " Lever with 207F.....
6809	—	Feed Regulator Lever complete, Nos. 190J, 6808 and 6810.....
286D	3385	Feed Regulator Lever Adjusting Thumb Screw.....
1584E	379	Feed Regulator Lever Adjusting Thumb Screw Nut.....

NO.	PLATE	NAME
6810	368	Feed Regulator Lever Friction Plate
190J	3384	" " " " " "
		Screw.....
732D	379	Feed Regulator Lever Friction Plate
		Thumb Screw.....
2049	221	Feed Regulator Lever Pin.....
207F	3384	" " " " Set Screw.....
6811	368	" " " " Segment.....
330J	379	" " " " " Screw....
6134	364	" " " " Shaft.....
*6169	—	" " " " Bracket....
145E	3384	" " " " " Screw.
6137	370	" Rock Shaft.....
16767	382	" " " " Arm with 453c.....
2117	221	" " " " Pin.....
453c	3385	" " " " " Set Screw.....
300c	3384	" " " " Screw Center.....
1513J	379	" " " " " Nut.....
6161	364	" Rod.....
657F	3384	" " Hinge Screw.....
16884	3389	" " Lifting Block.....
207F	3384	" " " " " Screw.....
16639	385	" " Spring.....
233J	3384	" " " " " Screw.....
4264	301	Needle Bar.....
*3045	301	" " Connecting Link.....
56773	—	" " " " " 3045 with
		2052.....
377c	312	Needle Bar Connecting Link Hinge Screw
1518J	312	" " " " " " " "
		Nut.....
2052	374	Needle Bar Connecting Stud with 155c..
155c	3384	" " " " " Set Screw..
290E	3385	" " " " " Screw Bushing.....
7524	3383	" " " " " Clamp with 196F, 651J and 7525
196F	3383	" " " " " Screw.....
7525	3383	" " " " " Thread Guide.....
651J	3383	" " " " " " Screw.....
*6022	367	Oscillating Rock Shaft with 4784.....
16806	—	Oscillating Rock Shaft complete, Nos.
		6022 and 56812.....
3052	367	Oscillating Rock Shaft Hinge Pin....
56812	—	" " " " " " " 3052
		with 1513J.....
1513J	379	Oscillating Rock Shaft Hinge Pin Nut..
4784	3383	" " " " " Oil Pad.....
6023	364	" Shaft.....

NO.	PLATE	NAME
*6056	—	Oscillating Shaft Crank with 460c and
		1813.....
6024	377	Oscillating Shaft Crank with 1813 and
		two 462c.....
2049	221	Oscillating Shaft Crank Pin.....
1813	221	" " " " Roller and Stud
460c	3379	" " " " Set Screw for
		6056.....
462c	3385	Oscillating Shaft Crank Set Screw for
		6024.....
3054	301	Presser Bar.....
52016	20879	" " " " Lifter.....
689c	312	" " " " " Screw.....
1520E	379	" " " " " Nut.....
5608	259	" " " " Lifting Bracket with 453c...
453c	3385	" " " " " Set Screw...
290E	3385	" " " " " Screw Bushing.....
3056	301	" " " " Spring (heavy).....
2308	301	" " " " (light).....
2070	221	" " " " Washer.....
6278	374	" " " " Foot (long shank).....
6279	374	" " " " (short shank).....
190J	3384	" " " " " Screw.....
262J	312	Pressure Regulating Thumb Screw.....
1868	231	Roller, 7/8 in. diam., coarse, with 652D
		and 1528J, for 6141.....
1841	—	Roller, 7/8 in. diam., fine, with 652D
		and 1528J, for 6142.....
1839	231	Roller, 1 1/4 in. diam., coarse, with 386D
		and 1528J, for 6143.....
1869	—	Roller, 1 1/4 in. diam., fine, with 386D
		and 1528J, for 6144.....
6145	378	Roller Arm for 6141 and 6142.....
6146	378	" " " " 6143 and 6144.....
440F	231	" " " " Adjusting Screw.....
1547J	231	" " " " " Nut.....
2206	231	" " " " Bracket for 6141 and 6142...
4282	3371	" " " " " 6143 and 6144...
316F	231	" " " " " Screw Center.....
15444	—	" " " " " " " 316F
		with 1547J.....
1547J	231	Roller Arm Bracket Screw Center Nut..
2205	231	" " " " Lock Spring.....
176J	231	" " " " " Screw.....
1549J	231	" " " " " " Nut.....

NO.	PLATE	NAME
6141	378	Roller Presser complete, 7/8 in. coarse roller, Nos. 176J, 440F, 1547J, 1549J, 1868, 2205, 2206, 6145 and two 15144
6142	---	Roller Presser complete, 7/8 in. fine roller, Nos. 176J, 440F, 1547J, 1549J, 1841, 2205, 2206, 6145 and two 15444.....
NOTE: No. 6142 is sent with this machine unless another Roller Presser is specified on order.		
6143	378	Roller Presser complete, 1 1/4 in. coarse roller, Nos. 176J, 440F, 1547J, 1549J, 1839, 2205, 4282, 6146 and two 15444
6144	---	Roller Presser complete, 1 1/4 in. fine roller, Nos. 176J, 440F, 1547J, 1549J, 1869, 2205, 4282, 6146 and two 15444
190J	3384	Roller Presser Screw.....
652D	3385	" Screw for 1841 and 1868.....
386D	3385	" " " 1839 and 1869.....
1528J	3386	" " Nut.....
2073	217	Shuttle Bobbin.....
2211	217	" " Retaining Spring.....
2212	217	" " " " Rivet..
*6058	---	" Body with 398E, 2082, 2084, 2211 and two 2212.....
*15458	---	Shuttle Cover.....
125017	---	" " 15458 with 112E, 466H, 2078, 2080, 2086 and 2090.....
2076	217	Shuttle Cover Hinge Pin.....
2078	217	" Delivery Eye Thread Guard....
2080	217	" " " " Rivet
2082	217	" Main Spring.....
398E	217	" " " Screw.....
2084	217	" " " Steady Pin.....
466H	217	" Tension Regulating Screw.....
2086	217	" " Spring.....
2090	217	" " " Plate.....
112E	217	" " " Screw.....
16892	20880	Shuttle (high point) complete, Nos. 2073, 2076, 6058 and 125017.....
6147	370	Shuttle Driver and Feed Lifting Cam...
2049	221	" " " " " Pin
6168	---	" Race Ring.....
6148	366	" " " 6168 with 6153 and two 590E.....
6149	---	Shuttle Race Ring complete, Nos. 6148 and 6150.....
6150	366	Shuttle Race Ring Cover with 6151 and two 8505.....

NO.	PLATE	NAME
6151	375	Shuttle Race Ring Cover Hinge.....
8505	3383	" " " " " Rivet...
7177	377	" " " " " Spring.....
330J	379	" " " " " Screw..
198J	312	" " " " " Screw.....
6153	375	" " " " " Thread Protector....
590E	379	" " " " " " Screw
2102	377	Tension Disc.....
1560c	379	" Regulating Thumb Nut.....
4369	377	" Releaser.....
2269	377	" " Hinge Pin.....
600c	379	" Screw Stud.....
16202	---	" " " 600c with 1560c....
448c	379	" " " Set Screw.....
2103	377	" Spring.....
2105	377	" Thread Guard.....
56791	---	Tension complete, Nos. 2103, 2124, 16202 and two 2102.....
2112	221	Thread Retaining Disc with 2113.....
2113	221	" " " Steady Pin.....
2114	221	" " Spring.....
2115	221	" " Stud.....
460c	3379	" " " Set Screw.....
2111	221	Thread Retainer Guide complete, Nos. 2112, 2114 and 2115.....
*56831	---	Thread Take-up Cam.....
3280	382	" " " 56831 with 446c...
3012	297	" " " Pin.....
446c	312	" " " Set Screw.....
*3072	259	" " Lever with 1819.....
56855	---	" " " 3072 with 1088c
1088c	3388	" " " Hinge Screw....
1819	379	" " " Roller and Stud
2124	221	" " Spring.....
2127	221	" " " Regulator Plate
233J	3384	" " " " " "
Adjusting Screw.....		
6173	---	Throat Plate, large needle hole, for 6281
6163	373	" " small needle hole, for 6281
6174	---	" " large needle hole, for 6282
6164	373	" " small needle hole, for 6282
6172	---	" " large needle hole, for 6283
6280	373	" " small needle hole, for 6283
401D	3385	" " Screw.....
6053	380	Drip Pan.....
*15404	---	Trade Mark.....
15405	20883	" " Rivet.....

LIST OF PARTS COMPLETE

FOR

MACHINE No. 17-11

FOR LEATHER. HAS VERTICAL TRIMMER,
DROP FEED ACROSS ARM.

NO.	PLATE	NAME
*6284	—	Arm with 4448, 4449, 15404 and two 15405.....
4389	3383	Arm Dowel Pin.....
4448	3383	" Oil Tube for intermediate bearing
123E	312	" Screw.....
4359	3304	" Shaft.....
3005	259	" " Bushing (back).....
448c	379	" " " " Set Screw....
*4449	—	" " " (front).....
144D	3384	" " Screw.....
4288	368	" Side Cover.....
286D	3385	" " Thumb Screw.....
12403	377	" Spool Pin and Thread Eyelet.....
11241	382	" " Washer (cloth).....
4370	364	Balance Wheel, heavy rim, 2 $\frac{3}{4}$ in. pulley, with two 448c.....
2862	364	Balance Wheel, heavy rim, 3 in. pulley, for 3022.....
448c	379	Balance Wheel Set Screw.....
2139	366	" " Speed Pulley, 1 $\frac{1}{8}$ in. diam., with 451c.....
2140	366	Balance Wheel Speed Pulley, 2 $\frac{3}{8}$ in. diam., with 437c.....
451c	3385	Balance Wheel Speed Pulley Set Screw for 2139.....
437c	3385	Balance Wheel Speed Pulley Set Screw for 2140.....
256J	259	Clamp Stop Motion Clamp Screw.....
248A	3385	" " " " Stop Screw..
2020	259	" " " " Washer.....
*3023	—	" " " Flanged Bushing...
4933	259	" " " " " 3023 with two 462c.....
2022	221	Clamp Stop Motion Flanged Bushing Pin.....
462c	3385	Clamp Stop Motion Flanged Bushing Set Screw.....

NO.	PLATE	NAME
3022	—	Clamp Stop Motion complete, Nos. 248A, 256J, 2020 and 4933.....
4292	364	Crank Connecting Rod.....
145E	3384	" " " Cap Screw.....
375c	312	" " " Hinge Screw....
1518J	312	" " " " " Nut
*6002	—	Cylinder, 2 $\frac{1}{8}$ in. diam.....
4380	3364	Face Plate.....
56789	—	" " 4380 with 2105.....
56802	—	Face Plate complete, Nos. 448c, 460c, 2107, 2111, 2127, 2269, 4369, 56789, 56791 and two 233J.....
175J	3384	Face Plate Screw.....
2107	221	" " Thread Guard.....
233J	3384	" " " " Screw.....
3032	259	Feed Cam with 446c.....
446c	312	" " Set Screw.....
3033	259	" Connecting Link.....
375c	312	" " " Hinge Screw....
1518J	312	" " " " " Nut
6285	375	" Dog, 12 teeth, for 6293.....
6016	366	" " Carrier.....
225c	379	" " Screw.....
3037	364	" Forked Connection.....
375c	312	" " " Hinge Screw....
1518J	312	" " " " " Nut
3039	259	" Regulator.....
58E	312	" " Hinge Screw.....
818D	379	" " Thumb Screw.....
6017	364	" Rock Shaft.....
6018	366	" " " Crank with 207F.....
156F	379	" " " " Position Screw..
207F	3384	" " " " Set Screw.....
6287	375	Knife, medium, end cut only.....
6288	375	" " " " " (shearing)..
6289	375	" " " " and side cut.....
6290	375	" " " " " (con- cave).....
6291	375	Knife, medium, end and side cut (thin gauge).....
6292	375	Knife, narrow, end and side cut.....
NOTE: Five No. 6292 are sent with this machine unless otherwise specified on order.		
6442	375	Knife, wide, end and side cut.....
3089	259	" Bar with 2301.....

NO.	PLATE	NAME
4581	—	Knife Bar complete, Nos. 621D, 2291, 2298, 3089, 3095, 3109 and two 335H...
3092	297	Knife Bar Driving Crank with 1822....
1822	221	" " " " Roller and Stud
3094	297	" " " " Wedge.....
690E	312	" " " " " Screw..
4739	3367	" " " " Slide.....
3095	297	Knife Bar Driving Slide complete, Nos. 468c, 514c, 1564D, 2296, 2297 and 4739
514c	379	Knife Bar Driving Slide Coupling Pin
2296	375	" " " " " " "
		Bushing.....
468c	3367	Knife Bar Driving Slide Coupling Pin Bushing Set Screw.....
1564D	3386	Knife Bar Driving Slide Coupling Pin Head.....
2297	375	Knife Bar Driving Slide Coupling Pin Spring.....
2298	375	Knife Bar Handle.....
621D	3386	" " " " Screw.....
9804	297	" " Lifting Spring.....
2301	3383	" " Stop Pin.....
3109	297	" Holder with two 223F.....
335H	3386	" " Screw.....
223F	312	" Screw.....
2291	375	" " Washer.....
3097	301	Needle Bar.....
*3098	297	" " Connecting Link with 390E..
56847	—	" " " " 3098 with 15472.....
390E	3385	Needle Bar Connecting Link Adjusting Screw.....
15472	3389	Needle Bar Connecting Stud with 155c..
155c	3384	" " " " " Set Screw..
2306	375	" " Thread Guard.....
1116F	3377	" " " " " Screw.....
336F	3384	" Set Screw.....
*6022	367	Oscillating Rock Shaft with 4784.....
16806	—	Oscillating Rock Shaft complete, Nos. 6022 and 56812.....
3052	367	Oscillating Rock Shaft Hinge Pin....
56812	—	" " " " " " 3052 with 1513J.....
1513J	379	Oscillating Rock Shaft Hinge Pin Nut...
4784	3383	" " " " Oil Pad.....
6023	364	" Shaft.....

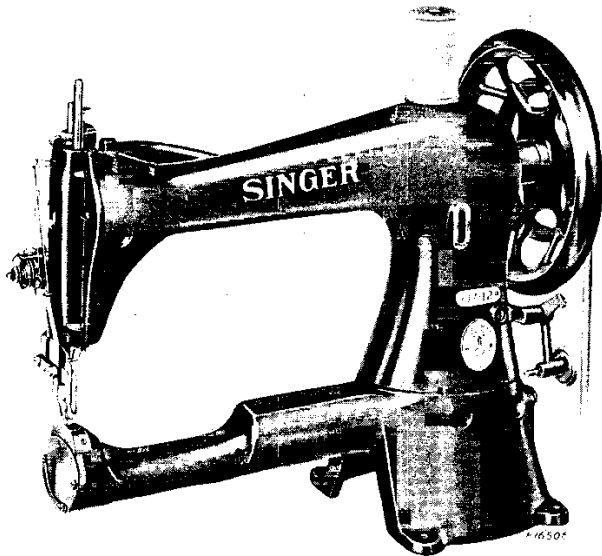
NO.	PLATE	NAME
*6056	—	Oscillating Shaft Crank with 460c and 1813.....
6024	377	Oscillating Shaft Crank with 1813 and two 462c.....
2049	221	Oscillating Shaft Crank Pin.....
1813	221	" " " " Roller and Stud..
460c	3379	" " " " Set Screw for 6056
462c	3385	" " " " " " 6024
2058	3365	Presser Bar.....
52016	20879	" " Lifter.....
689c	312	" " " " Screw.....
1520E	379	" " " " Nut.....
5612	3365	" " Lifting Bracket with 453c...
453c	3385	" " " " " Set Screw...
3100	301	" " Spring.....
2070	221	" " " " Washer.....
262J	312	Pressure Regulating Thumb Screw.....
1868	231	Roller, 1/8 in. diam., coarse, with 652D and 1528J, for 2309.....
1841	—	Roller, 1/8 in. diam., fine, with 652D and 1528J, for 2310.....
1839	231	Roller, 1/4 in. diam., coarse, with 386D and 1528J, for 16099.....
1869	—	Roller, 1/4 in. diam., fine, with 386D and 1528J, for 16100.....
2203	231	Roller Arm for 2309 and 2310.....
16098	3371	" " " " 16099 and 16100.....
440F	231	" " Adjusting Screw.....
1547J	231	" " " " " Nut.....
2313	3373	" " Bracket for 2309 and 2310...
4282	3371	" " " " " 16099 and 16100
316F	231	" " " " " Screw Center.....
15444	—	" " " " " " 316F with 1547J.....
1547J	231	Roller Arm Bracket Screw Center Nut..
2205	231	" " Lock Spring.....
176J	231	" " " " " Screw.....
1549J	231	" " " " " Nut.....
2309	—	Roller Presser complete, 1/8 in. coarse roller, Nos. 176J, 440F, 1547J, 1549J, 1868, 2203, 2205, 2313 and two 15444
2310	378	Roller Presser complete, 1/8 in. fine roller, Nos. 176J, 440F, 1547J, 1549J, 1841, 2203, 2205, 2313 and two 15444.....

NOTE: No. 2310 is sent with this machine unless another Roller Presser is specified on order.

NO.	PLATE	NAME
16099	3371	Roller Presser complete, 1¼ in. coarse roller, Nos. 176J, 440F, 1547J, 1549J, 1839, 2205, 4282, 16098 and two 15444
16100	—	Roller Presser complete, 1¼ in. fine roller, Nos. 176J, 440F, 1547J, 1549J, 1869, 2205, 4282, 16098 and two 15444
190J	3384	Roller Presser Screw.....
652D	3385	" Screw for 1841 and 1868.....
386D	3385	" " " 1839 and 1869.....
1528J	3386	" " Nut.....
2073	217	Shuttle Bobbin.....
2211	217	" " Retaining Spring.....
2212	217	" " " Rivet..
*6058	—	" Body with 398E, 2082, 2084, 2211 and two 2212.....
*15458	—	Shuttle Cover.....
125017	—	" " 15458 with 112E, 466H, 2078, 2080, 2086 and 2090.....
2076	217	Shuttle Cover Hinge Pin.....
2078	217	" Delivery Eye Thread Guard.....
2080	217	" " " " Rivet
2082	217	" Main Spring.....
398E	217	" " Screw.....
2084	217	" " " Steady Pin.....
466H	217	" Tension Regulating Screw.....
2086	217	" " Spring.....
2090	217	" " " Plate.....
112E	217	" " " " Screw.....
16892	20880	Shuttle (high point) complete, Nos. 2073, 2076, 6058 and 125017.....
6029	367	Shuttle Driver and Feed Lifting Cam...
2049	221	" " " " " " Pin
16601	388	" Race Ring.....
16602	—	" " " 16601 with 65059 and two 337J.....
16688	—	Shuttle Race Ring Cover.....
16689	382	" " " " 16688 with 16242 and two 725J.....
16242	20880	Shuttle Race Ring Cover Latch.....
725J	312	" " " " " Screw...
50250J	3388	" " " " Screw.....
175J	3384	" " " Screw.....
65059	20879	" " " Thread Protector...
337J	3385	" " " " " Screw
2102	377	Tension Disc.....
1560C	379	" Regulating Thumb Nut.....
4369	377	" Releaser.....

NO.	PLATE	NAME
2269	377	Tension Releaser Hinge Pin.....
600C	379	" Screw Stud.....
16202	—	" " " 600C with 1560C....
448C	379	" " " Set Screw.....
2103	377	" Spring.....
2105	377	" Thread Guard.....
56791	—	Tension complete, Nos. 2103, 2124, 16202 and two 2102.....
2112	221	Thread Retaining Disc with 2113.....
2113	221	" " " Steady Pin.....
2114	221	" " Spring.....
2115	221	" " Stud.....
460C	3379	" " " Set Screw.....
2111	221	Thread Retainer Guide complete, Nos. 2112, 2114 and 2115.....
*56843	—	Thread Take-up Cam.....
3104	370	" " " 56843 with 446C...
3012	297	" " " Pin.....
446C	312	" " " Set Screw.....
*3072	259	" " Lever with 1819.....
56855	—	" " " 3072 with 1088C.
1088C	3388	" " " Hinge Screw.....
1819	379	" " " Roller and Stud
2124	221	" " Spring.....
2127	221	" " " Regulator Plate
233J	3384	" " " " " "
6295	375	Adjusting Screw.....
6295	375	Throat Plate Cutting Bar.....
NOTE: When ordering No. 6295 state required distance of trimmed edge from seam		
1208D	20882	Throat Plate Cutting Bar Screw.....
2328	375	" " Spring Slide.....
2330	375	" " " Spring.....
6296	375	" " " " " S t o p
2332	375	" " " " " " "
6293	375	Rivet.....
6293	375	Throat Plate complete, for 6285, Nos. 2328, 2330, 6295, 6296 and two each 1208D and 2332.....
NOTE: When ordering No. 6293 state required distance of trimmed edge from seam		
401D	3385	Throat Plate Screw.....
6053	380	Drip Pan.....
*15404	—	Trade Mark.....
15405	20883	" " Rivet.....

**LIST OF PARTS COMPLETE
FOR**



MACHINE No. 17-12

FOR HORSE BOOTS AND OTHER CONCAVE ARTICLES IN LEATHER. UPPER FEED ACROSS ARM ONLY AND PRESSER FEED POINT FOR 1/8 INCH "SET" STITCH. PRESSER FEED POINTS FOR 1/4, 1/8, 1/10 AND 1/12 INCH "SET" STITCH CAN BE FURNISHED IF SO ORDERED AT AN EXTRA COST.

NO.	PLATE	NAME
*16666	—	Arm with 159j, 180j, 4448, 4449, 4891, 4892, 6305, 15404, two 15405 and four 129j.....
4389	3383	Arm Dowel Pin.....
4448	3383	" Oil Tube for intermediate bearing..
123E	312	" Screw.....

NO.	PLATE	NAME
6178	3361	Arm Shaft for 3011.....
6179	3364	" " " 5977.....
3005	259	" " Bushing (back).....
448c	379	" " " " Set Screw....
*4449	—	" " " (front).....
144D	3384	" " Screw.....
6302	368	" Side Cover.....
286D	3385	" " Thumb Screw.....
12403	377	" Spool Pin and Thread Eyelet.....
11241	382	" " Washer (cloth).....
3011	3364	Balance Wheel (two speed) 3 in. and 5 in. pulleys, with two 448c.....
5977	3364	Balance Wheel (two speed) 3 in. and 5 in. pulleys, for 5981.....
448c	379	Balance Wheel Set Screw.....
4292	364	Crank Connecting Rod.....
145E	3384	" " Cap Screw.....
375c	312	" " " Hinge Screw....
1518j	312	" " " " " Nut
*16773	—	Cylinder, 2 1/8 in. diam.....
5978	366	Driving Flange with two 435c.....
5993	—	Driving Flange complete, Nos. 136F, 330j and 5978 to 5980.....
5979	377	Driving Flange Latch.....
136F	379	" " " Hinge Screw....
5980	377	" " " Spring.....
330j	379	" " " " Screw.....
435c	379	" " Set Screw.....
5981	—	Loose Wheel Attachment complete, Nos. 5977 and 5993.....
56871	20876	Face Plate.....
56872	—	" " 56871 with 2105.....
56873	—	Face Plate complete, Nos. 448c, 460c, 2111, 2127, 2269, 4378, 56791, 56870, 56872 and two 233j.....
175j	3384	Face Plate Screw.....
56870	20879	" " Thread Guard.....
233j	3384	" " " " Screw.....
6319	369	Feed Bar.....
6306	375	" " Connecting Link.....
89E	379	" " " " Hinge Screw.
2361	259	" " Hinge Bracket.....
2362	221	" " " " Rivet.....
810b	379	" " " Cap Screw.....
6303	369	" Cam with two 446c.....
446c	312	" " Set Screw.....
4904	3368	" Lever.....

NO.	PLATE	NAME
*6305	—	Feed Lever Bracket with two 620c.....
180J	3384	“ “ “ Screw (lower).....
159J	3384	“ “ “ “ (upper).....
6307	3367	“ “ Hinge Pin.....
620c	379	“ “ “ “ Set Screw.....
6308	374	“ Point.....
NOTE: When ordering No. 6308, give number of stitches to the inch		
217J	3384	Feed Point Screw.....
4905	3369	“ Regulator with 4907 and two 237J
4938	—	Feed Regulator complete, Nos. 666F, 1014D, 4905 4906 and 4959.....
2049	221	Feed Regulator Pin.....
4906	3367	“ “ Slide Block.....
1014D	3385	“ “ Thumb Screw.....
666F	3385	“ “ “ “ Lock Screw
4959	3383	“ “ “ “ Stud..
4907	3367	“ “ “ “ S t o p Bracket.....
237J	3384	Feed Regulator Thumb Screw Stop Bracket Screw.....
4908	3366	Feed Shaft.....
*4892	—	“ “ Bracket (back).....
129J	3384	“ “ “ “ Screw.....
*4891	—	“ “ “ (front).....
129J	3384	“ “ “ “ Screw.....
6316	369	“ “ Crank with 453c and 1813..
3093	297	“ “ “ Pin.....
1813	221	“ “ “ Roller and Stud.....
453c	3385	“ “ “ “ Set Screw.....
3126	259	Guide Bar.....
*56752	—	“ “ 3126 with 2361 and two 2362
56868	—	“ “ 56752 with 4723 and three 404J
16656	—	Guide Bar complete, Nos. 810D, 810E, 4897, 6319 and 56868.....
4854	389	Guide Bar Driving Crank with 1862 and 3131.....
1862	297	Guide Bar Driving Crank Roller (roller only).....
3131	297	Guide Bar Driving Crank Roller Cap....
3094	297	“ “ “ “ Wedge.....
690E	312	“ “ “ “ “ Screw.
4723	389	“ “ Lifting Bracket.....
404J	3385	“ “ “ “ “ Screw.....
2058	3365	Lifting Presser Bar.....
3133	259	“ “ “ Bracket with 641E and 1823.....

NO.	PLATE	NAME
641E	3384	Lifting Presser Bar Bracket Clamping Screw.....
1823	221	Lifting Presser Bar Bracket Roller and Stud.....
4855	3366	Lifting Presser Bar Lifter.....
598c	3385	“ “ “ “ Screw.....
683D	3384	“ “ “ “ Stop Screw....
4897	3365	“ “ “ “ Lifting Bell Crank
810E	379	“ “ “ “ “ “ Hinge Cap Screw.....
4725	3365	Lifting Presser Bar Lifting Bracket....
4726	3383	“ “ “ “ “ “ Guide Pin.....
3100	301	Lifting Presser Bar Spring.....
2070	221	“ “ “ “ Washer.....
6317	374	“ “ Foot.....
193J	20883	“ “ “ “ Screw.....
4264	301	Needle Bar.....
*4898	3367	“ “ Connecting Link with 390E
56764	—	“ “ “ “ 4898 with 15472.....
390E	3385	Needle Bar Connecting Link Adjusting Screw.....
15472	3389	Needle Bar Connecting Stud with 155c...
155c	3384	“ “ “ “ “ Set Screw..
4265	302	“ “ Clamp with 196F.....
4865	3383	Needle Clamp complete, Nos. 651J, 4265 and 4266.....
196F	3383	Needle Clamp Screw.....
4266	302	“ “ Thread Guide.....
651J	3383	“ “ “ “ “ Screw.....
6318	374	“ Plate.....
223F	312	“ “ “ “ “ Screw.....
*6022	367	Oscillating Rock Shaft with 4784.....
16806	—	Oscillating Rock Shaft complete, Nos. 6022 and 56812.....
3052	367	Oscillating Rock Shaft Hinge Pin....
56812	—	“ “ “ “ “ “ 3052 with 1513J.....
1513J	379	Oscillating Rock Shaft Hinge Pin Nut...
4784	3383	“ “ “ “ Oil Pad.....
6023	364	“ “ Shaft.....
6056	—	“ “ Crank with 460c and 1813.....
6024	377	Oscillating Shaft Crank with 1813 and two 462c.....
2049	221	Oscillating Shaft Crank Pin.....

NO.	PLATE	NAME
1813	221	Oscillating Shaft Crank Roller and Stud
460c	3379	" " " Set Screw for 6056
462c	3385	Oscillating Shaft Crank Set Screw for 6024
262j	312	Pressure Regulating Thumb Screw
2073	217	Shuttle Bobbin
2211	217	" " Retaining Spring
2212	217	" " " Rivet
*6058	—	" Body with 398E, 2082, 2084, 2211 and two 2212
*15458	—	Shuttle Cover
125017	—	" " 15458 with 112E, 466H, 2078, 2080, 2086 and 2090
2076	217	Shuttle Cover Hinge Pin
2078	217	" Delivery Eye Thread Guard
2080	217	" " " Rivet
2082	217	" Main Spring
398E	217	" " " Screw
2084	217	" " " Steady Pin
466H	217	" Tension Regulating Screw
2086	217	" " Spring
2090	217	" " " Plate
112E	217	" " " " Screw
16892	20880	" (high point) complete, Nos. 2073, 2076, 6058 and 125017
6029	367	Shuttle Driver
2049	221	" " Pin
16769	—	" Race Ring
6118	367	" " " 16769 with 6119 and two 241j
16771	—	Shuttle Race Ring Cover
16772	382	" " " " 16771 with 16242 and two 240j
16242	20880	Shuttle Race Ring Cover Latch
240j	385	" " " " " Screw
50250j	3388	" " " " " Screw
6119	375	" " " Thread Protector
241j	3384	" " " " " Screw
2102	377	Tension Disc
1560c	379	" Regulating Thumb Nut
6378	3367	" Releaser
2269	377	" " Hinge Pin
600c	379	" Screw Stud
16202	—	" " " 600c with 1560c
448c	379	" " " Set Screw
2103	377	" Spring

NO.	PLATE	NAME
2105	377	Tension Thread Guard
56791	—	Tension complete, Nos. 2103, 2124, 16202 and two 2102
2112	221	Thread Retaining Disc with 2113
2113	221	" " " Steady Pin
2114	221	" " " Spring
2115	221	" " " Stud
460c	3379	" " " Set Screw
2111	221	Thread Retainer Guide complete, Nos. 2112, 2114 and 2115
*65003	—	Thread Take-up Cam
6450	382	" " " 65003 with 446c
3012	297	" " " Pin
446c	312	" " " Set Screw
*3072	259	" " " Lever with 1819
56855	—	" " " 3072 with 1088c
1088c	3388	" " " Hinge Screw
1819	379	" " " Roller and Stud
2124	221	" " " Spring
2127	221	" " " Regulator Plate
233j	3384	" " " " " " Adjusting Screw
6053	380	Drip Pan
*15404	—	Trade Mark
15405	20883	" " Rivet

SINGER Needles should be used
in SINGER Machines.
These Needles and their Containers
are marked with the
Company's Trade-Mark "SIMANCO.*" 1**

Needles in Containers marked
"FOR SINGER MACHINES"
are NOT **SINGER made needles. 2**

LIST OF PARTS COMPLETE
FOR
MACHINE No. 17-13
DROP FEED UP ARM
FOR COTTON AND LINEN GOODS

NO.	PLATE	NAME
*6001	—	Arm with 4448, 4449, 15404 and two 15405.....
4389	3383	Arm Dowel Pin.....
4448	3383	" Oil Tube for intermediate bearing
123E	312	" Screw.....
4368	364	" Shaft.....
3005	259	" " Bushing (back).....
448c	379	" " " " Set Screw....
*4449	—	" " " (front).....
144D	3384	" " Screw.....
4288	368	" Side Cover.....
286D	3385	" " " Thumb Screw.....
12403	377	" Spool Pin and Thread Eyelet.....
11241	382	" " " Washer (cloth).....
4370	364	Balance Wheel, heavy rim, 2¼ in. pulley, with two 448c.....
2862	364	Balance Wheel, heavy rim, 3 in. pulley, for 3022.....
448c	379	Balance Wheel Set Screw.....
2139	366	" " Speed Pulley, 1½ in. diam., with 451c.....
2140	366	Balance Wheel Speed Pulley, 2⅞ in. diam., with 437c.....
451c	3385	Balance Wheel Speed Pulley Set Screw for 2139.....
437c	3385	Balance Wheel Speed Pulley Set Screw for 2140.....
256J	259	Clamp Stop Motion Clamp Screw.....
248A	3385	" " " " Stop Screw..
2020	259	" " " " Washer.....
*3023	—	" " " Flanged Bushing...
4933	259	" " " " " 3023 with two 462c.....
2022	221	Clamp Stop Motion Flanged Bushing Pin.....
462c	3385	Clamp Stop Motion Flanged Bushing Set Screw.....
3022	—	Clamp Stop Motion complete, Nos. 248A, 256J, 2020 and 4933.....

NO.	PLATE	NAME
6127	365	Cloth Plate for 6175 and 6176.....
401D	3385	" " Screw.....
4292	364	Crank Connecting Rod.....
145E	3384	" " " Cap Screw.....
375c	312	" " " Hinge Screw....
1518J	312	" " " " " Nut
*6126	—	Cylinder, 2¼ in. diam.....
4343	365	Face Plate.....
56796	—	" " 4343 with 2105.....
56775	—	Face Plate complete, Nos. 448c, 460c, 2107, 2111, 2127, 2269, 4369, 56791, 56796 and two 233J.....
164J	312	Face Plate Screw.....
2107	221	" " Thread Guard.....
233J	3384	" " " " Screw.....
3032	259	Feed Cam with 446c.....
446c	312	" " Set Screw.....
3033	259	" Connecting Link.....
375c	312	" " " Hinge Screw....
1518J	312	" " " " " Nut
6329	373	" Dog, 13 teeth (16 teeth to the inch) for 6175 and 6176.....
185H	379	Feed Dog Screw.....
6158	370	" Forked Connection.....
375c	312	" " " Hinge Screw...
1518J	312	" " " " " Nut
6132	374	" " " " Universal Joint
212E	379	" " " " " " Cap Screw.....
23c	379	Feed Forked Connection Universal Joint Hinge Screw.....
3039	259	Feed Regulator.....
58E	312	" " Hinge Screw.....
818D	379	" " Thumb Screw.....
6137	370	" Rock Shaft.....
16767	382	" " " Arm with 453c.....
6166	377	" " " Pin.....
453c	3385	" " " " Set Screw.....
300c	3384	" " " Screw Center.....
1513J	379	" " " " " Nut.....
6161	364	" Rod.....
657F	3384	" " Hinge Screw.....
16884	3389	" " Lifting Block.....
207F	3384	" " " " Screw.....
16639	385	" " Spring.....
233J	3384	" " " " Screw.....

NO.	PLATE	NAME
6322	373	Hemmer (foot) $\frac{1}{8}$ in. hem.....
6325	373	" " $\frac{3}{16}$ in. hem.....
25916	373	" Folder.....
25888	373	" Tongue.....

NOTE: When ordering Nos. 25888 or 25916 give width of hem and No. of hemmer for which it is required.

190j	3384	Hemmer Screw.....
4264	301	Needle Bar.....
*3045	301	" " Connecting Link.....
50773	—	" " " " 3045 with 2052.....
377c	312	Needle Bar Connecting Link Hinge Screw.....
1518j	312	Needle Bar Connecting Link Hinge Screw Nut.....
2052	374	Needle Bar Connecting Stud with 155c..
155c	3384	" " " " Set Screw..
290E	3385	" " Screw Bushing.....
7524	3383	" Clamp with 196F, 651j and 7525.
190F	3383	" " Screw.....
7525	3383	" " Thread Guide.....
651j	3383	" " " " Screw.....
*6022	367	Oscillating Rock Shaft with 4784.....
16806	—	Oscillating Rock Shaft complete, Nos. 6022 and 56812.....
3052	367	Oscillating Rock Shaft Hinge Pin....
56812	—	" " " " " 3052 with 1513j.....
1513j	379	Oscillating Rock Shaft Hinge Pin Nut...
4784	3383	" " " " Oil Pad.....
6023	364	" Shaft.....
*6056	—	" " Crank with 460c and 1813.....
6024	377	Oscillating Shaft Crank with 1813 and two 462c.....
2049	221	Oscillating Shaft Crank Pin.....
1813	221	" " " " Roller and Stud
460c	3379	" " " " Set Screw for 6056.....
462c	3385	Oscillating Shaft Crank Set Screw for 6024.....
3054	301	Presser Bar.....
52016	20879	" " Lifter.....
689c	312	" " " " Screw.....
1520E	379	" " " " Nut.....

NO.	PLATE	NAME
5608	259	Presser Bar Lifting Bracket with 453c...
453c	3385	" " " " Set Screw...
290E	3385	" " Screw Bushing.....
3056	301	" " Spring (heavy).....
2308	301	" " " (light).....
2070	221	" " " Washer.....
6140	374	" Foot (short shank).....
190j	3384	" " Screw.....
262j	312	Pressure Regulating Thumb Screw.....
2073	217	Shuttle Bobbin.....
2211	217	" " Retaining Spring.....
2212	217	" " " " Rivet..
*6058	—	" " Body with 398E, 2082, 2084, 2211 and two 2212.....
*15458	—	Shuttle Cover.....
125017	—	" " 15458 with 112E, 466H, 2078, 2080, 2086 and 2090.....
2076	217	Shuttle Cover Hinge Pin.....
2078	217	" Delivery Eye Thread Guard....
2080	217	" " " " Rivet
2082	217	" Main Spring.....
398E	317	" " " Screw.....
2084	217	" " " Steady Pin.....
466H	217	" Tension Regulating Screw.....
2086	217	" " Spring.....
2090	217	" " " Plate.....
112E	217	" " " " Screw....
16892	20880	Shuttle (high point) complete, Nos. 2073, 2076, 6058 and 125017.....
6147	370	Shuttle Driver and Feed Lifting Cam...
2049	221	" " " " " Pin
6168	—	" Race Ring.....
6148	366	" " " 6168 with 6153 and two 590E.....
6149	—	Shuttle Race Ring complete, Nos. 6148 and 6150.....
6150	366	Shuttle Race Ring Cover with 6151 and two 8505.....
6151	375	Shuttle Race Ring Cover Hinge.....
8505	3383	" " " " Rivet...
7177	377	" " " " Spring.....
330j	379	" " " " Screw..
198j	312	" " " " Screw.....
6153	375	" " " Thread Protector....
590E	379	" " " " " Screw
2102	377	Tension Disc.....
1560c	379	" Regulating Thumb Nut.....

NO.	PLATE	NAME
4369	377	Tension Releaser.....
2269	377	" " Hinge Pin.....
600c	379	" Screw Stud.....
16202	—	" " " 600c with 1560c....
448c	379	" " " Set Screw.....
2103	377	" Spring.....
2105	377	" Thread Guard.....
56791	—	Tension complete, Nos. 2103, 2124, 16202 and two 2102.....
2112	221	Thread Retaining Disc with 2113.....
2113	221	" " " Steady Pin.....
2114	221	" " Spring.....
2115	221	" " Stud.....
460c	3379	" " " Set Screw.....
2111	221	Thread Retainer Guide complete, Nos. 2112, 2114 and 2115.....
*56831	—	Thread Take-up Cam.....
3280	382	" " " 56831 with 446c....
3012	297	" " " Pin.....
446c	312	" " " Set Screw.....
*3072	259	" " Lever with 1819.....
56855	—	" " " 3072 with 1088c....
1088c	3388	" " " Hinge Screw.....
1819	379	" " " Roller and Stud.
2124	221	" " Spring.....
2127	221	" " " Regulator Plate
233r	3384	" " " " " "
		Adjusting Screw.....
6175	373	Throat Plate, large needle hole, for 6329.....
6176	—	Throat Plate, small needle hole, for 6329
401D	3385	" " Screw.....
6053	380	Drip Pan.....
*15404	—	Trade Mark.....
15405	20883	" " Rivet.....

MACHINE No. 17-14

DROP FEED OFF ARM FOR COTTON AND LINEN GOODS

This Machine is the same as No. 17-13 with
the following exceptions:

NO.	PLATE	NAME
6264	373	Feed Dog, 13 teeth (16 teeth to the inch) for 6270 and 6299, in place of 6329.....
6265	—	Hemmer (foot) $\frac{1}{8}$ in. hem, in place of 6322.....
6266	373	Hemmer (foot) $\frac{1}{8}$ in. hem, in place of 6325.....
120527	—	Hemmer Folder for 6265 and 6266, in place of 25916.....

NOTE: When ordering No. 120527 state
gauge required.

16774	3374	Presser Foot, in place of 6140.....
6299	—	Throat Plate, large needle hole, for 6264, in place of 6175.....
6270	373	Throat Plate, small needle hole, for 6264 in place of 6176.....

SINGER Needles should be used
in SINGER Machines.
These Needles and their Containers
are marked with the
Company's Trade-Mark "SIMANCO. ***" 1

Needles in Containers marked
"FOR SINGER MACHINES"
are NOT **SINGER** made needles. 2

LIST OF PARTS COMPLETE

FOR

MACHINE No. 17-15

FOR PORTFOLIOS AND POCKETBOOKS
HAS DROP FEED ACROSS ARM

NO.	PLATE	NAME
*6001	—	Arm with 4448, 4449, 15104 and two 15105.....
4389	3383	Arm Dowel Pin.....
4448	3383	" Oil Tube for intermediate bearing
123E	312	" Screw.....
4368	364	" Shaft.....
3005	259	" " Bushing (back).....
448c	379	" " " " Set Screw....
*4449	—	" " " " (front).....
144b	3384	" " Screw.....
4288	368	" Side Cover.....
286b	3385	" " Thumb Screw.....
12403	377	" Spool Pin and Thread Eyelet.....
11241	382	" " Washer (cloth).....
4370	364	Balance Wheel, heavy rim, 2 $\frac{3}{4}$ in. pulley, with two 448c.....
2862	364	Balance Wheel, heavy rim, 3 in. pulley, for 3022.....
448c	379	Balance Wheel, Set Screw.....
2139	366	" " Speed Pulley, 1 $\frac{1}{8}$ in. diam., with 451c.....
2140	366	Balance Wheel Speed Pulley, 2 $\frac{1}{8}$ in. diam., with 437c.....
451c	3385	Balance Wheel Speed Pulley Set Screw for 2139.....
437c	3385	Balance Wheel Speed Pulley Set Screw for 2140.....
256j	259	Clamp Stop Motion Clamp Screw.....
248A	3385	" " " " Stop Screw..
2020	259	" " " " Washer.....
*3023	—	" " " Flanged Bushing.....
4933	259	" " " " " 3023 with two 462c.....
2022	221	Clamp Stop Motion Flanged Bushing Pin.....
462c	3385	Clamp Stop Motion Flanged Bushing Set Screw.....

NO.	PLATE	NAME
3022	—	Clamp Stop Motion complete, Nos. 248A, 256j, 2020 and 4933.....
6006	365	Cloth Plate.....
6008	365	" " Bracket with 345c.....
345c	379	" " " Set Screw.....
389F	312	" " Screw.....
6007	—	Cloth Plate with Bracket complete, Nos. 6006, 6008 and two 389F.....
4292	364	Crank Connecting Rod.....
145E	3384	" " " Cap Screw.....
375c	312	" " " Hinge Screw....
1518J	312	" " " " " Nut
*6003	—	Cylinder, 2 $\frac{1}{8}$ in. diam.....
4343	365	Face Plate.....
56796	—	" " 4343 with 2105.....
56775	—	Face Plate complete, Nos. 448c, 460c, 2107, 2111, 2127, 2269, 4369, 56791, 56796 and two 233j.....
164j	312	Face Plate Screw.....
2107	221	" " Thread Guard.....
233j	3384	" " " Screw.....
3032	259	Feed Cam with 446c.....
446c	312	" " Set Screw.....
3033	259	" Connecting Link.....
375c	312	" " " Hinge Screw....
1518J	312	" " " " " Nut
6013	372	" Dog (incline feed) 15 teeth (24 teeth to the inch) for 16714.....

NOTE: No. 6013 is sent with this machine unless another Feed Dog is specified on order.

16684	3355	Feed Dog (incline feed) 10 teeth (16 teeth to the inch) for 16714.....
16677	388	Feed Dog Carrier.....
225c	379	" " Screw.....
16638	382	" Forked Connection.....
375c	312	" " " Hinge Screw....
1518J	312	" " " " " Nut
3039	259	" Regulator.....
58E	312	" " Hinge Screw.....
818D	379	" " Thumb Screw.....
6017	364	" Rock Shaft.....
6019	366	" " Crank with 207F.....
156F	379	" " " " Position Screw..
207F	3384	" " " " Set Screw.....
6440	371	Guide (roller) Nos. 1852 and 6441.....
6441	371	" Bracket.....

NO.	PLATE	NAME
1852	371	Guide Roller and Screw Stud.....
286D	3385	" Thumb Screw.....
4264	301	Needle Bar.....
*3045	301	" " Connecting Link.....
56773	—	" " " " 3045 with 2052.....
377c	312	Needle Bar Connecting Link Hinge Screw.....
1518J	312	Needle Bar Connecting Link Hinge Screw Nut.....
2052	374	Needle Bar Connecting Stud with 155c..
155c	3384	" " " " Set Screw..
290E	3385	" " Screw Bushing.....
7524	3383	" " Clamp with 196F, 651J and 7525.
196F	3383	" " " " Screw.....
7525	3383	" " Thread Guide.....
651J	3383	" " " " Screw.....
*6022	367	Oscillating Rock Shaft with 4784.....
16806	—	Oscillating Rock Shaft complete, Nos. 6022 and 56812.....
3052	367	Oscillating Rock Shaft Hinge Pin.....
56812	—	" " " " " 3052 with 1513J.....
1513J	379	Oscillating Rock Shaft Hinge Pin Nut...
4784	3383	" " " Oil Pad.....
6023	364	" Shaft.....
*6056	—	" " Crank with 460c and 1813.....
6024	377	Oscillating Shaft Crank with 1813 and two 462c.....
2049	221	Oscillating Shaft Crank Pin.....
1813	221	" " " Roller and Stud
460c	3379	" " " Set Screw for 6056.....
462c	3385	Oscillating Shaft Crank Set Screw for 6024.....
2058	3365	Presser Bar.....
52016	20879	" " Lifter.....
689c	312	" " " Screw.....
1520E	379	" " " Nut.....
5608	259	" " Lifting Bracket with 453c...
453c	3385	" " " " Set Screw...
290E	3385	" " Screw Bushing.....
3056	301	" " Spring (heavy).....
2308	301	" " " (light).....
2070	221	" " Washer.....
6026	372	" Foot, 1/2 in. tread, for 6013.....

NO.	PLATE	NAME
6025	372	Presser Foot, 5/8 in. tread, for 6013.....
190J	3384	" " Screw.....
262J	312	Pressure Regulating Thumb Screw.....
1868	231	Roller, 7/8 in. diam., coarse, with 652D and 1528J, for 2196.....
1841	—	Roller, 7/8 in. diam., fine, with 652D and 1528J, for 2197.....
2203	231	Roller Arm.....
440F	231	" " Adjusting Screw.....
1547J	231	" " " " Nut.....
2206	231	" " Bracket.....
316F	231	" " " Screw Center.....
15444	—	" " " " " 316F with 1547J.....
1547J	231	Roller Arm Bracket Screw Center Nut..
2205	231	" " Lock Spring.....
176J	231	" " " " Screw.....
1549J	231	" " " " " Nut.....
2196	3371	Roller Presser complete, 7/8 in. coarse roller, Nos. 176J, 440F, 1547J, 1549J, 1868, 2203, 2205, 2206 and two 15444..
2197	—	Roller Presser complete, 7/8 in. fine roller, Nos. 176J, 440F, 1547J, 1549J, 1841, 2203, 2205, 2206 and two 15444.....

NOTE: No. 2197 is sent with this machine unless another Roller Presser is specified on order.

190J	3384	Roller Presser Screw.....
652D	3385	" " Screw.....
1528J	3386	" " Nut.....
2073	217	Shuttle Bobbin.....
2211	217	" " Retaining Spring.....
2212	217	" " " " Rivet..
*6058	—	" " Body with 398E, 2082, 2084, 2211 and two 2212.....
*15458	—	Shuttle Cover.....
125017	—	" " 15458 with 112E, 466H, 2078, 2080, 2086 and 2090.....
2076	217	Shuttle Cover Hinge Pin.....
2078	217	" Delivery Eye Thread Guard....
2080	217	" " " " Rivet
2082	217	" Main Spring.....
398E	217	" " " Screw.....
2084	217	" " " Steady Pin.....
466H	217	" Tension Regulating Screw.....
2086	217	" " Spring.....

NO.	PLATE	NAME
2090	217	Shuttle Tension Spring Plate.....
112E	217	" " " " Screw.....
16392	20880	Shuttle (high point) complete, Nos. 2073, 2076, 6058 and 125017.....
6029	367	Shuttle Driver and Feed Lifting Cam. . .
2049	221	" " " " " Pin
6030	368	" Race Ring.....
16688	---	" " " Cover.....
16689	382	" " " " 16688 with 16242 and two 725J.....
16242	20880	Shuttle Race Ring Cover Latch.....
725J	312	" " " " " Screw...
50250J	3388	" " " " " Screw.....
175J	3384	" " " " " Screw.....
2102	377	Tension Disc.....
1560c	379	" Regulating Thumb Nut.....
4369	377	" Releaser.....
2269	377	" " Hinge Pin.....
600c	379	" Screw Stud.....
16202	---	" " " 600c with 1560c....
448c	379	" " " Set Screw.....
2103	377	" Spring.....
2105	377	" Thread Guard.....
56791	---	Tension complete, Nos. 2103, 2124, 16202 and two 2102.....
2112	221	Thread Retaining Disc with 2113.....
2113	221	" " " Steady Pin.....
2114	221	" " " Spring.....
2115	221	" " " Stud.....
460c	3379	" " " Set Screw.....
2111	221	Thread Retainer Guide complete, Nos. 2112, 2114 and 2115.....
*56831	---	Thread Take-up Cam.....
3280	382	" " " 56831 with 446c..
3012	297	" " " Pin.....
446c	312	" " " Set Screw.....
*3072	259	" " " Lever with 1819.....
56855	---	" " " 3072 with 1088c
1088c	3388	" " " Hinge Screw.....
1819	379	" " " Roller and Stud..
2124	221	" " " Spring.....
2127	221	" " " Regulator Plate
233J	3384	" " " " "
		Adjusting Screw.....
16714	3355	Throat Plate, for 5 millimeter stitch, for 6013 and 16684.....

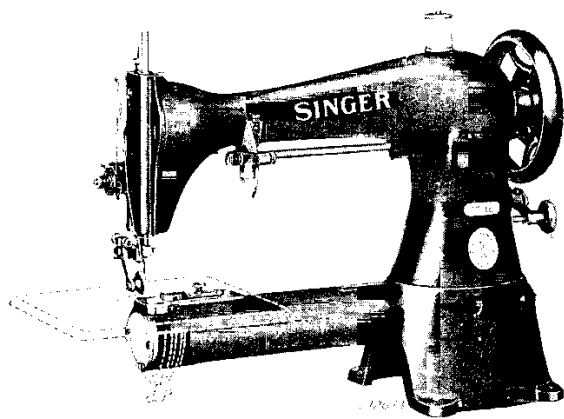
NO.	PLATE	NAME
6049	368	Throat Plate Holder with 16850, 16851 and four 16852.....
16690	---	Throat Plate Holder 6049 with 16714....
*16850	---	" " " " Packing (back)....
*16851	---	" " " " " (front)....
16852	---	" " " " " (Rivet)....
171D	312	" " " " Screw.....
6053	380	Drip Pan.....
*15404	---	Trade Mark.....
15405	20883	" " " Rivet.....

SINGER Needles should be used
in SINGER Machines.
These Needles and their Containers
are marked with the
Company's Trade-Mark "SIMANCO.**" 1

Needles in Containers marked
"FOR SINGER MACHINES"
are NOT **SINGER** made needles. 2

LIST OF PARTS COMPLETE

FOR



MACHINE No. 17-16

**FOR PORTFOLIOS AND POCKETBOOKS
HAS REVERSIBLE DROP FEED ACROSS
ARM. ROLLER PRESSER**

NO.	PLATE	NAME
*16687	—	Arm with 4448, 4449, 15404 and two 15405.....
4389	3383	Arm Dowel Pin.....
4448	3383	" Oil Tube for intermediate bearing.....
123E	312	" Screw.....
4368	364	" Shaft.....
3005	259	" " Bushing (back).....
448c	379	" " " " Set Screw....
*4449	—	" " " (front).....
144D	3384	" " Screw.....
4288	368	" Side Cover.....

PARTS FOR MACHINE No. 17-16

NO.	PLATE	NAME
286D	3385	Arm Side Cover Thumb Screw.....
12403	377	" Spool Pin and Thread Eyelet.....
11241	382	" " " Washer (cloth).....
4370	364	Balance Wheel, heavy rim, 2 3/4 in. pulley, with two 448c.....
2862	364	Balance Wheel, heavy rim, 3 in. pulley, for 3022.....
448c	379	Balance Wheel Set Screw.....
2139	366	" " Speed Pulley, 1 1/8 in. diam., with 451c.....
2140	366	Balance Wheel Speed Pulley, 2 1/8 in. diam., with 437c.....
451c	3385	Balance Wheel Speed Pulley Set Screw for 2139.....
437c	3385	Balance Wheel Speed Pulley Set Screw for 2140.....
256J	259	Clamp Stop Motion Clamp Screw.....
218A	3385	" " " " Stop Screw..
2020	259	" " " " Washer....
*3023	—	" " " Flanged Bushing... 3023
4933	259	" " " " " 3023 with two 462c.....
2022	221	Clamp Stop Motion Flanged Bushing Pin.....
462c	3385	Clamp Stop Motion Flanged Bushing Set Screw.....
3022	—	Clamp Stop Motion complete, Nos. 248A, 256J, 2020 and 4933.....
6006	365	Cloth Plate.....
6008	365	" " Bracket with 345c.....
345c	379	" " " Set Screw.....
389F	312	" " Screw.....
6007	—	Cloth Plate with Bracket complete, Nos. 6006, 6008 and two 389F.....
4292	364	Crank Connecting Rod.....
145E	3384	" " " Cap Screw.....
375c	312	" " " Hinge Screw....
1518J	312	" " " " " Nut
*6003	—	Cylinder, 2 1/8 in. diam.....
65042	20876	Face Plate.....
65043	—	" " 65042 with 2105.....
65044	—	Face Plate complete, Nos. 448c, 460c, 463c, 2107, 2111, 2127, 2269, 4369, 56791, 65043, 65045 and two 233J....
164J	312	Face Plate Screw.....
65045	20879	" " Thread Eyelet.....
463c	20883	" " " " Set Screw....

NO.	PLATE	NAME
2107	221	Face Plate Thread Guard.....
233j	3384	" " " " Screw.....
3032	259	Feed Cam with 446c.....
446c	312	" " Set Screw.....
3033	259	" Connecting Link.....
375c	312	" " " Hinge Screw.....
1518E	312	" " " " " Nut.....
6300	3355	" Dog (reversible) 13 teeth (21 teeth to the inch) for 16714.....
16677	388	Feed Dog Carrier.....
225c	379	" " Screw.....
16678	3368	" Forked Connection.....
375c	312	" " " Hinge Screw.....
1518j	312	" " " " " Nut.....
5544	259	" Regulator Crank with two 448c....
448c	379	" " " Set Screw.....
6808	368	" " Lever with 207F.....
6809	—	Feed Regulator Lever complete, Nos. 190j, 6808 and 6810.....
732D	379	Feed Regulator Lever Adjusting Thumb Screw.....
1584E	379	Feed Regulator Lever Adjusting Thumb Screw Nut.....
3146	3388	Feed Regulator Lever Adjusting Thumb Screw Nut Washer.....
6810	368	Feed Regulator Lever Friction Plate.....
190j	3384	" " " " " Screw.....
732D	379	Feed Regulator Lever Friction Plate Thumb Screw.....
2049	221	Feed Regulator Lever Pin.....
207F	3384	" " " Set Screw.....
16713	3365	" " " Segment.....
330j	379	" " " " Screw.....
5550	3366	" " " Shaft.....
6017	364	" Rock Shaft.....
6019	366	" " " Crank with 207F.....
150F	379	" " " " Position Screw..
207F	3384	" " " " Set Screw.....
6440	371	Guide (roller), Nos. 1852 and 6441....
6441	371	" Bracket.....
1852	371	" Roller and Screw Stud.....
286D	3385	" Thumb Screw.....
4264	301	Needle Bar.....
*3045	301	" " Connecting Link.....
56773	—	" " " " 3045 with 2052.....

NO.	PLATE	NAME
377c	312	Needle Bar Connecting Link Hinge Screw
1518j	312	" " " " " " " Nut.....
2052	374	Needle Bar Connecting Stud with 155c..
155c	3384	" " " " Set Screw..
290E	3385	" " Screw Bushing.....
7524	3383	" Clamp with 196F, 651j and 7525.
196F	3383	" " Screw.....
7525	3383	" " Thread Guide.....
651j	3383	" " " " Screw.....
*6022	367	Oscillating Rock Shaft with 4784.....
16806	—	Oscillating Rock Shaft complete, Nos. 6022 and 56812.....
3052	367	Oscillating Rock Shaft Hinge Pin....
56812	—	" " " " " 3052 with 1513j.....
1513j	379	Oscillating Rock Shaft Hinge Pin Nut...
4784	3383	" " " Oil Pad.....
6023	364	" Shaft.....
*6056	—	" " Crank with 460c and 1813.....
6024	377	Oscillating Shaft Crank with 1813 and two 462c.....
2049	221	Oscillating Shaft Crank Pin.....
1813	221	" " " Roller and Stud
460c	3379	" " " Set Screw for 6056.....
462c	3385	Oscillating Shaft Crank Set Screw for 6024.....
2058	3365	Presser Bar.....
52016	20879	" " Lifter.....
689c	312	" " " Screw.....
1520E	379	" " " " Nut.....
5608	259	" " Lifting Bracket with 453c....
453c	3385	" " " Set Screw...
290E	3385	" " Screw Bushing.....
3056	301	" " Spring (heavy).....
2308	301	" " " (light).....
2070	221	" " " Washer.....
16691	3374	" Foot, $\frac{1}{2}$ in. tread.....
16692	3374	" " $\frac{3}{4}$ in. tread.....
190r	3384	" " Screw.....
26276	3389	" " Hinge Pin.....
16824	—	" " Plate.....
16825	—	" " Shank.....
16826	3389	Presser Foot (hinged) complete, Nos. 16824, 16825 and 26276.....

NO.	PLATE	NAME
262J	312	Pressure Regulating Thumb Screw.....
1868	231	Roller, $\frac{7}{8}$ in. diam., coarse, with 652D and 1528J, for 2196.....
1841	---	Roller $\frac{7}{8}$ in. diam., fine, with 652D and 1528J, for 2197.....
2203	231	Roller Arm.....
440F	231	" " Adjusting Screw.....
1547J	231	" " " " Nut.....
2206	231	" " Bracket.....
316F	231	" " " Screw Center.....
15444	---	" " " " " 3 1 6 F with 1547J.....
1547J	231	Roller Arm Bracket Screw Center Nut..
2205	231	" " Lock Spring.....
176J	231	" " " " Screw.....
1549J	231	" " " " " Nut.....
2196	3371	Roller Presser complete, $\frac{7}{8}$ in. coarse roller, Nos. 176J, 440F, 1547J, 1549J, 1868, 2203, 2205, 2206 and two 15444
2197	----	Roller Presser complete, $\frac{7}{8}$ in. fine roller, Nos. 176J, 440F, 1547J, 1549J, 1841, 2203, 2205, 2206 and two 15444.....
NOTE: No. 2197 is sent with this machine unless another Roller Presser is specified on order.		
190J	3384	Roller Presser Screw.....
652D	3385	" Screw.....
1528J	3386	" " Nut.....
2073	217	Shuttle Bobbin.....
2211	217	" " Retaining Spring.....
2212	217	" " " " Rivet..
*6058	---	" Body with 398E, 2082, 2084, 2211 and two 2212.....
*15458	---	Shuttle Cover.....
125017	---	" " 15458 with 112E, 466H, 2078, 2080, 2086 and 2090.....
2076	217	Shuttle Cover Hinge Pin.....
2078	217	" Delivery Eye Thread Guard....
2080	217	" " " " Rivet
2082	217	" Main Spring.....
398E	217	" " " Screw.....
2084	217	" " " Steady Pin.....
466H	217	" Tension Regulating Screw.....
2086	217	" " Spring.....
2090	217	" " " Plate.....
112E	217	" " " " Screw.....

NO.	PLATE	NAME
16892	20880	Shuttle (high point) complete, Nos. 2073, 2076, 6058 and 125017.....
6029	367	Shuttle Driver and Feed Lifting Cam...
2049	221	" " " " " " Pin
6030	368	" Race Ring.....
16688	---	" " " Cover.....
16689	382	" " " " 16688 with 16242 and two 725J.....
16242	20880	Shuttle Race Ring Cover Latch.....
725J	312	" " " " " Screw...
50250J	3388	" " " " " Screw.....
175J	3384	" " " " " Screw.....
2102	377	Tension Disc.....
1560c	379	" Regulating Thumb Nut.....
4369	377	" Releaser.....
2269	377	" " Hinge Pin.....
600c	379	" Screw Stud.....
16202	---	" " " 600c with 1560c...
448c	379	" " " Set Screw.....
2103	377	" Spring.....
2105	377	" Thread Guard.....
56791	---	Tension complete, Nos. 2103, 2124, 16202 and two 2102.....
2112	221	Thread Retaining Disc with 2113.....
2113	221	" " " Steady Pin.....
2114	221	" " Spring.....
2115	221	" " Stud.....
460c	3379	" " " Set Screw.....
2111	221	Thread Retainer Guide complete, Nos. 2112, 2114 and 2115.....
*56831	---	Thread Take-up Cam.....
3280	382	" " " 56831 with 446c..
3012	297	" " " Pin.....
446c	312	" " " Set Screw.....
*3072	259	" " Lever with 1819.....
56855	---	" " " 3072 with 1088c..
1088c	3388	" " " Hinge Screw....
1819	379	" " " Roller and Stud
2124	221	" " Spring.....
2127	221	" " " Regulator Plate
233J	3384	" " " " " "
Adjusting Screw.....		
16714	3355	Throat Plate for 6300.....
6049	368	" " Holder with 16850, 16851 and four 16852.....

NO.	PLATE	NAME
16690	—	Throat Plate Holder 6049 with 16714...
*16850	—	" " " Packing (back)....
*16851	—	" " " " (front)....
16852	—	" " " " Rivet.....
171D	312	" " " Screw.....
6053	380	Drip Pan.....
*15404	—	Trade Mark.....
15405	20883	" " Rivet.....

SINGER Needles should be used in SINGER Machines. These Needles and their Containers are marked with the Company's Trade-Mark "SIMANCO."* 1

Needles in Containers marked "FOR SINGER MACHINES" are NOT **SINGER** made needles. 2

LIST OF PARTS COMPLETE
FOR
MACHINE No. 17-17
FOR MAKING CAPS. HAS 1 5/8 INCH EXTENSION OF BED TO LEFT OF NEEDLE, DROP FEED ACROSS ARM

NO.	PLATE	NAME
*6001	—	Arm with 4448, 4449, 15404 and two 15405.....
4389	3383	Arm Dowel Pin.....
4448	3383	" Oil Tube for intermediate bearing..
123E	312	" Screw.....
4368	364	" Shaft.....
3005	259	" " Bushing (back).....
448c	379	" " " " Set Screw.....
*4449	—	" " " (front).....
144D	3384	" " Screw.....
4288	368	" Side Cover.....
286D	3385	" " " Thumb Screw.....
12403	377	" Spool Pin and Thread Eyelet.....
11241	382	" " " Washer (cloth).....
4370	364	Balance Wheel, heavy rim, 2 3/4 in. pulley, with two 448c.....
2862	364	Balance Wheel, heavy rim, 3 in. pulley, for 3022.....
448c	379	Balance Wheel Set Screw.....
2139	366	" " " Speed Pulley, 1 1/8 in. diam., with 451c.....
2140	366	Balance Wheel Speed Pulley, 2 1/8 in. diam., with 437c.....
451c	3385	Balance Wheel Speed Pulley Set Screw for 2139.....
437c	3385	Balance Wheel Speed Pulley Set Screw for 2140.....
256r	259	Clamp Stop Motion Clamp Screw.....
248A	3385	" " " " Stop Screw..
2020	259	" " " " Washer.....
*3023	—	" " " Flanged Bushing...
4933	259	" " " " " 3023 with two 462c.....
2022	221	Clamp Stop Motion Flanged Bushing Pin.....

NO.	PLATE	NAME
462c	3385	Clamp Stop Motion Flanged Bushing Set Screw.....
3022	—	Clamp Stop Motion complete, Nos. 248A, 256J, 2020 and 4933.....
4292	364	Crank Connecting Rod.....
145E	3384	“ “ “ Cap Screw.....
375c	312	“ “ “ Hinge Screw....
1518J	312	“ “ “ “ “ Nut
*6003	—	Cylinder, 2 7/8 in. diam.....
4343	365	Face Plate.....
56796	—	“ “ 4343 with 2105.....
56775	—	Face Plate complete, Nos. 448c, 460c, 2107, 2111, 2127, 2269, 4369, 56791, 56796 and two 233J.....
164J	312	Face Plate Screw.....
2107	221	“ “ Thread Guard.....
233J	3384	“ “ “ “ Screw.....
3032	259	Feed Cam with 446c.....
446c	312	“ “ Set Screw.....
3033	259	“ Connecting Link.....
375c	312	“ “ “ Hinge Screw....
1518J	312	“ “ “ “ “ Nut
6012	372	“ Dog, (incline feed) for 6042.....
16677	388	“ “ Carrier.....
225c	379	“ “ Screw.....
16638	382	“ Forked Connection.....
375c	312	“ “ “ Hinge Screw....
1518J	312	“ “ “ “ “ Nut
3039	259	“ Regulator.....
58E	312	“ “ Hinge Screw.....
818D	379	“ “ Thumb Screw.....
6017	364	“ Rock Shaft.....
6019	366	“ “ “ Crank with 207F.....
156F	379	“ “ “ “ Position Screw..
207F	3384	“ “ “ “ Set Screw.....
6440	371	Guide (roller), Nos. 1852 and 6441.....
6441	371	“ Bracket.....
1852	371	“ Roller and Screw Stud.....
286D	3385	“ Thumb Screw.....
4264	301	Needle Bar.....
*3045	301	“ “ Connecting Link.....
56773	—	“ “ “ “ “ 3045 with 2052.....
377c	312	Needle Bar Connecting Link Hinge Screw.....
1518J	312	Needle Bar Connecting Link Hinge Screw Nut.....

NO.	PLATE	NAME
2052	374	Needle Bar Connecting Stud with 155c..
155c	3384	“ “ “ “ Set Screw..
290E	3385	“ “ Screw Bushing.....
7524	3383	“ Clamp with 196F, 651J and 7525.
196F	3383	“ “ Screw.....
7525	3383	“ “ Thread Guide.....
651J	3383	“ “ “ “ Screw.....
*6022	367	Oscillating Rock Shaft with 4784.....
16806	—	Oscillating Rock Shaft complete, Nos. 6022 and 56812.....
3052	367	Oscillating Rock Shaft Hinge Pin....
56812	—	“ “ “ “ “ 3052 with 1513J.....
1513J	379	Oscillating Rock Shaft Hinge Pin Nut...
4784	3383	“ “ “ Oil Pad.....
6023	364	“ Shaft.....
*6056	—	“ “ Crank with 460c and 1813.....
6024	377	Oscillating Shaft Crank with 1813 and two 462c.....
2049	221	Oscillating Shaft Crank Pin.....
1813	221	“ “ “ Roller and Stud
460c	3379	“ “ “ Set Screw for 6056.....
462c	3385	Oscillating Shaft Crank Set Screw for 6024.....
3054	301	Presser Bar.....
52016	20879	“ “ Lifter.....
689c	312	“ “ “ Screw.....
1520E	379	“ “ “ Nut.....
5608	259	Presser Bar Lifting Bracket with 453c...
453c	3385	“ “ “ “ Set Screw...
290E	3385	“ “ Screw Bushing.....
3056	301	“ “ Spring (heavy).....
2308	301	“ “ “ (light).....
2070	221	“ “ “ Washer.....
2183	372	“ Foot.....
190J	3384	“ “ Screw.....
262J	312	Pressure Regulating Thumb Screw.....
2073	217	Shuttle Bobbin.....
2211	217	“ “ Retaining Spring.....
2212	217	“ “ “ Rivet..
*6058	—	“ Body with 398E, 2082, 2084, 2211 and two 2212.....
*15458	—	Shuttle Cover.....
125017	—	“ “ 15458 with 112E, 466E, 2078, 2080, 2086 and 2090.....

NO.	PLATE	NAME
2076	217	Shuttle Cover Hinge Pin.....
2078	217	" Delivery Eye Thread Guard....
2080	217	" " " " " Rivet
2082	217	" Main Spring.....
398E	217	" " " Screw.....
2084	217	" " " Steady Pin.....
466u	217	" Tension Regulating Screw.....
2086	217	" " Spring.....
2090	217	" " " Plate.....
112E	217	" " " Screw.....
16892	20880	Shuttle (high point) complete, Nos. 2073, 2076, 6058 and 125017.....
6029	367	Shuttle Driver and Feed Lifting Cam...
2049	221	" " " " " Pin
6033	368	" Race Ring with 6036 and two 6037.....
16688	—	Shuttle Race Ring Cover.....
16689	382	" " " " 16688 with 16242 and two 725j.....
16242	20880	Shuttle Race Ring Cover Latch.....
725j	312	" " " " " Screw...
50250j	3388	" " " " " Screw.....
6036	375	" " " Feed Plate.....
6037	3383	" " " " " Rivet.....
175j	3384	" " " " " Screw.....
2102	377	Tension Disc.....
1560c	379	" Regulating Thumb Nut.....
4369	377	" Releaser.....
2269	377	" " Hinge Pin.....
600c	379	" Screw Stud.....
16202	—	" " " 600c with 1560c....
448c	379	" " " Set Screw.....
2103	377	" Spring.....
2105	377	" Thread Guard.....
56791	—	Tension complete, Nos. 2103, 2124, 16202 and two 2102.....
2112	221	Thread Retaining Disc with 2113.....
2113	221	" " " Steady Pin.....
2114	221	" " " Spring.....
2115	221	" " " Stud.....
460c	3379	" " " Set Screw.....
2111	221	Thread Retainer Guide complete, Nos. 2112, 2114 and 2115.....
*56831	—	Thread Take-up Cam.....
3280	382	" " " 56831 with 446c..
3012	297	" " " Pin.....
446c	312	" " " Set Screw.....

NO.	PLATE	NAME
*3072	259	Thread Take-up Lever with 1819.....
56855	—	" " " 3072 with 1088c
1088c	3388	" " " Hinge Screw.....
1819	379	" " " Roller and Stud
2124	221	" " " Spring.....
2127	221	" " " Regulator Plate
233j	3384	" " " " "
		Adjusting Screw.....
6042	372	Throat Plate for 6012.....
6046	368	" " Holder with 16848, 16849 and four 16852.....
6047	—	Throat Plate Holder 6046 with 6042....
6048	368	" " " Extension.....
*16848	—	" " " Packing (back)....
*16849	—	" " " " (front)....
16852	—	" " " Rivet.....
401j	3385	" " " Extension Screw...
171D	312	" " " Screw.....
6053	380	Drip Pan.....
*15404	—	Trade Mark.....
15405	20883	" " Rivet.....

SINGER Needles should be used
in SINGER Machines.
These Needles and their Containers
are marked with the
Company's Trade-Mark "SIMANCO.***" 1

Needles in Containers marked
"FOR SINGER MACHINES"
are NOT **SINGER** made needles. 2

LIST OF PARTS COMPLETE

FOR

MACHINE No. 17-18

DROP FEED, SPECIAL THROAT PLATE AND
FEED FOR HELMET WORK.

NO.	PLATE	NAME
*16775	—	Arm with 4448, 4449, 15404 and two 15405.....
4380	3383	Arm Dowel Pin.....
4448	3383	" Oil Tube for intermediate bearing..
123E	312	" Screw.....
6109	364	" Shaft for 3011.....
6107	364	" " " 5977.....
3005	259	" " Bushing (back).....
448c	379	" " " " Set Screw....
*4449	—	" " " (front).....
144d	3384	" " Screw.....
4288	368	" Side Cover.....
286d	3385	" " " Thumb Screw.....
12403	377	" Spool Pin and Thread Eyelet.....
11241	382	" " " Washer (cloth).....
3011	3364	Balance Wheel (two speed) 3 in. and 5 in. pulleys, with two 448c.....
5977	3364	Balance Wheel (two speed) 3 in. and 5 in. pulleys, for 5981.....
448c	379	Balance Wheel Set Screw.....
4292	364	Crank Connecting Rod.....
145E	3384	" " " Cap Screw.....
375c	312	" " " " Hinge Screw....
1518J	312	" " " " " Nut
*16842	—	Cylinder, 2 7/8 in. diam.....
5978	366	Driving Flange with two 435c.....
5993	—	Driving Flange complete, Nos. 136F, 330J and 5978 to 5980.....
5979	377	Driving Flange Latch.....
136F	379	" " " " Hinge Screw....
5980	377	" " " " Spring.....
330J	379	" " " " Screw.....
435c	379	" " " " Set Screw.....
5981	—	Loose Wheel Attachment complete, Nos. 5977 and 5993.....
4343	365	Face Plate.....
56796	—	" " 4343 with 2105.....

NO.	PLATE	NAME
56775	—	Face Plate complete, Nos. 448c, 460c, 2107, 2111, 2127, 2269, 4369, 56791, 56796 and two 233J.....
164J	312	Face Plate Screw.....
2107	221	" " Thread Guard.....
233J	3384	" " " " Screw.....
3032	259	Feed Cam with 446c.....
446c	312	" " Set Screw.....
3033	259	" Connecting Link.....
375c	312	" " " " Hinge Screw....
1518J	312	" " " " " Nut
16843	3390	" Dog, 12 teeth, for 16844.....
6016	366	" " Carrier.....
225c	379	" " Screw.....
16638	382	" Forked Connection.....
375c	312	" " " " Hinge Screw....
1518J	312	" " " " " Nut
3039	259	" Regulator.....
58E	312	" " " Hinge Screw....
818D	379	" " " Thumb Screw....
6017	364	" Rock Shaft.....
6019	366	" " " Crank with 207F.....
156F	379	" " " " Position Screw..
207F	3384	" " " " Set Screw.....
4264	301	Needle Bar.....
*3045	301	" " Connecting Link.....
56773	—	" " " " 3045 with 2052.....
377c	312	Needle Bar Connecting Link Hinge Screw.....
1518J	312	Needle Bar Connecting Link Hinge Screw Nut.....
2052	374	Needle Bar Connecting Stud with 155c..
155c	3384	" " " " Set Screw..
290E	3385	" " Screw Bushing.....
7524	3383	" Clamp with 196F, 651J and 7525
196F	3383	" " Screw.....
7525	3383	" " Thread Guide.....
651J	3383	" " " " Screw.....
6436	370	Oil Cup with 1111E and three 6437.....
1111E	3385	" " Screw Stud.....
6437	3383	" " Thread Eyelet.....
*6022	367	Oscillating Rock Shaft with 4784.....
16806	—	Oscillating Rock Shaft complete, Nos. 6022 and 56812.....
3052	367	Oscillating Rock Shaft Hinge Pin.....

100 PARTS FOR MACHINE No. 17-18

NO.	PLATE	NAME
56812	—	Oscillating Rock Shaft Hinge Pin 3052 with 1513j.....
1513j	379	Oscillating Rock Shaft Hinge Pin Nut...
4784	3383	" " " Oil Pad.....
6023	364	" Shaft.....
*6056	—	" " Crank with 460c and 1813.....
6024	377	Oscillating Shaft Crank with 1813 and two 462c.....
2049	221	Oscillating Shaft Crank Pin.....
1813	221	" " " Roller and Stud
460c	3379	" " " Set Screw for 6056.....
462c	3385	Oscillating Shaft Crank Set Screw for 6024.....
3054	301	Presser Bar.....
52016	20879	" " " Lifter.....
689c	312	" " " Screw.....
1520E	379	" " " " Nut.....
5608	259	" " " Lifting Bracket with 453c...
453c	3385	" " " " Set Screw...
290E	3385	" " " Screw Bushing.....
3056	301	" " " Spring (heavy).....
2308	301	" " " (light).....
2070	221	" " " Washer.....
2180	372	" Foot.....
190j	3384	" " Screw.....
262j	312	Pressure Regulating Thumb Screw.....
1868	231	Roller, 1/8 in. diam., coarse, with 652D and 1528j, for 2196.....
1841	—	Roller 1/8 in. diam., fine, with 652D and 1528j, for 2197.....
2203	231	Roller Arm.....
440F	231	" " Adjusting Screw.....
1547j	231	" " " " Nut.....
2206	231	" " " Bracket.....
316F	231	" " " Screw Center.....
15444	—	" " " " " 316F with 1547j.....
1547j	231	Roller Arm Bracket Screw Center Nut..
2205	231	" " " Lock Spring.....
176j	231	" " " " " Screw.....
1549j	231	" " " " " Nut.....
2196	3371	Roller Presser complete, 1/8 in. coarse roller, Nos. 176j, 440F, 1547j, 1549j, 1868, 2203, 2205, 2206 and two 15444

PARTS FOR MACHINE No. 17-18 101

NO.	PLATE	NAME
2197	—	Roller Presser complete, 1/8 in. fine roller, Nos. 176j, 440F, 1547j, 1549j, 1841, 2203, 2205, 2206 and two 15444.....
NOTE: No. 2197 is sent with this machine unless another Roller Presser is specified on order.		
190j	3384	Roller Presser Screw.....
652D	3385	" Screw.....
1528j	3386	" " Nut.....
2073	217	Shuttle Bobbin.....
2211	217	" " Retaining Spring.....
2212	217	" " " " Rivet..
*6058	—	" Body with 398E, 2082, 2084, 2211 and two 2212.....
*15458	—	Shuttle Cover.....
125017	—	" " 15458 with 112E, 466H, 2078, 2080, 2086 and 2090.....
2076	217	Shuttle Cover Hinge Pin.....
2078	217	" Delivery Eye Thread Guard....
2080	217	" " " " Rivet....
2082	217	" Main Spring.....
398E	217	" " " Screw.....
2084	217	" " " Steady Pin.....
466H	217	" Tension Regulating Screw.....
2086	217	" " Spring.....
2090	217	" " " Plate.....
112E	217	" " " " Screw.....
16892	20880	Shuttle (high point) complete, Nos. 2073, 2076, 6058 and 125017.....
6029	367	Shuttle Driver and Feed Lifting Cam...
2049	221	" " " " " Pin
16885	—	" Race Ring.....
16886	3391	" " " 16885 with 65059 and two 337j.....
16688	—	Shuttle Race Ring Cover.....
16689	382	" " " " 16688 with 16242 and two 725j.....
16242	20880	Shuttle Race Ring Cover Latch.....
725j	312	" " " " " Screw...
50250j	3388	" " " " " Screw.....
175j	3384	" " " " " Screw.....
65059	20879	" " " Thread Protector...
337j	3385	" " " " " Screw
2102	377	Tension Disc.....
1560c	379	" Regulating Thumb Nut.....
4369	377	" Releaser.....
2269	377	" " Hinge Pin.....

NO.	PLATE	NAME
600c	379	Tension Screw Stud
16202	—	“ “ “ 600c with 1560c....
448c	379	“ “ “ Set Screw.....
2103	377	“ Spring.....
2105	377	“ Thread Guard.....
56791	—	Tension complete, Nos. 2103, 2124, 16202 and two 2102.....
2112	221	Thread Retaining Disc with 2113.....
2113	221	“ “ “ Steady Pin.....
2114	221	“ “ Spring.....
2115	221	“ “ Stud.....
460c	3379	“ “ “ Set Screw.....
2111	221	Thread Retainer Guide complete, Nos. 2112, 2114 and 2115.....
*56831	—	Thread Take-up Cam.....
3280	382	“ “ “ 56831 with 446c..
3012	297	“ “ “ Pin.....
446c	312	“ “ “ Set Screw.....
*3072	259	“ “ Lever with 1819.....
56855	—	“ “ “ 3072 with 1088c..
1088c	3388	“ “ “ Hinge Screw.....
1819	379	“ “ “ Roller and Stud
2124	221	“ “ Spring.....
2127	221	“ “ Regulator Plate
233J	3384	“ “ “ “ “
		Adjusting Screw.....
16844	3390	Throat Plate for 16843, for 16842.....
401D	3385	“ “ Screw.....
6053	380	Drip Pan.....
*15404	—	Trade Mark.....
15405	20883	“ “ Rivet.....

SINGER Needles should be used in SINGER Machines. These Needles and their Containers are marked with the Company's Trade-Mark "SIMANCO.***" 1

Needles in Containers marked "FOR SINGER MACHINES" are NOT **SINGER** made needles. 2

LIST OF PARTS COMPLETE

FOR

MACHINE No. 17-19

FOR STITCHING CLOSE TO A SHOULDER AND IN CORNERS. NEEDLE DESCENDS $\frac{3}{8}$ IN. FROM END OF BED. DROP FEED ACROSS ARM AT RIGHT OF NEEDLE.

NO.	PLATE	NAME
*6001	—	Arm with 4448, 4449, 15404 and two 15405.....
4389	3383	Arm Dowel Pin.....
4448	3383	“ Oil Tube for intermediate bearing..
123E	312	“ Screw.....
4368	364	“ Shaft.....
3005	259	“ “ Bushing (back).....
448c	379	“ “ “ “ Set Screw....
*4449	—	“ “ “ (front).....
144D	3384	“ “ Screw.....
4288	368	“ Side Cover.....
286D	3385	“ “ Thumb Screw.....
12403	377	“ Spool Pin and Thread Eyelet.....
11241	382	“ “ “ Washer (cloth).....
4370	364	Balance Wheel, heavy rim, $2\frac{3}{4}$ in. pulley, with two 448c.....
2862	364	Balance Wheel, heavy rim, 3 in. pulley, for 3022.....
448c	379	Balance Wheel Set Screw.....
2139	366	Balance Wheel Speed Pulley, $1\frac{1}{8}$ in. diam., with 451c.....
2140	366	Balance Wheel Speed Pulley, $2\frac{1}{8}$ in. diam., with 437c.....
451c	3385	Balance Wheel Speed Pulley Set Screw for 2139.....
437c	3385	Balance Wheel Speed Pulley Set Screw for 2140.....
256J	259	Clamp Stop Motion Clamp Screw.....
248A	3385	“ “ “ “ Stop Screw..
2020	259	“ “ “ “ Washer.....
*3023	—	“ “ “ Flanged Bushing...
4933	259	“ “ “ “ “ 3023 with two 462c.....
2022	221	Clamp Stop Motion Flanged Bushing Pin.....

NO.	PLATE	NAME
462c	3385	Clamp Stop Motion Flanged Bushing Set Screw.....
3022	—	Clamp Stop Motion complete, Nos. 248A, 256J, 2020 and 4933.....
4292	364	Crank Connecting Rod.....
145E	3384	" " " Cap Screw.....
375c	312	" " " Hinge Screw.....
1518J	312	" " " " " Nut
*16853	—	Cylinder, 2 1/8 in. diam.....
16776	—	" End Cover.....
16663	389	" " " 16776 with 16242 and two 240J.....
16242	20880	Cylinder End Cover Latch.....
240J	385	" " " " Screw.....
51133w	20883	" " " " Screw (left).....
108w	3385	" " " " " (right).....
4343	365	Face Plate.....
56796	—	" " 4343 with 2105.....
56775	—	Face Plate complete, Nos. 448c, 460c, 2107, 2111, 2127, 2269, 4369, 56791, 56796 and two 233J.....
164J	312	Face Plate Screw.....
2107	221	" " Thread Guard.....
233J	3384	" " " " Screw.....
3032	259	Feed Cam with 446c.....
446c	312	" " Set Screw.....
3033	259	" Connecting Link.....
375c	312	" " Hinge Screw.....
1518J	312	" " " " " Nut
16856	3390	" Dog, 10 teeth, for leather, for 16857

NOTE: 16856 is sent with this machine unless another Feed Dog is specified on order.

16854	3390	Feed Dog, 12 teeth, for cloth, for 16855.
6016	366	" " Carrier.....
225c	379	" " Screw.....
16638	382	Forked Connection.....
375c	312	" " " Hinge Screw...
1518J	312	" " " " " Nut
3039	259	" Regulator.....
58E	312	" " Hinge Screw.....
818D	379	" " Thumb Screw.....
6017	364	" Rock Shaft.....
6019	366	" " Crank with 207F.....
156F	379	" " " " Position Screw..
207F	3384	" " " " Set Screw.....
16642	382	Needle Bar with 10160.....

NO.	PLATE	NAME
*3045	301	Needle Bar Connecting Link.....
56773	—	" " " " 3045 with 2052.....
377c	312	Needle Bar Connecting Link Hinge Screw.....
1518J	312	Needle Bar Connecting Link Hinge Screw Nut.....
2052	374	Needle Bar Connecting Stud with 155c..
155c	3384	" " " " Set Screw..
290E	3385	" " Screw Bushing.....
16643	385	" " Thread Guard.....
240J	385	" " " " Screw.....
16644	385	" Clamp with 1112F.....
1112F	385	" " Screw.....
10160	3383	" Stop Pin.....
*6022	367	Oscillating Rock Shaft with 4784.....
16806	—	Oscillating Rock Shaft complete, Nos. 6022 and 56812.....
3052	367	Oscillating Rock Shaft Hinge Pin....
56812	—	" " " " " 3052 with 1513J.....
1513J	379	Oscillating Rock Shaft Hinge Pin Nut...
4784	3383	" " " Oil Pad.....
7044	3366	" Shaft.....
*6056	—	" " Crank with 460c and 1813.....
6024	377	Oscillating Shaft Crank with 1813 and two 462c.....
2049	221	Oscillating Shaft Crank Pin.....
1813	221	" " " Roller and Stud
460c	3379	" " " " Set Screw for 6056.....
462c	3385	Oscillating Shaft Crank Set Screw for 6024.....
3054	301	Presser Bar.....
52016	20879	" " Lifter.....
689c	312	" " " Screw.....
1520E	379	" " " Nut.....
5608	259	" " Lifting Bracket with 453c...
453c	3385	" " " " Set Screw...
290E	3385	" " Screw Bushing.....
3056	301	" " Spring (heavy).....
2308	301	" " " (light).....
2070	221	" " " Washer.....
6069	376	" Foot.....
190J	3384	" " Screw.....
262J	312	Pressure Regulating Thumb Screw.....

NO.	PLATE	NAME
1868	231	Roller, $\frac{3}{8}$ in. diam., coarse, with 652b and 1528J, for 6070.....
1841	—	Roller, $\frac{3}{8}$ in. diam., fine, with 652b and 1528J, for 6071.....
6072	389	Roller Arm.....
440F	231	“ “ Adjusting Screw.....
1547J	231	“ “ “ “ Nut.....
6073	385	“ “ Bracket.....
316F	231	“ “ “ “ Screw Center.....
15444	—	“ “ “ “ “ “ 3 1 6 F with 1547J.....
1547J	231	Roller Arm Bracket Screw Center Nut..
2205	231	“ “ Lock Spring.....
176J	231	“ “ “ “ Screw.....
1549J	231	“ “ “ “ “ Nut.....
6070	—	Roller Presser complete, $\frac{3}{8}$ in. coarse roller, Nos. 176J, 440F, 1547J, 1549J, 1868, 2205, 6072, 6073 and two 15444
6071	378	Roller Presser complete, $\frac{3}{8}$ in. fine roller, Nos. 176J, 440F, 1547J, 1549J, 1841, 2205, 6072, 6073 and two 15444.....
NOTE: No. 6071 is sent with this machine unless another Roller Presser is specified on order.		
190J	3384	Roller Presser Screw.....
652b	3385	“ “ Screw.....
1528J	3386	“ “ Nut.....
2210	217	Shuttle Bobbin.....
3230	302	“ “ Retaining Spring.....
2212	217	“ “ “ “ Rivet..
*3383	—	“ “ Body with 398E, 2084, 3230, 3239 and two 2212.....
*6945	—	Shuttle Cover.....
17418	—	“ “ 6945 with 112E, 466H, 2080, 3238, 3241 and 3242.....
2076	217	Shuttle Cover Hinge Pin.....
3238	302	“ Delivery Eye Thread Guard.....
2080	217	“ “ “ “ “ Rivet
3239	302	“ Main Spring.....
398E	217	“ “ “ Screw.....
2084	217	“ “ “ Steady Pin.....
466H	217	“ Tension Regulating Screw.....
3241	302	“ “ Spring.....
3242	302	“ “ “ Plate.....
112E	217	“ “ “ “ Screw.....
6909	389	Shuttle (closed eye) complete, Nos. 2076, 2210, 3383 and 17418.....

NO.	PLATE	NAME
16662	389	Shuttle Driver and Feed Lifting Cam....
2049	221	“ “ “ “ “ Pin
2102	377	Tension Disc.....
1560c	379	“ Regulating Thumb Nut.....
4369	377	“ Releaser.....
2269	377	“ “ Hinge Pin.....
600c	379	“ Screw Stud.....
16202	—	“ “ “ 600c with 1560c.....
448c	379	“ “ “ Set Screw.....
2103	377	“ Spring.....
2105	377	“ Thread Guard.....
56791	—	Tension complete, Nos. 2103, 2124, 16202 and two 2102.....
2112	221	Thread Retaining Disc with 2113.....
2113	221	“ “ “ Steady Pin.....
2114	221	“ “ Spring.....
2115	221	“ “ Stud.....
460c	3379	“ “ “ Set Screw.....
2111	221	“ Retainer Guide complete, Nos. 2112, 2114 and 2115.....
*56831	—	Thread Take-up Cam.....
3280	382	“ “ “ 56831 with 446c...
3012	297	“ “ “ Pin.....
446c	312	“ “ “ Set Screw.....
*3072	259	“ “ “ Lever with 1819.....
56855	—	“ “ “ 3072 with 1088c...
1088c	3388	“ “ “ Hinge Screw.....
1819	379	“ “ “ Roller and Stud...
2124	221	“ “ Spring.....
2127	221	“ “ “ Regulator Plate
233J	3384	“ “ “ “ “
		Adjusting Screw.....
16857	3390	Throat Plate for 16856.....
16855	3390	“ “ “ 16854.....
401b	3385	“ “ “ Screw.....
6053	380	Drip Pan.....
*15404	—	Trade Mark.....
15405	20833	“ “ Rivet.....

**LIST OF PARTS COMPLETE
FOR
MACHINE No. 17-20**

**DROP FEED. ALTERNATING PRESSERS. FOR
HORSE BOOTS AND OTHER CONCAVE OR
CONVEX ARTICLES IN LEATHER**

NO.	PLATE	NAME
*65022	—	Arm with 4448, 4449, 15404 and two 15405
4389	3383	" Dowel Pin.....
4448	3383	" Oil Tube for intermediate bearing...
123E	312	" Screw.....
6178	3364	" Shaft for 3011.....
6179	3364	" " " 5977.....
3005	259	" " Bushing (back).....
448c	379	" " " " Set Screw....
*4449	—	" " " (front).....
144b	3384	" " Screw.....
4288	368	" Side Cover.....
286b	3385	" " " Thumb Screw.....
12403	377	" Spool Pin and Thread Eyelet.....
11241	382	" " " Washer (cloth).....
3011	3364	Balance Wheel (two-speed) 3 in. and 5 in. pulleys, with two 448c.....
5977	3364	Balance Wheel (two-speed) 3 in. and 5 in. pulleys, for 5981.....
448c	379	Balance Wheel Set Screw.....
4292	364	Crank Connecting Rod.....
145E	3384	" " " Cap Screw.....
375c	312	" " " Hinge Screw.....
1518J	312	" " " " " Nut..
*6110	—	Cylinder, 2 $\frac{1}{8}$ in. diam.....
6111	382	" Feed Cover.....
337J	3385	" " " Screw.....
5978	366	Driving Flange with two 435c.....
5993	—	Driving Flange complete, Nos. 136F, 330J and 5978 to 5980.....
5979	377	Driving Flange Latch.....
136F	379	" " " Hinge Screw.....
5980	377	" " " Spring.....
330J	379	" " " " Screw.....
435c	379	" " " Set Screw.....
5981	—	Loose Wheel Attachment complete, Nos. 5977 and 5993.....
56871	20876	Face Plate.....

NO.	PLATE	NAME
56872	—	Face Plate 56871 with 2105.....
56873	—	Face Plate complete, Nos. 448c, 460c, 2111, 2127, 2269, 4378, 56791, 56870, 56872 and two 233J.....
175J	3384	Face Plate Screw.....
56870	20879	" " Thread Guard.....
233J	3384	" " " " Screw.....
3032	259	Feed Cam with 446c.....
446c	312	" " Set Screw.....
3033	259	" Connecting Link.....
375c	312	" " " Hinge Screw.....
1518J	312	" " " " " Nut..
6112	371	" Dog, 12 teeth, for 6120 and 6449...
6016	366	" Carrier.....
225c	379	" " Screw.....
3037	364	" Forked Connection.....
375c	312	" " " Hinge Screw.....
1518J	312	" " " " " Nut
3039	259	" Regulator.....
1128E	20883	" " Hinge Screw.....
818b	379	" " Thumb Screw.....
6114	364	" Rock Shaft.....
6018	366	" " Crank with 207F.....
156F	379	" " " " Position Screw...
207F	3384	" " " " Set Screw.....
3126	259	Guide Bar.....
56752	—	" " 3126 with 2361 and two 2362...
56844	—	" " 56752 with 337J and 3137.....
4730	—	Guide Bar complete, Nos. 810b, 810E, 3134, 4723, 4897, 56844 and three 404J..
4854	389	Guide Bar Driving Crank with 1862 and 3131.....
1862	297	Guide Bar Driving Crank Roller (roller only).....
3131	297	Guide Bar Driving Crank Roller Cap....
3094	297	" " " " Wedge.....
690E	312	" " " " " Screw...
4723	389	" " Lifting Bracket.....
404J	3385	" " " " Screw.....
2058	3365	Lifting Presser Bar.....
3133	259	" " " Bracket with 641E and 1823.....
641E	3384	Lifting Presser Bar Bracket Clamping Screw.....
1823	221	Lifting Presser Bar Bracket Roller and Stud.....

NO.	PLATE	NAME
4855	3366	Lifting Presser Bar Lifter.....
598c	3385	" " " " Screw.....
4725	3365	" " " Lifting Bracket.....
4726	3383	" " " " " Guide Pin.....
3100	301	Lifting Presser Bar Spring.....
2070	221	" " " " Washer.....
2358	259	" " Foot.....
193j	20883	" " " Screw.....
4264	301	Needle Bar.....
*4898	3367	" " Connecting Link with 390E...
56764	—	" " " " 4898 with 15472.....
390E	3385	Needle Bar Connecting Link Adjusting Screw.....
15472	3389	Needle Bar Connecting Stud with 155c...
155c	3384	" " " " Set Screw...
4265	302	" Clamp with 196F.....
4865	3383	Needle Clamp complete, Nos. 651J, 4265 and 4266.....
196F	3383	Needle Clamp Screw.....
4266	302	" " Thread Guide.....
651J	3383	" " " " Screw.....
*6022	367	Oscillating Rock Shaft with 4784.....
16806	—	Oscillating Rock Shaft complete, Nos. 6022 and 56812.....
3052	367	Oscillating Rock Shaft Hinge Pin.....
56812	—	" " " " " 3 0 5 2 with 1513J.....
1513J	379	Oscillating Rock Shaft Hinge Pin Nut....
4784	3383	" " " Oil Pad.....
6023	364	" Shaft.....
*6056	—	" " Crank with 460c and 1813.....
6024	377	Oscillating Shaft Crank with 1813 and two 462c.....
2049	221	Oscillating Shaft Crank Pin.....
1813	221	" " " Roller and Stud..
460c	3379	" " " Set Screw for 6056
462c	3385	" " " " " 6024
262J	312	Pressure Regulating Thumb Screw.....
2073	217	Shuttle Bobbin.....
2211	217	" " Retaining Spring.....
2212	217	" " " " Rivet....
*6058	—	" Body with 398E, 2082, 2084, 2211 and two 2212.....
*15458	—	Shuttle Cover.....

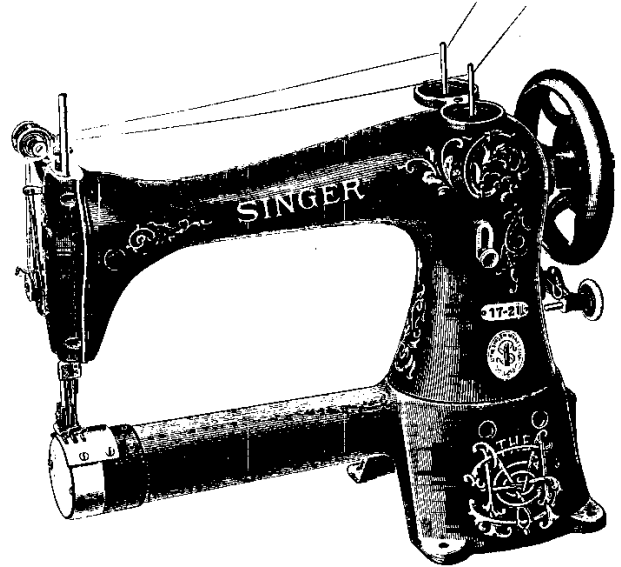
NO.	PLATE	NAME
125017	—	Shuttle Cover 15458 with 112E, 466H, 2078, 2080, 2086 and 2090.....
2076	217	Shuttle Cover Hinge Pin.....
2078	217	" Delivery Eye Thread Guard.....
2080	217	" " " " Rivet
2082	217	" Main Spring.....
398E	217	" " " Screw.....
2084	217	" " " Steady Pin.....
466H	217	" Tension Regulating Screw.....
2086	217	" " Spring.....
2090	217	" " " Plate.....
112E	217	" " " " Screw.....
16892	20880	Shuttle (high point) complete, Nos. 2073, 2076, 6058 and 125017.....
6029	367	Shuttle Driver and Feed Lifting Cam....
2049	221	" " " " " Pin.
16769	—	" Race Ring.....
6118	367	" " " 16769 with 6119 and two 241J.....
16771	—	Shuttle Race Ring Cover.....
16772	382	" " " " 16771 with 16242 and two 240J.....
16242	20880	Shuttle Race Ring Cover Latch.....
240J	385	" " " " " Screw....
50250J	3388	" " " " Screw.....
175J	3384	" " " Screw.....
6119	375	" " " Thread Protector.....
241J	3384	" " " " " Screw
2102	377	Tension Disc.....
1560c	379	" Regulating Thumb Nut.....
4378	3367	" Releaser.....
2269	377	" " Hinge Pin.....
600c	379	" Screw Stud.....
16202	—	" " " 600c with 1560c....
448c	379	" " " Set Screw.....
2103	377	" Spring.....
2105	377	" Thread Guard.....
56791	—	Tension complete, Nos. 2103, 2124, 16202 and two 2102.....
2112	221	Thread Retaining Disc with 2113.....
2113	221	" " " Steady Pin.....
2114	221	" " Spring.....
2115	221	" " Stud.....
460c	3379	" " " Set Screw.....
2111	221	Thread Retainer Guide complete, Nos. 2112, 2114 and 2115.....

NO.	PLATE	NAME
*65003	—	Thread Take-up Cam.....
6450	382	" " " 65003 with 446c...
3012	297	" " " Pin.....
446c	312	" " " Set Screw.....
*3072	259	" " Lever with 1819.....
56855	—	" " " 3072 with 1088c..
1088c	3388	" " " Hinge Screw.....
1819	379	" " " Roller and Stud...
2124	221	" " Spring.....
2127	221	" " Regulator Plate
233j	3384	" " " " " "
		Adjusting Screw.....
6120	371	Throat Plate, large needle hole, for 6112..
6449	—	" " small needle hole, for 6112..
223d	312	" " Screw.....
3134	259	Vibrating Presser Bar.....
2361	259	" " " Hinge Bracket.....
2362	221	" " " " Rivet
810d	379	" " " " Cap Screw..
4897	3365	" " " Lifting Bell Crank
810e	379	" " " " " "
		Hinge Cap Screw.....
3137	259	Vibrating Presser Bar Spring.....
337j	3385	" " " " Screw.....
3136	259	" " Foot.....
217j	3384	" " " Screw.....
6053	380	Drip Pan.....
*15404	—	Trade Mark.....
15405	20883	" " Rivet.....

SINGER Needles should be used in SINGER Machines. These Needles and their Containers are marked with the Company's Trade-Mark "SIMANCO."* 1

Needles in Containers marked "FOR SINGER MACHINES" are NOT SINGER made needles. 2

LIST OF PARTS COMPLETE FOR



MACHINE No. 17-21

TWO SHUTTLES, DROP FEED ACROSS ARM, ALTERNATING PRESSERS, GAUGES FROM 1/8 INCH TO 3/4 INCH. CLOTH OR LEATHER.

NO.	PLATE	NAME
*6271	—	Arm with 4448, 4449, 15404 and two 15405
4389	3383	" Dowel Pin.....
4448	3383	" Oil Tube for intermediate bearing...
123e	312	" Screw.....
4359	3364	" Shaft.....
3005	259	" " Bushing (back).....
448c	379	" " " Set Screw.....
*4449	—	" " " (front).....
144d	3384	" " Screw.....

NO.	PLATE	NAME
4288	368	Arm Side Cover.....
286D	3385	" " " Thumb Screw.....
2415	366	" Spool Bracket.....
15063	366	" " " 2415 with two 12403..
145J	3384	" " " Screw.....
12403	377	" " " Spool Pin and Thread Eyelet.....
11241	382	Arm Spool Bracket Spool Pin Washer (cloth).....
4370	364	Balance Wheel, heavy rim, 2 $\frac{3}{4}$ in. pulley, with two 448c.....
2862	364	Balance Wheel, heavy rim, 3 in. pulley, for 3022.....
448c	379	Balance Wheel Set Screw.....
2139	366	" " Speed Pulley, 1 $\frac{1}{8}$ in. diam., with 451c.....
2140	366	Balance Wheel Speed Pulley, 2 $\frac{1}{8}$ in. diam., with 437c.....
451c	3385	Balance Wheel Speed Pulley Set Screw for 2139.....
437c	3385	Balance Wheel Speed Pulley Set Screw for 2140.....
256J	259	Clamp Stop Motion Clamp Screw.....
248A	3385	" " " " Stop Screw...
2020	259	" " " " Washer.....
*3023	—	" " " Flanged Bushing....
4933	259	" " " " " 3023 with two 462c.....
2022	221	Clamp Stop Motion Flanged Bushing Pin.....
462c	3385	Clamp Stop Motion Flanged Bushing Set Screw.....
3022	—	Clamp Stop Motion complete, Nos. 248A, 256J, 2020 and 4933.....
4292	364	Crank Connecting Rod.....
145E	3384	" " " " Cap Screw.....
375c	312	" " " " Hinge Screw....
1518J	312	" " " " " " Nut
*6181	—	Cylinder, 2 $\frac{1}{8}$ in. diam.....
4834	3364	Face Plate.....
56817	—	" " 4834 with 2105.....
56818	—	Face Plate complete, Nos. 86D, 233J, 330J, 448c, 808F, 809c, 2108, 2127, 2248, 2410, 2411, 4377, 56817, two each 1560c, 2103 and four 2102.....
175J	3384	Face Plate Screw.....
2108	221	" " Thread Guard.....

NO.	PLATE	NAME
3032	259	Feed Cam with 446c.....
446c	312	" " Set Screw.....
3033	259	" Connecting Link.....
375c	312	" " " Hinge Screw....
1518J	312	" " " " " Nut.
6182	376	" Dog, 12 teeth (one row of teeth) for $\frac{1}{16}$ in. to $\frac{3}{8}$ in. gauges, for leather....
6183	3353	Feed Dog, 12 teeth (two rows of teeth) for $\frac{3}{16}$ in. to $\frac{1}{4}$ in. gauges, for general work
6184	3353	Feed Dog, 12 teeth (three rows of teeth) for $\frac{1}{8}$ in. to $\frac{1}{8}$ in. gauges, for general work
16762	3353	Feed Dog, 12 teeth (four rows of teeth) for $\frac{1}{4}$ in. to $\frac{3}{8}$ in. gauges, for general work
16764	3354	Feed Dog, 12 teeth (five rows of teeth) for $\frac{3}{16}$ in. to $\frac{3}{4}$ in. gauges, for general work
6016	366	Feed Dog Carrier.....
225c	379	" " Screw.....
3037	364	" Forked Connection.....
375c	312	" " " Hinge Screw....
1518J	312	" " " " " Nut
3039	259	" Regulator.....
58E	312	" " Hinge Screw.....
818D	379	" " Thumb Screw.....
6017	364	" Rock Shaft.....
6018	366	" " Crank with 207F.....
156F	379	" " " " Position Screw..
207F	3384	" " " " Set Screw.....
3126	259	Guide Bar.....
*56752	—	" " 3126 with 2361 and two 2362.
56844	—	" " 56752 with 337J and 3137....
4730	—	Guide Bar complete, Nos. 810D, 810E, 3134, 4723, 4897, 56844 and three 404J
4854	389	Guide Bar Driving Crank with 1862 and 3131.....
1862	297	Guide Bar Driving Crank Roller (roller only).....
3131	297	Guide Bar Driving Crank Roller Cap...
3094	297	" " " " Wedge.....
690E	312	" " " " " Screw
4723	389	" " Lifting Bracket.....
404J	3385	" " " " Screw.....
2058	3365	Lifting Presser Bar.....
3133	259	" " " Bracket with 641E and 1823.....
641E	3384	Lifting Presser Bar Bracket Clamping Screw.....

NO.	PLATE	NAME
1823	221	Lifting Presser Bar Bracket Roller and Stud.....
4855	3366	Lifting Presser Bar Lifter.....
598c	3385	" " " " Screw.....
4668	3365	" " " " Lifting Bracket.....
4726	3383	" " " " " Guide Pin.....
3100	301	Lifting Presser Bar Spring.....
2070	221	" " " " Washer.....
4662	3374	" " " " Foot.....
193j	20883	" " " " Screw.....
4344	3365	Needle Bar.....
*4898	3367	" " Connecting Link with 390E..
56764	—	" " " " 4898 with 15472.....
390E	3385	Needle Bar Connecting Link Adjusting Screw.....
15472	3389	Needle Bar Connecting Stud with 155c..
155c	3384	" " " " Set Screw..
4783	377	" Clamp with two 336F, for $\frac{1}{8}$ in. and $\frac{3}{8}$ in. gauges.....
4496	377	Needle Clamp with two 460c, for $\frac{3}{8}$ in. gauge and above.....
2273	3383	Needle Clamp Pin.....
336F	3384	" Set Screw for 4783.....
460F	3379	" " " " 4496.....
*6022	367	Oscillating Rock Shaft with 4784.....
16806	—	Oscillating Rock Shaft complete, Nos. 6022 and 56812.....
3052	367	Oscillating Rock Shaft Hinge Pin.....
56812	—	" " " " " " 3 0 5 2 with 1513j.....
1513j	379	Oscillating Rock Shaft Hinge Pin Nut...
4784	3383	" " " " Oil Pad.....
7044	3366	" Shaft.....
*6520	—	" " Crank with 1813.....
6532	377	" " " " 6520 with two 462c.....
2049	221	Oscillating Shaft Crank Pin.....
1813	221	" " " " Roller and Stud
462c	3385	" " " " Set Screw.....
262j	312	Pressure Regulating Thumb Screw.....
2210	217	Shuttle (inside) Bobbin.....
3230	302	" " " " Retaining Spring
2212	217	" " " " " " Rivet.....

NO.	PLATE	NAME
*3231	—	Shuttle (inside) Body with 398E, 2084 and 3239, for 3225.....
*3232	—	Shuttle (inside) Body with 398E, 2084, 3230, 3239 and two 2212, for 3226....
*3382	—	Shuttle (inside) Body with 398E, 2084 and 3239, for 3380.....
*3383	—	Shuttle (inside) Body with 398E, 2084, 3230, 3239 and two 2212, for 3381....
*3236	—	Shuttle (inside) Cover.....
56755	—	" " " " 3236 with 112E, 466H, 2080, 3238, 3241 and 3242.....
2076	217	Shuttle (inside) Cover Hinge Pin.....
3238	302	" " " " Delivery Eye Thread Guard.....
2080	217	Shuttle (inside) Delivery Eye Thread Guard Rivet.....
3239	302	Shuttle (inside) Main Spring.....
398E	217	" " " " " " Screw....
2084	217	" " " " " " Steady Pin.....
466H	217	Shuttle (inside) Tension Regulating Screw.....
3241	302	Shuttle (inside) Tension Spring.....
3242	302	" " " " " " Plate....
112E	217	" " " " " " " Screw
3225	3376	Shuttle (inside) complete, for $\frac{1}{8}$ in. $\frac{5}{16}$ in. and $\frac{1}{4}$ in. to $\frac{1}{2}$ in. gauges, Nos. 2076, 2210, 3231 and 56755.....
3226	3376	Shuttle (inside) complete, for $\frac{1}{8}$ in., $\frac{5}{16}$ in. and $\frac{1}{4}$ in. to $\frac{1}{2}$ in. gauges, Nos. 2076, 2210, 3232 and 56755.....
3380	6235	Shuttle (inside) complete, for $\frac{3}{8}$ in. to $\frac{1}{2}$ in. and $\frac{1}{8}$ in. gauges and above, Nos. 2076, 2210, 3382 and 56755..
3381	6235	Shuttle (inside) complete, for $\frac{3}{8}$ in. to $\frac{1}{2}$ in. and $\frac{1}{8}$ in. gauges and above, Nos. 2076, 2210, 3383 and 56755..
2210	217	Shuttle (outside) Bobbin.....
3230	302	" " " " Retaining Spring
2212	217	" " " " " " Rivet.....
*3234	—	Shuttle (outside) Body with 398E, 2084 and 3240, for 3228.....
*3235	—	Shuttle (outside) Body with 398E, 2084, 3230, 3240 and two 2212, for 3229....

NO.	PLATE	NAME
*3522	—	Shuttle (outside) Body with 398E, 2084 and 3240, for 3519.....
*4798	—	Shuttle (outside) Body with 398E, 2084, 3230, 3240 and two 2212, for 4729....
*3523	—	Shuttle (outside) Body with 398E, 2084 and 3240, for 3520.....
*3524	—	Shuttle (outside) Body with 398E, 2084, 3230, 3240 and two 2212, for 3521....
*3237	—	Shuttle (outside) Cover for 56754.....
56754	—	" " " 3237 with 112E, 466H, 2078, 2080, 2086 and 2090, for 3228, 3229, 3520 and 3521.....
*4582	—	Shuttle (outside) Cover for 56753.....
56753	—	" " " 4582 with 112E, 466H, 2078, 2080, 2086 and 2090, for 3227, 3519, 4648 and 4729.....
2076	217	Shuttle (outside) Cover Hinge Pin.....
2078	217	" " Delivery Eye Thread Guard.....
2080	217	Shuttle (outside) Delivery Eye Thread Guard Rivet.....
3240	302	Shuttle (outside) Main Spring.....
398E	217	" " " " Screw....
2084	217	" " " " Steady Pin.....
466H	217	Shuttle (outside) Tension Regulating Screw.....
2086	217	Shuttle (outside) Tension Spring.....
2090	217	" " " " Plate
112E	217	" " " " Screw.....
3228	3376	Shuttle (outside) complete, for $\frac{1}{8}$ in. to $\frac{1}{4}$ in. gauges, Nos. 2076, 2210, 3234 and 56754.....
3229	3376	Shuttle (outside) complete, for $\frac{1}{8}$ in. to $\frac{1}{4}$ in. gauges, Nos. 2076, 2210, 3235 and 56754.....
3519	6235	Shuttle (outside) complete, for $\frac{1}{4}$ in. gauge only, Nos. 2076, 2210, 3522 and 56753.....
4729	3376	Shuttle (outside) complete, for $\frac{1}{4}$ in. gauge only, Nos. 2076, 2210, 4798 and 56753.....
3520	6235	Shuttle (outside) complete, for $\frac{1}{4}$ in. gauge and above, Nos. 2076, 2210, 3523 and 56754.....

NO.	PLATE	NAME
3521	6235	Shuttle (outside) complete, for $\frac{1}{4}$ in. gauge and above, Nos. 2076, 2210, 3524 and 56754.....
65024	3389	Shuttle Driver and Feed Lifting Cam....
2049	221	" " " " " " Pin
16742	—	" Race Body (two pieces) with 629D.....
2049	221	Shuttle Race Dowel Pin.....
629D	379	" " Hinge Screw.....
6223	376	" " Lock Pin.....
400F	312	" " " " Screw.....
6224	376	" " " " Spring.....
6225	374	" " Loop Separator, for $\frac{1}{8}$ in. to $\frac{3}{8}$ in. gauges, for 6206.....
6235	374	Shuttle Race Loop Separator, for $\frac{3}{8}$ in. to $\frac{3}{4}$ in. gauges, for 6213.....
665J	3384	Shuttle Race Loop Separator Screw....
6206	370	Shuttle Race complete, for $\frac{1}{8}$ in. to $\frac{3}{4}$ in. gauges, Nos. 665J, 6225 and 16742
6213	—	Shuttle Race complete, for $\frac{3}{8}$ in. to $\frac{3}{4}$ in. gauges, Nos. 665J, 6235 and 16742.
738J	379	Shuttle Race Screw, for $\frac{1}{8}$ in. to $\frac{1}{2}$ in. gauges.....
50170J	3384	Shuttle Race Screw, for $\frac{1}{2}$ in. to $\frac{3}{4}$ in. gauges.....
6297	368	Shuttle Race Cover.....
50250J	3388	" " " Screw.....
2102	377	Tension Disc.....
1560c	379	" Regulating Thumb Nut.....
4835	3365	" Releaser.....
809c	379	" Stud (double).....
808F	379	" " Set Screw.....
2103	377	" Spring.....
4377	3383	" Thread Eyelet (double).....
330J	379	" " " Screw.....
2410	221	Thread Guiding Roller.....
86D	3385	" " " Screw.....
2411	221	" " " Stud.....
448c	379	" " " " Set Screw.
2105	377	" " " Thread Guard...
4663	3369	" Take-up Cam with 446c.....
3012	297	" " " Pin.....
446c	312	" " " Set Screw.....
*3281	259	" " Lever with 1819.....
56869	—	" " " 3281 with 1088c.
1088c	3388	" " " Hinge Screw.....

NO.	PLATE	NAME
1819	379	Thread Take-up Lever Roller and Stud..
2248	221	" " Spring with closed eyelet
2127	221	" " " Regulator Plate
233J	3384	" " " " " "
		Adjusting Screw.....
65035	3389	Throat Plate for 6182.....
6248	3353	" " " 6183.....
6254	3353	" " " 6184.....
16763	3353	" " " 16762.....
16765	3354	" " " 16764.....
401D	3385	" " Screw.....
3134	259	Vibrating Presser Bar.....
2361	259	" " " Hinge Bracket....
2362	221	" " " " " Rivet
810D	379	" " " " " Cap Screw.
4897	3365	" " " " " Lifting Bell Crank
810E	379	" " " " " " " "
		Hinge Cap Screw.....
3137	259	Vibrating Presser Bar Spring.....
337J	3385	" " " " " Screw.....
4666	3374	" " " Foot.....
217J	3384	" " " " " Screw.....
6053	380	Drip Pan.....
*15404	—	Trade Mark.....
15405	20883	" " Rivet.....

SINGER Needles should be used
in SINGER Machines.
These Needles and their Containers
are marked with the
Company's Trade-Mark "SIMANCO.***" 1

Needles in Containers marked
"FOR SINGER MACHINES"
are NOT SINGER made needles. 2

LIST OF PARTS COMPLETE

FOR

MACHINE No. 17-22

FOR LEATHER. C. B., CYLINDER BED 1 7/8 INCHES
DIAMETER, DROP FEED ACROSS ARM AT
RIGHT OF NEEDLE, ROLLER PRESSER

NO.	PLATE	NAME
*6001	—	Arm with 4448, 4449, 15404 and two 15405
4389	3383	" Dowel Pin.....
4448	3383	" Oil Tube for intermediate bearing...
123E	312	" Screw.....
4368	364	" Shaft.....
3005	259	" " Bushing (back).....
448C	379	" " " " " Set Screw....
*4449	—	" " " " (front).....
144D	3384	" " Screw.....
4288	368	" Side Cover.....
286D	3385	" " " Thumb Screw.....
12403	377	" Spool Pin and Thread Eyelet.....
11241	382	" " " Washer (cloth).....
4370	364	Balance Wheel, heavy rim, 2 3/4 in. pulley, with two 448c.....
2862	364	Balance Wheel, heavy rim, 3 in. pulley, for 3022.....
448c	379	Balance Wheel Set Screw.....
2139	366	" " Speed Pulley, 1 1/2 in. diam., with 451c.....
2140	366	Balance Wheel Speed Pulley, 2 1/8 in. diam., with 437c.....
451c	3385	Balance Wheel Speed Pulley Set Screw for 2139.....
437c	3385	Balance Wheel Speed Pulley Set Screw for 2140.....
256J	259	Clamp Stop Motion Clamp Screw.....
248A	3385	" " " " " Stop Screw...
2020	259	" " " " " Washer.....
*3023	—	" " " " " Flanged Bushing....
4933	259	" " " " " " 3023 with two 462c.....
2022	221	Clamp Stop Motion Flanged Bushing Pin
462c	3385	" " " " " " " Set Screw.....
3022	—	Clamp Stop Motion complete, Nos. 248A, 256J, 2020 and 4933.....

NO.	PLATE	NAME
16657	383	Cloth Plate.....
16686	383	" " Bracket with 345c.....
345c	379	" " " Set Screw.....
389F	312	" " " Screw.....
16658	—	Cloth Plate with Bracket complete, Nos. 16657, 16686 and two 389F.....
4292	364	Crank Connecting Rod.....
145E	3384	" " " Cap Screw.....
375c	312	" " " Hinge Screw.....
1518J	312	" " " " " Nut
*16839	—	Cylinder, 1 1/8 in. diam.....
4343	365	Face Plate.....
56796	—	" " 4343 with 2105.....
56775	—	Face Plate complete, Nos. 448c, 460c, 2107, 2111, 2127, 2269, 4369, 56791, 56796 and two 233J.....
164J	312	Face Plate Screw.....
2107	221	" " Thread Guard.....
233J	3384	" " " " Screw.....
3032	259	Feed Cam with 446c.....
446c	312	" " Set Screw.....
3033	259	" Connecting Link.....
375	312	" " " Hinge Screw.....
1518J	312	" " " " " Nut..
16607	3350	" Dog, 10 teeth, for 16617.....

NOTE: No. 16607 is sent with this machine unless
another Feed Dog is specified on order

16626	3350	Feed Dog, 10 teeth, one row of teeth at right and two teeth back of needle, for 16627.....
16628	3351	Feed Dog, 10 teeth, two rows of teeth, for 16629.....
16608	388	Feed Dog Carrier.....
225c	379	" " Screw.....
16638	382	" Forked Connection.....
375c	312	" " " Hinge Screw....
1518J	312	" " " " " Nut
3039	259	" Regulator.....
58E	312	" " Hinge Screw.....
818D	379	" " Thumb Screw.....
16610	382	" Rock Shaft.....
16611	388	" " " Crank.....
156F	379	" " " " Position Screw...
190J	3384	" " " " Set Screw.....
16642	382	Needle Bar with 10160.....
*3045	301	" " Connecting Link.....

NO.	PLATE	NAME
56773	—	Needle Bar Connecting Link 3045 with 2052.....
377c	312	Needle Bar Connecting Link Hinge Screw
1518J	312	" " " " " " "
		Nut.....
2052	374	Needle Bar Connecting Stud with 155c...
155c	3384	" " " " Set Screw...
290E	3385	" " Screw Bushing.....
16643	385	" " Thread Guard.....
240J	385	" " " " Screw.....
16644	385	" Clamp with 1112F.....
1112F	385	" " Screw.....
10160	3383	" Stop Pin.....
*6022	367	Oscillating Rock Shaft with 4784.....
16806	—	Oscillating Rock Shaft complete, Nos. 6022 and 56812.....
3052	367	Oscillating Rock Shaft Hinge Pin.....
56812	—	" " " " " 3052 with 1513J.....
1513J	379	Oscillating Rock Shaft Hinge Pin Nut....
4784	3383	" " " Oil Pad.....
16681	3366	" Shaft.....
*16682	—	" " Crank with 1813.....
16683	386	" " " 16682 with two 462c.....
2049	221	Oscillating Shaft Crank Pin.....
1813	221	" " " Roller and Stud..
462c	3385	" " " Set Screw.....
3054	301	Presser Bar.....
2062	301	" " Lifter.....
689c	312	" " " Screw.....
1520E	379	" " " " Nut.....
5608	259	" " Lifting Bracket with 453c....
453c	3385	" " " " Set Screw....
290E	3385	" " Screw Bushing.....
3056	301	" " Spring (heavy).....
2308	301	" " " (light).....
2070	221	" " Washer.....
6069	376	" Foot.....
16715	3374	" " for 16628.....
190J	3384	" " Screw.....
262J	312	Pressure Regulating Thumb Screw.....
1868	231	Roller, 3/8 in. diam., coarse, with 652D and 1528J, for 6070.....
1841	—	Roller, 3/8 in. diam., fine, with 652D and 1528J, for 6071.....

NO.	PLATE	NAME
1898	3388	Roller, 1¼ in. diam., fine, with 386D and 1528J, for 65030.....
1897	—	Roller, 1¼ in. diam., coarse, with 386D and 1528J, for 65051.....
6072	389	Roller Arm for 6070 and 6071.....
16625	385	" " " 65030 and 65051.....
440F	231	" " Adjusting Screw.....
1547J	231	" " " " Nut.....
6073	385	" " Bracket.....
316F	231	" " " Screw Center.....
15444	—	" " " " " 316F with 1547J.....
1547J	231	Roller Arm Bracket Screw Center Nut....
2205	231	" " Lock Spring.....
176J	231	" " " " Screw.....
1549J	231	" " " " " Nut.....
6070	—	Roller Presser complete, ¾ in. coarse roller, Nos. 176J, 440F, 1547J, 1549J, 1868, 2205, 6072, 6073 and two 15444.....
6071	378	Roller Presser complete, ⅞ in. fine roller, Nos. 176J, 440F, 1547J, 1549J, 1841, 2205, 6072, 6073 and two 15444.....

NOTE: No. 6071 is sent with this machine unless another Roller Presser is specified on order

65030	20886	Roller Presser complete, 1¼ in. fine roller, Nos. 176J, 440F, 1547J, 1549J, 1898, 2205, 6073, 16625 and two 15444.....
65051	—	Roller Presser complete, 1¼ in. coarse roller, Nos. 176J, 440F, 1547J, 1549J, 1897, 2205, 6073, 16625 and two 15444.....
190J	3384	Roller Presser Screw.....
652D	3385	" Screw for 1841 and 1868.....
386D	3385	" " " 1897 and 1898.....
1528J	3386	" " Nut.....
2996	386	Shuttle Bobbin.....
*62739	20880	" " Case.....
15140	386	" " " Latch.....
2973	386	" " " " Lever.....
2974	386	" " " " Fulcrum Pin.....
2975	386	Shuttle Bobbin Case Latch Spring.....
592E	386	" " " " Stop Screw....
15141	—	" " " " Hinge, Nos. 2973, 2974 and 15140.....
*15027	386	Shuttle Bobbin Case Position Finger.....
2523	386	" " " " " Rivet.....

NO.	PLATE	NAME
15277	386	Shuttle Bobbin Case complete, Nos. 591F, 592E, 2523, 2975, 15027, 15141, 15278 and 62739.....
16614	386	Shuttle Body.....
591F	386	" Tension Regulating Screw.....
15278	386	" " Spring.....
16613	386	" 1½ in. diam., Nos. 2996, 15277 and 16614.....
16615	386	Shuttle Driver and Feed Lifting Cam....
2049	221	" " " " " Pin
65052	—	" Race Body.....
65053	20880	" " Cap.....
1053J	3388	" " " Screw.....
65093	20880	" " Cover.....
50250J	3388	" " " Hinge Screw.....
22431	20880	" " " " Washer
65094	—	Shuttle Race complete, Nos. 50250J, 65052, 65053, 65093 and two each 1053J and 22431.....
50258J	3388	Shuttle Race Screw.....
2102	377	Tension Disc.....
1560c	379	" Regulating Thumb Nut.....
4369	377	" Releaser.....
2269	377	" " Hinge Pin.....
600c	379	" Screw Stud.....
16202	—	" " " 600c with 1560c....
448c	379	" " " Set Screw.....
2103	377	" Spring.....
2105	377	" Thread Guard.....
56791	—	Tension complete, Nos. 2103, 2124, 16202 and two 2102.....
2112	221	Thread Retaining Disc with 2113.....
2113	221	" " " Steady Pin.....
2114	221	" " Spring.....
2115	221	" " Stud.....
460c	3379	" " " Set Screw.....
2111	221	Thread Retainer Guide complete, Nos. 2112, 2114 and 2115.....
*56828	—	Thread Take-up Cam.....
3182	3369	" " " 56828 with 446c....
3012	297	" " " Pin.....
446c	312	" " " Set Screw.....
*3072	259	" " Lever with 1819.....
56855	—	" " " 3072 with 1088c..
1088c	3388	" " " Hinge Screw.....
1819	379	" " " Roller and Stud..
2124	221	" " Spring.....

NO.	PLATE	NAME
2127	221	Thread Take-up Spring Regulator Plate
233J	3384	" " " " " "
		Adjusting Screw.....
16617	3350	Throat Plate for 16607.....
16627	3350	" " " 16626.....
16629	3351	" " " 16628.....
401D	3385	" " Screw.....
6053	380	Drip Pan.....
*15404	—	Trade Mark.....
15405	20883	" " Rivet.....

SINGER Needles should be used in SINGER Machines. These Needles and their Containers are marked with the Company's Trade-Mark "SIMANCO.**" 1

Needles in Containers marked "FOR SINGER MACHINES" are NOT SINGER made needles. 2

LIST OF PARTS COMPLETE
FOR
MACHINE No. 17-23

FOR LEATHER. HAS FEED AT LEFT OF NEEDLE,
OTHERWISE SAME AS No. 17-22 MACHINE

NO.	PLATE	NAME
*6001	—	Arm with 4448, 4449, 15404 and two 15405
4389	3383	" Dowel Pin.....
4448	3383	" Oil Tube for intermediate bearing...
123E	312	" Screw.....
4368	364	" Shaft.....
3005	259	" " Bushing (back).....
448c	379	" " " " Set Screw....
*4449	—	" " " (front).....
144D	3384	" " Screw.....
4288	368	" Side Cover.....
286D	3385	" " " Thumb Screw.....
12403	377	" Spool Pin and Thread Eyelet.....
11241	382	" " " Washer (cloth).....
4370	364	Balance Wheel, heavy rim, 2 3/4 in. pulley, with two 448c.....
2862	364	Balance Wheel, heavy rim, 3 in. pulley, for 3022.....
448c	379	Balance Wheel Set Screw.....
2139	366	" " Speed Pulley, 1 1/8 in. diam., with 451c.....
2140	366	Balance Wheel Speed Pulley, 2 1/8 in. diam., with 437c.....
451c	3385	Balance Wheel Speed Pulley Set Screw for 2139.....
437c	3385	Balance Wheel Speed Pulley Set Screw for 2140.....
256J	259	Clamp Stop Motion Clamp Screw.....
248A	3385	" " " " Stop Screw....
2020	259	" " " " Washer.....
*3023	—	" " " Flanged Bushing....
4933	259	" " " " " 3023 with two 462c.....
2022	221	Clamp Stop Motion Flanged Bushing Pin
462c	3385	" " " " " Set Screw.....
3022	—	Clamp Stop Motion complete, Nos. 248A, 256J, 2020 and 4933.....

128 PARTS FOR MACHINE No. 17-23

NO.	PLATE	NAME
16657	383	Cloth Plate.....
16686	383	" " Bracket with 345c.....
345c	379	" " Set Screw.....
389F	312	" " Screw.....
16658	—	Cloth Plate with Bracket complete, Nos. 16657, 16686 and two 389F.....
4292	364	Crank Connecting Rod.....
145E	3384	" " Cap Screw.....
375c	312	" " Hinge Screw.....
1518J	312	" " Nut.....
*16839	—	Cylinder, 1 1/8 in. diam.....
4343	365	Face Plate.....
56796	—	" " 4343 with 2105.....
56775	—	Face Plate complete, Nos. 448c, 460c, 2107, 2111, 2127, 2269, 4369, 56791, 56796 and two 233J.....
164J	312	Face Plate Screw.....
2107	221	" " Thread Guard.....
233J	3384	" " Screw.....
3032	259	Feed Cam with 446c.....
446c	312	" " Set Screw.....
3033	259	" Connecting Link.....
375c	312	" " Hinge Screw.....
1518J	312	" " Nut.....
16618	3350	" Dog, 10 teeth, for 16619 and 65029..
16608	388	" Carrier.....
225c	379	" Screw.....
16638	382	" Forked Connection.....
375c	312	" " Hinge Screw.....
1518J	312	" " Nut.....
3039	259	" Regulator.....
58E	312	" " Hinge Screw.....
818D	379	" " Thumb Screw.....
16610	382	" Rock Shaft.....
16611	388	" " Crank.....
156F	379	" " Position Screw..
190J	3384	" " Set Screw.....
4264	301	Needle Bar.....
*3045	301	" " Connecting Link.....
56773	—	" " 3045 with 2052.....
377c	312	Needle Bar Connecting Link Hinge Screw
1518J	312	" " Nut.....
2052	374	Needle Bar Connecting Stud with 155c...
155c	3384	" " Set Screw...
290E	3385	" " Screw Bushing.....

PARTS FOR MACHINE No. 17-23 129

NO.	PLATE	NAME
7524	3383	Needle Clamp with 196F, 651J and 7525..
196F	3383	" " Screw.....
7525	3383	" " Thread Guide.....
651J	3383	" " Screw.....
*6022	367	Oscillating Rock Shaft with 4784.....
16806	—	Oscillating Rock Shaft complete, Nos. 6022 and 56812.....
3052	367	Oscillating Rock Shaft Hinge Pin.....
56812	—	" " 3052 with 1513J.....
1513J	379	Oscillating Rock Shaft Hinge Pin Nut....
4784	3383	" " Oil Pad.....
16681	3366	" Shaft.....
*16682	—	" " Crank with 1813.....
16683	386	" " 16682 with two 462c.....
2049	221	Oscillating Shaft Crank Pin.....
1813	221	" " Roller and Stud..
462c	3385	" " Set Screw.....
3054	301	Presser Bar.....
52016	20879	" " Lifter.....
689c	312	" " Screw.....
1520E	379	" " Nut.....
5608	259	" " Lifting Bracket with 453c....
453c	3385	" " Set Screw....
290E	3385	" " Screw Bushing.....
3056	301	" " Spring (heavy).....
2308	301	" " (light).....
2070	221	" " Washer.....
2180	372	" Foot.....
190J	3384	" " Screw.....
262J	312	Pressure Regulating Thumb Screw.....
1868	231	Roller, 1/8 in. diam., coarse, with 652D and 1528J, for 2196.....
1841	—	Roller, 1/8 in. diam., fine, with 652D and 1528J, for 2197.....
2203	231	Roller Arm.....
440F	231	" " Adjusting Screw.....
1547J	231	" " Nut.....
2206	231	" " Bracket.....
316F	231	" " Screw Center.....
15444	—	" " 316F with 1547J.....
1547J	231	Roller Arm Bracket Screw Center Nut...
2205	231	" " Lock Spring.....
176J	231	" " Screw.....
1549J	231	" " Nut.....

NO.	PLATE	NAME
2196	3371	Roller Presser complete, $\frac{3}{8}$ in. coarse roller, Nos. 176j, 440f, 1547j, 1549j, 1868, 2203, 2205, 2206 and two 15444.
2197	—	Roller Presser complete, $\frac{7}{8}$ in. fine roller, Nos. 176j, 440f, 1547j, 1549j, 1841, 2203, 2205, 2206 and two 15444.
NOTE: No. 2197 is sent with this machine unless another Roller Presser is specified on order.		
652d	3385	Roller Screw
1528j	3386	" " Nut
51851	—	Roller, $\frac{1}{4}$ in. diam., fine, for 51852.
51849	—	" " " coarse, for 51850.
16232	20882	" Ball
1766c	20882	" Retaining Nut
50553c	20882	" Screw
1528j	3386	" " Nut
51852	20883	Roller, $\frac{1}{4}$ in. diam., $\frac{3}{8}$ in. face, fine (ball bearing) complete for 65047, Nos. 1528j, 1766c, 50553c, 51851 and twenty-four 16232.
51850	—	Roller, $\frac{1}{4}$ in. diam., $\frac{3}{8}$ in. face, coarse (ball bearing) complete for 65086, Nos. 1528j, 1766c, 50553c, 51849 and twenty-four 16232.
16230	20882	Roller Arm
440f	231	" " Adjusting Screw
1547j	231	" " " " Nut
4282	3371	" " Bracket
316f	231	" " " Screw Center
15444	—	" " " " " 316f with 1547j.
1547j	231	Roller Arm Bracket Screw Center Nut
2205	231	" " Lock Spring
176j	231	" " " " Screw
1549j	231	" " " " " Nut
65047	20881	Roller Presser (ball bearing) complete, $\frac{1}{4}$ in. fine roller, Nos. 176j, 440f, 1547j, 1549j, 2205, 4282, 16230, 51852 and two 15444.
65086	—	Roller Presser (ball bearing) complete, $\frac{1}{4}$ in. coarse roller, Nos. 176j, 440f, 1547j, 1549j, 2205, 4282, 16230, 51850 and two 15444.
190j	3384	Roller Presser Screw
2996	386	Shuttle Bobbin
*62739	20880	" " Case

NO.	PLATE	NAME
15140	386	Shuttle Bobbin Case Latch
2973	386	" " " " Lever
2974	386	" " " " " Fulcrum Pin
2975	386	Shuttle Bobbin Case Latch Spring
592E	386	" " " " Stop Screw
15141	—	" " " Hinge, Nos. 2973, 2974 and 15140.
15027	386	Shuttle Bobbin Case Position Finger
2523	386	" " " " Rivet
15277	386	Shuttle Bobbin Case complete, Nos. 591f, 592E, 2523, 2975, 15027, 15141, 15278 and 62739.
16614	386	Shuttle Body
591f	386	" Tension Regulating Screw
15278	386	" " Spring
16613	386	" $1\frac{1}{2}$ in. diam., Nos. 2996, 15277 and 16614.
16615	386	Shuttle Driver and Feed Lifting Cam
2049	221	" " " " " Pin
65052	—	" Race Body
65053	20880	" " Cap
1053j	3388	" " " Screw
65093	20880	" " Cover
50250j	3388	" " " Hinge Screw
22431	20880	" " " " " Washer
65094	—	Shuttle Race complete, Nos. 50250j, 65052, 65053, 65093 and two each 1053j and 22431.
50258j	3388	Shuttle Race Screw
2102	377	Tension Disc
1560c	379	" Regulating Thumb Nut
4369	377	" Releaser
2269	377	" " Hinge Pin
600c	379	" Screw Stud
16202	—	" " " 600c with 1560c.
448c	379	" " " Set Screw
2103	377	" Spring
2105	377	" Thread Guard
56791	—	Tension complete, Nos. 2103, 2124, 16202 and two 2102.
2112	221	Thread Retaining Disc with 2113.
2113	221	" " " Steady Pin
2114	221	" " Spring
2115	221	" " Stud
460c	3379	" " " Set Screw

NO.	PLATE	NAME
2111	221	Thread Retainer Guide complete, Nos. 2112, 2114 and 2115.
*56828	—	Thread Take-up Cam.
3182	3369	" " " 56828 with 446c.
3012	297	" " " Pin.
446c	312	" " " Set Screw.
*3072	259	" " Lever with 1819.
56855	—	" " " 3072 with 1088c.
1088c	3388	" " " Hinge Screw.
1819	379	" " " Roller and Stud.
2124	221	" " Spring.
2127	221	" " " Regulator Plate
233j	3384	" " " " " "
16619	3350	Adjusting Screw.
65029	3389	Throat Plate for 16618.
401d	3385	" " " 16618, for ladies' shoes.
6053	380	" " " Screw.
*15404	—	Drip Pan.
15405	20883	Trade Mark.
		" " Rivet.

SINGER Needles should be used in SINGER Machines. These Needles and their Containers are marked with the Company's Trade-Mark "SIMANCO.***" 1

Needles in Containers marked "FOR SINGER MACHINES" are NOT SINGER made needles. 2

LIST OF PARTS COMPLETE
FOR
MACHINE No. 17-24

FOR SADDLES, FINE LEATHER BAGS AND OTHER CONCAVE OR HOLLOW ARTICLES IN LEATHER. HAS UPPER FEED ACROSS ARM AND PRESSER FEED POINT FOR 1/8 INCH "SET" STITCH. PRESSER FEED POINTS FOR 1/4, 1/5, 1/10 AND 1/12 INCH "SET" STITCH CAN BE FURNISHED IF SO ORDERED, AT AN EXTRA COST.

NO.	PLATE	NAME
*16666	—	Arm with 159j, 180j, 4448, 4449, 4891, 4892, 6305, 15404, two 15405 and four 129j.
4389	3383	Arm Dowel Pin.
4448	3383	" Oil Tube for intermediate bearing.
123E	312	" Screw.
6178	3364	" Shaft for 3011.
6179	3364	" " " 5977.
3005	259	" " Bushing (back).
448c	379	" " " " Set Screw.
*4449	—	" " " (front).
144d	3384	" " Screw.
6302	368	" Side Cover.
286d	3385	" " " Thumb Screw.
12403	377	" Spool Pin and Thread Eyelet.
11241	382	" " " Washer (cloth).
3011	3364	Balance Wheel (two speed) 3 in. and 5 in. pulleys, with two 448c.
5977	3364	Balance Wheel (two speed) 3 in. and 5 in. pulleys, for 5981.
448c	379	Balance Wheel Set Screw.
4292	364	Crank Connecting Rod.
145E	3384	" " " Cap Screw.
375c	312	" " " Hinge Screw.
1518j	312	" " " " " Nut.
*16667	—	Cylinder, 2 1/8 in. diam.
5978	366	Driving Flange with two 435c.
5993	—	Driving Flange complete, Nos. 136f, 330j and 5978 to 5980.

NO.	PLATE	NAME
5979	377	Driving Flange Latch.....
136F	379	" " " Hinge Screw.....
5980	377	" " " Spring.....
330J	379	" " " " Screw.....
435c	379	" " " Set Screw.....
5981	—	Loose Wheel Attachment complete, Nos. 5977 and 5993.....
56871	20876	Face Plate.....
56872	—	" " 56871 with 2105.....
56873	—	Face Plate complete, Nos. 448c, 460c, 2111, 2127, 2269, 4378, 56791, 56870, 56872 and two 233J.....
175J	3384	Face Plate Screw.....
56870	20879	" " Thread Guard.....
233J	3384	" " " " Screw.....
6319	369	Feed Bar.....
6306	375	" " Connecting Link.....
89F	379	" " " " Hinge Screw..
2361	259	" " Hinge Bracket.....
2362	221	" " " " Rivet.....
810D	379	" " " Cap Screw.....
65008	3392	" Cam with two 446c.....
446c	312	" " Set Screw.....
65009	3392	" Lever.....
*6305	—	" " Bracket with two 620c.....
180J	3384	" " " Screw (lower).....
159J	3384	" " " " (upper).....
6307	3367	" " Hinge Pin.....
620c	379	" " " " Set Screw.....
6308	374	" Point.....
NOTE: When ordering No. 6308, give number of stitches to the inch.		
217J	3384	Feed Point Screw.....
4905	3369	" Regulator with 4907 and two 237J..
4938	—	Feed Regulator complete, Nos. 666F, 1014D, 4905, 4906 and 4959.....
2049	221	Feed Regulator Pin.....
4906	3367	" " Slide Block.....
1014D	3385	" " " Thumb Screw.....
666F	3385	" " " " Lock Screw
4959	3383	" " " " Stud
4907	3367	" " " " Stop Bracket
237J	3384	" " " " " " " " Screw.....
4908	3366	Feed Shaft.....
*4892	—	" " Bracket (back).....

NO.	PLATE	NAME
129J	3384	Feed Shaft Bracket (back) Screw.....
*4891	—	" " " (front).....
129J	3384	" " " " Screw.....
6316	369	" " Crank with 453c and 1813....
3093	297	" " " Pin.....
1813	221	" " " Roller and Stud.....
453c	3385	" " " Set Screw.....
3126	259	Guide Bar.....
*56752	—	" " 3126 with 2361 and two 2362..
56868	—	" " 56752 with 4723 and three 404J
16656	—	Guide Bar complete, Nos. 810D, 810E, 4897, 6319 and 56868.....
4854	389	Guide Bar Driving Crank with 1862 and 3131.....
1862	297	Guide Bar Driving Crank Roller (roller only).....
3131	297	Guide Bar Driving Crank Roller Cap....
3094	297	" " " " Wedge.....
690E	312	" " " " " Screw..
4723	389	" " Lifting Bracket.....
404J	3385	" " " " " Screw.....
2058	3365	Lifting Presser Bar.....
3133	259	" " " Bracket with 641E and 1823.....
641E	3384	Lifting Presser Bar Bracket Clamping Screw.....
1823	221	Lifting Presser Bar Bracket Roller and Stud.....
4855	3366	Lifting Presser Bar Lifter.....
598c	3385	" " " " " Screw.....
683D	3384	" " " " " Stop Screw....
4897	3365	" " " " Lifting Bell Crank...
810E	379	" " " " " " " " Hinge Cap Screw.....
4725	3365	Lifting Presser Bar Lifting Bracket.....
4726	3383	" " " " " Guide Pin.....
3100	301	Lifting Presser Bar Spring.....
2070	221	" " " " " Washer.....
6317	374	" " " Foot.....
190J	3384	" " " " Screw.....
4264	301	Needle Bar.....
*4898	3367	" " Connecting Link with 390E..
56764	—	" " " " " 4898 with 15472.....
390E	3385	Needle Bar Connecting Link Adjusting Screw.....

NO.	PLATE	NAME
15472	3389	Needle Bar Connecting Stud with 155c...
155c	3384	" " " " Set Screw...
4265	302	" Clamp with 196F.....
4865	3383	Needle Clamp complete, Nos. 651r, 4265 and 4266.....
196F	3383	Needle Clamp Screw.....
4266	302	" " Thread Guide.....
651r	3383	" " " " Screw.....
65010	3389	" Plate.....
220j	3384	" " Screw.....
*6022	367	Oscillating Rock Shaft with 4784.....
16806	—	Oscillating Rock Shaft complete, Nos. 6022 and 56812.....
3052	367	Oscillating Rock Shaft Hinge Pin.....
56812	—	" " " " " 3052 with 1513r.....
1513r	379	Oscillating Rock Shaft Hinge Pin Nut...
4784	3383	" " " Oil Pad.....
6023	364	" Shaft.....
*6056	—	" " Crank with 460c and 1813
6024	377	" " " " 1813 and two 462c.....
2049	221	Oscillating Shaft Crank Pin.....
1813	221	" " " Roller and Stud..
460c	3379	" " " Set Screw for 6056
462c	3385	" " " " 6024
262r	312	Pressure Regulating Thumb Screw.....
1632c	3388	" " " " Lock Nut
2073	217	Shuttle Bobbin.....
2211	217	" " Retaining Spring.....
2212	217	" " " Rivet...
*6058	—	" Body with 398E, 2082, 2084, 2211 and two 2212.....
*15458	—	Shuttle Cover.....
125017	—	" " 15458 with 112E, 466H, 2078, 2080, 2086 and 2090.....
2076	217	Shuttle Cover Hinge Pin.....
2078	217	" Delivery Eye Thread Guard....
2080	217	" " " Rivet
2082	217	" Main Spring.....
398E	217	" " " Screw.....
2084	217	" " " Steady Pin.....
466H	217	" Tension Regulating Screw.....
2086	217	" " Spring.....
2090	217	" " " Plate.....
112E	217	" " " Screw.....
16892	20880	Shuttle (high point) complete, Nos. 2073, 2076, 6058 and 125017.....

NO.	PLATE	NAME
6029	367	Shuttle Driver.....
2049	221	" " Pin.....
16777	3393	" Race Ring.....
65011	—	Shuttle Race Ring complete, Nos. 16670, 16777, 65010 and four 220j.....
16670	3361	Shuttle Race Ring Cap.....
220j	3384	" " " " Screw.....
16778	—	" " " Cover.....
16779	3369	" " " " 16778 with 16242 and two 240r.....
16242	20880	Shuttle Race Ring Cover Latch.....
240r	385	" " " " " Screw....
50250j	3388	" " " " Screw.....
175r	3384	" " " Screw.....
2102	377	Tension Disc.....
1560c	379	" Regulating Thumb Nut.....
4378	3367	" Releaser.....
2269	377	" " Hinge Pin.....
600c	379	" Screw Stud.....
16202	—	" " " 600c with 1560c....
448c	379	" " " Set Screw.....
2103	377	" Spring.....
2105	377	" Thread Guard.....
5679i	—	Tension complete, Nos. 2103, 2124, 16202 and two 2102.....
2112	221	Thread Retaining Disc with 2113.....
2113	221	" " " Steady Pin.....
2114	221	" " Spring.....
2115	221	" " Stud.....
460c	3379	" " " Set Screw.....
2111	221	Thread Retainer Guide complete, Nos. 2112, 2114 and 2115.....
*65003	—	Thread Take-up Cam.....
6450	382	" " " 65003 with 446c...
3012	297	" " " Pin.....
446c	312	" " " Set Screw.....
*3072	259	" " Lever with 1819.....
56855	—	" " " 3072 with 1088c..
1088c	3388	" " " Hinge Screw.....
1819	379	" " " Roller and Stud...
2124	221	" " Spring.....
2127	221	" " " Regulator Plate
233j	3384	" " " " "
		Adjusting Screw.....
6053	380	Drip Pan.....
*15404	—	Trade Mark.....
15405	20883	" " Rivet.....

LIST OF PARTS COMPLETE

FOR

MACHINE No. 17-25

FOR CLOTH OR LEATHER. HAS C. B. CYLINDER
1 7/8 INCHES DIAMETER. DROP FEED ACROSS
ARM. ALTERNATING PRESSERS

NO.	PLATE	NAME
*6271	—	Arm with 4448, 4449, 15401 and two 15405
4389	3383	" Dowel Pin.....
4448	3383	" Oil Tube for intermediate bearing...
123E	312	" Screw.....
4359	3364	" Shaft.....
3005	259	" " Bushing (back).....
448c	379	" " " " Set Screw....
*4449	—	" " " " (front).....
144D	3384	" " Screw.....
4288	368	" Side Cover.....
286D	3385	" " " Thumb Screw.....
12403	377	" Spool Pin and Thread Eyelet.....
11241	382	" " " Washer (cloth).....
4370	364	Balance Wheel, heavy rim, 2 3/4 in. pulley, with two 448c.....
2862	364	Balance Wheel, heavy rim, 3 in. pulley, for 3022.....
448c	379	Balance Wheel Set Screw.....
2139	366	" " Speed Pulley, 1 1/8 in. diam., with 451c.....
2140	366	Balance Wheel Speed Pulley, 2 1/8 in. diam., with 437c.....
451c	3385	Balance Wheel Speed Pulley Set Screw for 2139.....
437c	3385	Balance Wheel Speed Pulley Set Screw for 2140.....
256J	259	Clamp Stop Motion Clamp Screw.....
248A	3385	" " " " Stop Screw....
2020	259	" " " " Washer.....
*3023	—	" " " Flanged Bushing....
4933	259	" " " " " 3023 with two 462c.....
2022	221	Clamp Stop Motion Flanged Bushing Pin
462c	3385	" " " " " Set Screw.....
3022	—	Clamp Stop Motion complete, Nos. 248A, 256J, 2020 and 4933.....

NO.	PLATE	NAME
16657	383	Cloth Plate.....
16686	383	" " Bracket with 345c.....
345c	379	" " " Set Screw.....
389F	312	" " Screw.....
16658	—	Cloth Plate with Bracket complete, Nos. 16657, 16686 and two 389F.....
4292	364	Crank Connecting Rod.....
145E	3384	" " " Cap Screw.....
375c	312	" " " Hinge Screw.....
1518J	312	" " " " " Nut..
*16839	—	Cylinder, 1 1/8 in. diam.....
56871	20876	Face Plate.....
56872	—	" " 56871 with 2105.....
56873	—	Face Plate complete, Nos. 448c, 460c, 2111, 2127, 2269, 4378, 56791, 56870, 56872 and two 233J.....
175J	3384	Face Plate Screw.....
56870	20879	" " Thread Guard.....
233J	3384	" " " Screw.....
3032	259	Feed Cam with 446c.....
446c	312	" " Set Screw.....
3033	259	" Connecting Link.....
375c	312	" " " Hinge Screw.....
1518J	312	" " " " " Nut..
16628	3351	" Dog, 10 teeth, two rows of teeth, for 16629.....
NOTE: No. 16628 is sent with this machine unless another Feed Dog is specified on order.		
16674	3355	Feed Dog, 10 teeth, for 16675.....
16608	388	" " Carrier.....
225c	379	" " Screw.....
16638	382	" Forked Connection.....
375c	312	" " " Hinge Screw....
1518J	312	" " " " " Nut..
3039	259	" Regulator.....
58E	312	" " Hinge Screw.....
818D	379	" " Thumb Screw.....
16610	382	" Rock Shaft.....
16611	388	" " Crank.....
156F	379	" " " Position Screw....
190J	3384	" " " Set Screw.....
3126	259	Guide Bar.....
*56752	—	" " 3126 with 2361 and two 2362..
56844	—	" " 56752 with 337J and 3137.....
16781	—	Guide Bar complete, Nos. 810D, 810E, 4723, 4897, 16780, 56844 and three 404J

NO.	PLATE	NAME
4854	389	Guide Bar Driving Crank with 1862 and 3131.....
1862	297	Guide Bar Driving Crank Roller (roller only).....
3131	297	Guide Bar Driving Crank Roller Cap.....
3094	297	" " " " Wedge.....
690E	312	" " " " " Screw....
4723	389	" " " " Lifting Bracket.....
404J	3385	" " " " " Screw.....
2058	3365	Lifting Presser Bar.....
3133	259	" " " " Bracket with 641E and 1823.....
641E	3384	Lifting Presser Bar Bracket Clamping Screw.....
1823	221	Lifting Presser Bar Bracket Roller and Stud.....
4855	3366	Lifting Presser Bar Lifter.....
598c	3385	" " " " " Screw.....
4725	3365	" " " " Lifting Bracket.....
4726	3383	" " " " " Guide Pin.....
3100	301	Lifting Presser Bar Spring.....
2070	221	" " " " " Washer.....
2358	259	" " " " Foot.....
193J	20883	" " " " " Screw.....
4264	301	Needle Bar.....
*4898	3367	" " " " Connecting Link with 390E..
56764	—	" " " " " 4898 with 15472.....
390E	3385	Needle Bar Connecting Link Adjusting Screw.....
15472	3389	Needle Bar Connecting Stud with 155c...
155c	3384	" " " " " Set Screw..
4265	302	" " " " Clamp with 196F.....
4865	3383	Needle Clamp complete, Nos. 651J, 4265 and 4266.....
196F	3383	Needle Clamp Screw.....
4266	302	" " " " Thread Guide.....
651J	3383	" " " " " Screw.....
*6022	367	Oscillating Rock Shaft with 4784.....
16806	—	Oscillating Rock Shaft complete, Nos. 6022 and 56812.....
3052	367	Oscillating Rock Shaft Hinge Pin.....
56812	—	" " " " " " 3052 with 1513J.....
1513J	379	Oscillating Rock Shaft Hinge Pin Nut....
4784	3383	" " " " " Oil Pad.....

NO.	PLATE	NAME
16681	3366	Oscillating Shaft.....
*16682	—	" " " " Crank with 1813.....
16683	386	" " " " " 16682 with two 462c
2049	221	" " " " " Pin.....
1813	221	" " " " " Roller and Stud..
462c	3385	" " " " " Set Screw.....
262J	312	Pressure Regulating Thumb Screw.....
2996	386	Shuttle Bobbin.....
*62739	20880	" " " " Case.....
15140	386	" " " " Latch.....
2973	386	" " " " " Lever.....
2974	386	" " " " " " Fulcrum Pin.....
2975	386	Shuttle Bobbin Case Latch Spring.....
592E	386	" " " " " Stop Screw...
15141	—	" " " " " Hinge, Nos. 2973, 2974 and 15140.....
*15027	386	Shuttle Bobbin Case Position Finger....
2523	386	" " " " " " Rivet
15277	386	Shuttle Bobbin Case complete, Nos. 591F, 592E, 2523, 2975, 15027, 15141, 15278 and 62739.....
16614	386	Shuttle Body.....
591F	386	" " " " Tension Regulating Screw.....
15278	386	" " " " Spring.....
16613	386	Shuttle, 1½ in. diam., Nos. 2996, 15277 and 16614.....
16615	386	Shuttle Driver and Feed Lifting Cam....
2049	221	" " " " " " " Pin
65052	—	" " " " Race Body.....
65053	20880	" " " " Cap.....
1053J	3388	" " " " " Screw.....
65093	20880	" " " " Cover.....
50250J	3388	" " " " Hinge Screw.....
22431	20880	" " " " " " Washer.
65094	—	Shuttle Race complete, Nos. 50250J, 65052, 65053, 65093 and two each 1053J and 22431.....
50253J	3388	Shuttle Race Screw.....
2102	377	Tension Disc.....
1560c	379	" " " " Regulating Thumb Nut.....
4378	3367	" " " " Releaser.....
2269	377	" " " " Hinge Pin.....
600c	379	" " " " Screw Stud.....
16202	—	" " " " " 600c with 1560c....
448c	379	" " " " " Set Screw.....
2103	377	" " " " Spring.....

NO.	PLATE	NAME
2105	377	Tension Thread Guard.....
56791	—	Tension complete, Nos. 2103, 2124, 16202 and two 2102.....
2112	221	Thread Retaining Disc with 2113.....
2113	221	“ “ “ Steady Pin.....
2114	221	“ “ Spring.....
2115	221	“ “ Stud.....
460c	3379	“ “ “ Set Screw.....
2111	221	Thread Retainer Guide complete, Nos. 2112, 2114 and 2115.....
*56829	—	Thread Take-up Cam.....
3190	3369	“ “ “ 56829 with 446c... ..
3012	297	“ “ “ Pin.....
446c	312	“ “ “ Set Screw.....
*3072	259	“ “ Lever with 1819.....
56855	—	“ “ “ 3072 with 1088c... ..
1088c	3388	“ “ “ Hinge Screw.....
1819	379	“ “ “ Roller and Stud... ..
2124	221	“ “ Spring.....
2127	221	“ “ “ Regulator Plate.....
233j	3384	“ “ “ “ “ “
		Adjusting Screw.....
16629	3351	Throat Plate for 16628.....
16675	3355	“ “ “ 16674.....
401D	3385	“ “ Screw.....
16780	3365	Vibrating Presser Bar.....
2361	259	“ “ “ Hinge Bracket.....
2362	221	“ “ “ “ “ Rivet.....
810D	379	“ “ “ “ Cap Screw.. ..
4897	3365	“ “ “ Lifting Bell Crank.....
810E	379	“ “ “ “ “ “
		Hinge Cap Screw.....
3137	259	Vibrating Presser Bar Spring.....
337j	3385	“ “ “ “ Screw.....
3136	259	“ “ Foot.....
217j	3384	“ “ “ Screw.....
6053	380	Drip Pan.....
*15404	—	Trade Mark.....
15405	20883	“ “ Rivet.....

LIST OF PARTS COMPLETE

FOR

MACHINE No. 17-26

UPPER AND LOWER FEEDS. FOR STITCHING IN SWEAT BANDS AFTER THEY ARE JOINED TOGETHER. FOR SOFT HATS.

NO.	PLATE	NAME
*16782	—	Arm with 4448, 4449, 4891, 4892, 15404, two 15405 and four 129E.....
4389	3383	Arm Dowel Pin.....
4448	3383	“ Oil Tube for intermediate bearing... ..
123E	312	“ Screw.....
6178	3364	“ Shaft for 3011.....
6179	3364	“ “ “ 5977.....
3005	259	“ “ Bushing (back).....
448c	379	“ “ “ “ Set Screw... ..
*4449	—	“ “ “ (front).....
144D	3384	“ “ Screw.....
16783	3365	“ Side Cover.....
286D	3385	“ “ “ Thumb Screw.....
12403	377	“ Spool Pin and Thread Eyelet.....
11241	382	“ “ “ Washer (cloth).....
3011	3364	Balance Wheel (two speed) 3 in. and 5 in. pulleys, with two 448c.....
5977	3364	Balance Wheel (two speed) 3 in. and 5 in. pulleys, for 5981.....
448c	379	Balance Wheel Set Screw.....
4292	364	Crank Connecting Rod.....
145E	3384	“ “ “ Cap Screw.....
375c	312	“ “ “ Hinge Screw.....
1518j	312	“ “ “ “ “ Nut.....
*16784	—	Cylinder, 2 1/8 in. diam.....
5978	366	Driving Flange with two 435c.....
5993	—	Driving Flange complete, Nos. 136F, 330J and 5978 to 5980.....
5979	377	Driving Flange Latch.....
136F	379	“ “ “ Hinge Screw.....
5980	377	“ “ “ Spring.....
330j	379	“ “ “ “ Screw.....
435c	379	“ “ “ Set Screw.....
5981	—	Loose Wheel Attachment complete, Nos. 5977 and 5993.....
56871	20876	Face Plate.....

NO.	PLATE	NAME
56872	—	Face Plate 56871 with 2105.....
56873	—	Face Plate complete, Nos. 448c, 460c, 2111, 2127, 2269, 4378, 56791, 56870, 56872 and two 233j.....
175j	3384	Face Plate Screw.....
56870	20879	" " Thread Guard.....
233j	3384	" " " " Screw.....
16785	3369	Feed (lower and upper) Cam with 446c..
446c	312	" " " " " Set Screw..
3033	259	" " Connecting Link.....
375c	312	" " " " " Hinge Screw
1518j	312	" " " " " " " Nut.....
16786	3355	Feed (lower) Dog, 11 teeth, for 16798....
6016	366	" " " " Carrier.....
225c	379	" " " " " Screw.....
16787	3368	" " Forked Connection.....
375c	312	" " " " " Hinge Screw
1518j	312	" " " " " " " Nut.....
4747	3367	Feed (lower) Regulator.....
58E	312	" " " " " Hinge Screw....
818D	379	" " " " " Thumb Screw....
6017	364	" " Rock Shaft.....
16788	3367	" " " " " Crank.....
156F	379	" " " " " " Position Screw.....
190j	3384	Feed (lower) Rock Shaft Crank Set Screw
16789	3365	" (upper) Bar.....
6306	375	" " " " " Connecting Link.....
89F	379	" " " " " " Hinge Screw.....
2361	259	Feed (upper) Bar Hinge Bracket.....
2362	221	" " " " " " Rivet....
810D	379	" " " " " " Cap Screw.....
4746	3368	" " Forked Connection with 453c
3093	297	" " " " " Pin.....
453c	3385	" " " " " Set Screw
16790	3368	" " Lever.....
16791	3368	" " " Bracket.....
180j	3384	" " " " " Screw.....
866D	3385	" " " " " Hinge Screw.....
1517E	3386	" " " " " Nut.....
16792	3367	" " " Slide Block.....
4905	3369	" " Regulator with 4907 and two 237j.....

NO.	PLATE	NAME
4938	—	Feed (upper) Regulator complete, Nos. 666F, 1014D, 4905, 4906 and 4959.....
2049	221	Feed (upper) Regulator Pin.....
4906	3367	" " " Slide Block.....
1014D	3385	" " " " Thumb Screw....
666F	3385	" " " " " Lock Screw.....
4959	3383	Feed (upper) Regulator Thumb Screw Lock Stud.....
4907	3367	Feed (upper) Regulator Thumb Screw Stop Bracket.....
237J	3384	Feed (upper) Regulator Thumb Screw Stop Bracket Screw.....
4908	3366	Feed (upper) Shaft.....
*4892	—	" " " " Bracket (back).....
129E	3384	" " " " " Screw
*4891	—	" " " " " (front).....
129E	3384	" " " " " " Screw
16793	3374	Feeding Foot.....
217J	3384	" " " Screw.....
3126	259	Guide Bar.....
*56752	—	" " 3126 with 2361 and two 2362..
16794	—	Guide Bar complete, Nos. 810D, 810E, 4723, 4897, 16789, 56752 and three 404j
4854	389	Guide Bar Driving Crank with 1862 and 3131.....
1862	297	Guide Bar Driving Crank Roller (roller only).....
3131	297	Guide Bar Driving Crank Roller Cap....
3094	297	" " " " " Wedge.....
690E	312	" " " " " " Screw..
4723	389	" " " Lifting Bracket.....
404J	3385	" " " " " Screw.....
2058	3365	Lifting Presser Bar.....
3133	259	" " " Bracket with 641E and 1823.....
641E	3384	Lifting Presser Bar Bracket Clamping Screw.....
1823	221	Lifting Presser Bar Bracket Roller and Stud.....
4855	3366	Lifting Presser Bar Lifter.....
598c	3385	" " " " " Screw.....
4897	3365	" " " " Lifting Bell Crank
810E	379	" " " " " " " Hinge Cap Screw.....
4725	3365	Lifting Presser Bar Lifting Bracket.....

NO.	PLATE	NAME
4726	3383	Lifting Presser Bar Lifting Bracket Guide Pin.....
3100	301	Lifting Presser Bar Spring.....
2070	221	" " " " Washer.....
16795	3374	" " Foot.....
193j	20883	" " Screw.....
7060	3365	Needle Bar.....
*4898	3367	" " Connecting Link with 390E...
56764	—	" " " " 4898 with 15472.....
390E	3385	Needle Bar Connecting Link Adjusting Screw.....
15472	3389	Needle Bar Connecting Stud with 155c...
155c	3384	" " " " Set Screw...
2306	375	" " Thread Guard.....
233j	3384	" " " " Screw.....
336F	3384	" Set Screw.....
*6022	367	Oscillating Rock Shaft with 4784.....
16806	—	Oscillating Rock Shaft complete, Nos. 6022 and 56812.....
3052	367	Oscillating Rock Shaft Hinge Pin.....
56812	—	" " " " 3052 with 1513j.....
1513j	379	Oscillating Rock Shaft Hinge Pin Nut.....
4784	3383	" " " Oil Pad.....
6023	364	" Shaft.....
*6056	—	" Crank with 460c and 1813
6024	377	" " " " 1813 and two 462c.....
2049	221	Oscillating Shaft Crank Pin.....
1813	221	" " " Roller and Stud...
460c	3379	" " " Set Screw for 6056
462c	3385	" " " " " 6024
262j	312	Pressure Regulating Thumb Screw.....
2073	217	Shuttle Bobbin.....
2211	217	" " Retaining Spring.....
2212	217	" " " " Rivet...
*6058	—	" Body with 398E, 2082, 2084, 2211 and two 2212.....
*15458	—	Shuttle Cover.....
125017	—	" " 15458 with 112E, 466H, 2078, 2080, 2086 and 2090.....
2076	217	Shuttle Cover Hinge Pin.....
2078	217	" Delivery Eye Thread Guard.....
2080	217	" " " " Rivet
2082	217	" Main Spring.....
398E	217	" " " Screw.....
2084	217	" " " Steady Pin.....

NO.	PLATE	NAME
466H	217	Shuttle Tension Regulating Screw.....
2086	217	" " Spring.....
2090	217	" " " Plate.....
112E	217	" " " " Screw.....
16892	20880	Shuttle (high point) complete, Nos. 2073, 2076, 6058 and 125017.....
6029	367	Shuttle Driver and Feed Lifting Cam....
2049	221	" " " " " Pin
16796	—	" Race Ring.....
16797	3369	" " " 16796 with 65059 and two 337j.....
16688	—	Shuttle Race Ring Cover.....
16689	382	" " " " 16688 with 16242 and two 725j.....
16242	20880	Shuttle Race Ring Cover Latch.....
725j	312	" " " " " Screw...
50250j	3388	" " " " Screw.....
175j	3384	" " " Screw.....
65059	20879	" " " Thread Protector.....
337j	3385	" " " " " Screw
2102	377	Tension Disc.....
1560c	379	" Regulating Thumb Nut.....
4378	3367	" Releaser.....
2269	377	" " Hinge Pin.....
600c	379	" Screw Stud.....
16202	—	" " " 600c with 1560c.....
448c	379	" " " Set Screw.....
2103	377	" Spring.....
2105	377	" Thread Guard.....
56791	—	Tension complete, Nos. 2103, 2124, 16202 and two 2102.....
2112	221	Thread Retaining Disc with 2113.....
2113	221	" " " Steady Pin.....
2114	221	" " Spring.....
2115	221	" " Stud.....
460c	3379	" " " Set Screw.....
2111	221	Thread Retainer Guide complete, Nos. 2112, 2114 and 2115.....
*65003	—	Thread Take-up Cam.....
6450	382	" " " 65003 with 446c...
3012	297	" " " Pin.....
446c	312	" " " Set Screw.....
*3072	259	" " Lever with 1819.....
56855	—	" " " 3072 with 1088c...
1088c	3388	" " " Hinge Screw.....
1819	379	" " " Roller and Stud...
2124	221	" " Spring.....

NO.	PLATE	NAME
2127	221	Thread Take-up Spring Regulator Plate
233j	3384	" " " " " "
		Adjusting Screw.....
16798	3355	Throat Plate for 16786.....
401d	3385	" " Screw.....
6053	380	Drip Pan.....
*15404	—	Trade Mark.....
15405	20883	" " Rivet.....

GUIDE (Adjustable)

FOR SWEAT BANDS

NO.	PLATE	NAME
36481	3387	Guide Arm.....
36482	3387	" " Hinge Plate.....
36483	3387	" " " " Pin.....
198j	3384	" " " " " Set Screw...
190j	3384	" " Screw.....
668d	3385	" " " Stud.....
42041	3383	" " Spring.....
1560c	379	" " " Regulating Thumb Nut
36484	3387	" Bed with 198j.....
36485	3387	" Lever.....
974d	3385	" " Hinge Screw.....
36486	3387	" Smoothing Arm.....
668d	3385	" " " Screw Stud.....
42041	3383	" " " Spring.....
1560c	379	" " " " Regulating Thumb Nut.....
36487	—	Guide (adjustable) complete, Nos. 190j, 974d, 36481 to 36486 and two each 668d, 1560c and 42041.....
190j	3384	Guide Screw.....

LIST OF PARTS COMPLETE

FOR

MACHINE No. 17-27

C. B., CYLINDER 1 7/8 INCH DIAMETER. NO FEEDING MECHANISM. KNEE LIFTER. PRESSER FOOT RISES AUTOMATICALLY AFTER EACH STITCH IS MADE. ESPECIALLY DESIGNED FOR DARNING STOCKINGS AND SIMILAR ARTICLES; ALSO HAS REMOVABLE CLOTH PLATE No. 16697 USED IN DARNING TABLE LINEN, TOWELS, ETC. (Obsolete).

NO.	PLATE	NAME
*6001	—	Arm with 4448, 4449, 15404 and two 15405
4389	3383	" Dowel Pin.....
4448	3383	" Oil Tube for intermediate bearing...
123E	312	" Screw.....
4368	364	" Shaft.....
3005	259	" " Bushing (back).....
448c	379	" " " " " Set Screw.....
*4449	—	" " " " (front).....
144d	3384	" " Screw.....
4288	368	" Side Cover.....
286d	3385	" " " Thumb Screw.....
12403	377	" Spool Pin and Thread Eyelet.....
11241	382	" " " Washer (cloth).....
4370	364	Balance Wheel, heavy rim, 2 3/4 in. pulley, with two 448c.....
2862	364	Balance Wheel, heavy rim, 3 in. pulley, for 3022.....
448c	379	Balance Wheel Set Screw.....
2139	366	" " " Speed Pulley, 1 1/4 in. diam., with 451c.....
2140	366	Balance Wheel Speed Pulley, 2 1/8 in. diam., with 437c.....
451c	3385	Balance Wheel Speed Pulley Set Screw for 2139.....
437c	3385	Balance Wheel Speed Pulley Set Screw for 2140.....
256j	259	Clamp Stop Motion Clamp Screw.....
248A	3385	" " " " " Stop Screw...
2020	259	" " " " " Washer.....
*3023	—	" " " " " Flanged Bushing....
4933	259	" " " " " " 3023 with two 462c.....

NO.	PLATE	NAME
2022	221	Clamp Stop Motion Flanged Bushing Pin
462c	3385	" " " " " Set Screw
3022	—	Clamp Stop Motion complete, Nos. 248A, 256J, 2020 and 4933
16693	383	Cloth Plate
16694	383	" " Bracket with 345c
345c	379	" " " Set Screw
389F	312	" " Screw
16695	383	" " Slide
3286	368	" " " Spring
725J	312	" " " " Screw
16696	383	Cloth Plate complete, Nos. 3286, 16693, 16695 and two 725J
16697	—	Cloth Plate with Bracket complete, Nos. 16694, 16696 and two 389F
4292	364	Crank Connecting Rod
145E	3384	" " " Cap Screw
375c	312	" " " Hinge Screw
1518J	312	" " " " Nut
*16606	—	Cylinder, 1 7/8 in. diam.
4343	365	Face Plate
56796	—	" " 4343 with 2105
56775	—	Face Plate complete, Nos. 448c, 460c, 2107, 2111, 2127, 2269, 4369, 56791, 56796 and two 233J
164J	312	Face Plate Screw
2107	221	" " Thread Guard
233J	3384	" " " " Screw
4264	301	Needle Bar
*3045	301	" " Connecting Link
56773	—	" " " " 3045 with 2052
377c	312	Needle Bar Connecting Link Hinge Screw
1518J	312	" " " " " " Nut
2052	374	Needle Bar Connecting Stud with 155c
155c	3384	" " " " Set Screw
290E	3385	" " Screw Bushing
7524	3383	" Clamp with 196F, 651J and 7525
196F	3383	" " Screw
7525	3383	" " Thread Guide
651J	3383	" " " " Screw
16698	3378	" Plate with 16699 and two 2532
16699	3378	" " Thread Guard
2532	3378	" " " " Rivet
401D	3385	" " Screw

NO.	PLATE	NAME
*6022	367	Oscillating Rock Shaft with 4784
16806	—	Oscillating Rock Shaft complete, Nos. 6022 and 56812
3052	367	Oscillating Rock Shaft Hinge Pin
56812	—	" " " " " 3052 with 1513J
1513J	379	Oscillating Rock Shaft Hinge Pin Nut
4784	3383	" " " Oil Pad
16681	3366	" Shaft
*16682	—	" Crank with 1813
16683	386	" " " 16682 with two 462c
2019	221	Oscillating Shaft Crank Pin
1813	221	" " " Roller and Stud
462c	3385	" " " Set Screw
3054	301	Presser Bar
52016	20879	" " Lifter
689c	312	" " " Screw
1520E	379	" " " Nut
5608	259	" " Lifting Bracket with 453c
453c	3385	" " " " Set Screw
290E	3385	" " Screw Bushing
2308	301	" " Spring
2070	221	" " Washer
16700	3377	" Foot
16701	3377	" " Body
16702	3377	" " Bracket with 196F
196F	3377	" " " Set Screw
190J	3377	" " Cap Screw
16703	3377	" " " Washer
16704	3377	" " Driving Arm
87F	3377	" " " Hinge Screw
16705	3377	" " " Spring
1116J	3377	" " " " Screw
16706	3377	" " Guide
208J	3377	" " Screw
16707	3377	" " Lifting Lever with 196F
196F	3377	" " " Set Screw
16708	3377	" " Shaft and Arm (solid)
16709	3377	" " Spring
16710	3377	Presser Foot (spring) complete, Nos. 87F, 190J, 208J, 1116J and 16700 to 16709
190J	3384	Presser Foot Screw
262J	312	Pressure Regulating Thumb Screw
2996	386	Shuttle Bobbin
*62739	20880	" " Case
15140	386	" " " Latch

152 PARTS FOR MACHINE No. 17-27

NO.	PLATE	NAME
2973	386	Shuttle Bobbin Case Latch Lever.....
2974	386	" " " " " Fulcrum Pin.....
2975	386	Shuttle Bobbin Case Latch Spring.....
592E	386	" " " " Stop Screw...
15141	—	" " " Hinge, Nos. 2973, 2974 and 15140.....
15027	386	Shuttle Bobbin Case Position Finger.....
2523	386	" " " " " Rivet
15277	386	Shuttle Bobbin Case complete, Nos. 591F, 592E, 2523, 2975, 15027, 15141, 15278 and 62739.....
16614	386	Shuttle Body.....
591F	386	" Tension Regulating Screw.....
15278	386	" " Spring.....
16613	386	" 1½ in. diam. Nos. 2996, 15277 and 16614.....
16615	386	Shuttle Driver.....
2049	221	" " Pin.....
16711	3378	" Race.....
16712	3378	" " Cover.....
683J	3384	" " Screw.....
2102	377	Tension Disc.....
1560c	379	" Regulating Thumb Nut.....
4369	377	" Releaser.....
2269	377	" " Hinge Pin.....
600c	379	" Screw Stud.....
16202	—	" " " 600c with 1560c.....
448c	379	" " " Set Screw.....
2103	377	" Spring.....
2105	377	" Thread Guard.....
56791	—	Tension complete, Nos. 2103, 2124, 16202 and two 2102.....
2112	221	Thread Retaining Disc with 2113.....
2113	221	" " " Steady Pin.....
2114	221	" " Spring.....
2115	221	" " Stud.....
460c	3379	" " " Set Screw.....
2111	221	Thread Retainer Guide complete, Nos. 2112, 2114 and 2115.....
*56828	—	Thread Take-up Cam.....
3182	3369	" " " 56828 with 446c...
3012	297	" " " Pin.....
446c	312	" " " Set Screw.....
*3072	259	" " Lever with 1819.....
56855	—	" " " 3072 with 1088c...
1088c	3388	" " " Hinge Screw.....

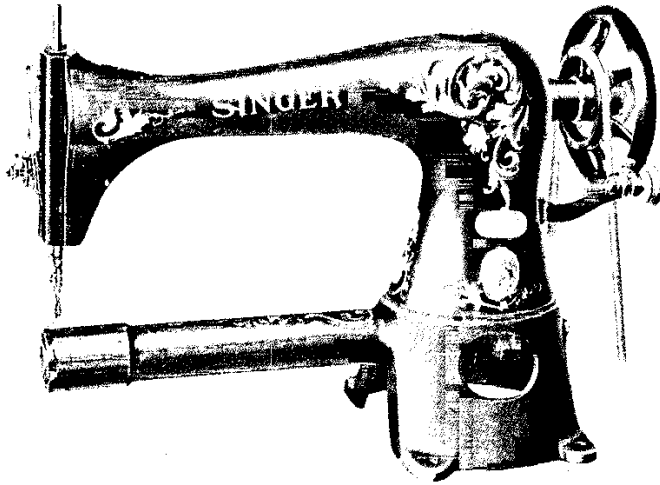
PARTS FOR MACHINE No. 17-27 153

NO.	PLATE	NAME
1819	379	Thread Take-up Lever Roller and Stud...
2124	221	" " Spring.....
2127	221	" " " Regulator Plate
233J	3384	" " " " "
		Adjusting Screw.....
6053	380	Drip Pan.....
*15404	—	Trade Mark.....
15405	20883	" " Rivet.....

SINGER Needles should be used
in SINGER Machines.
These Needles and their Containers
are marked with the
Company's Trade-Mark "SIMANCO."** 1

Needles in Containers marked
"FOR SINGER MACHINES"
are NOT **SINGER** made needles. 2

**LIST OF PARTS COMPLETE
FOR**



MACHINE No. 17-28

**FOR DARNING STOCKINGS. C. B., REMOVABLE
WORK PLATE No. 16720 FOR DARNING TABLE
LINEN, TOWELS, ETC. CYLINDER 1 7/8 INCHES
DIAMETER. NO FEEDING MECHANISM.
PRESSER RISES AUTOMATICALLY AFTER
EACH STITCH IS MADE.**

NO.	PLATE	NAME
*16716	—	Arm with 4448, 15404, 16717 and two 15405.....
4389	3383	Arm Dowel Pin.....
4448	3383	" Oil Tube for intermediate bearing....
123E	312	" Screw.....
4368	364	" Shaft.....
3005	259	" " Bushing (back).....
448c	379	" " " " Set Screw.....
*16717	—	" " " (front).....
144d	3384	" " Screw.....

PARTS FOR MACHINE No. 17-28 155

NO.	PLATE	NAME
4288	368	Arm Side Cover.....
286D	3385	" " " Thumb Screw.....
12403	377	" Spool Pin and Thread Eyelet.....
11241	382	" " " Washer (cloth).....
4370	364	Balance Wheel, heavy rim, 2 3/4 in. pulley, with two 448c.....
2862	364	Balance Wheel, heavy rim, 3 in. pulley, for 3022.....
448c	379	Balance Wheel Set Screw.....
2139	366	" " Speed Pulley, 1 1/4 in. diam., with 451c.....
2140	366	Balance Wheel Speed Pulley, 2 3/8 in. diam., with 437c.....
451c	3385	Balance Wheel Speed Pulley Set Screw for 2139.....
437c	3385	Balance Wheel Speed Pulley Set Screw for 2140.....
256J	259	Clamp Stop Motion Clamp Screw.....
248A	3385	" " " " Stop Screw.....
2020	259	" " " " Washer.....
*3023	—	" " " Flanged Bushing.....
4933	259	" " " " " 3023 with two 462c.....
2022	221	Clamp Stop Motion Flanged Bushing Pin
462c	3385	" " " " " Set Screw.....
3022	—	Clamp Stop Motion complete, Nos. 248A, 256J, 2020 and 4933.....
16718	383	Cloth Plate.....
16719	383	" " Bracket with 345c.....
345c	379	" " " Set Screw.....
389F	312	" " " Screw.....
16695	383	" " Slide.....
3286	368	" " " Spring.....
725J	312	" " " " Screw.....
16720	383	Cloth Plate complete, Nos. 3286, 16695, 16718 and two 725J.....
16721	—	Cloth Plate with Bracket complete, Nos. 16719, 16720 and two 389F.....
4292	364	Crank Connecting Rod.....
145E	3384	" " " Cap Screw.....
375c	312	" " " Hinge Screw.....
1518J	312	" " " " " Nut.....
*16837	—	Cylinder, 1 1/8 in. diam.....
16723	3364	Face Plate.....
16881	—	" " 16723 with 2105.....

NO.	PLATE	NAME
16883	—	Face Plate complete, Nos. 448c, 460c, 2107, 2127, 12296, 16881, 16882 and two 233J
164J	312	Face Plate Screw
2107	221	" " Thread Guard (lower)
233J	3384	" " " " " " Screw
12296	3379	" " " " " (upper)
460c	3379	" " " " " " Set Screw
16724	3365	Needle Bar
*3045	301	" " Connecting Link
56773	—	" " " " " 3045 with 2052
377c	312	" " " " " Hinge Screw
1518J	312	" " " " " " " "
		Nut
2052	374	Needle Bar Connecting Stud with 155c
155c	3384	" " " " " Set Screw
290E	3385	" " Screw Bushing
16725	3379	" " Thread Eyelet
662J	3379	" " " " " Screw
1678c	3379	" Clamping Nut
16726	3379	" Plate, large needle hole
16727	—	" " small needle hole
1231b	3379	" " Screw
*6022	367	Oscillating Rock Shaft with 4784
16806	—	Oscillating Rock Shaft complete, Nos. 6022 and 56812
3052	367	Oscillating Rock Shaft Hinge Pin
56812	—	" " " " " " 3052 with 1513J
1513J	379	Oscillating Rock Shaft Hinge Pin Nut
4784	3383	" " " Oil Pad
6462	3366	" Shaft
*7225	—	" " Crank with 1813
7054	3380	" " " 7225 with two 462c
2049	221	" " " Pin
1813	221	" " " Roller and Stud
462c	3385	" " " Set Screw
16728	3365	Presser Bar
16729	3379	" " Guide Bracket with 50022c
52016	20879	" " Lifter
689c	312	" " " Screw
1520E	379	" " " Nut
16730	3379	" " Lifting Rock Shaft
16731	3379	" " " " " Arm with 172c and 1979
172c	3379	Presser Bar Lifting Rock Shaft Arm Clamping Screw

NO.	PLATE	NAME
1979	3379	Presser Bar Lifting Rock Shaft Arm Roller and Screw Stud
16732	3379	Presser Bar Lifting Rock Shaft Arm Spring
16733	3379	Presser Bar Lifting Rock Shaft Link
810b	3379	" " " " " " Cap Screw
50022c	3379	Presser Bar Lifting Rock Shaft Link Hinge Screw
290E	3385	Presser Bar Screw Bushing
3100	301	" " Spring
2070	221	" " " Washer
*65037	—	" Foot
65038	20879	" " Finger Guard
65039	20879	Presser Foot with Finger Guard complete, Nos. 65037 and 65038
190J	3384	Presser Foot Screw
50334J	3388	Pressure Regulating Thumb Screw
1632c	3388	" " " " " Lock Nut
2996	386	Shuttle Bobbin
15140	386	" " Case Latch
2973	386	" " " " " Lever
2974	386	" " " " " Fulcrum Pin
2975	386	Shuttle Bobbin Case Latch Spring
592E	386	" " " " " Stop Screw
15141	—	" " " Hinge, Nos. 2973, 2974 and 15140
39623	20879	Shuttle Bobbin Case Position Finger
2523	386	" " " " " Rivet
40112	20880	Shuttle Bobbin Case complete, Nos. 591F, 592E, 2523, 2975, 15141, 15278 and 39623
16614	386	Shuttle Body
591F	386	" Tension Regulating Screw
15278	386	" " Spring
16735	3380	" " 1½ in. diam., Nos. 2996, 16614 and 40112
16736	3380	Shuttle Driver
65040	20879	" " for No. 23 Needle
2049	221	" " Pin
16838	3393	" Race
16738	3380	" " Cover
979D	3380	" " " Hinge Screw
50258J	3388	" " Screw
2102	377	Tension Disc
1560c	379	" Regulating Thumb Nut

NO.	PLATE	NAME
600c	379	Tension Screw Stud.....
16202	—	“ “ “ 600c with 1560c.....
448c	379	“ “ “ Set Screw.....
10148	3380	“ Spring.....
2105	377	“ Thread Guard.....
16882	—	Tension complete, Nos. 10148, 16202, 16766 and two 2102.....
*65055	—	Thread Take-up Cam.....
65056	20877	“ “ “ 65055 with 446c....
3012	297	“ “ “ Pin.....
446c	312	“ “ “ Set Screw.....
*16740	3366	“ “ Lever with 1819.....
65034	—	“ “ “ 16740 with 1088c....
1088c	3388	“ “ “ Hinge Screw.....
1819	379	“ “ “ Roller and Stud....
16766	3380	“ “ Spring.....
2127	221	“ “ “ Regulator Plate.....
233j	3384	“ “ “ “ “ “
		Adjusting Screw.....
6053	380	Drip Pan.....
*15404	—	Trade Mark.....
15405	20883	“ “ Rivet.....

SINGER Needles should be used
in SINGER Machines.
These Needles and their Containers
are marked with the
Company's Trade-Mark "SIMANCO." 1

Needles in Containers marked
"FOR SINGER MACHINES"
are NOT **SINGER** made needles. 2

LIST OF PARTS COMPLETE
FOR
MACHINE No. 17-29

FOR PUMPS, EYELET TIES, BLUCHER OXFORDS,
ETC. HAS HORIZONTAL UNDER TRIMMER,
CYLINDER BED 2 1/8 INCHES DIAMETER, DROP
FEED ACROSS ARM AND ROLLER PRESSER.

NO.	PLATE	NAME
*6001	—	Arm with 4448, 4449, 15404 and two 15405
4389	3383	“ Dowel Pin.....
4448	3383	“ Oil Tube for intermediate bearing...
123E	312	“ Screw.....
4368	364	“ Shaft.....
3005	259	“ “ Bushing (back).....
448c	379	“ “ “ “ Set Screw.....
*4449	—	“ “ “ (front).....
144D	3384	“ “ Screw.....
4288	368	“ Side Cover.....
286D	3385	“ “ Thumb Screw.....
12403	377	“ Spool Pin and Thread Eyelet.....
11241	382	“ “ “ Washer (cloth).....
4370	364	Balance Wheel, heavy rim, 2 3/4 in. pulley, with two 448c.....
2862	364	Balance Wheel, heavy rim, 3 in. pulley, for 3022.....
448c	379	Balance Wheel Set Screw.....
2139	366	“ “ Speed Pulley, 1 1/8 in. diam., with 451c.....
2140	366	Balance Wheel Speed Pulley, 2 1/8 in. diam., with 437c.....
451c	3385	Balance Wheel Speed Pulley Set Screw for 2139.....
437c	3385	Balance Wheel Speed Pulley Set Screw for 2140.....
256j	259	Clamp Stop Motion Clamp Screw.....
248A	3385	“ “ “ “ Stop Screw...
2020	259	“ “ “ “ Washer.....
*3023	—	“ “ “ Flanged Bushing....
4933	259	“ “ “ “ “ 3023 with two 462c.....
2022	221	Clamp Stop Motion Flanged Bushing Pin
462c	3385	“ “ “ “ “ Set Screw.....

NO.	PLATE	NAME
3022	—	Clamp Stop Motion complete, Nos. 248A, 256J, 2020 and 4933.....
4292	364	Crank Connecting Rod.....
145E	3384	" " " Cap Screw.....
375c	312	" " " Hinge Screw.....
1518J	312	" " " " Nut.
*16812	—	Cylinder, 2 1/4 in. diam.....
4343	365	Face Plate.....
56796	—	" " 4343 with 2105.....
56775	—	Face Plate complete, Nos. 448c, 460c, 2107, 2111, 2127, 2269, 4369, 56791, 56796 and two 233J.....
164J	312	Face Plate Screw.....
2107	221	" " Thread Guard.....
233J	3384	" " " " Screw.....
3032	259	Feed Cam with 446c.....
446c	312	" " Set Screw.....
3033	259	" Connecting Link.....
375c	312	" " " Hinge Screw.....
1518J	312	" " " " " Nut..
16744	3382	" Dog, 12 teeth (16 teeth to the inch) for 65033.....
16846	3390	Feed Dog, 17 teeth (24 teeth to the inch) for 65033.....
65058	20879	Feed Dog (diagonal spiked teeth) for 65033
6016	366	" " Carrier.....
225c	379	" " Screw.....
3037	364	" Forked Connection.....
375c	312	" " " Hinge Screw....
1518J	312	" " " " " Nut
3039	259	" Regulator.....
58E	312	" " Hinge Screw.....
818D	379	" " Thumb Screw.....
16745	3366	" Rock Shaft.....
6018	366	" " " Crank with 207F.....
150F	379	" " " " Position Screw...
207F	3384	" " " " Set Screw.....
24586	3381	Knife without Guide (corner bent up) for under trimming.....
24587	—	Knife without Guide (corner bent up) and Holder (sectional) complete, for under trimming, Nos. 24174, 24586 and two 602F.....
65063	20880	Knife Driving Lever.....
65064	—	Knife Driving Lever complete, Nos. 104D, 217J, 16749, 24173, 65063 and 65065 ..

NO.	PLATE	NAME
65065	20880	Knife Driving Lever Adjusting Block with 24177.....
217J	3384	Knife Driving Lever Adjusting Block Screw
16748	3381	" " " Cam with two 465c..
465c	3381	" " " " Set Screw.....
24170	3381	" " " Center Plate.....
24171	3381	" " " " " Cap.....
934J	3381	" " " " " " Screw
756D	3381	" " " " " " Screw...
16749	3381	" " " " Fork.....
16750	3382	" " " " Cover.....
233J	3382	" " " " " Screw.....
24173	3381	" " " " Swivel.....
104D	3381	" " " " " Screw....
16751	3382	" " " Plate.....
16752	3382	" " " " Holder.....
1346D	3382	" " " " " Screw....
50027F	3382	" " " " " Screw.....
24174	3381	" Holder.....
1098c	3381	" " Adjusting Screw.....
886c	3381	" " " " Binding Screw
24175	3381	" " Bushing.....
16753	3381	" " Position Spring.....
24177	3381	" " " Stud.....
24188	—	" " Regulator, Nos. 886c and 1098c.....
50998K	20883	Knife Holder Screw.....
1097F	3381	" " Stop Screw.....
602F	20883	" Screw.....
4264	301	Needle Bar.....
*3045	301	" " Connecting Link.....
56773	—	" " " " 3045 with 2052
377c	312	" " " " Hinge Screw
1518J	312	" " " " " " "
		Nut.....
2052	374	Needle Bar Connecting Stud with 155c...
155c	3384	" " " " Set Screw...
290E	3385	" " Screw Bushing.....
16813	3389	" Clamp with 196F.....
16814	—	Needle Clamp complete, Nos. 665J, 16813 and 16815.....
196F	3383	Needle Clamp Screw.....
16815	3389	" " Thread Guide.....
665J	3384	" " " " Screw.....
*6022	367	Oscillating Rock Shaft with 4784.....
16806	—	Oscillating Rock Shaft complete, Nos. 6022 and 56812.....

162 PARTS FOR MACHINE No. 17-29

NO.	PLATE	NAME
3052	367	Oscillating Rock Shaft Hinge Pin.....
56812	—	“ “ “ “ “ 3052with 1513J.....
1513J	379	Oscillating Rock Shaft Hinge Pin Nut....
4784	3383	“ “ “ Oil Pad.....
16754	3366	“ Shaft.....
*6056	—	“ Crank with 460c and 1813
6024	377	“ “ “ “ 1813 and two 462c.....
2049	221	Oscillating Shaft Crank Pin.....
1813	221	“ “ “ Roller and Stud..
460c	3379	“ “ “ Set Screw for 6056
462c	3385	“ “ “ “ “ “ 6024
3054	301	Presser Bar.....
52016	20879	“ “ Lifter.....
689c	312	“ “ “ Screw.....
1520E	379	“ “ “ Nut.....
5608	259	“ “ Lifting Bracket with 453c....
453c	3385	“ “ “ Set Screw....
290E	3385	“ “ Screw Bushing.....
3056	301	“ “ Spring (heavy).....
2308	301	“ “ “ (light).....
2070	221	“ “ “ Washer.....
262J	312	Pressure Regulating Thumb Screw.....
1987	3371	Roller, 1¼ in. diam., coarse, with 386D and 1528J, for 16755.....
1932	—	Roller, 1¼ in. diam., fine, with 386D and 1528J, for 65046.....
16098	3371	Roller Arm.....
440F	231	“ “ Adjusting Screw.....
1547J	231	“ “ “ Nut.....
4282	3371	“ “ Bracket.....
316F	231	“ “ “ Screw Center.....
15444	—	“ “ “ “ “ 316F with 1547J.....
1547J	231	Roller Arm Bracket Screw Center Nut....
2205	231	“ “ Lock Spring.....
176J	231	“ “ “ “ Screw.....
1549J	231	“ “ “ “ “ Nut.....
16755	3371	Roller Presser complete, 1¼ in. coarse roller, Nos. 176J, 440F, 1547J, 1549J, 1987, 2205, 4282, 16098 and two 15444
386D	3385	Roller Screw.....
1528J	3386	“ “ Nut.....
65046	20881	Roller Presser complete, 1¼ in. fine roller, Nos. 176J, 440F, 1547J, 1549J, 1932, 2205, 4282, 16098 and two 15444.....

PARTS FOR MACHINE No. 17-29 163

NO.	PLATE	NAME
51860	—	Roller, 1¼ in. diam.....
16232	20882	“ Ball.....
1766c	20882	“ “ Retaining Nut.....
50553c	20882	“ Screw.....
1528J	3386	“ “ Nut.....
51861	20883	Roller, 1¼ in. diam., ½ in. face, coarse, (ball bearing) complete, Nos. 1528J, 1766c, 50553c, 51860 and twenty-four 16232.....
16230	20882	Roller Arm.....
440F	231	“ “ Adjusting Screw.....
1547J	231	“ “ “ “ Nut.....
4282	3371	“ “ Bracket.....
316F	231	“ “ “ Screw Center.....
15444	—	“ “ “ “ “ 316F with 1547J.....
1547J	231	Roller Arm Bracket Screw Center Nut....
2205	231	“ “ Lock Spring.....
176J	231	“ “ “ “ Screw.....
1549J	231	“ “ “ “ “ Nut.....
65041	20881	Roller Presser (ball bearing) complete, 1¼ in. coarse roller, Nos. 167J, 440F, 1547J, 1549J, 2205, 4282, 16230, 51861 and two 15444.....
190J	3384	Roller Presser Screw.....
2073	217	Shuttle Bobbin.....
2211	217	“ “ Retaining Spring.....
2212	217	“ “ “ “ Rivet....
*6058	—	“ Body with 398E, 2082, 2084, 2211 and two 2212.....
*15458	—	Shuttle Cover.....
125017	—	“ “ 15458 with 112E, 466H, 2078, 2080, 2086 and 2090.....
2076	217	Shuttle Cover Hinge Pin.....
2078	217	“ Delivery Eye Thread Guard.....
2080	217	“ “ “ “ “ Rivet
2082	217	“ Main Spring.....
398c	217	“ “ “ Screw.....
2084	217	“ “ “ Steady Pin.....
466H	217	“ Tension Regulating Screw.....
2086	217	“ “ Spring.....
2090	217	“ “ “ Plate.....
112E	217	“ “ “ “ Screw.....
16892	20880	Shuttle (high point) complete, Nos. 2073, 2076, 6058 and 125017.....
6029	367	Shuttle Driver and Feed Lifting Cam....

164 PARTS FOR MACHINE No. 17-29

NO.	PLATE	NAME
2049	221	Shuttle Driver and Feed Lifting Cam Pin
16816	3393	" Race.....
50037F	3380	" " Screw.....
16756	—	" " Ring.....
16757	3369	" " " 16756 with 65059 and two 767J.....
16688	—	Shuttle Race Ring Cover.....
16689	382	" " " " 16688 with 16242 and two 725J.....
16242	20880	Shuttle Race Ring Cover Latch.....
725J	312	" " " " Screw....
50250J	3388	" " " " Screw.....
175J	3384	" " " Screw.....
65059	20879	" " " Thread Protector.....
767J	379	" " " " Screw
2102	377	Tension Disc.....
1560c	379	" Regulating Thumb Nut.....
4369	377	" Releaser.....
2269	377	" " Hinge Pin.....
600c	379	" Screw Stud.....
16202	—	" " " 600c with 1560c....
448c	379	" " " Set Screw.....
2103	377	" Spring.....
2105	377	" Thread Guard.....
56791	—	Tension complete, Nos. 2103, 2124, 16202 and two 2102.....
2112	221	Thread Retaining Disc with 2113.....
2113	221	" " " Steady Pin.....
2114	221	" " Spring.....
2115	221	" " Stud.....
460c	3379	" " " Set Screw.....
2111	221	Thread Retainer Guide complete, Nos. 2112, 2114 and 2115.....
*56831	—	Thread Take-up Cam.....
3280	382	" " " 56831 with 446c....
3012	297	" " " Pin.....
446c	312	" " " Set Screw.....
*3072	259	" " Lever with 1819.....
56855	—	" " " 3072 with 1088c..
1088c	3388	" " " Hinge Screw.....
1819	379	" " " Roller and Stud...
2124	221	" " Spring.....
2127	221	" " " Regulator Plate
233J	3384	" " " " " "
		Adjusting Screw.....
65031	—	Throat Plate, large needle hole, for 335...

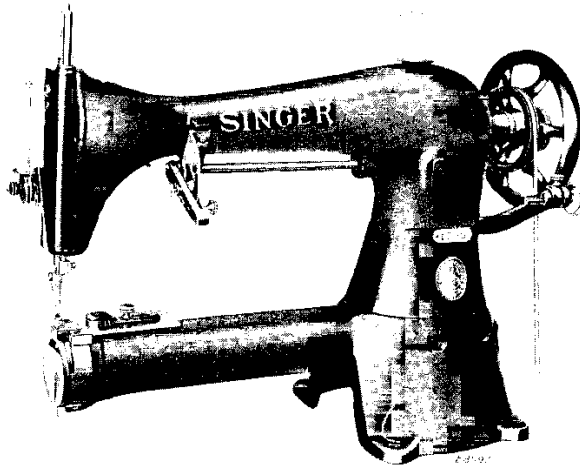
PARTS FOR MACHINE No. 17-29 165

NO.	PLATE	NAME
65033	3390	Throat Plate, large needle hole, complete for 335, for 16744, 16846 and 65058, Nos. 65031, 65032 and two 238D.....
65032	3390	Throat Plate Needle Hole Strip, large needle hole.....
16760	3382	Throat Plate Needle Hole Strip, small needle hole.....
238D	3382	Throat Plate Needle Hole Strip Screw....
335D	3386	" " Screw for 65031 and 65033..
65066	—	Trimming Attachment (adjustable) com- plete, Nos. 1097F, 16751, 16753, 24170, 24175, 24188, 24587, 50998K, 65064, two each 756D, 24171 and four 934J.....
6053	380	Drip Pan.....
*15404	—	Trade Mark.....
15405	20883	" " Rivet.....

SINGER Needles should be used
in SINGER Machines.
These Needles and their Containers
are marked with the
Company's Trade-Mark "SIMANCO.***" 1

Needles in Containers marked
"FOR SINGER MACHINES"
are NOT **SINGER** made needles. 2

**LIST OF PARTS COMPLETE
FOR**



MACHINE No. 17-30

**FOR STITCHING GUSSETS IN PORTFOLIOS,
POCKETBOOKS, ETC. HAS REVERSIBLE
DROP FEED ACROSS ARM.**

NO.	PLATE	NAME
*16687	---	Arm with 4448, 4449, 15404 and two 15405
4389	3383	" Dowel Pin.....
4448	3383	" Oil Tube for intermediate bearing...
123E	312	" Screw.....
4368	364	" Shaft.....
3005	259	" " Bushing (back).....
448c	379	" " " " Set Screw.....
*4449	---	" " " (front).....
144D	3384	" " Screw.....
4288	368	" Side Cover.....
286D	3385	" " " Thumb Screw.....
12403	377	" Spool Pin and Thread Eyelet.....
11241	382	" " " Washer (cloth).....

PARTS FOR MACHINE No. 17-30 167

NO.	PLATE	NAME
2135	3392	Balance Wheel, heavy rim, 2½ in. pulley..
4370	364	" " " " 2¾ in. pulley, with two 448c.....
2862	364	Balance Wheel, heavy rim, 3 in. pulley for 3022.....
448c	379	Balance Wheel Set Screw.....
2139	366	" " Speed Pulley, 1 ⅜ in. diam., with 451c.....
2140	366	Balance Wheel Speed Pulley, 2 ⅜ in. diam., with 437c.....
451c	3385	Balance Wheel Speed Pulley Set Screw for 2139.....
437c	3385	Balance Wheel Speed Pulley Set Screw for 2140.....
256J	259	Clamp Stop Motion Clamp Screw.....
248A	3385	" " " " Stop Screw...
2020	259	" " " " Washer.....
*3023	---	" " " Flanged Bushing....
4933	259	" " " " " 3023 with two 462c.....
2022	221	Clamp Stop Motion Flanged Bushing Pin
462c	3385	" " " " " Set Screw.....
3022	---	Clamp Stop Motion complete, Nos. 248A, 256J, 2020 and 4933.....
65013	3394	Cloth Plate.....
65014	3394	" " Bracket with two 345c.....
345c	379	" " " " Set Screw.....
65015	3394	" " Slide.....
3286	368	" " " Spring.....
725J	312	" " " " " Screw.....
65016	3394	Cloth Plate complete, Nos. 3286, 65013, 65015 and two 725J.....
65017	---	Cloth Plate with Bracket complete, Nos. 65014, 65016 and two 389F.....
389F	312	Cloth Plate Screw.....
4292	364	Crank Connecting Rod.....
145E	3384	" " " " Cap Screw.....
375c	312	" " " " " Hinge Screw.....
1518J	312	" " " " " " Nut.
*16863	---	Cylinder, 2 ⅞ in. diam.....
65073	20877	Face Plate.....
65074	---	" " 65073 with 2105.....
65075	---	Face Plate complete, Nos. 448c, 460c, 2107, 2111, 2127, 2269, 4369, 56791, 65074 and two 233J.....

NO.	PLATE	NAME
164J	312	Face Plate Screw.....
2107	221	" " Thread Guard.....
233J	3384	" " " " Screw.....
3032	259	Feed Cam with 446c.....
446c	312	" " Set Screw.....
3033	259	" Connecting Link.....
375c	312	" " " " Hinge Screw.....
1518J	312	" " " " " Nut..
65076	20878	" Dog, 5 teeth (20 teeth to the inch) for 65084.....
16677	388	Feed Dog Carrier.....
225c	379	" " Screw.....
16678	3368	" Forked Connection.....
375c	312	" " " " Hinge Screw.....
1518J	312	" " " " " " Nut
5544	259	" Regulator Crank with two 448c.....
448c	379	" " " " Set Screw.....
6808	368	" " " " Lever with 207F.....
6809	—	Feed Regulator Lever complete, Nos. 190J, 6808 and 6810.....
286D	3385	Feed Regulator Lever Adjusting Thumb Screw.....
1584E	379	Feed Regulator Lever Adjusting Thumb Screw Nut.....
3146	3388	Feed Regulator Lever Adjusting Thumb Screw Nut Washer.....
6810	368	Feed Regulator Lever Friction Plate.....
190J	3384	" " " " " " Screw
732D	379	" " " " " " Thumb Screw.....
2049	221	Feed Regulator Lever Pin.....
16865	3392	" " " " Segment.....
330J	379	" " " " " Screw....
207F	3384	" " " " " Set Screw.....
5550	3366	" " " " " Shaft.....
6017	364	" Rock Shaft.....
6019	366	" " " " Crank with 207F.....
156F	379	" " " " " Position Screw...
207F	3384	" " " " " Set Screw.....
6440	371	Guide (foller) Nos. 1852 and 6441.....
65049	20882	" " " " 1852 and 65050.....
65050	20882	" Bracket.....
6441	371	" " " " ".....
1852	371	" Roller and Screw Stud.....
286D	3385	" Thumb Screw.....
3044	301	Needle Bar.....
*3045	301	" " Connecting Link.....

NO.	PLATE	NAME
56773	—	Needle Bar Connecting Link 3045 with 2052.....
377c	312	Needle Bar Connecting Link Hinge Screw
1518J	312	" " " " " " " Nut.....
2052	374	Needle Bar Connecting Stud with 155c...
155c	3384	" " " " " " Set Screw...
290E	3385	" " Screw Bushing.....
2166	221	" " Thread Guard.....
233J	3384	" " " " " " Screw.....
2167	221	" Clamp with 196F.....
196F	3383	" " Screw.....
*6022	367	Oscillating Rock Shaft with 4784.....
16806	—	Oscillating Rock Shaft complete, Nos. 6022 and 56812.....
3052	367	Oscillating Rock Shaft Hinge Pin.....
56812	—	" " " " " " 3052 with 1513r.....
1513J	379	Oscillating Rock Shaft Hinge Pin Nut....
4784	3383	" " " " Oil Pad (felt).....
6023	364	" Shaft.....
*6056	—	" " Crank with 460c and 1813.....
6024	377	Oscillating Shaft Crank with 1813 and two 462c.....
2049	221	Oscillating Shaft Crank Pin.....
1813	221	" " " " Roller and Stud..
460c	3379	" " " " " Set Screw for 6056
462c	3385	" " " " " " " 6024
2058	3365	Presser Bar.....
52016	20879	" " Lifter.....
689c	312	" " " " " Screw.....
1520E	379	" " " " " Nut.....
5608	259	" " Lifting Bracket with 453c....
453c	3385	" " " " " " Set Screw....
290E	3385	" " Screw Bushing.....
2308	301	" " Spring.....
2070	221	" " " " Washer.....
16366	3395	" Foot.....
190J	3384	" " Screw.....
262J	312	Pressure Regulating Thumb Screw.....
2073	217	Shuttle Bobbin.....
2211	217	" " " " Retaining Spring.....
2212	217	" " " " " Rivet....
*16867	—	" " Body with 398E, 2082, 2084, 2211 and two 2212.....
*16868	—	Shuttle Cover.....

BINDER

**FOR CIRCULAR BINDING. FOR SANDALS,
SLIPPERS, SHOE TONGUES, ETC.
FOR MACHINE No. 17-8**

NO.	PLATE	NAME
6010	3363	Feed Dog, 12 teeth, for 28820
120493	20882	Folder with two 51022J, for $\frac{1}{4}$ in. to $\frac{1}{2}$ in. gauges
120494	20882	Folder with two 1368J, for $\frac{1}{2}$ in. to $\frac{3}{4}$ in. gauges
120495	20882	Folder with two 1368J, for $\frac{3}{4}$ in. to 1 in. gauges
51022J	20882	Folder Screw for 120493
1368J	20882	" " " 120494 and 120495
207F	3363	" " "
7071	3363	" " Washer
28367	3363	Lifting Presser Foot
28819	3363	Ribbon Guide
337J	3363	" " Screw
28820	3363	Throat Plate for 6010
28370	3363	Vibrating Presser Foot
28821	—	Binder complete, Nos. 207F, 337J, 6010, 7071, 28367, 28370, 28819, 28820, 120493, 120494 or 120495

BINDERS ON SHANK

NO.	PLATE	NAME
26823	3363	Binder on Shank, for bicycle saddles, for 17-1 Machine
35116	3362	Binder on Shank, for raw edge binding, for tobacco pouches, etc., for 17-16 Machine
35117	3362	Presser Foot for 35116

TAPE HOLDER (Straight)

6 INCH DISC

NO.	PLATE	NAME
35821	1518	Bracket Wire
35822	1518	Bracket Wire complete, Nos. 26918, 35821 and 35823
35823	—	Disc
35824	1518	" Hub
35825	1518	Disc complete, Nos. 35823 and 35824
26918	1518	Tape Guide

TAPE HOLDER (STRAIGHT)

NO.	PLATE	NAME
35826	3375	Tension Adjusting Collar with 286D
286D	3385	" " " Thumb Screw
13211	3375	" " Spring
35827	1518	Tape Holder (straight) 6 in. disc, com- plete, Nos. 13211, 35822, 35825 and 35826
190J	3384	Tape Holder Set Screw

BOBBIN WINDERS**BOBBIN WINDER**

(LOOSE WHEEL)

**FOR MACHINES Nos. 17-1 TO 17-4, 17-6 TO 17-11,
17-13 TO 17-17, 17-19, 17-21, 17-29 AND 17-30**

NO.	PLATE	NAME
2466	310	Eccentric
286D	3385	" Thumb Screw
5526	310	Frame
2460	310	Friction Ring (rubber)
2461	310	Pulley
2468	310	Spindle
2469	—	" 2468 with 2461
5525	310	Bobbin Winder complete, Nos. 286D, 2460, 2466, 2469 and 5526
1489J	3388	Bobbin Winder Screw

BOBBIN WINDER

(TIGHT WHEEL)

**FOR MACHINES Nos. 17-1 TO 17-4, 17-6 TO 17-11,
17-13 TO 17-17, 17-19, 17-21, 17-29 AND 17-30**

NO.	PLATE	NAME
15072	3383	Bobbin Position Pin
5522	310	Frame
2460	310	Friction Ring (rubber)
2461	310	Pulley
2462	310	Spindle with 15072
2463	—	" 2462 with 2461
2464	310	Spring
5521	310	Bobbin Winder complete, Nos. 2460, 2463 and 5522
46D	3385	Bobbin Winder Hinge Screw

**BOBBIN WINDER
(LOOSE WHEEL)**

**FOR MACHINES Nos. 17-1 TO 17-4, 17-6 TO 17-11,
17-13 TO 17-17, 17-19, 17-21, 17-29 AND 17-30**

NO.	PLATE	NAME
2466	310	Eccentric.....
286D	3385	" Thumb Screw.....
5526	310	Frame.....
2460	310	Friction Ring (rubber).....
2461	310	Pulley.....
2845	3369	Spindle for Bobbin.....
2846	3369	" " Spool.....
2847	—	" 2845 with 2846.....
5534	310	Bobbin Winder complete, Nos. 286D, 2460, 2461, 2466, 2847 and 5526.....
1489J	3388	Bobbin Winder Screw.....

**BOBBIN WINDER
(LOOSE WHEEL)**

**FOR MACHINES Nos. 17-22, 17-23, 17-25,
17-27 AND 17-28**

NO.	PLATE	NAME
2466	310	Eccentric.....
286D	3385	" Thumb Screw.....
5526	310	Frame.....
2460	310	Friction Ring (rubber).....
2461	310	Pulley.....
2693	310	Spindle.....
2694	—	" 2693 with 2461.....
5531	310	Bobbin Winder complete, Nos. 286D, 2460, 2466, 2694 and 5526.....
1489J	3388	Bobbin Winder Screw.....

**BOBBIN WINDER
(TIGHT WHEEL)**

**FOR MACHINES Nos. 17-22, 17-23, 17-25,
17-27 AND 17-28**

NO.	PLATE	NAME
5522	310	Frame.....
2460	310	Friction Ring (rubber).....
2461	310	Pulley.....
5529	310	Spindle.....
5530	—	" 5529 with 2461.....

NO.	PLATE	NAME
2464	310	Spring.....
5528	310	Bobbin Winder complete, Nos. 2460, 5522 and 5530.....
46D	3385	Bobbin Winder Hinge Screw.....

**BOBBIN WINDER
(LOOSE WHEEL)**

**FOR MACHINES Nos. 17-22, 17-23, 17-25,
17-27 AND 17-28**

NO.	PLATE	NAME
2466	310	Eccentric.....
286D	3385	" Thumb Screw.....
5526	310	Frame.....
2460	310	Friction Ring (rubber).....
2461	310	Pulley.....
2852	3369	Spindle for Bobbin.....
2846	3369	" " Spool.....
2853	—	" 2852 with 2846.....
5533	310	Bobbin Winder complete, Nos. 286D, 2460, 2461, 2466, 2853 and 5526.....
1489J	3388	Bobbin Winder Screw.....

BOBBIN WINDER

(TIGHT OR LOOSE WHEEL)

**FOR MACHINES Nos. 17-5, 17-12, 17-18, 17-20,
17-24 AND 17-26**

NO.	PLATE	NAME
15072	3383	Bobbin Position Pin.....
16862	3389	Bracket.....
16799	3369	Frame.....
46D	3385	" Hinge Screw.....
2460	310	Friction Ring (rubber).....
2461	310	Pulley.....
2462	310	Spindle with 15072.....
2463	—	" 2462 with 2461.....
2464	310	Spring.....
16900	—	Bobbin Winder, Nos. 2463 and 16799.....
16800	3369	Bobbin Winder complete, Nos. 46D, 2460, 2464, 16862 and 16900.....
161J	3384	Bobbin Winder Screw.....

BOBBIN WINDER

(SWINGING AUTOMATIC, RIGHT HAND)

FOR 2073 AND 2210

NO.	PLATE	NAME
27540	1703	Base.....
27302	1703	Frame.....
50356D	3388	" Hinge Screw.....
1620J	3388	" " " Nut.....
27303	3383	" Spring.....
27541	1703	Pulley.....
27305	1703	Spindle.....
27306	1703	Spool Pin.....
27307	1703	" Stand.....
27308	1703	Spool Stand complete, Nos. 418E, 1562J, 2106, 10141, 11241, 27306, 27307 and two each 2455 and wood screws 1 in. No. 10.....
11241	1703	Spool Washer.....
27309	1703	Stop Latch.....
35D	3385	" " Hinge Screw.....
2455	3383	Tension Disc.....
1562J	3383	" Regulating Thumb Nut.....
418E	3383	" Screw Stud.....
10141	3383	" Spring.....
2106	221	" Thread Guide.....
27646	1703	Bobbin Winder, Nos. 35D, 1620J, 27302, 27303, 27305, 27309, 27540, 27541, 50356D and two wood screws 1 in. No. 7.....
27543	---	Bobbin Winder (swinging automatic, right hand) complete, Nos. 27308 and 27646.....

BOBBIN WINDER

(SWINGING AUTOMATIC, RIGHT HAND)

FOR 2996

This Bobbin Winder is the same as 27543, with the following exceptions:

NO.	PLATE	NAME
15072	3383	Bobbin Position Pin.....
27849	---	Spindle.....
27538	2445	" 27849 with 15072, 27850 and 41828, in place of 27305.....
*27850	---	Spindle Collar.....
41828	---	" " Pin.....

NO.	PLATE	NAME
27312	2445	Stop Latch, in place of 27309.....
27647	2445	Bobbin Winder, Nos. 35D, 1620J, 27302, 27303, 27312, 27538, 27540, 27541, 50356D and two wood screws 1 in. No. 7, in place of 27646.....
27544	---	Bobbin Winder (swinging automatic, right hand) complete, Nos. 27308 and 27647.....

BOBBIN WINDER

(SWINGING AUTOMATIC, RIGHT HAND)

FOR 2996

This Bobbin Winder is the same as 27543, with the following exceptions:

NO.	PLATE	NAME
15072	3383	Bobbin Position Pin.....
27610	2445	Spindle with 15072, in place of 27305.....
2846	3369	" for Spool.....
27611	---	" 27610 with 2846.....
27312	2445	Stop Latch, in place of 27309.....
27656	2445	Bobbin Winder, Nos. 35D, 1620J, 27302, 27303, 27312, 27540, 27541, 27611, 50356D and two wood screws 1 in. No. 7, in place of 27646.....
27612	---	Bobbin Winder (swinging automatic, right hand) complete, Nos. 27308 and 27656.....

KNIFE GRINDER

FOR 6287 TO 6292 AND 6442

FOR 17-11 MACHINE

NO.	PLATE	NAME
27565	1104	Emery Wheel, 2 in. diam.....
1508J	1105	" " Clamping Nut.....
27822	1105	" " " Washer.....
27567	1105	" " Shaft.....
60934	---	" " " 27567 with 1508J, 27565, 27569 and 27822.....
27568	1105	Emery Wheel Shaft Oil Hole Cover (rubber)
27569	1105	" " " Pulley.....
310K	1105	" " " Screw Center.....
1516J	1105	" " " " " Nut.....
27564	1104	Frame with 27574.....
899J	1105	Knife Clamping Screw.....

NO.	PLATE	NAME
27657	—	Knife Holder Body
27658	1105	Knife Holder complete, Nos. 899j, 27657 and 27660
27323	1105	Knife Holder Guide Bar
27572	1104	" " " " Bracket with 27574
310k	1105	" " " " " Screw Center
1516j	1105	" " " " " " " "
		Nut
27573	1105	Knife Holder Guide Bar Bracket Spring
27574	1105	" " " " " " " "
		Hook
27659	1105	Knife Holder Stop Collar with 237k
237k	1105	" " " " " Set Screw
27660	20882	" Position Pin
261j	1105	" Regulating Thumb Screw
60583	5918	" Grinder, Nos. 261j, 27323, 27564, 27572, 27573, 27659, 60934, two 27568 and four each 310k and 1516j
27661	—	Knife Grinder complete, Nos. 27658, 27662, 60583 and three wood screws 1 in. No. 10

NOTE: When ordering No. 27661, state No.
of Knife Holder

27662 1104 Wrench for 1508 and 1516

ROLLER PRESSER (Ball Bearing)

WITH RATCHET BRAKE

FOR 17-29 MACHINE

NO.	PLATE	NAME
51892	—	Roller, 1¼ in. diam., ½ in. face
16232	20882	" Ball
1766c	20882	" " Retaining Nut
50553c	20882	" Screw
1528j	3386	" " Nut
51893	20883	Roller, 1¼ in. diam., ½ in. face, coarse, (ball bearing) complete, Nos. 1528j, 1766c, 50553c, 51892 and twenty-four 16232
65095	20882	Roller Arm
440f	231	" " Adjusting Screw
1547j	231	" " " " " Nut
4282	3371	" " Bracket
316f	231	" " " " " Screw Center
15444	—	" " " " " " 316f with 1547j

NO.	PLATE	NAME
1547j	231	Roller Arm Bracket Screw Center Nut
2205	231	" " Lock Spring
176j	231	" " " " " Screw
1549j	231	" " " " " " Nut
62853	20882	" Ratchet Spring Stop
62851	20882	" " " " " Bracket
62854	—	" " " " " " 62851 with 665j and 62853
230f	20883	Roller Ratchet Spring Stop Bracket Screw
665j	3384	" " " " " Screw
65099	20881	Roller Presser (ball bearing) complete, 1¼ in. coarse roller, ½ in. face, Nos. 176j, 230f, 440f, 1547j, 1549j, 2205, 4282, 51893, 62854, 65095 and two 15444

THREAD LUBRICATOR

FOR Nos. 17-1 TO 17-7, 17-10, 17-13 TO 17-19, 17-22, 17-23 AND 17-27 TO 71-30 MACHINES

NO.	PLATE	NAME
*62818	—	Thread Lubricator Bracket
65087	20884	" " " " Extension
50222j	20884	" " " " " Screw
21202	20884	" " " " " " Friction Washer
1529e	20884	Thread Lubricator Bracket Screw Nut
62819	20884	" " " " Oil Pad (felt)
*62820	—	" " " " " Holder
65088	—	" " " " " " 62820 with 65090
65089	20884	Thread Lubricator Oil Pad Holder 65088 with 62819, 62824 and 62827
*65090	—	Thread Lubricator Oil Pad Holder Oil Tube
62824	20884	Thread Lubricator Oil Pad Retainer
62830	—	" " " " " Reservoir
17822	20884	" " " " " " Rivet
8068	20884	" " " " " " " "
		Washer (inside)
124371	20884	Thread Lubricator Oil Reservoir Rivet Washer (outside)
62827	20877	Thread Lubricator Oil Wick (braided cotton)
65091	20884	Thread Lubricator complete, Nos. 8068, 17822, 62818, 62830, 65089 and 124371
65092	20884	Thread Lubricator 65091 with 1529e, 50222j, 65087 and two 21202

FOOT LIFTER PARTS

NO.	PLATE	NAME
6439	—	Chain, 36 in. to 45 in., with 56864 and 56865.....
NOTE: When ordering 6439, give length required		
4879	3369	Chain Connecting Link for 4885.....
56864	3302	" Hook (large).....
56865	3388	" " (small).....
7170	380	Lifting Lever for 6344, 6346 and 16801....
10648	384	" " with 448c, for 10654 and 16803.....
10641	384	Lifting Lever with 448c, for 16802.....
802d	379	" " Hinge Screw for 6344, 6346, 16654, 16801 and 16803.....
1064d	3385	Lifting Lever Hinge Screw for 16802.....
4896	3375	" " Hook for 16802.....
448c	379	" " " Set Screw.....
4727	3383	" " Pin for 16654 and 16803....
448c	379	" " " Set Screw.....
16659	384	" " Spring.....
4725	3365	" Presser Bar Lifting Bracket for 16654 and 16802.....
4668	3365	Lifting Presser Bar Lifting Bracket for 16803.....
4726	3383	Lifting Presser Bar Lifting Bracket Guide Pin for 16654, 16802 and 16803.....
5608	259	Presser Bar Lifting Bracket with 453c, for 6344.....
5611	382	Presser Bar Lifting Bracket with 453c and 5613, for 16801.....
5612	3365	Presser Bar Lifting Bracket with 453c, for 6346.....
453c	3385	Presser Bar Lifting Bracket Set Screw....
5613	3383	Tension Releasing Pin.....
4881	384	Treadle.....
4882	3369	" Shaft.....
4883	3369	" Spring.....
4884	384	" Stand.....
4885	384	Treadle complete, Nos. 4879, 4881 to 4884 and two wood screws 1 in. No. 16.....
6344	—	Foot Lifter complete for 17-1 to 17-6, 17-10, 17-13 to 17-19, 17-22, 17-23, 17-27, 17-29 and 17-30 Machines, Nos. 802d, 4885, 5608, 6439, 7170 and 16659
16801	—	Foot Lifter complete for 17-7 Machine, Nos. 802d, 4885, 5611, 6439, 7170 and 16659.....

NO.	PLATE	NAME
16654	—	Foot Lifter complete for 17-8, 17-9, 17-20 and 17-25 Machines, Nos. 802d, 4725 to 4727, 4885, 6439, 16648 and 16659..
6346	—	Foot Lifter complete for 17-11 Machine, Nos. 802d, 4885, 5612, 6439, 7170 and 16659.....
16802	—	Foot Lifter complete for 17-12, 17-24 and 17-26 Machines, Nos. 1064d, 4725, 4726, 4885, 4896, 6439, 16641 and 16659.....
16803	—	Foot Lifter complete for 17-21 Machine, Nos. 802d, 4668, 4726, 4727, 4885, 6439, 16648 and 16659.....

KNEE LIFTER PARTS

NO.	PLATE	NAME
7170	380	Lifting Lever for 6330, 6332 and 16804...
16648	384	" " with 448c, for 16653 and 16805.....
16641	384	Lifting Lever with 448c, for 16645.....
802d	379	" " Hinge Screw for 6330, 6332, 16653, 16804 and 16805.....
1064d	3385	Lifting Lever Hinge Screw for 16645.....
4896	3375	" " Hook for 16645.....
448c	379	" " " Set Screw.....
4727	3383	" " Pin for 16653 and 16805....
448c	379	" " " Set Screw.....
16659	384	" " Spring.....
4725	3365	" Presser Bar Lifting Bracket for 16645 and 16653.....
4668	3365	Lifting Presser Bar Lifting Bracket for 16805.....
4726	3383	Lifting Presser Bar Lifting Bracket Guide Pin for 16645, 16653 and 16805.....
6333	380	Pitman for 6330, 6332, 16653, 16804 and 16805.....
6343	380	Pitman for 16645.....
5608	259	Presser Bar Lifting Bracket with 453c, for 6330.....
5611	382	Presser Bar Lifting Bracket with 453c and 5613, for 16804.....
5612	3365	Presser Bar Lifting Bracket with 453c, for 6332.....
453c	3385	Presser Bar Lifting Bracket Set Screw....
2763	380	Rock Shaft.....
6334	380	" " Hanger with two wood screws 1 in. No. 10.....

NO.	PLATE	NAME
16646	380	Rock Shaft Knee Arm.....
16647	—	Rock Shaft Knee Arm complete, Nos. 2766, 2767 and 16646.....
2766	380	Rock Shaft Knee Arm Hub with 356c.....
356c	3384	" " " " " Set Screw.....
2767	380	" " " " " Plate with 356c.....
356c	3384	" " " " " Set Screw.....
6337	380	" " " " " Lifting Bracket with two 356c.....
6338	380	" " " " " Hook.....
356c	3384	" " " " " Set Screw.....
356c	3384	" " " " " Set Screw.....
2770	380	" " " " " Stop Dog with 356c.....
356c	3384	" " " " " Set Screw.....
6339	380	Rock Shaft complete, Nos. 2763, 2770, 6337, 6338, 16647 and two 6334.....
5613	3383	Tension Releaser Pin.....
6330	—	Knee Lifter complete (power table or stand) for 17-1 to 17-6, 17-10, 17-13 to 17-19, 17-22, 17-23, 17-27, 17-29 and 17-30 Machines, Nos. 802d, 5608, 6333, 6339, 7170 and 16659.....
16804	—	Knee Lifter complete (power table or stand) for 17-7 Machine, Nos. 802d, 5611, 6333, 6339, 7170 and 16659.....
16653	—	Knee Lifter complete (power table or stand) for 17-8, 17-9, 17-20 and 17-25 Machines, Nos. 802d, 4725 to 4727, 6333, 6339, 16648 and 16659.....
6332	—	Knee Lifter complete (power table or stand) for 17-11 Machine, Nos. 802d, 5612, 6333, 6339, 7170 and 16659.....
16645	—	Knee Lifter complete (power table or stand) for 17-12, 17-24 and 17-26 Machines, Nos. 1064d, 4725, 4726, 4896, 6339, 6343, 16641 and 16659.....
16805	—	Knee Lifter complete (power table or stand) for 17-21 Machine, Nos. 802d, 4668, 4726, 4727, 6333, 6339, 16648 and 16659.....

THREAD UNWINDERS

THREAD UNWINDER FOR ONE SPOOL

NO.	PLATE	NAME
225389	3398	Spool Rest with 201018c.....
225388	3398	" " Rod.....
200383c	3388	" " " Set Screw.....
201018c	3388	" " " Set Screw.....
202490	3398	" Stand with 200383c.....
225391	3398	Thread Guide.....
201696j	3388	" " Lock Nut.....
225326	20883	" " Position Cup.....
225324	3398	" " Rod with 208E and 225322.....
208E	3384	" " " Screw.....
225322	20883	" " " Washer.....
225394	3398	Thread Unwinder complete, Nos. 201696j, 202490, 225324, 225326, 225388, 225389, 225391 and three wood screws 1/8 in. No. 12.....
27739	7234	Thread Cone (wood) for large cones.....
225390	7234	" " Holder, for inverted cones..

NOTE: Nos. 27739 and 225390 are used with, but not included in 225394.

THREAD UNWINDER FOR TWO SPOOLS

NO.	PLATE	NAME
225395	7233	Spool Rest with 201018c.....
225388	7233	" " Rod.....
200383c	3388	" " " Set Screw.....
201018c	3388	" " " Set Screw.....
202490	7233	" Stand with 200383c.....
225391	7233	Thread Guide.....
201696j	3388	" " Lock Nut.....
225326	20883	" " Position Cup.....
225324	7233	" " Rod with 208E and 225322.....
208E	3384	" " " Screw.....
225322	20883	" " " Washer.....
225396	7233	Thread Unwinder complete, Nos. 201696j, 202490, 225324, 225326, 225388, 225395, two 225391 and three wood screws 1/8 in. No. 12.....
27739	7234	Thread Cone (wood) for large cones.....
225390	7234	" " Holder, for inverted cones..

NOTE: Nos. 27739 and 225390 are used with, but not included in 225396.

OBSOLETE PARTS

NO.	PLATE	NAME
*6060	---	Arm with 4448, 4449, 15404 and two 15405, for 17-1 Machine.....
*6165	---	Arm with 4448, 4449, 15404 and two 15405, for 17-6 Machine.....
*6301	---	Arm with 4448, 4449, 6305, 6314, 6315, 15404, two each 159E, 15405 and four 161E, for 17-12 Machine.....
*16676	---	Arm with 4448, 4449, 6169, 15404 and two each 145E and 15405, for 17-16 Machine.....
*6001	---	Arm with 4448, 4449, 15404 and two 15405, for 17-5 and 17-18 Machines.....
*6271	---	Arm with 4448, 4449, 15404 and two 15405, for 17-20 Machine.....
2117	221	Arm Dowel Pin for 17-1 to 17-18 Machines.....
8879	3383	" Spool Pin Washer (cloth).....
16620	384	Cloth Plate, 6 in. long, for 17-6, 17-10, 17-13 and 17-14 Machines.....
*6003	---	Cylinder, $2\frac{1}{8}$ in. diam., for straight bearing throat plate, for 17-1 and 17-2 Machines.....
*6002	---	Cylinder, $2\frac{1}{8}$ in. diam., for 17-8 Machine.....
*6177	---	" $2\frac{1}{8}$ in. diam., for 17-12 and 17-20 Machines.....
*6434	---	Cylinder, $2\frac{1}{8}$ in. diam., for 6438, for 17-18 Machine.....
*16660	---	Cylinder, $2\frac{1}{8}$ in. diam., for 17-19 Machine.....
*16606	---	Cylinder, $1\frac{1}{8}$ in. diam., for 16811, for 17-22, 17-23 and 17-25 Machines.....
*16722	---	Cylinder, $1\frac{1}{8}$ in. diam., for 16737, for 17-28 Machine.....
*16743	---	Cylinder, $2\frac{1}{8}$ in. diam., for 16756, for 17-29 Machine.....
3028	---	Face Plate for 413 and 2127, for 17-1 Machine.....
3029	---	Face Plate for 600, for 17-1 Machine.....
3030	---	" " " 600, 2111 and 2127, for 17-1 Machine.....
3205	---	Face Plate with 3265 and two 190J, for 3214, for 3206.....
3206	---	Face Plate complete for 17-7 Machine, Nos. 86D, 330J, 448C, 2105, 2107, 2124, 2127, 2410, 2411, 2413, 3205, two each 233I, 637F, 1560C, 2103 and four 2102..

NO.	PLATE	NAME
3125	---	Face Plate for 600 and 2111, for 17-8 Machine.....
3088	---	Face Plate for 600 and 2111, for 17-11 Machine.....
2106	221	Face Plate Thread Guard for 3028 and 3029, for 17-1 Machine.....
6010	3363	Feed Dog, 12 teeth, for cloth, for 17-1 Machine.....
6015	371	Feed Dog, 12 teeth (circular feed) for shirt work, for 17-1 Machine.....
6014	372	Feed Dog, 11 teeth (16 teeth to the inch) incline feed, for shirt work, for 17-1 Machine.....
6116	3357	Feed Dog, 15 teeth (16 teeth to the inch) horse shoe, for 17-6 Machine.....
6128	3357	Feed Dog, 13 teeth (16 teeth to the inch) for cloth, for 17-6 Machine.....
6129	3357	Feed Dog, 11 teeth (15 teeth to the inch) for leather, for 17-6 Machine.....
6275	3357	Feed Dog, 12 teeth (15 teeth to the inch) for cloth, for 17-10 Machine.....
6067	371	Feed Dog, 12 teeth, for cloth, for 17-2 Machine.....
6276	3357	Feed Dog, 12 teeth (15 teeth to the inch) for leather, for 17-10 Machine.....
6277	3357	Feed Dog, 11 teeth (15 teeth to the inch) two rows of teeth, for 17-10 Machine.....
6321	3357	Feed Dog for 17-13 Machine.....
6263	3357	" " 12 teeth, for 17-14 Machine.....
16632	3352	" " 13 teeth (21 teeth to the inch) conical teeth, for 17-16 Machine.....
16635	3356	Feed Dog, 10 teeth (16 teeth to the inch) for 17-17 Machine.....
6435	376	Feed Dog, 12 teeth, for 17-18 Machine.....
16661	3352	" " 10 teeth, for leather, for 17-19 Machine.....
16672	3352	Feed Dog, 12 teeth, (16 teeth to the inch) for cloth, for 17-19 Machine.....
16630	3351	Feed Dog, 10 teeth, one row of teeth at left and two teeth back of needle, for 17-23 Machine.....
16864	---	Feed Dog, 5 teeth (21 teeth to the inch) for 16878, for 17-30 Machine.....
6131	370	Feed Forked Connection for 17-6, 17-10, 17-13 and 17-14 Machines.....
16650	3351	Feed Dog for 16652 and 16655, for 17-8 Machine.....

NO.	PLATE	NAME
16894	3395	Feed Dog, 5 teeth (22 teeth to the inch) for 16897, for 17-30 Machine.....
6158	370	Feed Forked Connection for 17-10 Machine.....
6304	369	Feed Lever for 17-12 Machine.....
133F	379	" " Stop Screw for 17-12 Machine
1592E	3386	" " " " Lock Nut for 17-12 Machine.....
6309	369	Feed Regulator for 17-12 Machine.....
5544	259	" " Crank with two 448c, for 17-10 Machine.....
6166	377	Feed Regulator Crank Pin for 17-10 and 17-16 Machines.....
6133	368	Feed Regulator Lever Segment for 17-10 Machine.....
6811	368	Feed Regulator Lever Segment for 17-16 Machine.....
6134	364	Feed Regulator Lever Shaft for 17-16 Machine.....
*6169	---	Feed Regulator Lever Shaft Bracket for 16676, for 17-16 Machine.....
145E	3384	Feed Regulator Lever Shaft Bracket Screw for 16676, for 17-16 Machine.....
6310	375	Feed Regulator Slide Block for 17-12 Machine.....
751D	379	Feed Regulator Slide Block Screw Stud for 17-12 Machine.....
1591E	379	Feed Regulator Slide Block Screw Stud Nut for 17-12 Machine.....
6312	3383	Feed Regulator Slide Block Screw Stud Nut Washer for 17-12 Machine.....
6311	375	Feed Regulator Slide Block Spring for 17-12 Machine.....
233J	3384	Feed Regulator Slide Block Spring Screw for 17-12 Machine.....
6160	366	Feed Rock Shaft for 304, for 17-6, 17-10, 17-13 and 17-14 Machines.....
6159	3370	Feed Rock Shaft for 618, for 17-6, 17-10, 17-13 and 17-14 Machines.....
6138	370	Feed Rock Shaft Arm with 457c, for 6160, for 17-6, 17-10, 17-13 and 17-14 Machines.....
6167	366	Feed Rock Shaft Arm with 453c, for 6160, for 17-6, 17-10, 17-13 and 17-14 Machines.....
2117	221	Feed Rock Shaft Arm Pin for 17-6, 17-10, 17-13 and 17-14 Machines.....

NO.	PLATE	NAME
457c	3385	Feed Rock Shaft Arm Set Screw for 6138.
304c	379	" " " Screw Center for 6137 and 6160.....
618c	3384	Feed Rock Shaft Screw Center for 6159..
6135	3370	" Rod for 17-6, 17-10, 17-13 and 17-14 Machines.....
23c	379	Feed Rod Hinge Screw for 17-6, 17-10, 17-13 and 17-14 Machines.....
6136	375	Feed Rod Lifting Block for 17-6, 17-10, 17-13 and 17-14 Machines.....
6162	375	Feed Rod Lifting Block for 17-6, 17-10, 17-13 and 17-14 Machines.....
6313	364	Feed Shaft for 17-12 Machine.....
*6314	---	" " Bracket (back) for 6301, for 17-12 Machine.....
161E	3384	Feed Shaft Bracket (back) Screw for 6301, for 17-12 Machine.....
*6315	---	Feed Shaft Bracket (front) for 6301, for 17-12 Machine.....
161E	3384	Feed Shaft Bracket (front) Screw for 6301, for 17-12 Machine.....
5667	380	Foot Lever for 5668.....
5668	380	" " 5667 with 5669, 5671 and three wood screws 1½ in. No. 16, for 6344 to 6346 and 6446.....
5669	380	Foot Lever Bracket for 5668.....
5671	3383	" " Hinge Pin for 5668.....
5672	380	" " Lifting Spring for 6344 to 6346 and 6446.....
6345	---	Foot Lifter complete for 17-8 and 17-9 Machines, Nos. 202E, 802D, 4885, 5610, 6439, 7170 and 16659.....
6446	---	Foot Lifter complete for 17-12 Machine, Nos. 202E, 802D, 4885, 4896, 5610, 6439, 16641 and 16659.....
3127	---	Guide Bar complete for 17-8 and 17-9 Machines, Nos. 810D, 810E, 3132, 3134, 3135, 56844 and three 404J.....
3130	297	Guide Bar Driving Crank with 1862 and 3131, for 17-8, 17-9 and 17-12 Machines
3132	259	Guide Bar Lifting Bracket for 3127.....
626c	3385	" " " " Guide Screw Stud for 17-8, 17-9 and 17-12 Machines
16604	384	Knee Lifter Pitman, length 13¾ in., for 16605.....
6335	380	Knee Lifter Rock Shaft Knee Arm for 6336.....

NO.	PLATE	NAME
240J	385	Needle Clamp Thread Eyclet Screw for 6078.....
3215	302	Needle Clamp Thread Guard for 3352..
578J	3384	" " " " Screw for 3352.....
4802	385	Needle Clamp Thread Guide for 4803.
2166	221	" " " " " 17-29 Machine.....
196F	3383	Needle (inside) Set Screw for 3352, for 17-7 Machine.....
624c	312	Needle (outside) Set Screw for 3352, for 17-7 Machine.....
16668	3361	Needle Plate for 16669.....
211D	379	" " Screw for 17-12 Machine....
6021	367	Oscillating Rock Shaft with 197E, 2170 and two each 2173 and 2174, for 3052..
6062	3370	Oscillating Rock Shaft (solid) for 295 and 304.....
6063	3370	Oscillating Rock Shaft with 197E, 2170 and two each 2171 and 2174, for 295 and 304.....
6064	367	Oscillating Rock Shaft with 197E, 2170 and two each 2172 and 2174, for 295 and 304.....
6065	3370	Oscillating Rock Shaft with 197E, 2170 and two each 2171 and 2174, for 617 and 619.....
6066	3370	Oscillating Rock Shaft with 197E, 2170 and two each 2172 and 2174, for 617 and 619.....
2170	3383	Oscillating Rock Shaft Oil Pad for 6021, 6022 and 6063 to 6066.....
197E	312	Oscillating Rock Shaft Oil Pad Screw for 6021 and 6063 to 6066.....
295c	379	Oscillating Rock Shaft Screw Center (long) for 6062 to 6064.....
304c	379	Oscillating Rock Shaft Screw Center (short) for 6062 to 6064.....
617c	379	Oscillating Rock Shaft Screw Center (long) for 6065 and 6066.....
619c	3384	Oscillating Rock Shaft Screw Center (short) for 6065 and 6066.....
2173	3375	Oscillating Rock Shaft Steel Plate for 6021.....
2171	3375	Oscillating Rock Shaft Steel Plate for 6063 and 6065.....

NO.	PLATE	NAME
2172	3375	Oscillating Rock Shaft Steel Plate for 6064 and 6066.....
2174	221	Oscillating Rock Shaft Steel Plate Rivet for 6021 and 6063 to 6066.....
6462	3366	Oscillating Shaft for 17-22 Machine.....
*16679	—	" " Crank with 1813, for 16680.....
16680	3375	Oscillating Shaft Crank 16679 with two 462c, for 6462, for 17-22 Machine.....
2175	301	Presser Bar Lifter for 2063, for 17-1 Machine.....
2060	301	Presser Bar Lifter for 108, for 17-1 Machine.....
2061	301	Presser Bar Lifter for 33 and 70, for 17-1 Machine.....
108E	3385	Presser Bar Lifter Screw for 2060.....
33E	3385	" " " " (long) for 2061..
70E	3385	" " " " (short) for 2061
2063	221	" " Stud for 2175.....
3038	297	" " Spring Bracket with 453c, for 2060 and 2175, for 17-1 Machine... ..
3059	297	Presser Bar Spring Bracket with 453c, for 2061, for 17-1 Machine.....
3057	297	Presser Bar Spring Bracket with 453c, for 3055, for 17-1 Machine.....
3220	377	Presser Bar Spring Bracket with 453c and 5613, for 3267, for 17-7 Machine... ..
453c	3385	Presser Bar Spring Bracket Set Screw for 3057 to 3059 and 3220.....
3055	301	Presser Bar Spring (flat) for 17-1 Machine
2069	221	" " " " Guide Pin.....
2183	372	" " Foot for 6010, 6014 and 6015, for 17-1 Machine.....
3360	302	Presser Foot (short shank) for $\frac{3}{4}$ in. gauge and above, for 17-7 Machine....
3758	302	Presser Foot (short shank) for $\frac{3}{4}$ in. gauge and above, for outside stays and strips, for 17-7 Machine.....
6026	372	Presser Foot, $\frac{1}{32}$ in. tread, for 17-16 Machine.....
6025	372	Presser Foot, $\frac{1}{16}$ in. tread, for 17-16 Machine.....
16637	3374	Presser Foot for 16635, for 17-17 Machine
16734	3379	" " " " 17-28 Machine.....
261D	312	Pressure Regulating Thumb Screw for 3055, for 17-1 Machine.....
50023D	3379	Pressure Regulating Thumb Screw for 17-28 Machine.....

NO.	PLATE	NAME
*2075	—	Shuttle Cover for 44001.....
*44001	—	“ “ 2075 with 112E, 466H, 2078, 2080, 2086 and 2090, for 6028.....
6028	217	Shuttle (high point) complete for 17-1 to 17-6, 17-8 to 17-18, 17-20, 17-24, 17-26 and 17-29 Machines, Nos. 2073, 2076, 6058 and 44001.....
*2176	—	Shuttle Driver for 2092.....
2092	367	“ “ 2176 with two 457c, for 17-3 Machine.....
457c	3385	Shuttle Driver Set Screw for 2092.....
16737	3380	“ Race for 50037, for 16722, for 17-28 Machine.....
16809	—	Shuttle Race Body for 16811.....
16871	3396	“ “ “ “ 16877 and 16896..
16810	3389	“ “ Cap for 16811.....
16811	—	Shuttle Race complete for 17-22, 17-23 and 17-25 Machines, Nos. 16809, 16810 and two 1053J.....
16877	—	Shuttle Race complete for 16878, Nos. 16871 to 16875 and two each 330J and 399F.....
16896	—	Shuttle Race complete for 17-30 Machine, Nos. 16871, 16873 to 16875, 16895 and two each 330J and 399F.....
16872	—	Shuttle Race Ring for 16877.....
6032	367	“ “ “ 6057 with 65059 and two 337J, for 17-18 Machine.....
6031	3370	Shuttle Race Ring, for shirt work, for 17-1 Machine.....
16634	387	Shuttle Race Ring for 17-15 Machine....
16895	3396	“ “ “ “ 16896.....
16669	3361	Shuttle Race Ring complete for 17-24 Machine, Nos. 16668, 16670, 16777 and four 220J.....
6108	370	Shuttle Race Ring Cover for 17-5, 17-12 and 17-20 Machines.....
16671	3361	Shuttle Race Ring Cover for 17-24 Machine.....
50037F	3380	Shuttle Race Screw for 17-28 Machine....
3265	259	Tension Bracket for 3205 and 3266, for 17-7 Machine.....
3266	—	Tension Bracket complete for 17-7 Machine, Nos. 330J, 2413, 3265, two each 637F, 1560c, 2103 and four 2102.....
190J	3384	Tension Bracket Screw for 3205.....
637F	3385	“ Screw Stud for 3206 and 3266....

NO.	PLATE	NAME
413F	379	Tension Screw Stud for 3028, for 17-1 Machine.....
2413	301	Tension Thread Eyelet (double) for 3206 and 3266.....
2104	377	Tension Thread Guard for 17-1 Machine
15007	221	Thread Take-up Spring (2119) for 413, for 17-1 Machine.....
3071	370	Thread Take-up Cam with 446c, for 17-1 to 17-6, 17-10, 17-13 to 17-19 and 17-29 Machines.....
*65018	—	Thread Take-up Cam for 16739.....
16739	3369	“ “ “ 65018 with 446c, for 17-28 Machine.....
2792	221	Thread Take-up Spring (2120) for 413, for 17-1 Machine.....
15008	221	Thread Take-up Spring (2121) with offset, for 413, for 17-1 Machine.....
15009	221	Thread Take-up Spring (2122) with offset, closed eyelet, for 413, for 17-1 Machine
15010	221	Thread Take-up Spring (2123) for 600, for 17-1 Machine.....
2124	221	Thread Take-up Spring for 3206.....
2125	221	“ “ “ Regulator for 17-1 Machine.....
2126	221	Thread Take-up Spring Regulator Plate for 17-1 Machine.....
233J	3384	Thread Take-up Spring Regulator Screw.
6039	372	Throat Plate, large needle hole, for 6010..
6043	372	“ “ for 6013 and 16684, for 6050
16685	3356	“ “ “ 6013 and 16684.....
6044	372	“ “ “ 6014, for 6052.....
16633	3352	“ “ “ 16632.....
16636	3356	“ “ “ 16635.....
6245	376	“ “ “ 6182.....
16878	—	“ “ “ 16864 for 16880.....
16604	3352	“ “ “ 16661.....
16673	3352	“ “ “ 16672.....
6438	376	“ “ “ 6435.....
6045	371	“ “ (straight bearing) for 6015..
6041	372	“ “ “ “ “ 6011..
6076	371	“ “ “ “ “ 6068..
6170	3357	“ “ large needle hole, for 6128 and 6275.....
6154	—	Throat Plate, small needle hole, for 6128 and 6275.....

NO.	PLATE	NAME
6171	3357	Throat Plate, large needle hole, for 6129 and 6276.
6155	—	Throat Plate, small needle hole, for 6129 and 6276.
6320	3357	Throat Plate, large needle hole, for 6321.
6328	—	" " small needle hole, for 6321.
6074	371	" " for 6067.
16631	3351	" " " 16630.
6269	3357	" " small needle hole, for 6263.
6123	376	" " large needle hole, for 6116.
6124	—	" " small needle hole, for 6116.
6172	—	" " large needle hole, for C277.
6280	373	" " small needle hole, for 6277.
6051	3370	" " Holder for 6044, for 6052.
6052	—	" " " 6051 with 6044, for 17-1 Machine.
6050	—	Throat Plate Holder 6049 with 6043, for 17-15 and 17-16 Machines.
171D	312	Throat Plate Holder Screw for 17-1 Machine.
16880	—	Throat Plate Holder 16879 with 16878, for 17-30 Machine.
16759	3382	Throat Plate with 16760 and two 238D, for 401, for 16744 and 16846, for 17-29 Machines.
16652	3351	Throat Plate, large needle hole, for 16650, for 17-8 Machine.
16655	—	Throat Plate, small needle hole, for 16650, for 17-8 Machine.
16897	3395	Throat Plate for 16894, for 16898.
16898	—	" " Holder 16879 with 16897, for 17-30 Machine.
211D	379	Throat Plate Screw for 6041 and 6045, for 17-1 Machine, and for 6076, for 17-2 Machine.
401D	3385	Throat Plate Screw for 16759, for 17-29 Machine.
3135	259	Vibrating Presser Bar Lifting Bell Crank for 3127.
6274	374	Vibrating Presser Foot for 17-9 Machine.

NUMERICAL LIST OF PARTS

NO.	PLATE	NAME
23c	379	Feed Forked Connection Universal Joint Hinge Screw for 17-6, 17-10, 17-13 and 17-14 Machines.
23c	379	Feed Rod Hinge Screw for 17-6, 17-10, 17-13 and 17-14 Machines, obsolete.
33E	3385	Presser Bar Lifter Screw (long) for 2061, obsolete.
35D	3385	Bobbin Winder Stop Latch Hinge Screw for 27646, 27647 and 27656.
46D	3385	Bobbin Winder Frame Hinge Screw for 16800.
46D	3385	Bobbin Winder Hinge Screw for 5521 and 5528.
58E	312	Feed (lower) Regulator Hinge Screw for 17-26 Machine.
58E	312	Feed Regulator Hinge Screw for 17-1 to 17-9, 17-11, 17-13 to 17-15, 17-17 to 17-23, 17-25 and 17-29 Machines.
70E	3385	Presser Bar Lifter Screw (short) for 2061, obsolete.
76D	3385	Lifting Lever Connecting Rod Joint Hinge Screw for 16605, obsolete.
86D	3385	Thread Guiding Roller Screw for 3206, 4856 and 56818.
87F	3377	Presser Foot Driving Arm Hinge Screw for 16710, obsolete.
89F	379	Feed Bar Connecting Link Hinge Screw for 17-12 and 17-24 Machines.
89F	379	Feed (upper) Bar Connecting Link Hinge Screw for 17-26 Machine.
101D	3381	Knife Driving Lever Fork Swivel Screw for 16747 and 65064.
108W	3385	Cylinder End Cover Screw (right) for 17-19 Machine.
108E	3385	Presser Bar Lifter Screw for 2060, obsolete.
112E	217	Shuttle (inside) Tension Spring Plate Screw for 56755.
112E	217	Shuttle (outside) Tension Spring Plate Screw for 56753 and 56754.
112E	217	Shuttle Tension Spring Plate Screw for 16869, 17418, 44001 and 125017.
123E	312	Arm Screw.

NO.	PLATE	NAME
129J	3384	Feed Shaft Bracket (back) Screw for 16666.....
129J	3384	Feed Shaft Bracket (front) Screw for 16666.....
129E	3384	Feed (upper) Shaft Bracket (back) Screw for 16782.....
129E	3384	Feed (upper) Shaft Bracket (front) Screw for 16782.....
133F	379	Feed Lever Stop Screw for 17-12 Machine, obsolete.....
136F	379	Driving Flange Latch Hinge Screw for 5993.....
144D	3384	Arm Shaft Screw.....
145J	3384	" Spool Bracket Screw for 17-7 and 17-21 Machines.....
145E	3384	Crank Connecting Rod Cap Screw for 4292.....
145E	3384	Feed Regulator Lever Shaft Bracket Screw for 6125 and 16676.....
155c	3384	Needle Bar Connecting Stud Set Screw for 2052 and 15472.....
156F	379	Feed Rock Shaft Crank Position Screw for 17-1 to 17-5, 17-7 to 17-9, 17-11, 17-15 to 17-23, 17-25, 17-29 and 17-30 Machines.....
156F	379	Feed (lower) Rock Shaft Crank Position Screw for 17-26 Machine.....
159E	3384	Feed Lever Bracket Screw (upper) for 6301 and 16666.....
161J	3384	Bobbin Winder Screw for 16800.....
161E	3384	Feed Shaft Bracket (back) Screw for 6301, for 17-12 Machine, obsolete.....
161E	3384	Feed Shaft Bracket (front) Screw for 6301, for 17-12 Machine, obsolete.....
164J	312	Face Plate Screw for 17-1 to 17-7, 17-10, 17-13 to 17-19, 17-22, 17-23 and 17-27 to 17-30 Machines.....
171F	312	Roller Needle Guard (round) Screw for 4790.....
171D	312	Throat Plate Holder Screw for 17-15 to 17-17 and 17-30 Machines, and obsolete for 17-1 Machine.....
172c	3379	Presser Bar Lifting Rock Shaft Arm Clamping Screw for 16731.....
175J	3384	Face Plate Screw for 17-8, 17-9, 17-11, 17-12, 17-20, 17-21 and 17-24 to 17-26 Machines.....

NO.	PLATE	NAME
175J	3384	Shuttle Race Ring Screw for 17-1, 17-2, 17-5, 17-11, 17-15 to 17-18, 17-20, 17-24, 17-26 and 17-29 Machines.....
176J	231	Roller Arm Lock Spring Screw for 2196, 2197, 2309, 2310, 4790, 6070, 6071, 6141 to 6144, 16099, 16100, 16623, 16624, 16755, 65030, 65041, 65046, 65047, 65051, 65086 and 65099.....
180J	3384	Feed Lever Bracket Screw (lower) for 16666.....
180J	3384	Feed (upper) Lever Bracket Screw for 17-26 Machine.....
185H	379	Feed Dog Screw for 17-6, 17-10, 17-13 and 17-14 Machines.....
190J	3384	Feed (lower) Rock Shaft Crank Set Screw for 17-26 Machine.....
190J	3384	Feed Regulator Lever Friction Plate Screw for 6809.....
190J	3384	Feed Rock Shaft Crank Set Screw for 17-22, 17-23 and 17-25 Machines.....
190J	3384	Guide Arm Screw for 36487.....
190J	3384	" Screw for 36487.....
190J	3384	Hemmer Screw for 17-13 and 17-14 Machines.....
190J	3384	Lifting Presser Foot Screw for 17-24 Machine.....
190J	3377	Presser Foot Cap Screw for 16710, obsolete.....
190J	3384	Presser Foot Screw for 17-1 to 17-7, 17-10, 17-13 to 17-19, 17-22, 17-23, 17-27, 17-28 and 17-30 Machines.....
190J	3384	Roller Presser Screw for 17-1 to 17-3, 17-6, 17-7, 17-10, 17-11, 17-15, 17-16, 17-18, 17-19, 17-22, 17-23 and 17-29 Machines.....
190J	3384	Tape Holder Set Screw for 35827.....
190J	3384	Tension Bracket Screw for 3205, obsolete.....
193J	20883	Lifting Presser Foot Screw for 17-8, 17-9, 17-12, 17-20, 17-21, 17-25 and 17-26 Machines.....
196F	3383	Needle Clamp Screw for 2167, 3345, 3350, 4265, 6077, 7524 and 16813.....
196F	3383	Needle (inside) Set Screw for 3352, for 17-7 Machine, obsolete.....
196F	3377	Presser Foot Bracket Set Screw for 16702, obsolete.....

NO.	PLATE	NAME
196F	3377	Presser Foot Lifting Lever Set Screw for 16707, obsolete.....
197E	312	Oscillating Rock Shaft Oil Pad Screw for 6021 and 6063 to 6066, obsolete.....
198J	3384	Guide Arm Hinge Plate Pin Set Screw for 36484.....
198J	312	Shuttle Race and Throat Ring Screw for 17-3, 17-4 and 17-9 Machines.....
198J	312	Shuttle Race Ring Screw for 17-6, 17-10, 17-13 and 17-14 Machines.....
198J	312	Shuttle Race Screw for 17-8 Machine.....
202E	312	Lifting Presser Bar Lifting Bracket Screw for 6331, 6345, 6445 and 6446, obsolete.....
207F	3363	Binder Folder Screw for 28821.....
207F	3384	Feed Regulator Lever Set Screw for 6808.....
207F	3384	" Rock 'Shaft' Crank Set Screw for 6018 and 6019.....
207F	3384	Feed Rod Lifting Block Screw for 17-6, 17-10, 17-13 and 17-14 Machines.....
207F	3384	Feed Wheel Driver Spring Screw for 17-3, 17-4 and 17-9 Machines.....
207F	3384	Feed Wheel Friction Spring Screw for 17-3, 17-4 and 17-9 Machines.....
207F	3384	Roller Needle Guard (flat) Screw for 4790.....
208J	3377	Presser Foot Guide Screw for 16710, obsolete.....
208E	3384	Thread Unwinder Thread Guide Rod Screw for 225321.....
211D	379	Needle Plate Screw for 17-12 Machine, obsolete.....
211D	379	Throat Plate Screw for 6041 and 6045, for 17-1 Machine, and for 6076, for 17-2 Machine, obsolete.....
212E	379	Feed Forked Connection Universal Joint Cap Screw for 17-6, 17-10, 17-13 and 17-14 Machines.....
217J	3384	Feeding Foot Screw for 17-26 Machine....
217J	3384	Feed Point Screw for 17-12 and 17-24 Machines.....
217J	3384	Knife Driving Lever Adjusting Block Screw for 65064.....
217J	3384	Vibrating Presser Foot Screw for 17-8, 17-9, 17-20, 17-21 and 17-25 Machines..
220J	3384	Needle Plate Screw for 65011.....
220J	3384	Shuttle Race Ring Cap Screw for 16669 and 65011.....

NO.	PLATE	NAME
223F	312	Knife Screw for 3096 and 3109.....
223F	312	Needle Plate Screw for 17-12 Machine...
223D	312	Throat Plate Screw for 17-5 and 17-20 Machines.....
225c	379	Feed Dog Screw for 17-1, 17-2, 17-5, 17-7, 17-8, 17-11, 17-15 to 17-23, 17-25, 17-29 and 17-30 Machines.....
225c	379	Feed (lower) Dog Screw for 17-26 Machine
230F	20883	Roller Ratchet Spring Stop Bracket Screw for 65099.....
233J	3384	Box Support Screw for 17-4 Machine.....
233J	3384	Face Plate Thread Guard Screw for 3206, 4856, 56775, 56802, 56873, 65045 and 65075.....
233J	3384	Face Plate Thread Guard (lower) Screw for 16883.....
233J	3384	Feed Regulator Slide Block Spring Screw for 17-12 Machine, obsolete.....
233J	3384	Feed Rod Spring Screw for 17-6, 17-10, 17-13 and 17-14 Machines.....
233J	3382	Knife Driving Lever Fork Cover Screw for 17-29 Machine.....
233J	3384	Needle Bar Thread Guard Screw for 17-26 and 17-30 Machines, and obsolete for 2053, 2166 and 4301.....
233J	3384	Thread Take-up Spring Regulator Plate Adjusting Screw for 3206, 4856, 16883, 56775, 56802, 56803, 56818, 56873 and 65075.....
233J	3384	Thread Take-up Spring Regulator Screw, obsolete.....
237J	3384	Feed Regulator Thumb Screw Stop Bracket Screw for 4905.....
237J	3384	Feed (upper) Regulator Thumb Screw Stop Bracket Screw for 4905.....
237K	1105	Knife Grinder Knife Holder Stop Collar Set Screw for 27659.....
238D	3382	Throat Plate Needle Hole Strip Screw for 16759 and 65033.....
240J	385	Cylinder End Cover Latch Screw for 16663.....
240J	385	Needle Bar Thread Guard Screw for 17-2, 17-4, 17-19 and 17-22 Machines.....
240J	385	Needle Clamp Thread Eyelet Screw for 6078, obsolete.....
240J	385	Shuttle Race Ring Cover Latch Screw for 16772 and 16779.....

NO.	PLATE	NAME
241J	3384	Shuttle Race Ring Thread Protector Screw for 6118.....
246F	312	Needle Clamp Screw for 5682, obsolete...
248A	3385	Clamp Stop Motion Clamp Stop Screw for 3022.....
256J	259	Clamp Stop Motion Clamp Screw for 3022.....
261D	312	Pressure Regulating Thumb Screw for 3055, for 17-1 Machine, obsolete.....
261J	1105	Knife Grinder Knife Regulating Thumb Screw for 60583.....
262J	312	Pressure Regulating Thumb Screw for 17-1 to 17-27, 17-29 and 17-30 Machines
284D	3385	Guide Thumb Screw for 17-8 Machine....
286D	3385	Arm Side Cover Thumb Screw.....
286D	3385	Bobbin Winder Eccentric Thumb Screw for 5525, 5531, 5533 and 5534.....
286D	3385	Feed Regulator Lever Adjusting Thumb Screw for 17-10 and 17-30 Machines....
286D	3385	Guide Rod Thumb Screw for 6097 and 6098.....
286D	3385	Guide Thumb Screw for 17-15 to 17-17 and 17-30 Machines.....
286D	3385	Tape Holder Tension Adjusting Collar Thumb Screw for 35826.....
290E	3385	Needle Bar Screw Bushing for 17-1 to 17-7, 17-10, 17-13 to 17-19, 17-22, 17-23 and 17-27 to 17-30 Machines.....
290E	3385	Presser Bar Screw Bushing for 17-1 to 17-7, 17-10, 17-13 to 17-19, 17-22, 17-23 and 17-27 to 17-30 Machines.....
295C	379	Oscillating Rock Shaft Screw Center (long) for 6062 to 6064, obsolete.....
300C	3384	Feed Rock Shaft Screw Center for 17-6, 17-10, 17-13 and 17-14 Machines.....
304C	379	Feed Rock Shaft Screw Center for 6137 and 6160, obsolete.....
304C	379	Oscillating Rock Shaft Screw Center (short) for 6062 to 6064, obsolete.....
310K	1105	Knife Grinder Emery Wheel Shaft Screw Center for 60583.....
310K	1105	Knife Grinder Knife Holder Guide Bar Bracket Screw Center for 60583.....
316F	231	Roller Arm Bracket Screw Center for 15444.....
330J	379	Driving Flange Latch Spring Screw for 5993.....

NO.	PLATE	NAME
330J	379	Feed Regulator Lever Segment Screw for 17-10, 17-16 and 17-30 Machines...
330J	379	Shuttle Race Ring Cover Bracket Screw for 16877, 16896 and 65080.....
330J	379	Shuttle Race Ring Cover Spring Screw for 65080 and for 17-6, 17-10, 17-13 and 17-14 Machines.....
330J	379	Tension Thread Eyelet Screw for 3200, 3266, 4856 and 56818.....
335H	3386	Knife Holder Screw for 3090 and 4581....
335H	3386	" Screw for 17-11 Machine, obsolete....
335D	3386	Throat Plate Screw for 65031 and 65033
336F	3384	Needle Set Screw for 4783 and for 17-11 and 17-26 Machines.....
337J	3363	Binder Ribbon Guide Screw for 28821....
337J	3385	Cylinder Feed Cover Screw for 17-5 and 17-20 Machines.....
337J	3385	Vibrating Presser Bar Spring Screw for 56844.....
337J	3385	Shuttle Race Ring Thread Protector Screw for 6032, 16602, 16797 and 16886
345C	379	Cloth Plate Bracket Set Screw for 6008, 6083, 16686, 16694, 16719 and 65014..
356C	3384	Rock Shaft Knee Arm Hub Set Screw for 2766.....
356C	3384	Rock Shaft Knee Plate Set Screw for 2767.....
356C	3384	Rock Shaft Lifting Bracket Hook Set Screw for 6337.....
356C	3384	Rock Shaft Lifting Bracket Set Screw for 6337.....
356C	3384	Rock Shaft Stop Dog Set Screw for 2770
375C	312	Crank Connecting Rod Hinge Screw....
375C	312	Feed Connecting Link Hinge Screw for 17-1 to 17-11, 17-13 to 17-23, 17-25, 17-29 and 17-30 Machines.....
375C	312	Feed (lower) Connecting Link Hinge Screw for 17-26 Machine.....
375C	312	Feed Forked Connection Hinge Screw for 17-1 to 17-11, 17-13 to 17-23, 17-25, 17-29 and 17-30 Machines.....
375C	312	Feed (lower) Forked Connection Hinge Screw for 17-26 Machine.....
377C	312	Needle Bar Connecting Link Hinge Screw for 17-1 to 17-7, 17-10, 17-13 to 17-19, 17-22, 17-23 and 17-27 to 17-30 Machines.....

NO.	PLATE	NAME
381D	379	Guide Bracket Screw for 6097.....
386D	3385	Roller Screw for 1839, 1869, 1897, 1898, 1932 and 1987.....
389F	312	Cloth Plate Screw for 6004, 6007, 6081, 16658, 16697, 16721 and 65017.....
390E	3385	Needle Bar Connecting Link Adjusting Screw for 3098 and 4898.....
398E	217	Shuttle Main Spring Screw for 3383, 6058 and 16867.....
398E	217	Shuttle (inside) Main Spring Screw for 3231, 3232, 3382 and 3383.....
398E	217	Shuttle (outside) Main Spring Screw for 3233 to 3235, 3522 to 3524, 4649 and 4798.....
399F	3396	Shuttle Race Ring Screw for 16877, 16896 and 65080.....
400C	312	Needle Bar Guide Adjusting Screw for 3214.....
400F	312	Shuttle Race Lock Pin Screw for 17-7 and 17-21 Machines.....
401D	3385	Cloth Plate Screw for 17-6, 17-10, 17-13 and 17-14 Machines.....
401D	3385	Needle Plate Screw for 17-27 Machine, obsolete.....
401J	3385	Throat Plate Holder Extension Screw for 17-17 Machine.....
401D	3385	Throat Plate Screw for 17-1, 17-2, 17-6 to 17-8, 17-10, 17-11, 17-13, 17-14, 17-18, 17-19, 17-21 to 17-23, 17-25, 17-26, and obsolete for 16759, for 17-29 Machine.....
404J	3385	Guide Bar Lifting Bracket Screw for 3127, 4730, 16781, 16794 and 56868.....
413F	379	Tension Screw Stud for 3028, for 17-1 Machine, obsolete.....
418E	3383	Bobbin Winder Tension Screw Stud for 27308.....
435C	379	Driving Flange Set Screw for 5978.....
437C	3385	Balance Wheel Speed Pulley Set Screw for 2140.....
440F	231	Roller Arm Adjusting Screw for 2196, 2197, 2309, 2310, 4790, 6070, 6071, 6141 to 6144, 16099, 16100, 16623, 16624, 16755, 65030, 65041, 65046, 65047, 65051, 65086 and 65099.....
446C	312	Feed Cam Set Screw for 3032, 6303 and 65008.....

NO.	PLATE	NAME
446C	312	Feed (lower and upper) Cam Set Screw for 16785.....
446C	312	Feed Eccentric Set Screw for 3074.....
446C	312	Thread Take-up Cam Set Screw for 3071, 3104, 3182, 3190, 3280, 4663, 6450, 16739, 65056, 65069 and 65083.....
448C	379	Arm Shaft Bushing (back) Set Screw.....
448C	379	Balance Wheel Set Screw for 3011 and 4370
448C	379	Feed Regulator Crank Set Screw for 5544 and 14647.....
448C	379	Lifting Lever Hook Set Screw for 16641..
448C	379	" " Pin Set Screw for 4724, 6443 and 16648.....
448C	379	Tension Screw Stud Set Screw for 16883, 56775, 56802, 56873, 65043, and 65075..
448C	379	Thread Guiding Roller Stud Set Screw for 3206, 4856 and 56818.....
451C	3385	Balance Wheel Speed Pulley Set Screw for 2139.....
453C	3385	Feed (upper) Forked Connection Set Screw for 4746.....
453C	3385	Feed Rock Shaft Arm Set Screw for 6167 and 16767.....
453C	3385	Feed Shaft Crank Set Screw for 6316.....
453C	3385	Needle Bar Guide Set Screw for 3214.....
453C	3385	Presser Bar Lifting Bracket Set Screw for 5608, 5611 and 5612.....
453C	3385	Presser Bar Spring Bracket Set Screw for 3057 to 3059 and 3220, obsolete.....
457C	3385	Feed Rock Shaft Arm Set Screw for 6138, obsolete.....
457C	3385	Shuttle Driver Set Screw for 2092, obsolete
460C	3379	Face Plate Thread Guard (upper) Set Screw for 16883.....
460C	3379	Needle Set Screw for 4496.....
460C	3379	Oscillating Shaft Crank Set Screw for 6056.....
460C	3379	Thread Retaining Stud Set Screw for 56775, 56802, 56873, 65044 and 65075
462C	3385	Clamp Stop Motion Flanged Bushing Set Screw for 4933.....
462C	3385	Oscillating Shaft Crank Set Screw for 6024, 6532, 7054, 16680 and 16683.....
463C	20883	Face Plate Thread Eyelet Set Screw for 65044.....
465C	3381	Knife Driving Lever Cam Set Screw for 16748.....

NO.	PLATE	NAME
465c	312	Needle Clamp Screw for 3352, obsolete...
466H	217	Shuttle Tension Regulating Screw for 16869, 17418, 44001 and 125017.....
466H	217	Shuttle (inside) Tension Regulating Screw for 56755.....
466H	217	Shuttle (outside) Tension Regulating Screw for 56753 and 56754.....
468c	3367	Knife Bar Driving Slide Coupling Pin Bushing Set Screw for 3095.....
514c	379	Knife Bar Driving Slide Coupling Pin for 3095.....
578J	3384	Needle Clamp Thread Guard Screw for 3352, obsolete.....
590E	379	Shuttle Race Ring Thread Protector Screw for 6148.....
591F	386	Shuttle Tension Regulating Screw for 15277 and 40112.....
592E	386	Shuttle Bobbin Case Latch Stop Screw for 15277 and 40112.....
598c	3385	Lifting Presser Bar Lifter Screw for 17-8, 17-9, 17-12, 17-20, 17-21 and 17-24 to 17-26 Machines.....
600c	379	Tension Screw Stud for 16202.....
602F	20883	Knife Screw for 24587.....
617c	379	Oscillating Rock Shaft Screw Center (long) for 6065 and 6066, obsolete.....
618c	3384	Feed Rock Shaft Screw Center for 6159, obsolete.....
619c	3384	Oscillating Rock Shaft Screw Center (short) for 6065 and 6066, obsolete.....
620c	379	Feed Lever Hinge Pin Set Screw for 6305
621D	3386	Knife Bar Handle Screw for 3090 and 4581.....
624c	312	Needle (outside) Set Screw for 3352, for 17-7 Machine, obsolete.....
626c	3385	Guide Bar Lifting Bracket Guide Screw Stud for 17-8, 17-9 and 17-12 Machines, obsolete.....
629D	379	Shuttle Race Hinge Screw for 16742.....
634D	3385	Roller Screw for 1854.....
637F	3385	Tension Screw Stud for 3206 and 3266, obsolete.....
641E	3384	Lifting Presser Bar Bracket Clamping Screw for 3133.....
651J	3383	Needle Clamp Thread Guide Screw for 4803, 4865 and 7524.....
652D	3385	Roller Screw for 1841 and 1868.....

NO.	PLATE	NAME
657F	3384	Feed Rod Hinge Screw for 17-6, 17-10, 17-13 and 17-14 Machines.....
662J	3379	Needle Bar Thread Eyelet Screw for 17-28 Machine.....
665J	3384	Needle Bar Thread Guard Screw for 17-3 Machine.....
665J	3384	Needle Clamp Thread Guide Screw for 16814.....
665J	3384	Roller Ratchet Spring Stop Screw for 62854.....
665J	3384	Shuttle Race Loop Separator Screw for 6206 and 6213.....
665J	3384	Shuttle Race Thread Protector Screw for 65078.....
666F	3385	Feed Regulator Thumb Screw Lock Screw for 4938.....
666F	3385	Feed (upper) Regulator Thumb Screw Lock Screw for 4938.....
668D	3385	Guide Arm Screw Stud for 36487.....
668D	3385	" Smoothing Arm Screw Stud for 36487.....
683J	3384	Shuttle Race Screw for 17-27 Machine, obsolete.....
683D	3384	Lifting Presser Bar Lifter Stop Screw for 17-12 and 17-24 Machines.....
689c	312	Presser Bar Lifter Screw for 17-1 to 17-7, 17-10, 17-11, 17-13 to 17-19, 17-22, 17-23 and 17-27 to 17-30 Machines.....
690E	312	Guide Bar Driving Crank Wedge Screw for 17-8, 17-9, 17-12, 17-20, 17-21 and 17-24 to 17-26 Machines.....
690E	312	Knife Bar Driving Crank Wedge Screw for 17-11 Machine.....
725J	312	Cloth Plate Slide Spring Screw for 6005, 6082, 16696, 16720 and 65016.....
725J	312	Shuttle Race Cover Latch Screw for 16689.....
725J	312	Shuttle Race Ring Cover Latch Screw for 16689.....
732D	379	Feed Regulator Lever Friction Plate Thumb Screw for 17-10, 17-16 and 17-30 Machines.....
732D	379	Feed Regulator Lever Adjusting Thumb Screw for 17-16 Machine.....
738J	379	Shuttle Race Screw for $\frac{1}{2}$ in. to $\frac{3}{4}$ in. gauges, for 17-7 Machine, and for $\frac{1}{8}$ in. to $\frac{1}{2}$ in. gauges, for 17-21 Machine

NO.	PLATE	NAME
751D	379	Feed Regulator Slide Block Screw Stud for 17-12 Machine, obsolete.....
756D	3381	Knife Driving Lever Center Plate Screw for 65066.....
767J	379	Shuttle Race Ring Thread Protector Screw for 16757.....
802D	379	Lifting Lever Hinge Screw for 6330 to 6332, 6344 to 6346, 6445, 6446, 16605, 16653, 16654, 16801 and 16803 to 16805
808F	379	Needle Clamp Screw for 4303 and 4803, obsolete.....
808F	379	Tension Stud Set Screw for 4856 and 56818.....
809C	379	Tension Stud (double) for 4856 and 56818
810D	379	Feed Bar Hinge Cap Screw for 16656.....
810D	379	" (upper) Bar Hinge Cap Screw for 16794.....
810E	379	Lifting Presser Bar Lifting Bell Crank Hinge Cap Screw for 16656 and 16794..
810D	3379	Presser Bar Lifting Rock Shaft Link Cap Screw for 17-28 Machine.....
810D	379	Vibrating Presser Bar Hinge Cap Screw for 3127, 4730 and 16781.....
810E	379	Vibrating Presser Bar Lifting Bell Crank Hinge Cap Screw for 3127, 4730 and 16781.....
818D	379	Feed Regulator Thumb Screw for 17-1 to 17-9, 17-11, 17-13 to 17-15, 17-17 to 17-23, 17-25 and 17-29 Machines.....
818D	379	Feed (lower) Regulator Thumb Screw for 17-26 Machine.....
866D	3385	Feed (upper) Lever Hinge Screw for 17-26 Machine.....
886C	3381	Knife Holder Adjusting Screw Binding Screw for 24188.....
899J	1105	Knife Grinder Knife Clamping Screw for 27658.....
934J	3381	Knife Driving Lever Center Plate Cap Screw for 65066.....
974D	3385	Guide Lever Hinge Screw for 36487.....
979D	3380	Shuttle Race Cover Hinge Screw for 17-28 Machine.....
1014D	3385	Feed Regulator Thumb Screw for 4938...
1014D	3385	" (upper) Regulator Thumb Screw for 4938.....
1053J	3388	Shuttle Race Cap Screw for 16811 and 65094.....

NO.	PLATE	NAME
1064D	3385	Lifting Lever Hinge Screw for 16645 and 16802.....
1088C	3388	Thread Take-up Lever Hinge Screw for 56855, 56869 and 65034.....
1097F	3381	Knife Holder Stop Screw for 65066.....
1098C	3381	" " Adjusting Screw for 24188..
1111E	3385	Oil Cup Screw Stud for 6436.....
1112F	385	Needle Clamp Screw for 16644.....
1116J	3377	Presser Foot Driving Arm Spring Screw for 16710, obsolete.....
1116F	3377	Needle Bar Thread Guard Screw for 17-11 Machine.....
1128E	20883	Feed Regulator Hinge Screw for 17-20 Machine.....
1208D	20882	Throat Plate Cutting Bar Screw for 6203..
1231D	3379	Needle Plate Screw for 17-28 Machine...
1346D	3382	Knife Driving Lever Plate Holder Screw for 17-29 Machine.....
1368J	20882	Binder Folder Screw for 120494 and 120495
1489J	3388	Bobbin Winder Screw for 5525, 5531, 5533 and 5534.....
1508J	1105	Knife Grinder Emery Wheel Clamping Nut for 60934.....
1513J	379	Feed Rock Shaft Screw Center Nut for 17-6, 17-10, 17-13 and 17-14 Machines
1513J	379	Oscillating Rock Shaft Hinge Pin Nut for 56812.....
1516J	1105	Knife Grinder Emery Wheel Shaft Screw Center Nut for 60583.....
1516J	1105	Knife Grinder Knife Holder Guide Bar Bracket Screw Center Nut for 60583...
1517E	3386	Feed (upper) Lever Hinge Screw Nut for 17-26 Machine.....
1518J	312	Crank Connecting Rod Hinge Screw Nut
1518J	312	Feed Connecting Link Hinge Screw Nut for 17-1 to 17-11, 17-13 to 17-23, 17-25, 17-29 and 17-30 Machines.....
1518J	312	Feed (lower) Connecting Link Hinge Screw Nut for 17-26 Machine.....
1518J	312	Feed Forked Connection Hinge Screw Nut for 17-1 to 17-11, 17-13 to 17-23, 17-25, 17-29 and 17-30 Machines.....
1518J	312	Feed (lower) Forked Connection Hinge Screw Nut for 17-26 Machine.....

NO.	PLATE	NAME
1518J	312	Needle Bar Connecting Link Hinge Screw Nut for 17-1 to 17-7, 17-10, 17-13 to 17-19, 17-22, 17-23 and 17-27 to 17-30 Machines.....
1520E	379	Presser Bar Lifter Screw Nut for 17-1 to 17-7, 17-10, 17-11, 17-13 to 17-19, 17-22, 17-23 and 17-27 to 17-30 Machines.....
1521E	3386	Lifting Lever Connecting Rod Lock Nut for 16605, obsolete.....
1528J	3386	Roller Screw Nut for 1839, 1841, 1854, 1868, 1869, 1897, 1898, 1932, 1987, 51850, 51852, 51861 and 51893.....
1529E	20884	Thread Lubricator Bracket Screw Nut for 65092.....
1547J	231	Roller Arm Adjusting Screw Nut for 2196, 2197, 2309, 2310, 4790, 6070, 6071, 6141, to 6144, 16099, 16100, 16623, 16624, 16755, 65030, 65041, 65046, 65047, 65051, 65086 and 65099.....
1547J	231	Roller Arm Bracket Screw Center Nut for 15444.....
1549J	231	Roller Arm Lock Spring Screw Nut for 2196, 2197, 2309, 2310, 4790, 6070, 6071, 6141 to 6144, 16099, 16100, 16623, 16624, 16755, 65030, 65041, 65046, 65047, 65051, 65086 and 65099.....
1560C	379	Guide Arm Spring Regulating Thumb Nut for 36487.....
1560C	379	Guide Smoothing Arm Spring Regulating Thumb Nut for 36487.....
1560C	379	Tension Regulating Thumb Nut for 3206, 3266, 4856, 16202 and 56818.....
1562J	3383	Bobbin Winder Tension Regulating Thumb Nut for 27308.....
1564D	3386	Knife Bar Driving Slide Coupling Pin Head for 3095.....
1584E	379	Feed Regulator Lever Adjusting Thumb Screw Nut for 17-10, 17-16 and 17-30 Machines.....
1591E	379	Feed Regulator Slide Block Screw Stud Nut for 17-12 Machine, obsolete.....
1592E	3386	Feed Lever Stop Screw Lock Nut for 17-12 Machine, obsolete.....
1593D	3386	Guide Rod Holder Thumb Nut for 6097 and 6098.....
1620J	3388	Bobbin Winder Frame Hinge Screw Nut for 27646, 27647 and 27656.....

NO.	PLATE	NAME
1632C	3388	Pressure Regulating Thumb Screw Lock Nut for 17-24 and 17-28 Machines.....
1678C	3379	Needle Clamping Nut for 17-28 Machine.....
1766C	20882	Roller Ball Retaining Nut for 51850, 51852, 51861 and 51893.....
1813	221	Feed Shaft Crank Roller and Stud for 6316.....
1813	221	Oscillating Shaft Crank Roller and Stud for 6024, 6056, 6520, 7525, 16679 and 16682.....
1819	379	Thread Take-up Lever Roller and Stud for 3072, 3281 and 16740.....
1822	221	Knife Bar Driving Crank Roller and Stud for 3092.....
1823	221	Lifting Presser Bar Bracket Roller and Stud for 3133.....
1839	231	Roller, 1½ in. diam., coarse, with 386D and 1528J, for 6143, 16099 and 16623..
1841	—	Roller, ¾ in. diam., fine, with 652D and 1528J, for 2197, 2310, 6071 and 6142..
1852	371	Guide Roller and Screw Stud for 6440.....
1854	3372	Roller, 1½ in. diam., with 634D and 1528J, for 4790.....
1862	297	Guide Bar Driving Crank Roller (roller only) for 3130 and 4854.....
1868	231	Roller, ¾ in. diam., coarse, with 652D and 1528J, for 2196, 2309, 6070 and 6141..
1869	—	Roller, 1¼ in. diam., fine, with 386D and 1528J, for 6144, 16100 and 16624.....
1897	—	Roller, 1¼ in. diam., coarse, with 386D and 1528J, for 65051.....
1898	3388	Roller, 1¼ in. diam., fine, with 386D and 1528J, for 65030.....
1932	—	Roller, 1¼ in. diam., fine, with 386D and 1528J, for 65046.....
1979	3379	Presser Bar Lifting Rock Shaft Arm Roller and Screw Stud for 16731.....
1987	3371	Roller, 1¼ in. diam., coarse, with 386D and 1528J, for 16755.....
2020	259	Clamp Stop Motion Clamp Washer for 3022.....
2022	221	Clamp Stop Motion Flanged Bushing Pin for 17-1 to 17-4, 17-6 to 17-11, 17-13 to 17-17, 17-19, 17-21 to 17-23, 17-25 and 17-27 to 17-30 Machines.....
2049	221	Feed Regulator Lever Pin for 17-10, 17-16 and 17-30 Machines.....

210 NUMERICAL LIST OF PARTS

NO.	PLATE	NAME
2049	221	Feed Regulator Pin for 17-12 and 17-24 Machines.....
2049	221	Feed (upper) Regulator Pin for 17-26 Machine.....
2049	221	Oscillating Shaft Crank Pin.....
2049	221	Shuttle Driver and Feed Lifting Cam Pin for 17-1, 17-2, 17-5 to 17-8, 17-10, 17-11, 17-13 to 17-23, 17-25, 17-26, 17-29 and 17-30 Machines.....
2049	221	Shuttle Driver Pin for 17-3, 17-4, 17-9, 17-12, 17-24, 17-27 and 17-28 Machines.....
2049	221	Shuttle Race Dowel Pin for 17-7 and 17-21 Machines.....
2052	374	Needle Bar Connecting Stud with 155c, for 56773.....
2053	3383	Needle Bar Thread Guard for 17-22 Machine, obsolete.....
2058	3365	Lifting Presser Bar for 17-8, 17-9, 17-12, 17-20, 17-21 and 17-24 to 17-26 Machines.....
2058	3365	Presser Bar for 17-11, 17-15, 17-16 and 17-30 Machines.....
2060	301	Presser Bar Lifter for 108, for 17-1 Machine, obsolete.....
2061	301	Presser Bar Lifter for 33 and 70, for 17-1 Machine, obsolete.....
2062	301	Presser Bar Lifter for 17-1 to 17-7, 17-10, 17-11, 17-13 to 17-19, 17-22, and obsolete for 17-23 and 17-27 to 17-30 Machines.....
2063	221	Presser Bar Lifter Stud for 2175, obsolete.....
2069	221	" " Spring (flat) Guide Pin, obsolete.....
2070	221	Lifting Presser Bar Spring Washer for 17-8, 17-9, 17-12, 17-20, 17-21 and 17-24 to 17-26 Machines.....
2070	221	Presser Bar Spring Washer for 17-1 to 17-7, 17-10, 17-11, 17-13 to 17-19, 17-22, 17-23 and 17-27 to 17-30 Machines..
2073	217	Shuttle Bobbin for 6028, 16869 and 16892.....
*2075	—	" Cover for 44001, obsolete.....
2076	217	" " Hinge Pin for 6028, 6909 and 16892.....
2076	217	Shuttle (inside) Cover Hinge Pin for 3225, 3226, 3380 and 3381.....
2076	217	Shuttle (outside) Cover Hinge Pin for 3227 to 3229, 3519 to 3521, 4648 and 4729.....

NUMERICAL LIST OF PARTS 211

NO.	PLATE	NAME
2078	217	Shuttle Delivery Eye Thread Guard for 16869, 44001 and 125017.....
2078	217	Shuttle (outside) Delivery Eye Thread Guard for 56753 and 56754.....
2080	217	Shuttle Delivery Eye Thread Guard Rivet for 16869, 17418, 44001 and 125017.....
2080	217	Shuttle (inside) Delivery Eye Thread Guard Rivet for 56755.....
2080	217	Shuttle (outside) Delivery Eye Thread Guard Rivet for 56753 and 56754.....
2082	217	Shuttle Main Spring for 6058 and 16867.....
2084	217	" " " Steady Pin for 3383, 6058 and 16867.....
2084	217	Shuttle (inside) Main Spring Steady Pin for 3231, 3232, 3382 and 3383.....
2084	217	Shuttle (outside) Main Spring Steady Pin for 3233 to 3235, 3522 to 3524, 4649 and 4798.....
2086	217	Shuttle Tension Spring for 16869, 44001 and 125017.....
2086	217	Shuttle (outside) Tension Spring for 56753 and 56754.....
2090	217	Shuttle Tension Spring Plate for 16869, 44001 and 125017.....
2090	217	Shuttle (outside) Tension Spring Plate for 56753 and 56754.....
2092	367	Shuttle Driver 2176 with two 457c, for 17-3 Machine, obsolete.....
2102	377	Tension Disc for 3206, 3266, 4856, 16882, 56791 and 56818.....
2103	377	Tension Spring for 3206, 3266, 4856, 56791 and 56818.....
2104	377	Tension Thread Guard for 17-1 Machine, obsolete.....
2105	377	Tension Thread Guard for 16881, 56789, 56796, 56872, 65043 and 65074.....
2105	377	Thread Guiding Roller Thread Guard for 3206, 56797 and 56817.....
2106	221	Bobbin Winder Tension Thread Guide for 27308.....
2106	221	Face Plate Thread Guard for 3028 and 3029, for 17-1 Machine, obsolete.....
2107	221	Face Plate Thread Guard for 3206, 4856, 56775, 56802, 65044 and 65075.....
2107	221	Face Plate Thread Guard (lower) for 16883.....

212 NUMERICAL LIST OF PARTS

NO.	PLATE	NAME
2108	221	Face Plate Thread Guard for 56818....
2111	221	Thread Retainer Guide complete for 56775, 56802, 56873, 65044 and 65075, Nos. 2112, 2114 and 2115.....
2112	221	Thread Retaining Disc with 2113, for 2111.....
2113	221	Thread Retaining Disc Steady Pin for 2112.....
2114	221	Thread Retaining Spring for 2111.....
2115	221	" " Stud for 2111.....
2117	221	Arm Dowel Pin for 17-1 to 17-18 Machines, obsolete.....
2117	221	Feed Rock Shaft Arm Pin for 17-6, 17-10, 17-13 and 17-14 Machines, obsolete....
2124	221	Thread Take-up Spring for 3206 and 56791.....
2125	221	Thread Take-up Spring Regulator for 17-1 Machine, obsolete.....
2126	221	Thread Take-up Spring Regulator Plate for 17-1 Machine, obsolete.....
2127	221	Thread Take-up Spring Regulator Plate for 3206, 4856, 16883, 56775, 56802, 56818, 56873, 65044 and 65075.....
2135	3392	Balance Wheel, heavy rim, 2½ in. pulley, for 17-30 Machine.....
2139	366	Balance Wheel Speed Pulley, 1½ in. diam., with 451c, for 17-1 to 17-4, 17-6 to 17-11, 17-13 to 17-17, 17-19, 17-21 to 17-23, 17-25 and 17-27 to 17-30 Machines.....
2140	366	Balance Wheel Speed Pulley, 2⅜ in. diam., with 437c, for 17-1 to 17-4, 17-6 to 17-11, 17-13 to 17-17, 17-19, 17-21 to 17-23, 17-25 and 17-27 to 17-30 Machines.....
2166	221	Needle Bar Thread Guard for 17-30 Machine, and obsolete for 3044, for 17-1 to 17-6, 17-10, 17-15, 17-17 and 17-18 Machines.....
2166	221	Needle Clamp Thread Guide for 17-29 Machine, obsolete.....
2167	221	Needle Clamp with 196F, for 17-30 Machine, and obsolete for 3044, for 17-1 to 17-6, 17-10, 17-15, 17-17, 17-18 and 17-29 Machines.....

NUMERICAL LIST OF PARTS 213

NO.	PLATE	NAME
2170	3383	Oscillating Rock Shaft Oil Pad for 6021, 6022 and 6063 to 6066, obsolete.....
2171	3375	Oscillating Rock Shaft Steel Plate for 6063 and 6065, obsolete.....
2172	3375	Oscillating Rock Shaft Steel Plate for 6064 and 6066, obsolete.....
2173	3375	Oscillating Rock Shaft Steel Plate for 6021, obsolete.....
2174	221	Oscillating Rock Shaft Steel Plate Rivet for 6021 and 6063 to 6066, obsolete....
2175	301	Presser Bar Lifter for 2063, for 17-1 Machine, obsolete.....
*2176	—	Shuttle Driver for 2092, obsolete.....
2180	372	Presser Foot for 17-1, 17-18 and 17-23 Machines.....
2183	372	Presser Foot for 17-17 Machine and obsolete for 6010, 6014 and 6015, for 17-1 Machine.....
2196	3371	Roller Presser complete, ⅞ in. coarse roller, for 17-1, 17-15, 17-16, 17-18 and 17-23 Machines, Nos. 176j, 440F, 1547j, 1549j, 1868, 2203, 2205, 2206 and two 15444.....
2197	—	Roller Presser complete, ⅞ in. fine roller, for 17-1, 17-15, 17-16, 17-18 and 17-23 Machines, Nos. 176j, 440F, 1547j, 1549j, 1841, 2203, 2205, 2206 and two 15444.....
2203	231	Roller Arm for 2196, 2197, 2309 and 2310.
2205	231	" " Lock Spring for 2196, 2197, 2309, 2310, 6070, 6071, 6141 to 6144, 16099, 16100, 16623, 16624, 16755, 65030, 65041, 65046, 65047, 65051, 65086 and 65099.....
2206	231	Roller Arm Bracket for 2196, 2197, 6141 and 6142.....
2210	217	Shuttle Bobbin for 6909.....
2210	217	" (inside) Bobbin for 3225, 3226, 3380 and 3381.....
2210	217	Shuttle (outside) Bobbin for 3227 to 3229, 3519 to 3521, 4648 and 4729.....
2211	217	Shuttle Bobbin Retaining Spring for 6058 and 16867.....
2212	217	Shuttle Bobbin Retaining Spring Rivet for 3383, 6058 and 16867.....
2212	217	Shuttle (inside) Bobbin Retaining Spring Rivet for 3232 and 3383.....

NO.	PLATE	NAME
2212	217	Shuttle (outside) Bobbin Retaining Spring Rivet for 3235, 3524, 4649 and 4798....
2248	221	Thread Take-up Spring with closed eyelet, for 4856 and 56818.....
2269	377	Tension Releaser Hinge Pin for 56775, 56802, 56873, 65044 and 65075.....
2273	3383	Needle Clamp Pin for 17-7 and 17-21 Machines.....
2273	3383	Needle Stop Pin for 3343, obsolete.....
2291	375	Knife Screw Washer for 4581.....
2296	375	" Bar Driving Slide Coupling Pin Bushing for 3095.....
2297	375	Knife Bar Driving Slide Coupling Pin Spring for 3095.....
2298	375	Knife Bar Handle for 3090 and 4581.....
2301	3383	" " Stop Pin for 3089.....
2306	375	Needle Bar Thread Guard for 17-11 and 17-26 Machines.....
2308	301	Presser Bar Spring (light) for 17-1 to 17-7, 17-10, 17-13 to 17-19, 17-22, 17-23, 17-29 and 17-30 Machines.....
2308	301	Presser Bar Spring for 17-27 Machine, obsolete.....
2309	—	Roller Presser complete, $\frac{3}{8}$ in. coarse roller, for 17-11 Machine, Nos. 176j, 440f, 1547j, 1549j, 1868, 2203, 2205, 2313 and two 15444.....
2310	378	Roller Presser complete, $\frac{3}{8}$ in. fine roller, for 17-11 Machine, Nos. 176j, 440f, 1547j, 1549j, 1841, 2203, 2205, 2313 and two 15444.....
2313	3373	Roller Arm Bracket for 2309 and 2310....
2328	375	Throat Plate Spring Slide for 6293.....
2330	375	" " " " Spring for 6293
2332	375	" " " " " S t o p Rivet for 6293.....
2358	259	Lifting Presser Foot for 17-8, 17-9, 17-20 and 17-25 Machines.....
2359	301	Lifting Presser Bar Lifter for 17-8, 17-9 and 17-12 Machines, obsolete.....
2361	259	Feed Bar Hinge Bracket for 56752.....
2361	259	" (upper) Bar Hinge Bracket for 56752.....
2361	259	Vibrating Presser Bar Hinge Bracket for 56752.....
2362	221	Feed Bar Hinge Bracket Rivet for 56752.

NO.	PLATE	NAME
2362	221	Feed (upper) Bar Hinge Bracket Rivet for 56752.....
2362	221	Vibrating Presser Bar Hinge Bracket Rivet for 56752.....
2410	221	Thread Guiding Roller for 3206, 4856 and 56818.....
2411	221	Thread Guiding Roller Stud for 3206, 4856 and 56818.....
2413	301	Tension Thread Eyelet (double) for 3206 and 3266, obsolete.....
2415	366	Arm Spool Bracket for 15063.....
2455	3383	Bobbin Winder Tension Disc for 27308...
2460	310	Bobbin Winder Friction Ring (rubber) for 5521, 5525, 5528, 5531, 5533, 5534 and 16800.....
2461	310	Bobbin Winder Pulley for 2463, 2469, 2694, 5530, 5533 and 5534.....
2462	310	Bobbin Winder Spindle with 15072, for 2463.....
2463	—	Bobbin Winder Spindle 2462 with 2461, for 5521 and 16900.....
2464	310	Bobbin Winder Spring for 5521, 5528 and 16800.....
2466	310	Bobbin Winder Eccentric for 5525, 5531, 5533 and 5534.....
2468	310	Bobbin Winder Spindle for 2469.....
2469	—	" " " 2468 with 2461, for 5525.....
2523	386	Shuttle Bobbin Case Position Finger Rivet for 15277 and 40112.....
2532	3378	Needle Plate Thread Guard Rivet for 16698, obsolete.....
2693	310	Bobbin Winder Spindle for 2694.....
2694	—	" " " 2693 with 2461, for 5531.....
2763	380	Rock Shaft for 6339.....
2766	380	" " Knee Arm Hub with 356c, for 6336 and 16647.....
2767	380	Rock Shaft Knee Plate with 356c, for 6336 and 16647.....
2770	380	Rock Shaft Stop Dog with 356c, for 6339.
2792	221	Thread Take-up Spring 2120 for 413, for 17-1 Machine, obsolete.....
2845	3369	Bobbin Winder Spindle, for bobbin, for 2847.....
2846	3369	Bobbin Winder Spindle, for spool, for 2847, 2853 and 27611.....

216 NUMERICAL LIST OF PARTS

NO.	PLATE	NAME
2847	—	Bobbin Winder Spindle 2845 with 2846, for 5534.....
2852	3369	Bobbin Winder Spindle, for bobbin, for 2853.....
2853	—	Bobbin Winder Spindle 2852 with 2846, for 5533.....
2862	364	Balance Wheel, heavy rim, 3 in. pulley, for 3022.....
2973	386	Shuttle Bobbin Case Latch Lever for 15141.....
2974	386	Shuttle Bobbin Case Latch Lever Fulcrum Pin for 15141.....
2975	386	Shuttle Bobbin Case Latch Spring for 15277 and 40112.....
2996	386	Shuttle Bobbin for 16613 and 16735.....
3005	259	Arm Shaft Bushing (back).....
3011	3364	Balance Wheel (two speed) 3 in. and 5 in. pulleys, with two 448c, for 17-5, 17-12, 17-18, 17-20, 17-24 and 17-26 Machines.....
3012	297	Thread Take-up Cam Pin.....
3022	—	Clamp Stop Motion complete for 17-1 to 17-4, 17-6 to 17-11, 17-13 to 17-17, 17-19, 17-21 to 17-23, 17-25 and 17-27 to 17-30 Machines, Nos. 248A, 256J, 2020 and 4933.....
*3023	—	Clamp Stop Motion Flanged Bushing for 4933.....
Nos. 3028 TO 3030 FOR 17-1 MACHINE, OBSOLETE		
3028	—	Face Plate for 413 and 2127.....
3029	—	“ “ “ 600.....
3030	—	“ “ “ 600, 2111 and 2127.....
3032	259	Feed Cam with 446c, for 17-1, 17-2, 17-5 to 17-8, 17-10, 17-11, 17-13 to 17-23, 17-25, 17-29 and 17-30 Machines.....
3033	259	Feed Connecting Link for 17-1 to 17-11, 17-13 to 17-23, 17-25, 17-29 and 17-30, Machines.....
3033	259	Feed (lower) Connecting Link for 17-26 Machine.....
3037	364	Feed Forked Connection for 17-1 to 17-5, 17-7, 17-9, 17-11, 17-20, 17-21 and 17-29 Machines.....
3039	259	Feed Regulator for 17-1 to 17-9, 17-11, 17-13 to 17-15, 17-17 to 17-23, 17-25 and 17-29 Machines.....

NUMERICAL LIST OF PARTS 217

NO.	PLATE	NAME
3044	301	Needle Bar for 17-30 Machine and obsolete for 17-1 to 17-6, 17-10, 17-15, 17-17 and 17-18 Machines.....
*3045	301	Needle Bar Connecting Link for 56773...
3052	367	Oscillating Rock Shaft Hinge Pin for 56812.....
3054	301	Lifting Presser Bar for 17-8, 17-9 and 17-12 Machines, obsolete.....
3054	301	Presser Bar for 17-1 to 17-6, 17-10, 17-13, 17-14, 17-17 to 17-19, 17-22, 17-23, 17-27 and 17-29 Machines.....
3055	301	Presser Bar Spring (flat) for 17-1 Machine, obsolete.....
3056	301	Presser Bar Spring (heavy) for 17-1 to 17-7, 17-10, 17-13 to 17-19, 17-22, 17-23 and 17-29 Machines.....
3057	297	Presser Bar Spring Bracket with 453c, for 3055, for 17-1 Machine, obsolete....
3058	297	Presser Bar Spring Bracket with 453c, for 2060 and 2175, for 17-1 Machine, obsolete.....
3059	297	Presser Bar Spring Bracket with 453c, for 2061, for 17-1 Machine, obsolete....
3071	370	Thread Take-up Cam with 446c, for 17-1 to 17-6, 17-10, 17-13 to 17-19 and 17-29 Machines, obsolete.....
*3072	259	Thread Take-up Lever with 1819, for 56855.....
3074	259	Feed Eccentric with 446c, for 17-3, 17-4 and 17-9 Machines.....
3088	—	Face Plate for 600 and 2111, for 17-11 Machine, obsolete.....
3089	259	Knife Bar with 2301, for 3090 and 4581..
3090	—	Knife Bar complete for 17-11 Machine, Nos. 621D, 2298, 3089, 3095, 3096 and two 335H, obsolete.....
3092	297	Knife Bar Driving Crank with 1822, for 17-11 Machine.....
3093	297	Feed Shaft Crank Pin for 17-12 and 17-24 Machines.....
3093	297	Feed (upper) Forked Connection Pin for 17-26 Machine.....
3094	297	Guide Bar Driving Crank Wedge for 17-8, 17-9, 17-12, 17-20, 17-21 and 17-24 to 17-26 Machines.....
3094	297	Knife Bar Driving Crank Wedge for 17-11 Machine.....

NO.	PLATE	NAME
3095	297	Knife Bar Driving Slide complete for 3090 and 4581, Nos. 468c, 514c, 1564d, 2296, 2297 and 4739.....
3096	—	Knife Holder with two 223f, for 3090, obsolete.....
3097	301	Needle Bar for 17-11 Machine.....
*3098	297	“ “ Connecting Link with 300E, for 56847, and obsolete for 17-8, 17-9 and 17-12 Machines.....
3100	301	Lifting Presser Bar Spring for 17-8, 17-9, 17-12, 17-20, 17-21 and 17-24 to 17-26 Machines.....
3100	301	Presser Bar Spring for 17-11 and 17-28 Machines.....
3104	370	Thread Take-up Cam 56843 with 446c, for 17-9 and 17-11 Machines.....
3109	297	Knife Holder with two 223f, for 4581....
3125	—	Face Plate for 600 and 2111, for 17-8 Machine, obsolete.....
3126	259	Guide Bar for 56752.....
3127	—	Guide Bar complete for 17-8 and 17-9 Machines, Nos. 810b, 810E, 3132, 3134, 3135, 56844 and three 404j, obsolete....
3130	297	Guide Bar Driving Crank with 1862 and 3131, for 17-8, 17-9 and 17-12 Machines, obsolete.....
3131	297	Guide Bar Driving Crank Roller Cap for 3130 and 4854.....
3132	259	Guide Bar Lifting Bracket for 3127, obsolete.....
3133	259	Lifting Presser Bar Bracket with 641E and 1823, for 17-8, 17-9, 17-12, 17-20, 17-21 and 17-24 to 17-26 Machines.....
3134	259	Vibrating Presser Bar for 3127 and 4730..
3135	259	Lifting Presser Bar Lifting Bell Crank for 17-12 Machine, obsolete.....
3135	259	Vibrating Presser Bar Lifting Bell Crank for 3127, obsolete.....
3136	259	Vibrating Presser Foot for 17-8, 17-20 and 17-25 Machines.....
3137	259	Vibrating Presser Bar Spring for 56844....
3146	3388	Feed Regulator Lever Adjusting Thumb Screw Nut Washer for 17-16 and 17-30 Machines.....
3182	3369	Thread Take-up Cam 56828 with 446c, for 17-22, 17-23 and 17-27 Machines....

NO.	PLATE	NAME
3190	3369	Thread Take-up Cam 56829 with 446c, for 17-25 Machine.....
3205	—	Face Plate with 3265 and two 190j, for 3214, for 3206, obsolete.....
3206	—	Face Plate complete for 17-7 Machine, Nos. 86b, 330j, 448c, 2105, 2107, 2124, 2127, 2410, 2411, 2413, 3205, two each 233j, 637f, 1560c, 2103 and four 2102, obsolete.....
3214	374	Needle Bar Guide with 400c and 453c, for 17-7 Machine.....
3215	302	Needle Clamp Thread Guard for 3352, obsolete.....
3220	377	Presser Bar Spring Bracket with 453c and 5613, for 3267, for 17-7 Machine, obsolete.....
3222	3372	Roller Arm for 4790.....
3225	3376	Shuttle (inside) complete, for $\frac{1}{8}$ in. to $\frac{3}{8}$ in. and $\frac{1}{4}$ in. to $\frac{1}{2}$ in. gauges, for 17-7 Machine, and for $\frac{1}{16}$ in., $\frac{3}{8}$ in. and $\frac{1}{4}$ in. to $\frac{1}{2}$ in. gauges, for 17-21 Machine, Nos. 2076, 2210, 3231 and 56755.....
3226	3376	Shuttle (inside) complete, for $\frac{1}{8}$ in. to $\frac{1}{4}$ in. and $\frac{1}{4}$ in. to $\frac{1}{2}$ in. gauges, for 17-7 Machine, and for $\frac{1}{16}$ in., $\frac{3}{8}$ in. and $\frac{1}{4}$ in. to $\frac{1}{2}$ in. gauges, for 17-21 Machine, Nos. 2076, 2210, 3232 and 56755.....
3227	6234	Shuttle (outside) complete, for $\frac{1}{8}$ in. and $\frac{3}{8}$ in., gauges, for 17-7 Machine, Nos. 2076, 2210, 3233 and 56753.....
3228	3376	Shuttle (outside) complete, for $\frac{1}{16}$ in. to $\frac{1}{4}$ in. gauges, for 17-7 and 17-21 Machines, Nos. 2076, 2210, 3234 and 56754.....
3229	3376	Shuttle (outside) complete, for $\frac{1}{16}$ in. to $\frac{1}{4}$ in. gauges, for 17-7 and 17-21 Machines, Nos. 2076, 2210, 3235 and 56754.....
3230	302	Shuttle Bobbin Retaining Spring for 3383
3230	302	“ (inside) Bobbin Retaining Spring for 3232 and 3383.....
3230	302	Shuttle (outside) Bobbin Retaining Spring for 3235, 3524, 4649 and 4798.....
*3231	—	Shuttle (inside) Body with 398E, 2084 and 3239, for 3225.....
*3232	—	Shuttle (inside) Body with 398E, 2084, 3230, 3239 and two 2212, for 3226.....
*3233	—	Shuttle (outside) Body with 398E, 2084 and 3240, for 3227.....

NO.	PLATE	NAME
*3234	—	Shuttle (outside) Body with 398E, 2084 and 3240, for 3223.....
*3235	—	Shuttle (outside) Body with 398E, 2084, 3230, 3240 and two 2212, for 3229.....
*3236	—	Shuttle (inside) Cover for 56755.....
*3237	—	" (outside) Cover for 56754.....
3238	302	Shuttle Delivery Eye Thread Guard for 17418.....
3238	302	Shuttle (inside) Delivery Eye Thread Guard for 56755.....
3239	302	Shuttle Main Spring for 3383.....
3239	302	" (inside) Main Spring for 3231, 3232, 3382 and 3383.....
3240	302	Shuttle (outside) Main Spring for 3233 to 3235, 3522 to 3524, 4649 and 4798.....
3241	302	Shuttle Tension Spring for 17418.....
3241	302	" (inside) Tension Spring for 56755.....
3242	302	" Tension Spring Plate for 17418.....
3242	302	" (inside) Tension Spring Plate for 56755.....
3265	259	Tension Bracket for 3205 and 3266, for 17-7 Machine, obsolete.....
3266	—	Tension Bracket complete for 17-7 Machine, Nos. 330J, 2413, 3265, two each 637E, 1560c, 2103 and four 2102, obsolete.....
3267	369	Tension Releaser for 17-7 Machine.....
3280	382	Thread Take-up Cam 56831 with 446c, for 17-1 to 17-7, 17-10, 17-13 to 17-19 and 17-29 Machines.....
3281	259	Thread Take-up Lever with 1819, for 56869.....
3286	368	Cloth Plate Slide Spring for 6005, 6082, 16696, 16720 and 65016.....
3342	301	Needle Bar for 3350, for 17-7 Machine, obsolete.....
3343	301	Needle Bar with 2273, for 3345, for 17-7 Machine, obsolete.....
3344	301	Needle Bar for 3352, for 17-7 Machine, obsolete.....
3345	302	Needle Clamp with 196E, for $\frac{1}{4}$ in. gauge, for 3343, for 17-7 Machine, obsolete.....
3350	302	Needle Clamp with two 196E, for $\frac{1}{4}$ in. to $\frac{1}{8}$ in. gauges, for 3342, for 17-7 Machine, obsolete.....
3352	302	Needle Clamp with 465c and two 624c, for $\frac{1}{4}$ in. gauge and above, for 3344, for 17-7 Machine, obsolete.....

NO.	PLATE	NAME
3360	302	Presser Foot (short shank) for $\frac{3}{8}$ in. gauge and above, for 17-7 Machine, obsolete.....
3364	302	Presser Foot (long shank) $\frac{1}{2}$ in. gauge and above, for 17-7 Machine.....
3374	302	Presser Foot (long shank) $\frac{1}{8}$ in. gauge and above, for inside stays (shoes) for 17-7 Machine.....
3380	6235	Shuttle (inside) complete, for $\frac{3}{8}$ in. to $\frac{1}{4}$ in. and $\frac{5}{16}$ in. gauges and above, for 17-7 and 17-21 Machines, Nos. 2076, 2210, 3382 and 56755.....
3381	6235	Shuttle (inside) complete, for $\frac{3}{8}$ in. to $\frac{1}{4}$ in. and $\frac{5}{16}$ in. gauges and above, for 17-7 and 17-21 Machines, Nos. 2076, 2210, 3383 and 56755.....
*3382	—	Shuttle (inside) Body with 398E, 2084 and 3239, for 3380.....
*3383	—	Shuttle (inside) Body with 398E, 2084, 3230, 3239 and two 2212, for 3381.....
*3383	—	Shuttle Body with 398E, 2084, 3230, 3239 and two 2212, for 6909.....
Nos. 3519 TO 3521 FOR 17-7 AND 17-21 MACHINES		
3519	6235	Shuttle (outside) complete, for $\frac{1}{4}$ in. gauge only, Nos. 2076, 2210, 3522 and 56753.....
3520	6235	Shuttle (outside) complete, for $\frac{1}{4}$ in. gauge and above, Nos. 2076, 2210, 3523 and 56754.....
3521	6235	Shuttle (outside) complete, for $\frac{1}{4}$ in. gauge and above, Nos. 2076, 2210, 3524 and 56754.....
*3522	—	Shuttle (outside) Body with 398E, 2084 and 3240, for 3519.....
*3523	—	Shuttle (outside) Body with 398E, 2084 and 3240, for 3520.....
*3524	—	Shuttle (outside) Body with 398E, 2084, 3230, 3240 and two 2212, for 3521.....
3758	302	Presser Foot (short shank) for $\frac{3}{8}$ in. gauge and above, for outside stays and strips, for 17-7 Machine, obsolete.....
3765	302	Presser Foot (long shank) $\frac{3}{8}$ in. gauge and above, for outside stays and strips, for 17-7 Machine.....

NO.	PLATE	NAME
4264	301	Needle Bar for 17-1, 17-5, 17-6, 17-8 to 17-10, 17-12 to 17-18, 17-20, 17-23 to 17-25, 17-27 and 17-29 Machines.....
4265	302	Needle Clamp with 196F, for 4865.....
4266	302	" " Thread Guide for 4865.....
4282	3371	Roller Arm Bracket for 6143, 6144, 16099, 16100, 16755, 65041, 65046, 65047, 65086 and 65099.....
4288	368	Arm Side Cover for 17-1 to 17-11, 17-13 to 17-23, 17-25 and 17-27 to 17-30 Machines.....
4292	364	Crank Connecting Rod.....
Nos. 4301 TO 4303, FOR 17-1, 17-2, 17-4, 17-8, 17-9 AND 17-12 TO 17-17 MACHINES, OBSOLETE		
4301	366	Needle Bar.....
4302	302	" " Thread Guard, for 4301.....
4303	302	" Clamp with 808F, for 4301.....
4343	365	Face Plate for 56796.....
4344	3365	Needle Bar for 17-7 and 17-21 Machines..
4347	20885	Wrench for 1513 and 1518 (Accessories)..
4359	3364	Arm Shaft for 17-8, 17-9, 17-11, 17-21 and 17-25 Machines.....
4368	364	Arm Shaft for 17-1 to 17-4, 17-6, 17-7, 17-10, 17-13 to 17-17, 17-19, 17-22, 17-23 and 17-27 to 17-30 Machines.....
4369	377	Tension Releaser for 56775, 56802, 65044 and 65075.....
4370	364	Balance Wheel, heavy rim, 2 $\frac{3}{4}$ in. pulley, with two 448c, for 17-1 to 17-4, 17-6 to 17-11, 17-13 to 17-17, 17-19, 17-21 to 17-23, 17-25 and 17-27 to 17-30 Machines.....
4376	3364	Face Plate with Tension Bracket (solid) for 56797.....
4377	3383	Tension Thread Eyelet (double) for 4856 and 56818.....
4378	3367	Tension Releaser for 56873.....
4380	3364	Face Plate for 56789.....
4389	3383	Arm Dowel Pin.....
4448	3383	" Oil Tube, for intermediate bearing, for 6001, 6060, 6125, 6165, 6271, 6284, 6301, 16666, 16676, 16687, 16716, 16775, 16782, 65021 and 65022.....

NO.	PLATE	NAME
*4449	—	Arm Shaft Bushing (front) for 6001, 6060, 6125, 6165, 6271, 6284, 6301, 16666, 16676, 16687, 16775, 16782, 65021 and 65022.....
4496	377	Needle Clamp with two 460c, for $\frac{3}{8}$ in. gauge and above, for 17-7 and 17-21 Machines.....
4581	—	Knife Bar complete for 17-11 Machine, Nos. 621b, 2291, 2298, 3089, 3095, 3109 and two 335H.....
*4582	—	Shuttle (outside) Cover for 56753.....
4648	6234	Shuttle (outside) complete, for $\frac{1}{2}$ in. and $\frac{3}{8}$ in. gauges, for 17-7 Machine, Nos. 2076, 2210, 4649 and 56753.....
*4649	—	Shuttle (outside) Body with 398E, 2084, 3230, 3240 and two 2212, for 4648.....
4662	3374	Lifting Presser Foot for 17-21 Machine...
4663	3369	Thread Take-up Cam with 446c, for 17-21 Machine.....
4666	3374	Vibrating Presser Foot for 17-21 Machine
4668	3365	Lifting Presser Bar Lifting Bracket for 17-21 Machine and for 16803 and 16805
4723	389	Guide Bar Lifting Bracket for 4730, 16781, 16794 and 56868.....
4724	384	Lifting Lever with 448c, for 16605, obsolete.....
4725	3365	Lifting Presser Bar Lifting Bracket for 17-8, 17-9, 17-12, 17-20 and 17-24 to 17-26 Machines and for 16605, 16645, 16653, 16654 and 16802.....
4726	3383	Lifting Presser Bar Lifting Bracket Guide Pin for 17-8, 17-9, 17-12, 17-20, 17-21, and 17-24 to 17-26 Machines and for 16605, 16645, 16653, 16654, 16802, 16803 and 16805.....
4727	3383	Lifting Lever Pin for 16605, 16653, 16654, 16803 and 16805.....
4729	3376	Shuttle (outside) complete, for $\frac{1}{4}$ in. gauge only, for 17-7 and 17-21 Machines, Nos. 2076, 2210, 4798 and 56753.....
4730	—	Guide Bar complete for 17-8, 17-9, 17-20 and 17-21 Machines, Nos. 810b, 810e, 3134, 4723, 4897, 56844 and three 404J
4739	3367	Knife Bar Driving Slide for 3095.....
4746	3368	Feed (upper) Forked Connection with 453c, for 17-26 Machine.....
4747	3367	Feed (lower) Regulator for 17-26 Machine

NO.	PLATE	NAME
4783	377	Needle Clamp with two 336F, for $\frac{1}{2}$ in. to $\frac{5}{8}$ in. gauges, for 17-7 Machine, and for $\frac{1}{8}$ in. and $\frac{5}{16}$ in. gauges, for 17-21 Machine.....
4784	3383	Oscillating Rock Shaft Oil Pad for 6022..
4785	3372	Roller Arm Bracket for 4790.....
4786	3372	" Needle Guard (flat) for 4790.....
4789	3372	" " " (round) for 4790....
4790	3372	Roller Presser complete, $1\frac{1}{2}$ in. roller, for 17-7 Machine, Nos. 171F, 176J, 207F, 440F, 1547J, 1549J, 1854, 3222, 4785, 4786, 4789, 7556 and two 15444.....
*4798	—	Shuttle (outside) Body with 398E, 2084, 3230, 3240 and two 2212, for 4729.....
4802	385	Needle Clamp Thread Guide for 4803. obsolete.....
4803	385	Needle Clamp complete for 17-5, 17-12 and 17-18 Machines, Nos. 651J, 808E, 4802 and 13112, obsolete.....
4822	20885	Wrench for 1528, 1547 and 1549 (Accessories).....
4834	3364	Face Plate for 56817.....
4835	3365	Tension Releaser for 17-21 Machine.....
4854	389	Guide Bar Driving Crank with 1862 and 3131, for 17-8, 17-9, 17-12, 17-20, 17-21 and 17-24 to 17-26 Machines.....
4855	3366	Lifting Presser Bar Lifter for 17-8, 17-9, 17-12, 17-20, 17-21 and 17-24 to 17-26 Machines.....
4856	—	Face Plate complete for 17-7 Machine, Nos. 86D, 330J, 448C, 808F, 809C, 2107, 2127, 2248, 2410, 2411, 4377, 56797, two each 233J, 1560C, 2103 and four 2102.....
4865	3383	Needle Clamp complete for 17-8, 17-12, 17-20, 17-24 and 17-25 Machines, Nos. 651J, 4265 and 4266.....
4879	3369	Chain Connecting Link for 4885.....
		Nos. 4881 to 4884 for 4885
4881	384	Treadle.....
4882	3369	" Shaft.....
4883	3369	" Spring.....
4884	384	" Stand.....
4885	384	Treadle complete for 6344 to 6346, 6446, 16654 and 16801 to 16803, Nos. 4879, 4881 to 4884 and two wood screws 1 in. No. 16.....

NO.	PLATE	NAME
*4891	—	Feed Shaft Bracket (front) for 16666.....
*4891	—	" (upper) Shaft Bracket (front) for 16782.....
*4892	—	Feed Shaft Bracket (back) for 16666.....
*4892	—	" (upper) Shaft Bracket (back) for 16782.....
4896	3375	Lifting Lever Hook for 6446, 16645 and 16802.....
4897	3365	Lifting Presser Bar Lifting Bell Crank for 16656 and 16794.....
4897	3365	Vibrating Presser Bar Lifting Bell Crank for 4730 and 16781.....
*4898	3367	Needle Bar Connecting Link with 390E, for 56764.....
4904	3368	Feed Lever for 17-12 Machine.....
4905	3369	" Regulator with 4907 and two 237J, for 4938.....
4905	3369	Feed (upper) Regulator with 4907 and two 237J, for 4938.....
4906	3367	Feed Regulator Slide Block for 4938.....
4906	3367	" (upper) Regulator Slide Block for 4938.....
4907	3367	Feed Regulator Thumb Screw Stop Bracket for 4905.....
4907	3367	Feed (upper) Regulator Thumb Screw Stop Bracket for 4905.....
4908	3366	Feed Shaft for 17-12 and 17-24 Machines.
4908	3366	" (upper) Shaft for 17-26 Machine....
4909	3370	Lifting Presser Bar Lifter for 17-24 Machine, obsolete.....
4918	20885	Wrench for 1632 (Accessories).....
4933	259	Clamp Stop Motion Flanged Bushing 3023 with two 462C, for 3022.....
4938	—	Feed Regulator complete for 17-12 and 17-24 Machines, Nos. 666F, 1014D, 4905, 4906 and 4959.....
4938	—	Feed (upper) Regulator complete for 17-26 Machine, Nos. 666F, 1014D, 4905, 4906 and 4959.....
4959	3383	Feed Regulator Thumb Screw Lock Stud for 4938.....
4959	3383	Feed (upper) Regulator Thumb Screw Lock Stud for 4938.....
5465	366	Needle Bar for 17-5 and 17-18 Machines, obsolete.....

NO.	PLATE	NAME
5521	310	Bobbin Winder (tight wheel) complete for 17-1 to 17-4, 17-6 to 17-11, 17-13 to 17-17, 17-19, 17-21, 17-29 and 17-30 Machines, Nos. 2460, 2463 and 5522
5522	310	Bobbin Winder Frame for 5521 and 5528
5525	310	Bobbin Winder (loose wheel) complete for 17-1 to 17-4, 17-6 to 17-11, 17-13 to 17-17, 17-19, 17-21, 17-29 and 17-30 Machines, Nos. 286d, 2460, 2466, 2469 and 5526
5526	310	Bobbin Winder Frame for 5525, 5531, 5533 and 5534
5528	310	Bobbin Winder (tight wheel) complete, for 17-22, 17-23, 17-25, 17-27 and 17-28 Machines, Nos. 2460, 5522 and 5530
5529	310	Bobbin Winder Spindle for 5530
5530	—	" " " 5529 with 2461, for 5528
5531	310	Bobbin Winder (loose wheel) complete for 17-22, 17-23, 17-25, 17-27 and 17-28 Machines, Nos. 286d, 2460, 2466, 2694 and 5526
5533	310	Bobbin Winder (loose wheel) complete for 17-22, 17-23, 17-25, 17-27 and 17-28 Machines, Nos. 286d, 2460, 2461, 2466, 2853 and 5526
5534	310	Bobbin Winder (loose wheel) complete for 17-1 to 17-4, 17-6 to 17-11, 17-13 to 17-17, 17-19, 17-21, 17-29 and 17-30 Machines, Nos. 286d, 2460, 2461, 2466 2847 and 5526
5544	259	Feed Regulator Crank with two 448c, for 17-16 and 17-30 Machines, and obsolete for 17-10 Machines
5550	3366	Feed Regulator Lever Shaft for 17-16 and 17-30 Machines
5608	259	Presser Bar Lifting Bracket with 453c, for 17-1 to 17-6, 17-10, 17-13 to 17-19, 17-22, 17-23, 17-27, 17-29 and 17-30 Machines and for 6330 and 6344
5610	259	Lifting Presser Bar Lifting Bracket for 6331, 6345, 6445 and 6446, obsolete
5611	382	Presser Bar Lifting Bracket with 453c and 5613, for 17-7 Machine and for 16801 and 16804
5612	3365	Presser Bar Lifting Bracket with 453c, for 17-11 Machine and for 6332 and 6346

NO.	PLATE	NAME
5613	3383	Tension Releaser Pin for 3220 and 5611
5667	380	Foot Lever for 5668, obsolete
5668	380	" " 5667 with 5669, 5671 and three wood screws 1½ in. No. 16, for 6344 to 6346 and 6446, obsolete
5669	380	Foot Lever Bracket for 5668, obsolete
5671	3383	" " Hinge Pin for 5668, obsolete
5672	380	" " Lifting Spring for 6344 to 6346 and 6446, obsolete
5977	3364	Balance Wheel (two speed) 3 in. and 5 in. pulleys, for 5981
Nos. 5978 to 5980 for 5993		
5978	366	Driving Flange with two 435c
5979	377	" " Latch
5980	377	" " Spring
5981	—	Loose Wheel Attachment complete for 17-5, 17-12, 17-18, 17-20, 17-24 and 17-26 Machines, Nos. 5977 and 5993
5993	—	Driving Flange complete for 5981, Nos. 136r, 330r and 5978 to 5980
*6001	—	Arm with 4448, 4449, 15404 and two 15405, for 17-1 to 17-4, 17-6, 17-7, 17-13 to 17-15, 17-17, 17-19, 17-22, 17-23, 17-27 and 17-29 Machines, and obsolete for 17-5 and 17-18 Machines
*6002	—	Cylinder, 2⅞ in. diam., for 17-1, 17-2 and 17-11 Machines, and obsolete for 17-8 Machine
*6003	—	Cylinder, 2⅞ in. diam., for 17-15 to 17-17 Machines, and obsolete for straight bearing throat plate, for 17-1 and 17-2 Machines
6004	—	Cloth Plate with Bracket complete for 17-1, 17-2 and 17-8 Machines, Nos. 6005, 6008 and two 389r
6005	365	Cloth Plate complete for 6004, Nos. 3286, 6009, 6054 and two 725r
6006	365	Cloth Plate for 6007
6007	—	Cloth Plate with Bracket complete for 17-15 and 17-16 Machines, Nos. 6006, 6008 and two 389r
6008	365	Cloth Plate Bracket with 345c, for 6004 and 6007
6009	368	Cloth Plate Slide for 6005 and 6082
6010	3363	Feed Dog, 12 teeth, for 28820, for 28821 and obsolete for cloth, for 17-1 Machine

NO.	PLATE	NAME
6011	372	Feed Dog, 12 teeth, for 6040 and 16603, for 17-1 Machine.....
6012	372	Feed Dog (incline feed) for 6042, for 17-17 Machine.....
6013	372	Feed Dog, (incline feed) 15 teeth (24 teeth to the inch) for 16714, for 17-15 Machine.....
6014	372	Feed Dog, 11 teeth (16 teeth to the inch) incline feed, for shirt work, for 17-1 Machine, obsolete.....
6015	371	Feed Dog, 12 teeth (circular feed) for shirt work, for 17-1 Machine, obsolete.....
6016	366	Feed Dog Carrier for 17-1, 17-2, 17-7, 17-8, 17-11, 17-18, 17-19 to 17-21 and 17-29 Machines.....
6016	366	Feed (lower) Dog Carrier for 17-26 Machine.....
6017	364	Feed Rock Shaft for 17-1, 17-2, 17-7, 17-8, 17-11, 17-15 to 17-19, 17-21 and 17-30 Machines.....
6017	364	Feed (lower) Rock Shaft for 17-26 Machine.....
6018	366	Feed Rock Shaft Crank with 207F, for 17-1 to 17-5, 17-7, 17-9, 17-11, 17-20, 17-21 and 17-29 Machines.....
6019	366	Feed Rock Shaft Crank with 207F, for 17-8, 17-15 to 17-19 and 17-30 Machines.....
6021	367	Oscillating Rock Shaft with 197E, 2170 and two each 2173 and 2174, for 3052, obsolete.....
*6022	367	Oscillating Rock Shaft with 4784, for 16806.....
6023	364	Oscillating Shaft for 17-1 to 17-6, 17-8 to 17-18, 17-20, 17-24, 17-26 and 17-30 Machines.....
6024	377	Oscillating Shaft Crank with 1813 and two 462c, for 17-1 to 17-6, 17-8 to 17-20, 17-24, 17-26, 17-29 and 17-30 Machines.....
6025	372	Presser Foot, $\frac{5}{32}$ in. tread, for 6013, for 17-15 Machine, and obsolete for 17-16 Machine.....
6026	372	Presser Foot, $\frac{1}{2}$ in. tread, for 6013, for 17-15 Machine, and obsolete for 17-16 Machine.....

NO.	PLATE	NAME
6028	217	Shuttle (high point) complete for 17-1 to 17-6, 17-8 to 17-18, 17-20, 17-24, 17-26 and 17-29 Machines, Nos. 2073, 2076, 6058 and 44001, obsolete.....
6029	367	Shuttle Driver for 17-12 and 17-24 Machines.....
6029	367	Shuttle Driver and Feed Lifting Cam for 17-1, 17-2, 17-5, 17-8, 17-11, 17-15 to 17-18, 17-20, 17-26 and 17-29 Machines.....
6030	368	Shuttle Race Ring for 17-15 and 17-16 Machines.....
6031	3370	Shuttle Race Ring, for shirt work, for 17-1 Machine, obsolete.....
6032	367	Shuttle Race Ring 6057 with 6059 and two 337J, for 17-1 and 17-2 Machines, and obsolete for 17-18 Machine.....
6033	368	Shuttle Race Ring with 6036 and two 6037, for 17-17 Machine.....
6036	375	Shuttle Race Ring Feed Plate for 6033.....
6037	3383	" " " " " Rivet for 6033.....
6039	372	Throat Plate, large needle hole, for 6010, obsolete.....
6040	372	Throat Plate, large needle hole, for 6011.....
6041	372	" " (straight bearing) for 6011, obsolete.....
6042	372	Throat Plate for 6012, for 6047.....
6043	372	" " " 6013 and 16684, for 6050, obsolete.....
6044	372	Throat Plate for 6014, for 6052, obsolete.....
6045	371	" " (straight bearing) for 6015, obsolete.....
6046	368	Throat Plate Holder with 16848, 16849 and four 16852, for 6047.....
6047	—	Throat Plate Holder 6046 with 6042, for 17-17 Machine.....
6048	368	Throat Plate Holder Extension for 17-17 Machine.....
6049	368	Throat Plate Holder with 16850, 16851 and four 16852, for 6050 and 16690.....
6050	—	Throat Plate Holder 6049 with 6043, for 17-15 and 17-16 Machines, obsolete.....
6051	3370	Throat Plate Holder for 6044, for 6052, obsolete.....
6052	—	Throat Plate Holder 6051 with 6044, for 17-1 Machine, obsolete.....
6053	380	Drip Pan.....

NO.	PLATE	NAME
6054	365	Cloth Plate for 6005.....
6055	377	Machine Base Bolt Nut Washer for 7169.
6055	377	" Bolt Nut Washer (Accessories)
*6056	—	Oscillating Shaft Crank with 460c and 1813, for 17-1 to 17-6, 17-8 to 17-20, 17-24, 17-26, 17-29 and 17-30 Machines.....
6057	—	Shuttle Race Ring for 6032.....
*6058	—	" Body with 398E, 2082, 2084, 2211 and two 2212, for 6028 and 16892.....
*6060	—	Arm with 4448, 4449, 15404 and two 15405, for 17-1 Machine, obsolete.....
6061	3370	Needle Bar, obsolete.....
Nos. 6062 TO 6064 FOR 295 AND 304, OBSOLETE		
6062	3370	Oscillating Rock Shaft (solid).....
6063	3370	" " " with 197E, 2170 and two each 2171 and 2174.....
6064	367	Oscillating Rock Shaft with 197E, 2170 and two each 2172 and 2174.....
6065	3370	Oscillating Rock Shaft with 197E, 2170 and two each 2171 and 2174, for 617 and 619, obsolete.....
6066	3370	Oscillating Rock Shaft with 197E, 2170 and two each 2172 and 2174, for 617 and 619, obsolete.....
6067	371	Feed Dog, 12 teeth, for cloth, for 17-2 Machine, obsolete.....
6068	371	Feed Dog, 12 teeth, for leather, for 6075, for 17-2 Machine.....
Nos. 6069 TO 6071 FOR 17-2, 17-3, 17-19 AND 17-22 MACHINES		
6069	376	Presser Foot.....
6070	—	Roller Presser complete, 7/8 in. coarse roller, Nos. 176J, 440F, 1547J, 1549J, 1868, 2205, 6072, 6073 and two 15444..
6071	378	Roller Presser complete, 1/8 in. fine roller, Nos. 176J, 440F, 1547J, 1549J, 1841, 2205, 6072, 6073 and two 15444.....
6072	389	Roller Arm for 6070 and 6071.....
6073	385	" " Bracket for 6070, 6071, 16623, 16624, 65030 and 65051.....
6074	371	Throat Plate for 6067, obsolete.....
6075	371	" " " 6068.....
6076	371	" " (straight bearing) for 6068, obsolete.....

NO.	PLATE	NAME
6077	—	Needle Clamp with 196F, for 6078, obsolete
6078	377	Needle Clamp complete for 17-5 and 17-18 Machines, Nos. 240J, 6077 and 6079, obsolete.....
6079	377	Needle Clamp Thread Eyelet for 6078, obsolete.....
*6080	—	Cylinder, 2 1/4 in. diam., for 17-3 and 17-9 Machines.....
6081	—	Cloth Plate with Bracket complete for 17-3 and 17-9 Machines, Nos. 6082, 6083 and two 389E.....
6082	365	Cloth Plate complete for 6081, Nos. 3286, 6009, 16768 and two 725J.....
6083	365	Cloth Plate Bracket with two 345c, for 6081.....
6085	364	Feed Rock Shaft for 17-3, 17-4 and 17-9 Machines.....
6086	367	Feed Wheel for 17-3 and 17-9 Machines..
Nos. 6087 TO 6089 FOR 17-3, 17-4 AND 17-9 MACHINES		
6087	366	Feed Wheel Driver.....
6088	375	" " " Spring.....
6089	377	" " Friction Spring.....
6090	367	Shuttle Race and Throat Ring for 17-3 and 17-9 Machines.....
Nos. 6091 TO 6093 FOR 17-4 MACHINE		
6091	369	Box Support (left).....
6092	369	" " (right).....
*6093	—	Cylinder, 2 1/2 in. diam.....
6094	—	Feed Wheel for 6095.....
6095	367	" " 6094 with 6096, for 17-4 Machine.....
6096	382	Feed Wheel Guide Ring for 6095.....
6097	—	Guide complete, for machine, for 17-4 Machine, Nos. 286D, 1593D, 6099, 6101, 6102, 6104, 42523 and two 381D.....
6098	—	Guide complete, for table, for 17-4 Machine, Nos. 286D, 1593D, 6100 to 6102, 6104, 42523 and two wood screws 1 in. No. 12.....
6099	369	Guide Bracket for 6097.....
6100	369	" " " 6098.....
6101	369	" Rod for 6097 and 6098.....
6102	369	" " Holder for 6097 and 6098.....
6104	369	" Roller for 6097 and 6098.....

NO.	PLATE	NAME
6105	374	Presser Foot for 17-4 Machine.....
6106	367	Shuttle Race and Throat Ring for 17-4 Machine.....
6107	364	Arm Shaft for 5977, for 17-5 and 17-18 Machines.....
6108	370	Shuttle Race Ring Cover for 17-5, 17-12 and 17-20 Machines, obsolete.....
6109	364	Arm Shaft for 3011, for 17-5 and 17-18 Machines.....

Nos. 6110 TO 6112 FOR 17-5 AND 17-20 MACHINES

*6110	—	Cylinder, $2\frac{1}{8}$ in. diam.....
6111	382	" Feed Cover.....
6112	371	Feed Dog, 12 teeth, for 6120 and 6449...
6113	366	" " Carrier for 17-5 Machine.....
6114	364	" Rock Shaft for 17-5 and 17-20 Machines.....
6115	365	Cloth Plate for 6123 and 6124.....
6116	3357	Feed Dog, 15 teeth (16 teeth to the inch) horse shoe, for 17-6 Machine, obsolete
6117	374	Presser Foot for 17-5 Machine.....
6118	367	Shuttle Race Ring 16769 with 6119 and two 241J, for 17-5, 17-12 and 17-20 Machines.....
6119	375	Shuttle Race Ring Thread Protector for 6118.....
6120	371	Throat Plate (large needle hole) for 6112
6121	376	Feed Dog, 15 teeth (16 teeth to the inch) horse shoe, for cloth, for 6123 and 6124, for 17-6 Machine.....
6122	376	Presser Foot (long shank) for 6121.....
6123	376	Throat Plate (large needle hole) for 6116 and 6121.....
6124	—	Throat Plate (small needle hole) for 6116 and 6121.....
*6125	—	Arm with 4448, 4449, 6169, 15404 and two each 145J and 15405, for 17-10 Machine.....
*6126	—	Cylinder, $2\frac{1}{4}$ in. diam., for 17-6, 17-10, 17-13 and 17-14 Machines.....
6127	365	Cloth Plate for 6163, 6164, 6172 to 6176 6270, 6280 and 6299.....
6128	3357	Feed Dog, 13 teeth (16 teeth to the inch) for cloth, for 17-6 Machine, obsolete...
6129	3357	Feed Dog, 11 teeth (15 teeth to the inch) for leather, for 17-6 Machine, obsolete..

NO.	PLATE	NAME
6131	370	Feed Forked Connection for 17-6, 17-10, 17-13 and 17-14 Machines, obsolete....
6132	374	Feed Forked Connection Universal Joint for 17-6, 17-10, 17-13 and 17-14 Machines.....
6133	368	Feed Regulator Lever Segment for 17-10 Machine, obsolete.....
6134	364	Feed Regulator Lever Shaft for 17-10 Machine and obsolete for 17-16 Machine
6135	3370	Feed Rod for 17-6, 17-10, 17-13 and 17-14 Machines, obsolete.....
6136	375	Feed Rod Lifting Block for 17-6, 17-10, 17-13 and 17-14 Machines, obsolete....
6137	370	Feed Rock Shaft for 17-6, 17-10, 17-13 and 17-14 Machines.....
6138	370	Feed Rock Shaft Arm with 457c, for 6160, for 17-6, 17-10, 17-13 and 17-14 Machines, obsolete.....
6139	374	Presser Foot (long shank) for 6156 and 6157.....
6140	374	Presser Foot (short shank) for 6156, 6157 and 6329.....

Nos. 6141 to 6144 FOR 17-6 AND 17-10 MACHINES

6141	378	Roller Presser complete, $\frac{3}{8}$ in. coarse roller, Nos. 176J, 440F, 1547J, 1549J, 1868, 2205, 2206, 6145 and two 15444
6142	—	Roller Presser complete, $\frac{3}{8}$ in. fine roller, Nos. 176J, 440F, 1547J, 1549J, 1841, 2205, 2206, 6145 and two 15444.....
6143	378	Roller Presser complete, $1\frac{1}{4}$ in. coarse roller, Nos. 176J, 440F, 1547J, 1549J, 1839, 2205, 4282, 6146 and two 15444
6144	—	Roller Presser complete, $1\frac{1}{4}$ in. fine roller, Nos. 176J, 440F, 1547J, 1549J, 1869, 2205, 4282, 6146 and two 15444.....
6145	378	Roller Arm for 6141 and 6142.....
6146	378	" " " 6143 and 6144.....
6147	370	Shuttle Driver and Feed Lifting Cam for 17-6, 17-10, 17-13 and 17-14 Machines
6148	366	Shuttle Race Ring 6168 with 6153 and two 590E, for 6149.....
6149	—	Shuttle Race Ring complete for 17-6, 17-10, 17-13 and 17-14 Machines, Nos. 6148 and 6150.....
6150	366	Shuttle Race Ring Cover with 6151 and two 8505, for 6149.....

NO.	PLATE	NAME
6151	375	Shuttle Race Ring Cover Hinge for 6150.
6153	375	" " " Thread Protector for 6148.
6154	—	Throat Plate (small needle hole) for 6128 and 6275, obsolete.
6155	—	Throat Plate (small needle hole) for 6129 and 6276, obsolete.
6156	373	Feed Dog, 13 teeth (16 teeth to the inch) for cloth, for 6163 and 6173, for 17-6 Machine.
6157	373	Feed Dog, 12 teeth (16 teeth to the inch) for leather, for 6164 and 6174, for 17-6 Machine.
6158	370	Feed Forked Connection for 17-6, 17-13 and 17-14 Machines and obsolete for 17-10 Machine.
6159	3370	Feed Rock Shaft for 618, for 17-6, 17-10, 17-13 and 17-14 Machines, obsolete.
6160	366	Feed Rock Shaft for 304, for 17-6, 17-10, 17-13 and 17-14 Machines, obsolete.
6161	364	Feed Rod for 17-6, 17-10, 17-13 and 17-14 Machines.
6162	375	Feed Rod Lifting Block for 17-6, 17-10, 17-13 and 17-14 Machines, obsolete.
6163	373	Throat Plate, small needle hole, for 6156 and 6281.
6164	373	Throat Plate, small needle hole for 6157 and 6282.
*6165	—	Arm with 4448, 4449, 15404 and two 15405, for 17-6 Machine, obsolete.
6166	377	Feed Rock Shaft Arm Pin for 17-6, 17-13 and 17-14 Machines.
6166	377	Feed Regulator Crank Pin for 17-10 and 17-16 Machines, obsolete.
6167	366	Feed Rock Shaft Arm with 453c, for 6160, for 17-6, 17-10, 17-13 and 17-14 Machines, obsolete.
6168	—	Shuttle Race Ring for 6148.
*6169	—	Feed Regulator Lever Shaft Bracket for 6125 and obsolete for 16676, for 17-16 Machine.
6170	3357	Throat Plate, large needle hole, for 6128 and 6275, obsolete.
6171	3357	Throat Plate, large needle hole, for 6129 and 6276, obsolete.
6172	—	Throat Plate, large needle hole, for 6277 and 6283.

NO.	PLATE	NAME
6173	—	Throat Plate, large needle hole, for 6156 and 6281.
6174	—	Throat Plate, large needle hole, for 6157, and 6282.
6175	373	Throat Plate, large needle hole, for 6329
6176	—	" " small needle hole, for 6329
*6177	—	Cylinder, $2\frac{7}{8}$ in. diam., for 17-12 and 17-20 Machines, obsolete.
6178	3364	Arm Shaft for 3011, for 17-12, 17-20, 17-24 and 17-26 Machines.
6179	3364	Arm Shaft for 5977, for 17-12, 17-20, 17-24 and 17-26 Machines.
*6181	—	Cylinder, $2\frac{7}{8}$ in. diam., for 17-7 and 17-21 Machines.
6182	376	Feed Dog, 12 teeth (one row of teeth) for $\frac{1}{2}$ in. to $\frac{3}{4}$ in. gauges, for 65035, for 17-7 Machine, and for $\frac{1}{8}$ in. to $\frac{3}{4}$ in. gauges, for 17-21 Machine, for leather
6183	3353	Feed Dog, 12 teeth (two rows of teeth) for $\frac{3}{8}$ in. to $\frac{1}{4}$ in. gauges, for general work, for 6248, for 17-7 and 17-21 Machines.
6184	3353	Feed Dog, 12 teeth (three rows of teeth) for $\frac{1}{8}$ in. to $\frac{7}{16}$ in. gauges, for general work, for 6254, for 17-7 and 17-21 Machines.
6206	370	Shuttle Race complete, for $\frac{1}{2}$ in. to $\frac{3}{4}$ in. gauges, for 17-7 Machine, and for $\frac{1}{8}$ in. to $\frac{3}{4}$ in. gauges, for 17-21 Machine, Nos. 665J, 6225 and 16742.
6213	—	Shuttle Race complete, for $\frac{1}{2}$ in. to $\frac{3}{4}$ in. gauges, for 17-7 and 17-21 Machines, Nos. 665J, 6235 and 16742.
6223	376	Shuttle Race Lock Pin for 17-7 and 17-21 Machines.
6224	376	Shuttle Race Lock Pin Spring for 17-7 and 17-21 Machines.
6225	374	Shuttle Race Loop Separator, for $\frac{1}{2}$ in. to $\frac{3}{4}$ in. gauges, for 6206, for 17-7 Machine, and for $\frac{1}{8}$ in. to $\frac{3}{4}$ in. gauges, for 6206, for 17-21 Machine.
6235	374	Shuttle Race Loop Separator, for $\frac{1}{2}$ in. to $\frac{3}{4}$ in. gauges, for 6213.
6245	376	Throat Plate for 6182, obsolete.
6248	3353	" " " 6183.
6254	3353	" " " 6184.

NO.	PLATE	NAME
Nos. 6263 TO 6266 FOR 17-14 MACHINE		
6263	3357	Feed Dog, 12 teeth, obsolete.
6264	373	" " 13 teeth (16 teeth to the inch) for 6270 and 6299.
6265	—	Hemmer (foot) $\frac{1}{4}$ in. hem.
6266	373	" " $\frac{3}{8}$ in. hem.
6269	3357	Throat Plate, small needle hole, for 6263, obsolete.
6270	373	Throat Plate, small needle hole, for 6264
*6271	—	Arm with 4448, 4449, 15404 and two 15405, for 17-8, 17-9, 17-21 and 17-25 Machines, and obsolete for 17-20 Machine.
6272	371	Feed Dog, 12 teeth, for 6273 and 16622, for 17-8 Machine.
6273	371	Throat Plate, small needle hole, for 6272
6274	374	Vibrating Presser Foot for 17-9 Machine, obsolete.
Nos. 6275 TO 6283 FOR 17-10 MACHINE		
6275	3357	Feed Dog, 12 teeth (15 teeth to the inch) for cloth, obsolete.
6276	3357	Feed Dog, 12 teeth (15 teeth to the inch) for leather, obsolete.
6277	3357	Feed Dog, 11 teeth (15 teeth to the inch) two rows of teeth, obsolete.
6278	374	Presser Foot (long shank).
6279	374	" " (short shank).
6280	373	Throat Plate, small needle hole, for 6277 and 6283.
6281	376	Feed Dog, for cloth.
6282	376	" " " leather.
6283	373	" " (two rows of teeth).
*6284	—	Arm with 4448, 4449, 15404 and two 15405, for 17-11 Machine.
6285	375	Feed Dog, 12 teeth, for 6293, for 17-11 Machine.
Nos. 6287 TO 6293 FOR 17-11 MACHINE		
6287	375	Knife medium, end cut only.
6288	375	" " " " " (shearing).
6289	375	" " " " " and side cut.
6290	375	" " " " " (concave)
6291	375	" " " " " (thin gauge).

NO.	PLATE	NAME
6292	375	Knife, narrow, end and side cut.
6293	375	Throat Plate complete for 6285, Nos. 2328, 2330, 6295, 6296 and two each 1208d and 2332.
6295	375	Throat Plate Cutting Bar for 6293.
6296	375	" " Spring Slide Spring Stop for 6293.
6297	368	Shuttle Race Cover for 17-7 and 17-21 Machines.
6299	—	Throat Plate, large needle hole, for 6264
6300	3355	Feed Dog, (reversible) 13 teeth (21 teeth to the inch) for 16714, for 17-16 Machine.
*6301	—	Arm with 4448, 4449, 6305, 6314, 6315, 15404, two each 159E, 15405 and four 161E, for 17-12 Machine, obsolete.
6302	368	Arm Side Cover for 17-12 and 17-24 Machines.
6303	369	Feed Cam with two 446c, for 17-12 Machine.
6304	369	Feed Lever for 17-12 Machine, obsolete.
*6305	—	" " Bracket with two 620c, for 6301 and 16666.
6306	375	Feed Bar Connecting Link for 17-12 and 17-24 Machines.
6306	375	Feed (upper) Bar Connecting Link for 17-26 Machine.
6307	3367	Feed Lever Hinge Pin for 17-12 and 17-24 Machines.
6308	374	Feed Point for 17-12 and 17-24 Machines
Nos. 6309 TO 6315 FOR 17-12 MACHINE, OBSOLETE		
6309	369	Feed Regulator
6310	375	" " Slide Block.
6311	375	" " " " Spring.
6312	3383	" " " " Screw Stud Nut Washer.
6313	364	Feed Shaft.
*6314	—	" " Bracket (back) for 6301.
*6315	—	" " " (front) for 6301.
6316	369	" " Crank with 453c and 1813, for 17-12 and 17-24 Machines.
6317	374	Lifting Presser Foot for 17-12 and 17-24 Machines.
6318	374	Needle Plate for 17-12 Machine.
6319	369	Feed Bar for 16656.

NO.	PLATE	NAME
6320	3357	Throat Plate, large needle hole, for 6321 obsolete.....
6321	3357	Feed Dog, for 17-13 Machine, obsolete...
6322	373	Hemmer (foot) $\frac{1}{8}$ in. hem, for 17-13 Machine.....
6325	373	Hemmer (foot) $\frac{3}{16}$ in. hem, for 17-13 Machine.....
6328	—	Throat Plate, small needle hole, for 6321, obsolete.....
6329	373	Feed Dog, 13 teeth (16 teeth to the inch) for 6175 and 6176, for 17-13 Machine..
6330	—	Knee Lifter complete (power table or stand) for 17-1 to 17-6, 17-10, 17-13 to 17-19, 17-22, 17-23, 17-27, 17-29 and 17-30 Machines, Nos. 802d, 5608, 6333, 6339, 7170 and 16659.....
6331	—	Knee Lifter complete (power table or stand) for 17-8 and 17-9 Machines, Nos. 202e, 802d, 5610, 6333, 6339, 7170 and 16659, obsolete.....
6332	—	Knee Lifter complete (power table or stand) for 17-11 Machine, Nos. 802d, 5612, 6333, 6339, 7170 and 16659.....
6333	380	Pitman for 6330 to 6332, 6445, 16653, 16804 and 16805.....
6334	380	Rock Shaft Hanger with two wood screws 1 in. No. 10, for 6339.....
6335	380	Knee Lifter Rock Shaft Knee Arm for 6336, obsolete.....
6336	380	Knee Lifter Rock Shaft Knee Arm complete for 6339, Nos. 2766, 2767 and 6335, obsolete.....
6337	380	Rock Shaft Lifting Bracket with two 356c, for 6339.....
6338	380	Rock Shaft Lifting Bracket Hook for 6339.....
6339	380	Rock Shaft complete, for 6330 to 6332, 6445, 16605, 16645, 16653, 16804 and 16805, Nos. 2763, 2770, 6337, 6338, 16647 and two 6334.....
6343	380	Pitman for 16645.....
6344	—	Foot Lifter complete for 17-1 to 17-6, 17-10, 17-13 to 17-19, 17-22, 17-23, 17-27 17-29 and 17-30 Machines, Nos. 802d, 4885, 5608, 6439, 7170 and 16659.....

NO.	PLATE	NAME
6345	—	Foot Lifter complete for 17-8 and 17-9 Machines, Nos. 202e, 802d, 4885, 5610, 6439, 7170 and 16659, obsolete..
6346	—	Foot Lifter complete for 17-11 Machine, Nos. 802d, 4885, 5612, 6439, 7170 and 16659.....
6348	—	Lifting Lever (old style) obsolete.....
Nos. 6434 TO 6438 FOR 17-18 MACHINES		
*6434	—	Cylinder, 2 $\frac{7}{8}$ in. diam., for 6438, obsolete
6435	376	Feed Dog, 12 teeth, obsolete.....
6436	370	Oil Cup with 1111E and three 6437.....
6437	3383	" " Thread Eyelet for 6436.....
6438	376	Throat Plate for 6435, obsolete.....
6439	—	Chain, 36 in. to 45 in., with 56864 and 56865, for 6344 to 6346, 6446, 16654 and 16801 to 16803.....
6440	371	Guide (roller) Nos. 1852 and 6441, for 17-15 to 17-17 and 17-30 Machines.....
6441	371	Guide Bracket for 6440.....
6442	375	Knife (wide) end and side cut, for 17-11 Machine.....
6443	384	Lifting Lever with 448c, for 6445, obsolete
6444	385	" " Pin for 6445, obsolete.....
6445	—	Knee Lifter complete (power table or stand) for 17-12 Machine, Nos. 202e, 802d, 5610, 6333, 6339, 6443, 6444 and 16659, obsolete.....
6446	—	Foot Lifter complete for 17-12 Machine, Nos. 202e, 802d, 4885, 4896, 5610, 6439, 16641 and 16659, obsolete.....
6449	—	Throat Plate, small needle hole, for 6112..
6450	382	Thread Take-up Cam 65003 with 446c, for 17-12, 17-20, 17-24 and 17-26 Machines.....
6462	3366	Oscillating Shaft for 17-28 Machine and obsolete for 17-22 Machine.....
*6520	—	Oscillating Shaft Crank with 1813, for 6532.....
6532	377	Oscillating Shaft Crank 6520 with two 462c, for 17-7 and 17-21 Machines....
6808	368	Feed Regulator Lever with 207f, for 6809
6809	—	Feed Regulator Lever complete for 17-10, 17-16 and 17-30 Machines, Nos. 190j, 6808 and 6810.....
6810	368	Feed Regulator Lever Friction Plate for 6809.....

240 NUMERICAL LIST OF PARTS

NO.	PLATE	NAME
6811	368	Feed Regulator Lever Segment for 17-10 Machine and obsolete for 17-16 Machine.....
6909	389	Shuttle (closed eye) complete, for 17-19 Machine, Nos. 2076, 2210, 3383 and 17418.....
*6945	—	Shuttle Cover for 17418.....
7044	3366	Oscillating Shaft for 17-7, 17-19 and 17-21 Machines.....
7054	3380	Oscillating Shaft Crank 7225 with two 462c, for 17-28 Machine.....
7060	3365	Needle Bar for 17-26 Machine.....
7071	3363	Binder Folder Screw Washer for 28821....
7169	384	Machine Base with four each 6055, 51070E and wood screws 1 in. No. 12....
7170	380	Lifting Lever for 6330 to 6332, 6344 to 6346, 16801 and 16804.....
7177	377	Shuttle Race Ring Cover Spring for 17-6, 17-10, 17-13 and 17-14 Machines.....
*7225	—	Oscillating Shaft Crank with 1813, for 7054.....
7299	3365	Presser Bar for 17-7 Machine.....
7524	3383	Needle Clamp with 196F, 651L and 7525, for 17-1, 17-5, 17-6, 17-9, 17-10, 17-13 to 17-18, 17-23 and 17-27 Machines....
7525	3383	Needle Clamp Thread Guide for 7524....
7556	3372	Roller Arm Lock Spring for 4790.....
8068	20884	Thread Lubricator Oil Reservoir Rivet Washer (inside) for 65091.....
8505	3383	Shuttle Race Ring Cover Hinge Rivet for 6150.....
8879	3383	Arm Spool Pin Washer (cloth) obsolete....
8908	20885	Wrench for 1520 (Accessories).....
9804	297	Knife Bar Lifting Spring for 17-11 Machine.....
10141	3383	Bobbin Winder Tension Spring for 27308
10148	3380	Tension Spring for 16882.....
10160	3383	Needle Stop Pin for 16642.....
11241	382	Arm Spool Bracket Spool Pin Washer (cloth) for 17-7 and 17-21 Machines....
11241	382	Arm Spool Pin Washer (cloth) for 17-1 to 17-6, 17-8 to 17-20 and 17-22 to 17-30 Machines.....
11241	1703	Bobbin Winder Spool Washer for 27308..
12296	3379	Face Plate Thread Guard (upper) for 16883.....

NUMERICAL LIST OF PARTS 241

NO.	PLATE	NAME
12403	377	Arm Spool Bracket Spool Pin and Thread Eyelet for 15063.....
12403	377	Arm Spool Pin and Thread Eyelet for 17-1 to 17-6, 17-8 to 17-20 and 17-22 to 17-30 Machines.....
12416	3375	Lifting Lever Connecting Rod Joint for 16605, obsolete.....
13112	—	Needle Clamp Body for 4803, obsolete....
13211	3375	Tape Holder Tension Adjusting Spring for 35827.....
14647	3367	Feed Regulator Crank with two 448c, for 17-10 Machine.....
Nos. 15007 TO 15010 FOR 17-1 MACHINE, OBSOLETE		
15007	221	Thread Take-up Spring 2119 for 413.....
15008	221	“ “ “ 2121 with offset, for 413.....
15009	221	Thread Take-up Spring 2122 with offset, enclosed eyelet, for 413.....
15010	221	Thread Take-up Spring 2123 for 600.....
15027	386	Shuttle Bobbin Case Position Finger for 15277.....
15063	366	Arm Spool Bracket 2415 with two 12403, for 17-7 and 17-21 Machines.....
15072	3383	Bobbin Winder Bobbin Position Pin for 2462, 27538 and 27610.....
15140	386	Shuttle Bobbin Case Latch for 15141....
15141	—	“ “ “ Hinge, Nos. 2973, 2974 and 15140, for 15277 and 40112....
15277	386	Shuttle Bobbin Case complete for 16613, Nos. 591F, 592E, 2523, 2975, 15027, 15141, 15278 and 62739.....
15278	386	Shuttle Tension Spring for 15277 and 40112.....
*15404	—	Trade Mark for 6001, 6060, 6125, 6165, 6271, 6284, 6301, 16666, 16676, 16687, 16716, 16775, 16782, 65021 and 65022..
15405	20883	Trade Mark Rivet for 6001, 6060, 6125, 6165, 6271, 6284, 6301, 16666, 16676, 16687, 16716, 16775, 16782, 65021 and 65022.....
15444	—	Roller Arm Bracket Screw Center 316F with 1547J, for 2196, 2197, 2309, 2310, 4790, 6070, 6071, 6141 to 6144, 16099, 16100, 16623, 16624, 16755, 65030, 65041, 65046, 65047, 65051, 65086 and 65099..

NO.	PLATE	NAME
*15458	—	Shuttle Cover for 125017.....
15472	3389	Needle Bar Connecting Stud with 155c, for 56764 and 56847.....
16098	3371	Roller Arm for 16099, 16100, 16755 and 65046.....
16099	3371	Roller Presser complete, 1¼ in. coarse roller, for 17-1 and 17-11 Machines, Nos. 176j, 440f, 1547j, 1549j, 1839, 2205, 4282, 16098 and two 15444....
16100	—	Roller Presser complete, 1¼ in. fine roller, for 17-1 and 17-11 Machines, Nos. 176j, 440f, 1547j, 1549j, 1869, 2205, 4282, 16098 and two 15444.....
16202	—	Tension Screw Stud 600c with 1560c, for 16882 and 56791.....
16230	20882	Roller Arm for 65041, 65047 and 65086...
16232	20882	" Ball for 51850, 51852, 51861 and 51893.....
16242	20880	Cylinder End Cover Latch for 16663.....
16242	20880	Shuttle Race Cover Latch for 16689.....
16242	20880	" " Ring Cover Latch for 16689, 16772 and 16779.....
16601	388	Shuttle Race Ring for 16602.....
16602	—	" " " 16601 with 65059 and two 337j, for 17-11 Machine.....
16603	—	Throat Plate, small needle hole, for 6011
16604	384	Knee Lifter Pitman, length 13¾ in., for 16605, obsolete.....
16605	—	Knee Lifter complete (power table or stand) for 17-8 and 17-9 Machines, Nos. 76b, 802b, 1521e, 4724 to 4727, 6339, 12416, 16604 and 16659, obsolete
*16606	—	Cylinder, 1¼ in. diam., for 16811, for 17-22, 17-23, 17-25 and 17-27 Machines, obsolete.....
16607	3350	Feed Dog, 10 teeth, for 16617, for 17-22 Machine.....
16608	388	Feed Dog Carrier for 17-22, 17-23 and 17-25 Machines.....
16610	382	Feed Rock Shaft for 17-22, 17-23 and 17-25 Machines.....
16611	388	Feed Rock Shaft Crank for 17-22, 17-23 and 17-25 Machines.....
16613	386	Shuttle, 1½ in. diam., Nos. 2996, 15277 and 16614, for 17-22, 17-23, 17-25 and 17-27 Machines.....
16614	386	Shuttle Body for 16613 and 16735.....

NO.	PLATE	NAME
16615	386	Shuttle Driver for 17-27 Machine, obsolete
16615	386	" " and Feed Lifting Cam for 17-22, 17-23 and 17-25 Machines.....
16617	3350	Throat Plate for 16607.....
16618	3350	Feed Dog, 10 teeth, for 16619 and 65029, for 17-23 Machine.....
16619	3350	Throat Plate for 16618.....
16620	384	Cloth Plate, 6 in. long, for 17-6, 17-10, 17-13 and 17-14 Machines, obsolete....
16621	385	Vibrating Presser Foot for 17-9 Machine..
16622	—	Throat Plate, large needle hole, for 6272..
16623	385	Roller Presser complete, 1¼ in. coarse roller, for 17-2 Machine, Nos. 176j, 440f, 1547j, 1549j, 1839, 2205, 6073, 16625 and two 15444.....
16624	—	Roller Presser complete, 1¼ in. fine roller, for 17-2 Machine, Nos. 176j, 440f, 1547j, 1549j, 1869, 2205, 6073, 16625 and two 15444.....
16625	385	Roller Arm for 16623, 16624, 65030 and 65051.....
16626	3350	Feed Dog, 10 teeth, one row of teeth at right and two teeth back of needle, for 16627, for 17-22 Machine.....
16627	3350	Throat Plate for 16626.....
16628	3351	Feed Dog, 10 teeth, two rows of teeth, for 16629, for 17-22 and 17-25 Machines..
16629	3351	Throat Plate for 16628.....
16630	3351	Feed Dog, 10 teeth, one row of teeth at left and two teeth back of needle, for 17-23 Machine, obsolete.....
16631	3351	Throat Plate for 16630, obsolete.....
16632	3352	Feed Dog, 13 teeth (21 teeth to the inch) conical teeth, for 17-16 Machine, ob- solete.....
16633	3352	Throat Plate for 16632, obsolete.....
16634	387	Shuttle Race Ring for 17-15 Machine, obsolete.....
16635	3356	Feed Dog, 10 teeth (16 teeth to the inch) for 17-17 Machine, obsolete.....
16636	3356	Throat Plate for 16635, obsolete.....
16637	3374	Presser Foot for 16635, for 17-17 Machine, obsolete.....
16638	382	Feed Forked Connection for 17-8, 17-15, 17-17 to 17-19, 17-22, 17-23 and 17-25 Machines.....

NO.	PLATE	NAME
16639	385	Feed Rod Spring for 17-6, 17-10, 17-13 and 17-14 Machines.....
16640	385	Shuttle Driver for 17-3, 17-4 and 17-9 Machines.....
16641	384	Lifting Lever with 448c, for 6446, 16645 and 16802.....

Nos. 16642 TO 16644 FOR 17-2 TO 17-4, 17-19 AND 17-22 MACHINES

16642	382	Needle Bar with 10160.....
16643	385	" " Thread Guard.....
16644	385	" Clamp with 1112F.....
16645	—	Knee Lifter complete (power table or stand) for 17-12, 17-24 and 17-26 Machines, Nos. 1064d, 4725, 4726, 4896, 6339, 6343, 16641 and 16659.....
16646	380	Rock Shaft Knee Arm for 16647.....
16647	—	Rock Shaft Knee Arm complete for 6339, Nos. 2766, 2767 and 16646.....
16648	384	Lifting Lever with 448c, for 16653, 16654 16803 and 16805.....

Nos. 16649 TO 16652 FOR 17-8 MACHINE

*16649	—	Cylinder, 2 1/8 in. diam.,.....
16650	3351	Feed Dog for 16652 and 16655, obsolete..
16651	387	Shuttle Race.....
16652	3351	Throat Plate, large needle hole, for 16650, obsolete.....
16653	—	Knee Lifter complete (power table or stand) for 17-8, 17-9, 17-20 and 17-25 Machines, Nos. 802b, 4725 to 4727, 6333, 6339, 16648 and 16659.....
16654	—	Foot Lifter complete for 17-8, 17-9, 17-20 and 17-25 Machines, Nos. 802b, 4725 to 4727, 4885, 6439, 16648 and 16659.....
16655	—	Throat Plate, small needle hole, for 16650, obsolete.....
16656	—	Guide Bar complete for 17-12 and 17-24 Machines, Nos. 810b, 810e, 4897, 6319 and 56868.....
16657	383	Cloth Plate for 16658.....
16658	—	Cloth Plate with Bracket complete for 17-22, 17-23 and 17-25 Machines, Nos. 16657, 16686 and two 389F.....
16659	384	Lifting Lever Spring for 6330 to 6332, 6344 to 6346, 6445, 6446, 16605, 16645, 16653, 16654 and 16801 to 16805.....

NO.	PLATE	NAME
Nos. 16660 TO 16664 FOR 17-19 MACHINE		
*16660	—	Cylinder, 2 1/8 in. diam., obsolete.....
16661	3352	Feed Dog, 10 teeth, for leather, obsolete..
16662	389	Shuttle Driver and Feed Lifting Cam....
16663	389	Cylinder End Cover 16776 with 16242 and two 240J.....
16664	3352	Throat Plate for 16661, obsolete.....
*16666	—	Arm with 159J, 180J, 4448, 4449, 4891, 4892, 6305, 15404, two 15405 and four 129J, for 17-12 and 17-24 Machines....
*16667	—	Cylinder, 2 1/8 in. diam., for 17-24 Machine
16668	3361	Needle Plate for 16669, obsolete.....
16669	3361	Shuttle Race Ring complete for 17-24 Machine, Nos. 16668, 16670, 16777 and four 220J, obsolete.....
16670	3361	Shuttle Race Ring Cap for 16669 and 65011.....
16671	3361	Shuttle Race Ring Cover for 17-24 Machine, obsolete.....
16672	3352	Feed Dog, 12 teeth (16 teeth to the inch) for cloth, for 17-19 Machine, obsolete..
16673	3352	Throat Plate for 16672, obsolete.....
16674	3355	Feed Dog, 10 teeth, for 16675, for 17-25 Machine.....
16675	3355	Throat Plate for 16674.....
*16676	—	Arm with 4448, 4449, 6169, 15404 and two each 145E and 15405, for 17-16 Machine, obsolete.....
16677	388	Feed Dog Carrier for 17-15 to 17-17 and 17-30 Machines.....
16678	3368	Feed Forked Connection for 17-16 and 17-30 Machines.....
*16679	—	Oscillating Shaft Crank with 1813, for 16680, obsolete.....
16680	3375	Oscillating Shaft Crank 16679 with two 462c, for 6462, for 17-22 Machine, obsolete.....
16681	3366	Oscillating Shaft for 17-22, 17-23, 17-25 and 17-27 Machines.....
*16682	—	Oscillating Shaft Crank with 1813, for 16683.....
16683	386	Oscillating Shaft Crank 16682 with two 462c, for 17-22, 17-23, 17-25 and 17-27 Machines.....
16684	3355	Feed Dog (incline feed) 10 teeth (16 teeth to the inch) for 16714, for 17-15 Machine.....

NO.	PLATE	NAME
16685	3356	Throat Plate for 6013 and 16684, obsolete
16686	383	Cloth Plate Bracket with 345c, for 16658
*16687	—	Arm with 4448, 4449, 15404 and two 15405, for 17-16 and 17-30 Machines.....
16688	—	Shuttle Race Cover for 16689.....
16688	—	“ “ Ring Cover for 16689.....
16689	382	“ “ Cover 16688 with 16242 and two 725j, for 17-8 Machine.....
16689	382	Shuttle Race Ring Cover 16688 with 16242 and two 725j, for 17-1, 17-2, 17-11, 17-15 to 17-18, 17-26 and 17-29 Machines.....
16690	—	Throat Plate Holder 6049 with 16714, for 17-15 and 17-16 Machines.....
16691	3374	Presser Foot, $\frac{1}{2}$ in. tread, for 17-16 Machine.....
16692	3374	Presser Foot, $\frac{3}{8}$ in. tread, for 17-16 Machine.....
16693	383	Cloth Plate for 16696, obsolete.....
16694	383	“ “ Bracket with 345c, for 16697, obsolete.....
16695	383	Cloth Plate Slide for 16696 and 16720....
Nos. 16696 to 16699 FOR 17-27 MACHINE, OBSOLETE		
16696	383	Cloth Plate complete for 16697, Nos. 3286, 16693, 16695 and two 725j.....
16697	—	Cloth Plate with Bracket complete, Nos. 16694, 16696 and two 389f.....
16698	3378	Needle Plate with 16699 and two 2532 . . .
16699	3378	“ “ Thread Guard for 16698.....
Nos. 16700 to 16709 FOR 16710, OBSOLETE		
16700	3377	Presser Foot.....
16701	3377	“ “ Body.....
16702	3377	“ “ Bracket with 196f.....
16703	3377	“ “ Cap Screw Washer.....
16704	3377	“ “ Driving Arm.....
16705	3377	“ “ “ Spring.....
16706	3377	“ “ Guide.....
16707	3377	“ “ Lifting Lever with 196f.....
16708	3377	“ “ Shaft and Arm (solid).....
16709	3377	“ “ Spring.....
16710	3377	Presser Foot (spring) complete for 17-27 Machine, Nos. 87f, 190j, 208j, 1116j and 16700 to 16709, obsolete.....

NO.	PLATE	NAME
16711	3378	Shuttle Race for 17-27 Machine, obsolete.
16712	3378	“ “ Cover for 17-27 Machine, obsolete.....
16713	3365	Feed Regulator Lever Segment for 17-16 Machine.....
16714	3355	Throat Plate for 6300 and for 5 millimeter stitch, for 6013 and 16684, for 16690..
16715	3374	Presser Foot for 16628, for 17-22 Machine
Nos. 16716 to 16740 FOR 17-28 MACHINE		
*16716	—	Arm with 4448, 15404 16717 and two 15405.....
*16717	—	Arm Shaft Bushing (front) for 16716.....
16718	383	Cloth Plate for 16720.....
16719	383	“ “ Bracket with 345c, for 16721
16720	383	Cloth Plate complete for 16721, Nos. 3286, 16695, 16718 and two 725j.....
16721	—	Cloth Plate with Bracket complete, Nos. 16719, 16720 and two 389f.....
*16722	—	Cylinder, $1\frac{1}{8}$ in. diam., for 16737, obsolete.....
16723	3364	Face Plate for 16881.....
16724	3365	Needle Bar.....
16725	3379	“ “ Thread Eyelet.....
16726	3379	“ “ Plate, large needle hole.....
16727	—	“ “ small needle hole.....
16728	3365	Presser Bar.....
16729	3379	“ “ Guide Bracket with 50022c..
16730	3379	“ “ Lifting Rock Shaft.....
16731	3379	“ “ “ “ “ “ Arm with 172c and 1979.....
16732	3379	Presser Bar Lifting Rock Shaft Arm Spring.....
16733	3379	Presser Bar Lifting Rock Shaft Link.....
16734	3379	“ “ Foot, obsolete.....
16735	3380	Shuttle, $1\frac{1}{2}$ in. diam., Nos. 2996, 16614 and 40112.....
16736	3380	Shuttle Driver.....
16737	3380	“ Race for 50037, for 16722, obsolete
16738	3380	“ “ Cover.....
16739	3369	Thread Take-up Cam 65018 with 446c, obsolete.....
*16740	3366	Thread Take-up Lever with 1819, for 65034.....
16742	—	Shuttle Race Body (two pieces) for 629d, for 6206 and 6213.....

NO.	PLATE	NAME
Nos. 16743 to 16760 for 17-29 MACHINE		
*16743	—	Cylinder, $2\frac{7}{16}$ in. diam., for 16756, obsolete
16744	3382	Feed Dog, 12 teeth (16 teeth to the inch) for 65033.....
16745	3366	Feed Rock Shaft.....
16746	3381	Knife Driving Lever for 16747, obsolete
16747	—	Knife Driving Lever complete for 17-29 Machine, Nos. 104b, 16746, 16749, 24173 and 24177, obsolete.....
16748	3381	Knife Driving Lever Cam with two 465c.
16749	3381	" " " Fork for 16747 and 65064.....
16750	3382	Knife Driving Lever Fork Cover.....
16751	3382	" " " Plate for 65066.....
16752	3382	" " " Holder.....
16753	3381	" Holder Position Spring for 65066....
16754	3366	Oscillating Shaft.....
16755	3371	Roller Presser complete, $1\frac{1}{4}$ in. coarse roller, Nos. 176j, 440f, 1547j, 1549j, 1987, 2205, 4282, 16098 and two 15444.
16756	—	Shuttle Race Ring for 16757.....
16757	3369	" " " 16756 with 65059 and two 767j.....
16759	3382	Throat Plate with 16760 and two 238d, for 401, for 16744 and 16846, obsolete
16760	3382	Throat Plate Needle Hole Strip, small needle hole, for 16759.....
16762	3353	Feed Dog, 12 teeth (four rows of teeth) for $\frac{1}{2}$ in. to $\frac{5}{8}$ in. gauges, for general work, for 16763, for 17-7 and 17-21 Machines.....
16763	3353	Throat Plate for 16762.....
16764	3354	Feed Dog, 12 teeth (five rows of teeth) for $\frac{3}{4}$ in. to $\frac{3}{4}$ in. gauges, for general work, for 16765, for 17-7 and 17-21 Machines
16765	3354	Throat Plate for 16764.....
16766	3380	Thread Take-up Spring for 16882.....
16767	382	Feed Rock Shaft Arm with 453c, for 17-6, 17-10, 17-13 and 17-14 Machines.....
16768	365	Cloth Plate for 6082.....
16769	—	Shuttle Race Ring for 6118.....
16770	3368	Feed Forked Connection for 17-10 Machine.....

NO.	PLATE	NAME
16771	—	Shuttle Race Ring Cover for 16772..
16772	382	" " " " 16771 with 16242 and two 240j, for 17-5, 17-12 and 17-20 Machines.....
*16773	—	Cylinder, $2\frac{1}{8}$ in. diam., for 17-12 Machine
16774	3374	Presser Foot for 17-14 Machine.....
*16775	—	Arm with 4448, 4449, 15404 and two 15405, for 17-18 Machine.....
16776	—	Cylinder End Cover for 16663.....
16777	3393	Shuttle Race Ring for 16669 and 65011
16778	—	" " " Cover for 16779...
16779	3369	" " " " 16778 with 16242 and two 240j, for 17-24 Machine
16780	3365	Vibrating Presser Bar for 16781.....
16781	—	Guide Bar complete for 17-25 Machine, Nos. 810b, 810e, 4723, 4897, 16780, 56844 and three 404j.....
Nos. 16782 to 16798 for 17-26 MACHINE		
*16782	—	Arm with 4448, 4449, 4891, 4892, 15404, two 15405 and four 129e.....
16783	3365	Arm Side Cover.....
*16784	—	Cylinder, $2\frac{1}{8}$ in. diam.....
16785	3309	Feed (lower and upper) Cam with 446c...
16786	3355	" (lower) Dog, 11 teeth, for 16798....
16787	3368	" " Forked Connection.....
16788	3367	" " Rock Shaft Crank.....
16789	3365	" (upper) Bar for 16794.....
16790	3368	" " Lever.....
16791	3368	" " " Bracket.....
16792	3367	" " " Slide Block.....
16793	3374	Feeding Foot.....
16794	—	Guide Bar complete, Nos. 810b, 810e, 4723, 4897, 16789, 56752 and three 404j
16795	3374	Lifting Presser Foot.....
16796	—	Shuttle Race Ring for 16797.....
16797	3369	" " " 16796 with 65059 and two 337j.....
16798	3355	Throat Plate for 16786.....
16799	3369	Bobbin Winder Frame for 16900.....
16800	3369	Bobbin Winder (tight or loose wheel) complete for 17-5, 17-12, 17-18, 17-20, 17-24 and 17-26 Machines, Nos. 46b, 2460, 2464, 16862 and 16900.....
16801	—	Foot Lifter complete for 17-7 Machine, Nos. 802b, 4885, 5611, 6439, 7170 and 16659.....

NO.	PLATE	NAME
16802	—	Foot Lifter complete for 17-12, 17-24 and 17-26 Machines, Nos. 1064b, 4725, 4726, 4885, 4896, 6439, 16641 and 16659
16803	—	Foot Lifter complete for 17-21 Machine, Nos. 802D, 4668, 4726, 4727, 4885, 6439, 16648 and 16659.....
16804	—	Knee Lifter complete (power table or stand) for 17-7 Machine, Nos. 802D, 5611, 6333, 6339, 7170 and 16659.....
16805	—	Knee Lifter complete (power table or stand) for 17-21 Machine, Nos. 802D, 4668, 4726, 4727, 6333, 6339, 16648 and 16659.....
16806	—	Oscillating Rock Shaft complete, Nos. 6022 and 56812.....
16809	—	Shuttle Race Body for 16811, obsolete....
16810	3389	“ “ Cap for 16811, obsolete....
16811	—	Shuttle Race complete for 17-22, 17-23 and 17-25 Machines, Nos. 16809, 16810 and two 1053j, obsolete.....
*16812	—	Cylinder, 2 $\frac{1}{8}$ in. diam., for 17-29 Machine
16813	3389	Needle Clamp with 196r, for 16814.....
16814	—	Needle Clamp complete, for 17-29 Machine, Nos. 665j, 16813 and 16815.....
16815	3389	Needle Clamp Thread Guide for 16814....
16816	3393	Shuttle Race for 17-29 Machine.....
16824	—	Presser Foot Plate for 16826.....
16825	—	“ “ Shank for 16826.....
16826	3389	Presser Foot (hinged) complete for 17-16 Machine, Nos. 16824, 16825 and 26276
*16837	—	Cylinder, 1 $\frac{1}{8}$ in. diam., for 17-28 Machine
16838	3393	Shuttle Race for 17-28 Machine.....
*16839	—	Cylinder, 1 $\frac{1}{8}$ in. diam., for 17-22, 17-23 and 17-25 Machines.....
*16842	—	Cylinder, 2 $\frac{1}{8}$ in. diam., for 17-18 Machine
16843	3390	Feed Dog, 12 teeth, for 16844, for 17-18 Machine.....
16844	3390	Throat Plate for 16843, for 16842.....
16846	3390	Feed Dog, 17 teeth (24 teeth to the inch) for 65033, for 17-29 Machine.....
*16848	—	Throat Plate Holder Packing (back) for 6046.....
*16849	—	Throat Plate Holder Packing (front) for 6046.....
*16850	—	Throat Plate Holder Packing (back) for 6049.....

NO.	PLATE	NAME
*16851	—	Throat Plate Holder Packing (front) for 6049.....
16852	—	Throat Plate Holder Packing Rivet for 6046 and 6049.....
*16853	—	Cylinder, 2 $\frac{1}{8}$ in. diam., for 17-19 Machine.....
16854	3390	Feed Dog, 12 teeth, for cloth, for 16855, for 17-19 Machine.....
16855	3390	Throat Plate for 16854.....
16856	3390	Feed Dog, 10 teeth, for leather, for 16857, for 17-19 Machine.....
16857	3390	Throat Plate for 16856.....
16862	3389	Bobbin Winder Bracket for 16800.....
Nos. 16863 TO 16870 FOR 17-30 MACHINE		
*16863	—	Cylinder, 2 $\frac{1}{8}$ in. diam.....
16864	—	Feed Dog, 5 teeth (21 teeth to the inch) for 16878, obsolete.....
16865	3392	Feed Regulator Lever Segment.....
16866	3395	Presser Foot.....
*16867	—	Shuttle Body with 398E, 2082, 2084, 2211 and two 2212, for 16869.....
*16868	—	Shuttle Cover for 16869.....
16869	3395	Shuttle (high point) complete, Nos. 112E, 466H, 2073, 2076, 2078, 2080, 2086, 2090, 16867 and 16868.....
16870	3395	Shuttle Driver and Feed Lifting Cam....
16871	3396	“ Race Body for 16877 and 16896, obsolete.....
16872	—	Shuttle Race Ring for 16877, obsolete....
Nos. 16873 TO 16875 FOR 16877, 16896 AND 65080		
16873	3396	Shuttle Race Ring Cover.....
16874	3396	“ “ “ “ Bracket.....
16875	3396	“ “ “ “ Hinge Pin.....
16876	3396	“ “ “ “ Spring for 17-30 Machine.....
16877	—	Shuttle Race complete for 16878, Nos. 16871 to 16875 and two each 330r and 399r, obsolete.....
16878	—	Throat Plate for 16864, for 16880, obsolete
16879	3395	“ “ Holder for 16880, 16898 and 65085.....
16880	—	Throat Plate Holder 16879 with 16878, for 17-30 Machine, obsolete.....
16881	—	Face Plate 16723 with 2105, for 16883....
16882	—	Tension complete for 16883, Nos. 10148, 16202, 16766 and two 2102.....

NO.	PLATE	NAME
16883	---	Face Plate complete for 17-28 Machine, Nos. 448c, 460c, 2107, 2127, 12296, 16881, 16882 and two 233j.....
16884	3389	Feed Rod Lifting Block for 17-6, 17-10, 17-13 and 17-14 Machines.....
16885	---	Shuttle Race Ring for 16886.....
16886	3391	" " " 16885 with 65059 and two 337j, for 17-18 Machine.....
16892	20880	Shuttle (high point) complete for 17-1 to 17-6, 17-8 to 17-18, 17-20, 17-24, 17-26 and 17-29 Machines, Nos. 2073, 2076, 6058 and 125017.....
16894	3395	Feed Dog, 5 teeth (22 teeth to the inch) for 16897, for 17-30 Machine, obsolete.....
16895	3396	Shuttle Race Ring for 16896, obsolete....
16896	---	Shuttle Race complete for 17-30 Machine, Nos. 16871, 16873 to 16875, 16895 and two each 330j and 399f, obsolete.....
16897	3395	Throat Plate for 16894, for 16898, obsolete.....
16898	---	" " Holder 16879 with 16897, for 17-30 Machine, obsolete.....
16906	---	Bobbin Winder for 16800, Nos. 2463 and 16799.....
17418	---	Shuttle Cover 6945 with 112e, 466n, 2080, 3238, 3241 and 3242, for 6909.....
17822	20884	Thread Lubricator Oil Reservoir Rivet for 65091.....
19079	20885	Wrench for 1678 (Accessories).....
21202	20884	Thread Lubricator Bracket Screw Friction Washer for 65092.....
22431	20880	Shuttle Race Cover Hinge Screw Washer for 65094.....
24170	3381	Knife Driving Lever Center Plate for 65066.....
24171	3381	Knife Driving Lever Center Plate Cap for 65066.....
24173	3381	Knife Driving Lever Fork Swivel for 16747 and 65064.....
24174	3381	Knife Holder for 24587.....
24175	3381	" " Bushing for 65066.....
24177	3381	" " Position Stud for 16747 and 65065.....
24188	---	Knife Holder Regulator for 65066, Nos. 886c and 1098c.....
24586	3381	Knife without Guide (corner bent up) for undertrimming, for 24587.....

NO.	PLATE	NAME
24587	---	Knife without Guide (corner bent up) and Holder (sectional) complete, for undertrimming, for 65066, Nos. 24174, 24586 and two 602f.....
25888	373	Hemmer Tongue for 17-13 and 17-14 Machines.....
25916	373	Hemmer Folder for 17-13 Machine.....
26026	20885	Screw Driver, machine (Accessories).....
26276	3389	Presser Foot Hinge Pin for 16826.....
26485	20885	Screw Driver, shuttle tension (Accessories).....
26589	3362	Guide for 17-8 Machine.....
26823	3363	Binder on Shank, for bicycle saddles, for 17-1 Machine.....
26918	1518	Tape Holder Tape Guide for 35822.....
27302	1703	Bobbin Winder Frame for 27646, 27647 and 27656.....
27303	3383	Bobbin Winder Frame Spring for 27646, 27647 and 27656.....
27305	1703	Bobbin Winder Spindle for 27646.....
27306	1703	" " Spool Pin for 27308.....
27307	1703	" " " Stand for 27308....
27308	1703	Bobbin Winder Spool Stand complete for 27543, 27544 and 27612, Nos. 418e, 1562z, 2106, 10141, 11241, 27306, 27307 and two each 2455 and wood screws 1 in. No. 10.....
27309	1703	Bobbin Winder Stop Latch for 27646.....
27312	2445	" " " " 27647 and 27656.....
27323	1105	Knife Grinder Knife Holder Guide Bar for 60583.....
27538	2445	Bobbin Winder Spindle 27819 with 15072, 27850 and 41828, for 27647.....
27540	1703	Bobbin Winder Base for 27646, 27647 and 27656.....
27541	1703	Bobbin Winder Pulley for 27646, 27647 and 27656.....
27543	---	Bobbin Winder (swinging automatic, right hand) complete for 2073 and 2210, Nos. 27308 and 27647.....
27544	---	Bobbin Winder (swinging automatic, right hand) complete for 2996, Nos. 27308 and 27647.....
27564	1104	Knife Grinder Frame with 27574, for 60583.....
27565	1104	Knife Grinder Emery Wheel, 2 in. diam., for 60934.....

NO.	PLATE	NAME
27567	1105	Knife Grinder Emery Wheel Shaft for 60934.....
27568	1105	Knife Grinder Emery Wheel Shaft Oil Hole Cover (rubber) for 60583.....
27569	1105	Knife Grinder Emery Wheel Shaft Pulley for 60934.....
27572	1104	Knife Grinder Knife Holder Guide Bar Bracket with 27574, for 60583.....
27573	1105	Knife Grinder Knife Holder Guide Bar Bracket Spring for 60583.....
27574	1105	Knife Grinder Knife Holder Guide Bar Bracket Spring Hook for 27572.....
27610	2445	Bobbin Winder Spindle with 15072, for 27611.....
27611	—	Bobbin Winder Spindle 27610 with 2846, for 27656.....
27612	—	Bobbin Winder (swinging automatic, right hand) complete for 2996, Nos. 27308 and 27656.....
27646	1703	Bobbin Winder for 27543, Nos. 35D, 1620J, 27302, 27303, 27305, 27309, 27540, 27541, 50356D and two wood screws 1 in. No. 7.....
27647	2445	Bobbin Winder for 27544, Nos. 35D, 1620J, 27302, 27303, 27312, 27538, 27540, 27541, 50356D and two wood screws 1 in. No. 7.....
27656	2445	Bobbin Winder for 27612, Nos. 35D, 1620J, 27302, 27303, 27312, 27540, 27541, 27611, 50356D and two wood screws 1 in. No. 7.....
27657	—	Knife Grinder Knife Holder Body for 27658.....
27658	1105	Knife Grinder Knife Holder complete for 27661, Nos. 899J, 27657 and 27660.....
27659	1105	Knife Grinder Knife Holder Stop Collar with 237K, for 60583.....
27660	20882	Knife Grinder Knife Position Pin for 27658.....
27661	—	Knife Grinder complete for 6287 to 6292 and 6442, for 17-11 Machine, Nos. 27658, 27662, 60583 and three wood screws 1 in. No. 10.....
27662	1104	Wrench for 1508 and 1516, for 27661.....
27739	7234	Thread Unwinder Thread Cone (wood) for large cones, for 225394 and 225396..

NO.	PLATE	NAME
27822	1105	Knife Grinder Emery Wheel Clamping Nut Washer for 60934.....
27849	—	Bobbin Winder Spindle for 27538.....
*27850	—	“ “ “ Collar for 27538..
28367	3363	Lifting Presser Foot for 28821.....
28370	3363	Vibrating Presser Foot for 28821.....
28819	3363	Binder Ribbon Guide for 28821.....
28820	3363	Throat Plate for 6010, for 28821.....
28821	—	Binder complete, for circular binding, for sandals, slippers, shoe tongues, etc., for 17-8 Machine, Nos. 207F, 337J, 6010, 7071, 28367, 28370, 28819, 28820, 120493, 120494 or 120495.....
35116	3362	Binder on Shank, for raw edge binding, for tobacco pouches, etc., for 17-16 Machine
35117	3362	Presser Foot for 35116.....
35821	1518	Tape Holder Bracket Wire for 35822.....
35822	1518	Tape Holder Bracket Wire complete for 35827, Nos. 26918, 35821 and 35823....
35823	—	Tape Holder Disc for 35822 and 35825....
35824	1518	“ “ “ Hub for 35825.....
35825	1518	Tape Holder Disc complete for 35827, Nos. 35823 and 35824.....
35826	3375	Tape Holder Tension Adjusting Collar with 286D, for 35827.....
35827	1518	Tape Holder (straight) 6 in. disc, complete, Nos. 13211, 35822, 35825 and 35826.....
Nos. 36481 to 36486 for 36487		
36481	3387	Guide Arm.....
36482	3387	“ “ Hinge Plate.....
36483	3387	“ “ “ “ Pin.....
36484	3387	“ Bed with 198J.....
36485	3387	“ Lever.....
36486	3387	“ Smoothing Arm.....
36487	—	Guide (adjustable) complete, for sweat bands, for 17-26 Machine, Nos. 190J, 974D, 36481 to 36486 and two each 668D, 1560C and 42041.....
39623	20879	Shuttle Bobbin Case Position Finger for 40112.....
40112	20880	Shuttle Bobbin Case complete for 16735, Nos. 591F, 592E, 2523, 2975, 15141, 15278 and 39623.....
41828	—	Bobbin Winder Spindle Collar Pin for 27538.....

NO.	PLATE	NAME
42041	3383	Guide Arm Spring for 36487
42041	3383	" Smoothing Arm Spring for 36487 ..
42523	3388	" Rod Holder Washer for 6097 and 6098
*44001	—	Shuttle Cover 2075 with 112E, 466H, 2078, 2080, 2086 and 2090, for 6028, obsolete
50022c	3379	Presser Bar Lifting Rock Shaft Link Hinge Screw for 16729
50023D	3379	Pressure Regulating Thumb Screw for 17-28 Machine, obsolete
50027F	3382	Knife Driving Lever Plate Screw for 17-29 Machine
50037F	3380	Shuttle Race Screw for 17-29 Machine and obsolete for 17-28 Machine
50170J	3384	Shuttle Race Screw, for 1/2 in. to 3/4 in. gauges, for 17-7 and 17-21 Machines...
50222J	20884	Thread Lubricator Bracket Screw for 65092
50250J	3388	Shuttle Race Cover Hinge Screw for 65094
50250J	3388	Shuttle Race Cover Screw for 17-7, 17-8 and 17-21 Machines
50250J	3388	Shuttle Race Ring Cover Screw for 17-1, 17-2, 17-5, 17-11, 17-12, 17-15 to 17-18, 17-20, 17-24, 17-26 and 17-29 Ma- chines
50258J	3388	Shuttle Race Screw for 17-22, 17-23, 17-25, 17-28 and 17-30 Machines
50334J	3388	Pressure Regulating Thumb Screw for 17-28 Machine
50356b	3388	Bobbin Winder Frame Hinge Screw for 27646, 27647 and 27656
50553c	20882	Roller Screw for 51850, 51852, 51861 and 51893
50998K	20883	Knife Holder Screw for 65066
51022J	20882	Binder Folder Screw for 120493
51070E	20883	Machine Base Bolt with 51581E, to secure machine to base, for 7169
51072E	20883	Machine Bolt with 51581E, to secure machine to table (Accessories)
51133W	20883	Cylinder End Cover Screw (left) for 17-19 Machine
51581E	20883	Machine Base Bolt Nut for 51070
51581E	20883	Machine Bolt Nut for 51072
51849	—	Roller, 1/4 in. diam., coarse, for 51850

NO.	PLATE	NAME
51850	—	Roller, 1/4 in. diam., 3/8 in. face, coarse, (ball bearing) complete, for 65086, Nos. 1528J, 1766c, 50553c, 51849 and twenty- four 16232
51851	—	Roller, 1/4 in. diam., fine, for 51852
51852	20883	Roller, 1/4 in. diam., 1/8 in. face, fine, (ball bearing) complete, for 65047, Nos. 1528J, 1766c, 50553c, 51851 and twenty- four 16232
51860	—	Roller, 1/4 in. diam., for 51861
51861	20883	" 1/4 in. diam., 3/8 in. face, coarse, (ball bearing) complete, for 65041, Nos. 1528J, 1766c, 50553c, 51860 and twenty-four 16232
51892	—	Roller, 1/4 in. diam., 1/8 in. face, coarse, for 51893
51893	20883	Roller, 1/4 in. diam., 1/8 in. face, coarse, (ball bearing) complete, for 65099, Nos. 1528J, 1766c, 50553c, 51892 and twenty-four 16232
52016	20879	Presser Bar Lifter for 17-1, 17-3 to 17-11, 17-13 to 17-19, 17-23 and 17-27 to 17-30 Machines
*56752	—	Guide Bar 3126 with 2361 and two 2362, for 16794, 56844 and 56868
56753	—	Shuttle (outside) Cover 4582 with 112E, 466H, 2078, 2080, 2086 and 2090, for 3227, 3519, 4648 and 4729
56754	—	Shuttle (outside) Cover 3237 with 112E, 466H, 2078, 2080, 2086 and 2090, for 3228, 3229, 3520 and 3521
56755	—	Shuttle (inside) Cover 3236 with 112E, 466H, 2080, 3238, 3241 and 3242, for 3225, 3226, 3380 and 3381
56764	—	Needle Bar Connecting Link 4898 with 15472, for 17-8, 17-9, 17-12, 17-20, 17-21 and 17-24 to 17-26 Machines
56773	—	Needle Bar Connecting Link 3045 with 2052, for 17-1 to 17-7, 17-10, 17-13 to 17-19, 17-22, 17-23 and 17-27 to 17-30 Machines
56775	—	Face Plate complete for 17-1 to 17-6, 17-10, 17-13 to 17-15, 17-17 to 17-19, 17-22, 17-23, 17-27, 17-29 and 17-30 Ma- chines, Nos. 448c, 460c, 2107, 2111, 2127, 2269, 4369, 56791, 56796 and two 233J

NO.	PLATE	NAME
56789	---	Face Plate 4380 with 2105, for 56802.....
56791	---	Tension complete for 56775, 56802, 56873, 65044 and 65075, Nos. 2103, 2124, 16202 and two 2102.....
56796	---	Face Plate 4343 with 2105, for 56775.....
56797	---	" " 4376 with 2105, for 4856.....
56802	---	Face Plate complete for 17-11 Machine, Nos. 448c, 460c, 2107, 2111, 2127, 2269, 4369, 56789, 56791 and two 233J
56812	---	Oscillating Rock Shaft Hinge Pin 3052 with 1513j, for 16806.....
56817	---	Face Plate 4834 with 2105, for 56818.....
56818	---	Face Plate complete for 17-21 Machine, Nos. 86o, 233J, 330J, 448c, 808F, 809c, 2108, 2127, 2248, 2410, 2411, 4377, 56817, two each 1560c, 2103 and four 2102.....
*56828	---	Thread Take-up Cam for 3182.....
*56829	---	" " " " 3190.....
*56831	---	" " " " 3280.....
*56843	---	" " " " 3104.....
56844	---	Guide Bar 56752 with 337J and 3137, for 3127, 4730 and 16781.....
56847	---	Needle Bar Connecting Link 3098 with 15472, for 17-11 Machine.....
56855	---	Thread Take-up Lever 3072 with 1088c, for 17-1 to 17-6, 17-8 to 17-20, 17-22 to 17-27, 17-29 and 17-30 Machines
56864	3392	Chain Hook (large) for 6439.....
56865	3388	" " (small) for 6439.....
56868	---	Guide Bar 56752 with 4723 and three 404j, for 16656.....
56869	---	Thread Take-up Lever 3281 with 1088c, for 17-7 and 17-21 Machines.....
56870	20879	Face Plate Thread Guard for 56873.....
56871	20876	" " for 56872.....
56872	---	" " 56871 with 2105, for 56873....
56873	---	Face Plate complete for 17-8, 17-9, 17-12, 17-20, 17-24, 17-25 and 17-26 Machines, Nos. 448c, 460c, 2111, 2127, 2269, 4378, 56791, 56870, 56872 and two 233J
60583	5918	Knife Grinder for 27661, Nos. 261J, 27323, 27564, 27572, 27573, 27659, 60934, two 27568 and four each 310K and 1516J.....

NO.	PLATE	NAME
60934	---	Knife Grinder Emery Wheel Shaft 27567 with 1508J, 27565, 27569 and 27822, for 60583.....
*62739	20880	Shuttle Bobbin Case for 15277.....
*62818	---	Thread Lubricator Bracket for 65091.....
62819	20884	" " Oil Pad (felt) for 65089
*62820	---	" " " " Holder for 65088.....
62824	20884	Thread Lubricator Oil Pad Retainer for 65089.....
62827	20877	Thread Lubricator Oil Wick (braided cotton) for 65089.....
62830	---	Thread Lubricator Oil Reservoir for 65091
62851	20882	Roller Ratchet Spring Stop Bracket for 62854.....
62853	20882	Roller Ratchet Spring Stop for 62854....
62854	---	" " " " Bracket 62851 with 665J and 62853, for 65099.....
*65003	---	Thread Take-up Cam for 6450.....
65008	3392	Feed Cam with 446c, for 17-24 Machine..
65009	3392	" Lever for 17-24 Machine.....
65010	3389	Needle Plate for 65011.....
65011	---	Shuttle Race Ring complete for 17-24 Machine, Nos. 16670, 16777, 65010 and four 220J.....
65013	3394	Cloth Plate for 65016.....
65014	3394	" " Bracket with two 345c, for 65017.....
65015	3394	Cloth Plate Slide for 65016.....
65016	3394	Cloth Plate complete for 65017, Nos. 3286, 65013, 65015 and two 725J.....
65017	---	Cloth Plate with Bracket complete for 17-30 Machine, Nos. 65014, 65016 and two 389F.....
*65018	---	Thread Take-up Cam for 16739, obsolete
*65021	---	Arm with 4448, 4449, 15404 and two 15405, for 17-5 Machine.....
*65022	---	Arm with 4448, 4449, 15404 and two 15405, for 17-20 Machine.....
65024	3389	Shuttle Driver and Feed Lifting Cam for 17-7 and 17-21 Machines.....
65029	3389	Throat Plate for 16618, for ladies' shoes
65030	20886	Roller Presser complete, 1¼ in. fine roller, for 17-22 Machine, Nos. 176J, 440F, 1547J, 1549J, 1898, 2205, 6073, 16625 and two 15444.....

NO.	PLATE	NAME
65031	—	Throat Plate, large needle hole, for 335, for 65033.....
65032	3390	Throat Plate Needle Hole Strip, large needle hole, for 65033.....
65033	3390	Throat Plate, large needle hole, complete for 335, for 16744, 16846 and 65058, Nos. 65031, 65032 and two 238b.....
65034	—	Thread Take-up Lever 16740 with 1088c, for 17-28 Machine.....
65035	3389	Throat Plate for 6182.....
*65037	—	Presser Foot for 65039.....
65038	20879	" " Finger Guard for 65039.....
65039	20879	Presser Foot with Finger Guard complete, for 17-28 Machine, Nos. 65037 and 65038.....
65040	20879	Shuttle Driver for No. 23 Needle, for 17-28 Machine.....
65041	20881	Roller Presser (ball bearing) complete, 1¼ in. coarse roller, for 17-29 Machine, Nos. 176j, 440f, 1547j, 1549j, 2205, 4282, 16230, 51861 and two 15444.....
65042	20876	Face Plate for 65043.....
65043	—	" " 65042 with 2105, for 65044.....
65044	—	Face Plate complete for 17-16 Machine, Nos. 448c, 460c, 463c, 2107, 2111, 2127, 2269, 4369, 56791, 65043, 65045 and two 233j.....
65045	20879	Face Plate Thread Eyelet for 65044.....
65046	20881	Roller Presser complete, 1¼ in. fine roller, for 17-29 Machine, Nos. 176j, 440f, 1547j, 1549j, 1932, 2205, 4282, 16098 and two 15444.....
65047	20881	Roller Presser (ball bearing) complete, 1¼ in. fine roller, for 17-23 Machine, Nos. 176j, 440f, 1547j, 1549j, 2205, 4282, 16230, 51852 and two 15444.....
65049	20882	Guide Roller, Nos. 1852 and 65050, for 17-30 Machine.....
65050	20882	Guide Bracket for 65049.....
65051	—	Roller Presser complete, 1¼ in. coarse roller, for 17-22 Machine, Nos. 176j, 440f, 1547j, 1549j, 1897, 2205, 6073, 16625 and two 15444.....
65052	—	Shuttle Race Body for 65094.....
65053	20880	" " Cap for 65094.....

NO.	PLATE	NAME
*65055	—	Thread Take-up Cam for 65056.....
65056	20877	" " " 65055 with 446c, for 17-28 Machine.....
65058	20879	Feed Dog (diagonal spiked teeth) for 65033, for 17-29 Machine.....
65059	20879	Shuttle Race Ring Thread Protector for 6032, 16602, 16757, 16797 and 16886.....
65063	20880	Knife Driving Lever for 65064.....
65064	—	Knife Driving Lever complete for 65066, Nos. 104b, 217j, 16749, 24173, 65063 and 65065.....
65065	20880	Knife Driving Lever Adjusting Block with 24177, for 65064.....
65066	—	Trimming Attachment (adjustable) complete for 17-29 Machine, Nos. 1097f, 16751, 16753, 24170, 24175, 24188, 24587, 50998k, 65064, two each 756d, 24171 and four 934j.....
65067	20879	Feed Dog, 12 teeth (16 teeth to the inch) for 65070, for 17-8 Machine.....
*65068	—	Thread Take-up Cam for 65069.....
65069	20877	" " " 65068 with 446c, for 17-8 Machine.....
65070	20879	Throat Plate for 65067.....
65073	20877	Face Plate for 65074.....
65074	—	" " 65073 with 2105, for 65075.....
65075	—	Face Plate complete for 17-30 Machine, Nos. 448c, 460c, 2107, 2111, 2127, 2269, 4369, 56791, 65074 and two 233j.....
65076	20878	Feed Dog, 5 teeth (20 teeth to the inch) for 65084, for 17-30 Machine.....
65077	20878	Shuttle Race Body for 65078.....
65078	—	" " " 65077 with 665j and 65081, for 65080.....
65079	20878	Shuttle Race Ring for 65080.....
65080	—	Shuttle Race complete for 17-30 Machine, Nos. 16873 to 16875, 65078, 65079 and two each 330j and 399f.....
65081	20878	Shuttle Race Thread Protector for 65078.....
*65082	—	Thread Take-up Cam for 65083.....
65083	20877	" " " 65082 with 446c, for 17-30 Machine.....
65084	20878	Throat Plate for 65076.....
65085	—	" " Holder 16879 with 65084, for 17-30 Machine.....

NO.	PLATE	NAME
65086	---	Roller Presser (ball bearing) complete, 1¼ in. coarse roller, for 17-23 Machine, Nos. 176J, 440F, 1547J, 1549J, 2205, 4282, 16230, 51850 and two 15114.....
65087	20884	Thread Lubricator Bracket Extension for 65092.....
65088	---	Thread Lubricator Oil Pad Holder 62820 with 65090, for 65089.....
65089	20884	Thread Lubricator Oil Pad Holder 65088 with 62819, 62824 and 62827, for 65091
*65090	---	Thread Lubricator Oil Pad Holder Oil Tube for 65088.....
65091	20884	Thread Lubricator complete for 65092, Nos. 8068, 17822, 62818, 62830, 65089 and 124371.....
65092	20884	Thread Lubricator 65091 with 1529E, 50222J, 65087 and two 21202, for 17-1 to 17-7, 17-10, 17-13 to 17-19, 17-22, 17-23 and 17-27 to 17-30 Machines.....
65093	20880	Shuttle Race Cover for 65094.....
65094	---	Shuttle Race complete for 17-22, 17-23 and 17-25 Machines, Nos. 50250J, 65052, 65053, 65093 and two each 1053J and 22431.....
65095	20882	Roller Arm for 65099.....
65099	20881	Roller Presser (ball bearing) 1¼ in. coarse roller, ½ in. face, with ratchet brake, for 17-29 Machine, Nos. 176J, 230F, 440F, 1547J, 1549J, 2205, 4282, 51893, 62854, 65095 and two 15444.....
120342	20885	Oiler (copper plated) with 120343 (Accessories).....
120343	20885	Oiler Spout, 3½ in. long, for 120342.....
120493	20882	Binder Folder with two 51022J, for ¼ in. to ½ in. gauges, for 28821.....
120494	20882	Binder Folder with two 1368J, for ½ in. to ¾ in. gauges, for 28821.....
120495	20882	Binder Folder with two 1368J, for ¾ in. to 1 in. gauges, for 28821.....
120527	---	Hemmer Folder for 6265 and 6266, for 17-14 Machine.....
124371	20884	Thread Lubricator Oil Reservoir Rivet Washer (outside) for 65091.....
125017	---	Shuttle Cover 15458 with 112E, 466N, 2078, 2080, 2086 and 2090, for 16892..
200383c	3388	Thread Unwinder Spool Rest Rod Set Screw for 202490.....

NO.	PLATE	NAME
201018c	3388	Thread Unwinder Spool Rest Set Screw for 225389 and 225395.....
201696J	3388	Thread Unwinder Thread Guide Lock Nut for 225394 and 225396.....
202490	3398	Thread Unwinder Spool Stand with 200383c, for 225394 and 225396.....
225322	20883	Thread Unwinder Thread Guide Rod Washer for 225324.....
225324	3398	Thread Unwinder Thread Guide Rod with 208E and 225322, for 225394 and 225396.....
225326	20883	Thread Unwinder Thread Guide Position Cup for 225394 and 225396.....
225388	3398	Thread Unwinder Spool Rest Rod for 225394 and 225396.....
225389	3398	Thread Unwinder Spool Rest with 201018c, for 225394.....
225390	7234	Thread Unwinder Thread Cone Holder, for inverted cones, for 225394 and 225396
225391	3398	Thread Unwinder Thread Guide for 225394 and 225396.....
225394	3398	Thread Unwinder complete, for one spool, Nos. 201696J, 202490, 225324, 225326, 225388, 225389, 225391 and three wood screws ¼ in. No. 12.....
225395	7233	Thread Unwinder Spool Rest with 201018c for 225396.....
225396	7233	Thread Unwinder complete, for two spools, Nos. 201696J, 202490, 225324, 225326, 225388, 225395, two 225391 and three wood screws ¼ in. No. 12....

SINGER Needles should be used
in SINGER Machines.
These Needles and their Containers
are marked with the
Company's Trade-Mark "SIMANCO." 1

Needles in Containers marked
"FOR SINGER MACHINES"
are NOT **SINGER** made needles. 2

PLATE 217—FULL SIZE

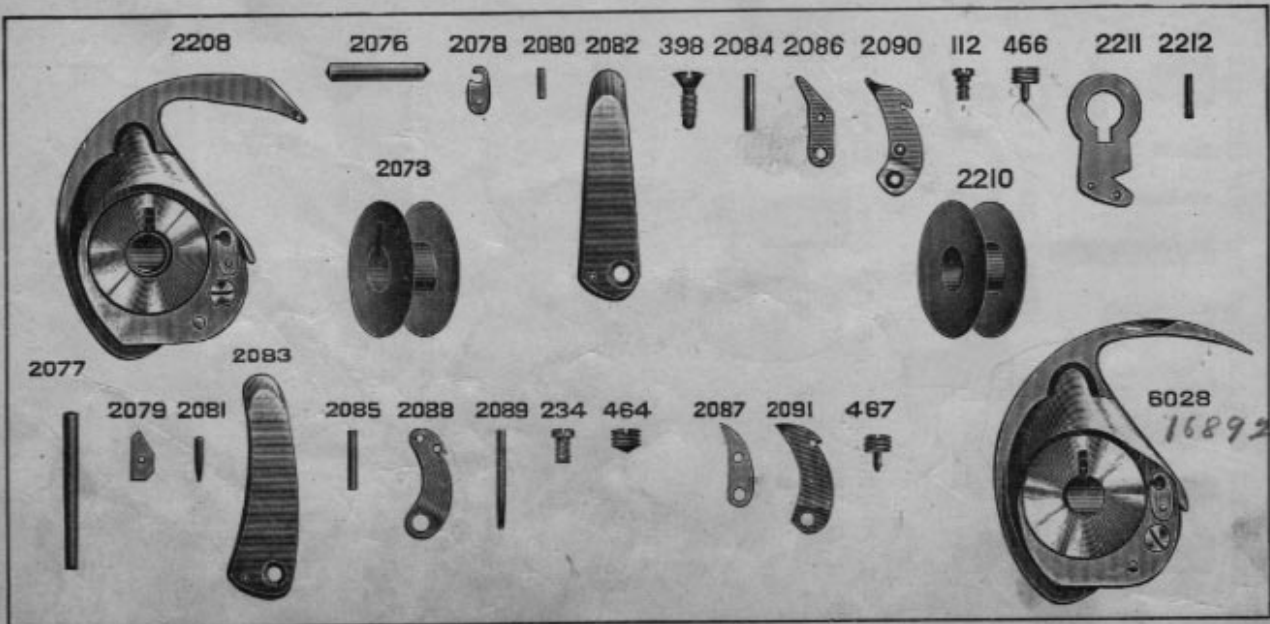


PLATE 221—FULL SIZE



PLATE 231—FULL SIZE

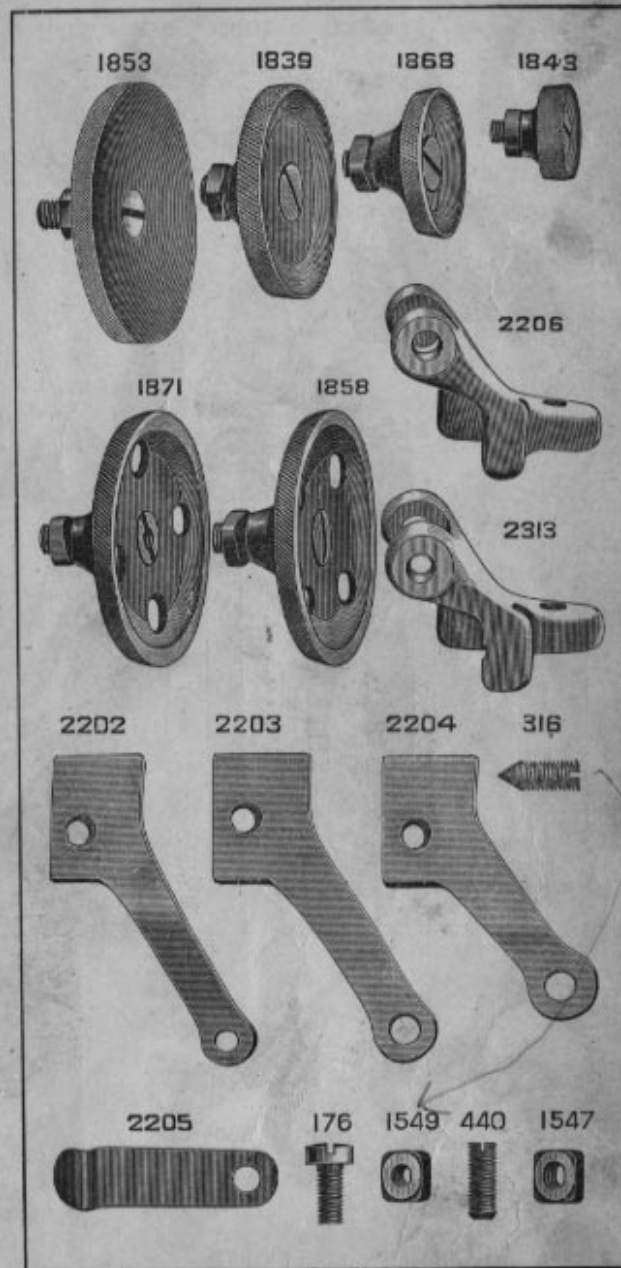


PLATE 259—ONE-HALF SIZE

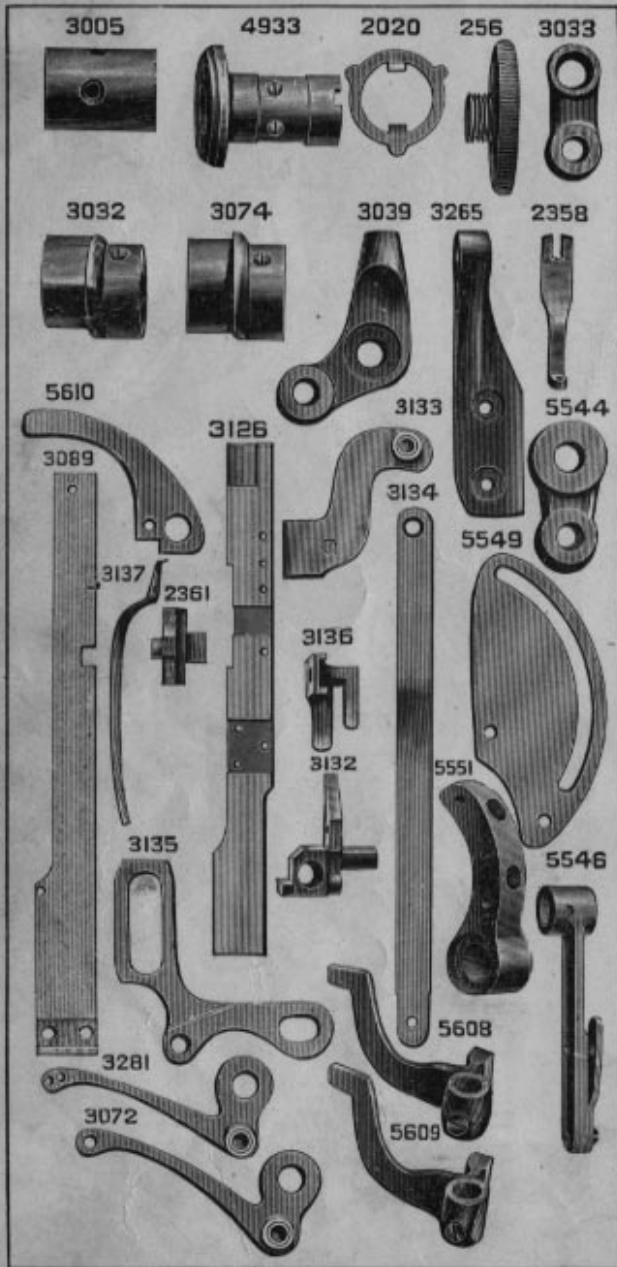


PLATE 297—FULL SIZE

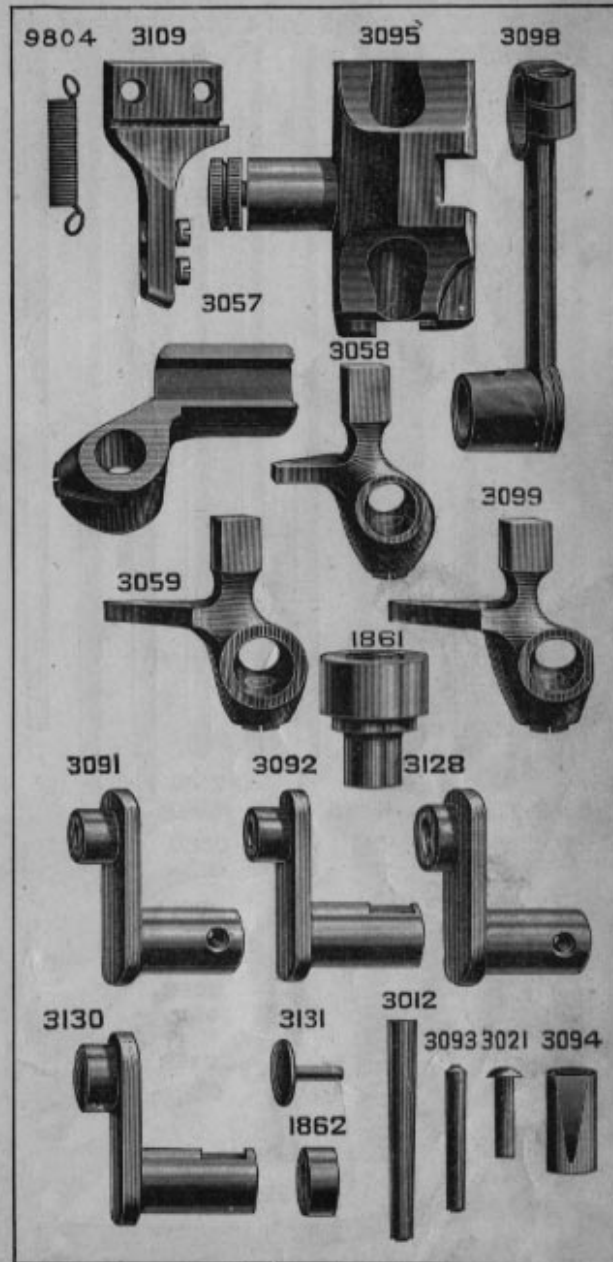


PLATE 301—ONE-HALF SIZE

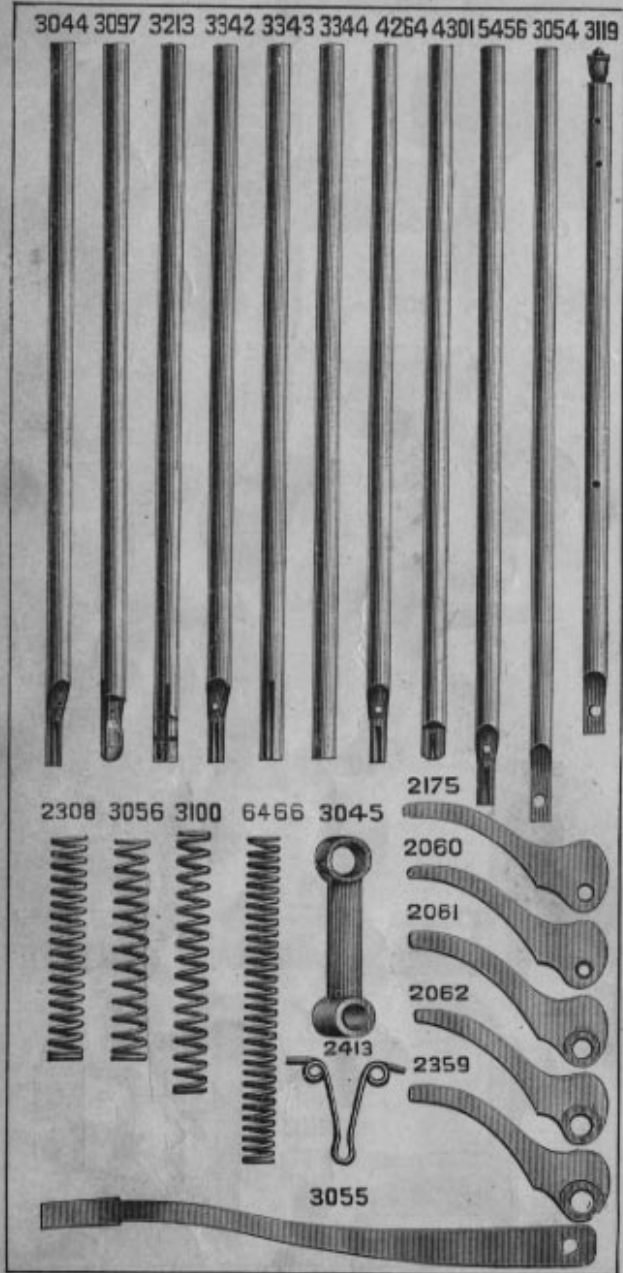


PLATE 302—FULL SIZE

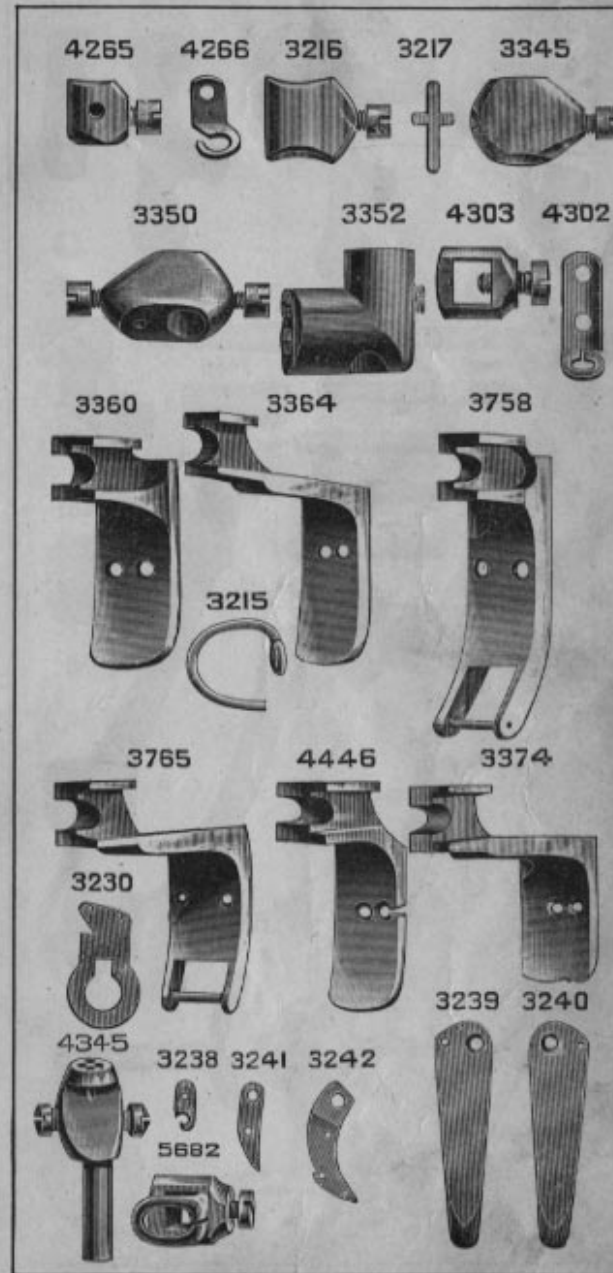


PLATE 310—ONE-HALF SIZE



PLATE 312—FULL SIZE

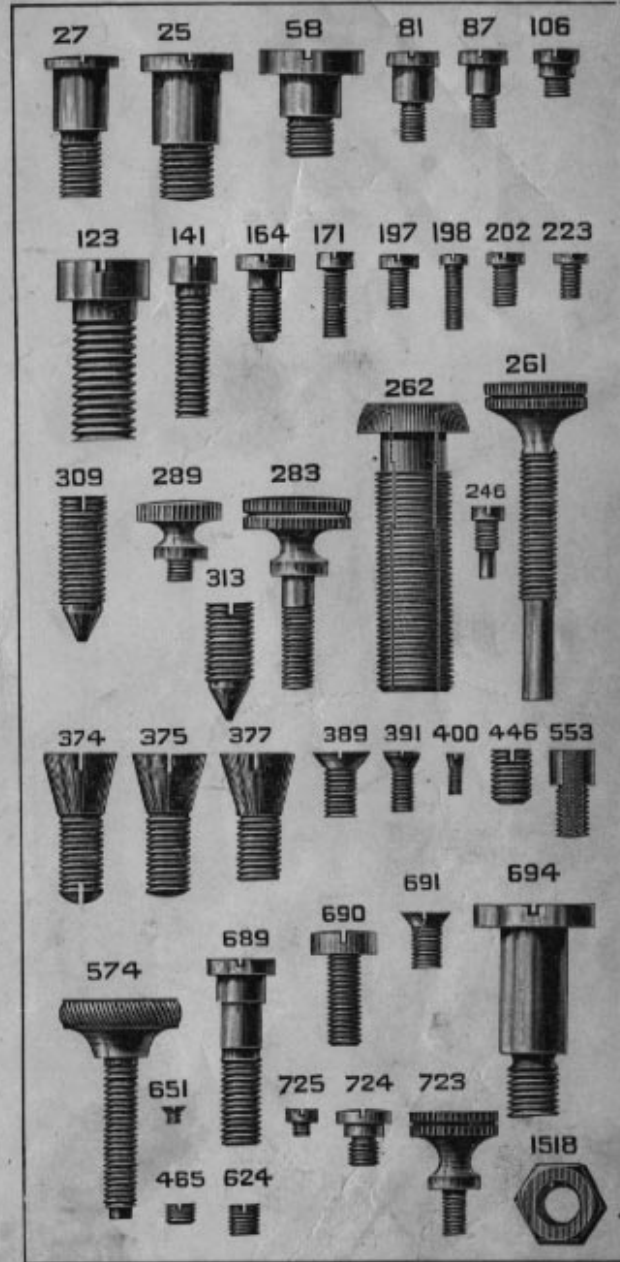


PLATE 358—ONE-HALF SIZE



PLATE 364—ONE-FOURTH SIZE

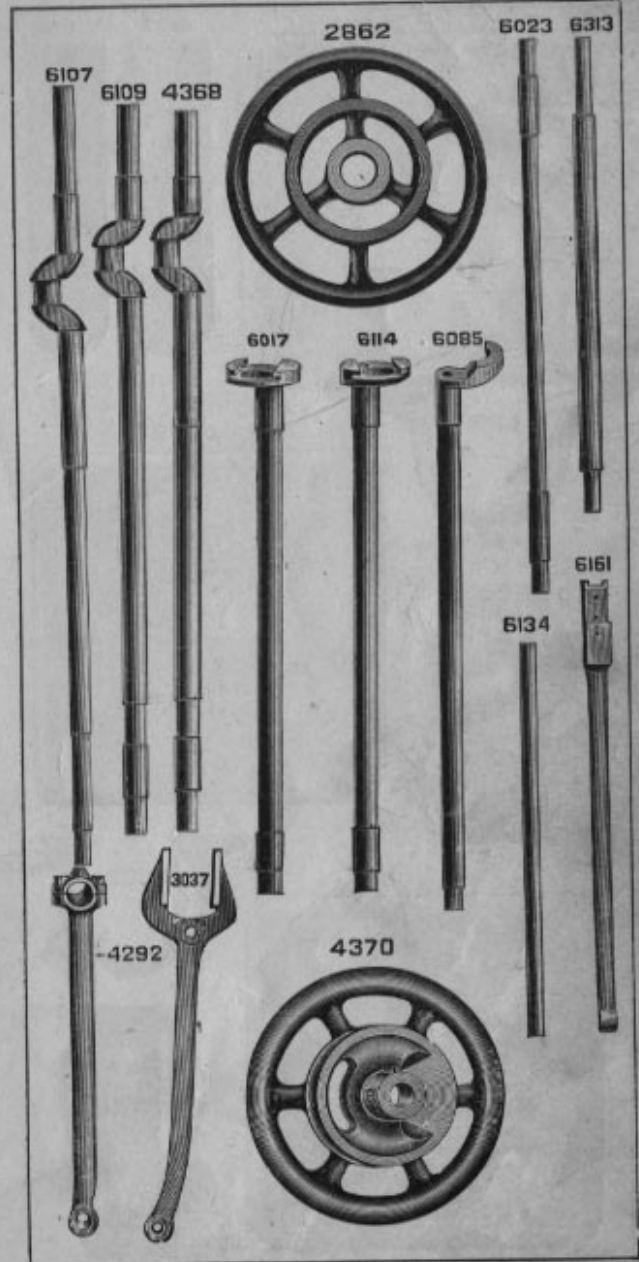


PLATE 365—ONE-FOURTH SIZE

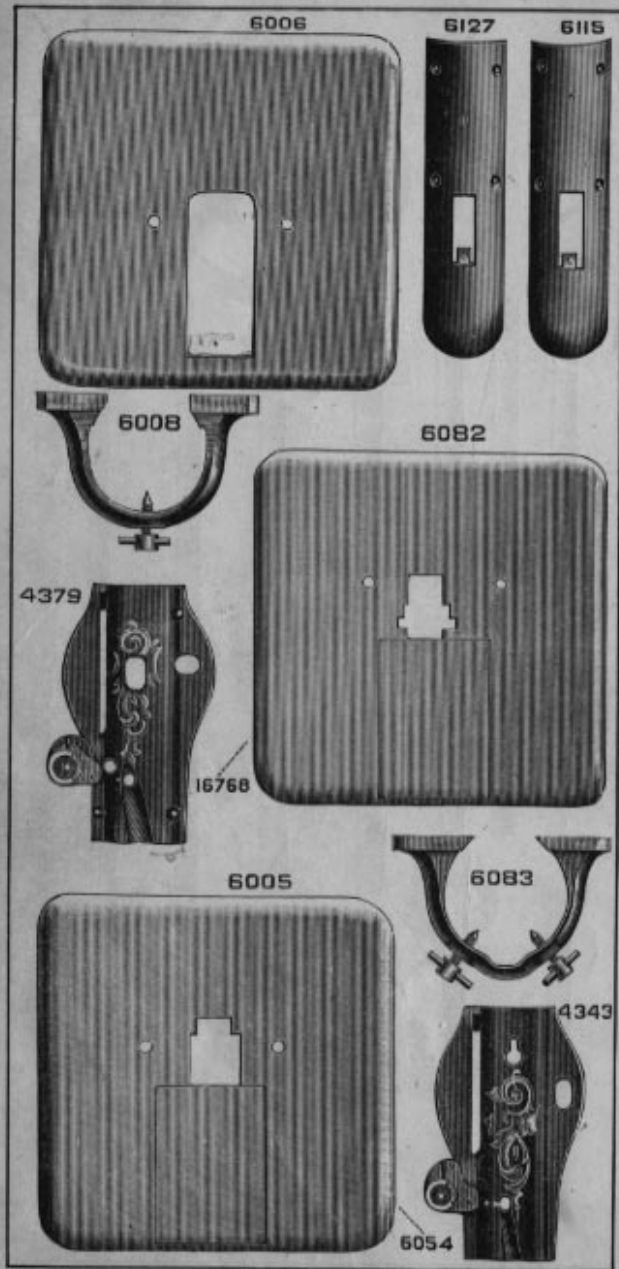


PLATE 366—ONE-HALF SIZE

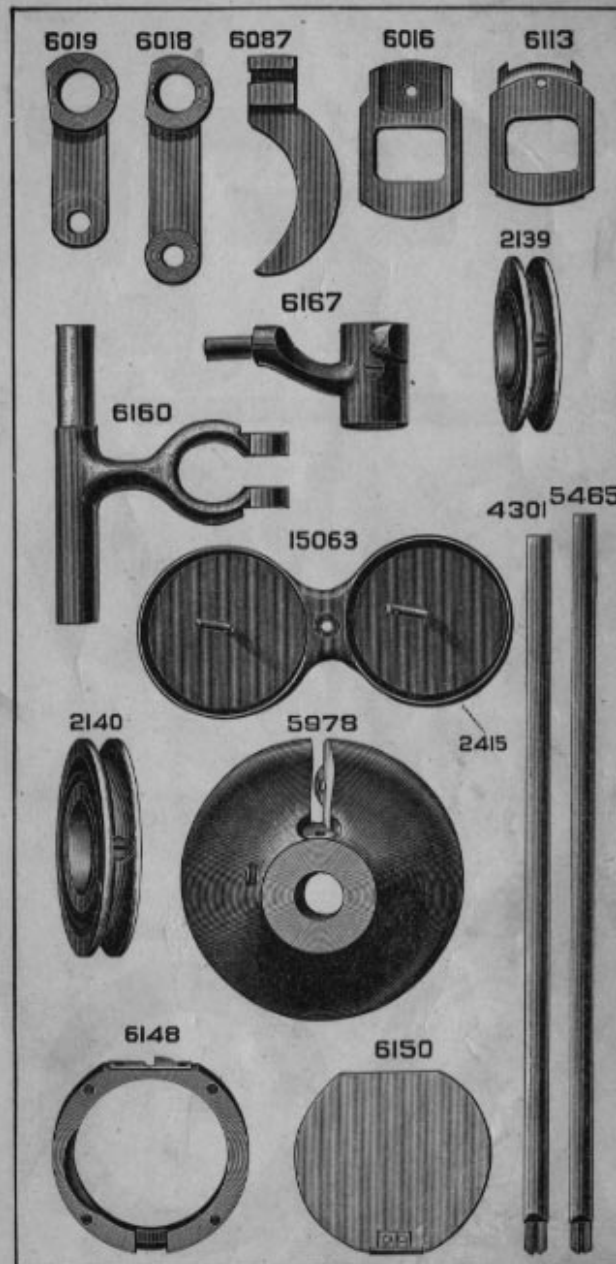


PLATE 367—ONE-HALF SIZE

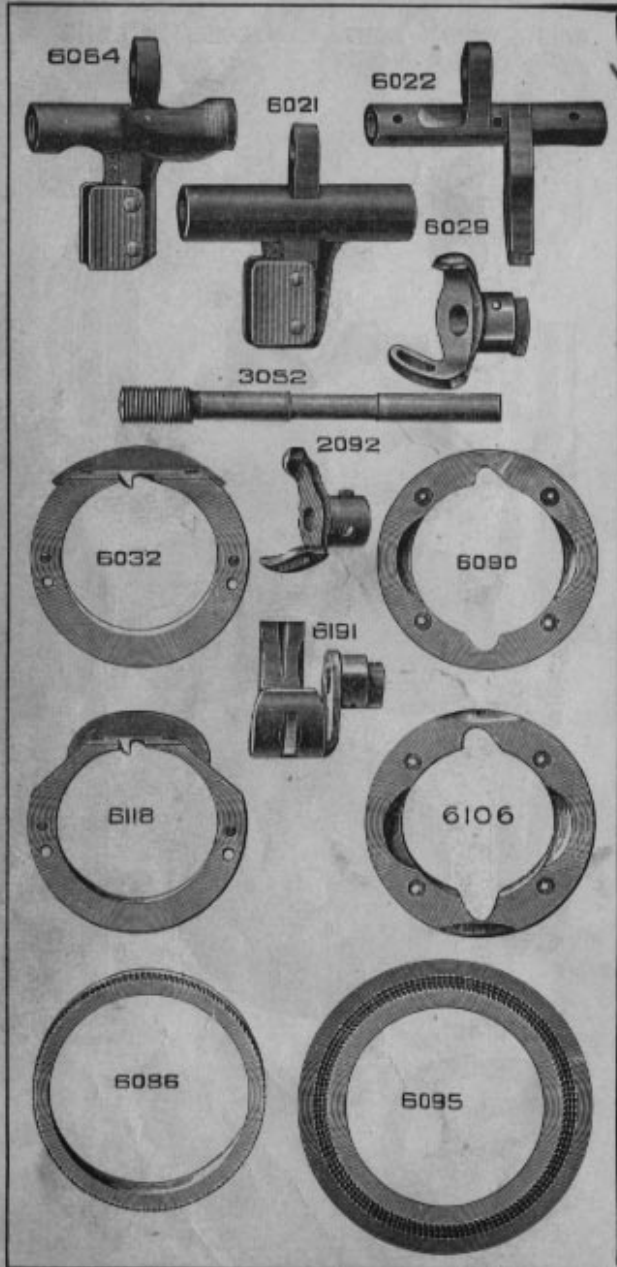


PLATE 368—ONE-HALF SIZE

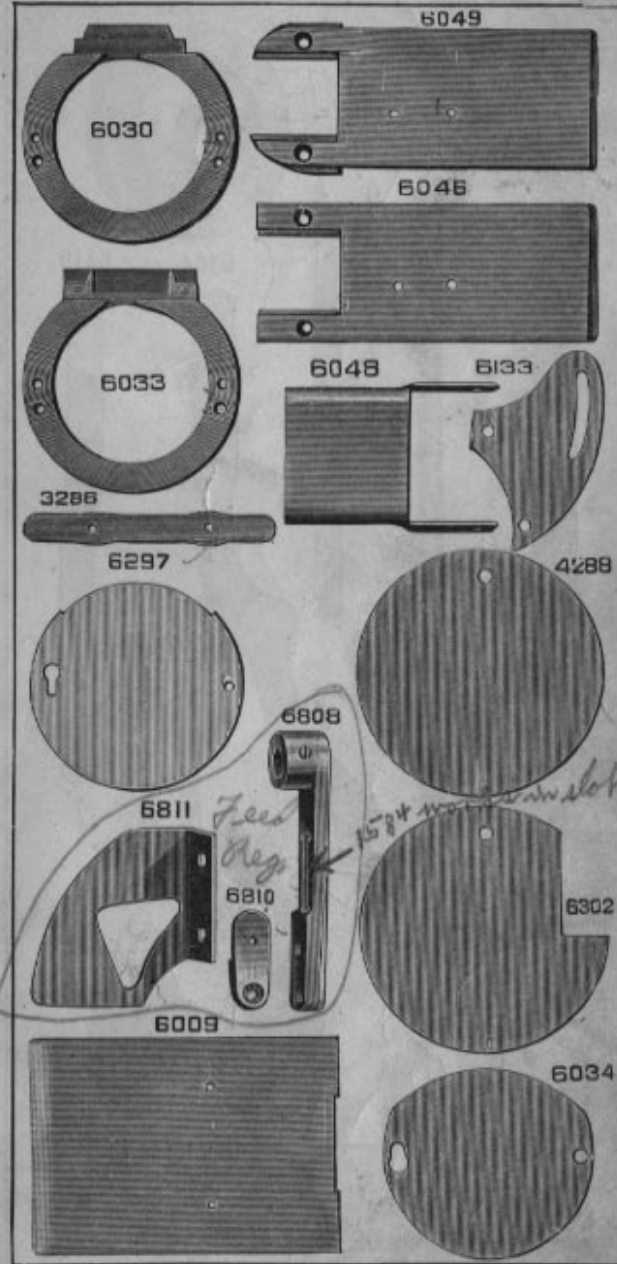


PLATE 369—ONE-HALF SIZE

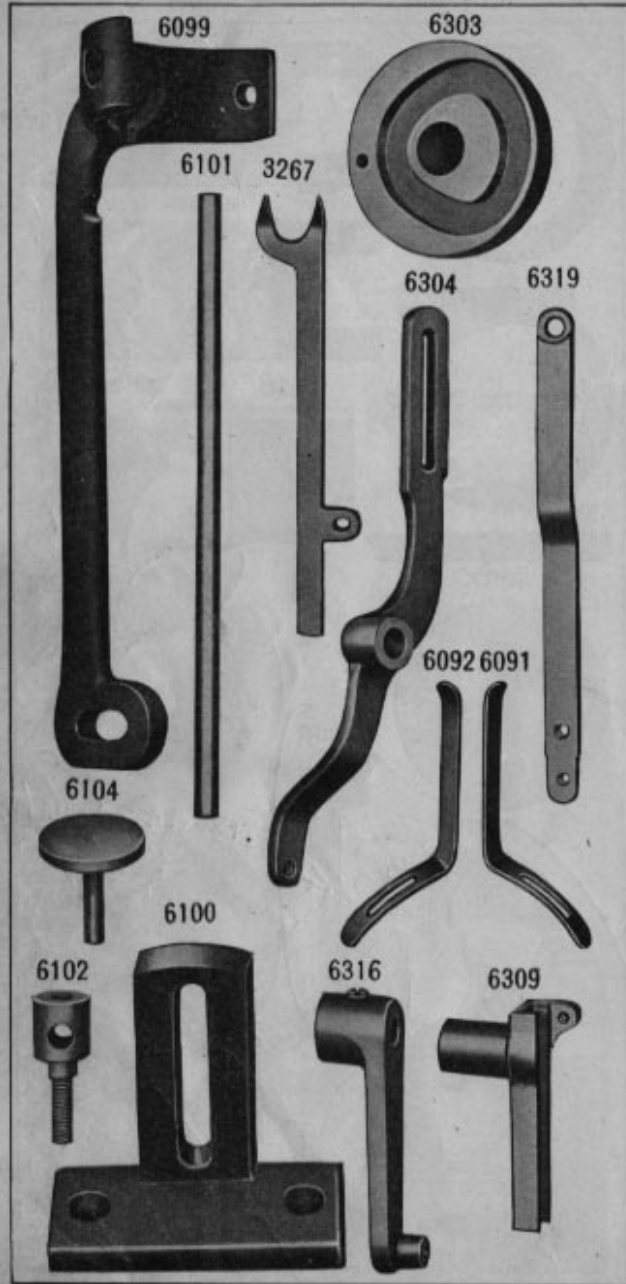


PLATE 370—ONE-HALF SIZE

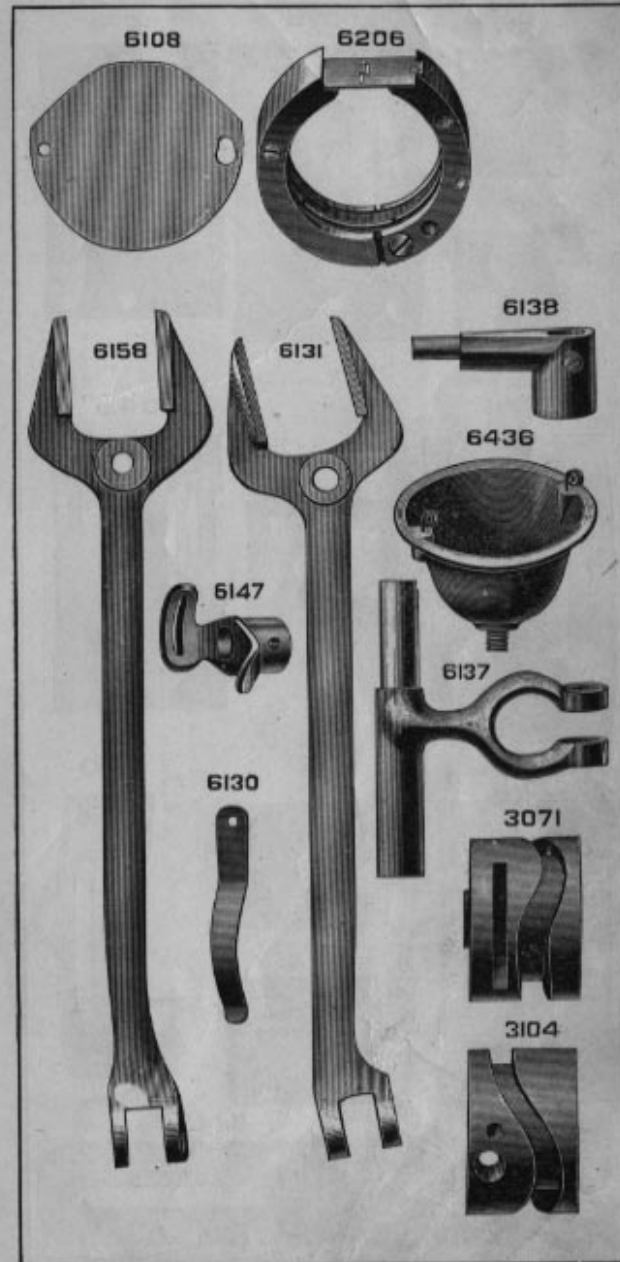


PLATE 371—FULL SIZE

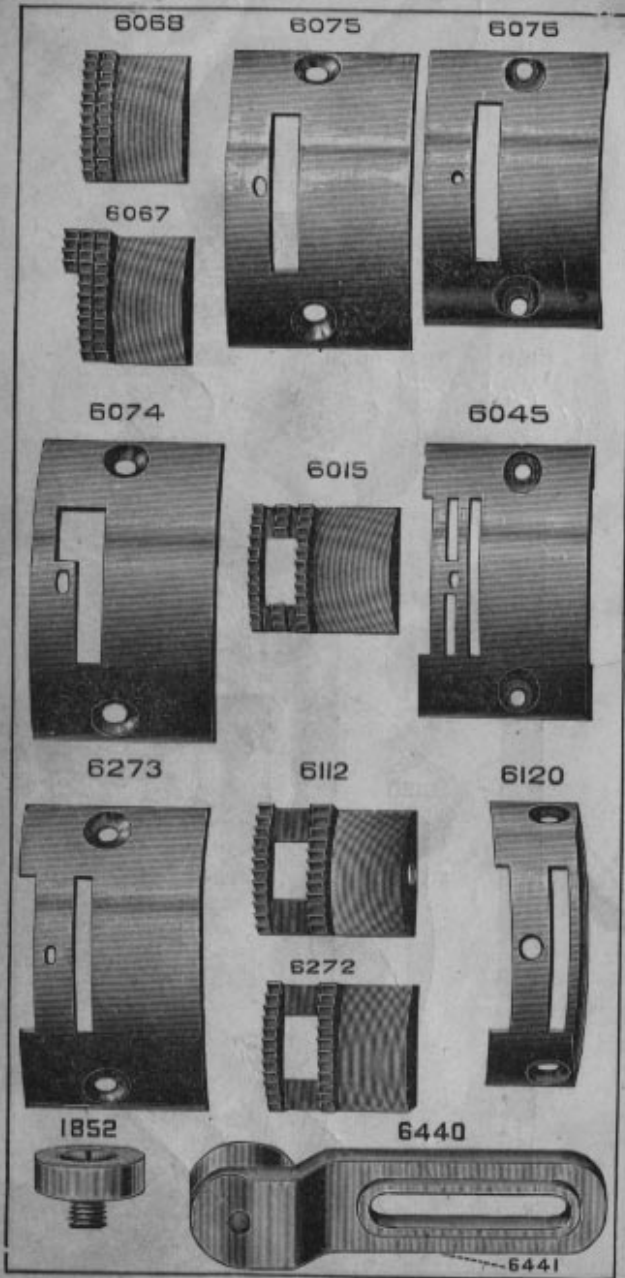


PLATE 372—FULL SIZE

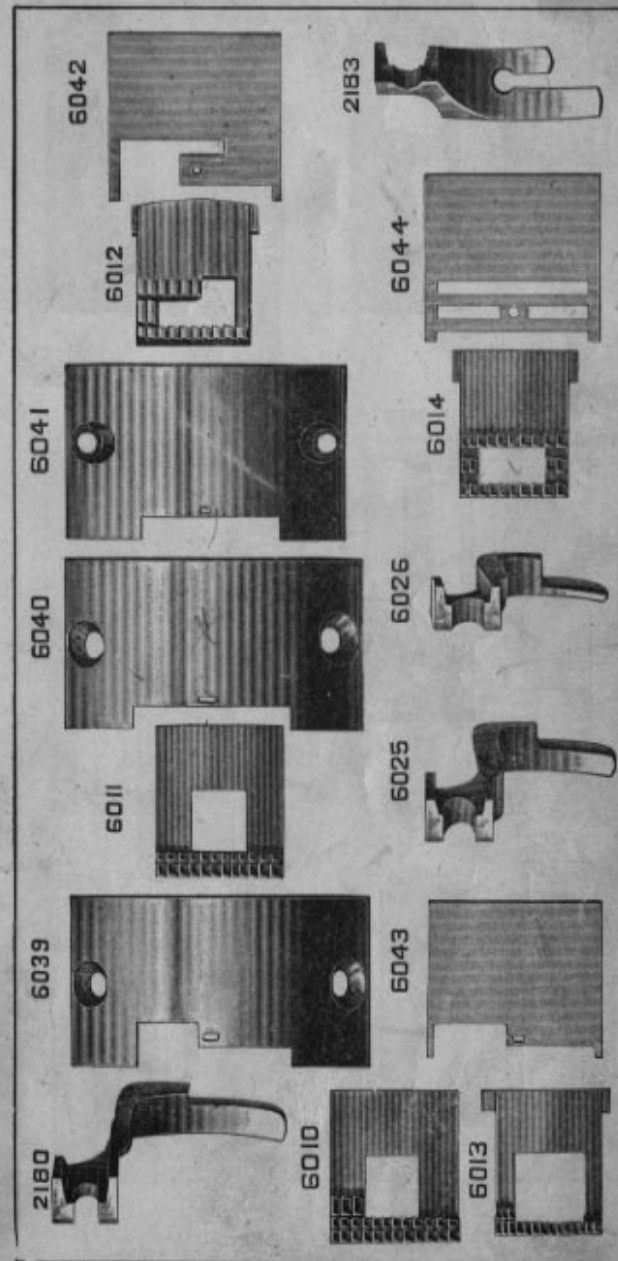


PLATE 373—FULL SIZE

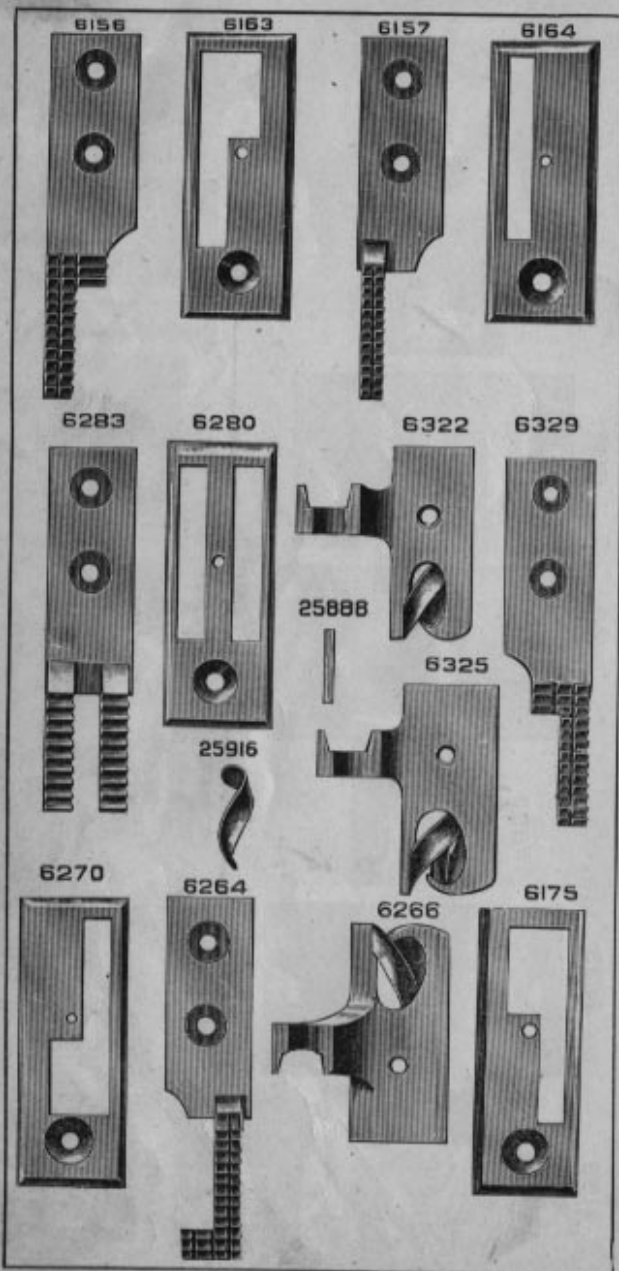


PLATE 374—FULL SIZE

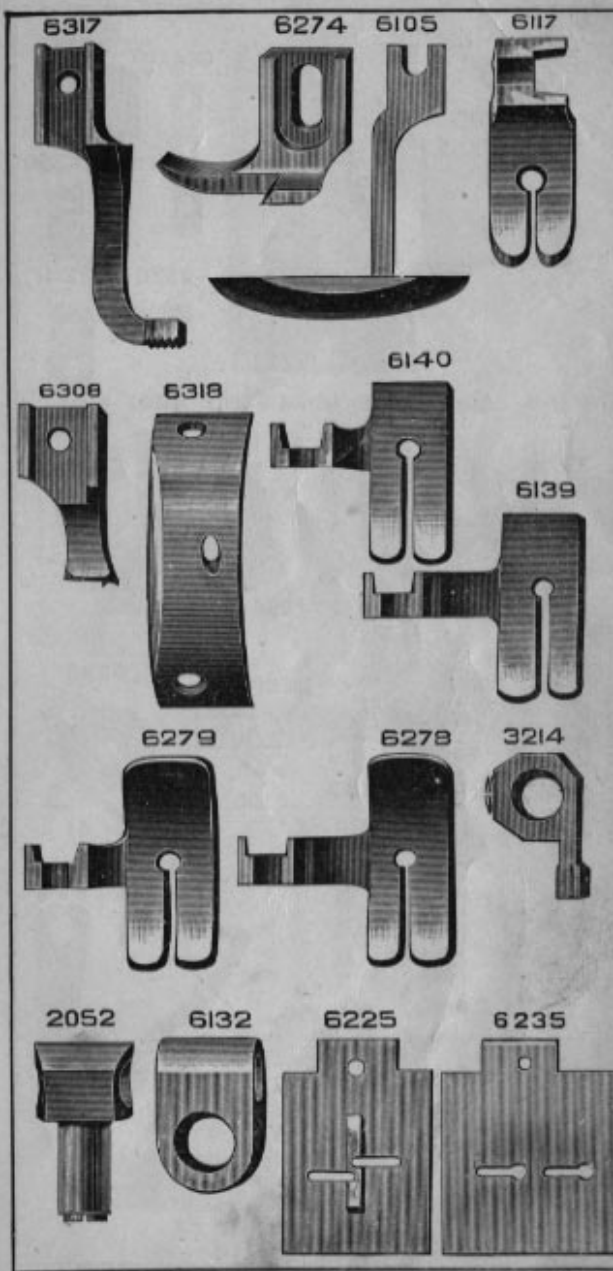


PLATE 375—FULL SIZE

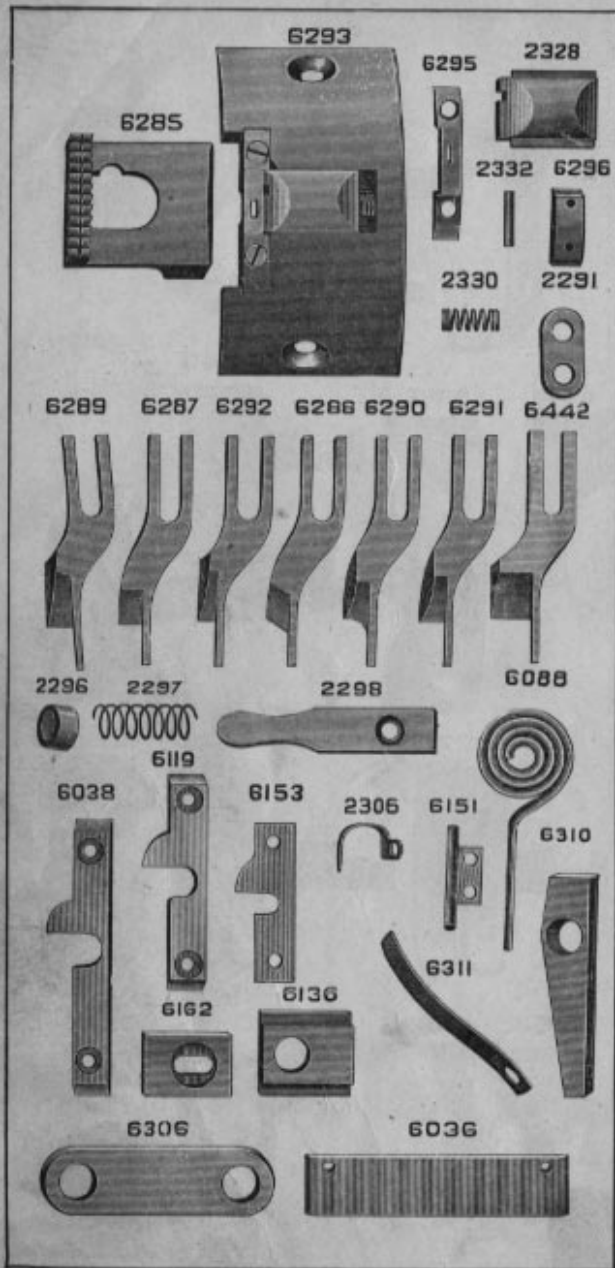


PLATE 376—FULL SIZE

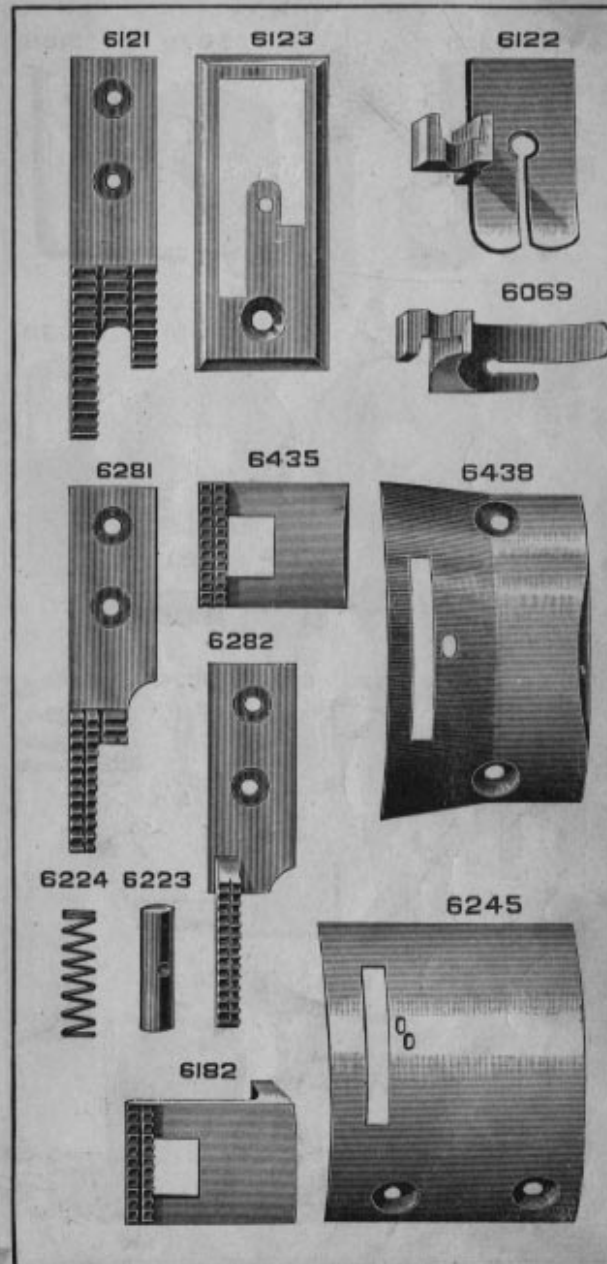


PLATE 377—FULL SIZE

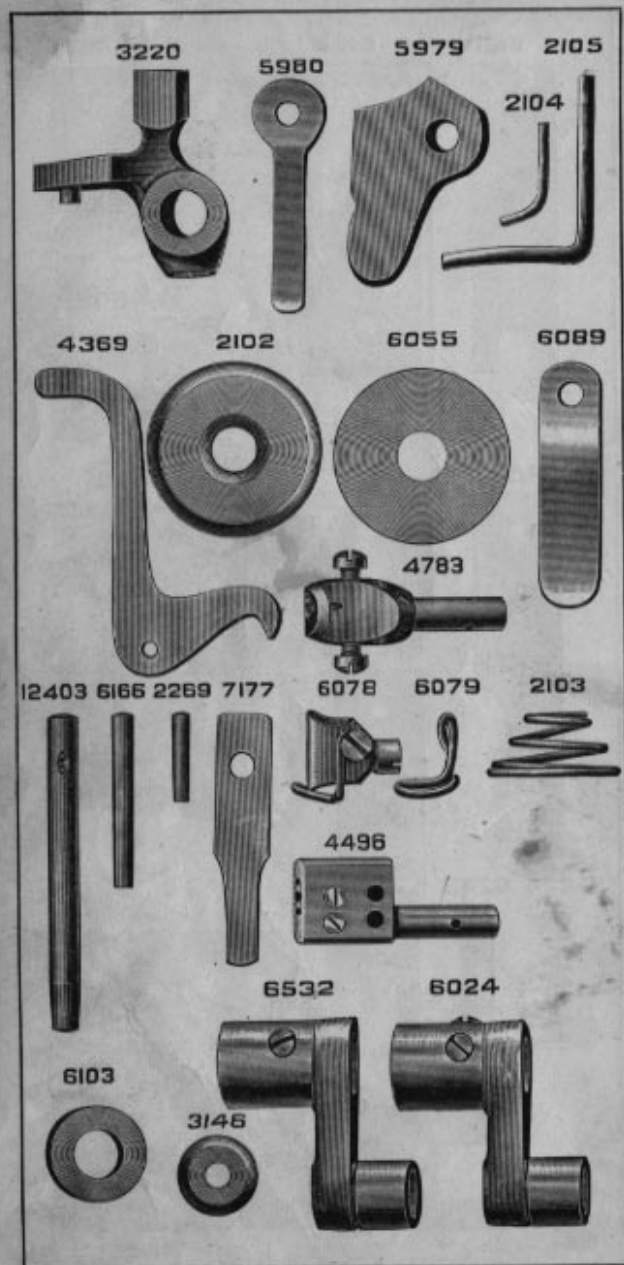


PLATE 378—FULL SIZE

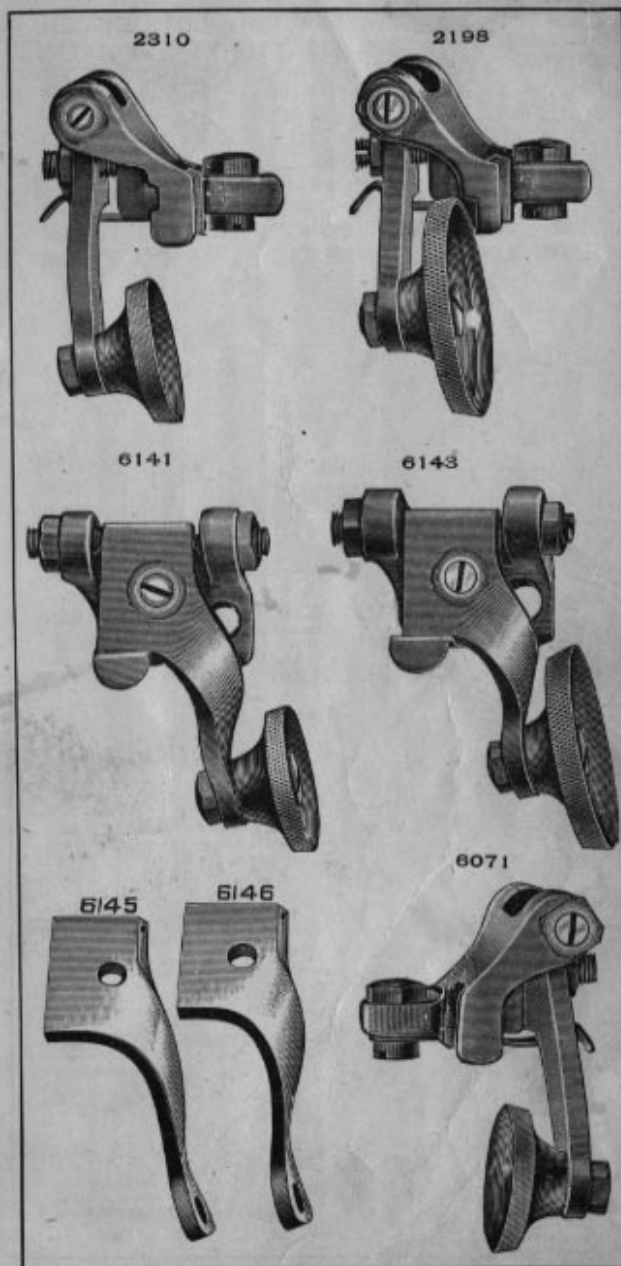


PLATE 379—FULL SIZE

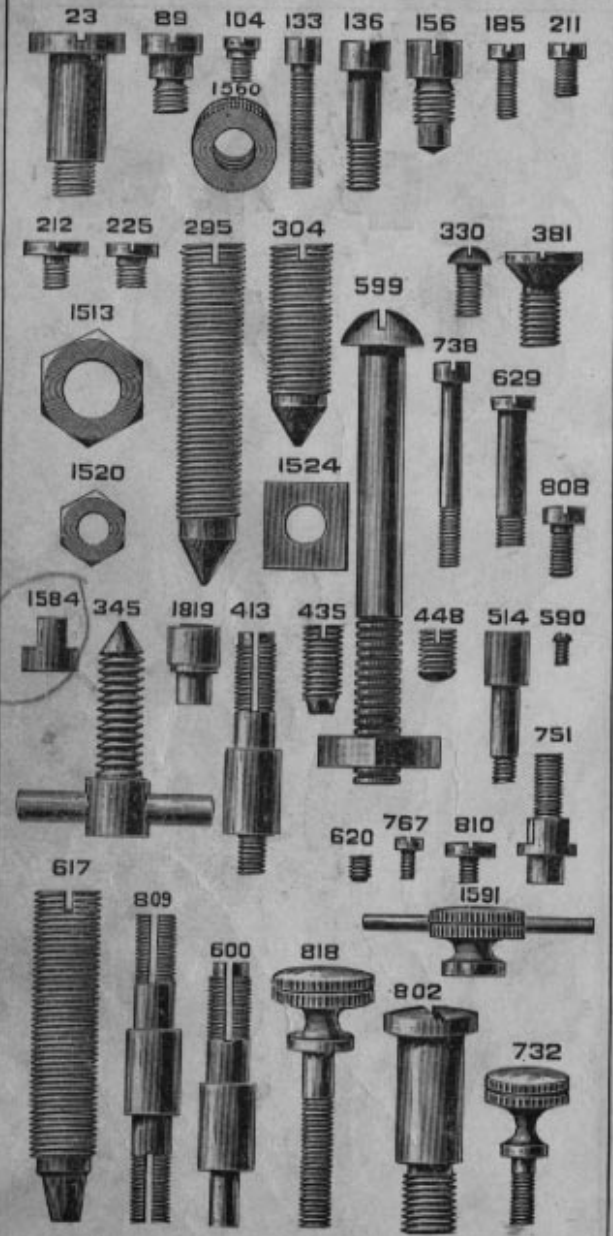
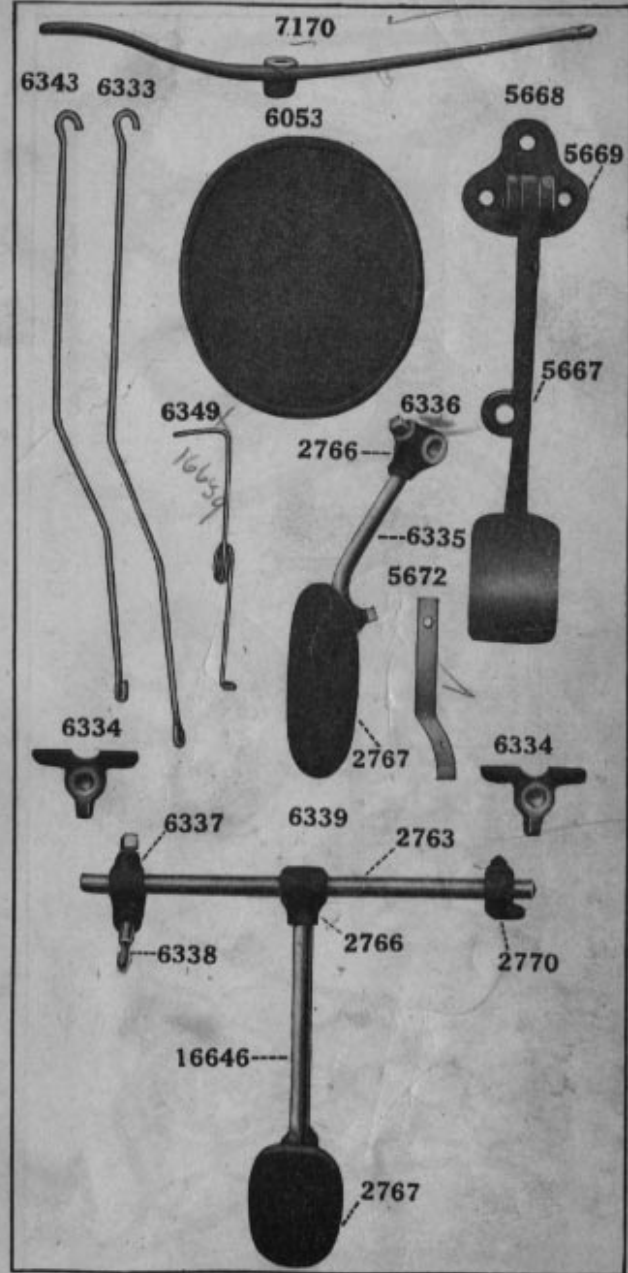


PLATE 380—ONE-FOURTH SIZE

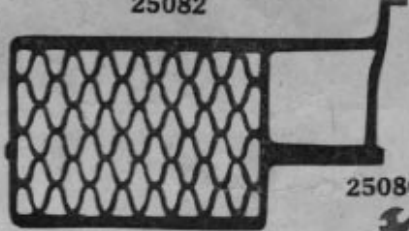


25074

25065



25082



25086



25133



25077

25368

SINGER

46553

25010

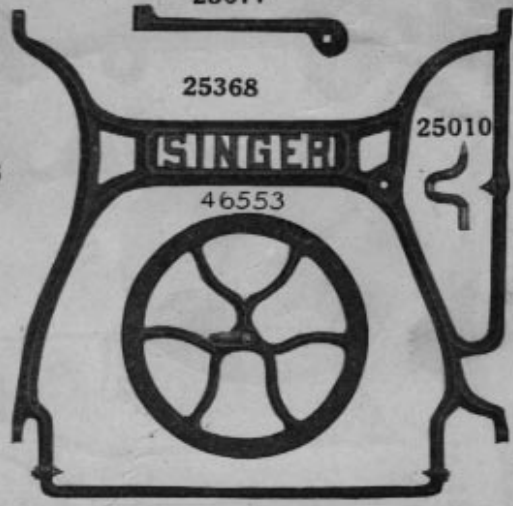


PLATE 381 - ONE-NINTH SIZE

PLATE 382—ONE-HALF SIZE

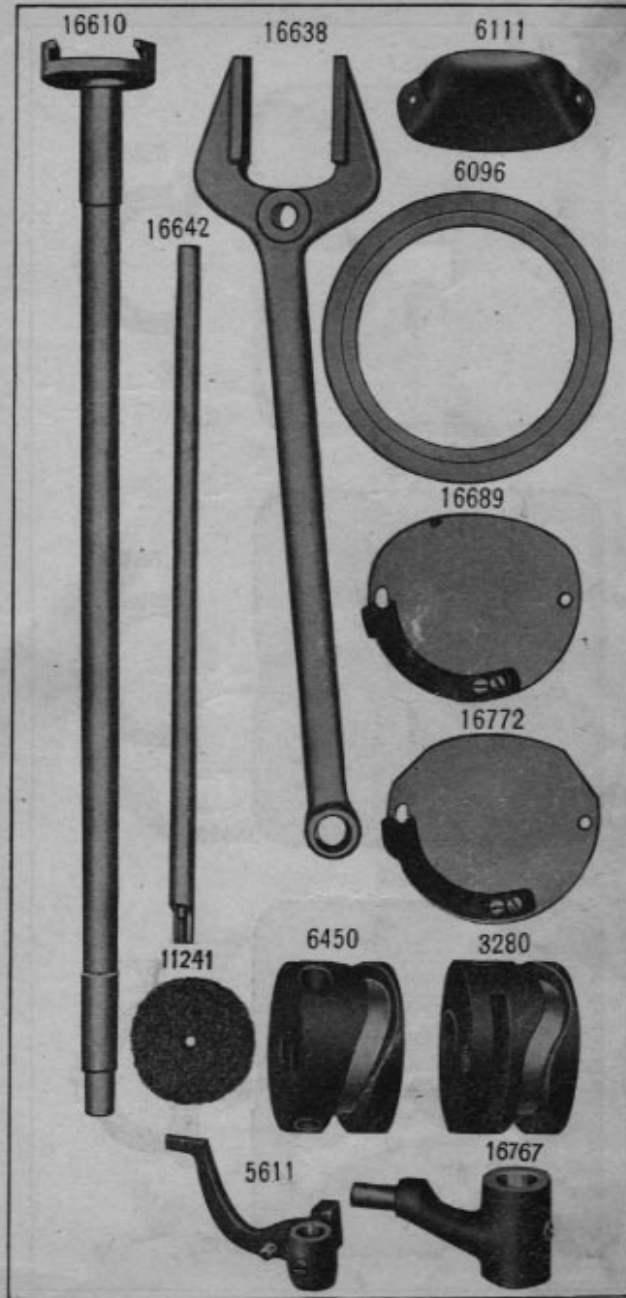


PLATE 383—ONE-FOURTH SIZE

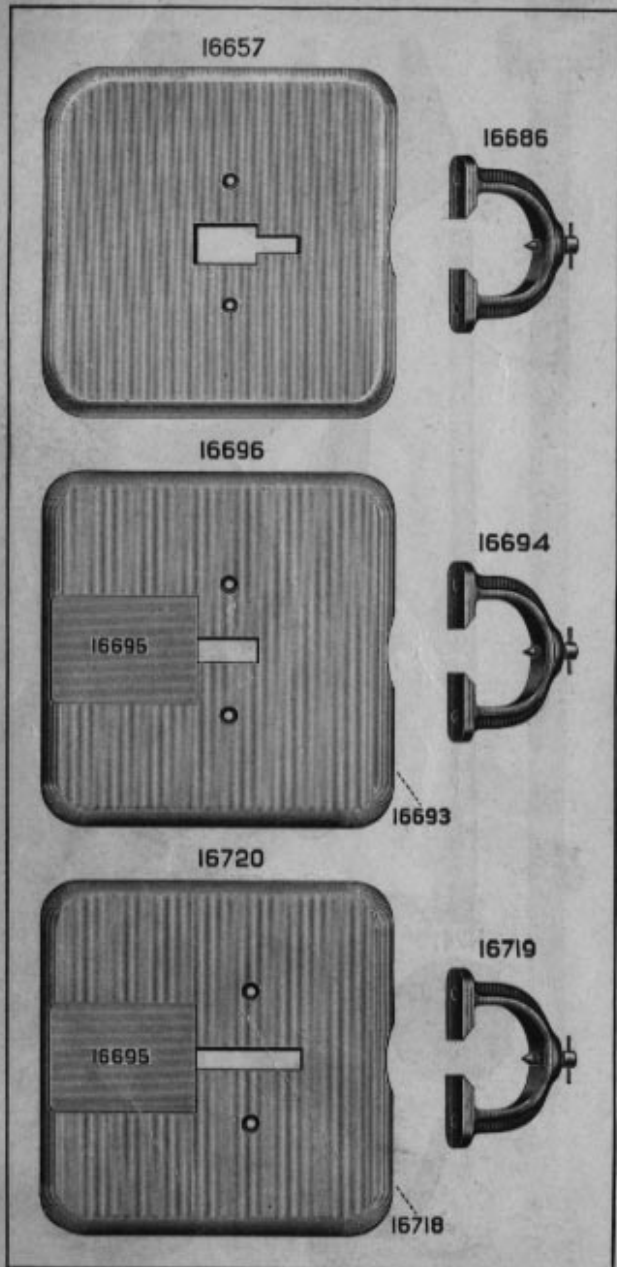


PLATE 384—ONE-FOURTH SIZE

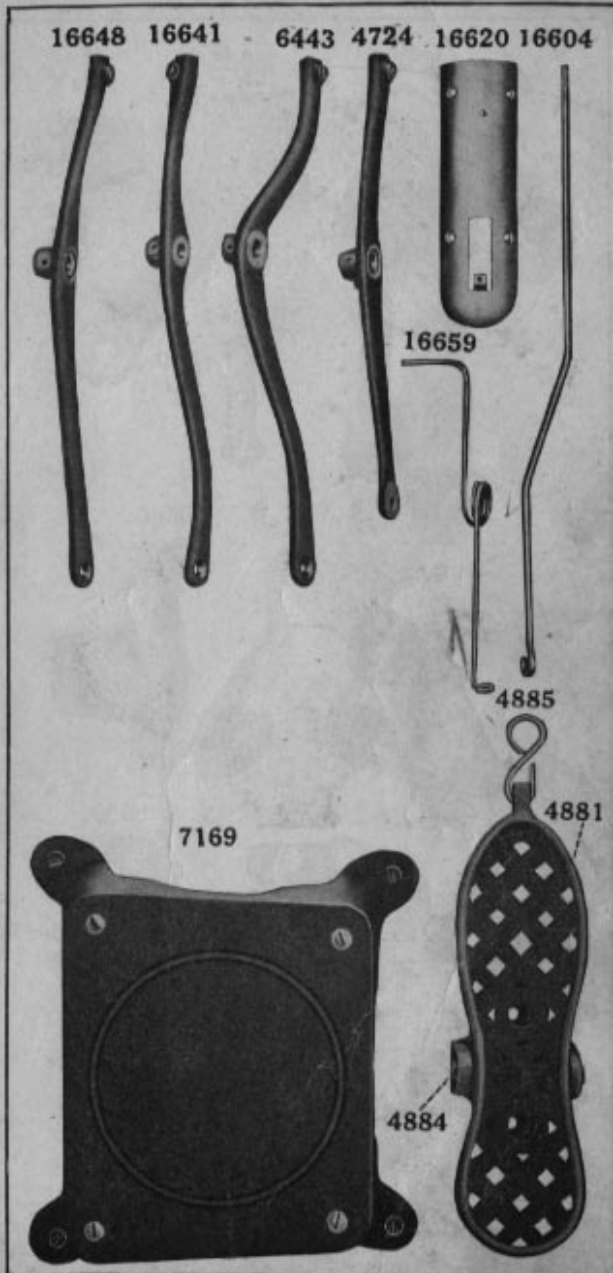


PLATE 385—FULL SIZE

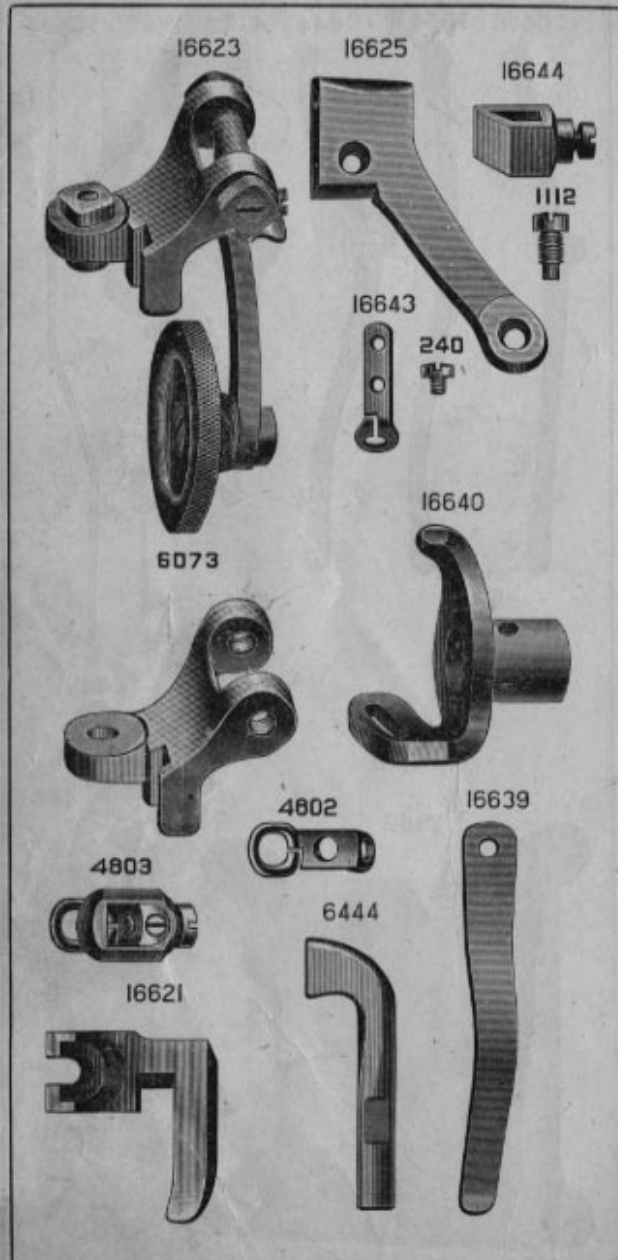


PLATE 386—FULL SIZE

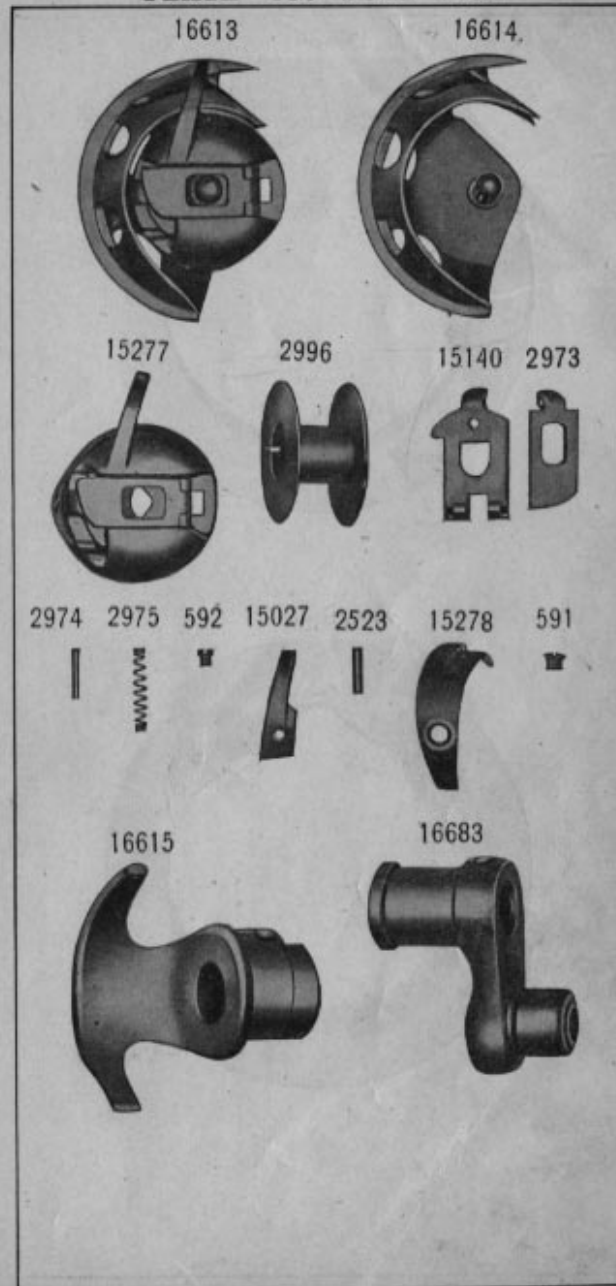


PLATE 387—FULL SIZE

16634



16651

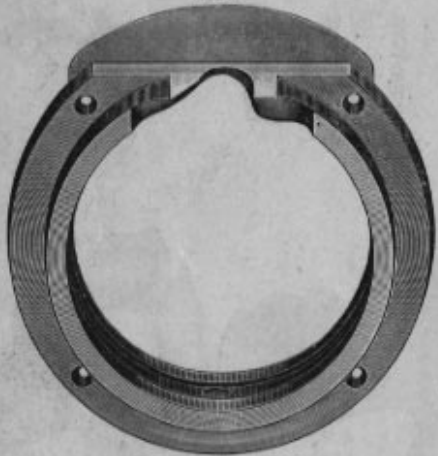
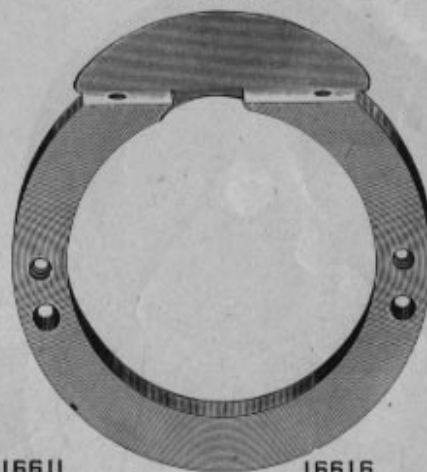


PLATE 388—FULL SIZE

16601



16611



16616



16677



16608



PLATE 389—FULL SIZE

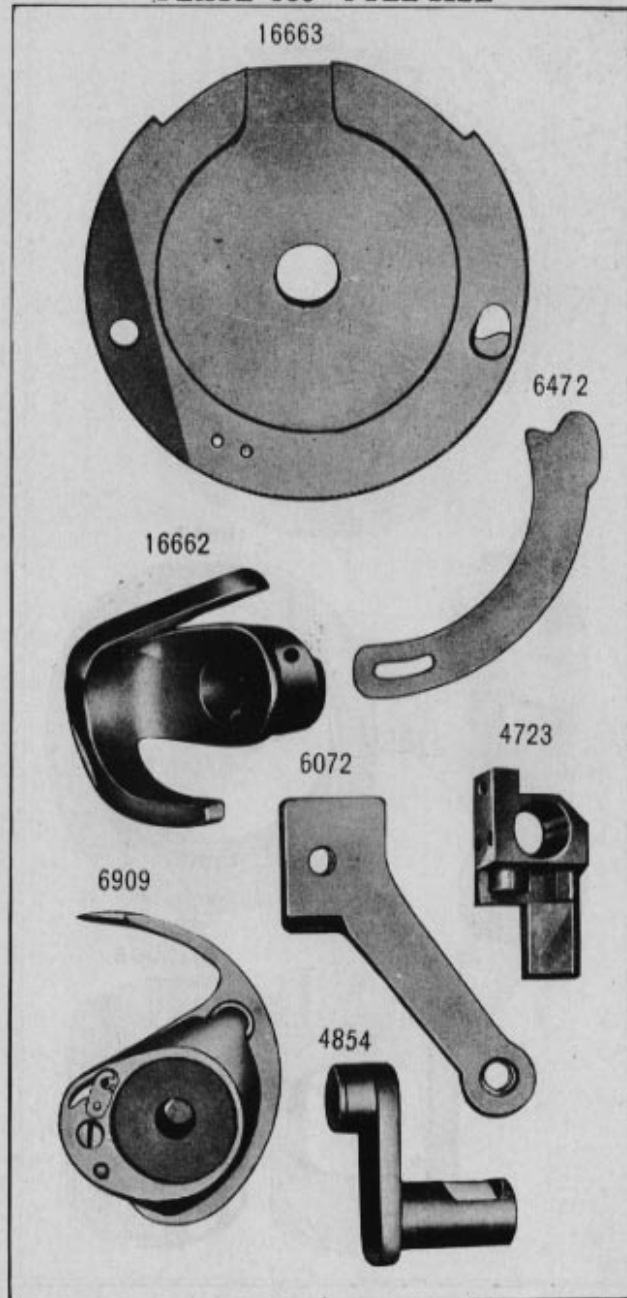


PLATE 1104—ONE-HALF SIZE

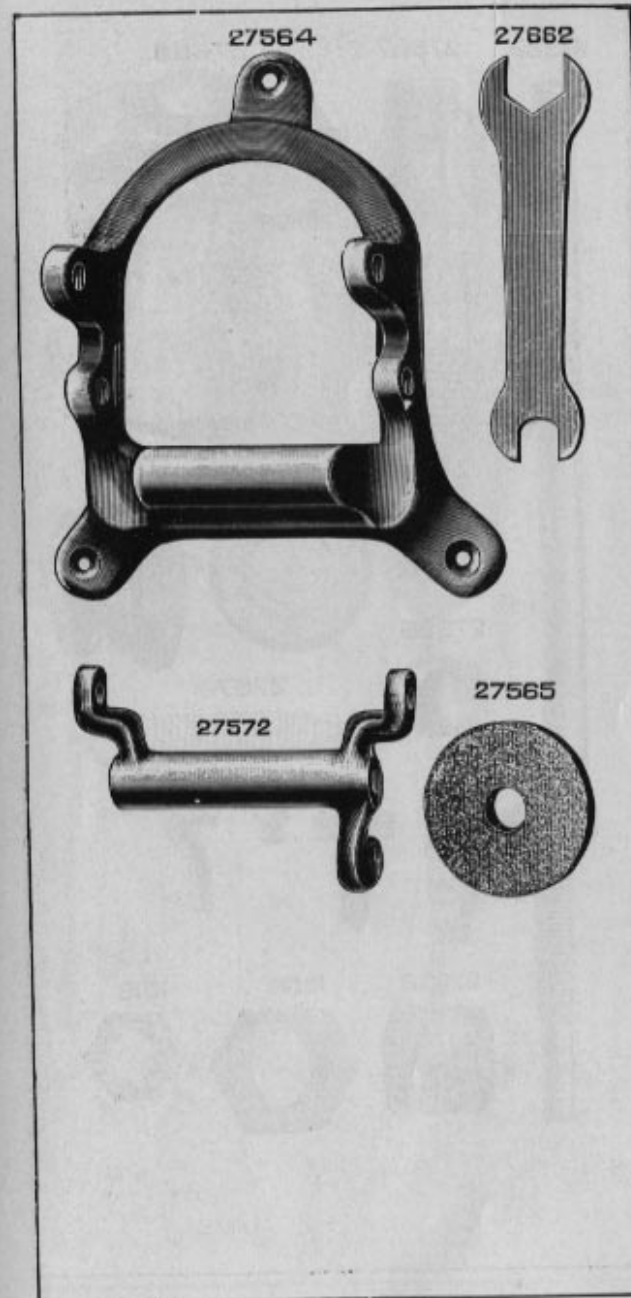


PLATE 1105—FULL SIZE

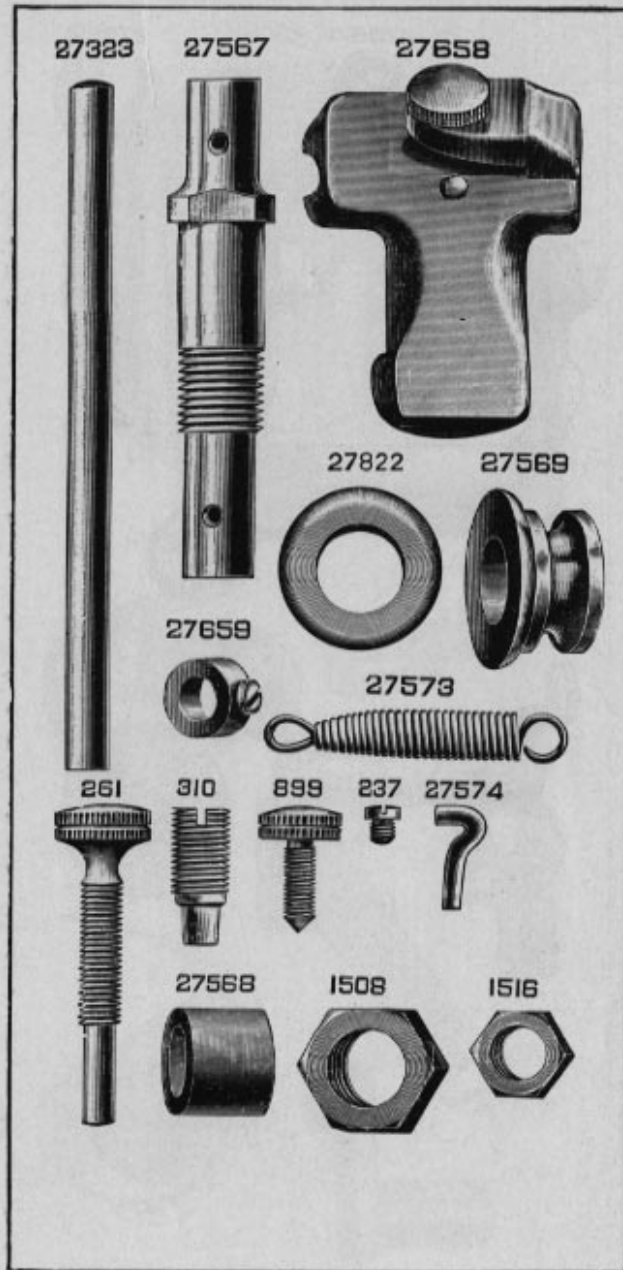


PLATE 1518—ONE-HALF SIZE

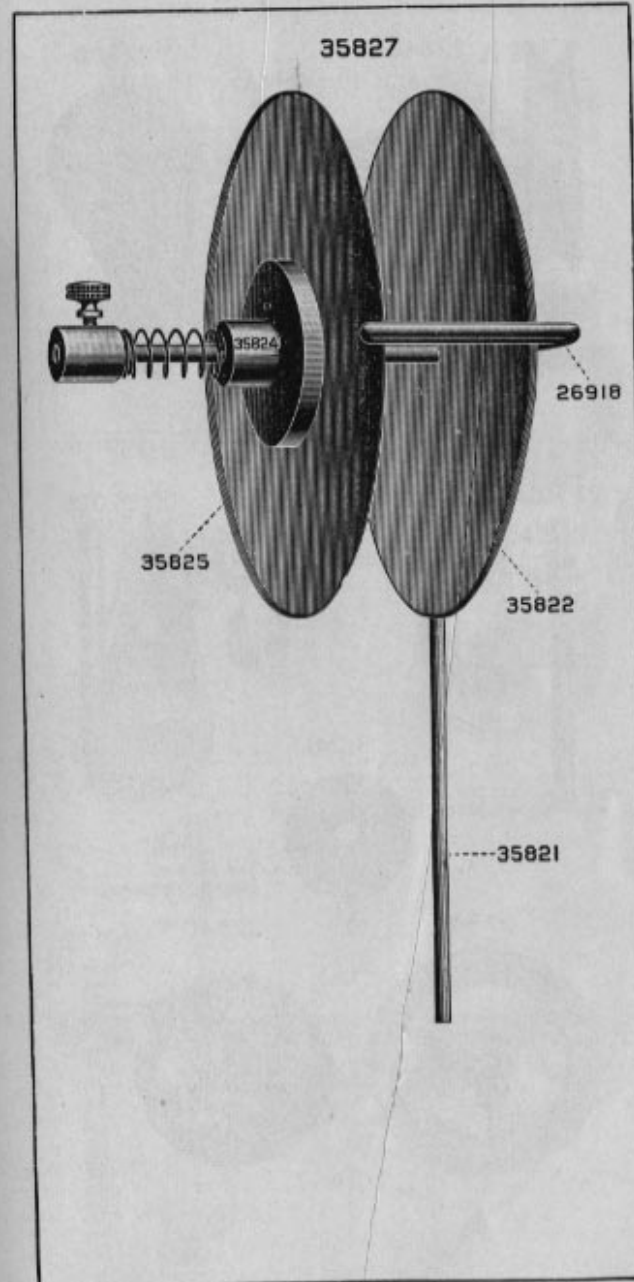


PLATE 1703—ONE-HALF SIZE

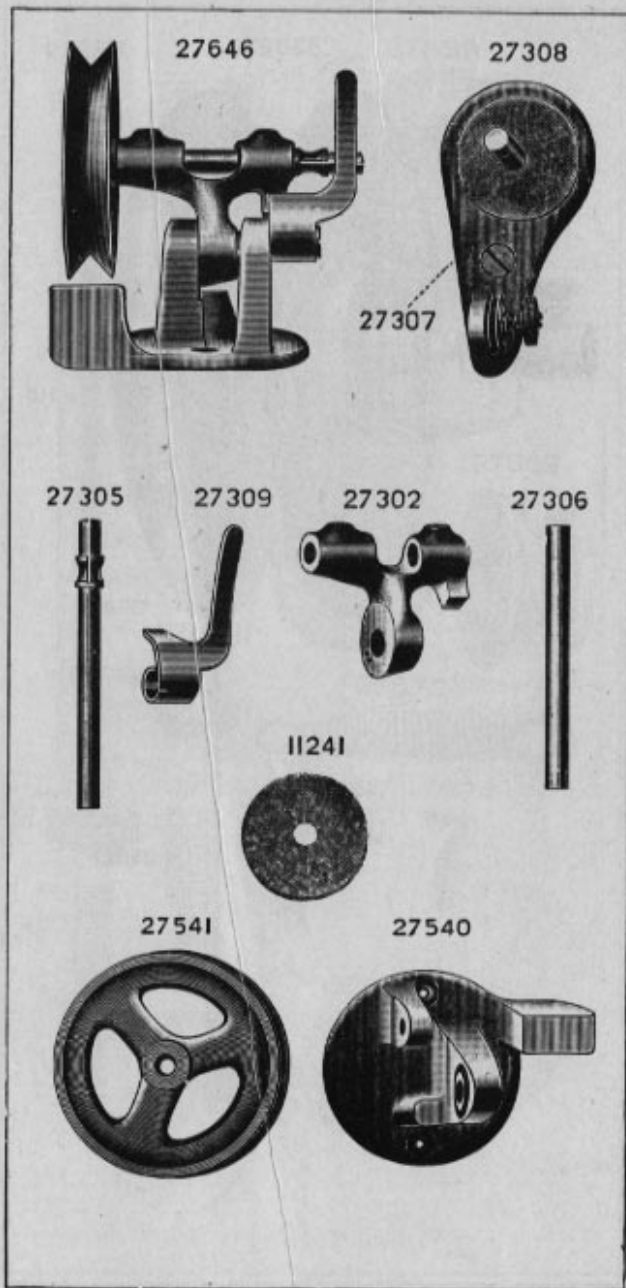


PLATE 2445—ONE-HALF SIZE

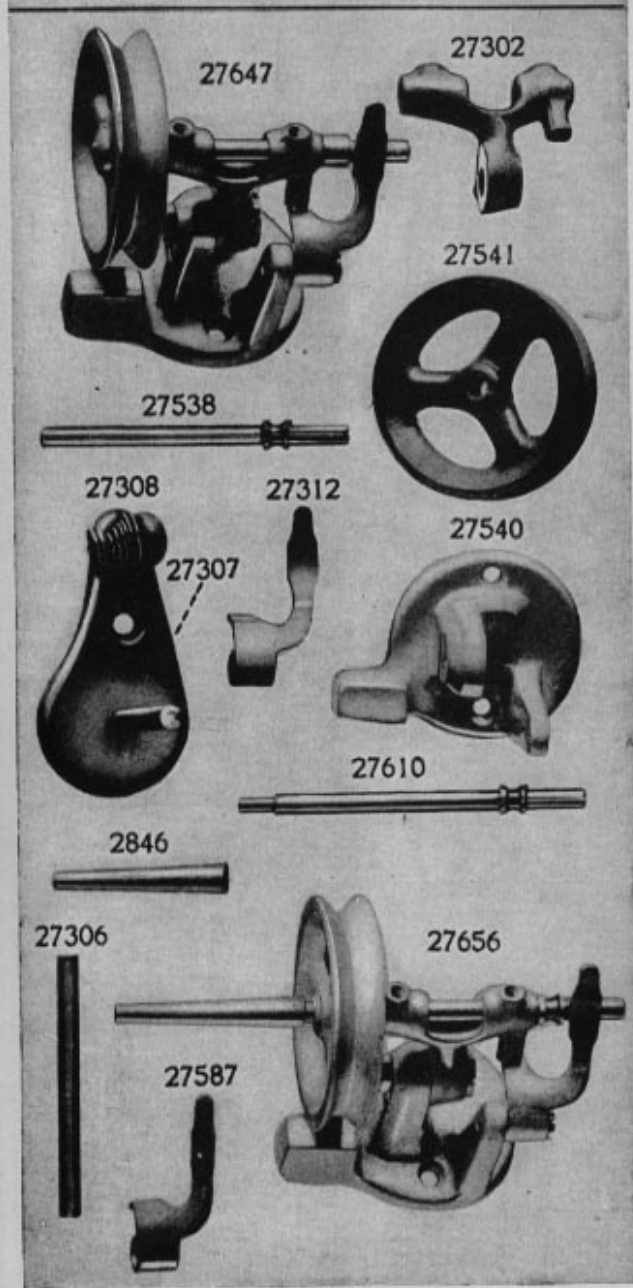


PLATE 3350—FULL SIZE

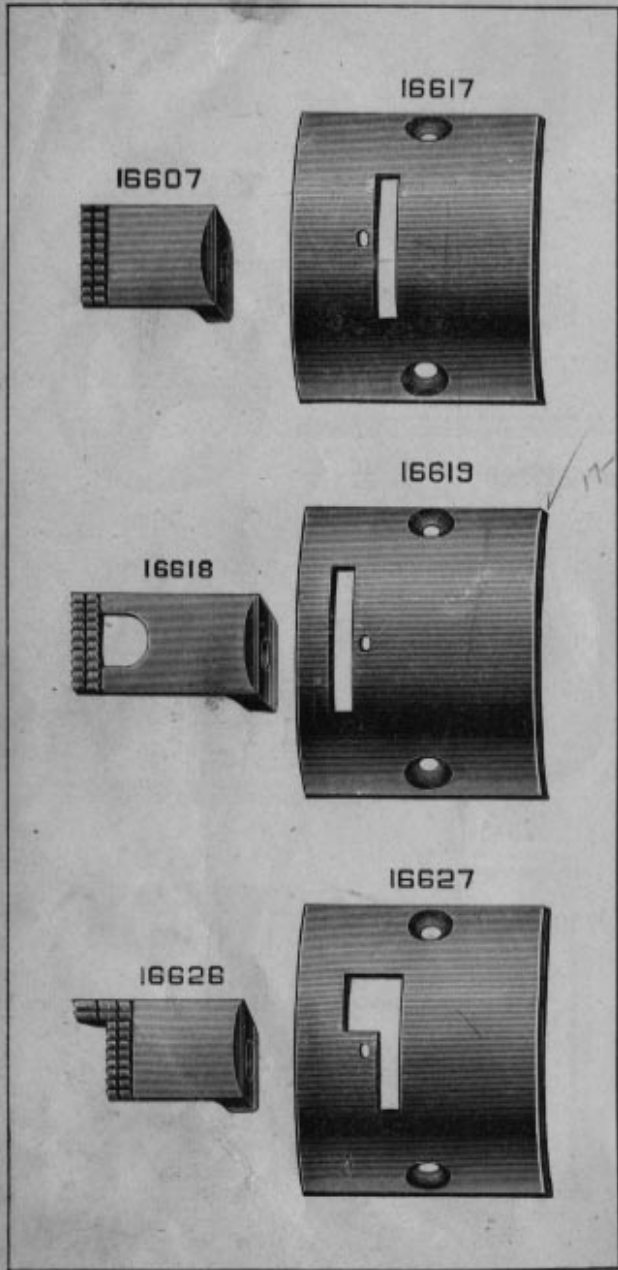


PLATE 3351—FULL SIZE

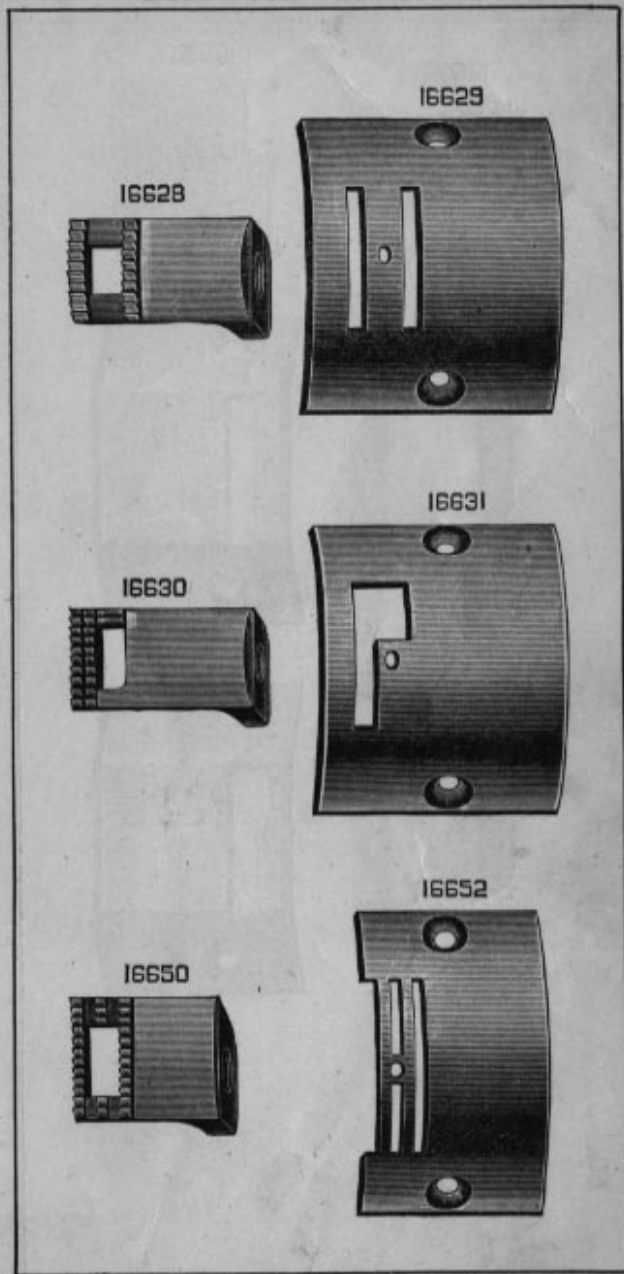


PLATE 3352—FULL SIZE

16632



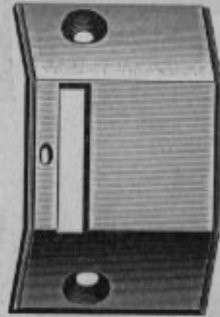
16633



16661



16664



16672



16673

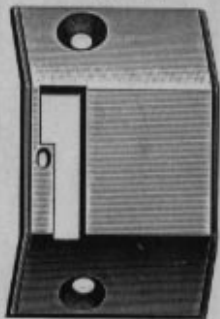
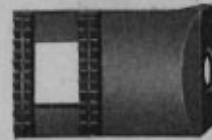
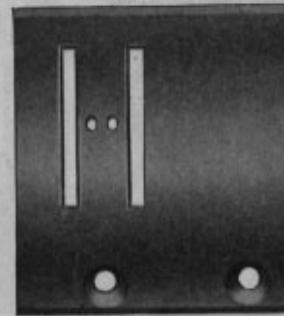


PLATE 3353—FULL SIZE

6183



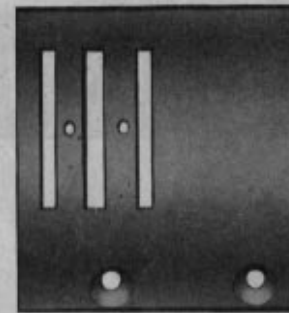
6248



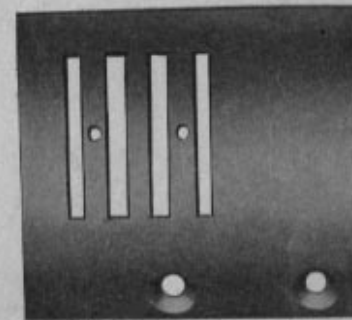
6184



6254



16763



16762

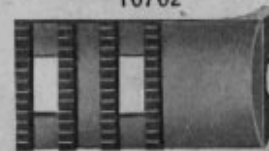
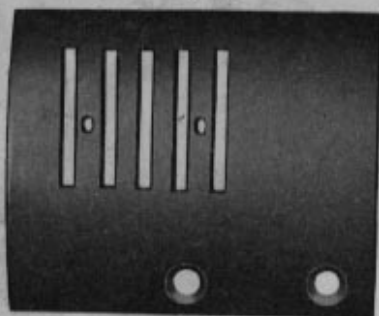


PLATE 3354—FULL SIZE

16765



16764

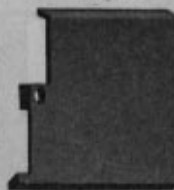


PLATE 3355—FULL SIZE

6300



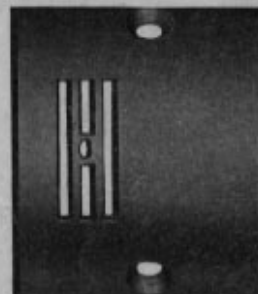
16714



16684



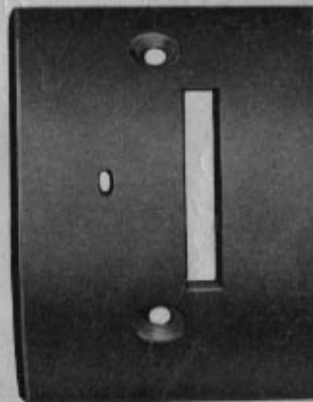
16675



16674



16798



16786



PLATE 3356—FULL SIZE

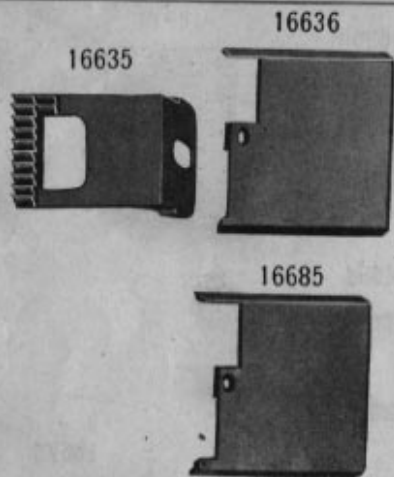


PLATE 3357—FULL SIZE

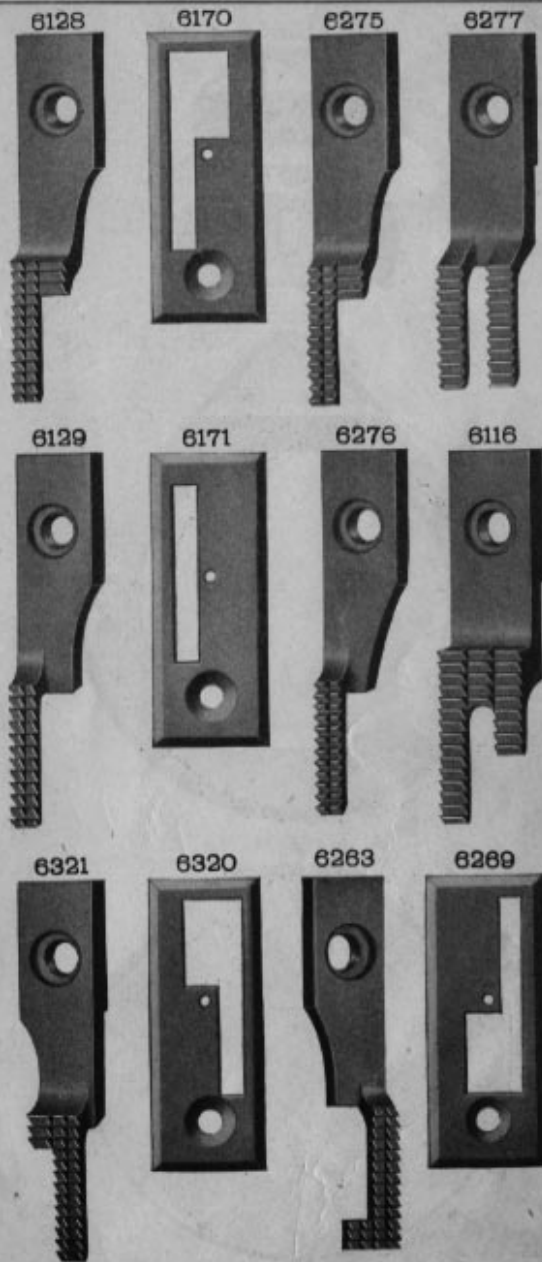


PLATE 3361—FULL SIZE

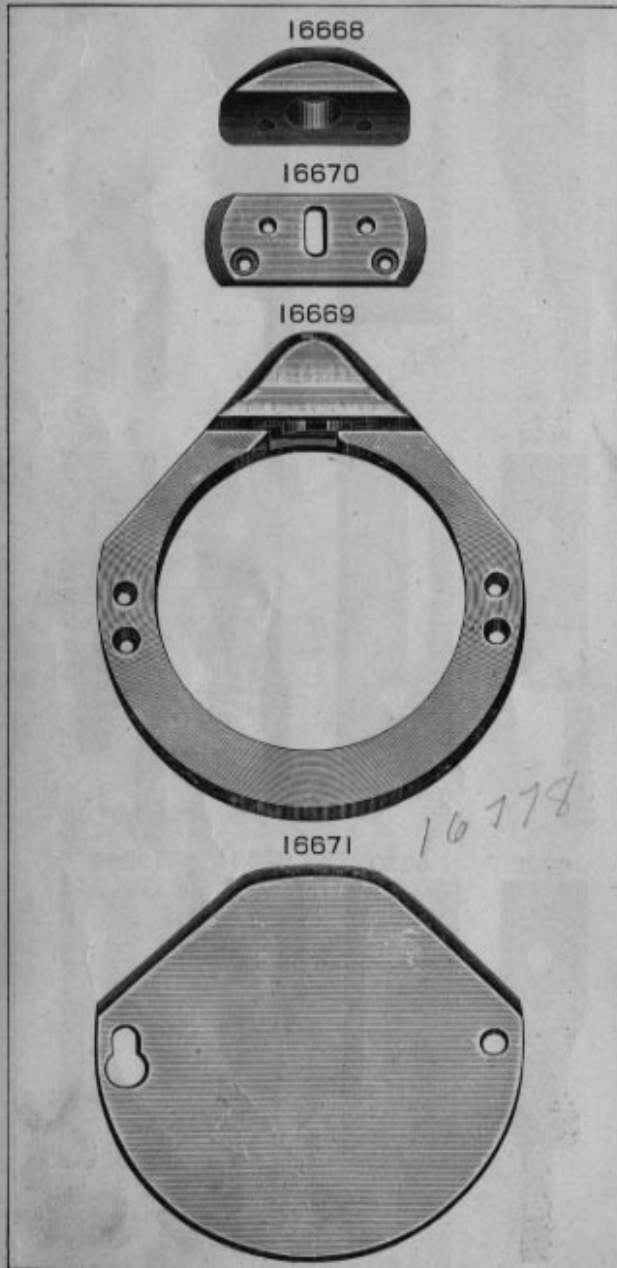


PLATE 3362—FULL SIZE

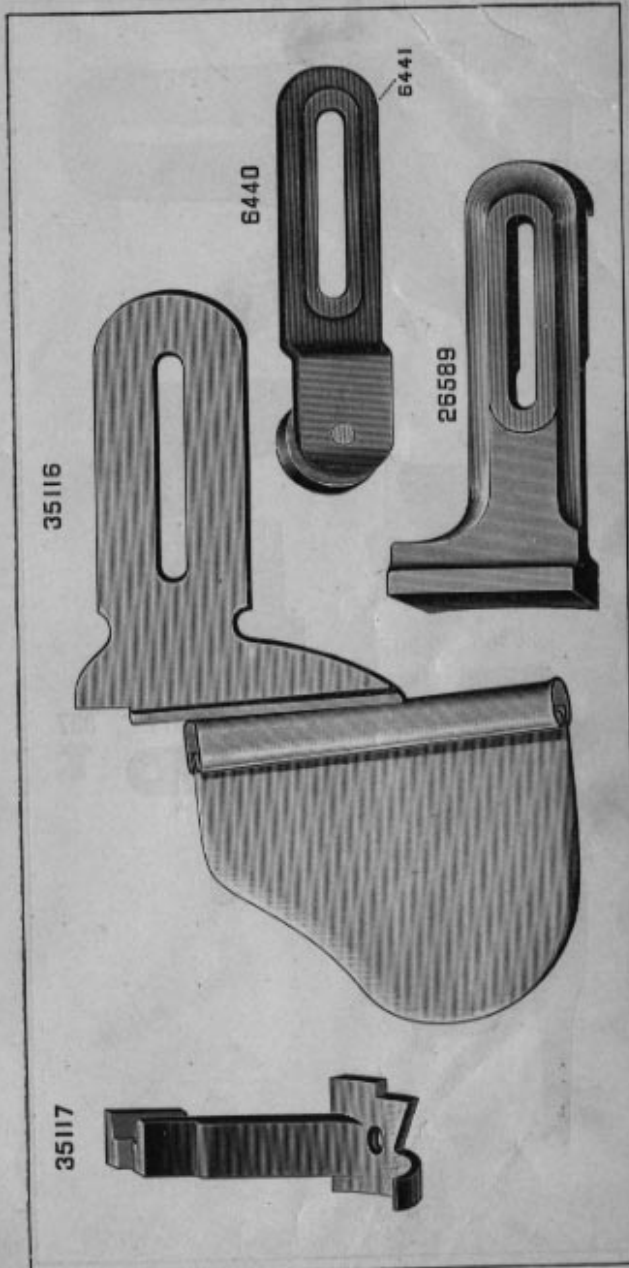


PLATE 3363—FULL SIZE

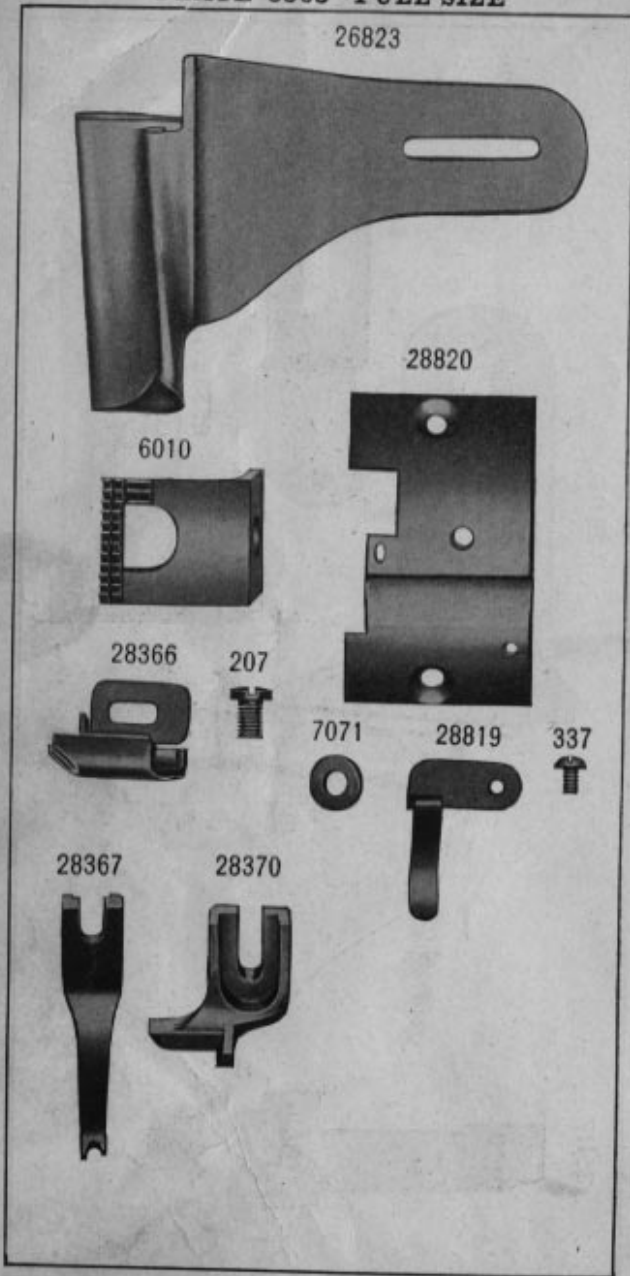


PLATE 3364—ONE-FOURTH SIZE

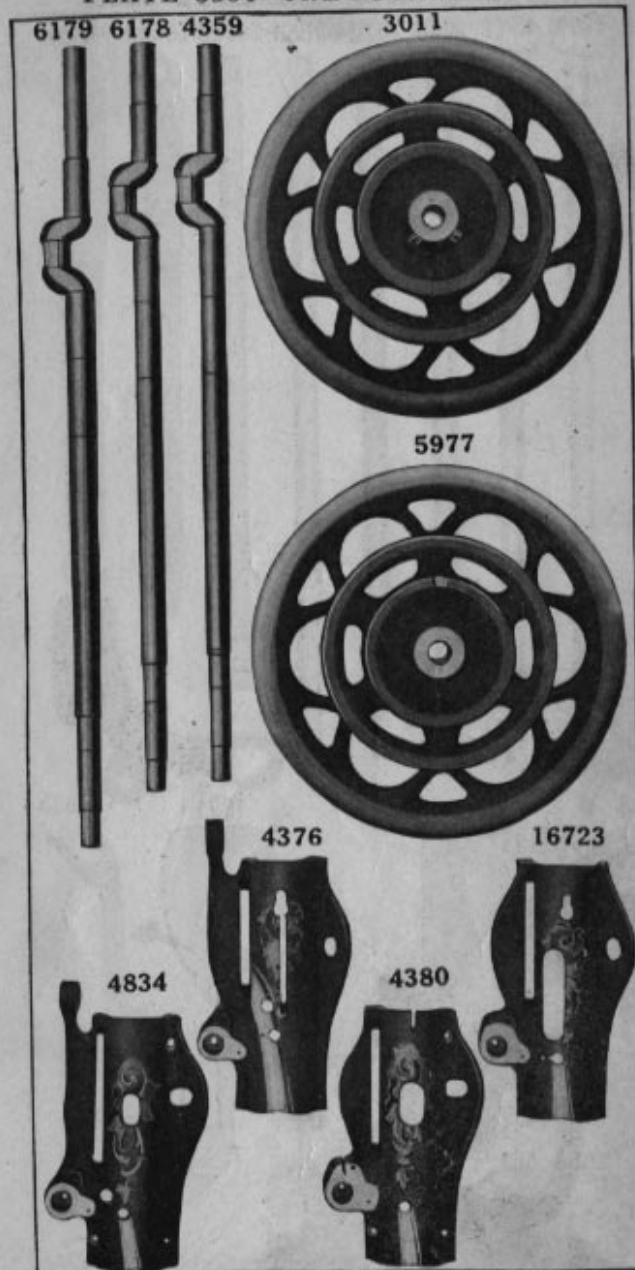


PLATE 3365—ONE-HALF SIZE

7299 4344 7060 16724 2058 16728 16780 16789

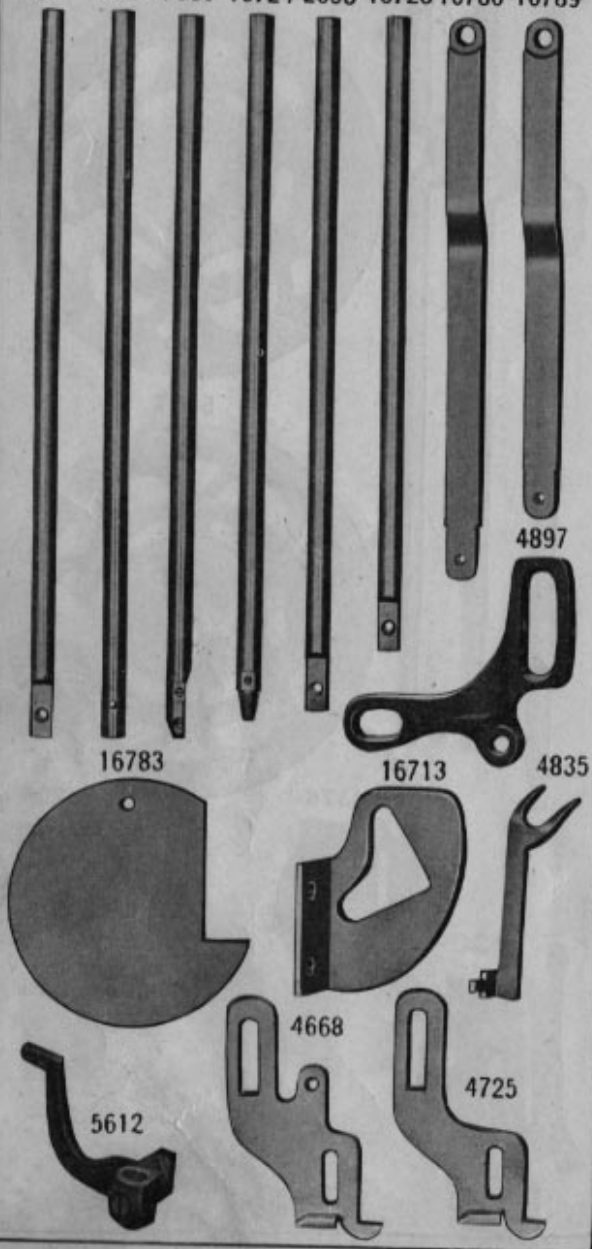


PLATE 3366—ONE-HALF SIZE

7044 6462 16681 16754 4908 5550 16745

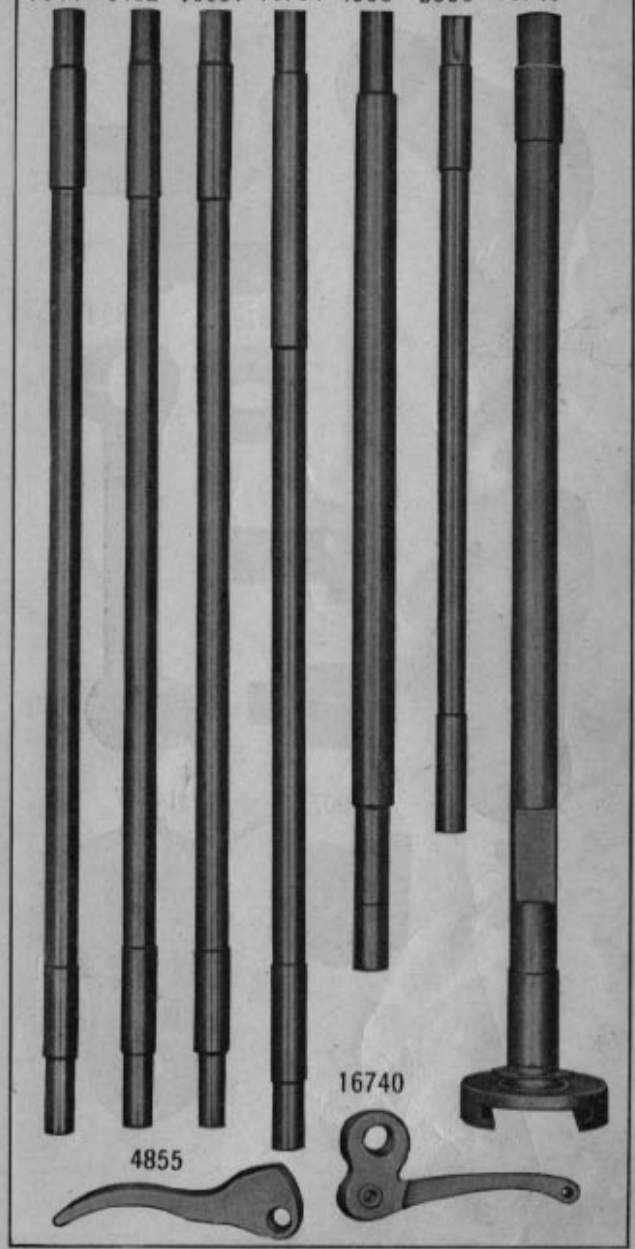


PLATE 3367—FULL SIZE

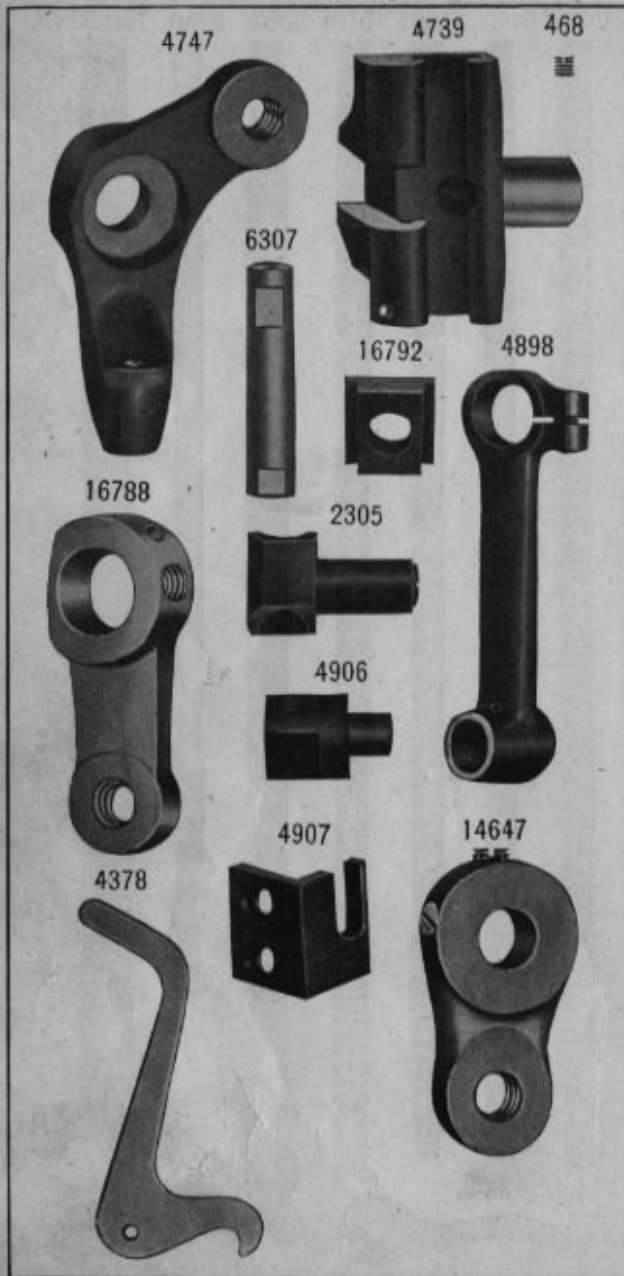


PLATE 3368—ONE-HALF SIZE

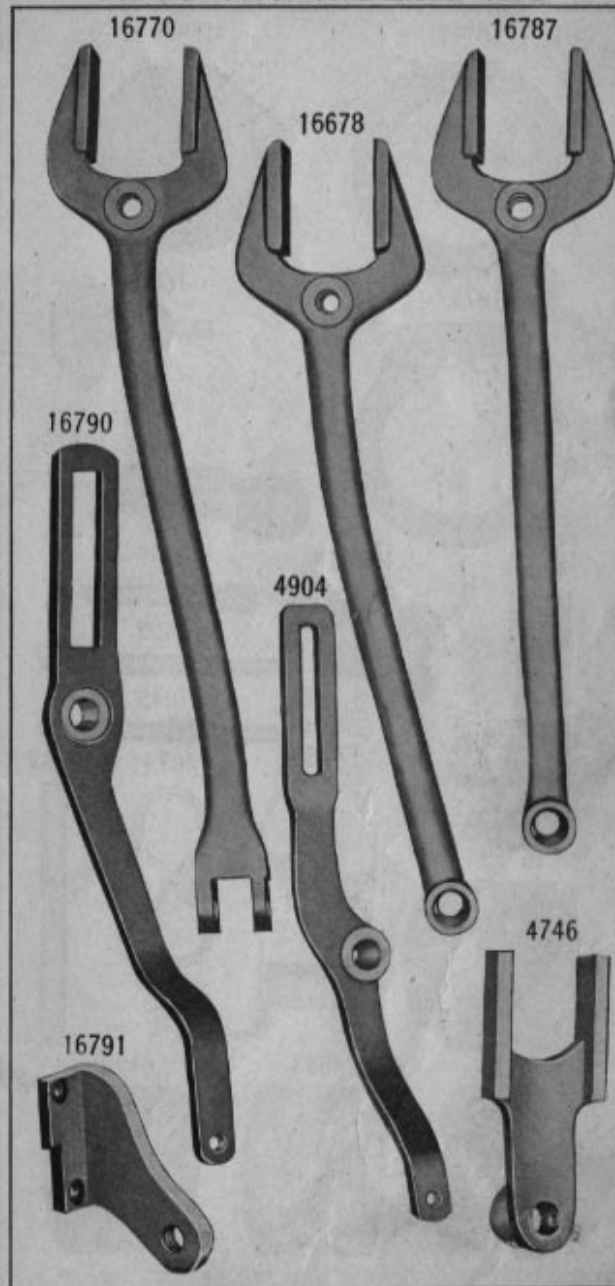


PLATE 3369—ONE-HALF SIZE

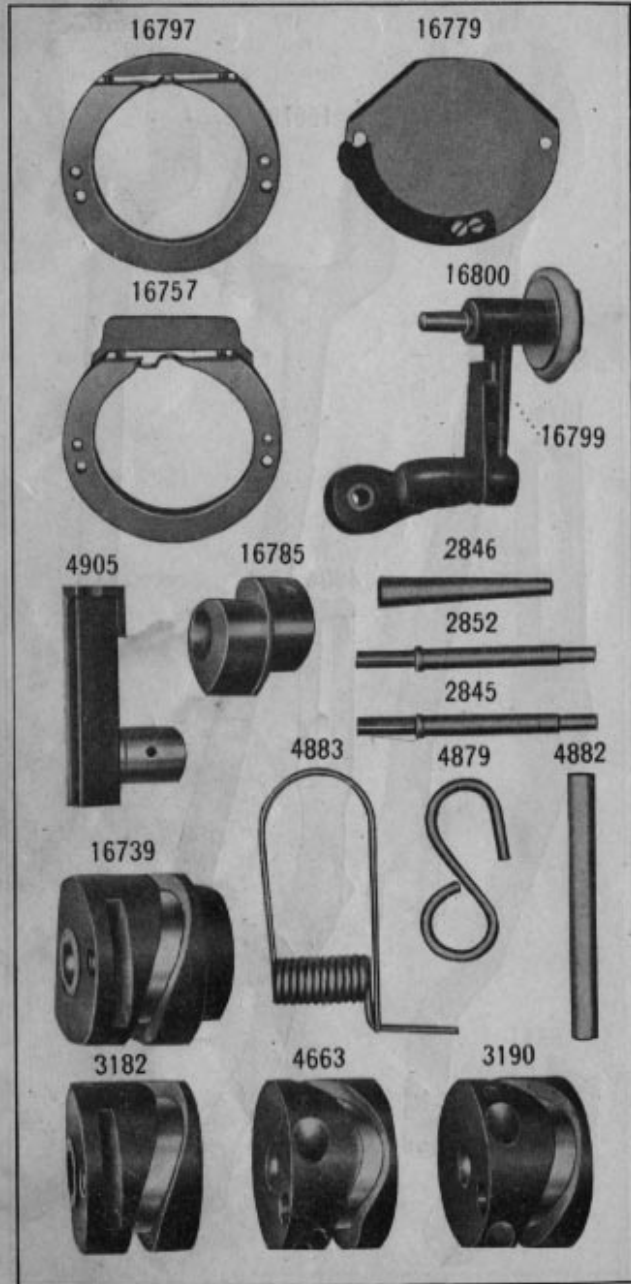


PLATE 3370—ONE-HALF SIZE

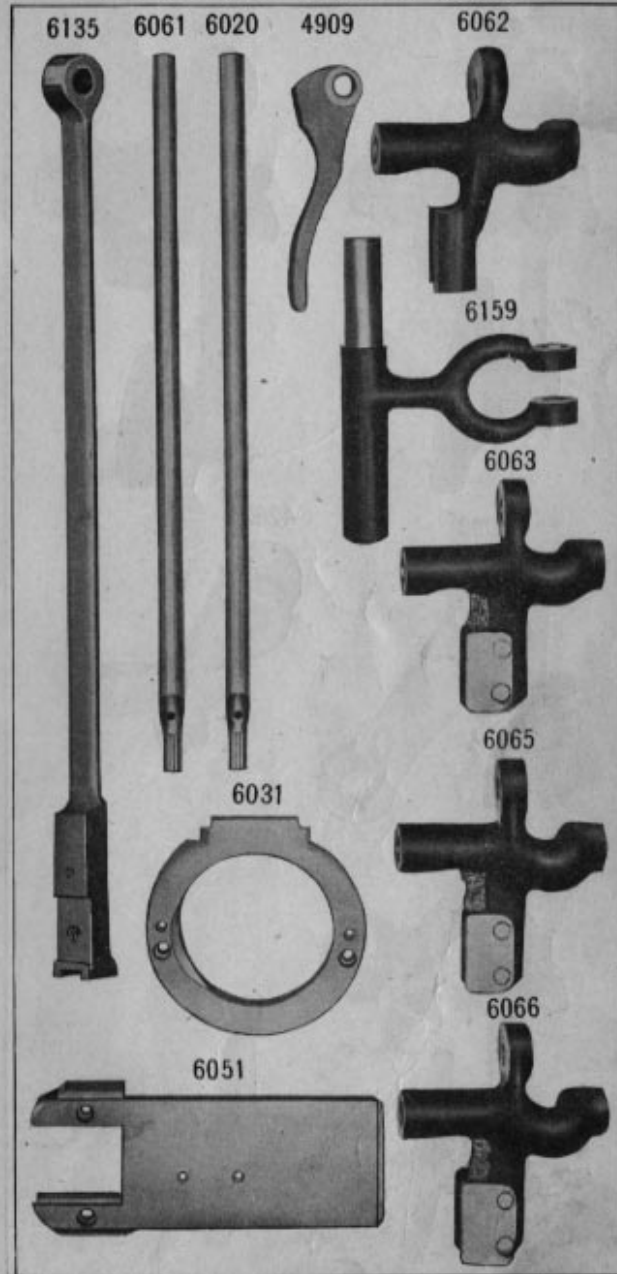


PLATE 3371—FULL SIZE

16099



2196



16098



4282



16755



1987



PLATE 3372—FULL SIZE

4790



1854



4785



3222



4786



4789



7556



PLATE 3373—FULL SIZE

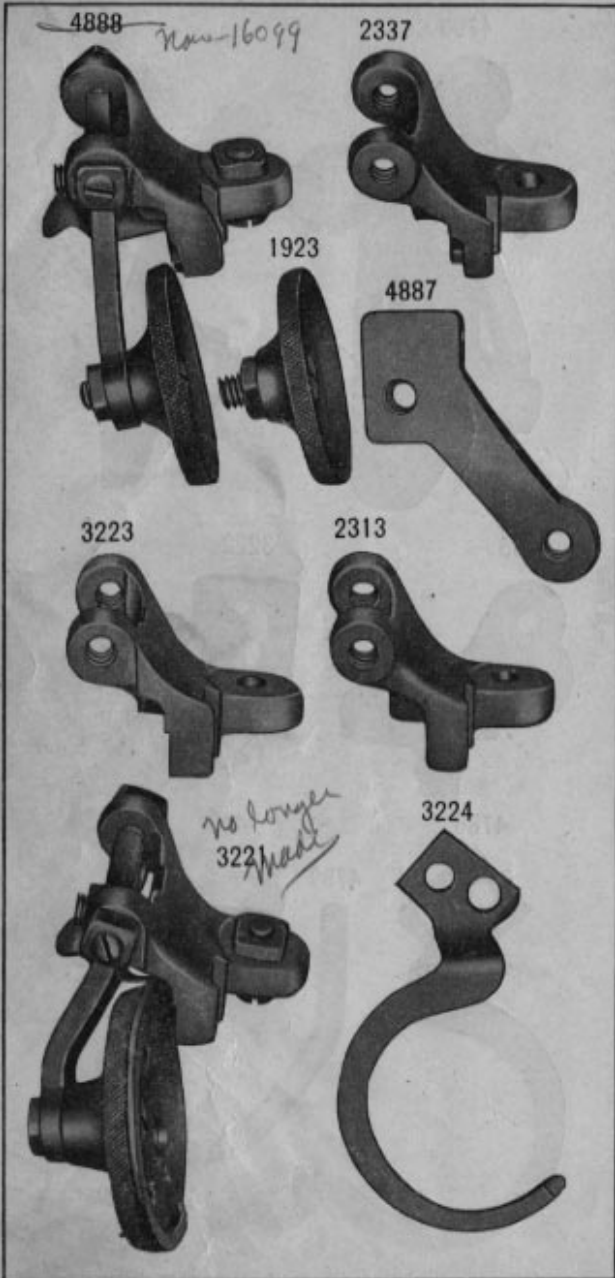


PLATE 3374—FULL SIZE

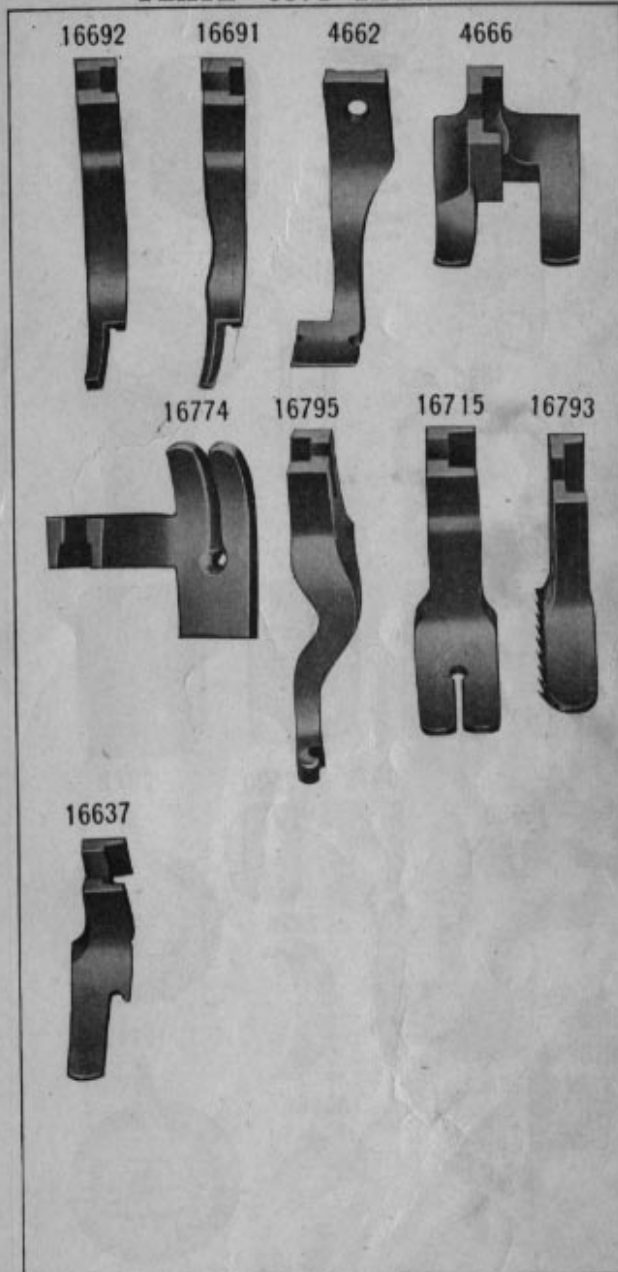


PLATE 3375—FULL SIZE

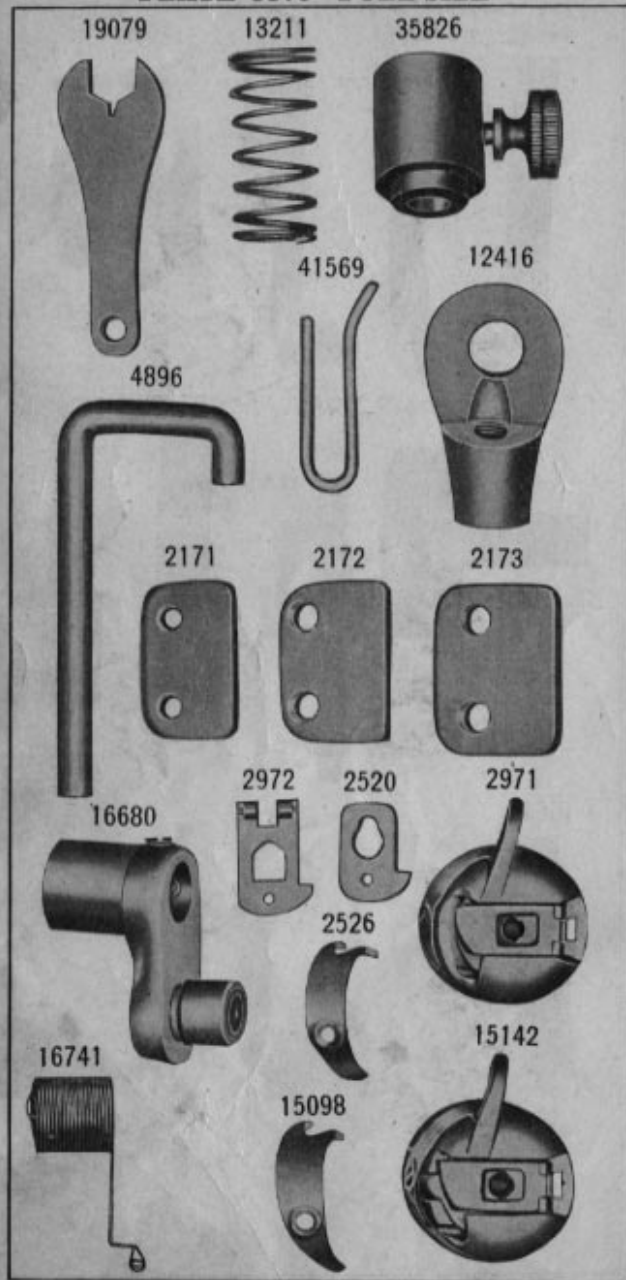


PLATE 3376—FULL SIZE

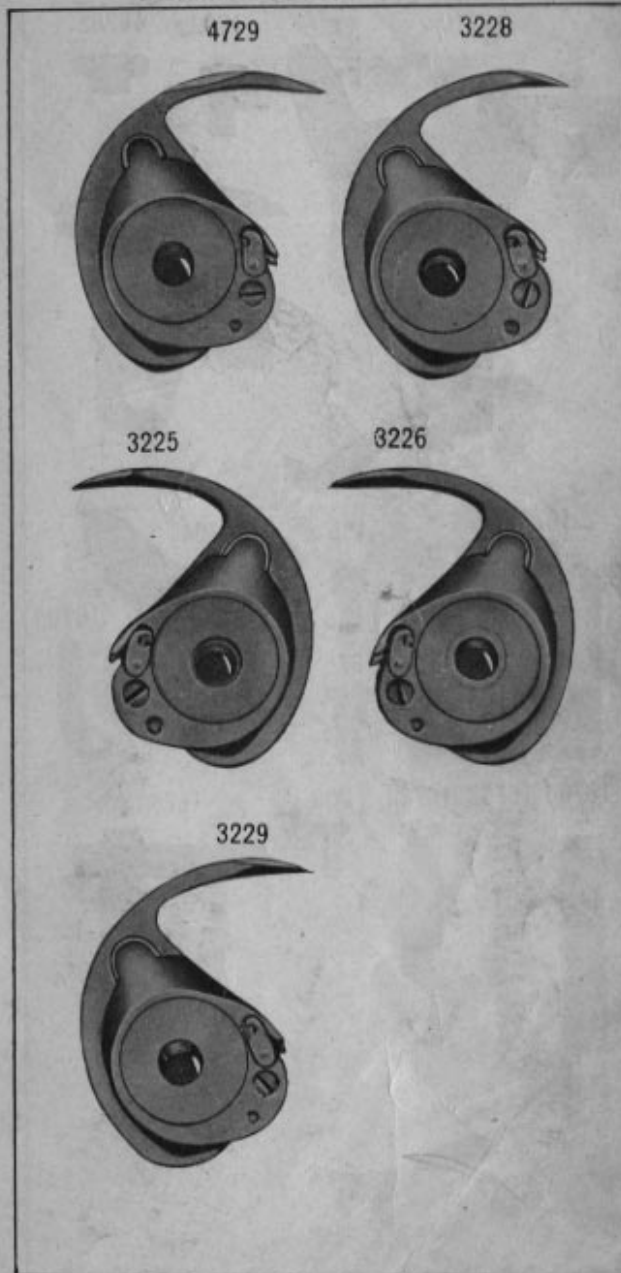


PLATE 3377—FULL SIZE

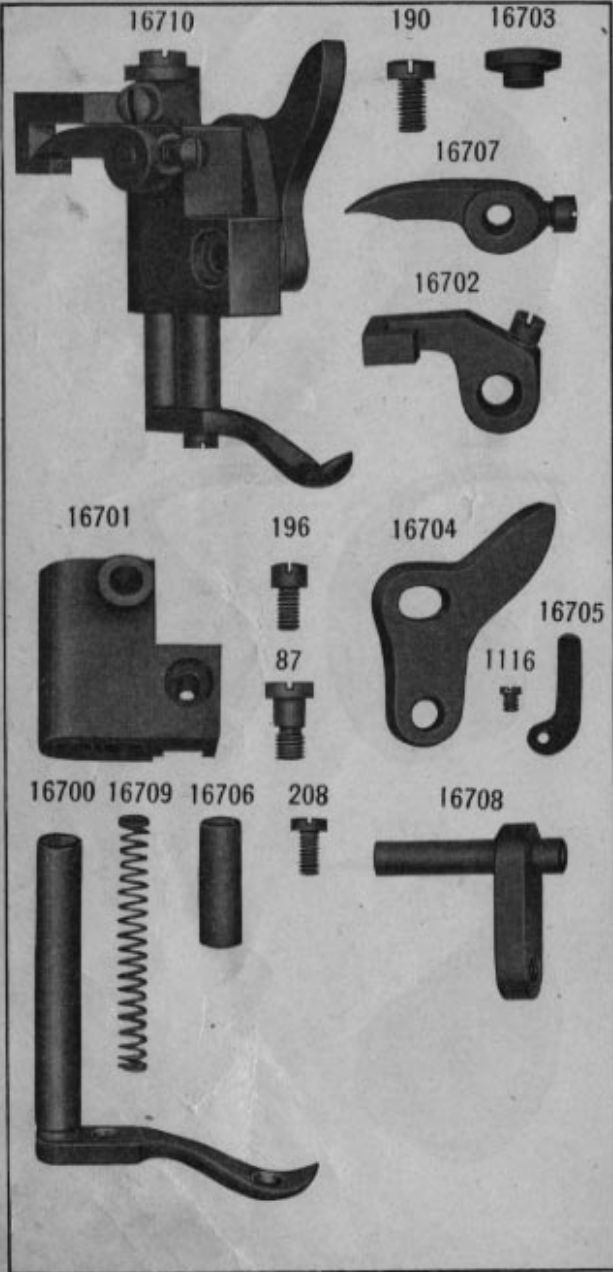


PLATE 3378—FULL SIZE

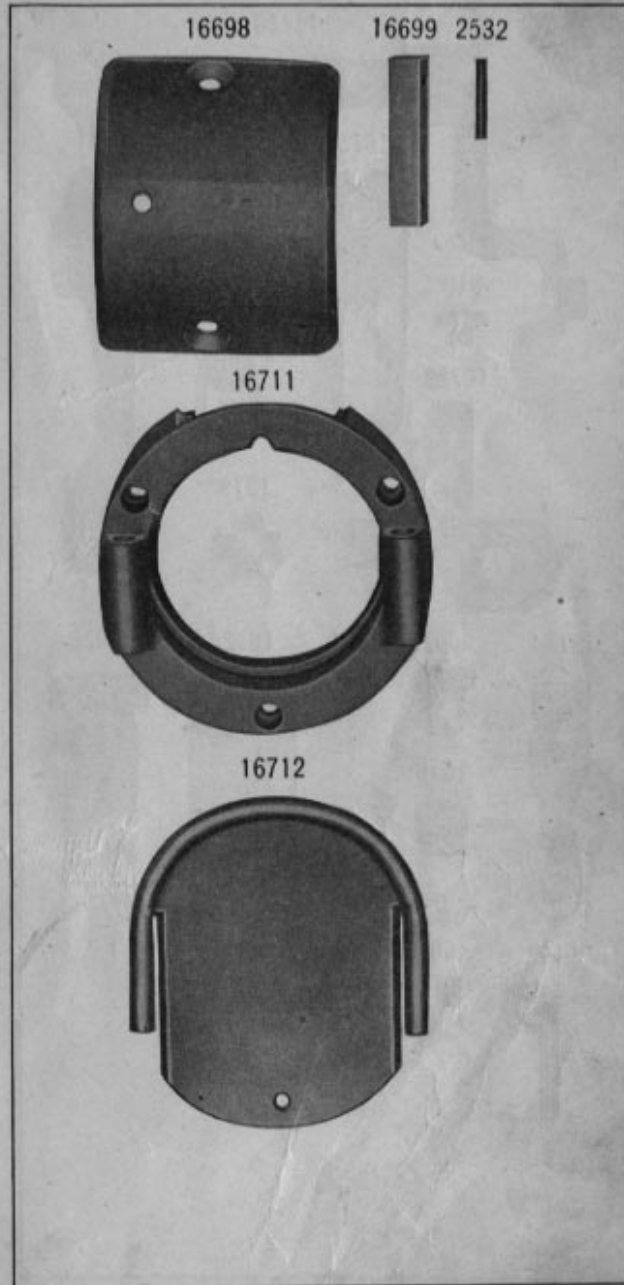


PLATE 3379—FULL SIZE

65039

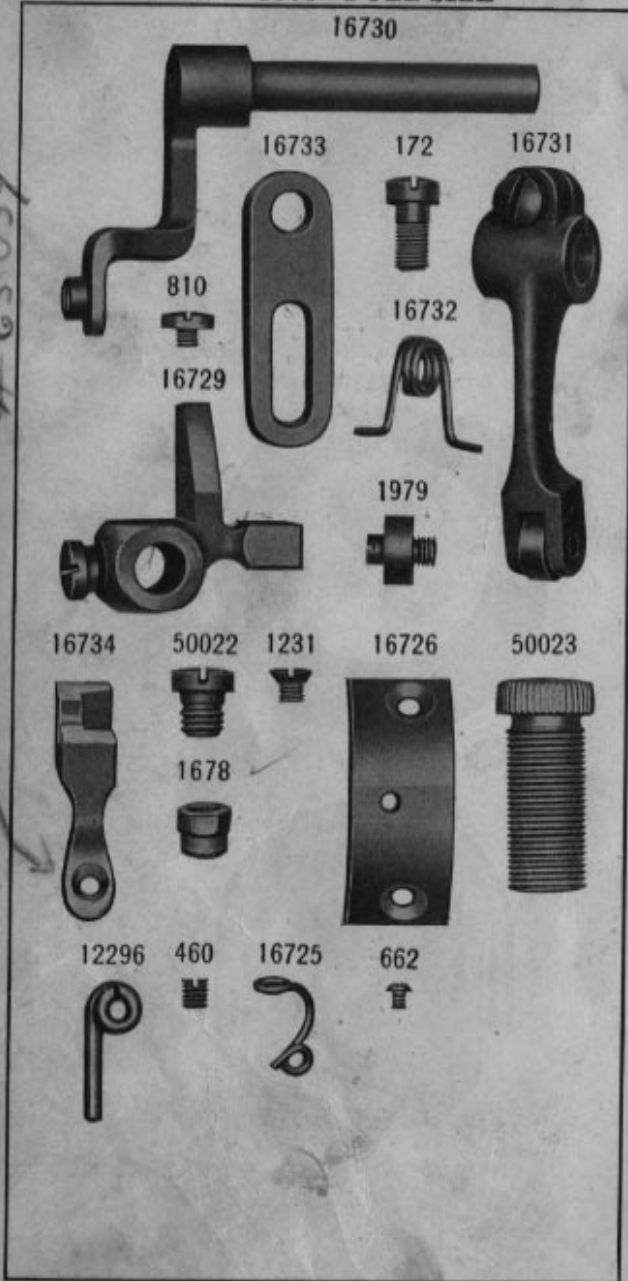


PLATE 3380—FULL SIZE

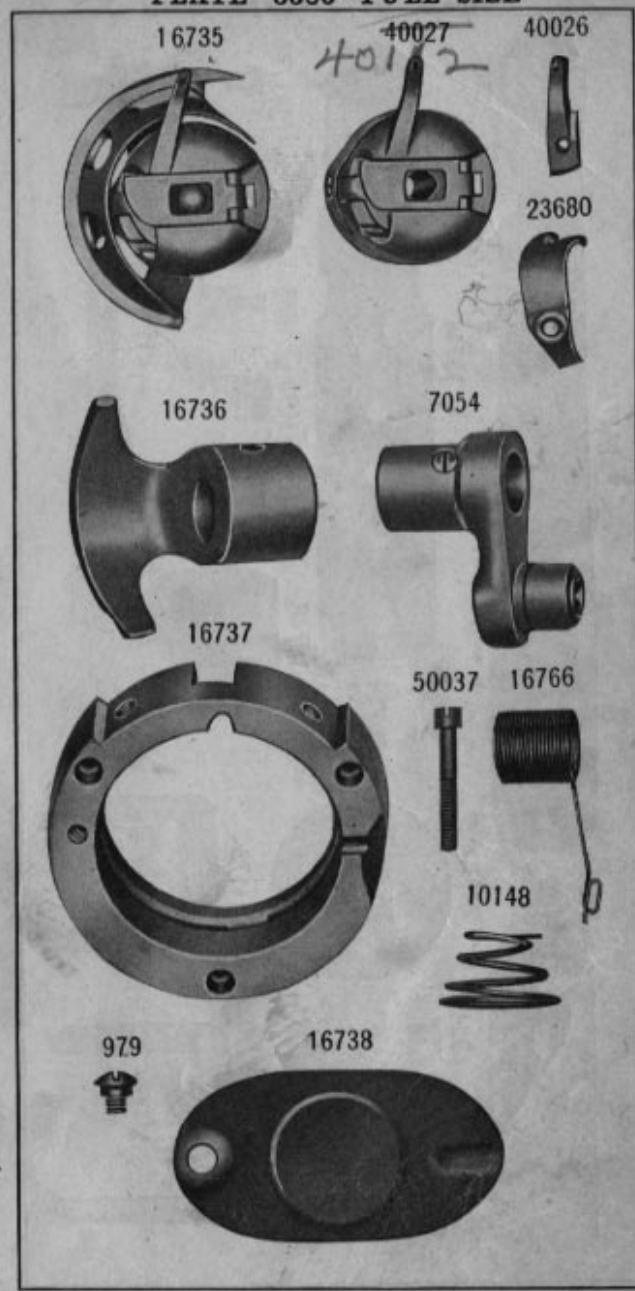


PLATE 3381-FULL SIZE

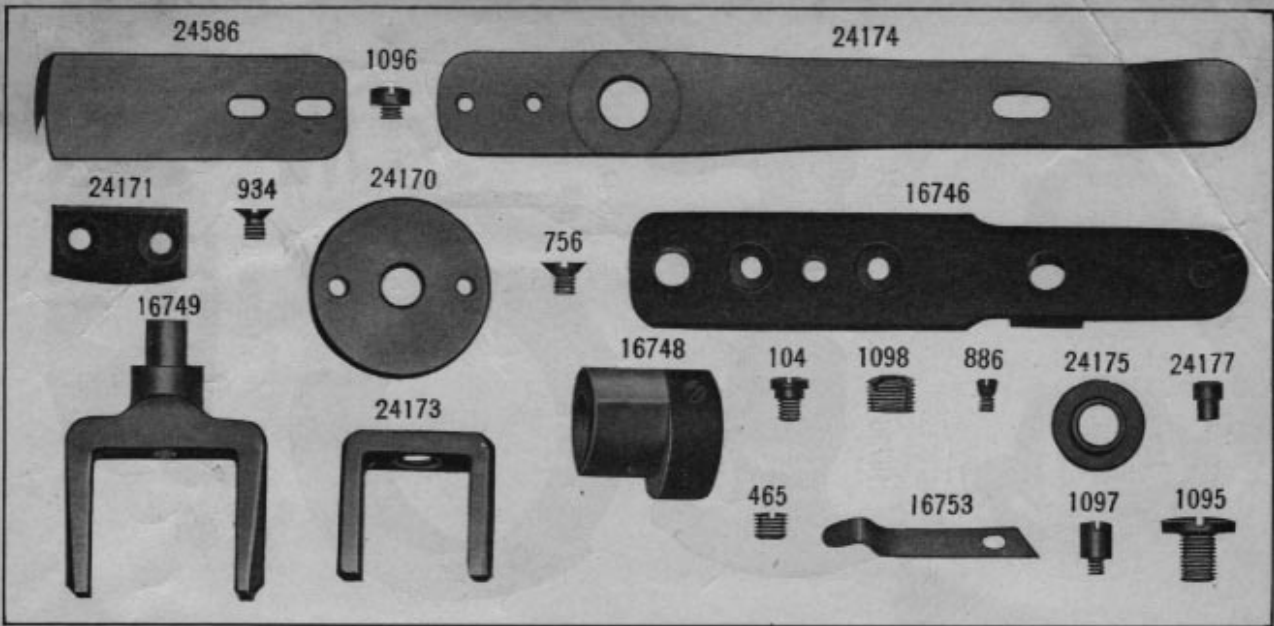


PLATE 3382-FULL SIZE

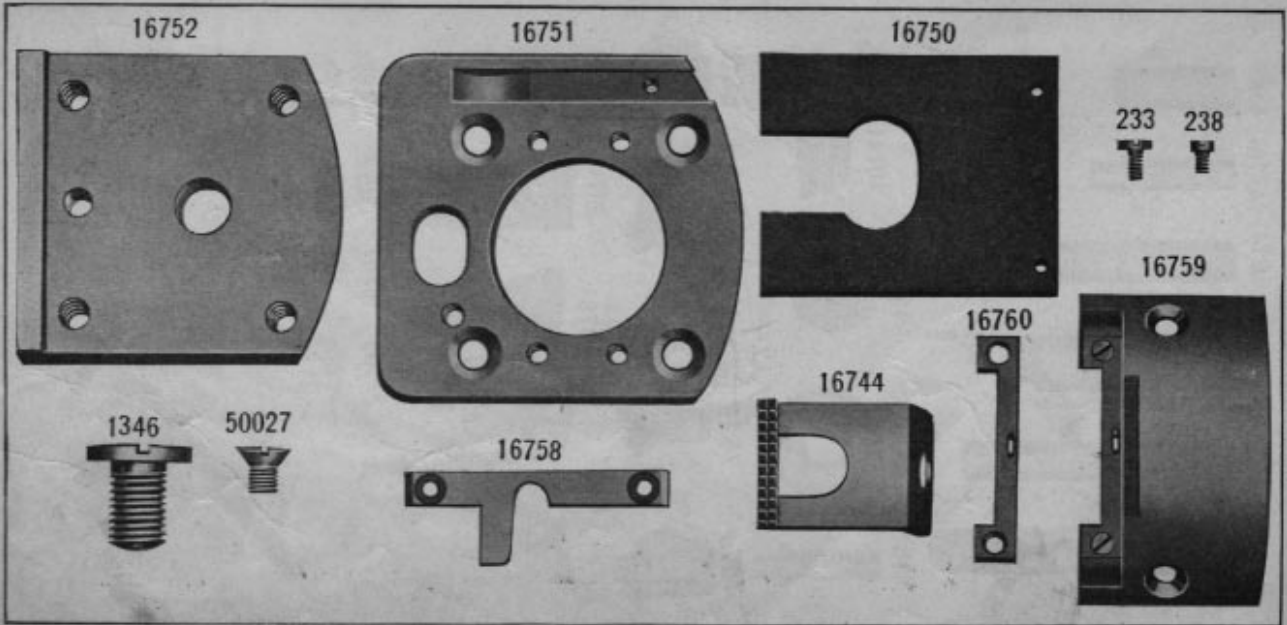


PLATE 3383—FULL SIZE



PLATE 3384—FULL SIZE

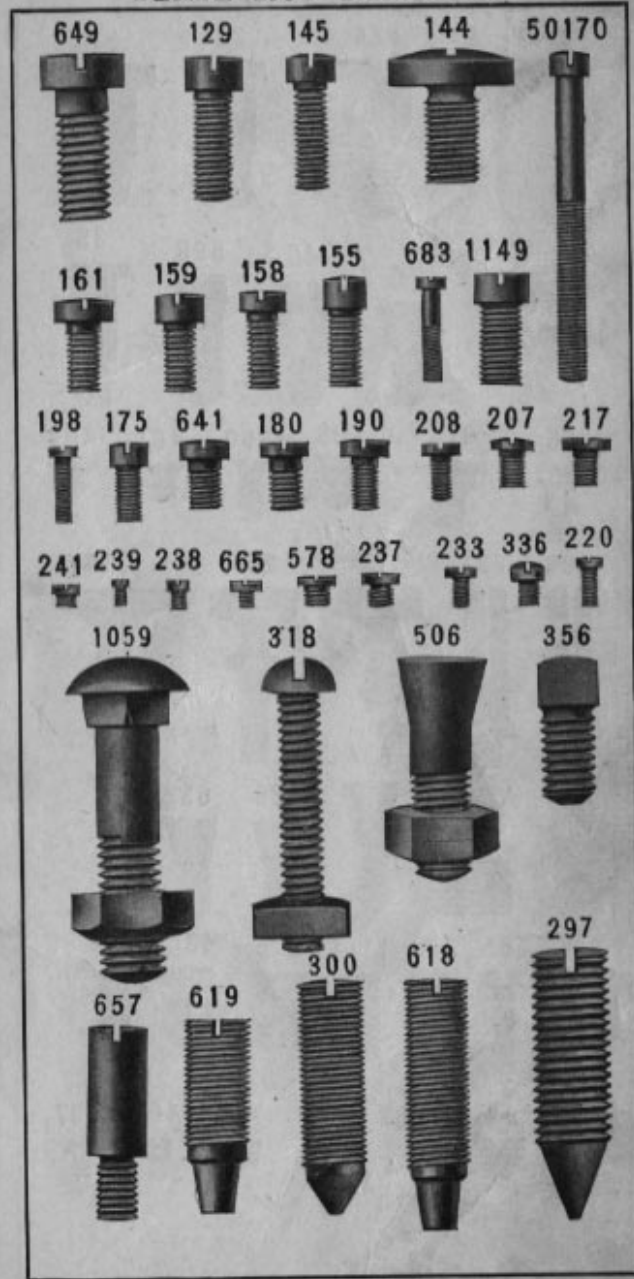


PLATE 3385—FULL SIZE



PLATE 3386—FULL SIZE

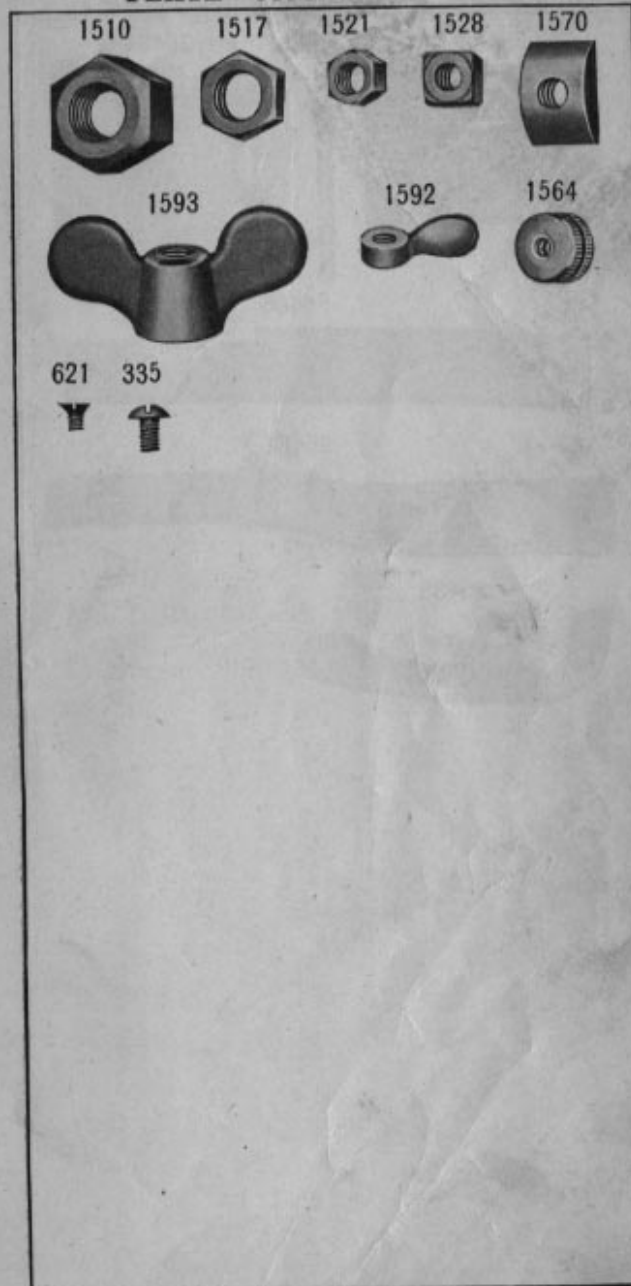


PLATE 3387—ONE-HALF SIZE

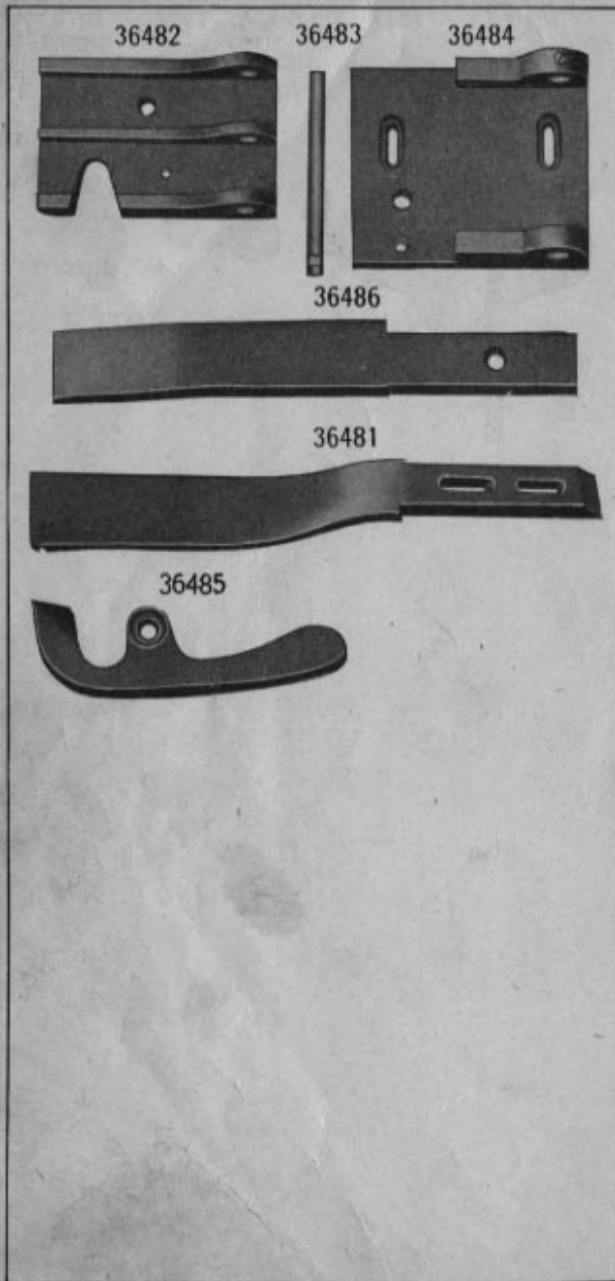


PLATE 3388—FULL SIZE

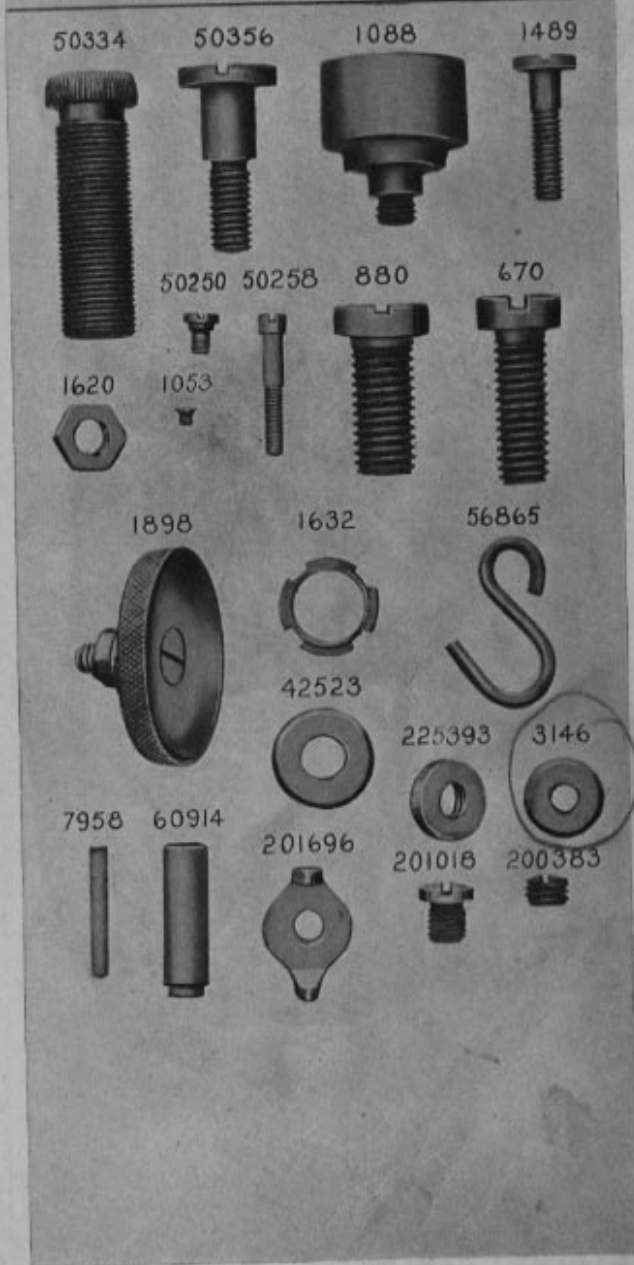
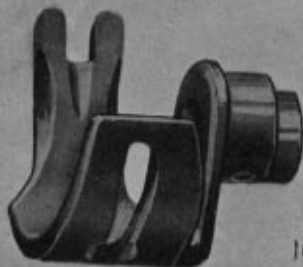


PLATE 3389—FULL SIZE

65024



15472



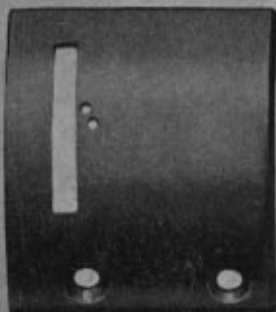
26276 16826



16810



65035



65010



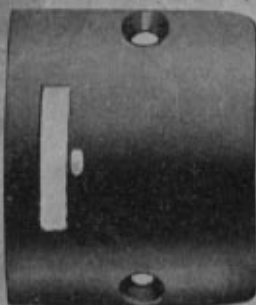
16815



16813



65029



16862

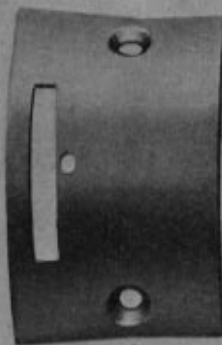


16884



PLATE 3390—FULL SIZE

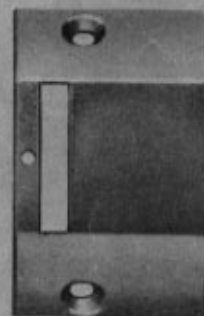
16844



16843



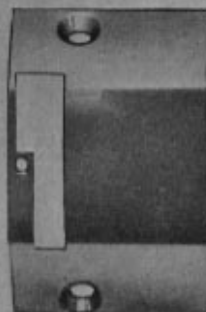
16857



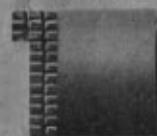
16856



16855



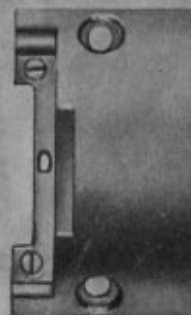
16854



65032



65033

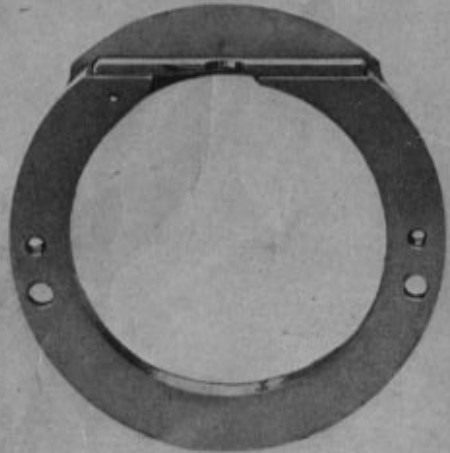


16846



PLATE 3391—FULL SIZE

16886



16841

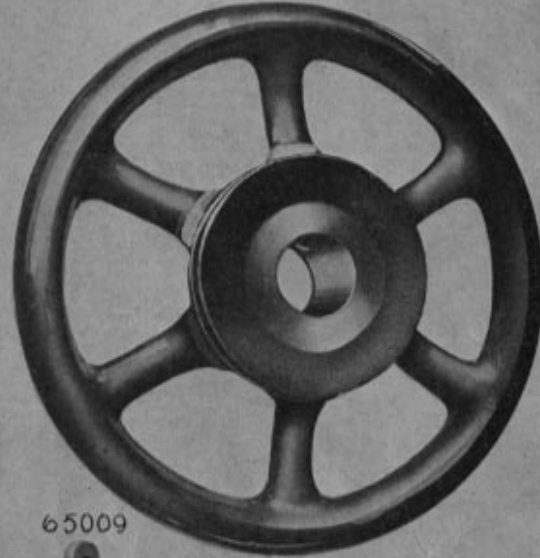


65028



PLATE 3392—ONE-HALF SIZE

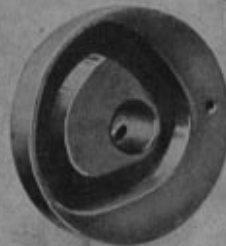
2135



65009



65008



16865

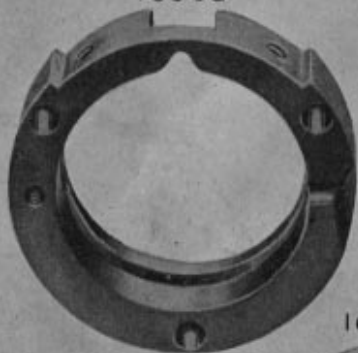


56864

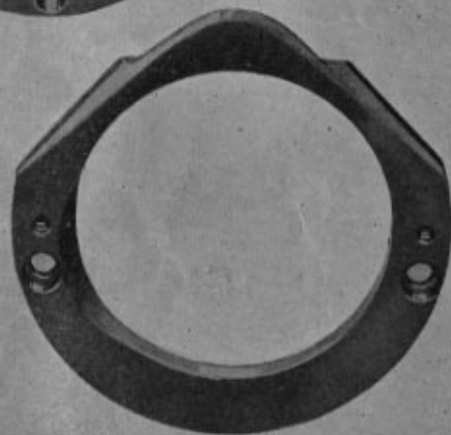


PLATE 3393—FULL SIZE

16838



16777

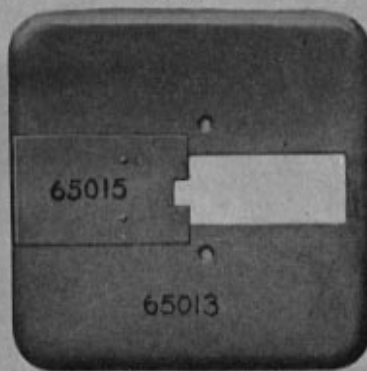


16816



PLATE 3394—ONE-FOURTH SIZE

65016



65015

65013

65014

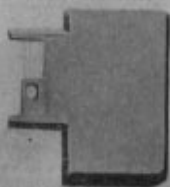


PLATE 3395—FULL SIZE

16894



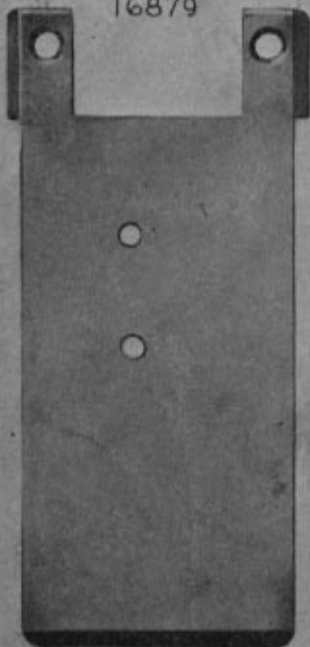
16897



16866



16879



16869

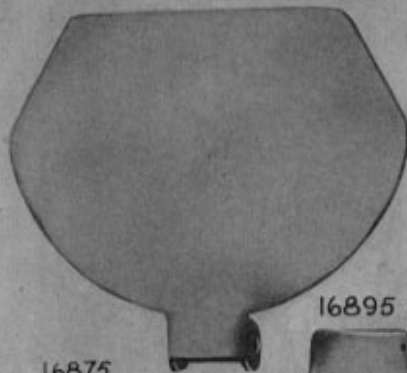


16870



PLATE 3396—FULL SIZE

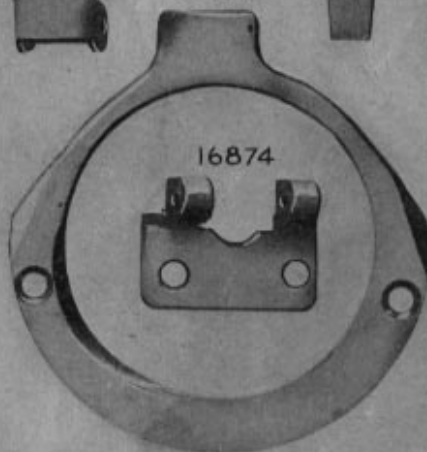
16873



16876



16895



16875

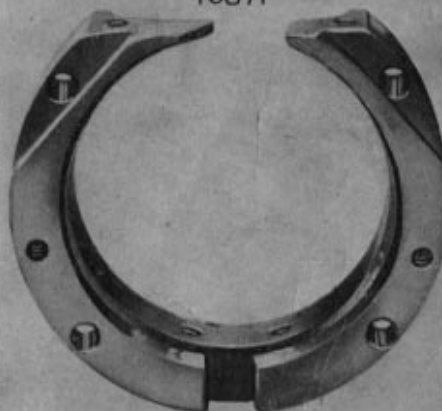


16874

399



16871



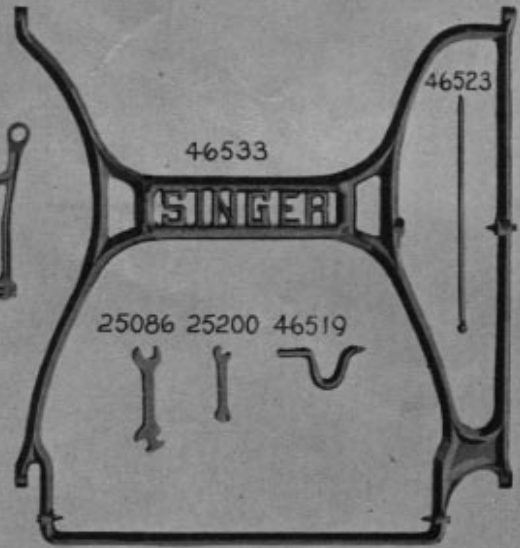
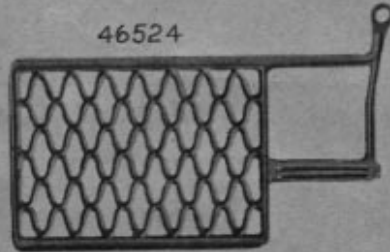
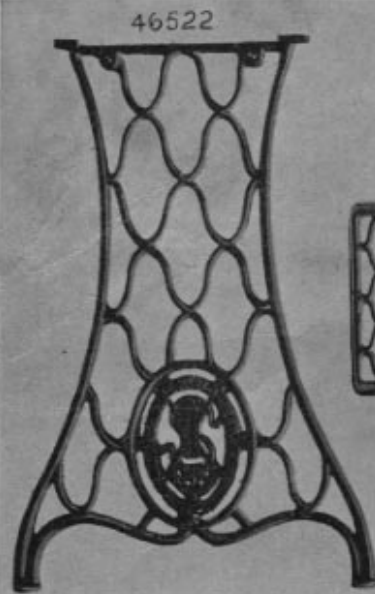


PLATE 3397-ONE-NINTH SIZE

PLATE 3398—ONE-FOURTH SIZE

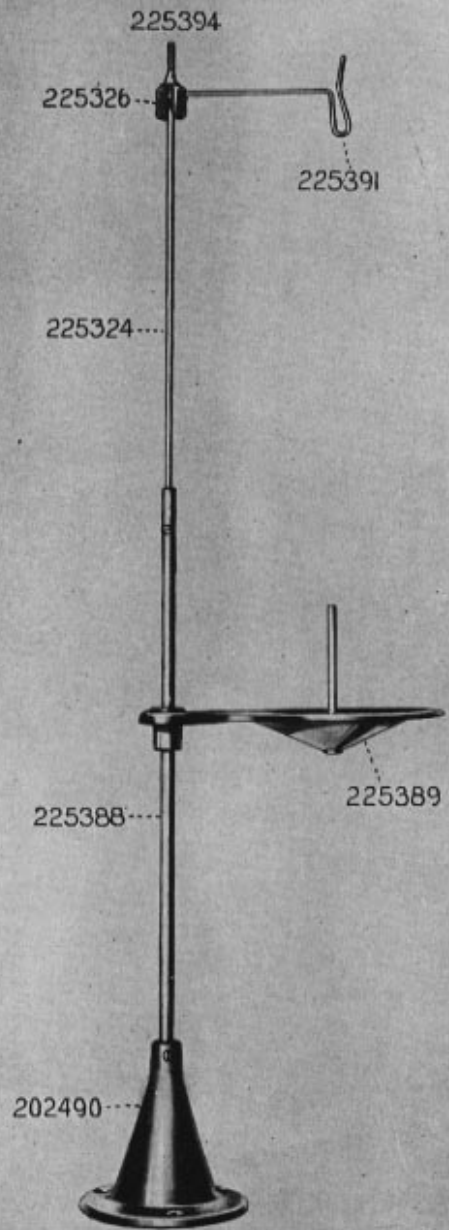


PLATE 5918—ONE-HALF SIZE

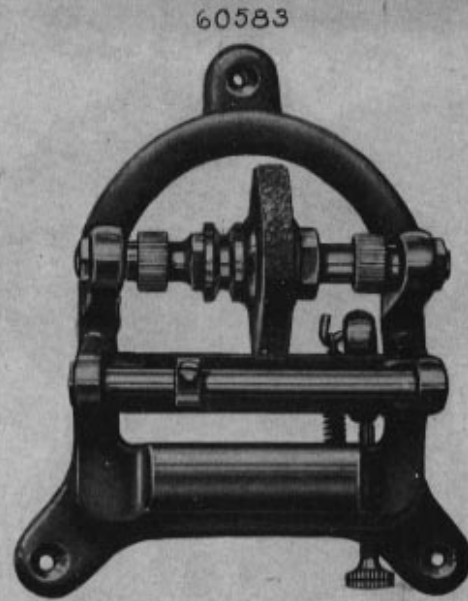


PLATE 6234 - FULL SIZE

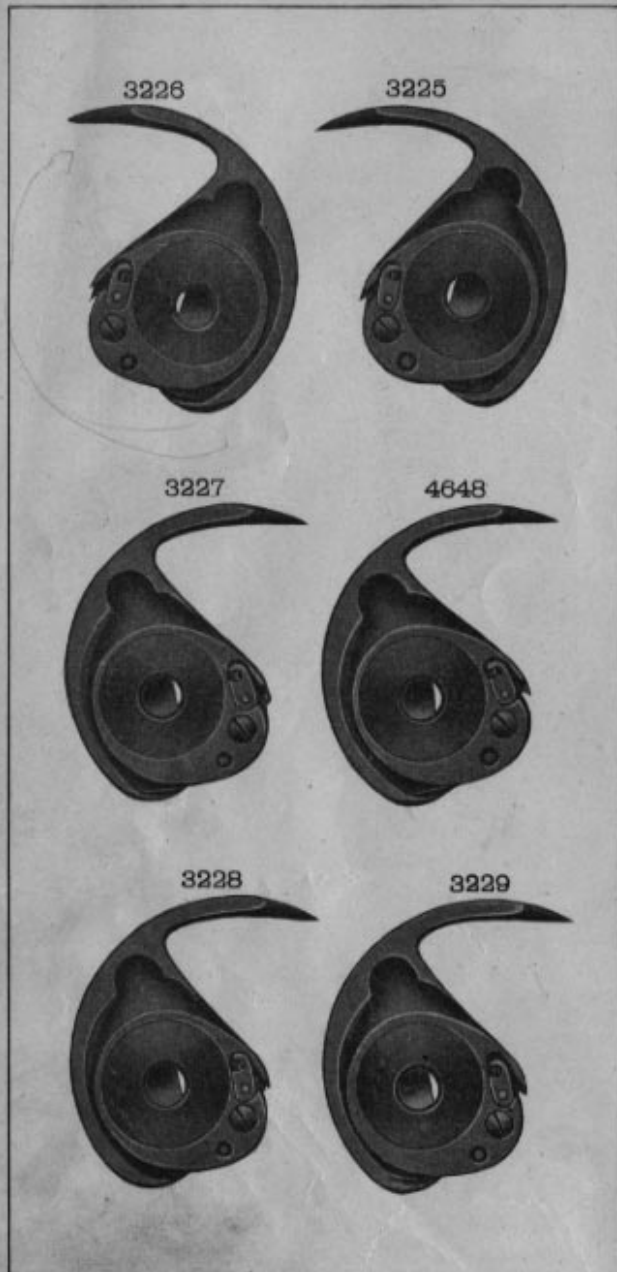


PLATE 6235 - FULL SIZE

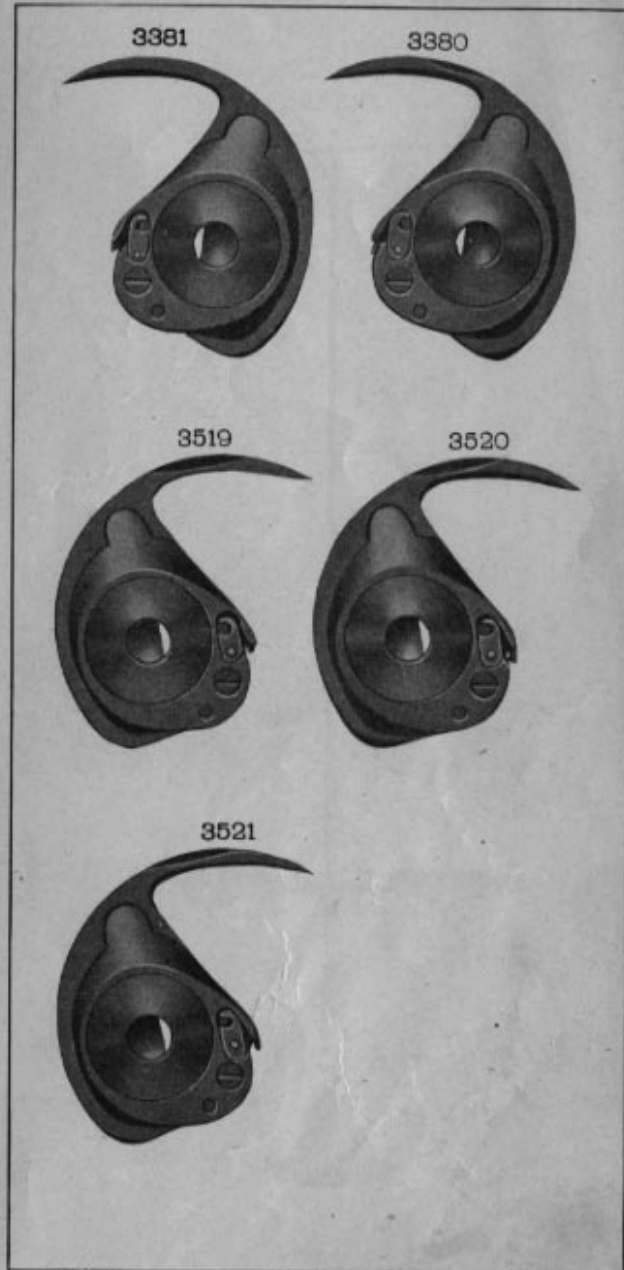


PLATE 7233—ONE-SIXTH SIZE



PLATE 7234—ONE-HALF SIZE

27739

225390

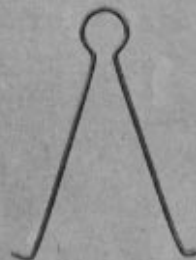


PLATE 20876—ONE-HALF SIZE

56871



65042

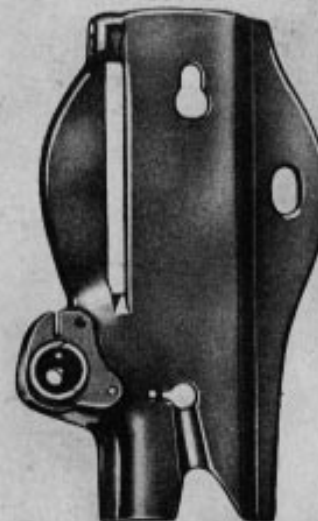


PLATE 20877—ONE-HALF SIZE

62827



65073



65069



65056



65083



PLATE 20878—FULL SIZE

65079



65081



65076



65084



65077

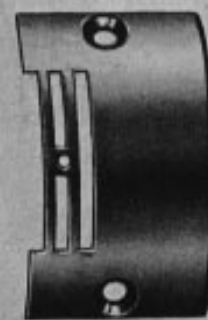


PLATE 20879—FULL SIZE

65067



65070



65058



65039



65038



65045



52016



65040



65059



56870



39623



PLATE 20880—FULL SIZE

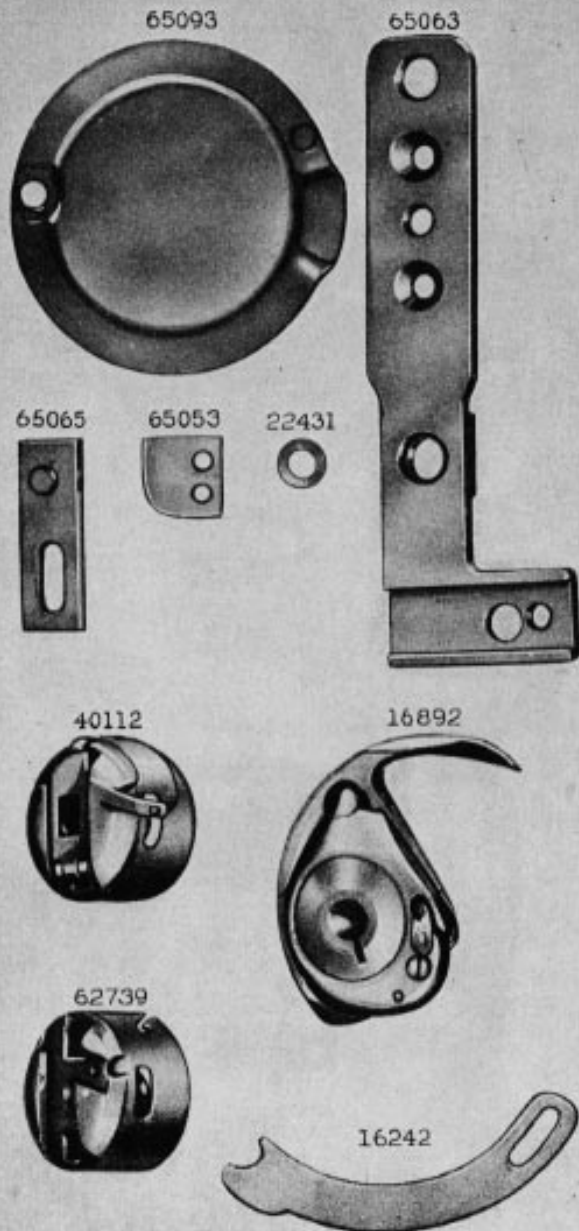


PLATE 20881—FULL SIZE

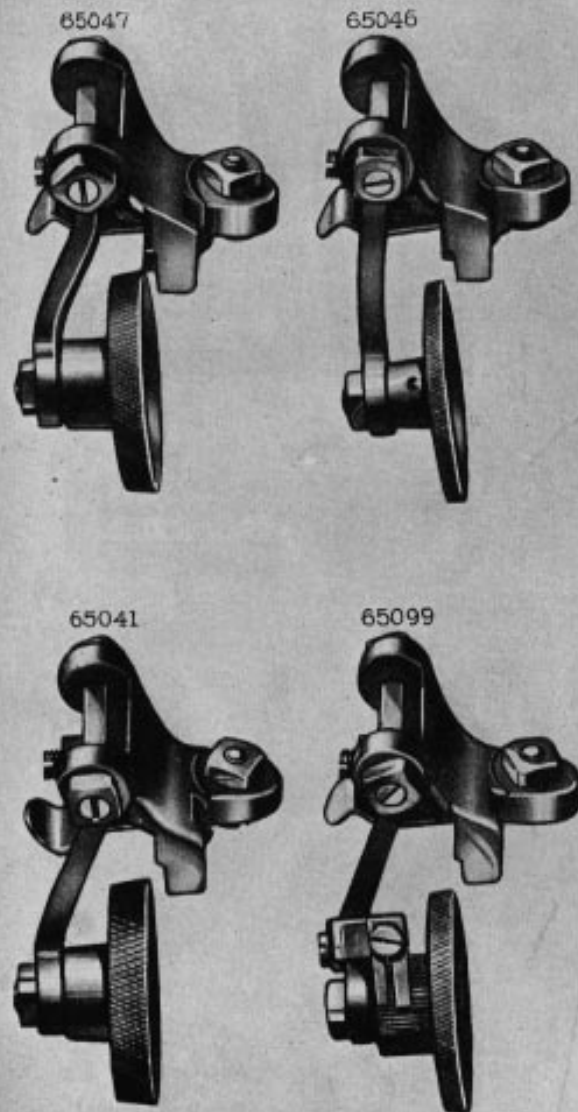


PLATE 20882—FULL SIZE

120493



120494



120495



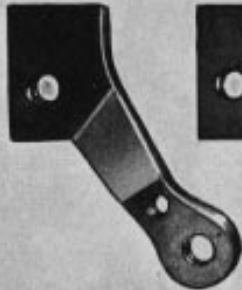
65049



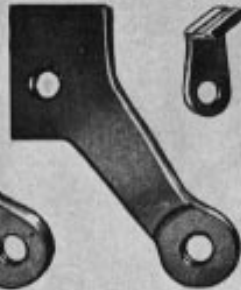
65050



65095



16230



62851



62853



50553



1766



1368



51022



1208



16232



27660



PLATE 20883—FULL SIZE

51072



51070



1128



732



225326



225322



51581



463



15405



230



51133



602



193



50998



51861



51893



51852



PLATE 20884—FULL SIZE

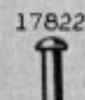
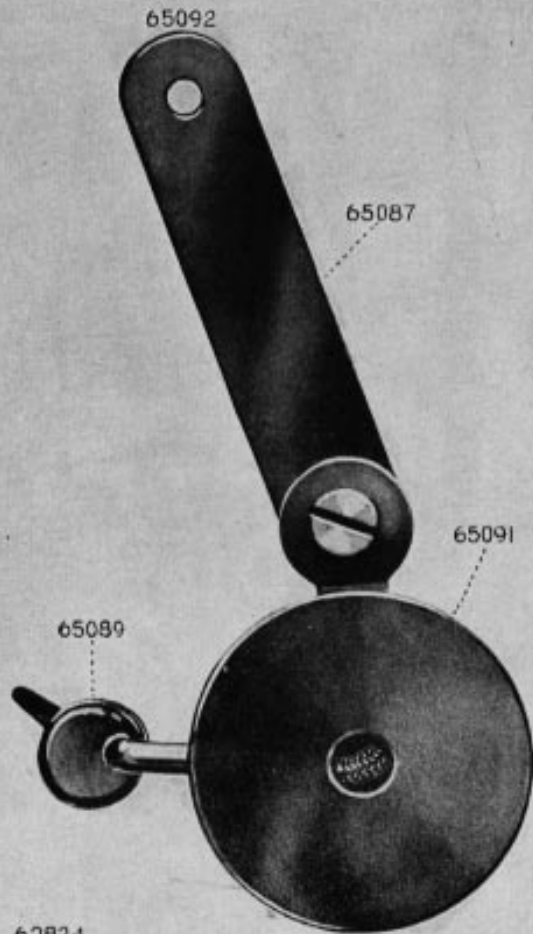


PLATE 20885—ONE-HALF SIZE

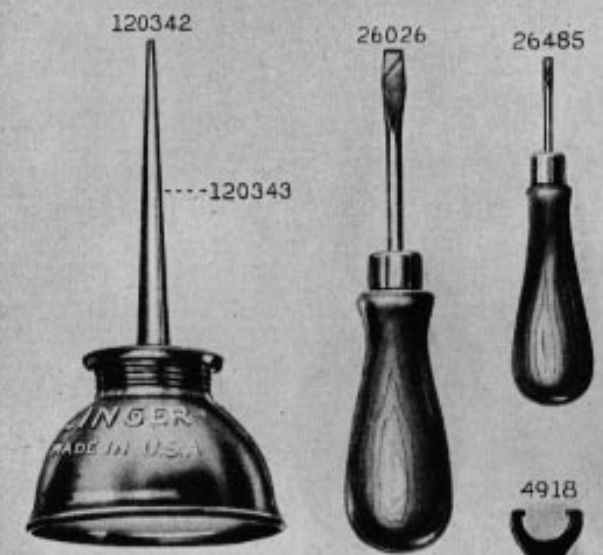


PLATE 20886—FULL SIZE

65030

