

**SINGER**  
400W31

Form 3061w  
(152)  
Printed in U.S.A.

# LIST OF PARTS



MACHINE No. 400w31

---

\*\*\* A TRADE-MARK OF  
THE SINGER MANUFACTURING COMPANY

# INSTRUCTIONS FOR OILING

---

BEFORE STARTING THE MACHINE, fill reservoir in base to "high" mark. Inspect often enough to keep oil level from going below "low" mark in base.

To ensure easy running and prevent unnecessary wear of the parts which are in movable contact, the machine requires oiling and when in continuous use, "TYPE A" or "TYPE C" OIL, sold only by Singer Sewing Machine Company, should be applied at the beginning of each working day to all oil holes marked "OIL".

"TYPE C" OIL is stainless.

## INDEX

|                               | Page    |
|-------------------------------|---------|
| Accessories .....             | 14      |
| Belt Guard .....              | 16      |
| Bobbin Winders .....          | 14 & 16 |
| Foot Lifter Treadle .....     | 15      |
| Knee Lifter .....             | 15      |
| Machine No. 400w31 .....      | 5       |
| Miscellaneous Parts .....     | 17      |
| Numerical List of Parts ..... | 19      |
| Thread Unwinder .....         | 17      |

FOR

## INSTRUCTIONS FOR ORDERING

In ordering from this list, use ONLY the PART number in the FIRST column.

The number stamped on a Sewing Machine Part is the number of the Single Part only, except when the part includes Set Screws, Clamping Screws, Studs and Rollers Spun on, Small Wires riveted, or Parts soldered together, etc., which it is necessary to furnish in combination.

Every combination of parts sent out has its specific number which, although not stamped on Parts (except in above case), must be used when ordering the combination.

Each number always indicates the SAME PART in whatever list it appears, or for whatever Machine.

The letters after some of the numbers indicate the style of finish only, as follows:

- A Hardened, Polished, Nickel Plated and Buffed.
- AL Heat Treated for Toughness.
- B Polished, Nickel Plated and Buffed.
- C Hardened only.
- D Polished only.
- E Soft, Not polished.
- F Hardened and Polished.
- H Blued.
- J Nickel Plated only.
- R Merlized.
- X Black Oxide, for Iron and Steel.
- XC Hardened and Black Oxide, for Iron and Steel.
- Y Black Nickel Plated only.
- Z Chromium Plated.

These letters MUST BE USED when they appear in the list and AFTER the number, as in the list.

In this series

1 to 1500, 200001 to 201500 and 350001 to 351500 are Screw Numbers.  
1501 to 1800, 201501 to 201800 and 351501 to 351800 are Nut Numbers.  
1801 to 2000, 201801 to 202000 and 351801 to 352000 are Roller Numbers.  
2001 to 50000 and 202001 to 350000 are Numbers of Machine Parts.

The figures in the second column refer only to the plate in which the illustration of the part is shown and are NOT TO BE USED in ordering.

Two or more numbers over a cut indicate that the difference between such parts is not visible in an illustration.

Parts marked with an asterisk (\*) are furnished only when repairs are made at the factory.

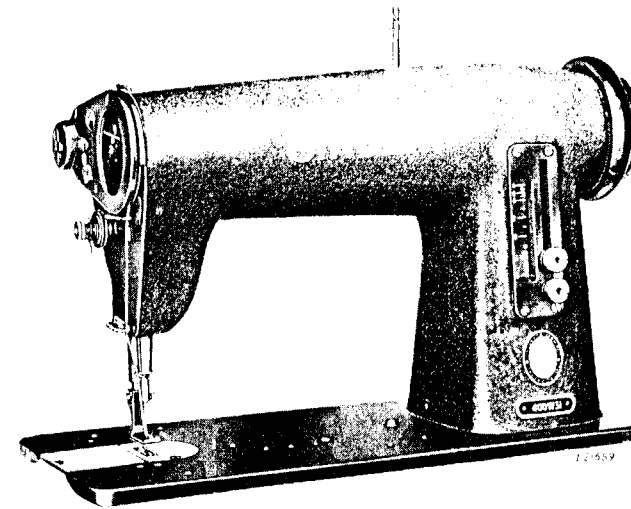

## MACHINE No. 400w31

CONTROLLABLE DIFFERENTIAL FEED

DOUBLE ROTARY DISC TAKE UP.

HIGH SPEED. SINGLE NEEDLE.

LOCK STITCH. DROP FEED.

MAXIMUM STITCH 5 1/2 TO THE INCH

PRESSER BAR LIFT 3/16 INCH.

HAS TWO INDEPENDENTLY ADJUSTED FEED MOTIONS FOR STITCHING KNIT GOODS AND OTHER STRETCHY MATERIALS. THE MOTION OF THE FEED DOG NEAREST THE OPERATOR MAY BE CONTROLLED WHILE MACHINE IS IN OPERATION BY PRESSURE ON A FOOT TREADLE.

| No.     | Plate | Name                 |
|---------|-------|----------------------|
| *270551 | ----- | Arm                  |
| 270002  | 18469 | " Cover Plate (back) |
| 200041X | 18469 | " " " Screw (2)      |
| 204235  | 18469 | " Position Pin (2)   |
| 350390E | 18469 | " Screw (long)       |
| 200004E | 18469 | " " (short) (2)      |
| 202005  | 18469 | " " Washer (3)       |
| *270084 | 18376 | " Shaft              |

| No.      | Plate | Name  |
|----------|-------|---|
| 270177   | 18376 | Arm Shaft 270084 with 200333C, 200378C, 270005 and 270099   |
| 270004   | 18376 | Arm Shaft Ball Bearing (back)   |
| 270005   | 18376 | " " " " (front)   |
| 270926   | 18376 | " " Connection Belt (reinforced neoprene)   |
| 270168   | 18376 | Arm Shaft Connection Belt Pulley and Rotary Take-up Driving Pulley with 200363AL, 350492C and three 214206                                |
| 350492C  | 18376 | Arm Shaft Connection Belt Pulley Position Screw   |
| 200363AL | 18376 | Arm Shaft Connection Belt Pulley Set Screw  |
| 214206   | 18376 | Arm Shaft Connection Belt Pulley Spring Flange  |
| 270189   | 18376 | Balance Wheel (aluminum alloy casting) for 5/16" round belt (diam. of belt groove 1-13/16 in.) (rim diam. 4 in.) with 201346C and 350107C |
| 270190   | 18376 | Balance Wheel 270189 with 270004  |
| 270187   | 18376 | " " (aluminum alloy casting) for "V" belt (outside diam. of belt groove 2.9 in.) (rim diam. 4 in.) with 350540C and 350541C               |
| 270188   | 18376 | Balance Wheel 270187 with 270004  |
| Note:    |       | Balance Wheel 270188 is furnished with this machine unless otherwise specified on order:  |
| 350107C  | 18376 | Balance Wheel Position Screw  |
| 350540C  | 18376 | " " " " Screw   |
| 201346C  | 18376 | " " Set Screw   |
| 350541C  | 18376 | " " " Screw   |
| *270552  | ----- | Bed   |
| 270502   | 18469 | " Slide   |
| 270144   | 18473 | Face Plate  |
| 350503H  | 18473 | " " Screw (5)   |
| 270553   | 18472 | Feed (back) Bar   |
| 270513   | 18472 | " " " Hinge Pin   |
| 350101AL | 18472 | " " " " " Set Screw   |
| 52266    | 18472 | " " " Slide Block   |
| 52267    | 18472 | " " " " " 52266 with 125060   |
| 270526   | 18472 | Feed (back) Bar Slide Block Crank with 52267 and 200040E  |
| 200040E  | 18472 | Feed (back) Bar Slide Block Crank Pinch Screw   |
| *125060  | 18472 | Feed (back) Bar Slide Block Stud  |
| 270514   | 18472 | " " Driving Connection  |
| 270515   | 18472 | " " " " 270514 with 270016  |
| 270015   | 18472 | Feed (back) Driving Connection Crank with 200040E   |

| No.      | Plate | Name  |
|----------|-------|---|
| 200040E  | 18472 | Feed (back) Driving Connection Crank Pinch Screw                                |
| 200545C  | 18472 | Feed (back) Driving Connection Hinge Screw                                      |
| 201522E  | 18472 | Feed (back) Driving Connection Hinge Screw Nut                                  |
| 270016   | 18472 | Feed (back) Driving Connection Needle Bearing                                   |
| 270017   | 18471 | Feed (back) Driving Eccentric   |
| 270517   | 18471 | " " " " Adjusting Disc  |
| 270508   | 18471 | Feed (back) Driving Eccentric Adjusting Disc Spring                             |
| 270509   | 18471 | Feed (back) Driving Eccentric Adjusting Disc Spring Stop Washer                 |
| 201403H  | 18471 | Feed (back) Driving Eccentric Adjusting Disc Spring Stop Washer Screw (2)       |
| 240231   | 18471 | Feed (back) Driving Eccentric Friction Gib                                      |
| 200369C  | 18471 | Feed (back) Driving Eccentric Friction Gib Adjusting Screw                      |
| 350101AL | 18471 | Feed (back) Driving Eccentric Friction Gib Adjusting Screw Set Screw            |
| 270527   | 18471 | Feed (back) Driving Flange with 200333C, 200346C, two each 200369C and 350101AL |
| 200333C  | 18471 | Feed (back) Driving Flange Position Screw                                       |
| 200346C  | 18471 | Feed (back) Driving Flange Set Screw  |
| 270518   | 18472 | " " " Rock Shaft with 222598 and 350101AL                                       |
| 270022   | 18472 | Feed (back) Driving Rock Shaft Center (2)                                       |
| 201254C  | 18472 | Feed (back) Driving Rock Shaft Center Set Screw (2)                             |
| 222598   | 18472 | Feed (back) Driving Rock Shaft Oiling Wick                                      |
| 270554   | 18472 | Feed (front) Bar  |
| 270012   | 18472 | " " " Center (2)  |
| 200394C  | 18472 | " " " " Set Screw   |
| 235706   | 18472 | " " " Oiling Wick   |
| 270138   | 18472 | " " " " " Holder  |
| 270139   | 18472 | " " " " " " 270138 with 235706  |
| 52266    | 18472 | Feed (front) Bar Slide Block  |
| 52267    | 18472 | " " " " " 52266 with 125060   |
| 270506   | 18472 | Feed (front) Bar Slide Block Crank with 52267 and 200040E                       |
| 200040E  | 18472 | Feed (front) Bar Slide Block Crank Pinch Screw                                  |
| *125060  | 18472 | Feed (front) Bar Slide Block Stud   |

| No.     | Plate | Name  |
|---------|-------|---|
| 270803  | 18472 | Feed (front) Driving Connection                             |
| 270804  | 18472 | " " " " 270803<br>with 270016                               |
| 270555  | 18472 | Feed (front) Driving Connection Crank<br>with 200040E       |
| 270556  | 18472 | Feed (front) Driving Connection Crank<br>270555 with 270653 |
| 350507C | 18472 | Feed (front) Driving Connection Crank<br>Hinge Screw        |
| 201531E | 18472 | Feed (front) Driving Connection Crank<br>Hinge Screw Nut    |
| 270653  | 18472 | Feed (front) Driving Connection Crank<br>Needle Bearing     |
| 200040E | 18472 | Feed (front) Driving Connection Crank<br>Pinch Screw        |
| 270807  | 18472 | Feed (front) Driving Connection Link                        |
| 270808  | 18472 | " " " " "   |
|         |       | Hinge Pin   |
| 200394C | 18472 | Feed (front) Driving Connection Link<br>Hinge Pin Set Screw |
| 270016  | 18472 | Feed (front) Driving Connection Needle<br>Bearing           |
| 270557  | 18471 | Feed (front) Driving Eccentric with<br>and 201220C          |
| 201220C | 18471 | Feed (front) Driving Eccentric Posi-<br>tion Screw          |
| 200382C | 18471 | Feed (front) Driving Eccentric Set<br>Screw                 |
| 270573  | 18472 | Feed (front) Driving Rock Shaft with<br>two 200394C         |
| 270022  | 18472 | Feed (front) Driving Rock Shaft Center<br>(2)               |
| 201254C | 18472 | Feed (front) Driving Rock Shaft Center<br>Set Screw (2)     |
| 270559  | 18472 | Feed (front) Indicator                                      |
| 270560  | 18472 | " " Regulating Index Plate                                  |
| 691F    | 18472 | " " " " "   |
|         |       | Screw (4)   |
| 270561  | 18472 | Feed (front) Regulating Lever with<br>270559                |
| 270562  | 18472 | Feed (front) Regulating Lever Con-<br>nection with 200040E  |
| 200040E | 18472 | Feed (front) Regulating Lever Con-<br>nection Pinch Screw   |
| 200273F | 18472 | Feed (front) Regulating Lever Hinge<br>Screw                |
| 350539H | 18472 | Feed (front) Regulating Lever Stop<br>Stud (2)              |
| 201561X | 18472 | Feed (front) Regulating Lever Stop<br>Screw Thumb Nut (2)   |
| 228032  | 18472 | Feed (front) Regulating Lever Stop<br>Screw Stud Washer (2) |
| 270563  | 18472 | Feed (front) Regulating Shaft                               |

| No.     | Plate | Name   |
|---------|-------|--|
| 270822  | 18472 | Feed (front) Regulating Shaft Crank<br>with 200040E              |
| 270823  | 18472 | Feed (front) Regulating Shaft Crank<br>270822 with two 270653    |
| 270825  | 18472 | Feed (front) Regulating Shaft Crank<br>Hinge Stud                |
| 270653  | 18472 | Feed (front) Regulating Shaft Crank<br>Hinge Stud Needle Bearing |
| 200394C | 18472 | Feed (front) Regulating Shaft Crank<br>Hinge Stud Set Screw      |
| 270824  | 18472 | Feed (front) Regulating Shaft Crank<br>Link with two 200394C     |
| 200040E | 18472 | Feed (front) Regulating Shaft Crank<br>Pinch Screw               |
| 270564  | 18472 | Feed (front) Regulating Shaft Spring                             |
| 270565  | 18472 | " " " " "  |
|         |       | Collar with two 200378C  |
| 200378C | 18472 | Feed (front) Regulating Shaft Spring<br>Collar Set Screw         |
| 270566  | 18474 | Feed Dog (back) for 270571                                       |
| 270567  | 18474 | " " (front) for 270571   |
| 50117E  | 18474 | " " Screw (4)  |
| 270013  | 18472 | " Lifting Connection   |
| 270014  | 18472 | " " " " 270013 with<br>270016                                    |
| 200545C | 18472 | Feed Lifting Connection Hinge Screw                              |
| 201522E | 18472 | " " " " "  |
|         |       | Nut  |
| 270016  | 18472 | Feed Lifting Connection Needle Bear-<br>ing                      |
| 270568  | 18471 | Feed Lifting Eccentric with 200382C<br>and 201220C               |
| 201220C | 18471 | Feed Lifting Eccentric Position Screw                            |
| 200382C | 18471 | " " " " Set Screw  |
| 270520  | 18472 | " " Rock Shaft   |
| 270022  | 18472 | " " " " Center (2)   |
| 201254C | 18472 | " " " " " Set<br>Screw (2)                                       |
| 270521  | 18471 | Feed Regulating Stud (2)   |
| 270522  | 18471 | " " " Spring (2)   |
| 200096E | 18471 | " " " " Screw (2)  |
| 270045  | 18470 | Knee Lifter Lifting Link   |
| 270285  | 18469 | " " " " Connection   |
| 200427C | 18469 | " " " " " Set<br>Screw   |
| 200293C | 18470 | Knee Lifter Lifting Link Hinge Screw                             |
| 270569  | 18469 | " " " Rod  |
| 270048  | 18469 | " " " " Connection   |
| 200434C | 18469 | " " " " " Set<br>Screw   |
| 270049  | 18469 | Knee Lifter Rock Shaft with 200427C<br>and 200434C               |
| 270050  | 18470 | Needle Bar with 350445F  |

| No.      | Plate | Name  |
|----------|-------|---|
| 270124   | 18470 | Needle Bar Bushing (lower)                                      |
| 270261   | 18470 | " " " (upper)   |
| 350489AL | 18470 | " " " " Set Screw   |
| 270053   | 18470 | " " Connecting Link   |
| 270054   | 18470 | " " " " 270053<br>with 270043                                   |
| 270055   | 18470 | Needle Bar Connecting Link Guide<br>Block                       |
| 200054E  | 18470 | Needle Bar Connecting Link Guide<br>Block Screw (2)             |
| 270143   | 18470 | Needle Bar Connecting Link Hinge<br>Stud with 222598 and 270161 |
| 222598   | 18470 | Needle Bar Connecting Link Hinge<br>Stud Oil Packing (wick)     |
| 200374C  | 18376 | Needle Bar Connecting Link Hinge Stud<br>Set Screw              |
| 270043   | 18470 | Needle Bar Connecting Link Needle<br>Bearing                    |
| 270100   | 18470 | Needle Bar Connecting Link Thrust<br>Washer                     |
| 270057   | 18470 | Needle Bar Connecting Stud with<br>200086C and 202330           |
| 202330   | 18470 | Needle Bar Connecting Stud Oil Pack-<br>ing (wick)              |
| 200086C  | 18470 | Needle Bar Connecting Stud Pinch<br>Screw                       |
| *270099  | 18376 | Needle Bar Crank with two 200374C                               |
| 200333C  | 18376 | " " " Position Screw  |
| 200378C  | 18376 | " " " " " "   |
|          |       | Check Screw   |
| 270058   | 18470 | Needle Bar Oiling Felt  |
| 350445F  | 18470 | " Set Screw   |
| 270059   | 18470 | Presser Bar with 176X   |
| 270060   | 18470 | " " Bushing   |
| 270061   | 18470 | " " Lifter  |
| 350442C  | 18470 | " " " Hinge Screw   |
| 270062   | 18470 | " " Lifting Releasing Lever<br>Bracket                          |
| 270095   | 18470 | Presser Bar Lifting Releasing Lever<br>Bracket Spring           |
| 270063   | 18470 | Presser Bar Position Guide with<br>200196E and 350411C          |
| 350411C  | 18470 | Presser Bar Position Guide Pinch<br>Screw                       |
| 270064   | 18469 | Presser Bar Spring  |
| 350435C  | 18469 | " " " Screw (pressure<br>regulating)                            |
| 350499XC | 18469 | Presser Bar Spring Screw Stud                                   |
| 270529   | 18474 | " Foot, 46 needle hole  |
| 176X     | 18470 | " " Screw   |
| 270570   | 18473 | Rotary Take-up (large)  |
| 270161   | 18470 | " " " Position Pin  |
| 401D     | 18473 | " " " Screw (2)   |

| No.     | Plate | Name  |
|---------|-------|---|
| 271032  | 18473 | Rotary Take-up (large) Thread Guide                             |
| 350503H | 18473 | " " " " " "<br>Screw  |
| 270146  | 18302 | Rotary Take-up (small) with 270147<br>and 350418C               |
| 270068  | 18302 | Rotary Take-up (small) Driving Shaft                            |
| 270032  | 18302 | " " " " " "<br>Ball Bearing (2)                                 |
| 270069  | 18302 | Rotary Take-up (small) Driving Shaft<br>Connection Belt         |
| 270072  | 18302 | Rotary Take-up (small) Driving Shaft<br>Pulley with two 200382C |
| 200382C | 18302 | Rotary Take-up (small) Driving Shaft<br>Pulley Set Screw        |
| 350418C | 18302 | Rotary Take-up (small) Set Screw                                |
| 270147  | 18302 | " " " Thread Cast-<br>off Pin                                   |
| 270148  | 18473 | Rotary Take-up Guard  |
| 350503H | 18473 | " " " Screw (3)   |
| 270868  | 18416 | Rotating Hook with 143301 and two<br>1253AL                     |
| 270869  | 18416 | Rotating Hook 270868 with 270874XC<br>and four 1053E            |
| 270870  | 18416 | Rotating Hook 270869 with 270872,<br>270876 and three 1367E     |
| 270871  | 18416 | Rotating Hook 270870 with 52237                                 |
| 270010  | 18416 | " " Bobbin  |
| 52235   | 18416 | " " " Case  |
| 52236   | 18416 | " " " " 52235 with<br>591F, 1380E and 40394                     |
| 40393   | 18416 | Rotating Hook Bobbin Case Hinge, Nos.<br>2974, 40392 and 125320 |
| 270872  | 18416 | Rotating Hook Bobbin Case Holder<br>(chromium plated)           |
| 270523  | 18416 | Rotating Hook Bobbin Case Holder<br>Position Bracket            |
| 200077D | 18416 | Rotating Hook Bobbin Case Holder<br>Position Bracket Screw      |
| 40392   | 18416 | Rotating Hook Bobbin Case Latch                                 |
| 125320  | 18416 | " " " " " "<br>Lever  |
| 2974    | 18416 | Rotating Hook Bobbin Case Latch<br>Lever Fulcrum Pin            |
| 2975    | 18416 | Rotating Hook Bobbin Case Latch<br>Spring                       |
| 592E    | 18416 | Rotating Hook Bobbin Case Latch<br>Stop Screw                   |
| 40394   | 18416 | Rotating Hook Bobbin Case Tension<br>Spring                     |
| 591F    | 18416 | Rotating Hook Bobbin Case Tension<br>Spring Regulating Screw    |
| 1380E   | 18416 | Rotating Hook Bobbin Case Tension<br>Spring Screw               |

| No.     | Plate | Name   |
|---------|-------|--|
| 52237   | 18416 | Rotating Hook Bobbin Case complete,<br>Nos. 592E, 2975, 40393 and 52236              |
| 270873  | 18416 | Rotating Hook Bobbin Case 52237 with<br>270872                                       |
| 270572  | 18471 | Rotating Hook Driving Shaft  |
| 270032  | 18471 | " " " " Ball<br>Bearing  |
| 271062  | 18471 | Rotating Hook Driving Shaft Bushing<br>with 270200                                   |
| 270200  | 18471 | Rotating Hook Driving Shaft Bushing<br>Oil Packing (wick)                            |
| 200346C | 18471 | Rotating Hook Driving Shaft Bushing<br>Set Screw                                     |
| 270169  | 18471 | Rotating Hook Driving Shaft Connection<br>Belt Pulley with 214206 and two<br>200070C |
| 200070C | 18471 | Rotating Hook Driving Shaft Connection<br>Belt Pulley Set Screw                      |
| 214206  | 18471 | Rotating Hook Driving Shaft Connection<br>Belt Pulley Spring Flange                  |
| 270035  | 18471 | Rotating Hook Driving Shaft Gear<br>(internal teeth) with 200382C and<br>201220C     |
| 201220C | 18471 | Rotating Hook Driving Shaft Gear<br>Position Screw                                   |
| 200382C | 18471 | Rotating Hook Driving Shaft Gear Set<br>Screw  |
| 270525  | 18471 | Rotating Hook Driving Shaft Oil Lead<br>Wire   |
| 270038  | 18469 | Rotating Hook Oil Reservoir Cover  |
| 270039  | 18469 | " " " " " "<br>Gasket  |
| 200041X | 18469 | Rotating Hook Oil Reservoir Cover<br>Screw (6)                                       |
| 143301  | 18416 | Rotating Hook Oil Wick (felt)  |
| 270876  | 18416 | " " Section  |
| 1367E   | 18416 | " " " Screw  |
| 1253AL  | 18416 | " " Set Screw  |
| 270162  | 18471 | " " Shaft  |
| 270163  | 18471 | " " " Bushing  |
| 268258  | 18471 | " " " " Oil Pack-<br>ing (wick)  |
| 270164  | 18471 | Rotating Hook Shaft End Bearing  |
| 201215D | 18471 | " " " " " Screw  |
| 202423  | 18471 | " " " Oil Filter Wick  |
| 143349  | 18471 | " " " " " "<br>Holder  |
| 270176  | 18471 | Rotating Hook Shaft Oil Filter complete,<br>Nos. 143349 and 202423                   |
| 350498E | 18471 | Rotating Hook Shaft Oil Regulating<br>Screw  |

| No.      | Plate | Name  |
|----------|-------|---|
| 270166   | 18471 | Rotating Hook Shaft Bushing complete,<br>Nos. 268258, 270044, 270162 to<br>270164, 270176, 350498E and two<br>201215D |
| 200346C  | 18471 | Rotating Hook Shaft Bushing Set Screw   |
| 270044   | 18471 | " " " Thrust Washer   |
| 270874XC | 18416 | " " Thread Guard  |
| 1053E    | 18416 | " " " " Screw   |
| 2102     | 18473 | Tension Disc  |
| 270076   | 18470 | " Releaser (adjustable)   |
| 200132E  | 18470 | " " Screw   |
| 32572    | 18473 | " Releasing Disc  |
| 270086   | 18473 | " " Pin   |
| 13710    | 18473 | " Spring  |
| 50304C   | 18473 | " Stud  |
| 52098    | 18473 | " " 50304C with 1560C   |
| 50305C   | 18473 | " " Set Screw   |
| 1560C    | 18473 | " Thumb Nut   |
| 270087   | 18473 | Tension complete, Nos. 13710, 32572,<br>52082, 52083, 52098, 270086 and two<br>2102                                   |
| 270096   | 18473 | Thread Guide  |
| 236245   | 18473 | " " (lower)   |
| 263118   | 18470 | " " (on Needle Bar Bushing)   |
| 350503H  | 18473 | " " Screw   |
| 270079   | 18470 | " Pull-off  |
| 200196E  | 18470 | " " Set Screw   |
| 270080   | 18473 | " Retainer  |
| 200355H  | 18473 | " " Set Screw   |
| 270150   | 18473 | " Severing Finger   |
| 270151   | 18473 | " " " Guard   |
| 350486XC | 18473 | " " " " Hinge<br>Screw  |
| 270156   | 18473 | Thread Severing Finger Guard Hinge<br>Screw Spring Washer   |
| 200567H  | 18473 | Thread Severing Finger Screw  |
| 52082    | 18473 | " Take-up Spring  |
| 52083    | 18473 | " " " Regulator with<br>50305C  |
| 446C     | 18473 | Thread Take-up Spring Regulator Set<br>Screw  |
| 270571   | 18474 | Throat Plate, for 270566 and 270567   |
| 691F     | 18474 | " " Screw (2)   |



## ACCESSORIES

| No.    | Plate | Name                                  |
|--------|-------|---------------------------------------|
| 50190W | 18469 | Attachment Thumb Screw                |
| 25878  | 18441 | Guide                                 |
| 270010 | 18416 | Rotating Hook Bobbin (2)              |
| 270155 | 18471 | " " Oil Reservoir Oil Gauge           |
| 228476 | 18441 | Screw Driver (Bobbin Case)            |
| 88 x 1 | ----- | Needles, six, size 16                 |
| 228688 | 18467 | Drip Pan with four 3/4 in. wire nails |
| 12361  | 18441 | Machine Hinge Connection (2)          |
| 41400  | 18441 | " Rest Pin (wood)                     |
| 228493 | ----- | Oiler 120342 filled with oil          |
| 120342 | 18441 | " (copper plated) with 120343         |
| 120343 | 18441 | " Spout (3-1/2 in. long)              |
| 259477 | 18441 | Screw Driver, 5 in. long              |

## BOBBIN WINDER

(SWINGING AUTOMATIC, RIGHT HAND)

## FOR "V" BELT DRIVE

|         |       |                              |
|---------|-------|------------------------------|
| 259428  | 18312 | Brake (leather)              |
| 259429  | 18312 | " Clamp                      |
| 200113F | 18312 | " " Screw                    |
| 225453  | 18312 | Frame with 202277 and 259660 |
| 225454  | 18312 | " Hinge Pin                  |
| 202277  | 18312 | " Oil Packing (wick)         |
| 259660  | 18312 | " " Well Washer              |
| 225455  | 18312 | " Spring                     |
| 225456  | 18312 | " " Plunger                  |
| 259461  | 18312 | Pulley with 200380C          |
| 200380C | 18312 | " Set Screw                  |
| 225381  | 18312 | Spindle                      |
| 225444  | 18312 | Stop Latch                   |
| 200056E | 18312 | " " Screw                    |
| 225458  | 18312 | " " Thumb Lever              |
| 225459  | 18312 | " " " " Hinge Stud           |
| 225459  | 18312 | " " " " Joint Stud           |
| 202478  | 18312 | " " Trip Lever               |
| 200299H | 18312 | " " " " Hinge Screw          |
| 225461  | 18312 | Tension Bracket with 201499H |
| 200082D | 18312 | " " Screw                    |
| 228026  | 18312 | " " " " Washer               |
| 2102    | 18312 | " Disc                       |

## ACCESSORIES

| No.     | Plate | Name   |
|---------|-------|--|
| 13710   | 18312 | Tension Spring   |
| 201499H | 18312 | " Stud   |
| 201572H | 18312 | " " Thumb Nut  |
| 225462  | 18312 | Bobbin Winder Tension Bracket complete, Nos. 13710, 201572H, 225461 and two 2102   |
| 259662  | 18312 | Bobbin Winder and Tension Bracket Base   |
| 259462  | 18312 | Universal Bobbin Winder complete, Nos. 200056E, 200082D, 200113F, 200299H, 202478, 225381, 225444, 225453 to 225456, 225458, 225462, 228026, 259428, 259429, 259461, 259662, two each 225459 and wood screws 3/4 in., No. 12, R. H. B. |

## FOOT LIFTER TREADLE

|         |       |  |
|---------|-------|--|
| 228676  | 18468 | Treadle  |
| 228714  | 18468 | " 228676 with 2718R, 14373 and 50581R                                    |
| 228683  | 18468 | Treadle Bracket with 200358C and two 200528C                             |
| 200528C | 18468 | Treadle Bracket Set Screw  |
| 228474  | 18468 | " Chain, 34 in. long, with two 202784                                    |
| 202784  | 18468 | Treadle Chain Hook   |
| 14373   | 18468 | " Extension  |
| 50581R  | 18468 | " " Screw  |
| 2718R   | 18468 | " " " Washer   |
| 228679  | 18468 | " Shaft  |
| 200358C | 18468 | " " Set Screw  |
| 228712  | 18468 | Foot Lifter Treadle complete, Nos. 228474, 228679, 228714 and two 228683 |

## KNEE LIFTER

|         |       |  |
|---------|-------|--|
| 228359  | 18467 | Rock Lever with two 350231C  |
| 228486  | 18467 | " " Bracket with 200347C and three wood screws 7/8 in., No. 12           |
| 228361  | 18467 | Rock Lever Bracket 228486 with 228359, 228363, 228367, 228386 and 228455 |
| 228370  | 18467 | Rock Lever Extension with 200529C  |
| 350231C | 18467 | " " " " Set Screw  |
| 228363  | 18467 | " " Hinge Pin  |
| 228364  | 18467 | " " Knee Plate with 350231C  |
| 228388  | 18467 | " " " " Arm  |

## ACCESSORIES

| No.     | Plate | Name  |
|---------|-------|---|
| 350231C | 18467 | Rock Lever Knee Plate Arm Set Screw   |
| 350231C | 18467 | " " " " Set Screw   |
| 228455  | 18467 | " " Position Spring   |
| 228365  | 18467 | " " Rod   |
| 200529C | 18467 | " " " Set Screw   |
| 228386  | 18467 | " " Spring  |
| 228367  | 18467 | " " Stop Stud   |
| 200347C | 18467 | " " " " Set Screw   |
| 228371  | 18467 | Knee Lifter Rock Lever complete, Nos.<br>228361, 228364, 228365, 228370 and<br>228388 |

(Other Knee Lifter Parts are listed with parts  
of Machine Head)

## BELT GUARD

|         |       |   |
|---------|-------|---|
| 270197  | 18442 | Belt Guard with two 200362C                                 |
| 270198  | 18442 | " " Bracket   |
| 350328H | 18442 | " " " Screw   |
| 200362C | 18442 | " " Set Screw   |
| 270199  | 18442 | Belt Guard complete, Nos. 270197,<br>270198 and two 350328H |

## BOBBIN WINDER

(SWINGING AUTOMATIC, RIGHT HAND)  
FOR 5/16 INCH ROUND BELT DRIVE

Note: Same as 259462 "V" belt Bobbin Winder with  
the following exceptions:

|        |       |  |
|--------|-------|--|
| 225368 | 18312 | Pulley with 200380C  |
| 259430 | 18312 | Bobbin Winder and Tension Bracket<br>Base  |
| 259431 | 18312 | Universal Bobbin Winder complete,<br>Nos. 200056E, 200082D, 200113F,<br>200299H, 202478, 225368, 225381,<br>225444, 225453 to 225456, 225458,<br>225462, 228026, 259428 to 259430,<br>two each 225459 and wood screws<br>3/4 in., No. 12, R. H. B. |

## THREAD UNWINDER

| No.     | Plate | Name  |
|---------|-------|---|
| 228692  | 18362 | Spool Pin   |
| 201528H | 18362 | " " Nut   |
| 228693  | 18362 | " " Washer  |
| 225257  | 18362 | " Rest (for two spools) (flat) with<br>201018C, two each 201528H, 228692<br>and 228693  |
| 150203  | 18362 | Spool Rest Cushion (felt)   |
| 225388  | 18362 | " " Rod   |
| 200383C | 18362 | " " " Set Screw   |
| 201018C | 18362 | " " Set Screw   |
| 259658  | 18362 | " Stand with 200383C  |
| 225391  | 18362 | Thread Guide  |
| 201696H | 18362 | " " Lock Nut  |
| 225326  | 18362 | " " Position Cup  |
| 225324  | 18362 | " " Rod with 208AL and<br>225322  |
| 208AL   | 18362 | Thread Guide Rod Screw  |
| 225322  | 18362 | " " " Washer  |
| 225258  | 18362 | Thread Unwinder (for two spools)<br>complete, Nos. 201696H, 225257,<br>225324, 225326, 225388, 259658,<br>two each 150203, 225391, and<br>three wood screws 7/8 in., No. 12 |

## MISCELLANEOUS PARTS

|        |       |               |
|--------|-------|---------------|
| 225434 | 18441 | Bobbin Holder |
| 259502 | 18441 | Finger Guard  |
| 228394 | 18441 | Spool Pin     |

USED IN CONJUNCTION WITH  
THREAD UNWINDER

|        |       |  |
|--------|-------|--|
| 259370 | 18362 | Spool Pin  |
| 259378 | 18362 | " " Arm with 217E and 259379                           |
| 232896 | 18362 | " " " Bracket with two 448AL                           |
| 448AL  | 18362 | " " " " Set Screw                                      |
| 448AL  | 18362 | " " " Set Screw  |
| 259371 | 18362 | " " Cap (bakelite)                                     |
| 1010F  | 18362 | " " Hinge Screw  |
| 259379 | 18362 | " " Retaining Spring                                   |
| 217E   | 18362 | " " " " Screw  |
| 259372 | 18362 | " " Washer   |
| 259373 | 18362 | Spool Pin complete, Nos. 1010F and<br>259370 to 259372 |

| No.    | Plate | Name                     |
|--------|-------|--------------------------|
| 60913  | 18362 | Spool Weight with 60914  |
| 60914  | 18362 | " " Center Pin           |
| 225377 | 18362 | " Wire, for small spools |
| 27739  | 18362 | Thread Cone (wood)       |
| 225390 | 18362 | " " Holder               |

**SINGER** Needles should be used  
in **SINGER** Machines  
These Needles and their Containers  
are marked with the  
Company's Trade Mark "SIMANCO.\*\*" 1

Needles in Containers marked  
"FOR SINGER MACHINES"  
are NOT **SINGER** made needles. 2

18302 - 1/2

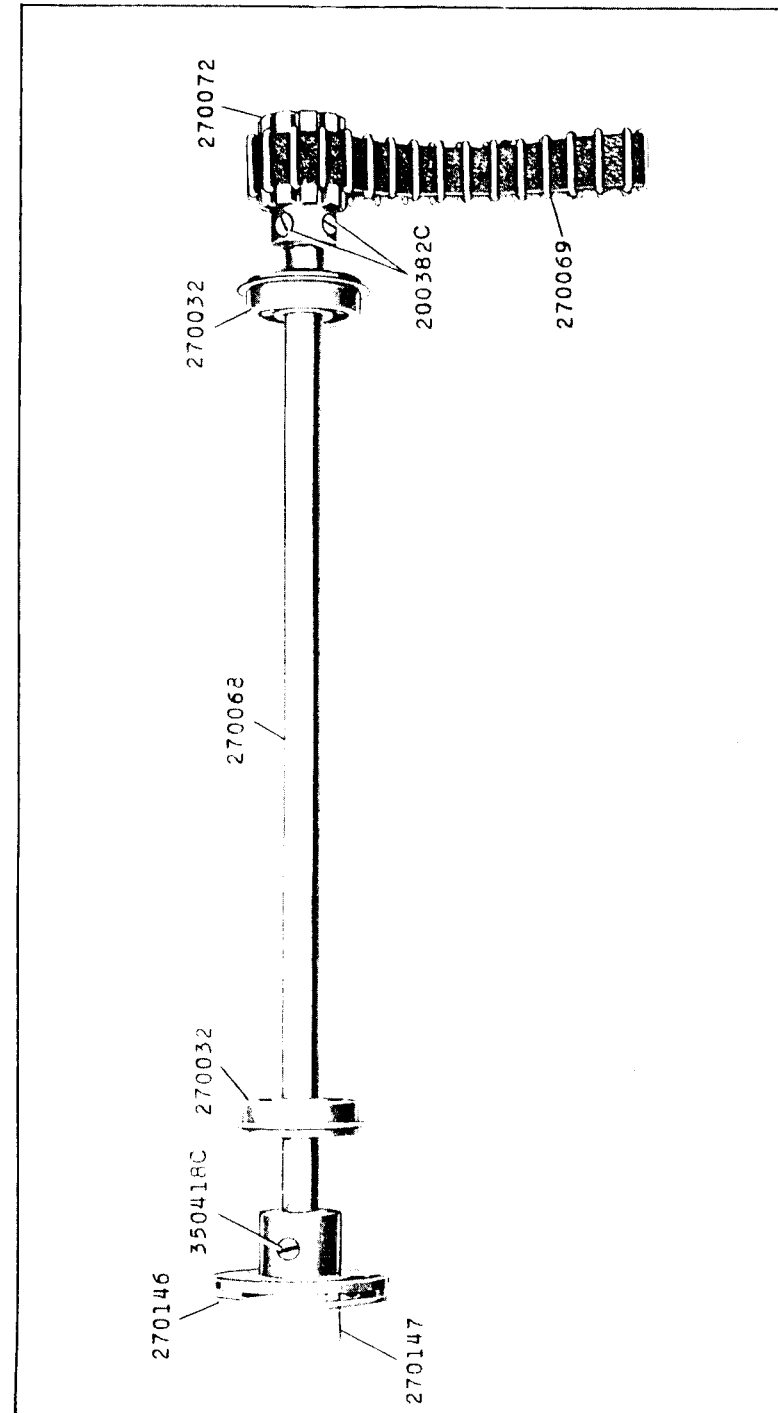

18312 - 3/8

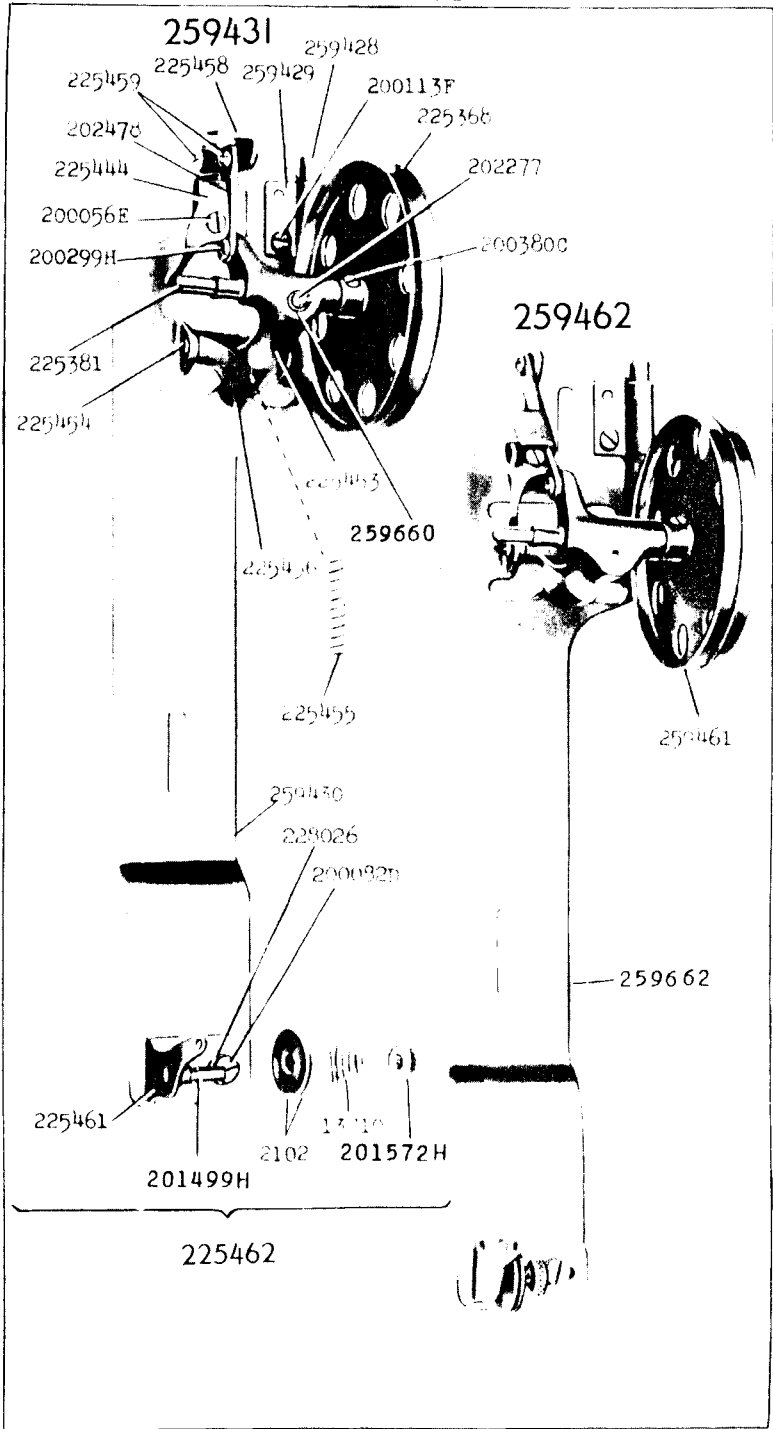

18362 - 1/6

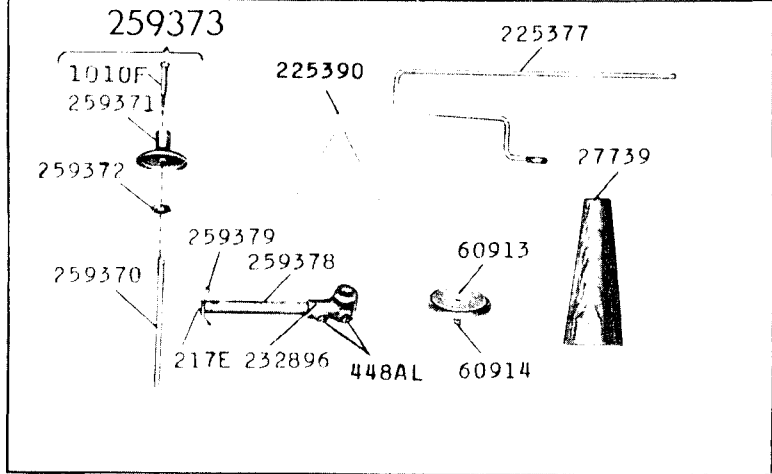
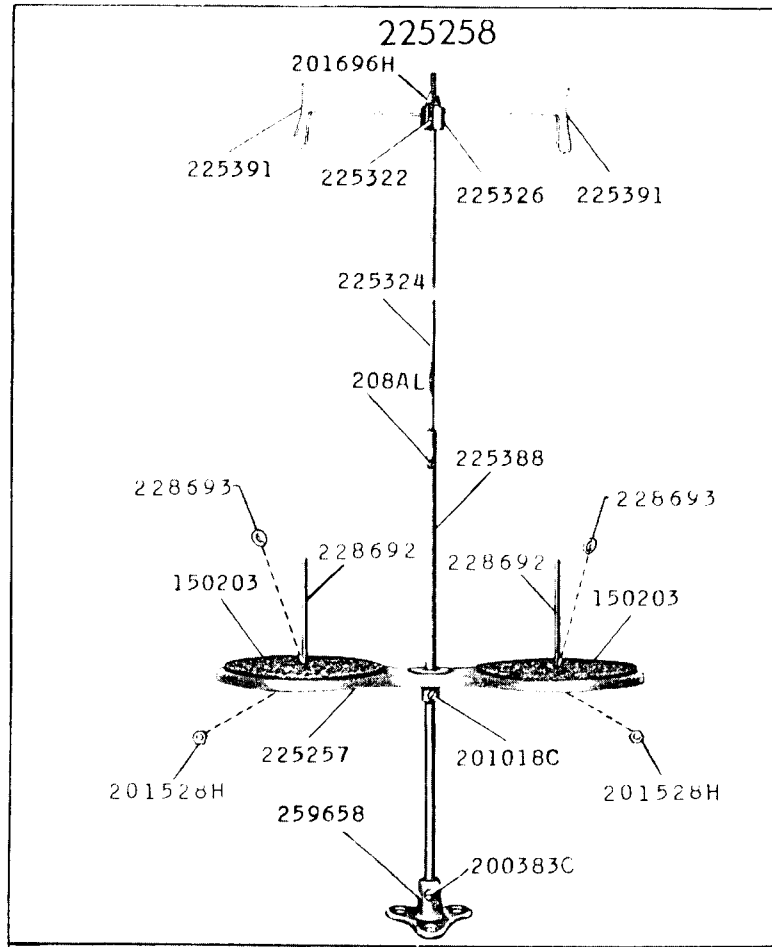

18376 - 3/8

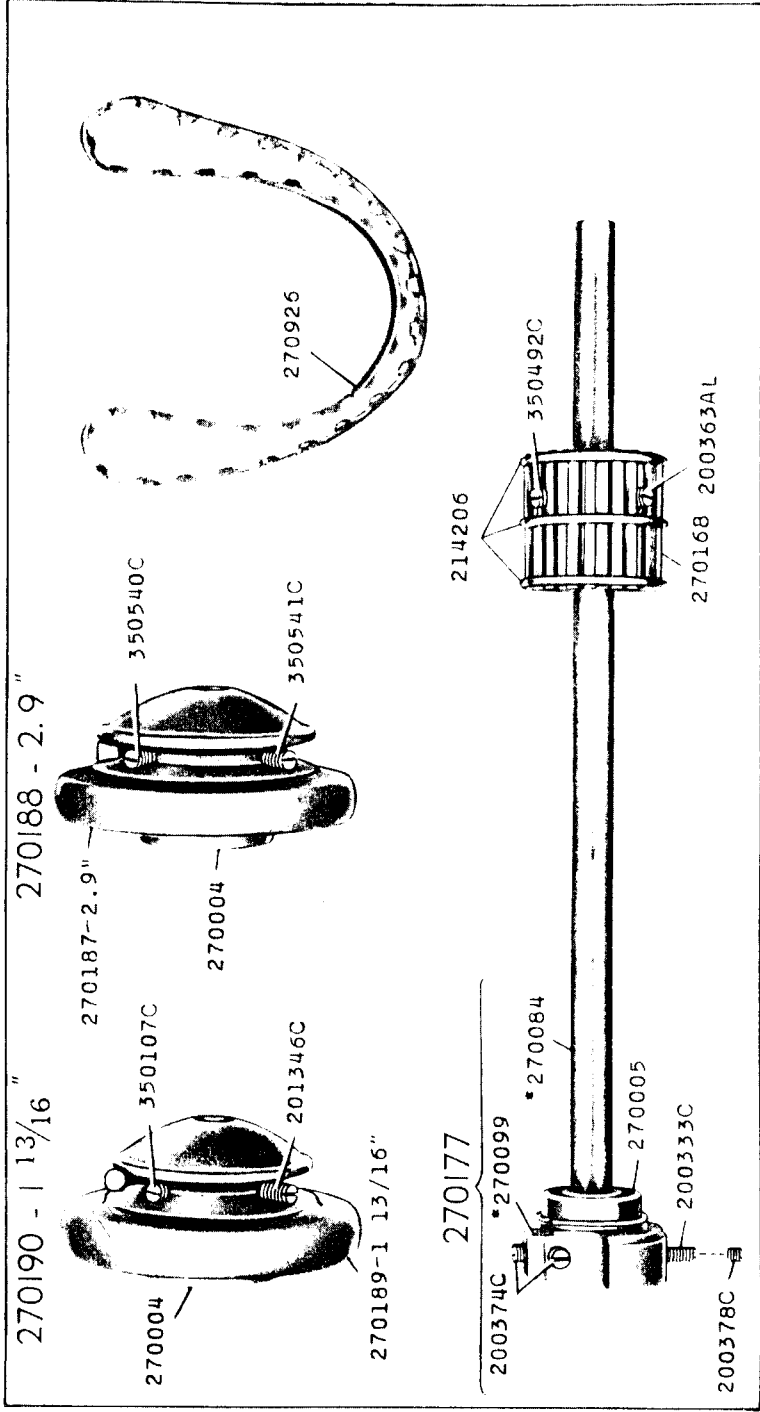

18416 - 3/4

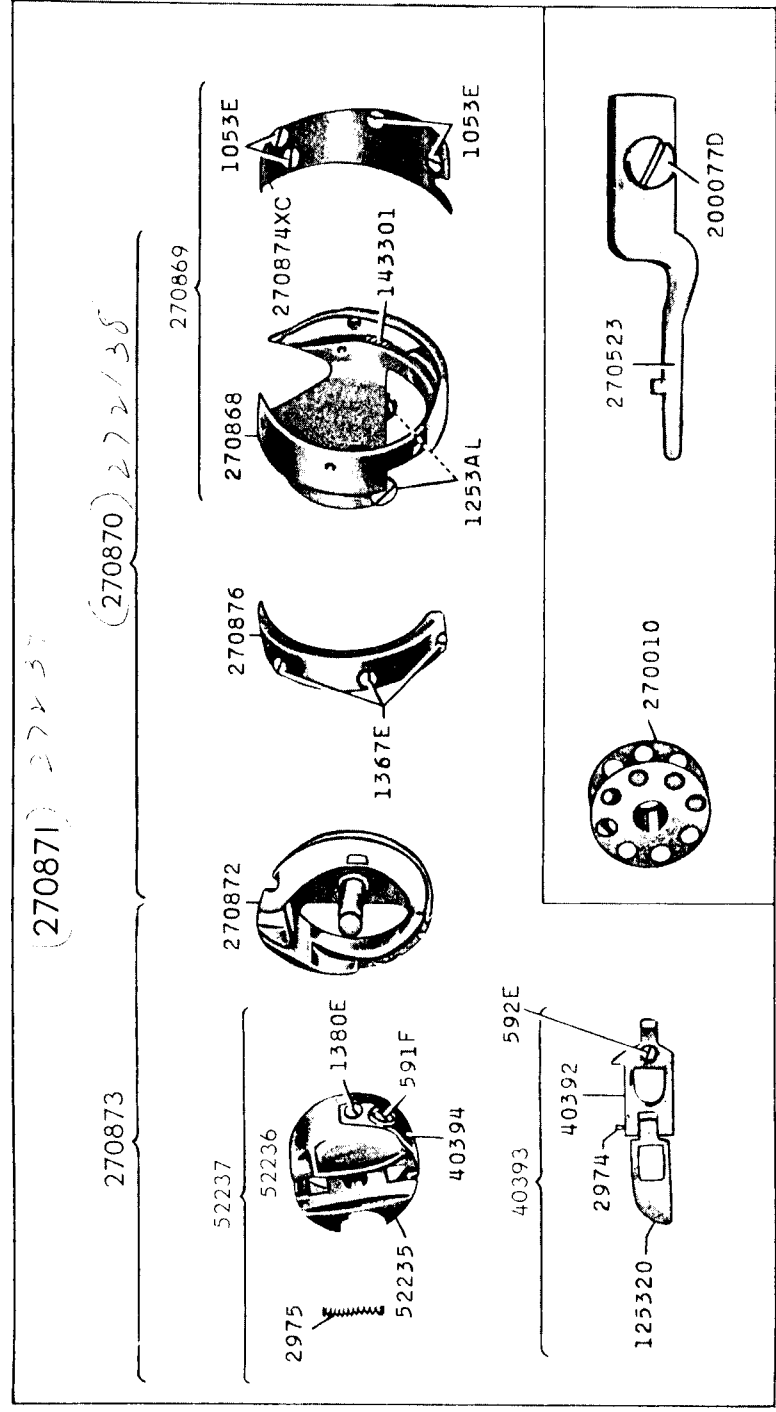

18441 - 1/2

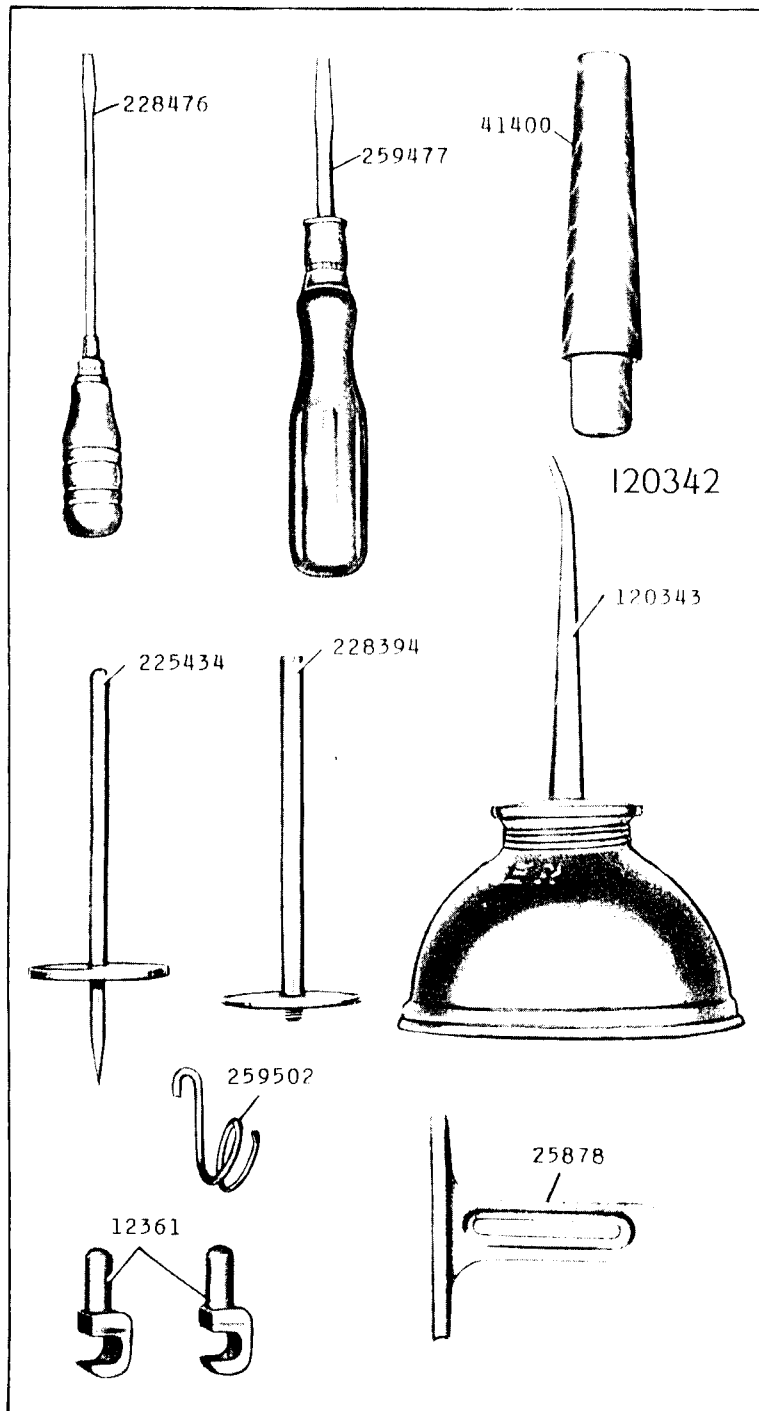

18442 - 2/3

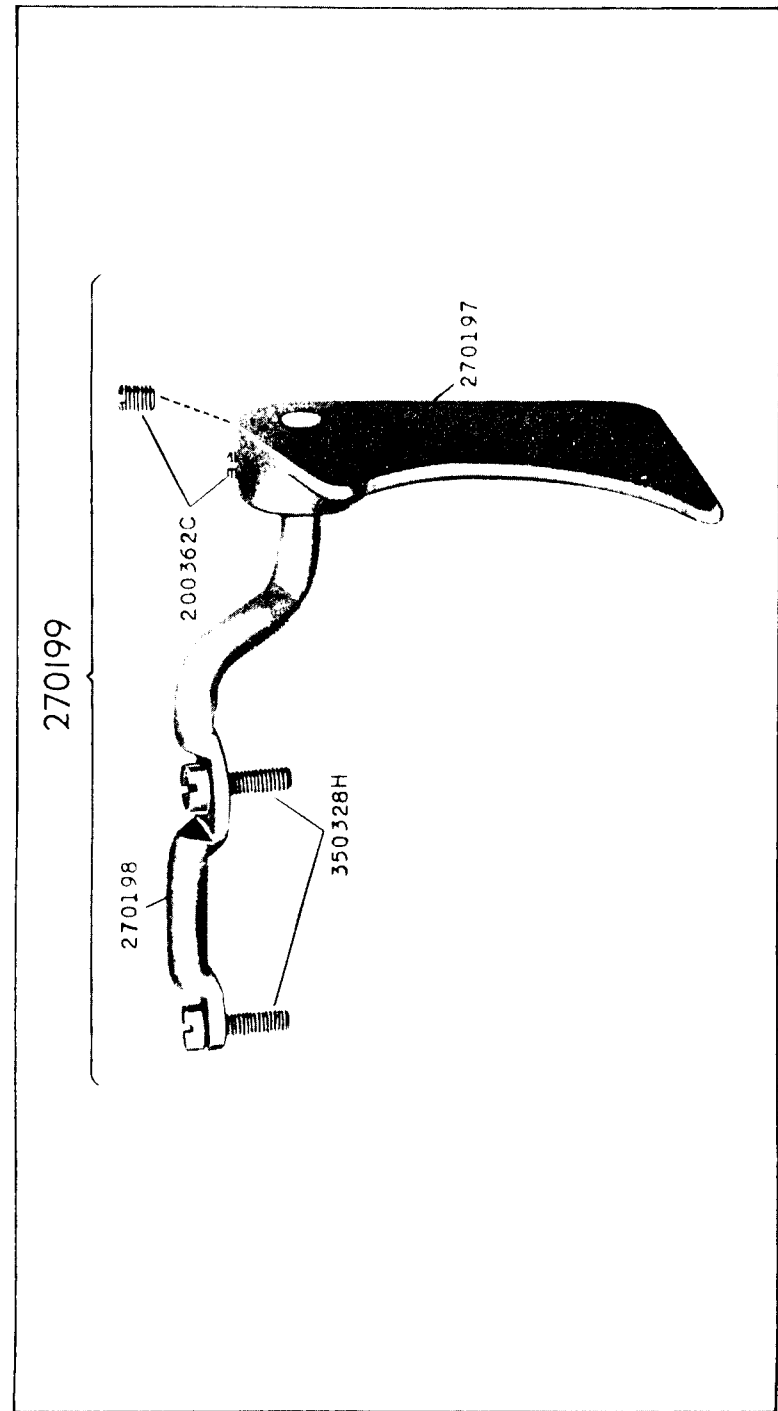

18467-1/4

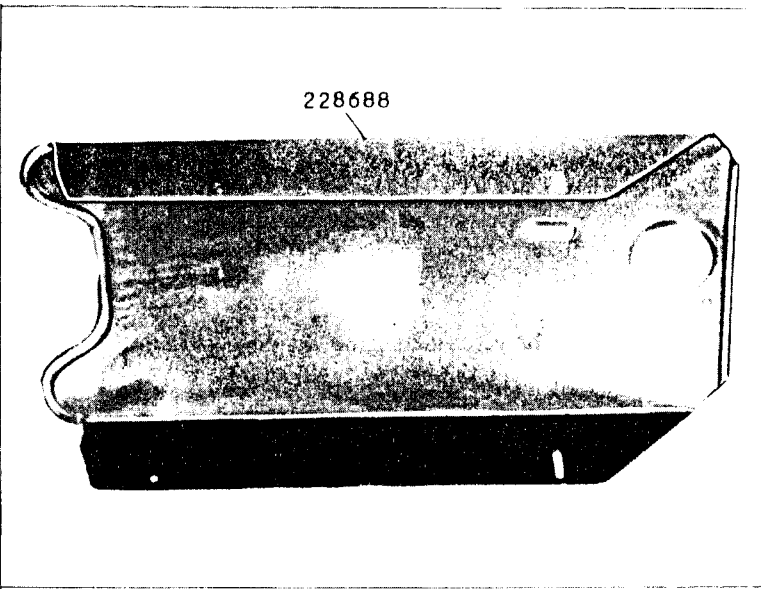

228688

228710 228371

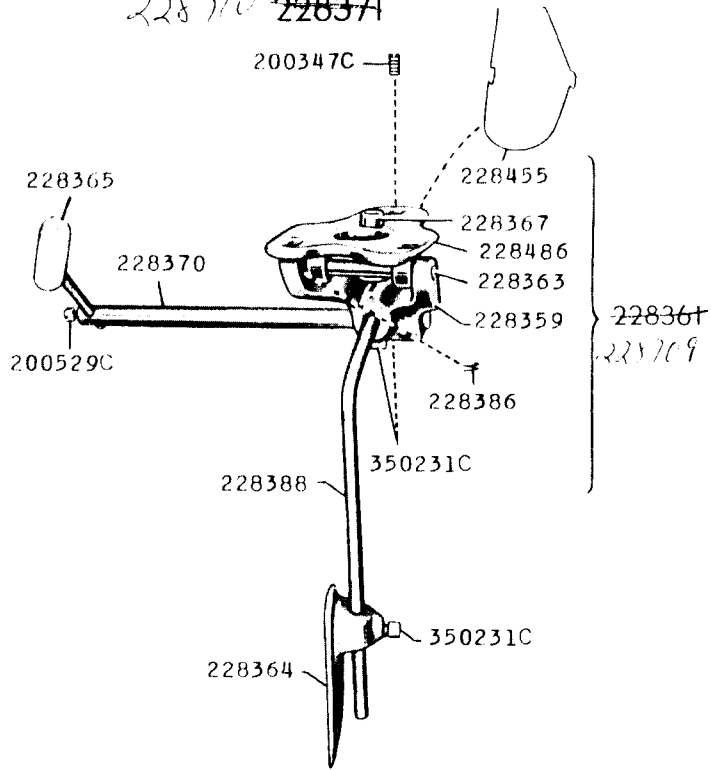

18468-3/8

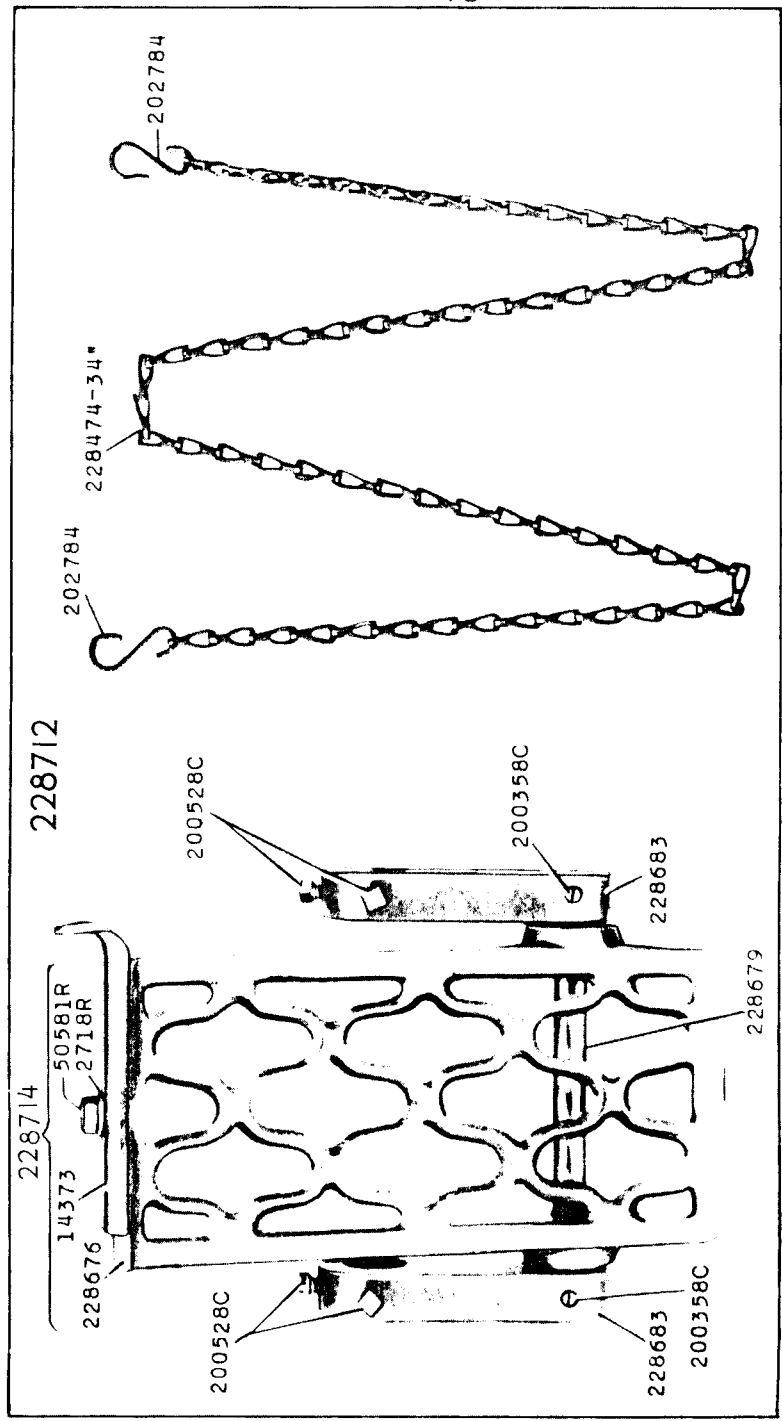

202784

228474-34\*

202784

228712

200528C

200358C

228683

228679

228714

14373

50581R

2718R

228676

200528C

228683

200358C

18469-3/8

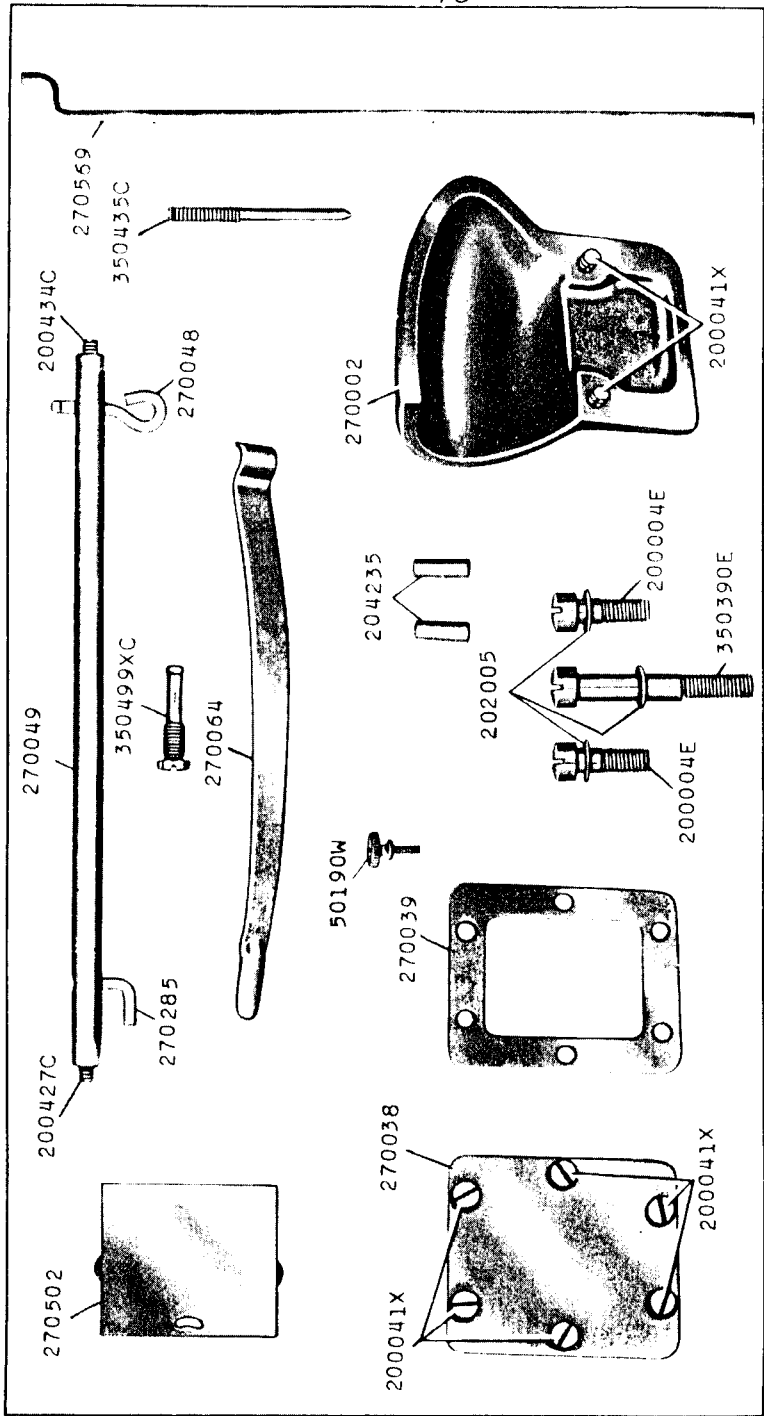

18470-1/2

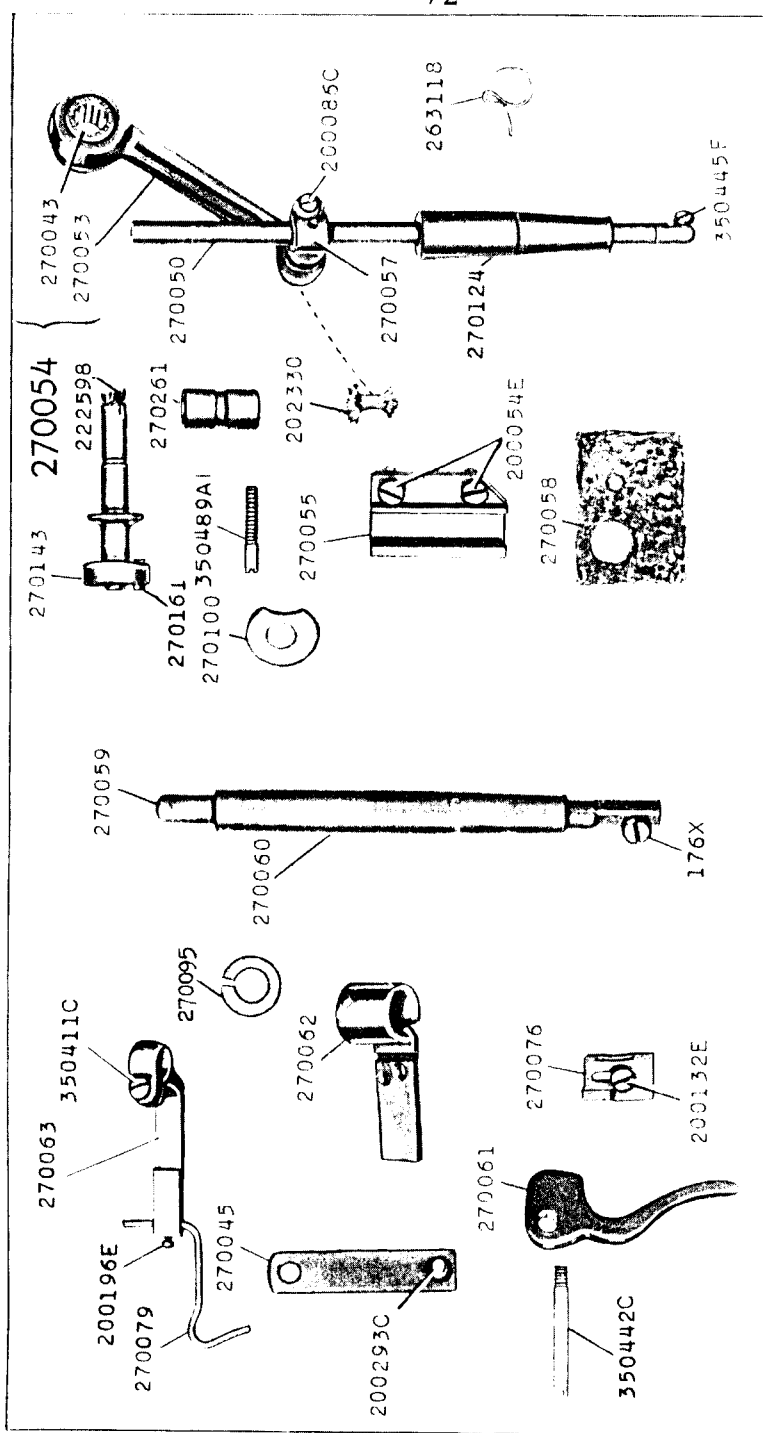





18473-1/2

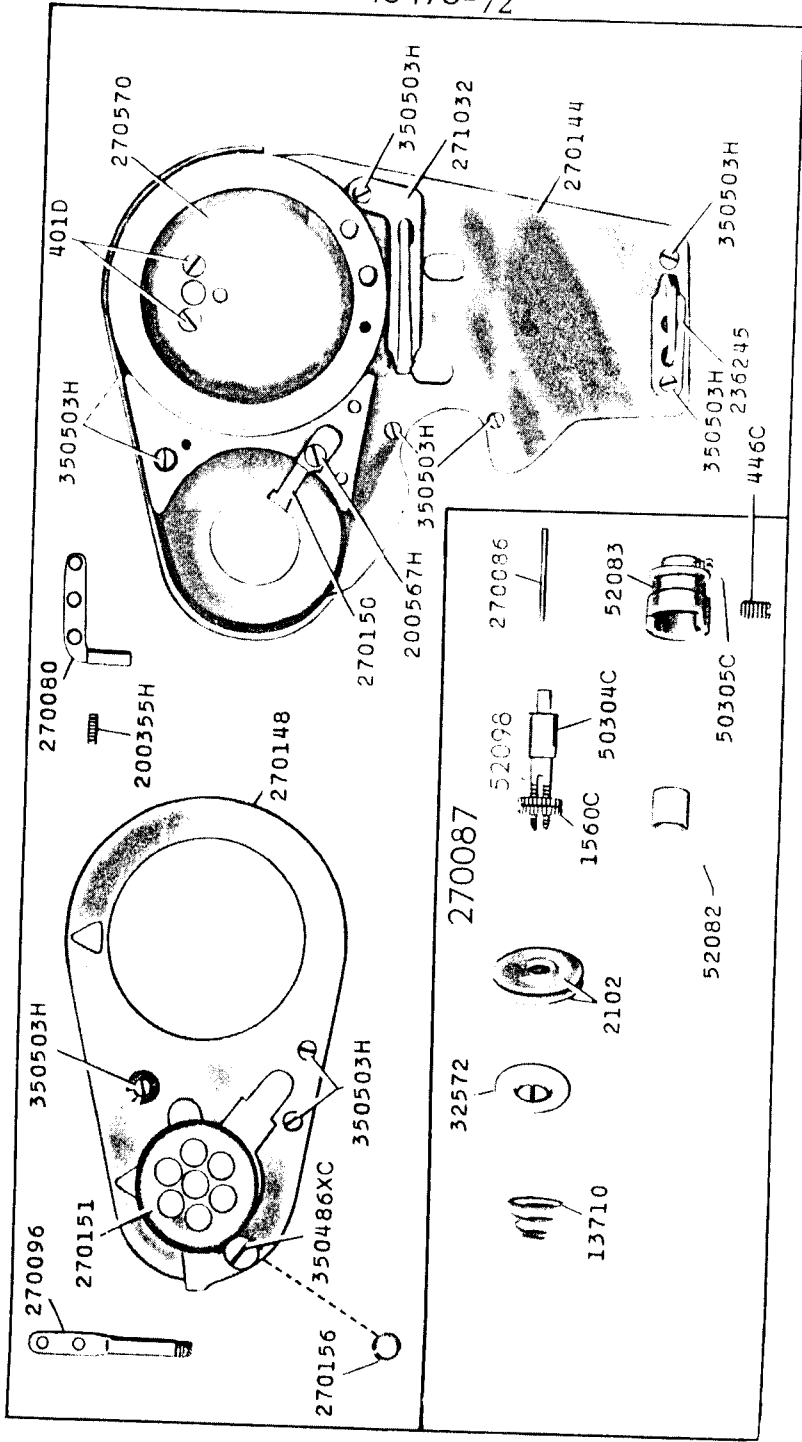

18474

