

Form 18413
February, 1930
PRINTED IN U.S.A.

LIST OF PARTS



MACHINES

Nos. 147-29 and 147-38

THE SINGER MANUFACTURING COMPANY

18413-1

COPYRIGHT, U. S. A., 1922, 1925, 1927, 1928 AND 1930
BY THE SINGER MANUFACTURING CO.
ALL RIGHTS RESERVED FOR ALL COUNTRIES

INDEX

	PAGE
ACCESSORIES.....	30
ATTACHMENTS.....	31
BELT GUARD.....	36
BENCH STAND.....	36
FEED ROLL (RUBBER).....	35
FOOT LIFTER PARTS.....	37
HEMMER.....	31
KNEE LIFTER PARTS.....	37
LAP SEAM FELLERS.....	33
MACHINE BASE.....	38
MACHINE NO. 147-29.....	7
" " 147-38.....	19
NUMERICAL LIST OF PARTS.....	43
OBSOLETE PARTS.....	40
SPOOL HOLDER.....	38
STRIP FOLDER.....	35
TAPE HOLDER (ADJUSTABLE).....	38
TAPE REEL.....	39
THREAD UNWINDER.....	40

INSTRUCTIONS FOR ORDERING

In ordering from this list, use **ONLY** the part NUMBER in the **FIRST** column.

The number stamped on a Sewing Machine part is in every case the number of the single part only.

Every combination of parts sent out as such has its specific number, which, although not stamped on the parts, must be used when ordering the combination.

Each number always indicates the **SAME PART** in whatever list it appears, or for whatever machine.

The letters after some of the numbers indicate the style of finish only, as follows:

- A—Hardened, Polished, Nickel Plated and Buffed
- B—Polished, Nickel Plated and Buffed
- C—Hardened Only
- D—Polished Only
- E—Soft, Not Polished
- F—Hardened and Polished
- H—Blued
- J—Nickel Plated Only
- K—Hardened and Nickel Plated
- L—Brass Plated
- M—Oxidized
- N—Japanned, Dull
- P—Japanned, Bright
- R—Merlized
- T—Copper Plated
- T. A.—Hardened, Polished, Copper and Nickel Plated and Buffed
- T. B.—Copper and Nickel Plated and Polished
- T. J.—Copper and Nickel Plated Only
- T. K.—Hardened, Copper and Nickel Plated
- T. M.—Copper Plated and Oxidized
- T. L.—Copper and Brass Plated
- U—Zinc Plated
- V—Silver Plated
- W—Polished and Nickel Plated
- Z—Chromium Plated
- Z. B.—Polished, Nickel Plated, Buffed and Chromium Plated
- Z. J.—Nickel and Chromium Plated

These letters **MUST BE USED** when they appear in the list; and **AFTER** the number **as** in the list.

In this series:

- 1 to 1500 and 50001 to 51500 are Screw Numbers
- 1501 to 1800 and 51501 to 51800 are Nut Numbers
- 1801 to 2000 and 51801 to 52000 are Roller Numbers
- 2001 to 50000 and 52001 and upward are numbers of Machine Parts

The figures in the second column refer only to the plates, illustrating the parts, and are **NOT TO BE USED** in ordering.

Parts marked with an asterisk (*) are furnished only when repairs are made at factory.

When ordering parts which differ as to **Gauge** (the distance between seams) the Gauge, as well as the **Number must be given** on order.

LIST OF PARTS COMPLETE FOR

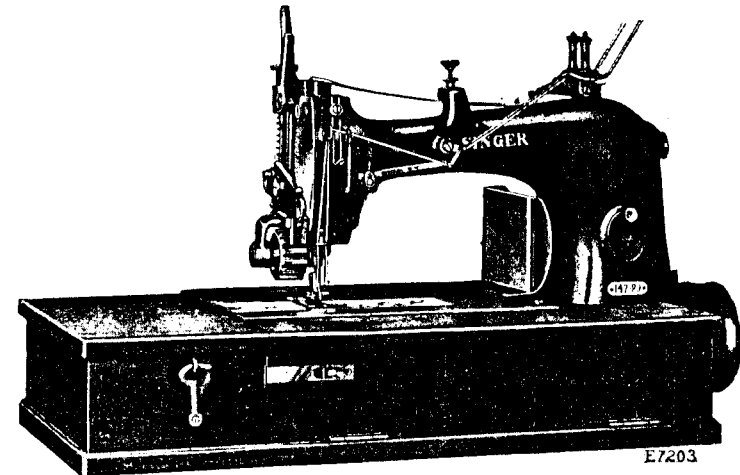

MACHINE No. 147-29

FOR TWO-LINE STITCHING IN FABRICS. TWO NEEDLES, TWO LOOPERS, FOR TWO THREAD CHAIN STITCH. FOOT LIFTER. GAUGES FROM $\frac{3}{2}$ INCH TO $\frac{3}{8}$ INCH. THE MACHINE IS FITTED WITH UPPER AND UNDER CORRUGATED FEED ROLLS ATTACHED TO THE MACHINE TO ASSIST IN CARRYING THE MATERIAL FROM THE MACHINE AFTER BEING STITCHED. THE UNDER ROLL RECEIVES ITS MOTION FROM AN ADJUSTABLE ECCENTRIC ON THE ROTARY SHAFT, BEING INDEPENDENTLY ADJUSTABLE TO BRING THE MOTION OF THE FEED ROLLS IN UNISON WITH THE FEEDING MECHANISM. SPEED 3400

NO.	PLATE	NAME
*54449	—	Arm, upper and lower (solid) with 948D and 54034.....
42366	8901	Arm Oil Pad (braided cotton) for oiling Arm Rock Shaft Front Bearing.....
56006	8901	Arm Oil Pad (braided cotton) for oiling Arm Rock Shaft Intermediate Bearing
56003	9000	Arm Oil Tube with 52045 for oiling 54326
52045	8901	“ “ “ Packing (braided cotton)...

NO.	PLATE	NAME
54002	8902	Arm Rock Shaft.....
54079	—	“ “ “ “ 54002 with 54004, 54005 and 64255.....
64386	8901	Arm Rock Shaft Bushing (back).....
64387	—	“ “ “ “ “ “ 6 4 3 8 6 with 52045.....
446c	8901	Arm Rock Shaft Bushing (back) Set Screw
64388	8901	“ “ “ “ (intermediate)
64389	—	“ “ “ “ “ “ 64388 with 52045.....
423c	8901	Arm Rock Shaft Bushing (intermediate) Set Screw.....
52045	8901	Arm Rock Shaft Bushing Oil Pad (braided cotton).....
54004	8901	Arm Rock Shaft Collar with two 453c...
453c	8901	“ “ “ “ Set Screw.....
54005	8901	“ “ “ Crank (back) with two 50083c.....
50083c	8901	Arm Rock Shaft Crank (back) Set Screw.
64255	8911	“ “ “ “ (front) with 453c
2117	8901	“ “ “ “ “ Pin.....
453c	8901	“ “ “ “ “ Set Screw
54105	8901	“ “ “ Flanged Bushing (front)
52045	8901	“ “ “ “ “ “ Oil Pad (braided cotton).....
453c	8901	Arm Rock Shaft Flanged Bushing (front) Set Screw.....
54006	9850	Arm Rotary Shaft.....
68017	—	“ “ “ “ 54006 with 640E, 54088, 54383, 54450, 64351, 64355, 68016 and 68018.....
54367	9000	Arm Rotary Shaft Bushing (front).....
761E	8901	“ “ “ “ “ S e t Screw.....
54007	8902	Arm Rotary Shaft Bushing (intermediate)
54089	—	“ “ “ “ “ “ 54007 with 64508 and 64805.....
64508	8902	Arm Rotary Shaft Bushing (intermediate) Oil Pad, long (braided cotton).....
64805	9000	Arm Rotary Shaft Bushing (intermediate) Oil Pad, short (braided cotton).....
422c	8901	Arm Rotary Shaft Bushing (intermediate) Set Screw (long).....
50084c	8901	Arm Rotary Shaft Bushing (intermediate) Set Screw (short).....
54450	9000	Arm Rotary Shaft Collar with two 1258c
1258c	8901	“ “ “ “ Set Screw.....

NO.	PLATE	NAME
54009	8902	Arm Rotary Shaft Flanged Bushing.....
54090	—	“ “ “ “ “ “ 54009 with 58039 and 64805.....
58039	8902	Arm Rotary Shaft Flanged Bushing Oil Pad, long (braided cotton).....
64805	9000	Arm Rotary Shaft Flanged Bushing Oil Pad, short (braided cotton).....
159F	8901	Arm Rotary Shaft Flanged Bushing Screw
49013	8904	“ “ “ “ Front Bearing Oil Pad (braided cotton).....
144D	8901	Arm Rotary Shaft Screw.....
15196	8902	“ “ “ “ Side Cover (back).....
286D	8904	“ “ “ “ Thumb Screw...
54010	8904	“ “ “ “ (front).....
286D	8904	“ “ “ “ Thumb Screw...
64259	8913	Balance Wheel with two 430c.....
430c	8904	“ “ “ “ Set Screw.....
68142	9850	Cloth Plate.....
68145	9850	“ “ “ “ Extension.....
1011F	8904	“ “ “ “ Screw.....
54309	9000	“ “ “ “ Oil Tube with 49092, for oiling 54458.....
49092	8908	Cloth Plate Oil Tube Packing (felt).....
54012	8902	“ “ “ “ Slide (left).....
38419	8904	“ “ “ “ “ Spring.....
725J	8904	“ “ “ “ “ Screw.....
54013	—	Cloth Plate Slide (left) complete, Nos. 38419, 54012 and two 725J.....
54014	8913	Cloth Plate Slide (right) for 54015.....
54055	9868	“ “ “ “ “ “ 54056.....
68166	—	“ “ “ “ “ “ 68167.....
38419	8904	“ “ “ “ “ Spring.....
725J	8904	“ “ “ “ (left) Spring Screw.....
54015	—	Cloth Plate Slide (right) complete, for 68144, Nos. 38419, 54014 and two 725J
54056	—	Cloth Plate Slide (right) complete for 68143, Nos. 38419, 54055 and two 725J
68167	—	Cloth Plate Slide (right) complete for 68248, Nos. 38419, 68166 and two 725J.
68144	—	Cloth Plate complete, for $\frac{3}{8}$ in. to $\frac{5}{8}$ in. gauges, for 46089, Nos. 54013, 54015, 54309 and 68142.....
68143	—	Cloth Plate complete, for $\frac{3}{8}$ in. to $\frac{1}{4}$ in. gauges, for 46090, Nos. 54013, 54056, 54309 and 68142.....

NO.	PLATE	NAME
68248	—	Cloth Plate complete, for $\frac{3}{8}$ in. to $\frac{3}{8}$ in. gauges, for 46090, Nos. 54013, 54309, 68142 and 68167.
1011f	8904	Cloth Plate Screw (left).
50473f	8904	" " " (right).
68146	9859	" " " Thread Guard.
50473f	8904	" " " " Screw (long).
1235f	8904	" " " " " (short).
54017	8902	Crank Connecting Rod with 6575, 54018, 54218, 54897, 57222 and two each 896E and 1057E.
54088	—	Crank Connecting Rod 54017 with 50069c
50069c	8904	" " " " Ball Screw Stud
1516E	8904	" " " " " Nut.
64268	8904	Crank Connecting Rod Ball Screw Stud Washer.
*57222	—	Crank Connecting Rod Cap (lower).
896E	8904	" " " " " Screw
*54018	—	" " " " " (upper).
1057E	8904	" " " " " Screw
54897	8904	" " " " Oil Cup.
54218	8904	" " " " " Pad (braided cotton).
6575	8904	Crank Connecting Rod Oil Pad Stop Pin
64269	8913	Face Plate.
46111	8911	" " " Pin.
286b	8904	" " " Thumb Screw.
54019	8902	Feed Bar with 50429c and two 453c.
54020	8902	" " " Connection.
57225	8904	" " " Hinge Pin.
453c	8901	" " " " " Set Screw.
54111	8902	" " " " " Connecting Rod with 1057E, 54112 and two 896E.
68018	—	Feed Connecting Rod 54111 with 54456.
*54112	—	" " " " Cap.
896E	8904	" " " " " Screw.
1057E	8904	" " " " " Clamping Screw.
54023	8911	" " " " " Hinge Pin.
21506	8904	" " " " " Collar with 457c.
457c	8904	Feed Connecting Rod Hinge Pin Collar Set Screw.
46081	9852	Feed Dog, 17 teeth (16 teeth to the inch) for 46090.
157w	8904	Feed Dog Screw.
50429c	8904	" " " Stop Screw.

NO.	PLATE	NAME
*54024	—	Feed Eccentric.
*54455	—	" " " Body.
443c	8904	" " " " Set Screw.
7071	8904	" " " Clamping Washer.
217D	8904	" " " " " Screw.
54456	9000	Feed Eccentric (adjustable) complete, Nos. 217D, 1103c, 7071, 54024, 54455 and two 443c.
1103c	8904	Feed Regulating Screw.
54026	9851	" " " " " Rocking Frame with two 453c.
54077	—	" " " " " 54026 with 21506, 54019, 54020, 54023 and 57225.
57234	8911	Feed Rocking Frame Hinge Pin.
57235	9000	" " " " " " Bushing
453c	8901	" " " " " " " Set Screw.
453c	8901	Feed Rocking Frame Hinge Pin Set Screw
54457	9864	" " " " " Roll (lower) with two 50333c.
68147	9854	" " " " " Clutch (brake).
68148	9854	" " " " " (drive).
68149	9854	" " " " " (brake) Connection with 440c, 1700j and two 50083c.
440c	9853	Feed Roll (lower) Clutch (brake) Connection Adjusting Screw.
1700j	9853	Feed Roll (lower) Clutch (brake) Connection Adjusting Screw Nut.
50083c	8901	Feed Roll (lower) Clutch (brake) Connection Set Screw.
127530	9000	Feed Roll (lower) Clutch (brake) Connection Stop Block.
158b	9853	Feed Roll (lower) Clutch (brake) Connection Stop Block Screw.
68150	9854	Feed Roll (lower) Clutch (drive) Connection with two 50083c.
50083c	8901	Feed Roll (lower) Clutch (drive) Connection Set Screw.
68151	9000	Feed Roll (lower) Clutch Roller.
68152	9000	" " " " " " Plunger.
68153	9000	" " " " " " Spring.
68154	9850	" " " " " Shaft.
68157	—	" " " " " " 68154 with 68156.
54467	9859	Feed Roll (lower) Clutch Shaft Bracket.
68207	—	Feed Roll (lower) Clutch Shaft Bracket complete, Nos. 54457, 54467, 68157, 127530 and two each 158b and 62562.

NO.	PLATE	NAME
62562	9000	Feed Roll (lower) Clutch Shaft Bracket Collar with 465c.....
465c	8909	Feed Roll (lower) Clutch Shaft Bracket Collar Set Screw.....
948d	8958	Feed Roll (lower) Clutch Shaft Bracket Screw.....
68155	9854	Feed Roll (lower) Clutch Sleeve with four 1149c.....
1149c	9853	Feed Roll (lower) Clutch Sleeve Set Screw
68156	—	Feed Roll (lower) Clutch complete, Nos. 68147 to 68150, 68155 and six each 68151 to 68153.....
54458	9854	Feed Roll (lower) Connecting Rod with 51112 and two 896E.....
68016	—	Feed Roll (lower) Connecting Rod 54458 with 54456.....
*54112	—	Feed Roll (lower) Connecting Rod Cap
896E	8904	“ “ “ “ “ “ Screw.....
1257c	9853	Feed Roll (lower) Connecting Rod Hinge Screw.....
1620E	9853	Feed Roll (lower) Connecting Rod Hinge Screw Nut.....
*54024	—	Feed Roll (lower) Eccentric.....
*54455	—	“ “ “ “ Body.....
443c	8904	“ “ “ “ “ S e t Screw.....
7071	8904	Feed Roll (lower) Eccentric Clamping Washer.....
217d	8904	Feed Roll (lower) Eccentric Clamping Washer Screw.....
54456	9000	Feed Roll (lower) Eccentric (adjustable) complete, Nos. 217d, 1103c, 7071, 54024, 54455 and two 443c.....
1103c	8904	Feed Roll (lower) Eccentric Regulating Screw.....
50333c	9853	Feed Roll (lower) Set Screw.....
54457	9864	“ “ (upper) with two 50333c.....
127534	9851	“ “ “ Bar.....
54469	9851	“ “ “ “ Bracket with 453c
54170	—	Feed Roll (upper) Bar Bracket complete, Nos. 79c, 866c, 913d, 1330c, 1876, 23404, 38648, 54469, 54471 to 54473, 54475, 127534, 127536, 127542 and two 208d.....
1193d	9853	Feed Roll (upper) Bar Bracket Screw (lower).....

NO.	PLATE	NAME
769c	9853	Feed Roll (upper) Bar Bracket Screw (upper).....
127536	9000	Feed Roll (upper) Bar Collar with 448c..
1876	9000	“ “ “ “ Roller and Screw Stud.....
448c	8958	Feed Roll (upper) Bar Collar Set Screw..
23404	9000	“ “ “ “ Spring.....
127538	9854	“ “ “ Bracket with 453c....
54475	—	“ “ “ “ 127538 with 54457 and 127546.....
127542	9000	Feed Roll (upper) Bracket Guide Pin....
453c	8901	“ “ “ “ “ “ Set Screw.....
453c	8901	Feed Roll (upper) Bracket Set Screw....
54471	9855	“ “ “ “ Lifter.....
866c	9853	“ “ “ “ Hinge Screw....
54472	9855	“ “ “ “ Latch.....
79c	9853	“ “ “ “ “ H i n g e Screw.....
38648	9856	Feed Roll (upper) Lifter Latch Spring..
54473	9856	“ “ “ “ “ S t o p
208d	8910	“ “ “ “ “ “ “ Screw.....
1330c	9853	Feed Roll (upper) Lifter Stop Screw..
913d	—	“ “ “ “ Pressure Regulating Thumb Screw.....
50333c	9853	Feed Roll (upper) Set Screw.....
127546	9856	“ “ “ Shaft.....
13172 (54106)	9856	Looper (back) closed eye.....
NOTE: When ordering No. 54106, state gauge of machine for which required.		
1147c	8922	Looper (back) Set Screw.....
1314 (54107)	9856	“ (front) closed eye.....
NOTE: When ordering No. 54107 state gauge of machine for which required.		
1120c	8958	Looper (front) Set Screw.....
54027	8960	“ Carrier with two 171d.....
171d	8958	“ “ Adjusting Screw.....
54227	8960	“ “ Connection.....
54228	8960	“ “ “ Shaft.....
54229	8960	“ “ “ “ Bushing
446c	8901	“ “ “ “ “ Set Screw.....
49013	8904	Looper Carrier Connection Shaft Oil Pad (braided cotton).....
54230	8960	Looper Carrier Driver with 54032 and four 175E.....

NO.	PLATE	NAME
*54032	—	Looper Carrier Driver Cap.....
175E	8908	“ “ “ “ Screw.....
54368	9856	“ Driving Shaft and Feed Lifting Eccentric with 227D and two 64315....
54383	—	Looper Driving Shaft and Feed Lifting Eccentric 54368 with 54027, 54227, 54228 and 54230.....
*54034	—	Looper Driving Shaft and Feed Lifting Eccentric Bracket with 761E.....
54080	8960	Looper Driving Shaft and Feed Lifting Eccentric Bracket Bushing.....
761E	8901	Looper Driving Shaft and Feed Lifting Eccentric Bracket Bushing Set Screw..
948D	8958	Looper Driving Shaft and Feed Lifting Eccentric Bracket Screw.....
64315	8960	Looper Driving Shaft and Feed Lifting Eccentric Oil Hole Plug.....
227D	8958	Looper Driving Shaft and Feed Lifting Eccentric Oil Hole Plug Screw.....
40326	9856	Looper Driving Shaft and Feed Lifting Eccentric Oil Pad (braided cotton)....
640E	8908	Looper Driving Shaft and Feed Lifting Eccentric Screw.....
54061	8922	Looper Holder with 1120c and 1147c....
704W	8958	“ “ “ “ Screw.....
64319	8922	Needle Bar (hollow).....
54062	—	Needle Bar complete, for $\frac{3}{32}$ in. to $\frac{1}{4}$ in. gauges, Nos. 54064, 54065 and 64319..
54063	—	Needle Bar complete, for $\frac{3}{32}$ in. to $\frac{3}{8}$ in. gauges, Nos. 54064, 54066 and 64319..
38456	8991	Needle Bar Bushing (lower).....
1133E	8958	“ “ “ “ Set Screw...
64320	8991	“ “ “ “ (upper).....
1133E	8958	“ “ “ “ Set Screw...
54326	8991	“ “ Connecting Link.....
54327	8991	“ “ “ “ Hinge Stud
1520J	8991	“ “ “ “ “ “
		Nut.....
54328	8991	Needle Bar Connecting Stud with 211F and two 187E.....
187E	8958	Needle Bar Connecting Stud Clamping Screw.....
54064	8922	Needle Clamp with two 1498F.....
54065	8922	“ “ Thread Guard, for 54062..
54066	8922	“ “ “ “ “ 54063..
54067	8922	“ Guard, for $\frac{3}{32}$ in. to $\frac{5}{32}$ in. gauges.
54068	8922	“ “ “ $\frac{3}{16}$ in. to $\frac{3}{32}$ in. gauges.

NO.	PLATE	NAME
54069	8922	Needle Guard, for $\frac{5}{16}$ in. to $\frac{3}{8}$ in. gauges.
54038	8991	“ “ “ “ Holder.....
176D	8958	“ “ “ “ Screw.....
217F	8904	“ “ “ “ Screw.....
1498F	8922	“ Set Screw.....
54108	—	Oil Tube.....
54109	—	“ “ Bracket.....
49092	8908	“ “ Packing (felt).....
54110	8908	Oil Tube complete, for oiling Crank Con- necting Rod (upper bearing) Nos. 49092, 54108 and 54109.....
64330	9855	Presser Bar with 25303.....
25303	9856	“ “ “ “ Ball, size $\frac{1}{4}$ in.....
64331	8911	“ “ “ “ Bushing (lower).....
1133E	8958	“ “ “ “ “ Set Screw...
38456	8991	“ “ “ “ (upper).....
1133E	8958	“ “ “ “ “ Set Screw..
54039	8908	“ “ “ “ Guide Bracket with 453c, 640W and 1963.....
640W	8908	Presser Bar Guide Bracket Adjusting Screw.....
11173	8908	Presser Bar Guide Bracket Guide.....
447C	8908	“ “ “ “ “ “ Set Screw.....
1963	8908	Presser Bar Guide Bracket Roller and Stud
453C	8901	“ “ “ “ “ Set Screw....
54474	9856	“ “ “ “ Lifter.....
57258	8911	“ “ “ “ Hinge Pin.....
447C	8908	“ “ “ “ “ Set Screw..
1872	8908	“ “ “ “ Roller and Stud.....
1250C	8911	“ “ “ “ Stop Screw.....
61047	8911	“ “ “ “ Lifting Bracket with 460c and 1872.....
68208	9855	Presser Bar Lifting Lever.....
61075	8911	“ “ “ “ “ Connecting Stud.....
460C	8910	Presser Bar Lifting Lever Connecting Stud Set Screw.....
68184	9855	Presser Bar Lifting Lever Extension.....
161D	8908	“ “ “ “ “ “ Screw (left).....
176D	8958	Presser Bar Lifting Lever Extension Screw (right).....
802D	8908	Presser Bar Lifting Lever Hinge Screw...
54040	9855	“ “ “ “ Spring (flat).....
38468	8908	“ “ “ “ Stud.....
26276	8911	“ Foot Hinge Pin.....

NO.	PLATE	NAME
53075	—	Presser Foot Plate.....
46087	—	“ “ Shank.....
53076	9857	Presser Foot (hinged) complete, Nos. 26276, 46087 and 53075.....
190d	8908	Presser Foot Screw.....
574w	8908	Pressure Regulating Thumb Screw.....
1539w	8908	“ “ “ “ Lock Nut.....
54381	9856	Slack Thread Controller.....
54242	9856	“ “ “ Clamp.....
190d	8908	“ “ “ “ Screw....
64337	8922	“ “ “ Regulator.....
54042	8908	“ “ “ “ Holder with 175E and 50150c.....
175E	8908	Slack Thread Regulator Holder Clamping Screw.....
54043	8908	Slack Thread Regulator Holder Shaft
24292	8908	“ “ “ “ “ Collar with 1019c.....
1019c	8908	Slack Thread Regulator Holder Shaft Collar Set Screw.....
54044	8908	Slack Thread Regulator Holder Shaft Crank (forked) with 1253c.....
1253c	8908	Slack Thread Regulator Holder Shaft Crank Set Screw.....
50150c	8908	Slack Thread Regulator Set Screw.....
2102	8909	Tension (under thread) Disc.....
51570c	9853	“ “ “ “ Regulating Thumb Nut.....
50326c	9853	Tension (under thread) Screw Stud.....
59539	—	“ “ “ “ “ 50326c with 51570c.....
59534	9858	Tension (under thread) Spring.....
59537	9858	“ “ “ “ “ Bushing (large).....
59538	9858	Tension (under thread) Spring Bushing (small).....
17547	8909	Tension (under thread) Thread Guide...
54070	8996	“ (upper thread) Bracket.....
376d	8909	“ “ “ “ “ Screw....
2102	8909	“ “ “ “ “ Disc.....
51570c	9853	“ “ “ “ “ Regulating Thumb Nut.....
32572	8909	Tension (upper thread) Releasing Disc...
54988	8909	“ “ “ “ “ Pin....
54071	8922	“ “ “ “ “ Shaft

NO.	PLATE	NAME
54047	8909	Tension (upper thread) Releasing Shaft Crank with 624c.....
54048	8909	Tension (upper thread) Releasing Shaft Crank Link.....
624c	8909	Tension (upper thread) Releasing Shaft Crank Set Screw.....
68261	—	Tension (upper thread) Releasing Shaft Spring.....
316F	8909	Tension (upper thread) Releasing Shaft Stop Screw.....
1547J	8909	Tension (upper thread) Releasing Shaft Stop Screw Nut.....
50326c	9853	Tension (upper thread) Screw Stud.....
59539	—	“ “ “ “ “ 50326c with 51570c.....
59535	9858	Tension (upper thread) Spring.....
59537	9858	“ “ “ “ “ Bushing (large).....
59538	9858	Tension (upper thread) Spring Bushing (small).....
57076	9858	Tension (upper thread) Thread Guide...
53225	9858	Thread (under) Eyelet (back).....
190d	8908	“ “ “ “ “ Screw....
54072	9858	“ “ “ “ (front).....
64351	8909	“ “ “ “ “ Nipper Cam with 465c..
465c	8909	“ “ “ “ “ Set Screw..
38210	8909	“ “ “ “ “ Spring (lower)...
38211	8909	“ “ “ “ “ (upper)
46247	8909	“ “ “ “ “ “ Stop.....
176d	8958	Thread (under) Nipper Spring Screw....
38475	8910	“ “ “ “ “ Take-up with 465c.....
465c	8909	“ “ “ “ “ Set Screw.....
54435	9858	“ “ “ “ “ Staple with 590d and 38481.....
54049	9855	Thread (under) Take-up Staple Bracket with 460c.....
965d	8910	Thread (under) Take-up Staple Bracket Screw.....
46041	8909	Thread (under) Take-up Staple Spring
190d	8908	“ “ “ “ “ “ Screw.....
38481	8910	Thread (under) Take-up Staple Thread Guard.....
590d	8958	Thread (under) Take-up Staple Thread Guard Screw.....

NO.	PLATE	NAME
38482	8910	Thread (under) Take-up Stripper.....
207b	8910	" " " " Screw.
64355	8910	" " " Thread Guard (brass).....
64356	8910	Thread (under) Take-up Thread Guard Steady Pin.....
460c	8910	Thread (under) Take-up Thread Guard Steady Pin Set Screw.....
54330	9858	Thread (upper) Controller.....
207b	8910	" " " Screw.....
46009	9858	" " Eyelet.....
190b	8908	" " " Screw.....
54094	8922	" " Take-up.....
54095	8922	" " " Plate.....
68164	9858	" " " " Spring
1449b	8922	" " " " "
		Screw.....
54096	—	Thread (upper) Take-up complete, Nos. 1449b, 54094, 54095 and 68164.....
211f	8958	Thread (upper) Take-up Set Screw.....
46090	9852	Throat Plate, for $\frac{3}{16}$ in. to $\frac{3}{8}$ in. gauges, for 46081.....
742f	8910	Throat Plate Screw.....

Genuine Singer Needles and their Containers are marked with the Company's Trade Mark "SIMANCO." 1

Needles in Containers marked "For Singer Machines" are not Singer made needles. 2

**LIST OF PARTS COMPLETE
FOR**

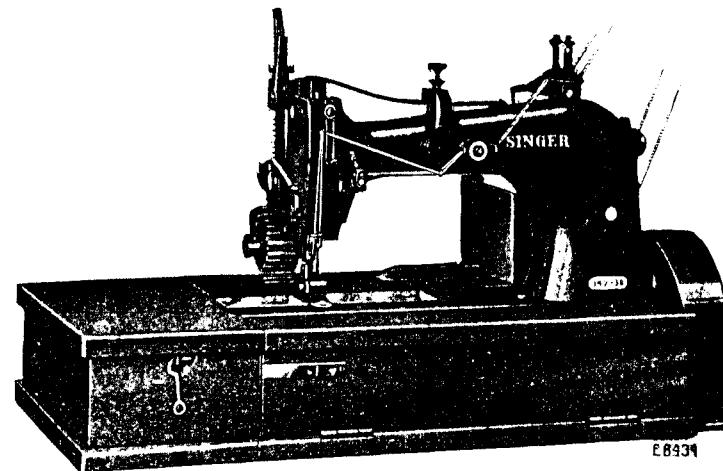

MACHINE No. 147-38

FOR WORK ON AWNINGS, HEAVY OVERALLS, STITCHING FRINGE AND TAPE TO RUGS AND WORK OF A SIMILAR NATURE REQUIRING A LONG NEEDLE BAR STROKE AND PULLER FEED. TWO NEEDLES, TWO LOOPERS, FOR TWO THREAD CHAIN STITCH. FOOT LIFTER. GAUGES $\frac{3}{16}$ TO $\frac{3}{8}$ INCH. NEEDLE BAR STROKE $1\frac{5}{16}$ INCH. UPPER THREAD NIPPER. THE MACHINE IS FITTED WITH UPPER AND UNDER CORRUGATED FEED ROLLS ATTACHED TO THE MACHINE TO ASSIST IN CARRYING THE MATERIAL FROM THE MACHINE AFTER BEING STITCHED. THE UNDER ROLL RECEIVES ITS MOTION FROM AN ADJUSTABLE ECCENTRIC ON THE ROTARY SHAFT, BEING INDEPENDENTLY ADJUSTABLE TO BRING THE MOTION OF THE FEED ROLLS IN UNISON WITH THE FEEDING MECHANISM. SPEED 2800.

NOTE: Fittings as listed are for Lap Seam Felling on Awnings or work of a similar nature.

NO.	PLATE	NAME
*68217	—	Arm, upper and lower (solid) with 948b and 54034

NO.	PLATE	NAME
42366	8901	Arm Oil Pad (braided cotton) for oiling Arm Rock Shaft Front Bearing.....
56006	8901	Arm Oil Pad (braided cotton) for oiling Arm Rock Shaft Intermediate Bearing.
11119	8901	Arm Oil Tube with 52045, for oiling 68137
56003	9000	" " " " " " " " 54326
52045	8901	" " " " Packing (braided cotton)...
68118	9850	" Rock Shaft.....
68119	-----	" " " 68118 with 54004, 54005 and 64255.....
64386	8901	Arm Rock Shaft Bushing (back).....
64387	-----	" " " " " " 64386 with 52045.....
446c	8901	Arm Rock Shaft Bushing (back) Set Screw
64388	8901	" " " " (intermediate)
64389	-----	" " " " " "
		64388 with 52045.....
423c	8901	Arm Rock Shaft Bushing (intermediate) Set Screw.....
52045	8901	Arm Rock Shaft Bushing Oil Pad (braided cotton).....
54004	8901	Arm Rock Shaft Collar with two 453c...
453c	8901	" " " " Set Screw.....
54005	8901	" " " " Crank (back) with two 50083c.....
50083c	8901	Arm Rock Shaft Crank (back) Set Screw
64255	8911	" " " " (front) with 453c
2117	8901	" " " " " Pin.....
453c	8901	" " " " " Set Screw
54105	8901	" " " " Flanged Bushing (front)
52045	8901	" " " " " "
		Oil Pad (braided cotton).....
453c	8901	Arm Rock Shaft Flanged Bushing (front) Set Screw.....
68110	9850	Arm Rotary Shaft.....
68218	-----	" " " 68110 with 640e, 54088, 54383, 54450, 64351, 64355, 68016 and 68018.....
54367	9000	Arm Rotary Shaft Bushing (front).....
761e	8901	" " " " " " S e t Screw.....
54007	8902	Arm Rotary Shaft Bushing (intermediate)
54089	-----	" " " " " "
		54007 with 64508 and 64805.....
64508	8902	Arm Rotary Shaft Bushing (intermediate) Oil Pad, long (braided cotton).....

NO.	PLATE	NAME
64805	9000	Arm Rotary Shaft Bushing (intermediate) Oil Pad, short (braided cotton).....
422c	8901	Arm Rotary Shaft Bushing (intermediate) Set Screw (long).....
50084c	8901	Arm Rotary Shaft Bushing (intermediate) Set Screw (short).....
54450	9000	Arm Rotary Shaft Collar with two 1258c
1258c	8901	" " " " Set Screw.....
54009	8902	" " " " Flanged Bushing.....
54090	-----	" " " " " " 54009 with 58039 and 64805.....
58039	8902	Arm Rotary Shaft Flanged Bushing Oil Pad, long (braided cotton).....
64805	9000	Arm Rotary Shaft Flanged Bushing Oil Pad, short (braided cotton).....
159F	8901	Arm Rotary Shaft Flanged Bushing Screw
49013	8904	" " " " Front Bearing Oil Pad (braided cotton).....
144D	8901	Arm Rotary Shaft Screw.....
15196	8902	" Side Cover (back).....
286D	8904	" " " " Thumb Screw ...
54010	8904	" " " (front).....
286D	8904	" " " " Thumb Screw ...
54210	9855	Balance Wheel, 2 $\frac{5}{8}$ in. pulley, with two 430c.....
430c	8904	Balance Wheel Set Screw.....
68142	9850	Cloth Plate.....
68145	9850	" " Extension.....
1011F	8904	" " " Screw.....
54309	9000	" " Oil Tube with 49092, for oiling 54458.....
49092	8908	Cloth Plate Oil Tube Packing (felt).....
54012	8902	" " Slide (left).....
38419	8904	" " " " Spring.....
725J	8904	" " " " " Screw.....
54013	-----	Cloth Plate Slide (left) complete, Nos. 38419, 54012 and two 725J.....
68191	-----	Cloth Plate Slide (right) for 68192.....
38419	8904	" " " " Spring.....
725J	8904	" " " " " Screw ...
68192	-----	Cloth Plate Slide (right) complete, Nos. 38419, 68191 and two 725J.....
68260	-----	Cloth Plate complete, for $\frac{1}{8}$ in. to $\frac{3}{8}$ in. gauges, for 68198, Nos. 54013, 54309, 68142 and 68192.....
1011F	8904	Cloth Plate Screw (left).....
50473F	8904	" " " (right).....

NO.	PLATE	NAME
68146	9859	Cloth Plate Thread Guard.....
50473F	8904	" " " " Screw (long)..
1235F	8904	" " " " " (short)..
54017	8902	Crank Connecting Rod with 6575, 54018, 54218, 54897, 57222 and two each 896E and 1057E.....
54088	—	Crank Connecting Rod 54017 with 50069c
50069c	8904	" " " " Ball Screw Stud
1516E	8904	" " " " " " "
		Nut.....
64268	8904	Crank Connecting Rod Ball Screw Stud Washer.....
*57222	—	Crank Connecting Rod Cap (lower).....
896E	8904	" " " " " " Screw
*54018	—	" " " " " (upper).....
1057E	8904	" " " " " " Screw
54897	8904	" " " " Oil Cap.....
54218	8904	" " " " Pad (braided cotton).....
6575	8904	Crank Connecting Rod Oil Pad Stop Pin
64269	8913	Face Plate.....
46111	8911	" " Pin.....
286D	8904	" " Thumb Screw.....
54488	—	Feed Bar with 50429c and two 453c....
54020	8902	" " Connection.....
57225	8904	" " Hinge Pin.....
453c	8901	" " " " Set Screw.....
51111	8902	" Connecting Rod with 1057E, 54112 and two 896E.....
68018	—	Feed Connecting Rod 54111 with 54456..
*51112	—	" " " Cap.....
896E	8904	" " " " " Screw.....
1057E	8904	" " " " Clamping Screw...
54023	8911	" " " " Hinge Pin.....
21506	8904	" " " " " " Collar with 457c.....
457c	8904	Feed Connecting Rod Hinge Pin Collar Set Screw.....
68194	9852	Feed Dog, 14 teeth (10 teeth to the inch) for 68198.....
157W	8904	Feed Dog Screw.....
50429c	8904	" " Stop Screw.....
*54024	—	" Eccentric.....
*54455	—	" " Body.....
443c	8904	" " " Set Screw.....
7071	8904	" " Clamping Washer.....
217D	8904	" " " " " Screw..

NO.	PLATE	NAME
54456	9000	Feed Eccentric (adjustable) complete, Nos. 217D, 1103c, 7071, 54024, 54455 and two 443c.....
1103c	8904	Feed Regulating Screw.....
54026	9851	" Rocking Frame with two 453c....
68022	—	" " " " 54026, with 21506, 54020, 54023, 54488 and 57225.....
57234	8911	Feed Rocking Frame Hinge Pin.....
57235	9000	" " " " " Bushing
453c	8901	" " " " " " "
		Set Screw.....
453c	8901	Feed Rocking Frame Hinge Pin Set Screw
54457	9864	" Roll (lower) with two 50333c.....
68147	9854	" " " Clutch (brake).....
68148	9854	" " " " (drive).....
68149	9854	" " " " (brake) Conne- ction with 440c, 1700J and two 50083c..
440c	9853	Feed Roll (lower) Clutch (brake) Conne- ction Adjusting Screw.....
1700J	9853	Feed Roll (lower) Clutch (brake) Conne- ction Adjusting Screw Nut.....
50083c	8901	Feed Roll (lower) Clutch (brake) Conne- ction Set Screw.....
127530	9000	Feed Roll (lower) Clutch (brake) Conne- ction Stop Block.....
158D	9853	Feed Roll (lower) Clutch (brake) Conne- ction Stop Block Screw.....
68150	9854	Feed Roll (lower) Clutch (drive) Conne- ction with two 50083c.....
50083c	8901	Feed Roll (lower) Clutch (drive) Conne- ction Set Screw.....
68151	9000	Feed Roll (lower) Clutch Roller.....
68152	9000	" " " " " Plunger.
68153	9000	" " " " " Spring..
68154	9850	" " " " Shaft.....
68157	—	" " " " " 68154 with 68156.....
54467	9859	Feed Roll (lower) Clutch Shaft Bracket
68207	—	Feed Roll (lower) Clutch Shaft Bracket complete, Nos. 54457, 54467, 68157, 127530 and two each 158D and 62562..
62562	9000	Feed Roll (lower) Clutch Shaft Bracket Collar with 465c.....
465c	8909	Feed Roll (lower) Clutch Shaft Bracket Collar Set Screw.....
948D	8958	Feed Roll (lower) Clutch Shaft Bracket Screw.....

NO.	PLATE	NAME
68155	9854	Feed Roll (lower) Clutch Sleeve with four 1149c.....
	1149c 9853	Feed Roll (lower) Clutch Sleeve Set Screw
68156	—	Feed Roll (lower) Clutch complete, Nos. 68147 to 68150, 68155 and six each 68151 to 68153.....
54458	9854	Feed Roll (lower) Connecting Rod with 54112 and two 896E.....
68016	—	Feed Roll (lower) Connecting Rod 54458 with 54456.....
*54112	—	Feed Roll (lower) Connecting Rod Cap
896E	8904	“ “ “ “ “ “ Screw.....
1257c	9853	Feed Roll (lower) Connecting Rod Hinge Screw.....
1620E	9853	Feed Roll (lower) Connecting Rod Hinge Screw Nut.....
*54024	—	Feed Roll (lower) Eccentric.....
*54455	—	“ “ “ “ Body.....
443c	8904	“ “ “ “ “ S e t Screw.....
7071	8904	Feed Roll (lower) Eccentric Clamping Washer.....
217D	8904	Feed Roll (lower) Eccentric Clamping Washer Screw.....
54456	9000	Feed Roll (lower) Eccentric (adjustable) complete, Nos. 217D, 1103c, 7071, 54024, 54455 and two 443c.....
1103c	8904	Feed Roll (lower) Eccentric Regulating Screw.....
50333c	9853	Feed Roll (lower) Set Screw.....
54457	9864	“ “ (upper) with two 50333c.....
127534	9851	“ “ “ Bar.....
54469	9851	“ “ “ “ Bracket with 453c
54470	—	Feed Roll (upper) Bar Bracket complete, Nos. 79c, 866c, 913D, 1330c, 1876, 23404, 38648, 54469, 54471 to 54473, 54475, 127534, 127536, 127542 and two 208D.....
1193D	9853	Feed Roll (upper) Bar Bracket Screw (lower).....
769c	9853	Feed Roll (upper) Bar Bracket Screw (upper).....
127536	9000	Feed Roll (upper) Bar Collar with 448c..
1876	9000	“ “ “ “ “ Roller and Screw Stud.....

NO.	PLATE	NAME
448c	8958	Feed Roll (upper) Bar Collar Set Screw..
23404	9000	“ “ “ “ Spring.....
127538	9854	“ “ “ “ Bracket with 453c...
54475	—	“ “ “ “ 127538 with 54457 and 127546.....
127542	9000	Feed Roll (upper) Bracket Guide Pin....
453c	8901	“ “ “ “ “ “ Set Screw.....
453c	8901	Feed Roll (upper) Bracket Set Screw....
54471	9855	“ “ “ “ Lifter.....
866c	9853	“ “ “ “ Hinge Screw....
54472	9855	“ “ “ “ Latch.....
79c	9853	“ “ “ “ “ H i n g e Screw.....
38648	9856	Feed Roll (upper) Lifter Latch Spring....
54473	9856	“ “ “ “ “ Stop.....
208D	8910	“ “ “ “ “ “ Screw
1330c	9853	“ “ “ “ “ Stop Screw.....
913D	—	“ “ “ “ Pressure Regulating Thumb Screw.....
50333c	9853	Feed Roll (upper) Set Screw.....
127546	9856	“ “ “ “ Shaft.....
54106	9856	Looper (back) closed eye.....
NOTE: When ordering No. 54106, state gauge of machine for which required.		
1147c	8922	Looper (back) Set Screw.....
54107	9856	“ (front) closed eye.....
NOTE: When ordering No. 54107, state gauge of machine for which required.		
1120c	8958	Looper (front) Set Screw.....
54027	8960	“ Carrier with two 171D.....
171D	8958	“ “ Adjusting Screw.....
54227	8960	“ “ Connection.....
54228	8960	“ “ “ Shaft.....
54229	8960	“ “ “ “ Bushing
446c	8901	“ “ “ “ “ “ Set Screw.....
49013	8904	Looper Carrier Connection Shaft Oil Pad (braided cotton).....
54230	8960	Looper Carrier Driver with 54032 and four 175E.....
*54032	—	Looper Carrier Driver Cap.....
175E	8908	“ “ “ “ Screw.....
54368	9856	“ Driving Shaft and Feed Lifting Eccentric with 227D and two 64315....

NO.	PLATE	NAME
54383	—	Looper Driving Shaft and Feed Lifting Eccentric 54368 with 54027, 54227, 54228 and 54230.
*54034	—	Looper Driving Shaft and Feed Lifting Eccentric Bracket with 761E.
54080	8960	Looper Driving Shaft and Feed Lifting Eccentric Bracket Bushing.
	761E 8901	Looper Driving Shaft and Feed Lifting Eccentric Bracket Bushing Set Screw.
	948D 8958	Looper Driving Shaft and Feed Lifting Eccentric Bracket Screw.
64315	8960	Looper Driving Shaft and Feed Lifting Eccentric Oil Hole Plug.
	227D 8958	Looper Driving Shaft and Feed Lifting Eccentric Oil Hole Plug Screw.
40326	9856	Looper Driving Shaft and Feed Lifting Eccentric Oil Pad (braided cotton).
	640E 8908	Looper Driving Shaft and Feed Lifting Eccentric Screw.
54061	8922	Looper Holder with 1120c and 1147c.
	704W 8958	" " Screw.
64319	8922	Needle Bar (hollow).
54062	—	Needle Bar complete, for $\frac{3}{8}$ in. to $\frac{1}{4}$ in. gauges, Nos. 54064, 54065 and 64319.
54063	—	Needle Bar complete, for $\frac{3}{8}$ in. to $\frac{3}{8}$ in. gauges, Nos. 54064, 54066 and 64319.
38456	8991	Needle Bar Bushing (lower).
	1133E 8958	" " " " Set Screw.
64320	8991	" " " (upper).
	1133E 8958	" " " " Set Screw.
54326	8991	" " Connecting Link.
54327	8991	" " " " Hinge Stud
	1520J 8991	" " " " " " " " Nut.
54328	8991	Needle Bar Connecting Stud with 211F and two 187E.
	187E 8958	Needle Bar Connecting Stud Clamping Screw.
54064	8922	Needle Clamp with two 1498F.
54065	8922	" " Thread Guard for 54062.
54066	8922	" " " " " 54063.
68197	9858	" Guard, for $\frac{1}{4}$ in. to $\frac{3}{8}$ in. gauges.
54038	8991	" " Holder.
	176D 8958	" " " Screw.
	217F 8904	" " " Screw.
	1498F 8922	" Set Screw.
54108	—	Oil Tube.

NO.	PLATE	NAME
54109	—	Oil Tube Bracket.
49092	8908	" " Packing (felt).
54110	8908	Oil Tube complete, for oiling Crank Connecting Rod (upper bearing) Nos. 49092, 54108 and 54109.
64330	9855	Presser Bar with 25303.
25303	9856	" " Ball, size $\frac{1}{4}$ in.
64331	8911	" " Bushing (lower).
	1133E 8958	" " " " Set Screw.
38456	8991	" " " (upper).
	1133E 8958	" " " " Set Screw.
54039	8908	" " Guide Bracket with 453c, 640w and 1963.
	640w 8908	Presser Bar Guide Bracket Adjusting Screw.
11173	8908	Presser Bar Guide Bracket Guide.
	447c 8908	" " " " " " Set Screw.
	1963 8908	Presser Bar Guide Bracket Roller and Stud.
	453c 8901	Presser Bar Guide Bracket Set Screw.
54474	9856	" " Lifter.
57258	8911	" " " Hinge Pin.
	447c 8908	" " " " " Set Screw.
	1872 8908	" " " Roller and Stud.
	1250c 8911	" " " Stop Screw.
61047	8911	" " Lifting Bracket with 460c and 1872.
68208	9855	Presser Bar Lifting Lever.
61075	8911	" " " " Connecting Stud.
	460c 8910	Presser Bar Lifting Lever Connecting Stud Set Screw.
68184	9855	Presser Bar Lifting Lever Extension.
	161D 8908	" " " " " Screw (left).
	176D 8958	Presser Bar Lifting Lever Extension Screw (right).
	802D 8908	Presser Bar Lifting Lever Hinge Screw.
54040	9855	" " Spring (flat).
38468	8908	" " " Stud.
26276	8911	" Foot Hinge Pin.
68219	—	" " Plate.
46087	—	" " Shank.
68220	9857	Presser Foot (hinged) complete, for $\frac{3}{8}$ in. to $\frac{3}{8}$ in. gauges, for lap seam feller, Nos. 26276, 46087 and 68119.

NO.	PLATE	NAME
190b	8908	Presser Foot Screw.....
574w	8908	Pressure Regulating Thumb Screw.....
1539w	8908	“ “ “ “ Lock Nut.....
54381	9856	Slack Thread Controller.....
54242	9856	“ “ “ Clamp.....
190b	8908	“ “ “ “ Screw...
68199	9858	“ “ Regulator.....
54042	8908	“ “ “ Holder with 175E and 50150c.....
175E	8908	Slack Thread Regulator Holder Clamping Screw.....
54043	8908	Slack Thread Regulator Holder Shaft
24292	8908	“ “ “ “ “ Collar with 1019c.....
1019c	8908	Slack Thread Regulator Holder Shaft Collar Set Screw.....
54044	8908	Slack Thread Regulator Holder Shaft Crank (forked) with 1253c.....
1253c	8908	Slack Thread Regulator Holder Shaft Crank Set Screw.....
50150c	8908	Slack Thread Regulator Set Screw.....
2102	8909	Tension (under thread) Disc.....
51570c	9853	“ “ “ Regulating Thumb Nut.....
50326c	9853	Tension (under thread) Screw Stud.....
59539	—	“ “ “ “ “ 50326c with 51570c.....
59534	9858	Tension (under thread) Spring.....
59537	9858	“ “ “ “ Bushing (large).....
59538	9858	Tension (under thread) Spring Bushing (small).....
17547	8909	Tension (under thread) Thread Guide..
54070	8996	“ (upper thread) Bracket.....
376b	8909	“ “ “ “ Screw..
2102	8909	“ “ “ Disc.....
51570c	9853	“ “ “ Regulating Thumb Nut.....
32572	8909	Tension (upper thread) Releasing Disc...
54988	8909	“ “ “ “ Pin....
54071	8922	“ “ “ “ Shaft
54047	8909	“ “ “ “ Crank with 624c.....
54048	8909	Tension (upper thread) Releasing Shaft Crank Link.....

NO.	PLATE	NAME
624c	8909	Tension (upper thread) Releasing Shaft Crank Set Screw.....
68261	—	Tension (upper thread) Releasing Shaft Spring.....
316F	8909	Tension (upper thread) Releasing Shaft Stop Screw.....
1547J	8909	Tension (upper thread) Releasing Shaft Stop Screw Nut.....
50326c	9853	Tension (upper thread) Screw Stud.....
59539	—	“ “ “ “ “ 50326c with 51570c.....
59535	9858	Tension (upper thread) Spring.....
59537	9858	“ “ “ “ Bushing (large).....
59538	9858	Tension (upper thread) Spring Bushing (small).....
57076	9858	Tension (upper thread) Thread Guide..
53225	9858	Thread (under) Eyelet (back).....
190b	8908	“ “ “ “ Screw.....
54072	9858	“ “ “ (front).....
64351	8909	“ “ Nipper Cam with 465c..
465c	8909	“ “ “ “ Set Screw..
38210	8909	“ “ “ Spring (lower)...
38211	8909	“ “ “ “ (upper)
46247	8909	“ “ “ “ “ Stop.....
176b	8958	Thread (under) Nipper Spring Screw....
68128	9858	“ “ Take-up with two 465c..
465c	8909	“ “ “ Set Screw.....
54435	9858	“ “ “ Staple with 590b and 38481.....
54049	9855	Thread (under) Take-up Staple Bracket with 460c.....
965b	8910	Thread (under) Take-up Staple Bracket Screw.....
46041	8909	Thread (under) Take-up Staple Spring
190b	8908	“ “ “ “ “ Screw.....
38481	8910	Thread (under) Take-up Staple Thread Guard.....
590b	8958	Thread (under) Take-up Staple Thread Guard Screw.....
38482	8910	Thread (under) Take-up Stripper.....
207b	8910	“ “ “ “ Screw
64355	8910	“ “ “ Thread Guard (brass).....

NO.	PLATE	NAME
64356	8910	Thread (under) Take-up Thread Guard Steady Pin.....
460c	8910	Thread (under) Take-up Thread Guard Steady Pin Set Screw.....
68129	9860	Thread (upper) Nipper Body.....
1149F	9853	“ “ “ “ Set Screw..
68130	9860	“ “ “ “ Disc (inside)
68131	9860	“ “ “ “ “
		Washer (fibre).....
68132	9860	Thread (upper) Nipper Disc (outside)
1698R	9853	“ “ “ “ “
		Nut.....
59456	9860	Thread (upper) Nipper Disc (outside) Nut Washer.....
68133	9860	Thread (upper) Nipper Roller.....
68134	9860	“ “ “ “ Hinge Pin.
68135	9860	“ “ “ “ Stud.....
68136	—	“ “ “ “ 68135 with 68133 and 68134.....
13218	9860	Thread (upper) Nipper Stud Spring.....
68137	—	Thread (upper) Nipper complete, Nos. 1698R, 13218, 59456, 68129 to 68132 and 68136.....
68138	9860	Thread (upper) Nipper Thread Guide
207D	8910	“ “ “ “ “ Screw.....
54075	9860	Thread (upper) Take-up.....
211F	8958	“ “ “ “ Set Screw.....
68198	9852	Throat Plate, for $\frac{5}{16}$ in. to $\frac{3}{8}$ in. gauges for 68194.....
742F	8910	Throat Plate Screw.....

ACCESSORIES

NO.	PLATE	NAME
120344	8941	Oiler (copper plated) with 120345.....
120345	8941	“ Spout, 5 in. long.....
26026	8941	Screw Driver (large).....
26485	8941	“ “ (small).....
38487	8941	Threading Wire.....
120341	8941	Tweezers (curved).....
4822	8941	Wrench for 1547.....
8908	8941	“ “ 1520 and 1620.....
19221	8941	“ “ 1516.....

ATTACHMENT

FOR FRINGING AND TAPING EDGE OF RUGS
FOR 147-38 MACHINE

NO.	PLATE	NAME
120744	9866	Fringe Guide with Nap Guide on Bracket
1443w	9853	“ “ Screw.....
120745	9866	Leveling Plate.....
120746	—	Rug Guide.....
1443w	9853	“ “ Screw.....
120747	9866	Tape Guide on Shank.....
96B	9853	“ “ Hinge Screw.....
36006	9862	“ “ “ “ Friction Washer
120748	9866	Attachment complete, for fringing and taping edges of rugs in one operation, Nos. 96B, 36006, 120744 to 120747 and four 1443w.....
1443w	9853	Attachment Screw.....
68194	9852	Feed Dog, 14 teeth (10 teeth to the inch)
68058	9864	“ Roll (lower) $1\frac{1}{4}$ in. wide, with two 50333c.....
50333c	9853	Feed Roll (lower) Set Screw.....
68221	9854	“ “ (upper) $1\frac{1}{8}$ in. wide, with two 50333c.....
50333c	9853	Feed Roll (upper) Set Screw.....
120749	—	Presser Foot Compensating Plate.....
1449F	8922	“ “ “ “ Screw..
24701	9857	“ “ “ “ Spring.
18055	9857	“ “ Hinge Pin.....
120750	—	“ “ Plate.....
120751	—	“ “ Shank.....
120752	9857	Presser Foot (compensating, hinged) com- plete for 120748, Nos. 18055, 120749 to 120751 and two each 1449F and 24701
68198	9852	Throat Plate, for $\frac{5}{16}$ in. to $\frac{3}{8}$ in. gauges, for 68194.....

HEMMER

FOR HEMMING AND INSERTING ELASTIC IN RAYON BLOOMERS
FOR 147-29 MACHINE

NO.	PLATE	NAME
68209	9865	Cloth Plate.....
68145	9850	“ “ Extension.....
1011F	8904	“ “ “ Screw.....

NO.	PLATE	NAME
54309	9000	Cloth Plate Oil Tube with 49092.....
49092	8908	“ “ “ “ Packing (felt).....
68107	9868	“ “ Slide (left).....
38419	8904	“ “ “ “ Spring.....
725J	8904	“ “ “ “ Screw.....
68108	----	Cloth Plate Slide (left) complete, Nos. 38419, 68107 and two 725J.....
68191	----	Cloth Plate Slide (right).....
38419	8904	“ “ “ “ Spring.....
725J	8904	“ “ “ “ “ Screw...
68192	----	Cloth Plate Slide (right) complete, Nos. 38419, 68191 and two 725J.....
68210	----	Cloth Plate complete, for $\frac{7}{32}$ in. to $\frac{3}{8}$ in. gauges, for 68105 and 68201, Nos. 54309, 68108, 68192 and 68209.....
1011F	8904	Cloth Plate Screw (left).....
50473F	8904	“ “ “ (right).....
68200	9863	Feed Dog, 25 teeth (20 teeth to the inch) for 68201.....
68095	----	Feed Dog, 25 teeth (20 teeth to the inch) for 68105.....
54457	9864	Feed Roll (lower) with two 50333c.....
50333c	9853	“ “ “ Set Screw.....
54481	9864	“ “ (upper) 1 in. wide, with two 50333c.....
50333c	9853	Feed Roll (upper) Set Screw.....
120626	9864	Hemmer Bracket with 10248.....
120627	----	“ Elastic Guide.....
54509	9860	“ “ “ Position Pin.....
120628	----	“ “ “ Spring with 54509
229D	9853	“ “ “ “ Screw.....
120629	9864	“ Folder.....
51097J	9853	“ “ Thumb Screw.....
3146	9860	“ “ “ “ Washer...
120630	----	“ Tension Elastic Guide.....
120631	----	“ “ Plate.....
10248	9860	“ “ “ Position Pin.....
1560c	9853	“ “ Regulating Thumb Nut
916c	9853	“ “ Screw Stud.....
44209	----	“ “ “ “ 916c with 1560c.....
13710	9860	Hemmer Tension Spring.....
120632	9864	Hemmer with Elastic Tension, complete, for hemming and inserting elastic in Rayon bloomers, Nos. 13710, 44209, 120626 to 120631 and two each 229D, 3146 and 51097J.....

NO.	PLATE	NAME
68096	----	Presser Foot Chaining-off Plate (left) with 68097 and 68099.....
68097	9857	Presser Foot Chaining-off Plate (left) Guide Pin (long).....
68098	9857	Presser Foot Chaining-off Plate (left) Guide Pin (long) Collar with 853c.....
853c	9857	Presser Foot Chaining-off Plate (left) Guide Pin (long) Collar Set Screw.....
68099	9857	Presser Foot Chaining-off Plate (left) Guide Pin (short).....
68100	9857	Presser Foot Chaining-off Plate (left) Spring.....
68101	----	Presser Foot Chaining-off Plate (right) with 68097 and 68099.....
68097	9857	Presser Foot Chaining-off Plate (right) Guide Pin (long).....
68098	9857	Presser Foot Chaining-off Plate (right) Guide Pin (long) Collar with 853c.....
853c	9857	Presser Foot Chaining-off Plate (right) Guide Pin (long) Collar Set Screw.....
68099	9857	Presser Foot Chaining-off Plate (right) Guide Pin (short).....
68100	9857	Presser Foot Chaining-off Plate (right) Spring.....
26276	8911	Presser Foot Hinge Pin.....
68102	----	“ “ Plate.....
68103	----	“ “ Shank.....
68100	9857	“ “ Spring.....
68104	9857	Presser Foot (spring hinged) with right and left Chaining-off Guide Plates com- plete, for $\frac{5}{16}$, $\frac{1}{2}$ and $\frac{3}{8}$ in. gauges, for 120632, Nos. 26276, 68096, 68101 to 68103, two 68098 and three 68100.....
68201	9863	Throat Plate, for $\frac{1}{8}$ in. to $\frac{3}{8}$ in. gauges, for 68200.....
68105	----	Throat Plate, for $\frac{5}{16}$ in., $\frac{1}{2}$ in. and $\frac{3}{8}$ in. gauges, for 68095.....

LAP SEAM FELLERS

NO.	PLATE	NAME
120524	9866	Lap Seam Feller on Shank, for general work, for light and medium weight ma- terial.....
120709	9866	Lap Seam Feller (adjustable, right hand) on Shank, for general work, for medium- heavy and heavy weight material.....

NO.	PLATE	NAME
120743	9866	Half Lap Seam Feller on Shank, for general work, for heavy material.....
120387	8949	Feed Dog, 17 teeth (16 teeth to the inch)
120351	8949	" " 23 teeth (22 teeth to the inch)
120407	8949	" " 17 teeth (16 teeth to the inch)
120361	8949	" " 23 teeth (22 teeth to the inch)
54114	8950	" " 11 teeth (10 teeth to the inch)
54097	8950	" " 14 teeth (12 teeth to the inch)
54098	8950	" " 18 teeth (16 teeth to the inch)
54099	8950	" " 20 teeth (18 teeth to the inch)
120383	8950	" " 14 teeth (12 teeth to the inch)
68194	9852	" " 14 teeth (10 teeth to the inch)
26276	8911	Presser Foot Hinge Pin.....
120352	—	" " Plate.....
46087	—	" " Shank.....
120353	8951	Presser Foot (hinged) complete, Nos. 26276, 46087 and 120352.....
26276	8911	Presser Foot Hinge Pin.....
120384	—	" " Plate.....
46087	—	" " Shank.....
120385	8951	Presser Foot (hinged) complete, Nos. 26276, 46087 and 120384.....
26276	8911	Presser Foot Hinge Pin.....
120405	—	" " Plate.....
46087	—	" " Shank.....
120406	8951	Presser Foot (hinged) complete, Nos. 26276, 46087 and 120405.....
26276	8911	Presser Foot Hinge Pin.....
54119	—	" " Plate.....
54120	—	" " Shank.....
54121	8951	Presser Foot (hinged) complete, with left hand guide on toe, Nos. 26276, 54119 and 54120.....
26276	8911	Presser Foot Hinge Pin.....
54117	—	" " Plate.....
46087	—	" " Shank.....
54118	8951	Presser Foot (hinged) complete, with right hand guide on toe, Nos. 26276, 46087 and 54117.....
26276	8911	Presser Foot Hinge Pin.....
54101	—	" " Plate.....
46087	—	" " Shank.....
54102	8951	Presser Foot (hinged) complete, with left hand guide on toe, Nos. 26276, 46087 and 54101.....
26276	8911	Presser Foot Hinge Pin.....
68219	—	" " Plate.....

NO.	PLATE	NAME
46087	—	Presser Foot Shank.....
68220	9857	Presser Foot (hinged) complete, Nos. 26276, 46087 and 68219.....
120354	8949	Throat Plate, for $\frac{3}{8}$ in. to $\frac{1}{8}$ in. gauges, for 120351 and 120387.....
120362	8949	Throat Plate, for $\frac{1}{5}$ in. and $\frac{1}{4}$ in. gauges, for 120361 and 120407.....
120386	8950	Throat Plate, for $\frac{1}{8}$ in. to $\frac{3}{8}$ in. gauges, for 120383.....
54100	8950	Throat Plate, for $\frac{1}{8}$ in. to $\frac{3}{8}$ in. gauges, for 54097 to 54099 and 54114.....
68198	9852	Throat Plate, for $\frac{1}{8}$ in. to $\frac{3}{8}$ in. gauges, for 68194.....

FEED ROLL (Rubber)

NO.	PLATE	NAME
68021	9854	Feed Roll (rubber) with two 50333c.....
50333c	9853	" " Set Screw.....

STRIP FOLDER

FOR ATTACHING "JACKLASTIC" TO
HEAVY SPORT BLOUSES
FOR 147-29 MACHINE

NO.	PLATE	NAME
46062	9863	Feed Dog, 18 teeth (16 teeth to the inch)
68058	9864	" Roll (lower) $1\frac{1}{4}$ in. wide, with two 50333c.....
50333c	9853	Feed Roll (lower) Set Screw.....
68059	9864	" " (upper) 1 in. wide, with two 50333c.....
50333c	9853	Feed Roll (upper) Set Screw.....
26276	8911	Presser Foot Hinge Pin.....
120551	—	" " Plate.....
46099	—	" " Shank.....
120552	9857	" " Spreader, for elastic work... 218w 8958
218w	8958	" " " Screw.....
120553	9857	Presser Foot (hinged) with Elastic Spreader complete, Nos. 26276, 46099, 120551, 120552 and two 218w.....
190D	8908	Presser Foot Screw.....
120551	9864	Strip Folder (adjustable).....
1443B	9853	" " Screw.....
120555	—	" " Edge Guide, for body of garment.....

STRIP FOLDER

NO.	PLATE	NAME
1443B	9853	Strip Folder Edge Guide Screw.....
120556	9864	" " Spring Edge Guide, for jack-lastic.....
1443B	9853	Strip Folder Spring Edge Guide Screw....
120557	9864	" " Shank.....
96B	9853	" " " " Hinge Screw.....
36006	9862	" " " " " Friction Washer.....
120558	9864	Strip Folder Shank Plate.....
120559	---	" " " Stop.....
665B	9853	" " " " Screw.....
120560	9864	Strip Folder (adjustable) on Throw-out Shank complete, Nos. 96B, 36006, 120554 to 120559, two 665B and six 1413B.....
1443W	9853	Strip Folder Screw for 120560.....
120561	9863	Throat Plate, for $\frac{3}{4}$ in. to $\frac{3}{8}$ in. gauges, for 46062.....

BELT GUARD

NO.	PLATE	NAME
68222	9859	Belt Guard with two wood screws 1 in. No. 12.....

BENCH STAND

NO.	PLATE	NAME
79756	---	Bench Stand with 27998, 41538, two each 60656, 121500, wood screws $1\frac{1}{4}$ in. No. 14 and eight each wood screws $\frac{5}{8}$ in. No. 5 and $\frac{5}{8}$ in. No. 7.....
124500	9862	Flap Hinge.....
27998	9862	" Hook and Eye (brass) with wood screw $\frac{1}{2}$ in. No. 5.....
11538	---	Flush Bolt with Plate complete, Nos. 126247, 126248 and four brass wood screws $\frac{5}{8}$ in. No. 4.....
126247	9862	Flush Bolt.....
126248	9862	" " Plate.....
60656	9855	Hinge.....

FOOT LIFTER PARTS

NO.	PLATE	NAME
6439	---	Chain, 36 in. to 45 in., with 56864 and 56865.....
NOTE: When ordering No. 6439, state length required.		
4879	8941	Chain Connecting Link.....
56864	8941	" Hook (large).....
56865	8910	" " (small).....
126249	9861	Treadle.....
4882	8941	" Shaft.....
126250	9862	" Spring.....
126251	9861	" Stand.....
126252	9861	Treadle complete, Nos. 4882, 126249 to 126251 and two wood screws 1 in. No. 16.....

KNEE LIFTER PARTS

NO.	PLATE	NAME
37563	---	Chain, length 15 in., with 56864 and 56865
56864	8941	" Hook (large).....
56865	8910	" " (small).....
2763	9861	Rock Shaft.....
12242	9861	" " Hanger with two wood screws 1 in. No. 10.....
6335	9861	Rock Shaft Knee Arm.....
6336	---	Rock Shaft Knee Arm complete, Nos. 2766, 2767 and 6335.....
2766	9861	Rock Shaft Knee Arm Hub with 356c...
356c	8910	" " " " " Set Screw....
2767	9861	" " " Plate with 356c.....
356c	8910	" " " " Set Screw.....
6337	9861	" " Lifting Bracket with two 356c
7125	9861	" " " " Hook.....
356c	8910	" " " " " S e t Screw.....
356c	8910	Rock Shaft Lifting Bracket Set Screw....
2770	9861	" " Stop Dog with 356c.....
356c	8910	" " " " Set Screw.....
23767	9861	Rock Shaft complete, Nos. 2763, 2770, 6336, 6337, 7125 and two 12242.....

MACHINE BASE

NO.	PLATE	NAME
54476	9861	Machine Base.....
49123	8996	" " Oil Pipe.....
49124	9862	" " " " Valve.....
54477	9862	" " Screw Stud.....
51576E	9862	" " " " Nut.....
9842	9862	" " " " " Washer..
57285	8996	" Cushion (felt).....
54478	9862	" Screw Stud, to fasten machine to base.....
51577E	9862	Machine Screw Stud Nut.....
54479	—	Machine Base complete, Nos. 49123, 49124, 54476 three each 9842, 51576E, 54477, 57285 and four each 51577E and 54478.....

SPOOL HOLDER

FOR ELASTIC MATERIAL
FOR HEMMER NO. 120632

NO.	PLATE	NAME
27723	9867	Base with 168B and three wood screws 1 in. No. 10.....
27870	9867	Disc (8 in.) with 879b, 27871 and five 12152
27871	—	" Hub.....
879D	9853	" " Thumb Screw.....
12152	9860	" Rivet.....
120528	9867	Rod.....
168B	9853	" Set Screw.....
120529	—	Spool Holder complete, Nos. 27723, 120528 and two 27870.....

TAPE HOLDER (Adjustable)

(9 INCH DISC)
FOR UNDER THE BENCH
FOR STRIP FOLDER NO. 120560

NO.	PLATE	NAME
35903	5729	Arm with 457c and 797c.....
797c	9853	" Set Screw.....
35889	5729	" Shaft.....
35890	5729	Disc.....

NO.	PLATE	NAME
35891	—	Disc. 35890 with 35894 and five 4604.....
35892	5729	"
35893	—	" 35892 with 35895 and five 4604.....
35894	5729	" Hub.....
35895	5729	" " with 457c.....
457c	8904	" " Set Screw.....
4604	9860	" Rivet.....
35896	5729	Spindle.....
35897	9851	" Sleeve.....
35898	5729	" " Spring (flat).....
284D	9853	" " " Thumb Screw....
11564	9860	" Spring.....
40043	9860	" " Collar with 237F.....
237F	9853	" " " Set Screw.....
35904	5729	Tape Guide.....
457c	8904	" " Set Screw.....
35905	—	Tape Holder (9 in. disc) adjustable, com- plete, Nos. 284D, 11564, 35889, 35891, 35893, 35896 to 35898, 35903, 35904 and 40043.....
35906	9867	Stand with two 647D and four wood screws 1 in. No. 10.....
647D	9853	Stand Clamping Screw.....
35907	—	Tape Holder with Stand complete, for under the bench, Nos. 35905 and 35906

TAPE REEL

9 IN. DISC
FOR UNDER THE BENCH
FOR RUG ATTACHMENT NO. 120748

NO.	PLATE	NAME
*120671	—	Tape Reel Disc.....
120672	9867	" " " 120671 with 120673....
*120673	—	" " " Hub.....
120674	9867	" " Rod.....
28012	9000	" " Screw Eye.....
120680	—	Tape Reel (9 in. disc) complete, Nos. 28012, 120672 and 120674.....

THREAD UNWINDER

FOR FOUR SPOOLS

NO.	PLATE	NAME
225395	8953	Spool Rest (for two spools) with 201018c
225388	8953	" " Rod
200383c	8910	" " " Set Screw
201018c	8910	" " " Set Screw
202490	8953	" Stand with 200383c
225391	8953	Thread Guide
201696j	8910	" " Lock Nut
225392	8953	" " Rod with 208e and 225395
208e	8910	" " " Screw
225393	8910	" " " Washer
225398	8953	Thread Unwinder complete, Nos. 201696j, 202490, 225388, 225392, two 225395, four 225391 and three wood screws $\frac{7}{8}$ in. No. 12
27739	8996	Thread Cone (wood) for large cones
225390	8996	" " Holder, for inverted cones

NOTE: Nos. 27739 and 225390 are used with, but not included in 225398.

OBSOLETE PARTS

FOR 147-29 MACHINE

NO.	PLATE	NAME
54356	9861	Belt Guard with 1192c, for 54479
27347	9860	" " Hinge Pin for 54479
1192c	9853	" " " " Set Screw for 54467
1192c	9853	" " " " Set Screw for 54356
54451	9865	Cloth Plate
54453	—	Cloth Plate complete, for $\frac{1}{2}$ in. and $\frac{3}{8}$ in. gauges, Nos. 54013, 54056, 54309 and 54451
68057	—	Cloth Plate complete, for $\frac{3}{2}$ in. to $\frac{5}{8}$ in. gauges, Nos. 54013, 54015, 54309 and 54451
54452	9865	Cloth Plate Extension
54454	9859	" " Thread Guard
54459	9868	Feed Roll (lower) Retaining Clutch with two 448c
54460	9868	Feed Roll (lower) Retaining Clutch Frame with 54463

NO.	PLATE	NAME
68080	—	Feed Roll (lower) Retaining Clutch Frame 54460 with 54459, 54461, 54464, 54465, three 127528, four each 966e, 127531, six 208d and fourteen 54466
54461	9868	Feed Roll (lower) Retaining Clutch Frame Cover with 54462
54462	9868	Feed Roll (lower) Retaining Clutch Frame Cover Pad (felt)
208d	8910	Feed Roll (lower) Retaining Clutch Frame Cover Screw
54463	9868	Feed Roll (lower) Retaining Clutch Frame Pad (felt)
21788	9860	Feed Roll (lower) Retaining Clutch Frame Spring
127530	9000	Feed Roll (lower) Retaining Clutch Frame Stop Block
158d	9853	Feed Roll (lower) Retaining Clutch Frame Stop Block Screw
127528	9860	Feed Roll (lower) Retaining Clutch Roller
54466	9860	" " " " " " " Spring
448c	8958	Feed Roll (lower) Retaining Clutch Set Screw
54464	9868	Feed Roll (lower) Rock Shaft
54465	9868	" " " " " " Clutch
127531	9860	" " " " " " " Roller
54466	9860	Feed Roll (lower) Rock Shaft Clutch Roller Spring
966e	9853	Feed Roll (lower) Rock Shaft Clutch Screw
127521	9850	Feed Roll (lower) Shaft
54467	9859	" " " " Bracket
54468	—	Feed Roll (lower) Shaft Bracket complete, Nos. 21788, 54457, 54467, 127521, 127530 and two each 158d and 62562
62562	9000	Feed Roll (lower) Shaft Bracket Collar with two 465c
465c	8909	Feed Roll (lower) Shaft Bracket Collar Set Screw
948d	8958	Feed Roll (lower) Shaft Bracket Screw
54990	8909	Tension (upper thread) Releasing Shaft Spring, use 68261

NUMERICAL LIST OF PARTS
FOR
MACHINES
Nos. 147-29 and 147-38

NUMERICAL LIST OF PARTS

NO. PLATE	NAME
79C 9853	Feed Roll (upper) Lifter Latch Hinge Screw for 54470.....
96B 9853	Strip Folder Shank Hinge Screw for 120560
96B 9853	Tape Guide Hinge Screw for 120748.....
144D 8901	Arm Rotary Shaft Screw.....
157W 8904	Feed Dog Screw.....
158D 9853	“ Roll (lower) Clutch (brake) Connection Stop Block Screw for 68207....
158D 9853	Feed Roll (lower) Retaining Clutch Frame Stop Block Screw for 54468, obsolete..
159F 8901	Arm Rotary Shaft Flanged Bushing Screw
161D 8908	Presser Bar Lifting Lever Extension Screw (left).....
168B 9853	Spool Holder Rod Set Screw for 27723...
171D 8958	Looper Carrier Adjusting Screw for 54027
175E 8908	“ “ Driver Cap Screw for 54230.....
175E 8908	Slack Thread Regulator Holder Clamping Screw for 54042.....
176D 8958	Needle Guard Holder Screw.....
176D 8958	Presser Bar Lifting Lever Extension Screw (right).....
176D 8958	Thread (under) Nipper Spring Screw....
187E 8958	Needle Bar Connecting Stud Clamping Screw for 54328.....
190D 8908	Presser Foot Screw.....
190D 8908	Slack Thread Controller Clamp Screw...
190D 8908	Thread (under) Eyelet (back) Screw.....
190D 8908	“ “ Take-up Staple Spring Screw.....
190D 8908	Thread (upper) Eyelet Screw for 147-29 Machine.....
207D 8910	Thread (under) Take-up Stripper Screw..
207D 8910	“ (upper) Controller Screw for 147-29 Machine.....
207D 8910	Thread (upper) Nipper Thread Guide Screw for 147-38 Machine.....
208D 8910	Feed Roll (lower) Retaining Clutch Frame Cover Screw for 68080, obsolete.....
208D 8910	Feed Roll (upper) Lifter Latch Stop Screw for 54470.....
208E 8910	Thread Unwinder Thread Guide Rod Screw for 225392.....

NO. PLATE	NAME
211F 8958	Thread (upper) Take-up Set Screw for 54328.....
217D 8904	Feed Eccentric Clamping Washer Screw for 54456.....
217D 8904	Feed Roll (lower) Eccentric Clamping Washer Screw for 54456.....
217F 8904	Needle Guard Screw.....
218W 8958	Presser Foot Spreader Screw for 120553..
227D 8958	Looper Driving Shaft and Lifting Eccentric Oil Hole Plug Screw for 54368.....
229D 9853	Hemmer Elastic Guide Spring Screw for 120632.....
237F 9853	Tape Holder Spindle Spring Collar Set Screw for 40043.....
281D 9853	Tape Holder Spindle Sleeve Spring Thumb Screw for 35905.....
286D 8904	Arm Side Cover (back) Thumb Screw...
286D 8904	" " " (front) Thumb Screw...
286D 8904	Face Plate Thumb Screw.....
316F 8909	Tension (upper thread) Releasing Shaft Stop Screw.....
356c 8910	Rock Shaft Knee Arm Hub Set Screw for 2766.....
356c 8910	Rock Shaft Knee Plate Set Screw for 2767
356c 8910	" " Lifting Bracket Hook Set Screw for 6337.....
356c 8910	Rock Shaft Lifting Bracket Set Screw for 6337.....
356c 8910	Rock Shaft Stop Dog Set Screw for 2770
376D 8909	Tension (upper thread) Bracket Screw...
422c 8901	Arm Rotary Shaft Bushing (intermediate) Set Screw (long).....
423c 8901	Arm Rock Shaft Bushing (intermediate) Set Screw.....
430c 8904	Balance Wheel Set Screw for 54210 and 64259.....
440c 9853	Feed Roll (lower) Clutch (brake) Connection Adjusting Screw for 68149.....
443c 8904	Feed Eccentric Body Set Screw for 54456
443c 8904	" Roll (lower) Eccentric Body Set Screw for 54456.....
446c 8901	Arm Rock Shaft Bushing (back) Set Screw
446c 8901	Looper Carrier Connection Shaft Bushing Set Screw.....
447c 8908	Presser Bar Guide Bracket Guide Set Screw.....
447c 8908	Presser Bar Lifter Hinge Pin Set Screw..

NO. PLATE	NAME
448c 8958	Feed Roll (lower) Retaining Clutch Set Screw for 54459, obsolete.....
448c 8958	Feed Roll (upper) Bar Collar Set Screw for 127536.....
453c 8901	Arm Rock Shaft Collar Set Screw for 54004.....
453c 8901	Arm Rock Shaft Crank (front) Set Screw for 64255.....
453c 8901	Arm Rock Shaft Flanged Bushing (front) Set Screw.....
453c 8901	Feed Bar Hinge Pin Set Screw for 54019 and 54488.....
453c 8901	Feed Rocking Frame Hinge Pin Bushing Set Screw.....
453c 8901	Feed Rocking Frame Hinge Pin Set Screw for 54026.....
453c 8901	Feed Roll (upper) Bracket Guide Pin Set Screw for 54469.....
453c 8901	Feed Roll (upper) Bracket Set Screw for 127538.....
453c 8901	Presser Bar Guide Bracket Set Screw for 54039.....
457c 8904	Feed Connecting Rod Hinge Pin Collar Set Screw for 21506.....
457c 8904	Tape Holder Disc Hub Set Screw for 35895
457c 8904	" " Tape Guide Set Screw for 35903.....
460c 8910	Presser Bar Lifting Lever Connecting Stud Set Screw for 61047.....
460c 8910	Thread (under) Take-up Thread Guard Steady Pin Set Screw for 54049.....
465c 8909	Feed Roll (lower) Clutch Shaft Bracket Collar Set Screw for 62562.....
465c 8909	Thread (under) Nipper Cam Set Screw for 64351.....
465c 8909	Thread (under) Take-up Set Screw for 38475 and 68128.....
465c 8909	Feed Roll (lower) Shaft Bracket Collar Set Screw for 62562, obsolete.....
574w 8908	Pressure Regulating Thumb Screw.....
590D 8958	Thread (under) Take-up Staple Thread Guard Screw for 54435.....
624c 8909	Tension (upper thread) Releasing Shaft Crank Set Screw for 54047.....
640E 8908	Looper Driving Shaft and Feed Lifting Eccentric Screw for 68017 and 68218..

NO. PLATE	NAME
640W 8908	Presser Bar Guide Bracket Adjusting Screw for 54039.....
647D 9853	Tape Holder Stand Clamping Screw for 35906.....
665B 9853	Strip Folder Shank Stop Screw for I20560
704W 8958	Looper Holder Screw.....
725J 8904	Cloth Plate Slide (left) Spring Screw for 54013 and 68108.....
725J 8904	Cloth Plate Slide (right) Spring Screw for 54015, 54056, 68093 and 68167.....
742F 8910	Throat Plate Screw.....
761E 8901	Arm Rotary Shaft Bushing (front) Set Screw.....
761E 8901	Looper Driving Shaft and Feed Lifting Eccentric Bracket Bushing Set Screw for 54034.....
769C 9853	Feed Roll (upper) Bar Bracket Screw (upper).....
797C 9853	Tape Holder Arm Set Screw for 35903...
802D 8908	Presser Bar Lifting Lever Hinge Screw...
853C 9857	" Foot Chaining-off Plate (left) Guide Pin (long) Collar Set Screw for 68098.....
853C 9857	Presser Foot Chaining-off Plate (right) Guide Pin (long) Collar Set Screw for 68098.....
866C 9853	Feed Roll (upper) Lifter Hinge Screw for 54470.....
879D 9853	Spool Holder Disc Hub Thumb Screw for 27870.....
896E 8904	Crank Connecting Rod Cap (lower) Screw for 54017.....
896E 8904	Feed Connecting Rod Cap Screw for 54111
896E 8904	" Roll (lower) Connecting Rod Cap Screw for 54458.....
913D —	Feed Roll (upper) Pressure Regulating Thumb Screw for 54470.....
916C 9853	Hammer Tension Screw Stud for 44209..
948D 8958	Feed Roll (lower) Clutch Shaft Bracket Screw.....
948D 8958	Looper Driving Shaft and Feed Lifting Eccentric Bracket Screw for 54449 and 68217.....
948D 8958	Feed Roll (lower) Shaft Bracket Screw for 147-29 Machine, obsolete.....
965D 8910	Thread (under) Take-up Staple Bracket Screw.....

NO. PLATE	NAME
966E 9853	Feed Roll (lower) Rock Shaft Clutch Screw for 68080, obsolete.....
1011F 8904	Cloth Plate Extension Screw.....
1011F 8904	" " Screw (left).....
1019C 8908	Slack Thread Regulator Holder Shaft Collar Set Screw for 24292.....
1057E 8904	Crank Connecting Rod Cap (upper) Screw for 54017.....
1057E 8904	Feed Connecting Rod Clamping Screw for 54111.....
1103C 8904	Feed Regulating Screw for 54456.....
1103C 8904	" Roll (lower) Eccentric Regulating Screw for 54456.....
1120C 8958	Looper (front) Set Screw for 54061.....
1133E 8958	Needle Bar Bushing (lower) Set Screw...
1133E 8958	" " " (upper) Set Screw...
1133E 8958	Presser Bar Bushing (lower) Set Screw...
1133E 8958	" " " (upper) Set Screw..
1147C 8922	Looper (back) Set Screw for 54061.....
1149C 9853	Feed Roll (lower) Clutch Sleeve Set Screw for 68155.....
1149F 9853	Thread (upper) Nipper Body Set Screw for 147-38 Machine.....
1192C 9853	Belt Guard Hinge Pin Set Screw for 54476, obsolete.....
1192C 9853	Belt Guard Set Screw for 54356, obsolete
1193D 9853	Feed Roll (upper) Bar Bracket Screw (lower).....
1235F 8904	Cloth Plate Thread Guard Screw (short)
1250C 8911	Presser Bar Lifter Stop Screw.....
1253C 8908	Slack Thread Regulator Holder Shaft Crank Set Screw for 54044.....
1257C 9853	Feed Roll (lower) Connecting Rod Hinge Screw.....
1258C 8901	Arm Rotary Shaft Collar Set Screw for 54450.....
1330C 9853	Feed Roll (upper) Lifter Stop Screw for 54470.....
1443B 9853	Strip Folder Screw for 120560.....
1443B 9853	" " Edge Guide Screw for 120560
1443B 9853	" " Spring Edge Guide Screw for 120560.....
1443W 9853	Attachment Screw for 120748.....
1443W 9853	Fringe Guide Screw for 120748.....
1443W 9853	Rug Guide Screw for 120748.....
1443W 9853	Strip Folder Screw for 120560.....

NO.	PLATE	NAME
1449d	8922	Thread (upper) Take-up Plate Spring Screw for 54096.
1449f	8922	Presser Foot Compensating Plate Screw for 120752.
1498f	8922	Needle Set Screw for 54064.
1516e	8904	Crank Connecting Rod Ball Screw Stud Nut.
1520j	8991	Needle Bar Connecting Link Hinge Stud Nut.
1539w	8908	Pressure Regulating Thumb Screw Lock Nut.
1547j	8909	Tension (upper thread) Releasing Shaft Stop Screw Nut.
1560c	9853	Hemmer Tension Regulating Thumb Nut for 44209.
1620e	9853	Feed Roll (lower) Connecting Rod Hinge Screw Nut.
1698u	9853	Thread (upper) Nipper Disc (outside) Nut for 68137.
1700j	9853	Feed Roll (lower) Clutch (brake) Connection Adjusting Screw Nut for 68149.
1872	8908	Presser Bar Lifter Roller and Stud for 61047.
1876	9000	Feed Roll (upper) Bar Collar Roller and Screw Stud for 54470.
1963	8908	Presser Bar Guide Bracket Roller and Stud for 54039.
2102	8909	Tension (under thread) Disc.
2102	8909	" (upper thread) Disc.
2117	8901	Arm Rock Shaft Crank (front) Pin.
2763	9861	Rock Shaft for 23767.
2766	9861	" " Knee Arm Hub with 356c, for 6336.
2770	9861	Rock Shaft Stop Dog with 356c, for 23767.
3146	9860	Hemmer Folder Thumb Screw Washer for 120632.
4604	9860	Tape Holder Disc Rivet for 35891 and 35893.
482z	8941	Wrench for 1547 (Accessories).
4879	8941	Chain Connecting Link for 6439.
4882	8941	Treadle Shaft for 126252.
6335	9861	Rock Shaft Knee Arm for 6336.
6336	----	Rock Shaft Knee Arm complete for 23767, Nos. 2766, 2767 and 6335.
6337	9861	Rock Shaft Lifting Bracket with two 356c for 23767.

NO.	PLATE	NAME
6439	----	Chain, 36 in. to 45 in., with 56864 and 56865.
6575	8904	Crank Connecting Rod Oil Pad Stop Pin for 54017.
7071	8904	Feed Eccentric Clamping Washer for 54456.
7071	8904	" Roll (lower) Eccentric Clamping Washer for 54456.
7125	9861	Rock Shaft Lifting Bracket Hook for 23767.
8908	8941	Wrench for 1520 and 1620 (Accessories).
9842	9862	Machine Base Screw Stud Nut Washer for 54479.
10248	9860	Hemmer Tension Plate Position Pin for 120626.
11119	8901	Arm Oil Tube with 52045, for oiling 68137, for 147-38 Machine.
11173	8908	Presser Bar Guide Bracket Guide.
11564	9860	Tape Holder Spindle Spring for 35905.
12152	9860	Spool Holder Disc Rivet for 27870.
12242	9861	Rock Shaft Hanger with two wood screws 1 in. No. 10, for 23767.
13218	9860	Thread (upper) Nipper Stud Spring for 68137.
13710	9860	Hemmer Tension Spring for 120632.
15196	8902	Arm Side Cover (back).
17547	8909	Tension (under thread) Thread Guide.
18055	9857	Presser Foot Hinge Pin for 120752.
19221	8941	Wrench for 1516 (Accessories).
21506	8904	Feed Connecting Rod Hinge Pin Collar with 457c, for 54077 and 68022.
21788	9860	Feed Roll (lower) Retaining Clutch Frame Spring for 54468, obsolete.
23404	9000	Feed Roll (upper) Bar Spring for 54470.
23767	9861	Rock Shaft complete, Nos. 2763, 2770, 6336, 6337, 7125 and two 12242.
24292	8908	Slack Thread Regulator Holder Shaft Collar with 1019c.
24701	9857	Presser Foot Compensating Plate Spring for 120752.
25303	9856	Presser Bar Ball, size 1/4 in., for 64330.
26026	8941	Screw Driver, large (Accessories).
26276	8911	Presser Foot Hinge Pin for 53076, 54102, 54118, 54121, 68104, 68220, 120353, 120385, 120406 and 120553.
26485	8941	Screw Driver, small (Accessories).
27347	9860	Belt Guard Hinge Pin for 54479, obsolete.

NO.	PLATE	NAME
27723	9867	Spool Holder Base with 168B and three wood screws 1 in. No. 10, for 120529...
27739	8996	Thread Unwinder Thread Cone (wood) for large cones, for 225398.....
27870	9867	Spool Holder Disc (8 in.) with 879D, 27871 and five 12152, for 120529.....
27871	—	Spool Holder Disc Hub for 27870.....
27998	9862	Bench Stand Flap Hook and Eye (brass) with wood screw ½ in. No. 5, for 79756
28012	9000	Tape Reel Screw Eye for 120680.....
32572	8909	Tension (upper thread) Releasing Disc...
35889	5729	Tape Holder Arm Shaft for 35905.....
35890	5729	“ “ Disc for 35891.....
35891	—	“ “ “ 35890 with 35894 and five 4604 for 35905.....
35892	5729	Tape Holder Disc for 35893.....
35893	—	“ “ “ 35892 with 35895 and five 4604 for 35905.....
35894	5729	Tape Holder Disc Hub for 35891.....
35895	5729	“ “ “ “ with 457c, for 35893.....
35896	5729	Tape Holder Spindle for 35905.....
35897	9851	“ “ “ Sleeve for 35905....
35898	5729	“ “ “ “ Spring (flat) for 35905.....
35903	5729	Tape Holder Arm with 457c and 797c for 35905.....
35904	5729	Tape Holder Tape Guide for 35905.....
35905	—	Tape Holder (9 in. disc) Adjustable complete, for 35907, Nos. 284b, 11564, 35889, 35891, 35893, 35896 to 35898, 35903, 35904 and 40043.....
35906	9867	Tape Holder Stand with two 647b and four wood screws 1 in. No. 10 for 35907
35907	—	Tape Holder with Stand complete, for under the bench, for Strip Folder No. 120560, Nos. 35905 and 35906.....
36006	9862	Strip Folder Shank Hinge Screw Friction Washer for 120560.....
36006	9862	Tape Guide Hinge Screw Friction Washer for 120748.....
37563	—	Chain, length 15 in., with 56864 and 56865
38210	8909	Thread (under) Nipper Spring (lower)...
38211	8909	“ “ “ “ (upper)...
38419	8904	Cloth Plate Slide (left) Spring for 54013 and 68108.....

NO.	PLATE	NAME
38419	8904	Cloth Plate Slide (right) Spring for 54015, 54056, 68093 and 68167.....
38456	8991	Needle Bar Bushing (lower).....
38456	8991	Presser Bar Bushing (upper).....
38468	8908	“ “ Spring Stud.....
38475	8910	Thread (under) Take-up with 465c, for 147-29 Machine.....
38481	8910	Thread (under) Take-up Staple Thread Guard for 54435.....
38482	8910	Thread (under) Take-up Stripper.....
38487	8941	Threading Wire (Accessories).....
38648	9856	Feed Roll (upper) Lifter Latch Spring for 54470.....
40043	9860	Tape Holder Spindle Spring Collar with 237E, for 35905.....
40326	9856	Looper Driving Shaft and Feed Lifting Eccentric Oil Pad (braided cotton)....
41538	—	Bench Stand Flush Bolt with Plate complete, for 79756, Nos. 126247, 126248 and four brass wood screws ¾ in. No. 4
42366	8901	Arm Oil Pad (braided cotton) for oiling Arm Rock Shaft Front Bearing.....
44209	—	Hemmer Tension Screw Stud 916c with 1560c, for 120632.....
46009	9858	Thread (upper) Eyelet for 147-29 Machine.....
46011	8909	Thread (under) Take-up Staple Spring...
46062	9863	Feed Dog, 18 teeth (16 teeth to the inch) for 120560.....
46081	9852	Feed Dog, 17 teeth (16 teeth to the inch) for 46090, for 147-29 Machine.....
46087	—	Presser Foot Shank for 54102, 54118, 68220, 120353, 120385 and 120406....
46090	9852	Throat Plate, for ¼ in. to ¾ in. gauges, for 46081.....
46099	—	Presser Foot Shank for 120553.....
46111	8911	Face Plate Pin.....
46247	8909	Thread (under) Nipper Spring (upper) Stop.....
49013	8904	Arm Rotary Shaft Front Bearing Oil Pad (braided cotton).....
49013	8904	Looper Carrier Connection Shaft Oil Pad (braided cotton).....
49092	8908	Cloth Plate Oil Tube Packing (felt) for 54309.....
49092	8908	Oil Tube Packing (felt) for 54110.....

NO.	PLATE	NAME
49123	8996	Machine Base Oil Pipe for 54479.....
49124	9862	“ “ “ “ Valve for 54479..
50069c	8904	Crank Connecting Rod Ball Screw Stud..
50083c	8901	Arm Rock Shaft Crank (back) Set Screw for 54005.....
50083c	8901	Feed Roll (lower) Clutch (brake) Con- nection Set Screw for 68149.....
50083c	8901	Feed Roll (lower) Clutch (drive) Con- nection Set Screw for 68150.....
50084c	8901	Arm Rotary Shaft Bushing (intermediate) Set Screw (short).....
50150c	8908	Slack Thread Regulator Set Screw for 54042.....
50326c	9853	Tension (under thread) Screw Stud for 59539.....
50326c	9853	Tension (upper thread) Screw Stud for 59539.....
50333c	9853	Feed Roll (lower) Set Screw for 54457 and 68058.....
50333c	9853	Feed Roll (upper) Set Screw for 54457, 54481, 68059 and 68221.....
50333c	9853	Feed Roll Set Screw for 68021.....
50129c	8904	“ Dog Stop Screw for 54019 and 54488
50473F	8904	Cloth Plate Screw (right).....
50473F	8904	“ “ Thread Guard Screw (long)
51097J	9853	Hammer Folder Thumb Screw for 120632
51570c	9853	Tension (under thread) Regulating Thumb Nut for 59539.....
51570c	9853	Tension (upper thread) Regulating Thumb Nut for 59539.....
51576E	9862	Machine Base Screw Stud Nut for 54479
51577E	9862	“ Screw Stud Nut for 54479.....
52045	8901	Arm Rock Shaft Bushing Oil Pad (braided cotton) for 64387 and 64389.....
52045	8901	Arm Rock Shaft Flanged Bushing (front) Oil Pad (braided cotton).....
52045	8901	Arm Rotary Shaft Bushing (front) Oil Pad (braided cotton).....
52045	8901	Arm Oil Tube Packing (braided cotton) for 11119 and 56003.....
53075	—	Presser Foot Plate for 53076.....
53076	9857	Presser Foot (hinged) complete for 147-29 Machine, Nos. 26276, 46087 and 53075
53225	9858	Thread (under) Eyelet (back).....
54002	8902	Arm Rock Shaft for 54079.....
54004	8901	“ “ “ Collar with two 453c, for 54079 and 68119.....

NO.	PLATE	NAME
54005	8901	Arm Rock Shaft Crank (back) with two 50083c, for 54079 and 68119.....
54006	9850	Arm Rotary Shaft for 68017.....
54007	8902	“ “ “ Bushing (intermediate) for 54089.....
54009	8902	Arm Rotary Shaft Flanged Bushing for 54090.....
54010	8904	Arm Side Cover (front).....
54012	8902	Cloth Plate Slide (left) for 54013.....
54013	—	Cloth Plate Slide (left) complete, for 54453, 68057, 68143, 68144 and 68248, Nos. 38419, 54012 and two 725J.....
54014	8913	Cloth Plate Slide (right) for 54015.....
54015	—	Cloth Plate Slide (right) complete for 68057 and 68144, Nos. 38419, 54014 and two 725J.....
54017	8902	Crank Connecting Rod with 6575, 54018, 51218, 54897, 57222 and two each 896E and 1057E for 54088.....
*54018	—	Crank Connecting Rod Cap (upper) for 54017.....
54019	8902	Feed Bar with 50429c and two 453c, for 54077.....
54020	8902	Feed Bar Connection for 54077 and 68022
54023	8911	“ Connecting Rod Hinge Pin for 54077 and 68022.....
*54024	—	Feed Eccentric for 54456.....
*54024	—	“ Roll (lower) Eccentric for 54456....
54026	9851	“ Rocking Frame with two 453c, for 54077.....
54027	8960	Looper Carrier with two 171b, for 54383.
*54032	—	“ “ Driver Cap for 54230....
*54034	—	“ Driving Shaft and Feed Lifting Eccentric Bracket with 761E, for 54449 and 68217.....
54038	8991	Needle Guard Holder.....
51039	8908	Presser Bar Guide Bracket with 453c, 640w and 1963.....
54040	9855	Presser Bar Spring (flat).....
54042	8908	Slack Thread Regulator Holder with 175E and 50150c.....
54043	8908	Slack Thread Regulator Holder Shaft
54044	8908	“ “ “ “ “ “ Crank (forked) with 1253c.....
54047	8909	Tension (upper thread) Releasing Shaft Crank with 624c.....

NO.	PLATE	NAME
54048	8909	Tension (upper thread) Releasing Shaft Crank Link.....
54049	9855	Thread (under) Take-up Staple Bracket with 460c.....
54055	9868	Cloth Plate Slide (right) for 54056.....
54056	—	Cloth Plate Slide (right) complete for 54453 and 68143, Nos. 38419, 54055 and two 725J.....
54061	8922	Looper Holder with 1120c and 1147c, 54055 and two 725J.....
54062	—	Needle Bar complete, for $\frac{3}{32}$ in. to $\frac{1}{4}$ in. gauges, Nos. 54064, 54065 and 64319..
54063	—	Needle Bar complete, for $\frac{3}{32}$ in. to $\frac{3}{8}$ in. gauges, Nos. 54064, 54066 and 64319..
54064	8922	Needle Clamp with two 1498r, for 54062 and 54063.....
54065	8922	Needle Clamp Thread Guard for 54062..
54066	8922	“ “ “ “ “ 54063..
54067	8922	“ Guard, for $\frac{3}{32}$ in. to $\frac{5}{32}$ in. gauges, for 147-29 Machine.....
54068	8922	Needle Guard, for $\frac{3}{16}$ in. to $\frac{9}{32}$ in. gauges, for 147-29 Machine.....
54069	8922	Needle Guard, for $\frac{1}{16}$ in. to $\frac{3}{8}$ in. gauges, for 147-29 Machine.....
54070	8996	Tension (upper thread) Bracket.....
54071	8922	“ “ “ Releasing Shaft..
54072	9858	Thread (under) Eyelet (front).....
54075	9860	“ (upper) Take-up for 147-38 Machine.....
54077	—	Feed Rocking Frame 54026 with 21506, 54019, 54020, 54023 and 57225, for 147-29 Machine.....
54079	—	Arm Rock Shaft 54002 with 54004, 54005 and 64225, for 147-38 Machine.....
54080	8960	Looper Driving Shaft and Feed Lifting Eccentric Bracket Bushing.....
54088	—	Crank Connecting Rod 54017 with 50069c, for 68017 and 68218.....
54089	—	Arm Rotary Shaft Bushing (intermediate) 54007 with 64508 and 64805.....
54090	—	Arm Rotary Shaft Flanged Bushing 54009 with 58039 and 64805.....
54094	8922	Thread (upper) Take-up for 54096.....
54095	8922	“ “ “ Plate for 54096..
54096	—	Thread (upper) Take-up complete for 147-29 Machine, Nos. 1449D, 54094, 54095 and 68164.....

NO.	PLATE	NAME
54097	8950	Feed Dog, 14 teeth (12 teeth to the inch) for 120524, 120709 and 120743.....
54098	8950	Feed Dog, 18 teeth (16 teeth to the inch) for 120524, 120709 and 120743.....
54099	8950	Feed Dog, 20 teeth (18 teeth to the inch) for 120524, 120709 and 120743.....
54100	8950	Throat Plate, for $\frac{3}{8}$ in. to $\frac{3}{8}$ in. gauges, for 54097 to 54099 and 54114.....
54101	—	Presser Foot Plate for 54102.....
54102	8951	Presser Foot (hinged) complete, with left hand guide on toe, for 120524, 120709 and 120743, Nos. 26276, 46087 and 54101
54105	8901	Arm Rock Shaft Flanged Bushing (front)
54106	9856	Looper (back) closed eye.....
NOTE: When ordering No. 54106, state gauge of machine for which required.		
54107	9856	Looper (front) closed eye.....
NOTE: When ordering No. 54107, state gauge of machine for which required.		
54108	—	Oil Tube for 54110.....
54109	—	“ “ Bracket for 54110.....
54110	8908	Oil Tube complete, for oiling Crank Connecting Rod (upper bearing), Nos. 49092, 54108 and 54109.....
54111	8902	Feed Connecting Rod with 1057E, 54112 and two 896E, for 68018.....
*54112	—	Feed Connecting Rod Cap for 54111.....
*54112	—	“ Roll (lower) Connecting Rod Cap for 54458.....
54114	8950	Feed Dog, 11 teeth (10 teeth to the inch) for 120524, 120709 and 120743.....
54117	—	Presser Foot Plate for 54118.....
54118	8951	Presser Foot (hinged) complete, with right hand guide on toe, for 120524, 120709 and 120743, Nos. 26276, 46087 and 54117.....
54119	—	Presser Foot Plate for 54121.....
54120	—	“ “ Shank for 54121.....
54121	8951	Presser Foot (hinged) complete with left hand guide on toe, for 120524, 120709 and 120743, Nos. 26276, 54119 and 54120.....
54210	9855	Balance Wheel, 2 $\frac{5}{8}$ in. pulley, with two 430c, for 147-38 Machine.....

NO.	PLATE	NAME
54218	8904	Crank Connecting Rod Oil Pad (braided cotton) for 54017.....
54227	8960	Looper Carrier Connection for 54383.....
54228	8960	" " " Shaft for 54383
54229	8960	" " " Shaft Bushing
54230	8960	" " Driver with 54032 and four 175e, for 54383.....
54242	9856	Slack Thread Controller Clamp.....
54309	9000	Cloth Plate Oil Tube with 49092, for oiling 54458, for 54453, 68057, 68143, 68144, 68210 and 68248.....
54326	8991	Needle Bar Connecting Link.....
54327	8991	" " " " Hinge Stud
54328	8991	" " " Stud with 211f and two 187e.....
54330	9858	Thread (upper) Controller for 147-29 Machine.....
54356	9861	Belt Guard with 1192c for 54479, obsolete
54367	9000	Arm Rotary Shaft Bushing (front).....
54368	9856	Looper Driving Shaft and Feed Lifting Eccentric with 227d and two 64315, for 54383.....
54381	9856	Slack Thread Controller.....
54383	—	Looper Driving Shaft and Feed Lifting Eccentric 54368 with 54027, 54227, 54228 and 54230, for 68017 and 68218.
54435	9858	Thread (under) Take-up Staple with 590d and 38481.....
*54449	—	Arm, upper and lower (solid) with 948d and 54034, for 147-29 Machine.....
54450	9000	Arm Rotary Shaft Collar with two 1258c, for 68017 and 68218.....
54451	9865	Cloth Plate for 54453 and 68057, obsolete
54452	9865	Cloth Plate Extension for 147-29 Machine, obsolete.....
54453	—	Cloth Plate complete, for $\frac{3}{8}$ in. and $\frac{3}{8}$ in. gauges, for 147-29 Machine, Nos. 54013, 54056, 54309 and 54451, obsolete.....
54454	9859	Cloth Plate Thread Guard for 147-29 Machine, obsolete.....
*54455	—	Feed Eccentric Body for 54456.....
*54455	—	" Roll (lower) Eccentric Body for 54456.....
54456	9000	Feed Eccentric (adjustable) complete for 68018, Nos. 217d, 1103c, 7071, 54024, 54455 and two 443c.....

NO.	PLATE	NAME
54456	9000	Feed Roll (lower) Eccentric (adjustable) complete for 68016, Nos. 217d, 1103c, 7071, 54024, 54455 and two 443c.....
54457	9864	Feed Roll (lower) with two 50333c, for 68207.....
54457	9864	Feed Roll (upper) with two 50333c, for 54475.....
54458	9854	Feed Roll (lower) Connecting Rod with 54112 and two 896e, for 68016.....
54459	9868	Feed Roll (lower) Retaining Clutch with two 448c, for 68080, obsolete.....
54460	9868	Feed Roll (lower) Retaining Clutch Frame with 54463, for 68080, obsolete.....
54461	9868	Feed Roll (lower) Retaining Clutch Frame Cover with 54462, for 68080, obsolete..
54462	9868	Feed Roll (lower) Retaining Clutch Frame Cover Pad (felt) for 54461, obsolete...
54463	9868	Feed Roll (lower) Retaining Clutch Frame Pad (felt) for 54460, obsolete.....
54464	9868	Feed Roll (lower) Rock Shaft for 68080, obsolete.....
54465	9868	Feed Roll (lower) Rock Shaft Clutch for 68080, obsolete.....
54466	9860	Feed Roll (lower) Retaining Clutch Roller Spring for 68080, obsolete.....
54466	9860	Feed Roll (lower) Rock Shaft Clutch Roller Spring for 68080, obsolete.....
54467	9859	Feed Roll (lower) Clutch Shaft Bracket for 68207.....
54467	9859	Feed Roll (lower) Shaft Bracket for 54468, obsolete.....
54468	—	Feed Roll (lower) Shaft Bracket complete for 147-29 Machine, Nos. 21788, 54457, 54467, 127521, 127530 and two each 158d and 62562, obsolete.....
54469	9851	Feed Roll (upper) Bar Bracket with 453c, for 54470.....
54470	—	Feed Roll (upper) Bar Bracket complete, Nos. 79c, 866c, 1326d, 1330c, 1876, 23404, 38648, 54469, 54471 to 54473, 54475, 127534, 127536, 127542 and two 208d.....
54471	9855	Feed Roll (upper) Lifter for 54470.....
54472	9855	" " " " Latch for 54470.
54473	9856	" " " " " Stop for 54470.....
54474	9856	Presser Bar Lifter.....

NO.	PLATE	NAME
54475	---	Feed Roll (upper) Bracket 127538 with 54457 and 127546, for 54470.....
54476	9861	Machine Base for 54479.....
54477	9862	" " Screw Stud for 54479.....
54478	9862	" " Screw Stud, to fasten machine to base, for 54479.....
54479	----	Machine Base complete, Nos. 49123, 49124, 54476, three each 9842, 51576c, 54477, 57285 and four each 51577E and 54478.....
54481	9864	Feed Roll (upper) 1 in. wide, with two 50333c, for 120632.....
54488	----	Feed Bar with 50429c and two 453c, for 68022.....
54509	9860	Hemmer Elastic Guide Position Pin for 120628.....
54897	8904	Crank Connecting Rod Oil Cup for 54017
54988	8909	Tension (upper thread) Releasing Pin....
54990	8909	" " " " Shaft Spring, obsolete, use 68261.....
56003	9000	Arm Oil Tube with 52045, for oiling 54326
56006	8901	" " Pad (braided cotton) for oiling Arm Rock Shaft Intermediate Bearing.
56864	8941	Chain Hook (large) for 6439 and 37563..
56865	8910	" " (small) for 6439 and 37563..
57076	9858	Tension (upper thread) Thread Guide....
*57222	----	Crank Connecting Rod Cap (lower) for 54017.....
57225	8904	Feed Bar Hinge Pin for 54077 and 68022.
57234	8911	" " Rocking Frame Hinge Pin.....
57235	9000	" " " " " Bushing
57258	8911	Presser Bar Lifter Hinge Pin.....
57285	8996	Machine Cushion (felt) for 54479.....
58039	8902	Arm Rotary Shaft Flanged Bushing Oil Pad, long (braided cotton) for 54090...
59456	9860	Thread (upper) Nipper Disc (outside) Nut Washer for 68137.....
59534	9858	Tension (under thread) Spring.....
59535	9858	" (upper thread) Spring.....
59537	9858	" (under thread) Spring Bushing (large).....
59537	9858	Tension (upper thread) Spring Bushing (large).....
59538	9858	Tension (under thread) Spring Bushing (small).....
59538	9858	Tension (upper thread) Spring Bushing (small).....

NO.	PLATE	NAME
59539	----	Tension (under thread) Screw Stud 50326c with 51570c.....
59539	----	Tension (upper thread) Screw Stud 50326c with 51570c.....
60656	9855	Hinge for 79756.....
61047	8911	Presser Bar Lifting Bracket with 460c and 1872.....
61075	8911	Presser Bar Lifting Lever Connecting Stud.....
62562	9000	Feed Roll (lower) Clutch Shaft Bracket Collar with two 465c.....
62562	9000	Feed Roll (lower) Clutch Shaft Bracket Collar with two 465c, for 54468, obsolete
64255	8911	Arm Rock Shaft Crank (front) with 453c, for 54079 and 68119.....
64259	8913	Balance Wheel with two 430c, for 147-29 Machine.....
64268	8904	Crank Connecting Rod Ball Screw Stud Washer.....
64269	8913	Face Plate.....
64315	8960	Looper Driving Shaft and Feed Lifting Eccentric Oil Hole Plug for 54368.....
64319	8922	Needle Bar (hollow) for 54062 and 54063
64320	8991	" " Bushing (upper).....
64330	9855	Presser Bar with 25303.....
64331	8911	" " Bushing (lower).....
64337	8922	Slack Thread Regulator for 147-29 Machine.....
64351	8909	Thread (under) Nipper Cam with 465c for 68017 and 68218.....
64355	8910	Thread (under) Take-up Thread Guard (brass) for 68017 and 68218.....
64356	8910	Thread (under) Take-up Thread Guard Steady Pin.....
64386	8901	Arm Rock Shaft Bushing (back) for 64387
64387	----	" " " " " " 64386 with 52045.....
64388	8901	Arm Rock Shaft Bushing (intermediate) for 64389.....
64389	----	Arm Rock Shaft Bushing (intermediate) 64388 with 52045.....
64508	8902	Arm Rock Shaft Bushing (intermediate) Oil Pad, long (braided cotton) for 54089
64805	9000	Arm Rotary Shaft Bushing (intermediate) Oil Pad, short (braided cotton) for 54089
64805	9000	Arm Rotary Shaft Flanged Bushing Oil Pad, short (braided cotton) for 54090..

NO.	PLATE	NAME
68016	---	Feed Roll (lower) Connecting Rod 54458 with 54456, for 68017 and 68218.....
68017	---	Arm Rotary Shaft 54006 with 640e, 54088, 54383, 54450, 64351, 64355, 68016 and 68018, for 147-29 Machine.....
68018	---	Feed Connecting Rod 54111 with 54456, for 68017 and 68218.....
68021	9854	Feed Roll (rubber) with two 50333c.....
68022	---	" Rocking Frame 54026 with 21506, 54020, 54023, 54488 and 57225, for 147-38 Machine.....
68057	---	Cloth Plate complete, for $\frac{3}{32}$ in. to $\frac{5}{16}$ in. gauges, for 147-29 Machine, Nos. 54013, 54015, 54309 and 54451, obsolete.....
68058	9864	Feed Roll (lower) $1\frac{1}{4}$ in. wide, with two 50333c, for 120560 for 147-29 Machine and for 120748 for 147-38 Machine....
68059	9864	Feed Roll (upper) 1 in. wide, with two 50333c, for 120560 for 147-29 Machine
68080	---	Feed Roll (lower) Retaining Clutch Frame 54460 with 54459, 54461, 54464, 54465, three 127528, four each 966e, 127531, six 208d and fourteen 54466, for 147-29 Machine, obsolete.....
68095	---	Feed Dog, 25 teeth (20 teeth to the inch) for 68105, for 120632.....
Nos. 68096 to 68103 for 68104		
68096	---	Presser Foot Chaining-off Plate (left) with 68097 and 68099.....
68097	9857	Presser Foot Chaining-off Plate (left) Guide Pin (long) for 68096.....
68097	9857	Presser Foot Chaining-off Plate (right) Guide Pin (long) for 68101.....
68098	9857	Presser Foot Chaining-off Plate (left) Guide Pin (long) Collar with 853c.....
68098	9857	Presser Foot Chaining-off Plate (right) Guide Pin (long) Collar with 853c.....
68099	9857	Presser Foot Chaining-off Plate (left) Guide Pin (short) for 68096.....
68099	9857	Presser Foot Chaining-off Plate (right) Guide Pin (short) for 68101.....
68100	9857	Presser Foot Chaining-off Plate (left) Spring.....
68100	9857	Presser Foot Chaining-off Plate (right) Spring.....

NO.	PLATE	NAME
68100	9857	Presser Foot Spring.....
68101	---	" " Chaining-off Plate (right) with 68097 and 68099.....
68102	---	Presser Foot Plate.....
68103	---	" " Shank.....
68104	9857	Presser Foot (spring hinged) with right and left chaining-off and guide plates complete, for $\frac{5}{16}$, $\frac{11}{32}$ and $\frac{3}{8}$ in. gauges, for 120632, Nos. 26276, 68096, 68101 to 68103, two 68098 and three 68100.....
68105	---	Throat Plate, for $\frac{5}{16}$ in., $\frac{11}{32}$ in. and $\frac{3}{8}$ in. gauges, for 68095, for 147-29 Machine.
68107	9868	Cloth Plate Slide (left) for 68108.....
68108	---	Cloth Plate Slide (left) complete, for 68210, Nos. 38419, 68107 and two 725j
68110	9850	Arm Rotary Shaft for 68218.....
68118	9850	" Rock Shaft for 68119.....
68119	---	" " " 68118 with 54004, 54005 and 64255 for 147-38 Machine.....
68128	9858	Thread (under) Take-up with two 465c, for 147-38 Machine.....
68129	9860	Thread (upper) Nipper Body for 68137..
68130	9860	" " " Disc (inside) for 68137.....
68131	9860	Thread (upper) Nipper Disc (inside) Washer (fibre) for 68137.....
68132	9860	Thread (upper) Nipper Disc (outside) for 68137.....
68133	9860	Thread (upper) Nipper Roller for 68136..
68134	9860	" " " " Hinge Pin for 68136.....
68135	9860	Thread (upper) Nipper Stud for 68136..
68136	---	" " " " 68135 with 68133 and 68134, for 68137.....
68137	---	Thread (upper) Nipper complete for 147-38 Machine, Nos. 1698R, 13218, 59456, 68129 to 68132 and 68136.....
68138	9860	Thread (upper) Nipper Thread Guide for 147-38 Machine.....
68142	9850	Cloth Plate for 68143, 68144 and 68248..
68143	---	Cloth Plate complete, for $\frac{1}{8}$ in. to $\frac{1}{4}$ in. gauges, for 46090, for 147-29 Machine, Nos. 54013, 54056, 54309 and 68142...
68144	---	Cloth Plate complete, for $\frac{3}{32}$ in. to $\frac{5}{16}$ in. gauges, for 46089, for 147-29 Machine, Nos. 54013, 54015, 54309 and 68142...
68145	9850	Cloth Plate Extension.....

NO.	PLATE	NAME
68146	9859	Cloth Plate Thread Guard.....
68147	9854	Feed Roll (lower) Clutch (brake) for 68156.....
68148	9854	Feed Roll (lower) Clutch (drive) for 68156
68149	9854	“ “ “ “ (brake) Connection with 440c, 1700j and two 50083c, for 68156.....
68150	9854	Feed Roll (lower) Clutch (drive) Connection with two 50083c, for 68156.....
68151	9000	Feed Roll (lower) Clutch Roller for 68156
68152	9000	“ “ “ “ “ Plunger for 68156.....
68153	9000	Feed Roll (lower) Clutch Roller Spring for 68156.....
68154	9850	Feed Roll (lower) Clutch Shaft for 68157
68155	9854	“ “ “ “ Sleeve with four 1149c, for 68156.....
68156	---	Feed Roll (lower) Clutch complete for 68157, Nos. 68147 to 68150, 68155 and six each 68151 to 68153.....
68157	----	Feed Roll (lower) Clutch Shaft 68154 with 68156, for 68207.....
68164	9858	Thread (upper) Take-up Plate Spring for 54096.....
68166	----	Cloth Plate Slide (right) for 68167.....
68167	----	Cloth Plate Slide (right) complete for 68248, Nos. 38419, 68166 and two 7251
68184	9855	Presser Bar Lifting Lever Extension.....
68191	----	Cloth Plate Slide (right) for 69192.....
68192	----	Cloth Plate Slide (right) complete for 68210 and 68260, Nos. 38419, 68191 and two 7251.....
68194	9852	Feed Dog, 14 teeth (10 teeth to the inch) for 120524, 120709, 120743 and 120748
68197	9858	Needle Guard, for $\frac{1}{4}$ in. to $\frac{3}{8}$ in. gauges, for 147-38 Machine.....
68198	9852	Throat Plate, for $\frac{1}{8}$ in. to $\frac{3}{8}$ in. gauges, for 68194.....
68199	9858	Slack Thread Regulator for 147-38 Machine.....
68200	9863	Feed Dog, 25 teeth (20 teeth to the inch) for 68201, for 120632.....
68201	9863	Throat Plate, for $\frac{3}{2}$ in. to $\frac{3}{2}$ in. gauges, for 68200.....
68207	---	Feed Roll (lower) Clutch Shaft Bracket complete, Nos. 54457, 54467, 68157, 127530 and two each 158d and 62562..

NO.	PLATE	NAME
68208	9855	Presser Bar Lifting Lever.....
68209	9865	Cloth Plate for 68210.....
68210	---	Cloth Plate complete, for $\frac{1}{2}$ in. to $\frac{3}{8}$ in. gauges, for 68105 and 68201, for 120632, Nos. 54309, 68108, 68192 and 68209...
*68217	---	Arm, upper and lower (solid) with 948d and 54034, for 147-38 Machine.....
68218	---	Arm Rotary Shaft 68110 with 640e, 54088, 54383, 54450, 64351, 64355, 68016 and 68018, for 147-38 Machine.....
68219	---	Presser Foot Plate for 68220.....
68220	9857	Presser Foot (hinged) complete, for $\frac{1}{8}$ in. to $\frac{3}{8}$ in. gauges, for lap seam feller, for 120524, 120709 and 120743, Nos. 26276, 46087 and 68119.....
68221	9854	Feed Roll (upper) $\frac{1}{2}$ in. wide, with two 50333c, for 120748, for 147-38 Machine
68222	9859	Belt Guard with two wood screws 1 in. No. 12.....
68248	---	Cloth Plate complete, for $\frac{3}{2}$ in. to $\frac{3}{8}$ in. gauges, for 46090, for 147-29 Machine, Nos. 54013, 54309, 68142 and 68167...
68260	---	Cloth Plate complete, for $\frac{1}{8}$ in. to $\frac{3}{8}$ in. gauges, for 68198, for 147-38 Machine, Nos. 54013, 54309, 68142 and 68192...
68261	---	Tension (upper thread) Releasing Shaft Spring.....
79756	---	Bench Stand with 27998, 41538, two each 60656, 124500, wood screws $1\frac{1}{4}$ in. No. 14 and eight each wood screws $\frac{5}{8}$ in. No. 5 and $\frac{5}{8}$ in. No. 7.....
120341	8941	Tweezers, curved (Accessories).....
120344	8941	Oiler (copper plated) with 120345 (Accessories).....
120345	8941	Oiler Spout, 5 in. long, for 120344.....
120351	8949	Feed Dog, 23 teeth (22 teeth to the inch) for 120524, 120709 and 120743.....
120352	---	Presser Foot Plate for 120353.....
120353	8951	Presser Foot (hinged) complete for 120524, 120709 and 120743, Nos. 26276, 46087 and 120352.....
120354	8949	Throat Plate, for $\frac{3}{2}$ in. to $\frac{3}{8}$ in. gauges, for 120351 and 120387.....
120361	8949	Feed Dog, 23 teeth (22 teeth to the inch) for 120524, 120709 and 120743.....
120362	8949	Throat Plate, for $\frac{1}{2}$ in. and $\frac{1}{4}$ in. gauges, for 120361 and 120407.....

NO.	PLATE	NAME
120383	8950	Feed Dog, 14 teeth (12 teeth to the inch) for 120524, 120709 and 120743.....
120384	---	Presser Foot Plate for 120385.....
120385	8951	Presser Foot (hinged) complete for 120524, 120709 and 120743, Nos. 26276, 46087 and 120384.....
120386	8950	Throat Plate, for $\frac{5}{16}$ in. to $\frac{3}{8}$ in. gauges, for 120383.....
120387	8949	Feed Dog, 17 teeth (16 teeth to the inch) for 120524, 120709 and 120743.....
120405	---	Presser Foot Plate for 120406.....
120406	8951	Presser Foot (hinged) complete for 120524, 120709 and 120743, Nos. 26276, 46087 and 120405.....
120407	8949	Feed Dog, 17 teeth (16 teeth to the inch) for 120524, 120709 and 120743.....
120524	9866	Lap Seam Feller on Shank, for general work, for light and medium weight material.....
120528	9867	Spool Holder Rod for 120529.....
120529	---	Spool Holder complete, for elastic material, for Hemmer No. 120632, Nos. 27723, 120528 and two 27870.....
120551	---	Presser Foot Plate for 120553.....
120552	9857	" " Spreader, for elastic work, for 120553.....
120553	9857	Presser Foot (hinged) elastic spreader complete, for 120560, Nos. 26276, 46099, 120551, 120552 and two 218w.....
Nos. 120554 to 120559 FOR 120560		
120554	9864	Strip Folder (adjustable).....
120555	---	" " Edge Guide, for body of garment.....
120556	9864	Strip Folder Spring Edge Guide, for jack-lastic.....
120557	9864	Strip Folder Shank.....
120558	9864	" " " Plate.....
120559	---	" " " Stop.....
120560	9864	Strip Folder (adjustable) on Throw-out Shank complete, for attaching jack-lastic to heavy sport blouses, for 147-29 Machine, Nos. 96B, 36006, 120554 to 120559 two 665B and six 1443B.....
120561	9863	Throat Plate, for $\frac{9}{32}$ in. to $\frac{3}{8}$ in. gauges, for 46062.....

NO.	PLATE	NAME
Nos. 120626 to 120631 FOR 120632		
120626	9864	Hemmer Bracket with 10248.....
120627	---	" " Elastic Guide.....
120628	---	" " " Spring with 54509.....
120629	9864	" " Folder.....
120630	---	" " Tension Elastic Guide.....
120631	---	" " " Plate.....
120632	9864	Hemmer with Elastic Tension complete, for hemming and inserting elastic in Rayon bloomers, for 147-29 Machine, Nos. 13710, 44209, 120626 to 120631 and two each 229B, 3146 and 51097J
*120671	---	Tape Reel Disc for 120672.....
120672	9867	" " " 120671 with 120673, for 120680.....
*120673	---	Tape Reel Disc Hub for 120672.....
120674	9867	" " Rod for 120680.....
120680	---	Tape Reel (9 in. disc) complete, for under the bench, for Rug Attachment No. 120748, Nos. 28012, 120672, and 120674
120709	9866	Lap Seam Feller (adjustable, right hand) on Shank, for general work, for medium-heavy and heavy weight material.....
120743	9866	Half Lap Seam Feller on Shank, for general work, for heavy material.....
Nos. 120744 to 120747 FOR 120748		
120744	9866	Fringe Guide with Nap Guide on Bracket
120745	9866	Leveling Plate.....
120746	---	Rug Guide.....
120747	9866	Tape Guide on Shank.....
120748	9866	Attachment complete, for fringing and taping edges of rugs in one operation, for 147-38 Machine, Nos. 96B, 36006, 120744 to 120747 and four 1443w...
120749	---	Presser Foot Compensating Plate for 120752.....
120750	---	Presser Foot Plate for 120752.....
120751	---	" " Shank for 120752.....
120752	9857	Presser Foot (compensating, hinged) complete for 120748, Nos. 18055, 120749 to 120751 and two each 1449F and 24701
124500	9862	Bench Stand Flap Hinge for 79756.....
126247	9862	" " Flush Bolt for 41538.....
126248	9862	" " " " Plate for 41538.

NO.	PLATE	NAME
Nos. 126249 to 126251 for 126252		
126249	9861	Treadle.....
126250	9862	“ Spring.....
126251	9861	“ Stand.....
126252	9861	Treadle complete, Nos. 4882, 126249 to 126251 and two wood screws 1 in. No. 16
127521	9850	Feed Roll (lower) Shaft for 54468, obsolete
127528	9860	“ “ “ Retaining Clutch Roller for 68080, obsolete.....
127530	9000	Feed Roll (lower) Clutch (brake) Conne- ction Stop Block for 68207.....
127530	9000	Feed Roll (lower) Retaining Clutch Frame Stop Block for 54468, obsolete.....
127531	9860	Feed Roll (lower) Rock Shaft Clutch Roller for 68080, obsolete.....
127534	9851	Feed Roll (upper) Bar for 54470.....
127536	9000	“ “ “ “ Collar with 418c, for 54470.....
127538	9854	Feed Roll (upper) Bracket with 453c, for 54475.....
127542	9000	Feed Roll (upper) Bracket Guide Pin for 54470.....
127546	9856	Feed Roll (upper) Shaft for 54475.....
200383c	8910	Thread Unwinder Spool Rest Rod Set Screw for 202490.....
201018c	8910	Thread Unwinder Spool Rest Set Screw for 225395.....
201696j	8910	Thread Unwinder Thread Guide Lock Nut for 225398.....
202490	8953	Thread Unwinder Spool Stand with 200383c, for 225398.....
225388	8953	Thread Unwinder Spool Rest Rod for 225398.....
225390	8996	Thread Unwinder Thread Cone Holder, for inverted cones, for 225398.....
225391	8953	Thread Unwinder Thread Guide for 225398
225392	8953	“ “ “ “ Rod with 208E and 225393, for 225398.....
225393	8910	Thread Unwinder Thread Guide Rod Washer for 225392.....
225395	8953	Thread Unwinder Spool Rest (for two spools) with 201018c, for 225398.....
225398	8953	Thread Unwinder complete, for four spools, Nos. 201696j, 202490, 225388, 225392, two 225395, four 225391 and three wood screws $\frac{7}{8}$ in. No. 12.....

**ILLUSTRATIONS OF PARTS
FOR
MACHINES
Nos. 147-29 and 147-38**

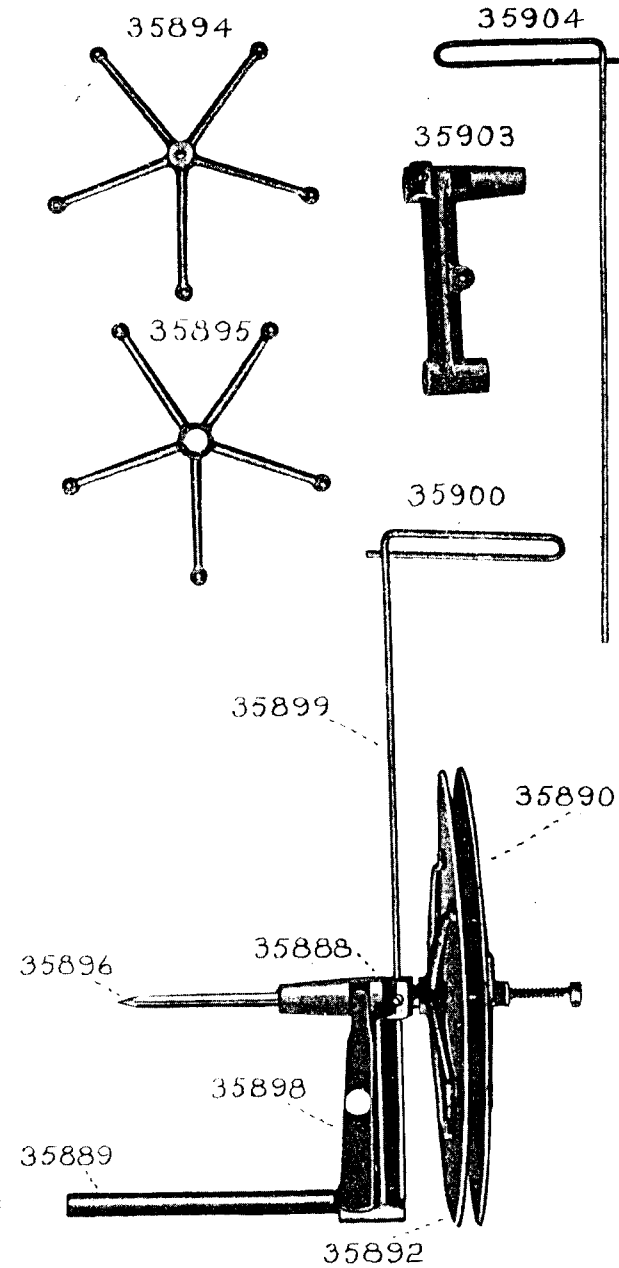

PLATE 8901—FULL SIZE

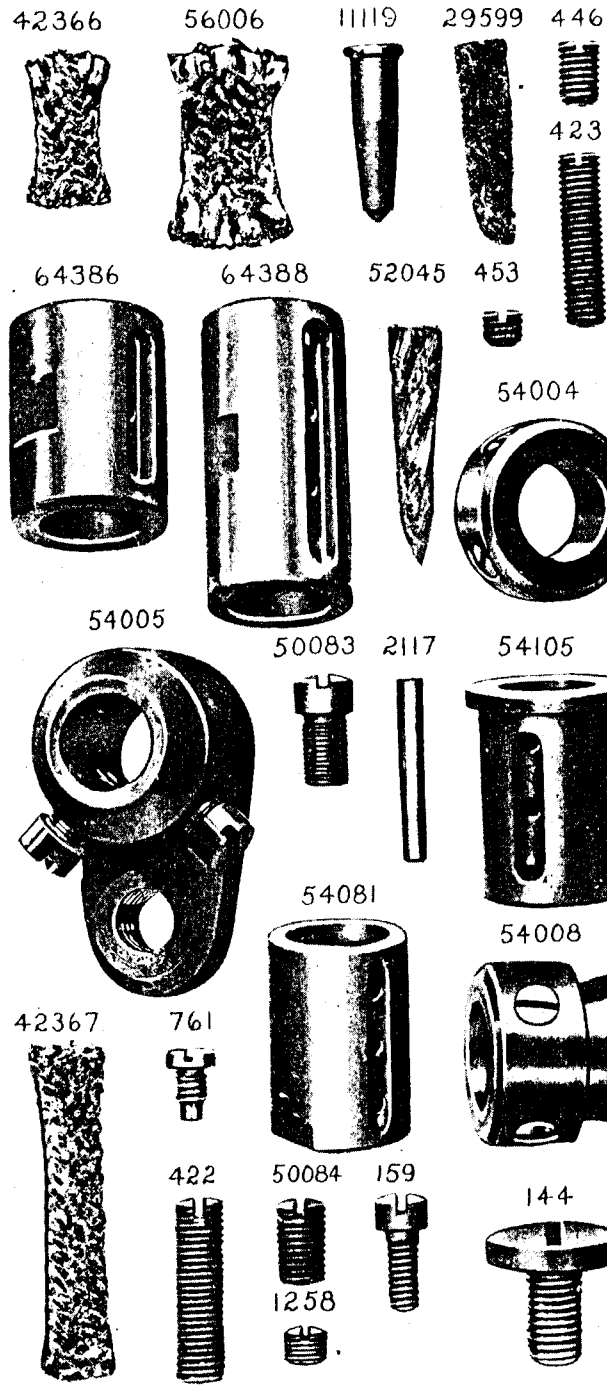

PLATE 8902—ONE-HALF SIZE

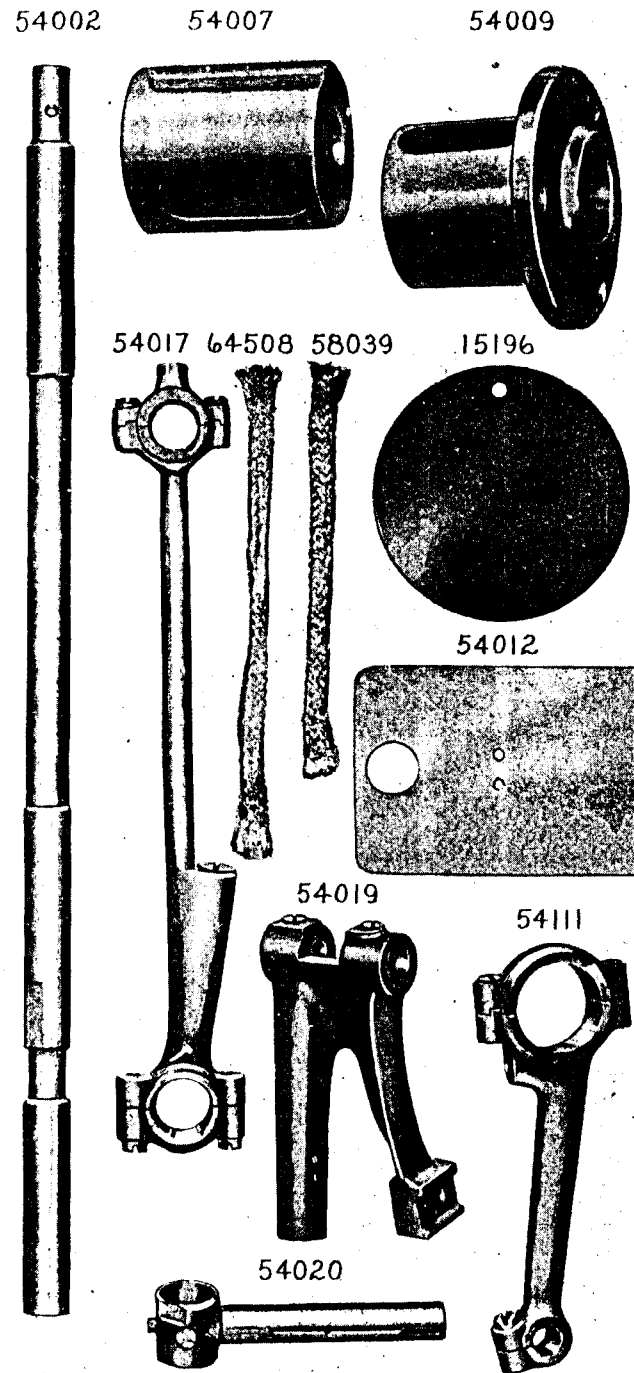

PLATE 8904—FULL SIZE

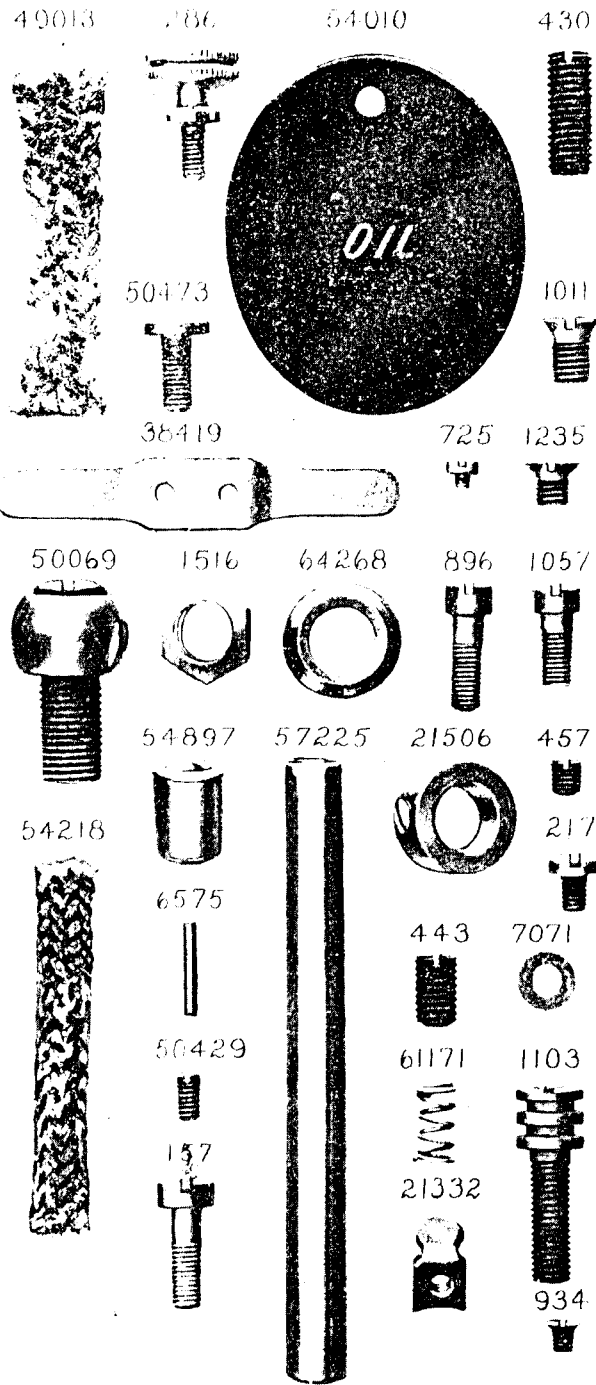

PLATE 8908—FULL SIZE

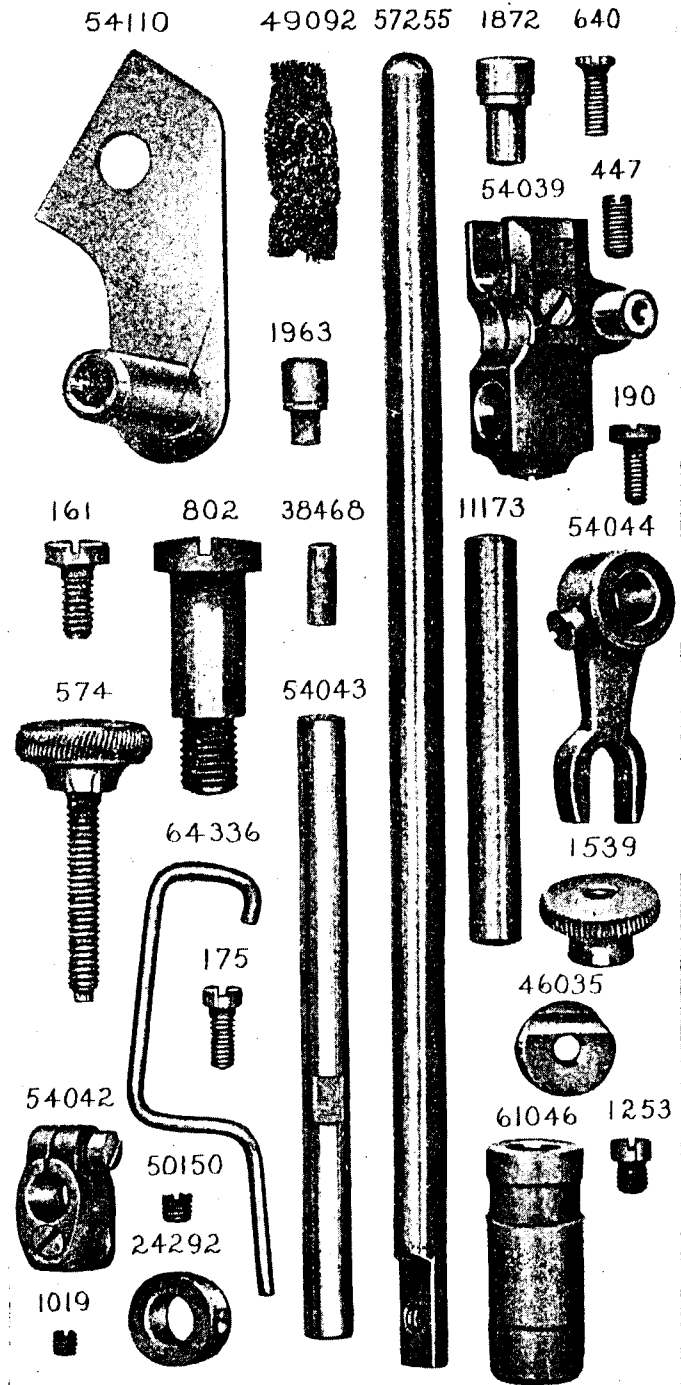

PLATE 8909—FULL SIZE

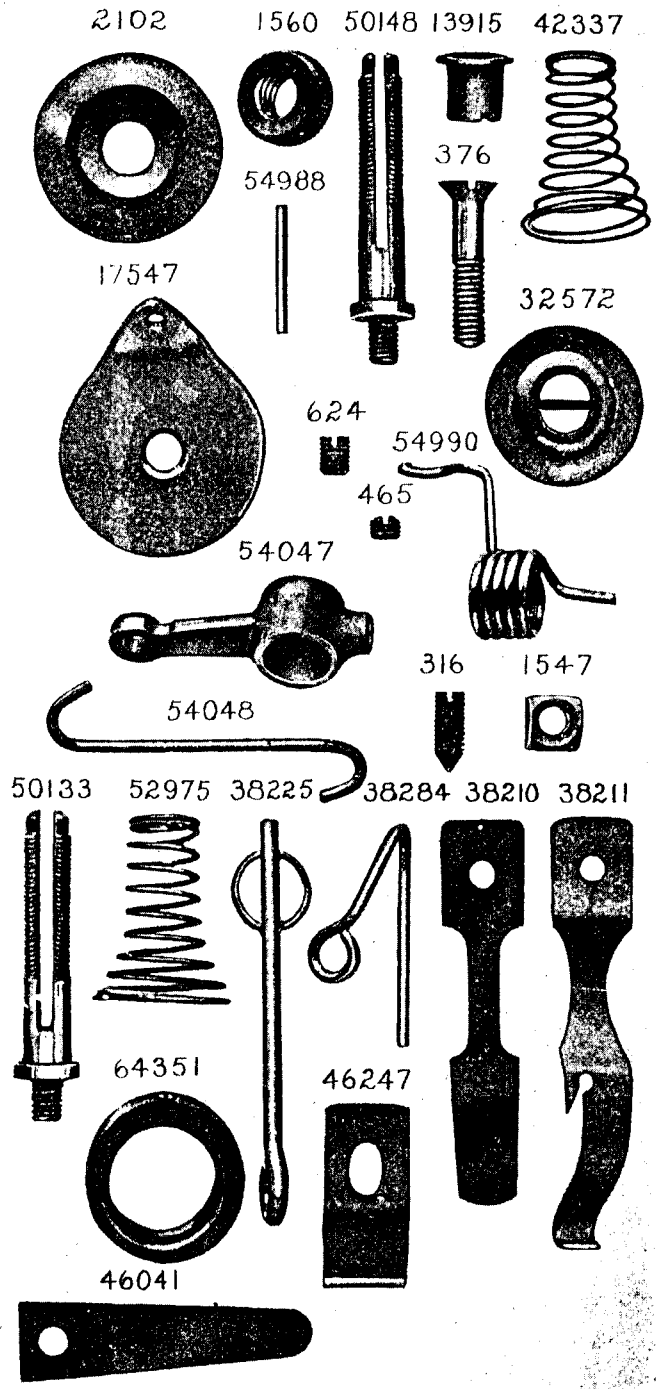

PLATE 8910—FULL SIZE

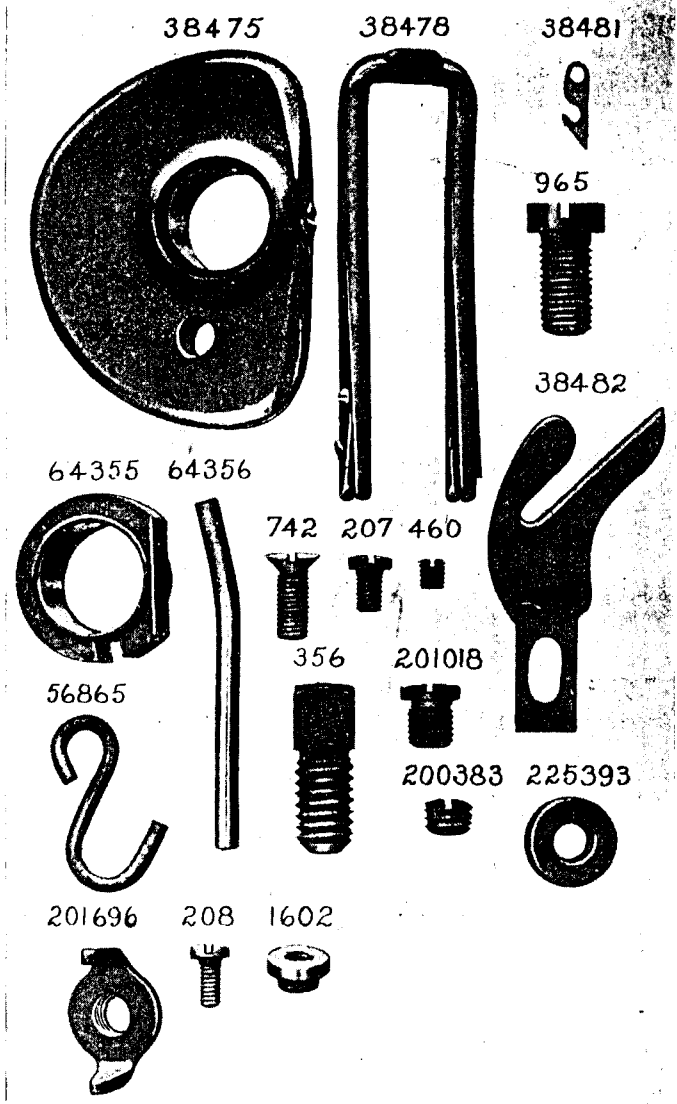

PLATE 8911—FULL SIZE

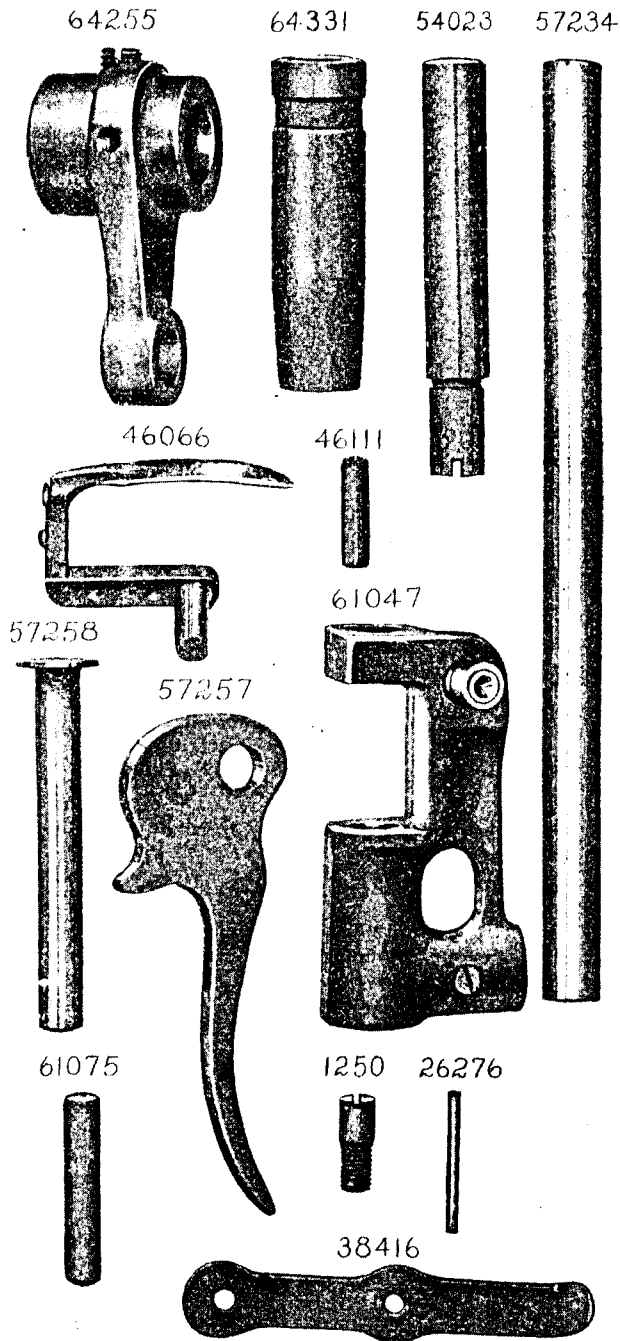

PLATE 8913—ONE-HALF SIZE

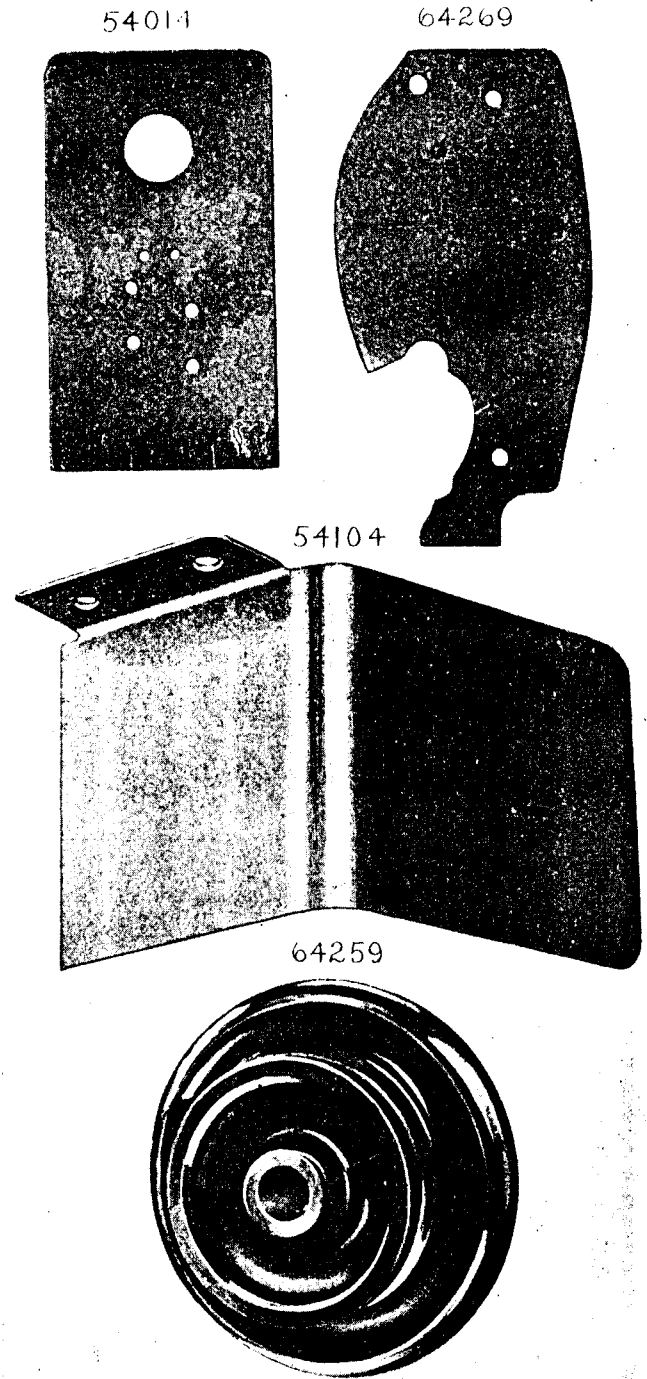

PLATE 8922—FULL SIZE

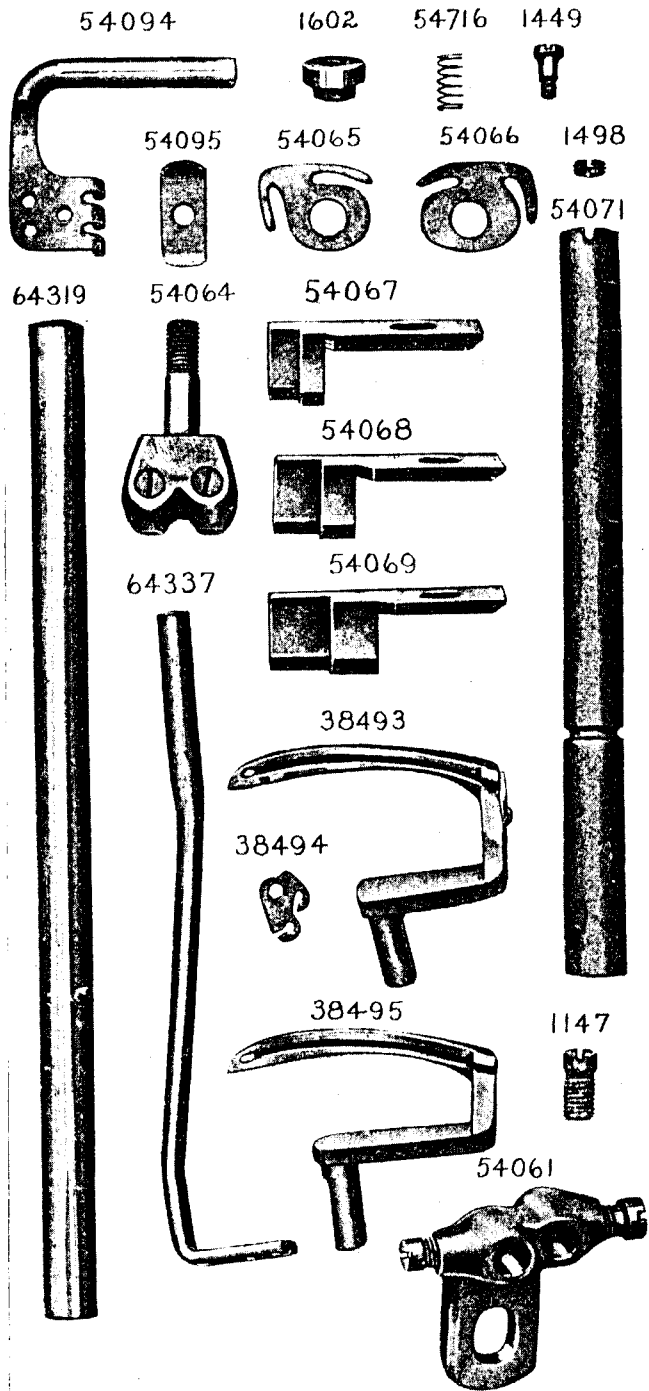

PLATE 8941—ONE-HALF SIZE

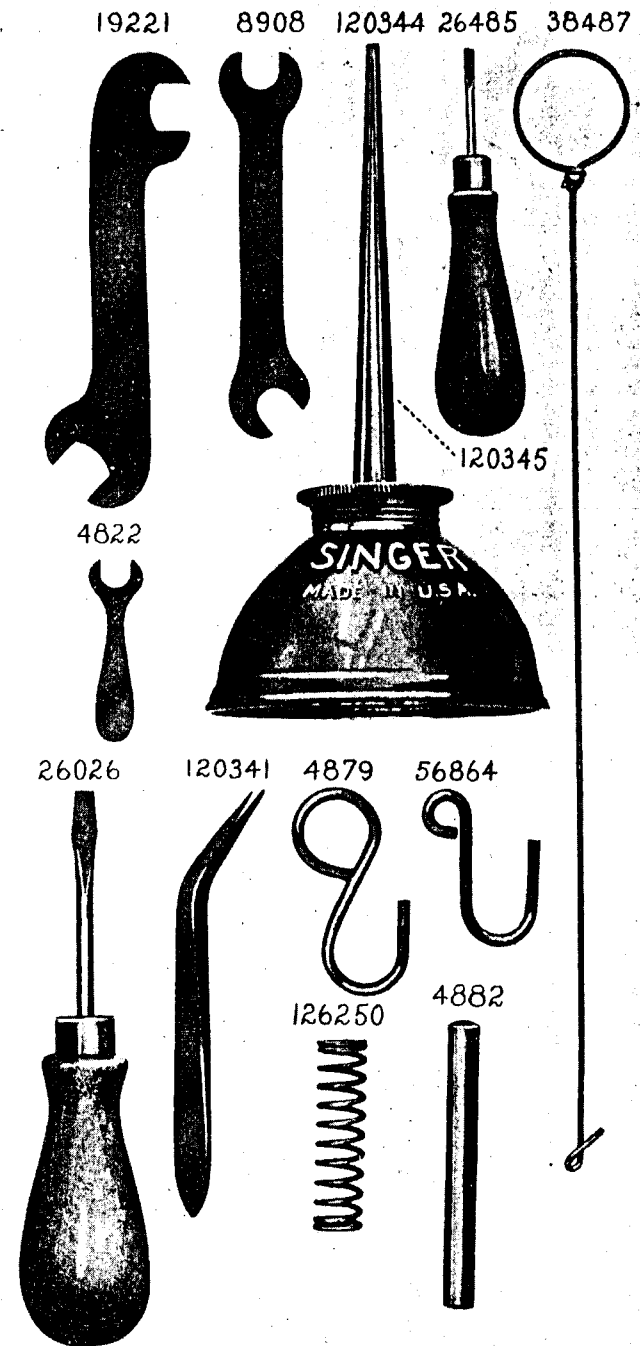

PLATE 8949—FULL SIZE

120354



120387



120351



120362



120361



120407

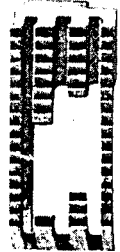

PLATE 8950—FULL SIZE

120386



120383



54097



54099



54100

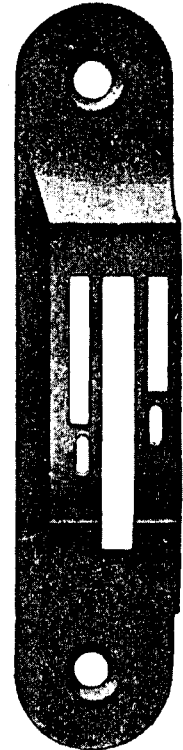

54098



54114



PLATE 8951—FULL SIZE

120353



120385



120406



54121

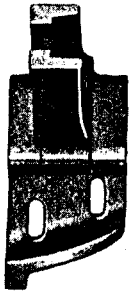

54118



54102

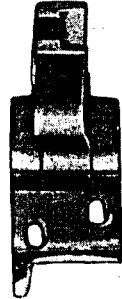

PLATE 8953—ONE-SIXTH SIZE

225398



225391

225391

225392

225395

225395

225388

202490

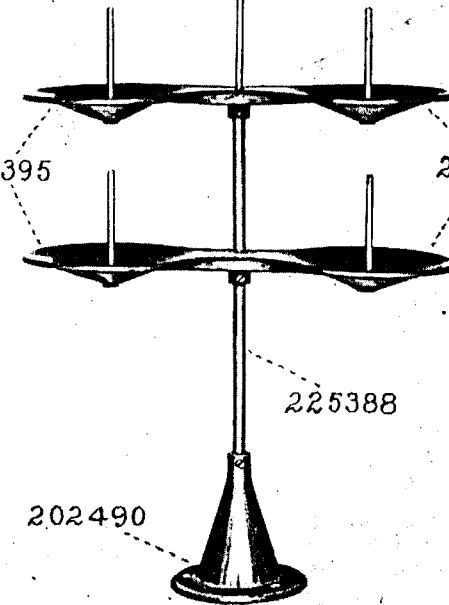

PLATE 8958—FULL SIZE

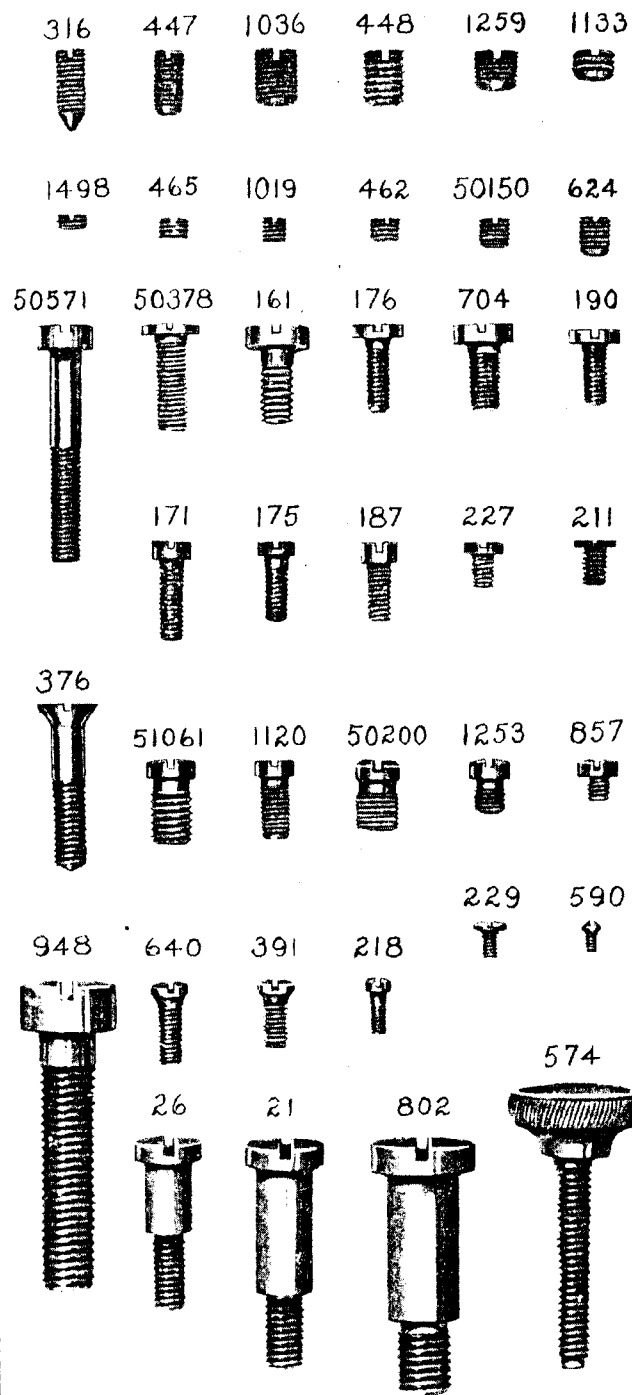

PLATE 8960—FULL SIZE

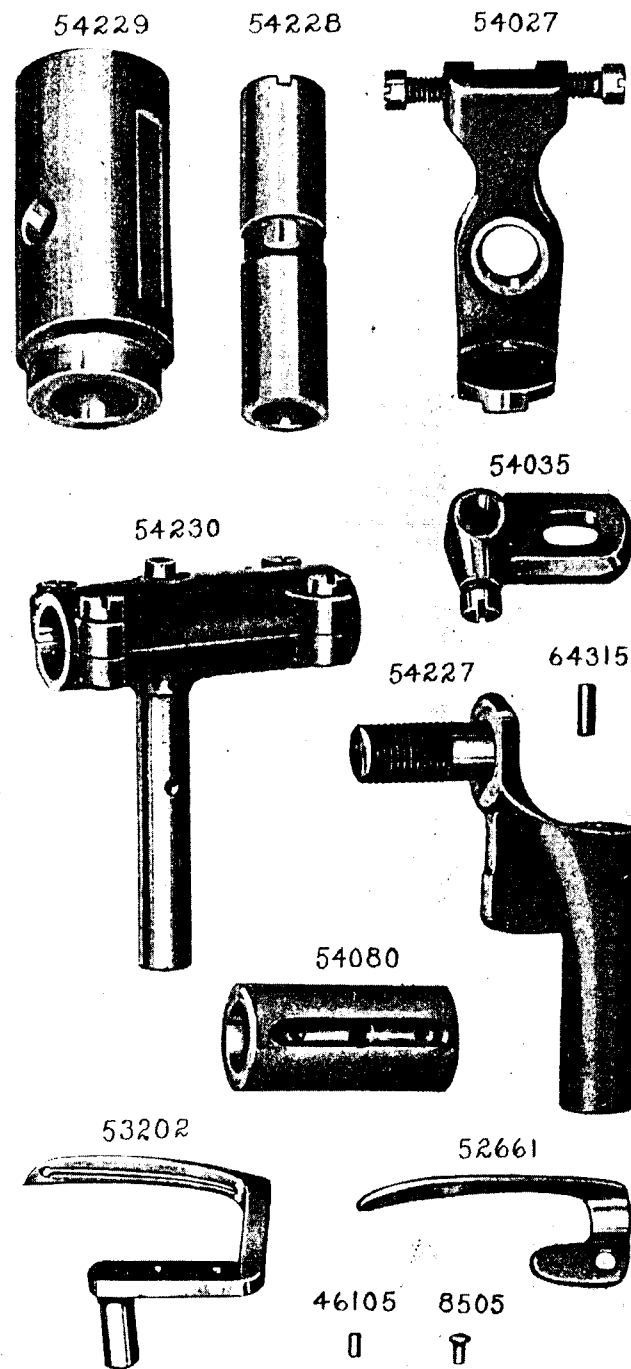

PLATE 8991—FULL SIZE

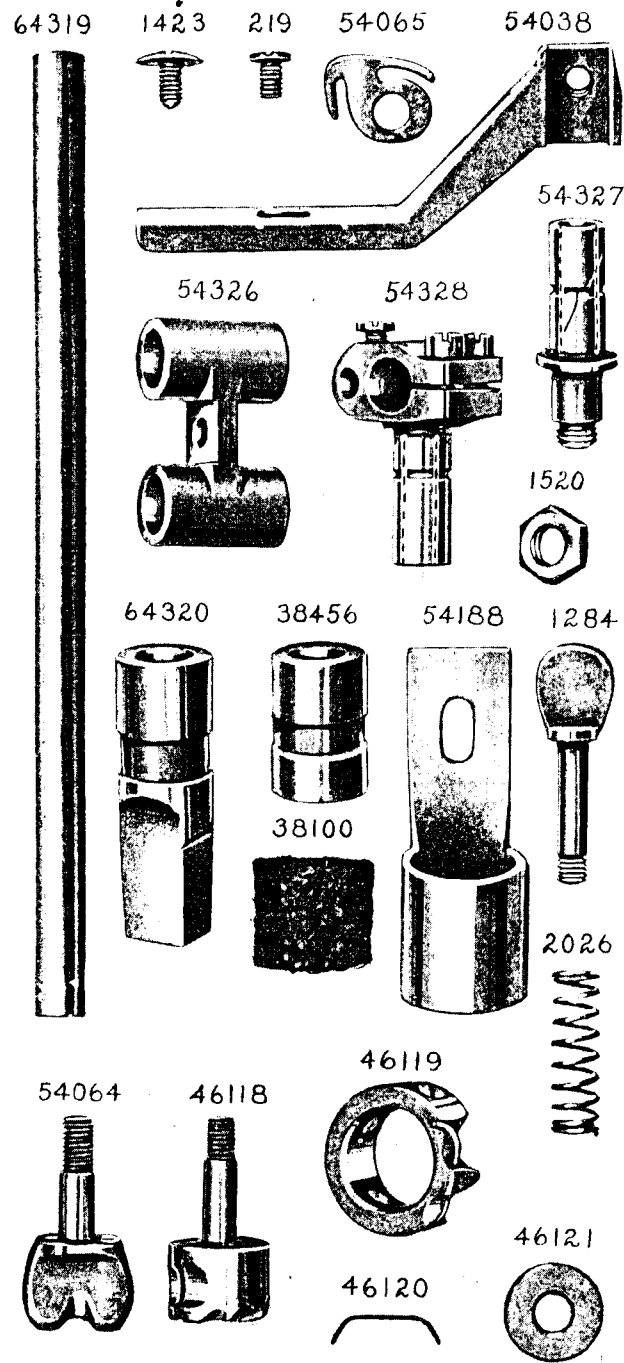

PLATE 8996—ONE-HALF SIZE

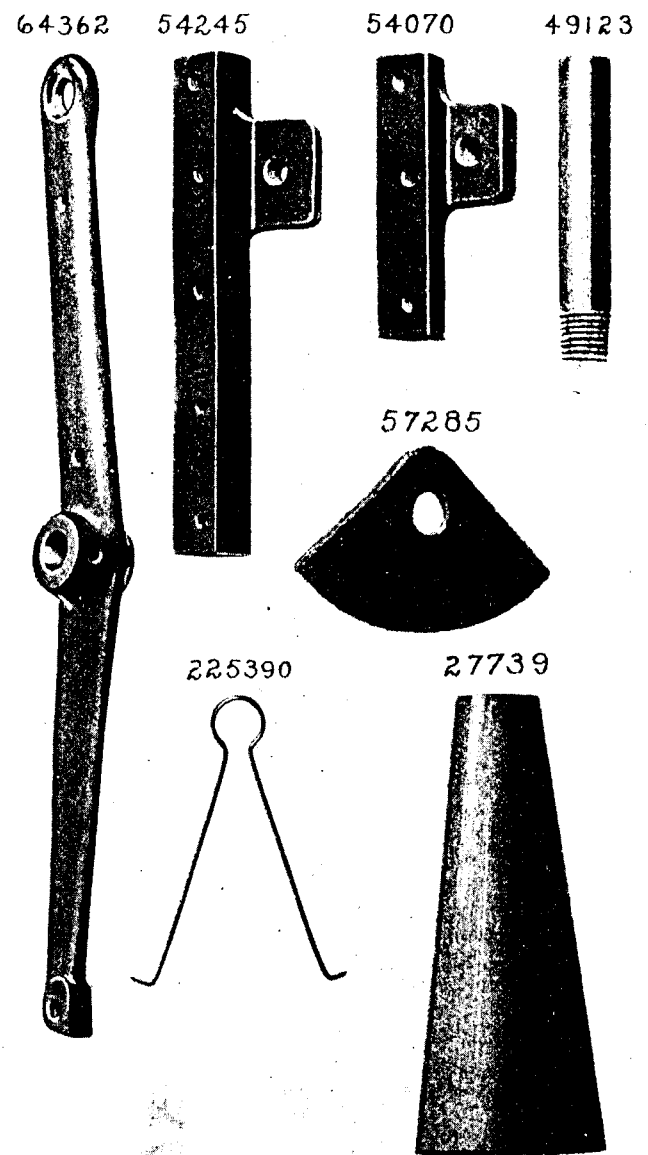
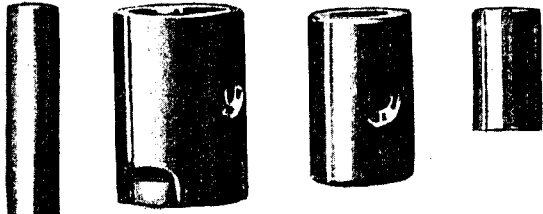
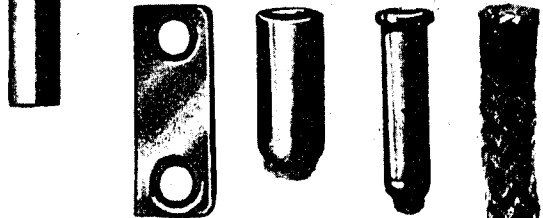

PLATE 9000—FULL SIZE

127542 54367 57235 68151



127530 54309 56003 64805



127536

54450

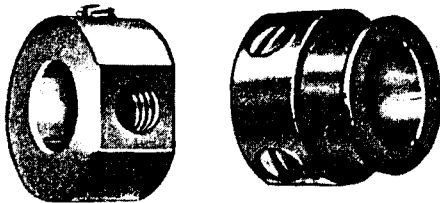

28012

23404

62562

1876

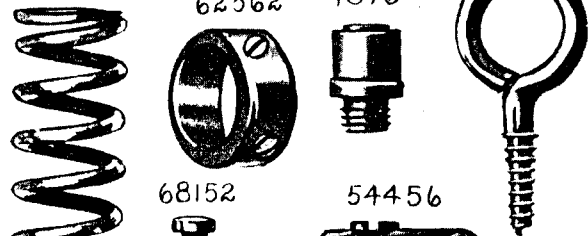

68152

54456

68153

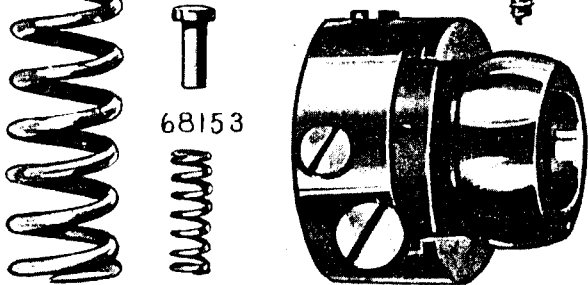
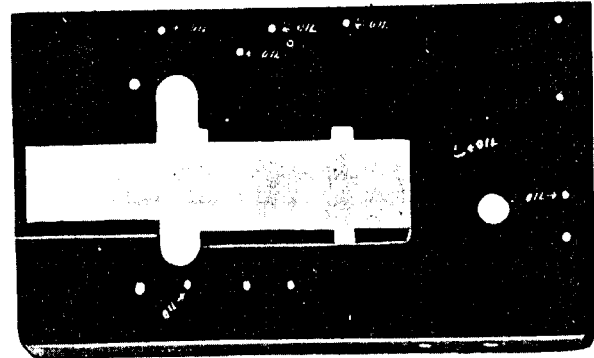
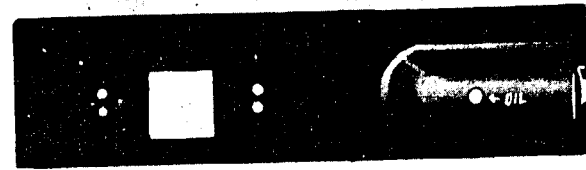

PLATE 9850—ONE-FOURTH SIZE

68142



68145



127521 68154 68110 54006 68118

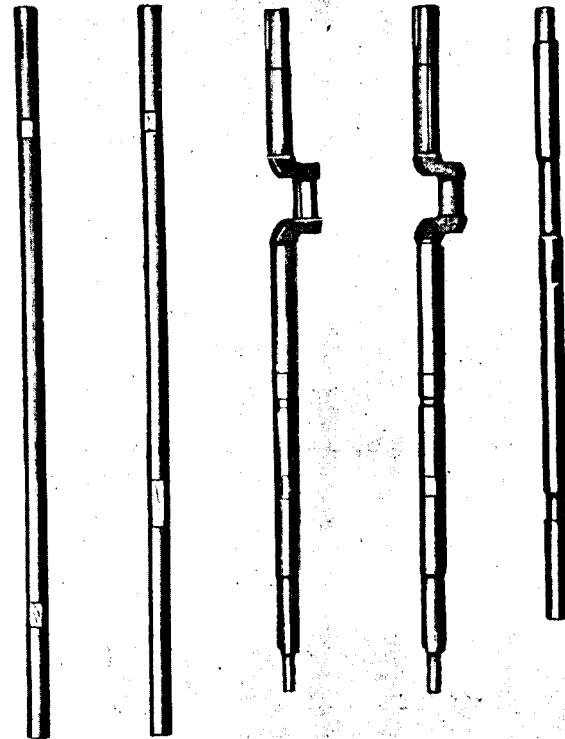
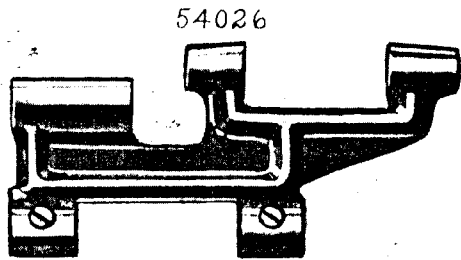
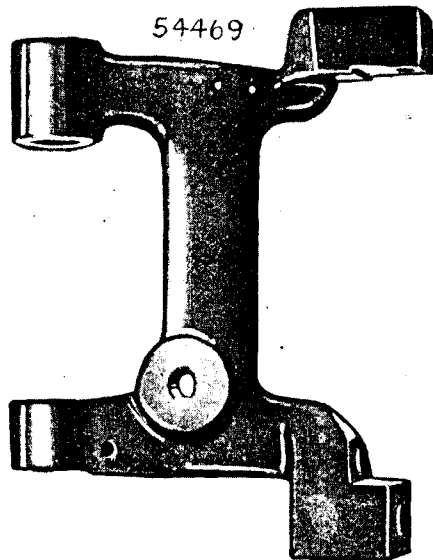

PLATE 9851—ONE-HALF SIZE



127534



68092

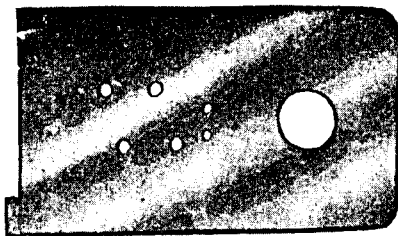

35897

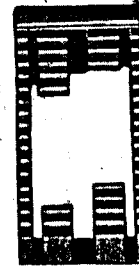

PLATE 9852—FULL SIZE

46090



46081



68198



68194

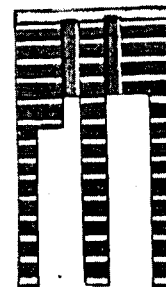

PLATE 9853—FULL SIZE

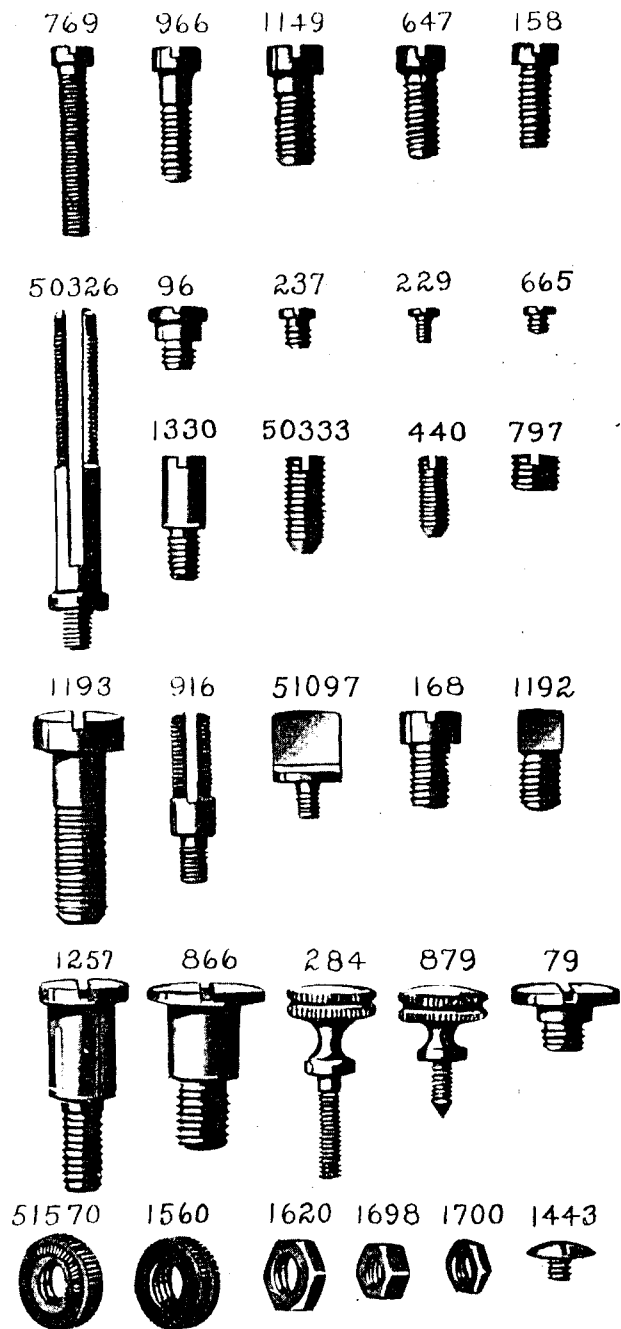

PLATE 9854—ONE-HALF SIZE

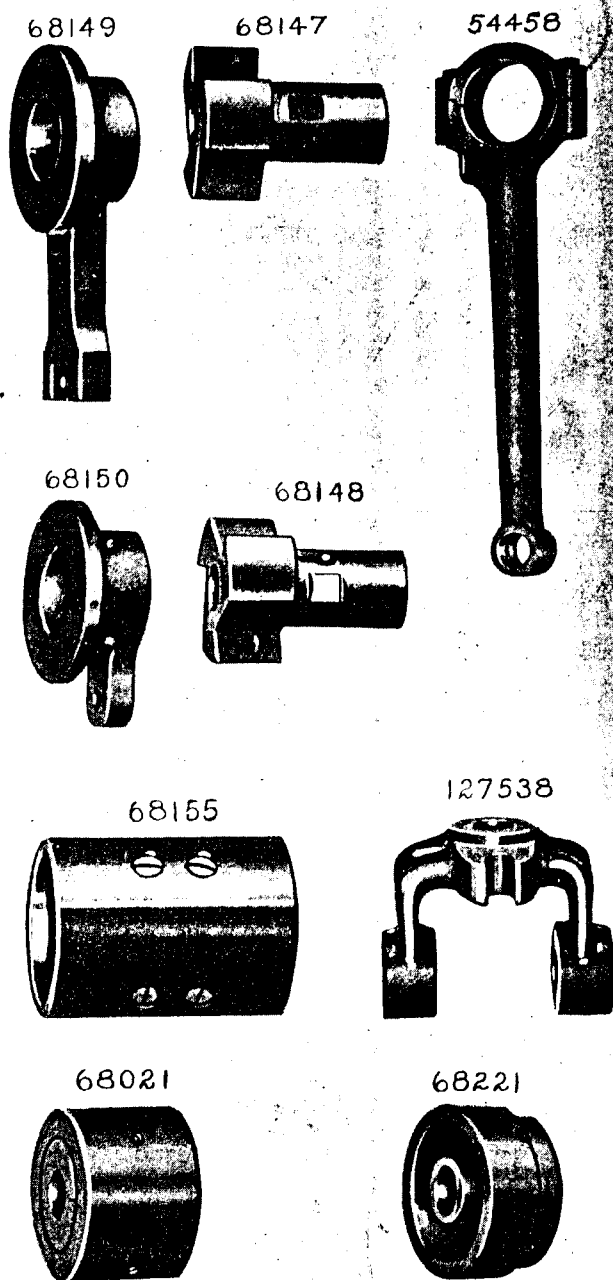
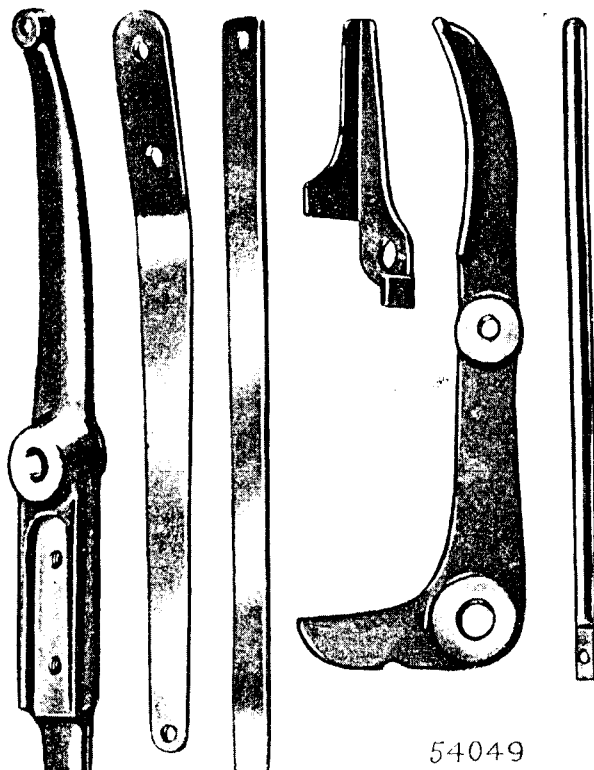
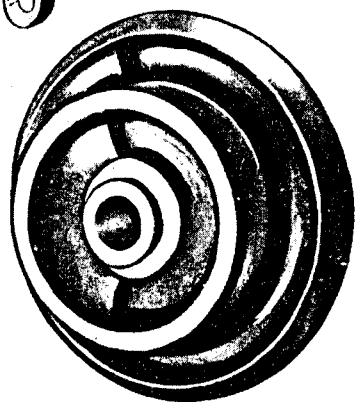

PLATE 9855—ONE-HALF SIZE

68208 68184 54040 54472 54471 64330



54210



54049

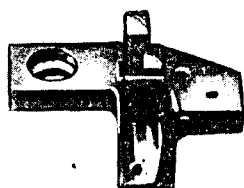

60656

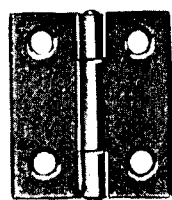
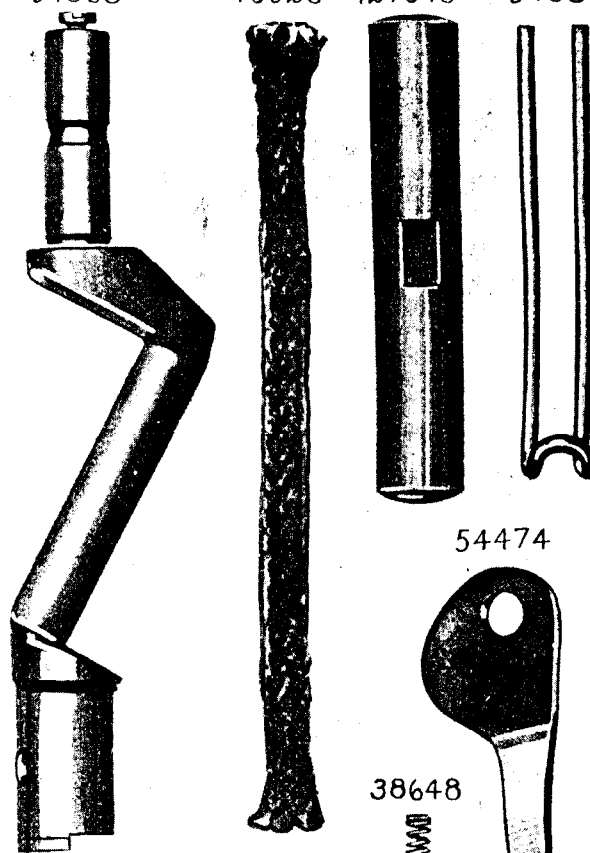
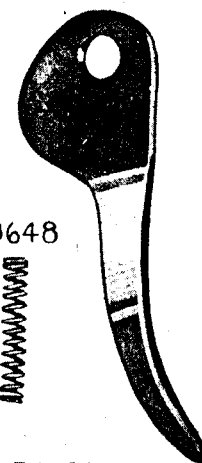

PLATE 9856—FULL SIZE

54368 40326 127546 54381



54474



38648



54107

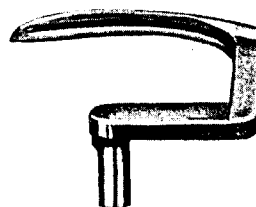

54106

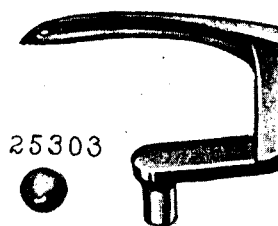

54473

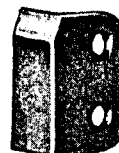

54242



25303



PLATE 9857—FULL SIZE

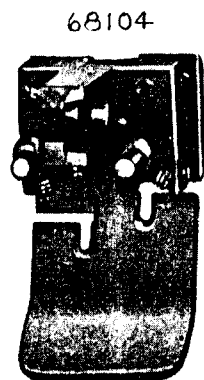
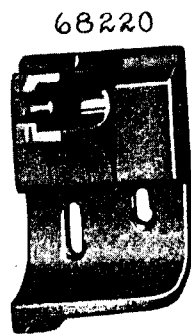
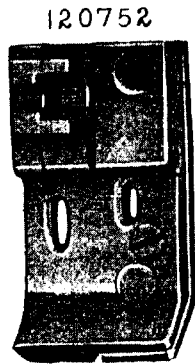
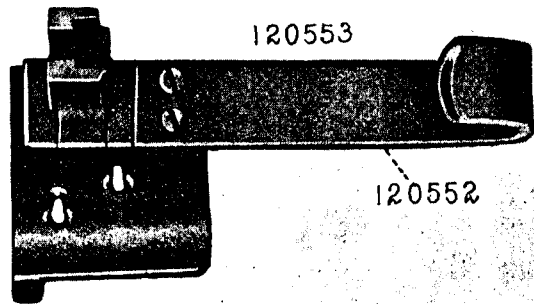

18055 68097 24701 68100 68099

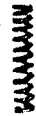

68098 853



PLATE 9858—FULL SIZE

59534



59535



59537



59538 68164



68199

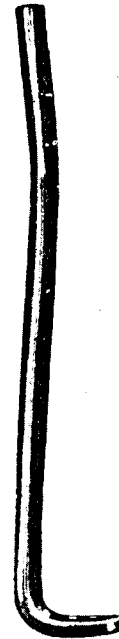

54435



57076

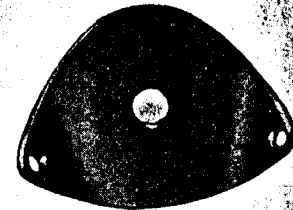

54330

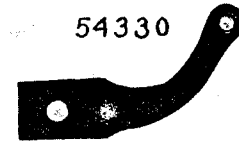

68197



46009



53225



68128

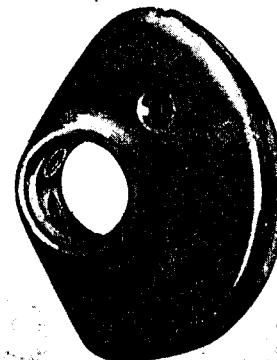

54072



PLATE 9859—ONE-FOURTH SIZE

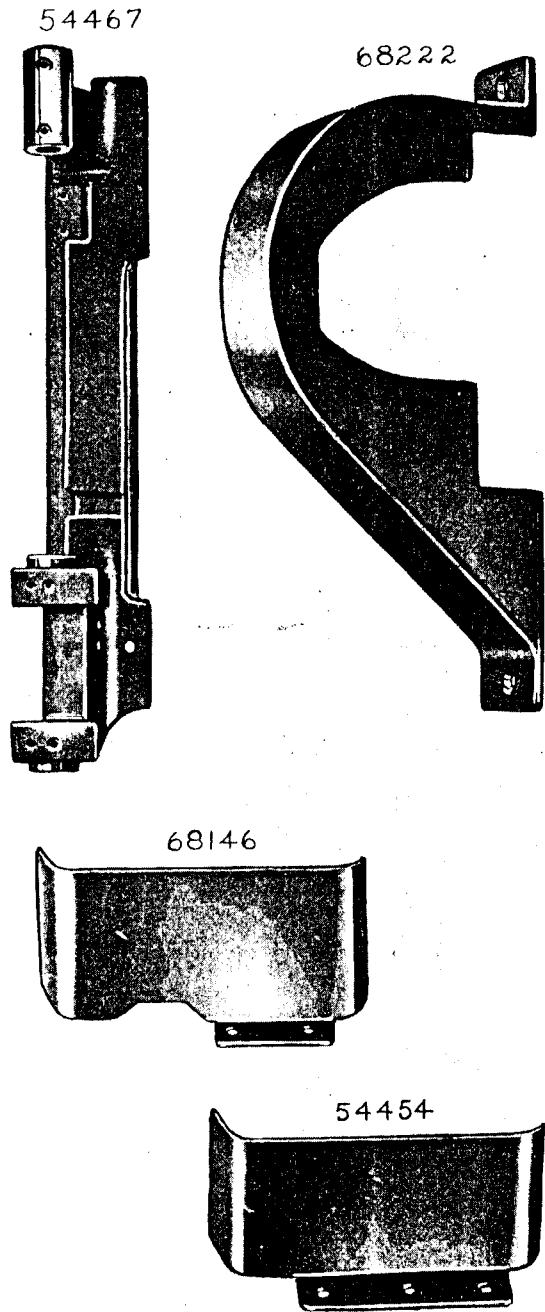

PLATE 9860—FULL SIZE

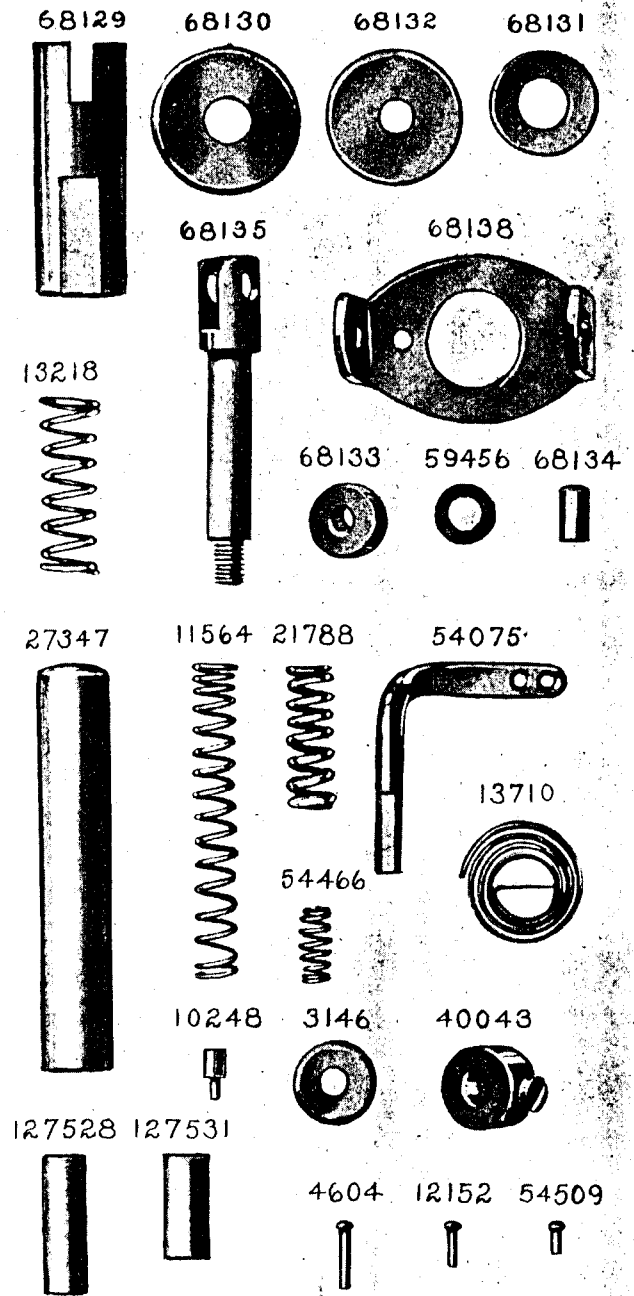

PLATE 9861—ONE-FOURTH SIZE

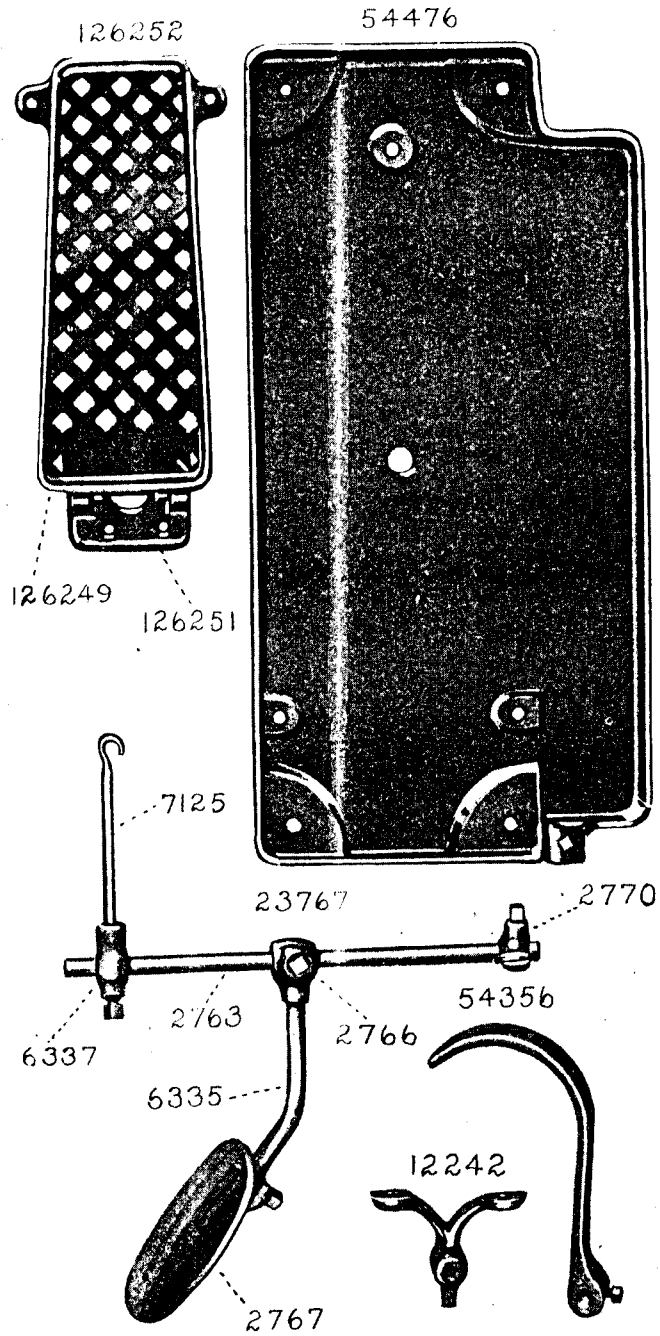

PLATE 9862—FULL SIZE

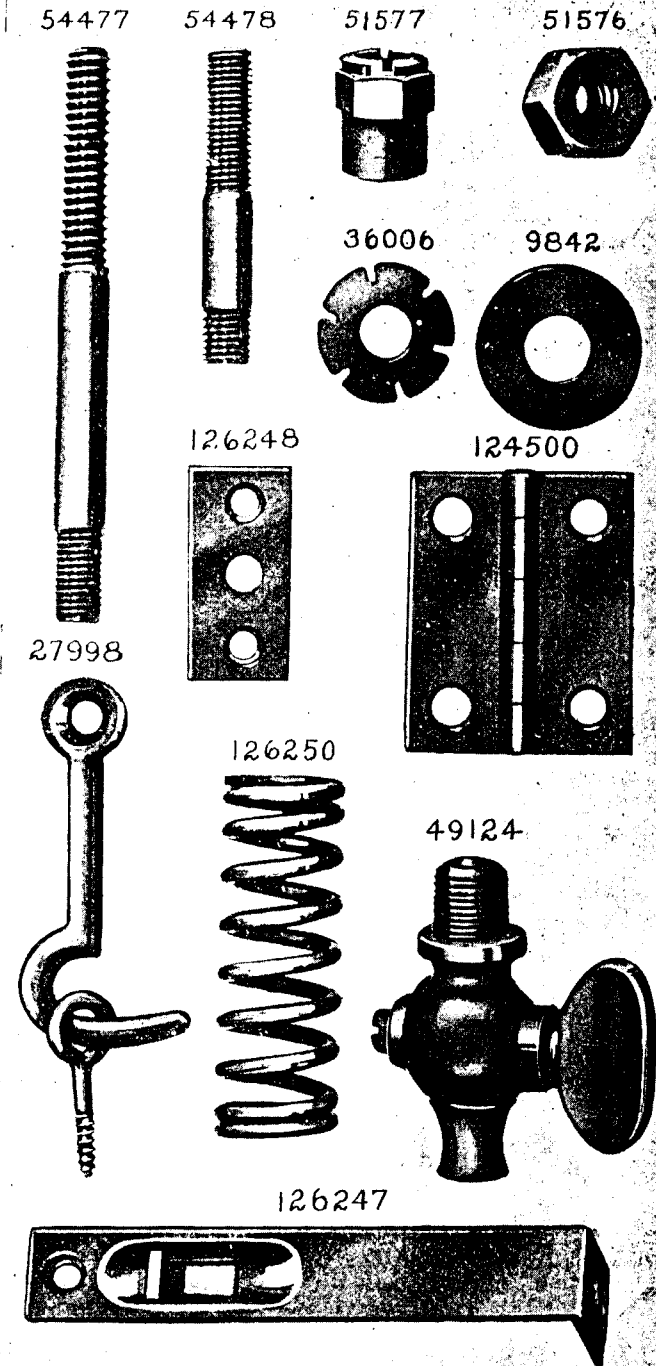
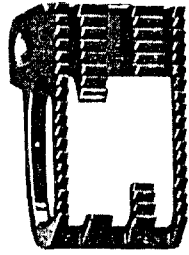

PLATE 9863—FULL SIZE

120561



46062



68201

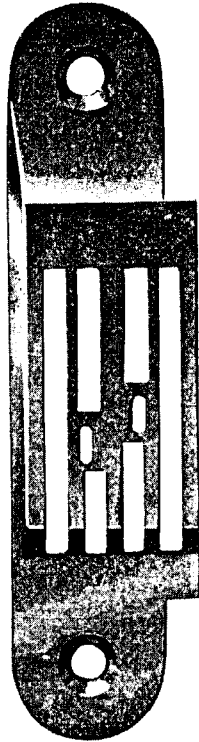

68200

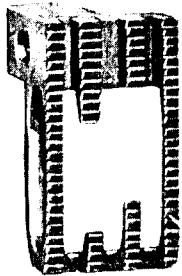
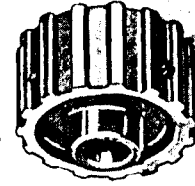
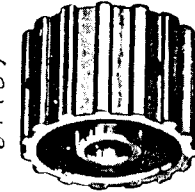

PLATE 9864—ONE-HALF SIZE

54481



54457



120560

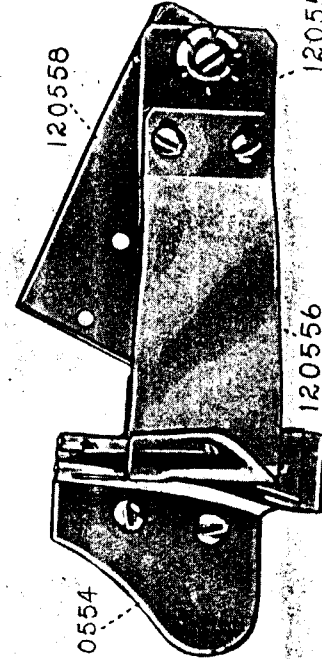

120558

120557

120556

120554

120629

68059

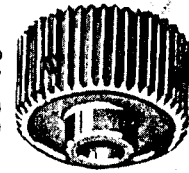

120632

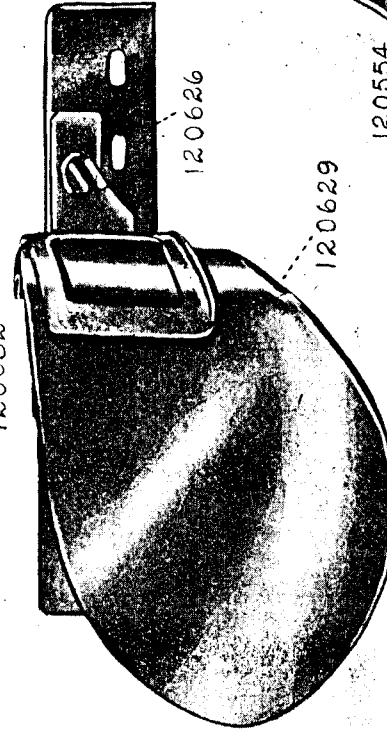

120626

68058

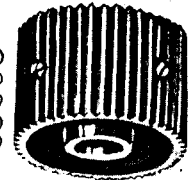
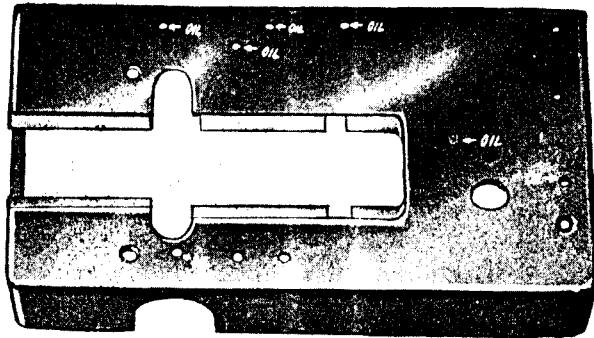
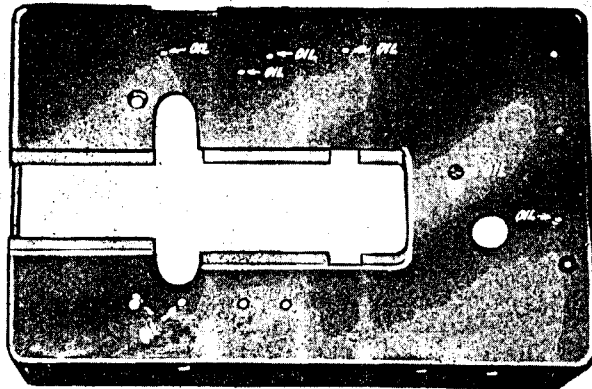

PLATE 9865—ONE-FOURTH SIZE

68209



54451



54452

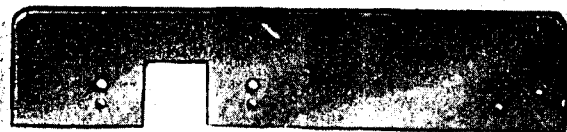
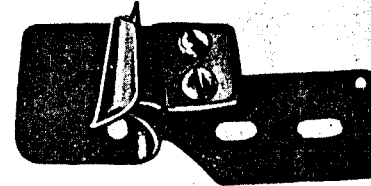
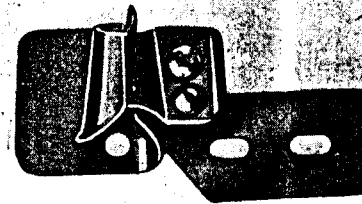

PLATE 9866—ONE-HALF SIZE

120524



120709



120743

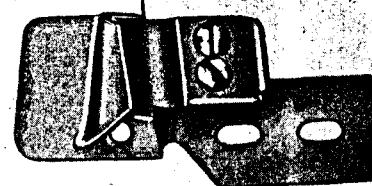

120748

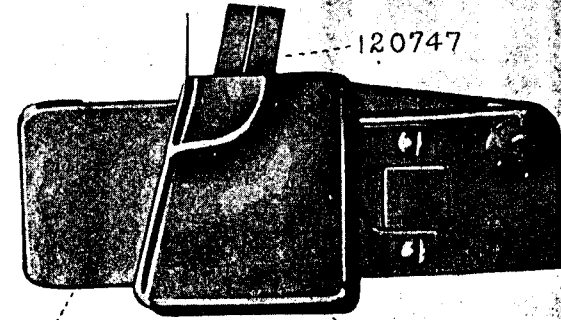

120745

120747

120744

PLATE 9867—ONE-FOURTH SIZE

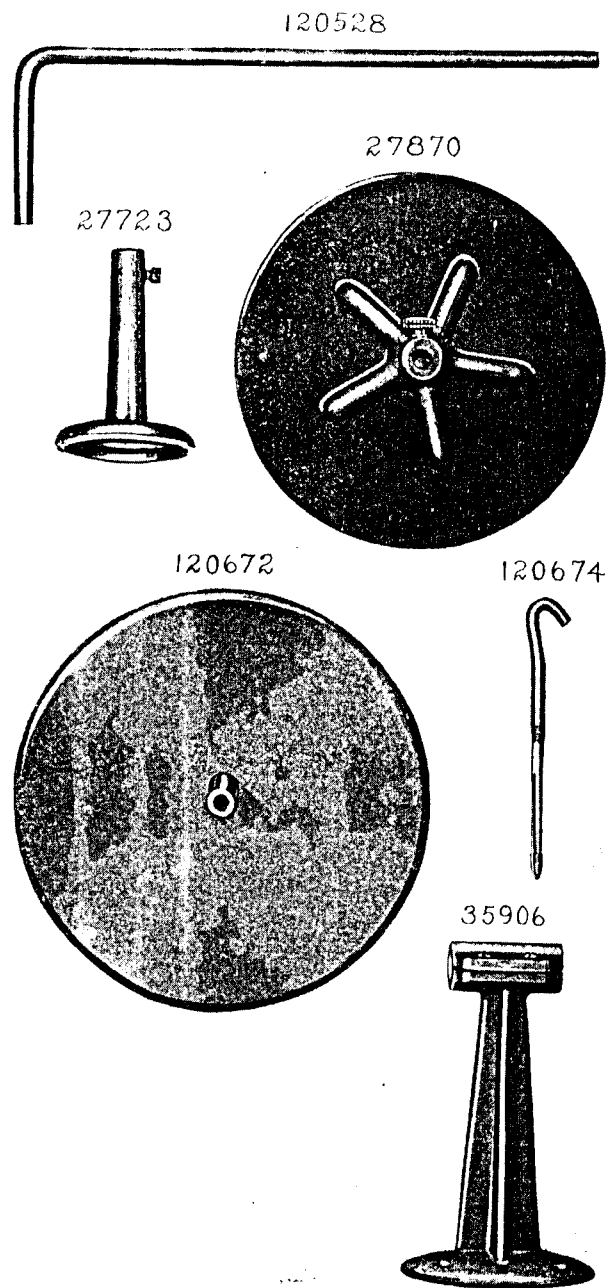

PLATE 9868—ONE-HALF SIZE

