

# LIST OF PARTS



**MACHINE No. 96-18**

---

\*\* A TRADE MARK OF  
**THE SINGER MANUFACTURING COMPANY**

# INSTRUCTIONS FOR OILING

---

To ensure easy running and prevent unnecessary wear of the parts which are in movable contact, the machine requires oiling and when in continuous use, "TYPE B" or "TYPE D" OIL, sold only by Singer Sewing Machine Company, should be applied at least twice each day to all oil holes marked "OIL".

"TYPE D" OIL is stainless.

**CAUTION:** Never oil the sewing hook race through the needle hole in the throat plate. Never flood the hook with oil.

## INDEX

	PAGE
ACCESSORIES .....	15
BOBBIN WINDER NO. 41348 .....	16
"      "      "   41916 .....	15
"      "      "   225382 .....	17
FOOT LIFTER PARTS .....	18
IRON BASE .....	15
KNEE LIFTER PARTS .....	19
KNIFE GRINDER .....	20
MACHINE NO. 96-18 .....	7
NUMERICAL LIST OF PARTS .....	23

# INSTRUCTIONS FOR ORDERING

In ordering from this list, use **ONLY** the part NUMBER in the **FIRST** column.

The number stamped on a Sewing Machine part is in every case the number of the single part only.

Every combination of parts sent out as such has its specific number, which, although not stamped on the parts, must be used when ordering the combination.

Each number always indicates the **SAME PART** in whatever list it appears, or for whatever machine.

The letters after some of the numbers indicate the style of finish only, as follows:

- A. Hardened, Polished and Plated.
- B. Polished and Plated.
- C. Hardened only.
- D. Polished only.
- E. Soft, not Polished.
- F. Hardened and Polished
- G.
- H. Blued.
- J. Plated only.
- K. Hardened and Plated.
- L. Brass or Gilt.
- M. Oxidized
- P. Japanned.
- R. Merlized
- T. Copper-plated.

These letters **MUST BE USED** *when* they appear in the list, and **AFTER** the number *as* in the list.

In this series:

- 1 to 1500 and 50001 to 51500 are Screw Numbers.
- 1501 to 1800 are Nut Numbers.
- 1801 to 2000 are Roller Numbers.
- 2001 to 50000 and 52001 and upward are numbers of Machine Parts.

The figures in the second column refer only to the plates, illustrating the parts, and are **NOT TO BE USED** in ordering.

Parts marked with an asterisk (\*) are furnished only when repairs are made at factory.

## LIST OF PARTS COMPLETE FOR

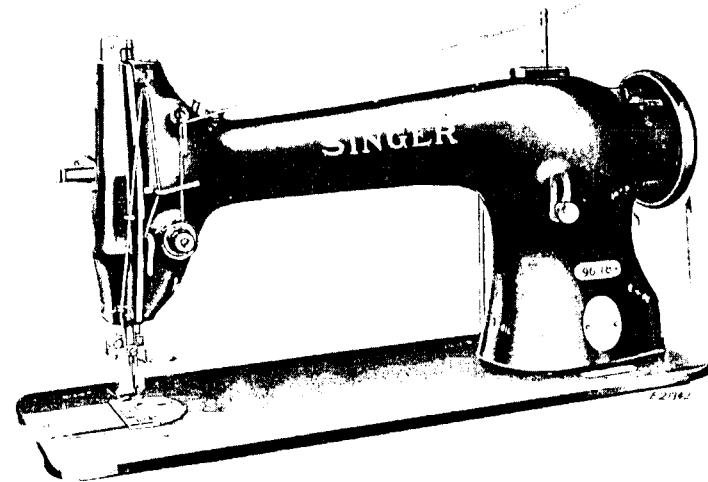

### MACHINE No. 96-18

**FOR LIGHT, MEDIUM AND HEAVY CLOTHING AND OTHER WORK IN CLOTH. ROTATING HOOK, DRIVEN BY GEARS. DROP FEED. VERTICAL TRIMMER THAT TRIMS FROM  $\frac{1}{8}$  TO  $\frac{1}{4}$  INCH FROM THE LINE OF STITCHING. THE MACHINE IS FITTED WITH A  $\frac{1}{8}$  INCH CUTTING BAR, UNLESS OTHERWISE ORDERED, AND AN EXTRA  $\frac{3}{8}$  INCH CUTTING BAR AND PRESSER FOOT ARE FURNISHED WITH THE MACHINE. WHEN A DIFFERENT WIDTH IS ORDERED, THE EXTRA CUTTING BAR WILL BE ONE SIZE LARGER, EXCEPT WHEN  $\frac{1}{4}$  INCH IS REQUIRED. SPEED 3200.**

NO.	PLATE	NAME
*127023	--	Arm with two 56015.....
16532	5900	" Dowel Pin.....
24131	5900	" Oil Tube with 29599, for oiling 24036
52120	7712	" " " " " " " " 24040
18130	5900	" " " " " " " " 52022
12454	5900	" " " " " " " " 52024
24131	5900	" " " " " " " " 12430,
		for 52043.....
29599	5900	Arm Oil Tube Packing (felt).....
	116E	5875 " Screw (back).....
	854E	7713 " " (front).....
127024	7714	" Shaft (horizontal).....

NO.	PLATE	NAME
52059	5907	Arm Shaft (horizontal) Flanged Bushing (back).....
56006	5900	Arm Shaft (horizontal) Flanged Bushing (back) Oil Pad (braided cotton).....
448c	5875	Arm Shaft (horizontal) Flanged Bushing (back) Set Screw.....
52078	5907	Arm Shaft (horizontal) Flanged Bushing (front).....
56006	5900	Arm Shaft (horizontal) Flanged Bushing (front) Oil Pad (braided cotton).....
435c	7713	Arm Shaft (horizontal) Flanged Bushing (front) Set Screw.....
54897	5900	Arm Shaft (horizontal) Front Bearing Oil Cup.....
52060	5898	Arm Shaft (horizontal) Gear with two 1036c.....
52071	5907	Arm Shaft (horizontal) Gear Case (two pieces) with 121E and 50234E.....
50234E	7713	Arm Shaft (horizontal) Gear-Case Plug Screw.....
121E	7713	Arm Shaft (horizontal) Gear Case Screw
1036c	5911	" " " " Set Screw..
144d	5875	" " " " Screw.....
52062	5898	" " (upright).....
56099	5898	" " " Bushing (lower)....
432c	5898	" " " " " Set Screw.....
56100	5898	Arm Shaft (upright) Bushing (upper)....
1149c	5875	" " " " " Set Screw.....
56013	5898	Arm Shaft (upright) Gear (lower) with two 1253c.....
1253c	7713	Arm Shaft (upright) Gear (lower) Set Screw.....
56101	5898	Arm Shaft (upright) Gear (upper) with two 1253c.....
1253c	7713	Arm Shaft (upright) Gear (upper) Set Screw.....
56015	5900	Arm Shaft (upright) Oil Tube (lower)....
56015	5900	" " " " " (upper)....
12193	5907	" Side Cover.....
50053D	7713	" " " Thumb Screw.....
12403	5900	" Spool Pin and Thread Eyelet.....
8879	5936	" " " Washer (cloth).....
52042	5896	" Top Cover.....
52043	5896	" " " 52042 with 12403 and 24131.....

NO.	PLATE	NAME
180D	5875	Arm Top Cover Screw.....
52005	5893	Balance Wheel (power) light rim, 2 $\frac{1}{8}$ in. pulley, with two 448c.....
52081	5893	Balance Wheel (stand) heavy rim, 2 $\frac{1}{8}$ in. pulley, with two 448c.....
52063	5907	Balance Wheel Oil Cover.....
210D	5875	" " " " Screw.....
448c	5875	" " Set Screw.....
*52383	-----	Bed.....
12431	-----	" Slide.....
12432	5907	Bed Slide complete, Nos. 4307, 12431 and two 725J.....
4307	5907	Bed Slide Spring.....
725J	5875	" " " Screw.....
52102	-----	Face Plate.....
52103	5907	Face Plate complete, Nos. 52053, 52102, 56086 and two 226D.....
190D	5875	Face Plate Screw.....
52053	5900	" " Thread Guard (lower).....
226D	5900	" " " " " Screw..
56086	5900	" " " " (upper).....
226D	5900	" " " " " Screw..
50190D	7713	" " Thumb Screw.....
52452	5896	Feed Bar.....
313C	5875	" " Screw Centre.....
1519J	7713	" " " " Nut.....
3033	5897	" Connecting Link.....
375c	5897	" " " Hinge Screw.....
1518E	5897	" " " " " Nut..
52073	5897	" " " " " Stud.....
50083c	5897	" " " " " Set Screw.....
127025	7715	Feed Dog.....
50117E	5913	" " Screw.....
20283	5947	" and Feed Lifting Eccentric with 446c.....
446c	7713	Feed and Feed Lifting Eccentric Set Screw.....
24036	5896	Feed and Feed Lifting Eccentric Sleeve..
20284	5947	" Forked Connection.....
375c	5897	" " " Hinge Screw....
1518E	5897	" " " " " Nut
52384	7714	" Lifting Rock Shaft.....
52385	-----	Feed Lifting Rock Shaft complete, Nos. 12376 and 52384.....
12430	5896	Feed Lifting Rock Shaft Connecting Rod (steel) with 12204 and two 966E.....

NO.	PLATE	NAME
*12204	—	Feed Lifting Rock Shaft Connecting Rod Cap.....
966E	7713	Feed Lifting Rock Shaft Connecting Rod Cap Screw.....
375c	5897	Feed Lifting Rock Shaft Connecting Rod Hinge Screw.....
1518E	5897	Feed Lifting Rock Shaft Connecting Rod Hinge Screw Nut.....
12376	5897	Feed Lifting Rock Shaft Crank with 157J and 1813.....
157J	5897	Feed Lifting Rock Shaft Crank Clamping Screw.....
1813	5897	Feed Lifting Rock Shaft Crank Roller and Stud.....
50191c	7713	Feed Lifting Rock Shaft Screw Centre.....
1513j	7713	" " " " " " Nut.....
52074	5897	" Regulator with 50083c.....
1128E	5897	" " Hinge Screw.....
818d	5897	" " Thumb Screw.....
52359	7712	" " " " Stop.....
52386	7714	" Rock Shaft.....
52387	—	Feed Rock Shaft complete, Nos. 29633 and 52386.....
29633	5897	Feed Rock Shaft Crank with 157J.....
157J	5897	" " " " Clamping Screw.....
50191c	7713	" " " Screw Centre.....
1513j	7713	" " " " " Nut.....
127026	7712	Knife (narrow).....
127027	7712	" (wide).....
620c	5913	" Adjusting Screw.....
52104	7716	" Bar with 2301.....
24431	7716	" " Crank with 191c.....
1162c	5913	" " " Coupling Pin.....
1564d	5913	" " " " " Head.....
2297	5913	" " " " " Spring.....
2022	5913	" " " Pin.....
191c	7713	" " " Set Screw.....
24432	—	Knife Bar Crank complete, Nos. 1162c, 1564d, 2297 and 24431.....
127028	7716	Knife Bar Driving Crank (forked).....
16564	7716	" " " " Bracket.....
127029	—	Knife Bar Driving Crank Bracket complete, Nos. 2022, 16564, 24432 and 127028.....
647c	7713	Knife Bar Driving Crank Bracket Screw.....
24122	5913	" " Lifting Spring.....
24123	5913	" " " " Case.....

NO.	PLATE	NAME
24124	5913	Knife Bar Lifting Spring Guide.....
*24906	—	" " " " " " 24124 with 2523 and 24125.....
24125	5913	Knife Bar Lifting Spring Guide Bracket
621d	5913	" " " " " " " Screw.....
2523	5913	Knife Bar Lifting Spring Guide Pin.....
2301	5913	" " Stop Pin.....
52107	—	Knife Bar complete, Nos. 621d, 24109, 24906, 52104, 52108 and three 50117E
52108	5913	Knife Holder with 620c, 2291 and two 223d.....
24109	5913	Knife Holder Handle.....
50117E	5913	" " " Screw.....
50117E	5913	" " Screw.....
223d	5913	" Screw.....
2291	5913	" " Washer.....
127030	7716	Needle Bar (hollow) with 1072F.....
52110	5911	" " Bushing (lower) with 52114..
1133E	5911	" " " " Set Screw ..
52111	5911	" " " (upper).....
1133E	5911	" " " " Set Screw...
24040	5911	" " Connecting Link with 794E...
24894	—	" " " " 24010 with 24041.....
794E	5911	Needle Bar Connecting Link Adjusting Screw.....
775E	5911	Needle Bar Connecting Link Cap Screw..
24041	5911	" " " Stud with 207E..
207E	5911	" " " " Clamping Screw.....
127031	7716	Needle Bar Crank (eccentric) with 858c, 1036c, 1037c and 1065c.....
127032	7712	Needle Bar Crank (eccentric) Sleeve.....
1065c	5875	" " " Position Screw.....
858c	5875	" " " Set Screw.....
52114	5911	" " Oil Cup.....
1072F	5911	" Set Screw.....
12391	5896	Presser Bar (hollow).....
52338	5936	" " Guide Bracket with 223c and 453c.....
453c	5936	Presser Bar Guide Bracket Set Screw....
52016	5936	" " Lifter.....
689c	5936	" " " Screw.....
1520E	5936	" " " " Nut.....
12327	5936	" " Lifting and Releasing Lever Bracket.....

NO.	PLATE	NAME
11167	5896	Presser Bar Spring.....
11170	5936	" " " Washer.....
127033	7715	" Foot, for $\frac{1}{8}$ in. to $\frac{1}{4}$ in. gauges
127034	7715	" " " $\frac{1}{8}$ in. gauge and above
NOTE: No. 127033, $\frac{1}{8}$ in. gauge, and No. 127034, $\frac{1}{4}$ in. gauge, are sent with this machine unless other gauges are specified on order.		
190D	5875	Presser Foot Screw.....
50373J	7713	Pressure Regulating Thumb Screw.....
52121	—	Rotating Hook.....
52123	—	" " 52121 with 52090 and four 1053D.....
52089	5898	Rotating Hook 52123 with 40274 and three each 1253C and 1367D.....
52478	—	Rotating Hook 52089 with 52474.....
40264	7717	" " Bobbin.....
52472	—	" " " Case.....
52481	—	" " " " 52472 with 591E, 1380D and 40394.....
40392	7717	Rotating Hook Bobbin Case Latch.....
40409	7717	" " " " " Lever
2974	7717	" " " " " " "
		Fulcrum Pin.....
2975	7717	Rotating Hook Bobbin Case Latch Spring
592E	7717	" " " " " Stop Screw.....
40393	—	Rotating Hook Bobbin Case Hinge, Nos. 2974, 40392 and 40409.....
591E	7717	Rotating Hook Bobbin Case Tension Regulating Screw.....
40394	7717	Rotating Hook Bobbin Case Tension Spring.....
1380D	7717	Rotating Hook Bobbin Case Tension Spring Screw.....
52473	7717	Rotating Hook Bobbin Case complete, Nos. 592E, 2975, 40393 and 52481.....
52474	—	Rotating Hook Bobbin Case 52473 with 52477.....
52477	7717	Rotating Hook Bobbin Case Holder with 52475 and two 52476.....
52018	7717	Rotating Hook Bobbin Case Holder Posi- tion Bracket.....
704J	7717	Rotating Hook Bobbin Case Holder Posi- tion Bracket Screw.....
*52475	—	Rotating Hook Bobbin Case Locating Plate.....

NO.	PLATE	NAME
*52476	—	Rotating Hook Bobbin Case Locating Plate Rivet.....
40274	7717	Rotating Hook Section.....
1367D	7717	" " " Screw.....
1253C	7713	" " Set Screw.....
52388	7714	" " Shaft.....
56106	5898	" " " Bushing (back)....
52045	5898	" " " " " Pack- ing (cotton).....
1143C	7713	Rotating Hook Shaft Bushing (back) Set Screw.....
56107	5898	Rotating Hook Shaft Bushing (front)....
52045	5898	" " " " " Pack- ing (cotton).....
1148C	5898	Rotating Hook Shaft Bushing (front) Set Screw.....
56013	5898	Rotating Hook Shaft Gear with two 1253C.....
52072	5907	Rotating Hook Shaft Gear Case (two pieces) with 121E and 50234E.....
50234E	7713	Rotating Hook Shaft Gear Case Plug Screw.....
121E	7713	Rotating Hook Shaft Gear Case Screw...
1253C	7713	" " " " Set Screw....
52090	5898	" " Thread Guard.....
1053D	7713	" " " " Screw.....
52337	5936	Slack Thread Regulator.....
223C	5936	" " " Set Screw.....
2102	5913	Tension Disc.....
1560C	7713	" Regulating Thumb Nut.....
32572	5913	" Releasing Disc.....
43944	5936	" " Lever.....
12398	5936	" " " Hinge Pin.....
12329	5936	" " " Spring.....
32574	5913	" " Pin.....
2103	7717	" Spring.....
50304C	7717	" Stud.....
50305C	7717	" " Set Screw.....
52397	—	Tension complete, Nos. 1560C, 2103, 32572, 32574, 50304C, 52083, 52394 and two 2102.....
52027	5911	Thread Guard (side of arm).....
52454	5900	" Retainer.....
460C	7713	" " Set Screw.....
52054	—	Thread Take-up complete, Nos. 11204, 52025 and 52143.....
52021	5911	Thread Take-up Crank.....

NO.	PLATE	NAME
52143	-----	Thread Take-up Crank 52021 with 775E and 24894.....
1037c	5911	Thread Take-up Crank Position Screw.....
1036c	5911	" " " " Set Screw.....
52022	5911	" " " " Lever with 52130.....
52023	5911	" " " " Hinge Pin.....
52024	5911	" " " " Link.....
11204	5911	" " " " " Hinge Pin.....
435c	7713	" " " " " " " " Set Screw.....
52130	7717	Thread Take-up Lever Thread Eyelet Bushing.....
52025	-----	Thread Take-up Lever complete, Nos. 52022 to 52024.....
52394	7717	Thread Take-up Spring.....
52083	7717	" " " " Regulator with 50305c.....
448c	5875	Thread Take-up Spring Regulator Set Screw.....
5729	-----	Throat Plate Body.....
5730	7715	" " " " Cutting Bar for 127036.....
NOTE: No. 5730, $\frac{3}{8}$ in. gauge, is sent with this machine, unless another gauge is specified on order.		
52131	7715	Throat Plate Cutting Bar for 127040.....
NOTE: When ordering 5730 or 52131, state required distance of trimmed edge from seam.		
578d	7713	Throat Plate Cutting Bar Screw.....
127035	7715	" " " " Slide.....
578d	7713	" " " " Adjusting Screw.....
127036	7715	Throat Plate (small needle hole) complete for 127025, Nos. 5729, 5730, 127035 and three 578d.....
NOTE: No. 127036, $\frac{1}{8}$ in. gauge, is sent with this machine, unless another gauge is specified on order.		
127040	7715	Throat Plate (large needle hole) complete for 127025, Nos. 5729, 52131, 127035 and three 578d.....
NOTE: When ordering 127036 or 127040, state required distance of trimmed edge from seam.		
691F	5875	Throat Plate Screw.....
44212	7711	Drip Pan with four 1 in. wire nails.....

## IRON BASE

NO.	PLATE	NAME
19219	5943	Bed Frame Cushion (leather).....
158c	5943	" " " " Screw.....
19220	5943	" " " " Spring.....
19226	5943	" " " " Hinge Connection.....
19398	-----	" " " " " 19226 with 211E and 19397.....
19397	5943	Bed Frame Hinge Connection Cap.....
211E	5943	" " " " " " Screw.....
16555	5943	" " " " Plate.....
14010	5943	" " " " Rivet.....
20067	819	Bed Frame with two each 16555, 19398, four each 19219, 19220, six each 14010, wood screws $\frac{1}{4}$ in. No. 12 and eight 158c.....

## ACCESSORIES

NO.	PLATE	NAME
12361	5943	Machine Hinge Connection.....
44139	5943	" " " " Plate.....
44140	-----	Machine Hinge complete, Nos. 12361, 44139 and merlized wood screw $\frac{1}{4}$ in. No. 14.....
12405	5943	Machine Rest (felt).....
28084	-----	" " " " Pin.....
120342	5901	Oiler (copper plated) with 120343.....
120343	5901	" Spout, $3\frac{1}{2}$ in. long.....
26026	5901	Screw Driver (large).....
26485	5901	" " (small).....
8909	5901	Wrench for 1513 and 1518.....
8908	5901	" " 1519 and 1520.....

## BOBBIN WINDER

(SWINGING AUTOMATIC, LEFT HAND)

NO.	PLATE	NAME
41913	5902	Bracket with 457c.....
41583	5902	Frame with 457c.....
34105	5902	" Hinge Pin.....
457c	7713	" " " " Set Screw.....
41914	5902	" Spring.....
41585	5902	Pulley with 171d.....
171d	7713	" Set Screw.....

NO.	PLATE	NAME
41586	5902	Spindle.....
41587	5902	Stop Latch.....
42614	5902	" " Hinge Stud.....
457C	7713	" " " " Set Screw.....
7958	5913	" " Stop Pin.....
41588	5902	" " Tripping Arm with 185H.....
185H	7713	" " " " Clamping Screw.....
41591	5902	Tension Bracket with 460C.....
41592	5902	Tension Bracket complete, Nos. 12403, 24131, 41591, 41593 to 41595 and two 2455.....
24131	5900	Tension Bracket Oil Tube with 29599.....
29599	5900	" " " " Packing (felt)
180D	5875	" " Screw.....
12403	5900	" " Spool Pin.....
8879	5936	" " " " Washer (cloth)
2455	2834	" Disc.....
41593	5936	" Spring.....
41594	5936	" Stud.....
460C	7713	" " Set Screw.....
41595	5936	" Thread Guide.....
60845	----	Bobbin Winder, Nos. 7958, 34105, 41583, 41585 to 41588, 41913, 41914 and 42614
41915	5902	Bobbin Winder 60845 with 880E and 25446.....
41916	----	Bobbin Winder (swinging automatic, left hand) complete, Nos. 41592 and 41915
880E	7713	Bobbin Winder Screw.....
25446	5900	" " " Washer.....

## BOBBIN WINDER

(SWINGING AUTOMATIC, RIGHT HAND)

NO.	PLATE	NAME
41339	2833	Base.....
41340	2833	Frame.....
1429D	2834	" Hinge Screw.....
41341	2833	" Spring.....
207D	2834	" " Screw.....
41342	2833	Pulley with 200F.....
200F	2834	" Set Screw.....
41343	2834	Spindle.....
27306	2834	Spool Pin.....
27307	2833	" Stand.....

NO.	PLATE	NAME
27308	2833	Spool Stand complete, Nos. 418E, 1562J, 2106, 10141, 11241, 27306, 27307, two each 2455 and wood screws 1 in. No. 10.....
11241	2833	Spool Washer (cloth).....
41344	2834	Stop Latch.....
41345	2834	" " Finger.....
152F	2834	" " " Screw.....
1430D	2834	" " Hinge Screw.....
1550J	2834	" " " Nut.....
41346	2834	" " Lever.....
1430D	2834	" " " Hinge Screw.....
2455	2834	Tension Disc.....
1562J	2834	" Regulating Thumb Nut.....
418E	2834	" Screw Stud.....
10141	2834	" Spring.....
2106	2834	" Thread Guide.....
60456	---	Bobbin Winder, Nos. 152F, 207D, 1429D, 1550J, 41339 to 41346 and three 1430D
41347	2833	Bobbin Winder, No. 60456, two each 9331 and wood screws 1 in. No. 10 R. H. B.....
41348	---	Bobbin Winder (swinging automatic, right hand) complete, Nos. 27308 and 41347.....
9331	2834	Bobbin Winder Washer.....

## BOBBIN WINDER

(SWINGING AUTOMATIC, RIGHT HAND)  
FOR POWER TABLE

NO.	PLATE	NAME
225433	3469	Bobbin Winder and Tension Bracket Base
225453	3470	Frame with 202277 and 225438.....
225454	3471	" Hinge Pin.....
202277	3471	" Oil Packing (wick).....
225438	3471	" " Well Cap.....
225455	3471	" Spring.....
225456	3471	" " Plunger.....
202473	3470	Pulley with 200380C.....
200380C	3471	" Set Screw.....
225381	3470	Spindle.....
225444	3471	Stop Latch.....
200056E	3471	" " Screw.....
225458	3471	" " Thumb Lever.....
225459	3471	" " " " Hinge Stud.....
225460	3471	" " " " Joint Stud.....



NO.	PLATE	NAME
202478	3471	Stop Latch Trip Lever .....
200299h	3471	" " " " Hinge Screw .....
225461	3471	Tension Bracket with 201499b .....
200082b	3471	" " Screw .....
228026	-----	" " Washer .....
2102	3471	" Disc .....
202407	3471	" Spring .....
201499b	3471	" Stud .....
201572b	3471	" " Thumb Nut .....
225462	-----	Tension Bracket complete, Nos. 201572b, 202407, 225461 and two 2102 .....
225382	3469	Bobbin Winder (swinging automatic, right hand) complete, Nos. 200056e, 200082b, 200299h, 202473, 202478, 225381, 225433, 225444, 225453 to 225456, 225458 to 225460, 225462, 228026 and two wood screws $\frac{3}{4}$ in. No. 13 R. H. B. ....

## FOOT LIFTER PARTS

NO.	PLATE	NAME
5596	5947	Bell Crank .....
56848	-----	" " 5596 with 5599 and 5601 .....
5599	5947	" " Bracket .....
178E	5875	" " " Screw .....
5601	5943	" " Hinge Pin .....
5735	5943	" " Spring .....
5598	5947	Bell Crank complete, Nos. 5735 and 56848
5670	-----	Chain, length 26 in. to 35 in., with 56864 and 56865 .....
NOTE: When ordering No. 5670, state length required		
4879	5947	Chain Connecting Link .....
56864	7712	" Hook (large) .....
56865	7712	" " (small) .....
20340	7716	Lifting Lever with 448c .....
24940	7716	" " Connecting Rod .....
12416	5936	" " " " Joint .....
76D	5875	" " " " " Hinge Screw .....
1521E	7713	Lifting Lever Connecting Rod Lock Nut
802D	5875	" " Hinge Screw .....
12241	5936	" " Link .....
766D	5875	" " " Hinge Screw .....
16586	7712	" " Pin .....

NO.	PLATE	NAME
448c	5875	Lifting Lever Pin Set Screw .....
2763	819	Rock Shaft .....
12242	819	" " Hanger with two wood screws 1 in. No. 10. ....
6337	819	Rock Shaft Lifting Bracket with two 356c
12243	819	" " " " Hook .....
7125	819	" " " " " .....
356c	5875	" " " " " Set Screw
356c	5875	" " " " " Set Screw .....
2770	819	" " Stop Dog with 356c .....
356c	5875	" " " " " Set Screw .....
4880	819	Rock Shaft complete, Nos. 2763, 2770, 7125, 12243 and two each 6337 and 12242 .....
4881	819	Treadle .....
4882	5947	" Shaft .....
4883	5947	" Spring .....
4884	819	" Stand .....
4885	819	Treadle complete, Nos. 4879, 4881 to 4884 and two wood screws 1 in. No. 16. ....
127037	-----	Foot Lifter complete, Nos. 76D, 766D, 802D, 1521E, 4880, 4885, 5598, 5670, 12241, 12416, 16586, 20340, 24940 and two 178E .....

## KNEE LIFTER PARTS

NO.	PLATE	NAME
5596	5947	Bell Crank .....
56848	-----	" " 5596 with 5599 and 5601 .....
5599	5947	" " Bracket .....
178E	5875	" " " Screw .....
5601	5943	" " Hinge Pin .....
5735	5943	" " Spring .....
5598	5947	Bell Crank complete, Nos. 5735 and 56848
20340	7716	Lifting Lever with 448c .....
24940	7716	" " Connecting Rod .....
12416	5936	" " " " " Joint .....
76D	5875	" " " " " Hinge Screw .....
1521E	7713	Lifting Lever Connecting Rod Lock Nut
802D	5875	" " Hinge Screw .....
12241	5936	" " Link .....
766D	5875	" " " Hinge Screw .....
16586	7712	" " Pin .....
448c	5875	" " " Set Screw .....
2763	7711	Rock Shaft .....

NO.	PLATE	NAME
7539	7711	Rock Shaft Hanger with two wood screws 1 in. No. 10.....
2765	7711	Rock Shaft Knee Arm.....
2766	7711	" " " " Hub with 356c....
356c	5875	" " " " " Set Screw....
2768	---	Rock Shaft Knee Arm complete, Nos. 2765 to 2767.....
2767	7711	Rock Shaft Knee Plate with 356c.....
356c	5875	" " " " Set Screw.....
6337	7711	" " Lifting Bracket with two 356c
2778	7711	" " " " Hook.....
356c	5875	" " " " " Set Screw
356c	5875	" " " " " Set Screw....
2770	7711	" " Stop Dog with 356c.....
356c	5875	" " " " Set Screw.....
12250	7711	Rock Shaft complete, Nos. 2763, 2768, 2778, 6337 and two each 2770 and 7539
127038	---	Knee Lifter complete (power table) Nos. 76D, 766D, 802D, 1521E, 5598, 12241, 12250, 12416, 16586, 20340, 24940 and two 178E.....

## KNIFE GRINDER

### FOR 127026 AND 127027

NO.	PLATE	NAME
27565	1104	Emery Wheel, 2 in. diam.....
1508J	1105	" " Clamping Nut.....
27822	1105	" " " " Washer....
27567	1105	" " Shaft.....
60934	---	" " " 27567 with 1508J, 27565, 27569 and 27822.....
27568	1105	Emery Wheel Shaft Oil Hole Cover (rubber).....
27569	1105	Emery Wheel Shaft Pulley.....
310K	1105	" " " " Screw Centre.....
1516J	1105	" " " " " Nut....
27564	1104	Frame with 27574.....
899J	1105	Knife Clamping Screw.....
126304	---	" Holder Body.....
126305	7716	Knife Holder complete, Nos. 899J, 27660 and 126304.....
27323	1105	Knife Holder Guide Bar.....
27572	1104	" " " " Bracket with 27574.....

310K	1105	Knife Holder Guide Bar Bracket Screw Centre.....
1516J	1105	Knife Holder Guide Bar Bracket Screw Centre Nut.....
27573	1105	Knife Holder Guide Bar Bracket Spring
27574	1105	" " " " " " "
		Hook.....
27659	1105	Knife Holder Stop Collar with 237K.....
237K	1105	" " " " Set Screw.....
27660	5913	" Position Pin.....
261J	1105	" Regulating Thumb Screw.....
27662	1104	Wrench for 1508 and 1516.....
60583	---	Knife Grinder, Nos. 261J, 27323, 27564, 27572, 27573, 27659, 60934, two 27568 and four each 310K and 1516J.....
126306	---	Knife Grinder complete, Nos. 27662, 60583, 126305 and three wood screws 1 in. No. 10.....

## THREAD UNWINDER

### FOR TWO SPOOLS

NO.	PLATE	NAME
225395	7233	Spool Rest with 201018c.....
225388	7233	" " Rod.....
200383C	7713	" " " Set Screw.....
201018C	7713	" " Set Screw.....
202490	7233	" Stand with 200383c.....
225391	7233	Thread Guide.....
201696J	7713	" " Lock Nut.....
225392	7233	" " Rod with 208E and 225393
208E	7713	" " " Screw.....
225393	7713	" " " Washer.....
225396	7233	Thread Unwinder complete, Nos. 201696J, 202490, 225388, 225392, 225395, two 225391 and three wood screws 7/8 in. No. 13.....
27739	7234	Thread Cone (wood) for large cones.....
225390	7234	" " Holder, for inverted cones..

NOTE: Nos. 27739 and 225390 are used with,  
but not included in, No. 225396

## NUMERICAL LIST OF PARTS

NO. PLATE	NAME
76D 5875	Lifting Lever Connecting Rod Joint Hinge Screw for 127037 and 127038. . . . .
116E 5875	Arm Screw (back) . . . . .
121E 7713	" Shaft (horizontal) Gear Case Screw for 52071 . . . . .
121E 7713	Rotating Hook Shaft Gear Case Screw for 52072 . . . . .
144D 5875	Arm Shaft (horizontal) Screw . . . . .
152F 2834	Bobbin Winder Stop Latch Finger Screw for 60456 . . . . .
157J 5897	Feed Lifting Rock Shaft Crank Clamping Screw for 12376 . . . . .
157J 5897	Feed Rock Shaft Crank Clamping Screw for 29633 . . . . .
158C 5943	Bed Frame Cushion Screw for 20037 . . . . .
171D 7713	Bobbin Winder Pulley Set Screw for 41585
178E 5875	Bell Crank Bracket Screw for 127037 and 127038 . . . . .
180D 5875	Arm Top Cover Screw . . . . .
180D 5875	Bobbin Winder Tension Bracket Screw . . . . .
185H 7713	" " Stop Latch Tripping Arm Clamping Screw for 41588 . . . . .
190D 5875	Face Plate Screw . . . . .
190D 5875	Presser Foot Screw . . . . .
191C 7713	Knife Bar Crank Set Screw for 24431 . . . . .
200F 2834	Bobbin Winder Pulley Set Screw for 41342 . . . . .
207D 2834	Bobbin Winder Frame Spring Screw for 60456 . . . . .
207E 5911	Needle Bar Connecting Stud Clamping Screw for 24041 . . . . .
208E 7713	Thread Unwinder Thread Guide Rod Screw for 225392 . . . . .
210D 5875	Balance Wheel Oil Cover Screw . . . . .
211E 5943	Bed Frame Hinge Connection Cap Screw for 19398 . . . . .
223C 5936	Slack Thread Regulator Set Screw for 52338 . . . . .
223D 5913	Knife Screw for 52108 . . . . .
226D 5900	Face Plate Thread Guard (lower) Screw for 52103 . . . . .
226D 5900	Face Plate Thread Guard (upper) Screw for 52103 . . . . .

SINGER Needles should be used  
in SINGER Machines.  
These Needles and their Containers  
are marked with the  
Company's Trade Mark "SIMANCO." 1

Needles in Containers marked  
"FOR SINGER MACHINES"  
are NOT **SINGER** made needles. 2

NO.	PLATE	NAME
237k	1105	Knife Grinder Knife Holder Stop Collar Set Screw for 27659.....
261j	1105	Knife Grinder Knife Regulating Thumb Screw for 60583.....
310k	1105	Knife Grinder Emery Wheel Shaft Screw Centre for 60583.....
310k	1105	Knife Grinder Knife Holder Guide Bar Bracket Screw Centre for 60583.....
313c	5875	Feed Bar Screw Centre.....
356c	5875	Rock Shaft Knee Arm Hub Set Screw for 2766.....
356c	5875	Rock Shaft Knee Plate Set Screw for 2767
356c	5875	“ “ Lifting Bracket Hook Set Screw for 6337.....
356c	5875	Rock Shaft Lifting Bracket Set Screw for 6337.....
356c	5875	Rock Shaft Stop Dog Set Screw for 2770
375c	5897	Feed Connecting Link Hinge Screw.....
375c	5897	“ Forked Connection Hinge Screw.....
375c	5897	“ Lifting Rock Shaft Connecting Rod Hinge Screw.....
418e	2834	Bobbin Winder Tension Screw Stud for 27308.....
432c	5898	Arm Shaft (upright) Bushing (lower) Set Screw.....
435c	7713	Arm Shaft (horizontal) Flanged Bushing (front) Set Screw.....
435c	7713	Thread Take-up Lever Link Hinge Pin Set Screw.....
446c	7713	Feed and Feed Lifting Eccentric Set Screw for 20283.....
448c	5875	Arm Shaft (horizontal) Flanged Bushing (back) Set Screw.....
448c	5875	Balance Wheel Set Screw for 52005 and 52081.....
448c	5875	Lifting Lever Pin Set Screw for 20340 ..
448c	5875	Thread Take-up Spring Regulator Set Screw.....
453c	5936	Presser Bar Guide Bracket Set Screw for 52338.....
457c	7713	Bobbin Winder Frame Hinge Pin Set Screw for 41583.....
457c	7713	Bobbin Winder Stop Latch Hinge Stud Set Screw for 41913.....
460c	7713	Bobbin Winder Tension Stud Set Screw for 41591.....
460c	7713	Thread Retainer Set Screw.....

NO.	PLATE	NAME
578d	7713	Throat Plate Cutting Bar Screw for 127036 and 127040.....
578d	7713	Throat Plate Slide Adjusting Screw for 127036 and 127040.....
591f	7717	Rotating Hook Bobbin Case Tension Regulating Screw for 52481.....
592e	7717	Rotating Hook Bobbin Case Latch Stop Screw for 52473.....
620c	5913	Knife Adjusting Screw for 52108.....
621b	5913	“ Bar Lifting Spring Guide Bracket Screw for 52107.....
647c	7713	Knife Bar Driving Crank Bracket Screw
689c	5936	Presser Bar Lifter Screw.....
691f	5875	Throat Plate Screw.....
704j	7717	Rotating Hook Bobbin Case Holder Position Bracket Screw.....
725j	5875	Bed Slide Spring Screw for 12432.....
766b	5875	Lifting Lever Link Hinge Screw for 127037 and 127038.....
775e	5911	Needle Bar Connecting Link Cap Screw for 52143.....
794e	5911	Needle Bar Connecting Link Adjusting Screw for 24040.....
802b	5875	Lifting Lever Hinge Screw for 127037 and 127038.....
818d	5897	Feed Regulator Thumb Screw.....
854e	7713	Arm Screw (front).....
858c	5875	Needle Bar Crank Set Screw for 127031 ..
880e	7713	Bobbin Winder Screw for 41915.....
899j	1105	Knife Grinder Knife Clamping Screw for 126305.....
966e	7713	Feed Lifting Rock Shaft Connecting Rod Cap Screw for 12430.....
1036c	5911	Arm Shaft (horizontal) Gear Set Screw for 52060.....
1036c	5911	Thread Take-up Crank Set Screw for 127031.....
1037c	5911	Thread Take-up Crank Position Screw for 127031.....
1053b	7713	Rotating Hook Thread Guard Screw for 52123.....
1065c	5875	Needle Bar Crank Position Screw for 127031.....
1072f	5911	Needle Set Screw for 127030.....
1128e	5897	Feed Regulator Hinge Screw.....
1133e	5911	Needle Bar Bushing (lower) Set Screw..
1133e	5911	“ “ “ (upper) Set Screw..

NO.	PLATE	NAME
1143c	7713	Rotating Hook Shaft Bushing (back) Set Screw.....
1148c	5898	Rotating Hook Shaft Bushing (front) Set Screw.....
1149c	5875	Arm Shaft (upright) Bushing (upper) Set Screw.....
1162c	5913	Knife Bar Crank Coupling Pin for 24432.....
1253c	7713	Arm Shaft (upright) Gear (lower) Set Screw for 56013.....
1253c	7713	Arm Shaft (upright) Gear (upper) Set Screw for 56101.....
1253c	7713	Rotating Hook Set Screw for 52089.....
1253c	7713	" " Shaft Gear Set Screw for 56013.....
1367d	7717	Rotating Hook Section Screw for 52089.....
1380d	7717	" " Bobbin Case Tension Spring Screw for 52481.....
1429d	2834	Bobbin Winder Frame Hinge Screw for 60456.....
1430d	2834	Bobbin Winder Stop Latch Hinge Screw for 60456.....
1430d	2834	Bobbin Winder Stop Latch Lever Hinge Screw for 60456.....
1508j	1105	Knife Grinder Emery Wheel Clamping Nut for 60934.....
1513j	7713	Feed Lifting Rock Shaft Screw Centre Nut.....
1513j	7713	Feed Rock Shaft Screw Centre Nut.....
1516j	1105	Knife Grinder Emery Wheel Shaft Screw Centre Nut for 60583.....
1516j	1105	Knife Grinder Knife Holder Guide Bar Bracket Screw Centre Nut for 60583.....
1518E	5897	Feed Connecting Link Hinge Screw Nut.....
1518E	5897	" Forked Connection Hinge Screw Nut.....
1518E	5897	Feed Lifting Rock Shaft Connecting Rod Hinge Screw Nut.....
1519j	7713	Feed Bar Screw Centre Nut.....
1520E	5936	Presser Bar Lifter Screw Nut.....
1521E	7713	Lifting Lever Connecting Rod Lock Nut for 127037 and 127038.....
1550j	2834	Bobbin Winder Stop Latch Hinge Screw Nut for 60456.....
1560c	7713	Tension Regulating Thumb Nut for 52397.....
1562j	2834	Bobbin Winder Tension Regulating Thumb Nut for 27308.....

NO.	PLATE	NAME
1564d	5913	Knife Bar Crank Coupling Pin Head for 24432.....
1813	5897	Feed Lifting Rock Shaft Crank Roller and Stud for 12378.....
2022	5913	Knife Bar Crank Pin for 127029.....
2102	5913	Tension Disc for 52397.....
2102	5913	Bobbin Winder Tension Disc for 225462.....
2103	7717	Tension Spring for 52397.....
2106	2834	Bobbin Winder Tension Thread Guide for 27308.....
2291	5913	Knife Screw Washer for 52108.....
2297	5913	" Bar Crank Coupling Pin Spring for 24432.....
2301	5913	Knife Bar Stop Pin for 52104.....
2455	2834	Bobbin Winder Tension Disc for 27308 and 41592.....
2523	5913	Knife Bar Lifting Spring Guide Pin for 24906.....
2763	819	Rock Shaft for 4880 and 12250.....
2765	7711	" " Knee Arm for 2768.....
2766	7711	" " " " Hub with 356c, for 2768.....
2767	7711	Rock Shaft Knee Plate with 356c, for 2768.....
2768	---	Rock Shaft Knee Arm complete for 12250, Nos. 2765 to 2767.....
2770	819	Rock Shaft Stop Dog with 356c, for 4880 and 12250.....
2778	7711	Rock Shaft Lifting Bracket Hook for 12250.....
2974	7717	Rotating Hook Bobbin Case Latch Lever Fulcrum Pin for 40393.....
2975	7717	Rotating Hook Bobbin Case Latch Spring for 52473.....
3033	5897	Feed Connecting Link.....
4307	5907	Bed Slide Spring for 12432.....
4879	5947	Chain Connecting Link for 4885.....
4880	819	Rock Shaft complete for 127037, Nos. 2763, 2770, 7125, 12243 and two each 6337 and 12242.....
Nos. 4881 to 4884 for 4885		
4881	819	Treadle.....
4882	5947	" Shaft.....
4883	5947	" Spring.....
4884	819	" Stand.....

NO.	PLATE	NAME
4885	819	Treadle complete for 127037, Nos. 4879, 4881 to 4884 and two wood screws 1 in. No. 16.....
5596	5947	Bell Crank for 56848.....
5598	5947	Bell Crank complete for 127037 and 127038, Nos. 5735 and 56848.....
5599	5947	Bell Crank Bracket for 56848.....
5601	5943	" " Hinge Pin for 56848.....
5670	—	Chain, length 26 in. to 35 in., with 56864 and 56865, for 127037.....
5729	—	Throat Plate Body for 127036 and 127040
5730	7715	" " Cutting Bar for 127036.....
5735	5943	Bell Crank Spring for 5598.....
6337	819	Rock Shaft Lifting Bracket with two 356c, for 4880 and 12250.....
7125	819	Rock Shaft Lifting Bracket Hook for 4880
7539	7711	" " Hanger with two wood screws 1 in. No. 10, for 12250.....
7958	5913	Bobbin Winder Stop Latch Stop Pin for 60845.....
8879	5936	Arm Spool Pin Washer (cloth).....
8879	5936	Bobbin Winder Tension Bracket Spool Pin Washer (cloth).....
8908	5901	Wrench for 1519 and 1520 (Accessories)...
8909	5901	" " 1513 and 1518 (Accessories)...
9331	2834	Bobbin Winder Washer for 41347.....
10141	2834	" " Tension Spring for 27308
11167	5896	Presser Bar Spring.....
11170	5936	" " " Washer.....
11204	5911	Thread Take-up Lever Link Hinge Pin for 52054.....
11241	2833	Bobbin Winder Spool Washer (cloth) for 27308.....
12193	5907	Arm Side Cover.....
*12204	—	Feed Lifting Rock Shaft Connecting Rod Cap for 12430.....
12241	5936	Lifting Lever Link for 127037 and 127038
12242	819	Rock Shaft Hanger with two wood screws 1 in. No. 10, for 4880.....
12243	819	Rock Shaft Lifting Bracket Hook for 4880
12250	7711	Rock Shaft complete for 127038, Nos. 2763, 2768, 2778, 6337 and two each 2770 and 7539.....
12327	5936	Presser Bar Lifting and Releasing Lever Bracket.....
12329	5936	Tension Releasing Lever Spring.....
12361	5943	Machine Hinge Connection for 44140...

NO.	PLATE	NAME
12376	5897	Feed Lifting Rock Shaft Crank with 157J and 1813, for 52385.....
12391	5896	Presser Bar (hollow).....
12398	5936	Tension Releasing Lever Hinge Pin....
12403	5900	Arm Spool Pin and Thread Eyelet for 52043.....
12403	5900	Bobbin Winder Tension Bracket Spool Pin for 41592.....
12405	5943	Machine Rest (felt) Accessories.....
12416	5936	Lifting Lever Connecting Rod Joint for 127037 and 127038.....
12430	5896	Feed Lifting Rock Shaft Connecting Rod (steel) with 12204 and two 968E.....
12431	—	Bed Slide for 12432.....
12432	5907	Bed Slide complete, Nos. 4307, 12431 and two 725J.....
12454	5900	Arm Oil Tube with 29599, for oiling 52024
14010	5943	Bed Frame Hinge Plate Rivet for 20067..
16532	5900	Arm Dowel Pin.....
16555	5943	Bed Frame Hinge Plate for 20067.....
16564	7716	Knife Bar Driving Crank Bracket for 127029.....
16586	7712	Lifting Lever Pin for 127037 and 127038
18130	5900	Arm Oil Tube with 29599, for oiling 52022
19219	5943	Bed Frame Cushion (leather) for 20067..
19220	5943	" " " Spring for 20067....
19226	5943	" " Hinge Connection for 19398..
19397	5943	" " " " Cap for 19398
19398	—	" " " " 19226 with 211E and 19397, for 20067.....
20067	819	Bed Frame with two each 16555, 19398, four each 19219, 19220, six each 14010, wood screws 1¼ in. No. 12 and eight 158c.....
20283	5947	Feed and Feed Lifting Eccentric with 446c.....
20284	5947	Feed Forked Connection.....
20340	7716	Lifting Lever with 448c, for 127037 and 127038.....
24036	5896	Feed and Feed Lifting Eccentric Sleeve..
24040	5911	Needle Bar Connecting Link with 794E, for 24894.....
24041	5911	Needle Bar Connecting Stud with 207E, for 24894.....
24109	5913	Knife Holder Handle for 52107.....
24122	5913	" Bar Lifting Spring.....
24123	5913	" " " " Case.....

NO.	PLATE	NAME
24124	5913	Knife Bar Lifting Spring Guide for 24906
24125	5913	“ “ “ “ “ Bracket for 24906.....
24131	5900	Arm Oil Tube with 29599, for oiling 12430 and 24036, for 52043.....
24131	5900	Bobbin Winder Tension Bracket Oil Tube with 29599, for 41592.....
24431	7716	Knife Bar Crank with 191c, for 24432...
24432	---	Knife Bar Crank complete for 127029, Nos. 1162c, 1564d, 2297 and 24431...
24894	---	Needle Bar Connecting Link 24040 with 24041, for 52143.....
*24906	---	Knife Bar Lifting Spring Guide 24124 with 2523 and 24125, for 52107.....
24940	7716	Lifting Lever Connecting Rod for 127037 and 127038.....
25446	5900	Bobbin Winder Screw Washer for 41915
26026	5901	Screw Driver, large (Accessories).....
26485	5901	“ “ small (Accessories).....
27306	2834	Bobbin Winder Spool Pin for 27308.....
27307	2833	“ “ “ Stand for 27308.....
27308	2833	Bobbin Winder Spool Stand complete for 41348, Nos. 418e, 1562j, 2106, 10141, 11241, 27306, 27307, two each 2455 and wood screws 1 in. No. 10.....
27323	1105	Knife Grinder Knife Holder Guide Bar for 60583.....
27564	1104	Knife Grinder Frame with 27574, for 60583.....
27565	1104	Knife Grinder Emery Wheel, 2 in. diam., for 60934.....
27567	1105	Knife Grinder Emery Wheel Shaft for 60934.....
27568	1105	Knife Grinder Emery Wheel Shaft Oil Hole Cover (rubber) for 60583.....
27569	1105	Knife Grinder Emery Wheel Shaft Pulley for 60934.....
27572	1104	Knife Grinder Knife Holder Guide Bar Bracket with 27574, for 60583.....
27573	1105	Knife Grinder Knife Holder Guide Bar Bracket Spring for 60583.....
27574	1105	Knife Grinder Knife Holder Guide Bar Bracket Spring Hook for 27564 and 27572.....
27659	1105	Knife Grinder Knife Holder Stop Collar with 237k, for 60583.....

NO.	PLATE	NAME
27660	5913	Knife Grinder Knife Position Pin for 126305.....
27662	1104	Wrench for 1508 and 1516, for 126308...
27739	7234	Thread Unwinder Thread Cone (wood) for large cones.....
27822	1105	Knife Grinder Emery Wheel Clamping Nut Washer for 60934.....
28084	---	Machine Rest Pin (Accessories).....
29599	5900	Arm Oil Tube Packing (felt) for 12454, 18130, 24131 and 52120.....
29599	5900	Bobbin Winder Tension Bracket Oil Tube Packing (felt) for 24131.....
29633	5897	Feed Rock Shaft Crank with 157j, for 52387.....
32572	5913	Tension Releasing Disc for 52397.....
32574	5913	“ “ Pin for 52397.....
34105	5902	Bobbin Winder Frame Hinge Pin for 60845.....
40264	7717	Rotating Hook Bobbin.....
40274	7717	“ “ Section for 52089.....
40392	7717	“ “ Bobbin Case Latch for 40393.....
40393	---	Rotating Hook Bobbin Case Hinge, Nos. 2974, 40392 and 40409, for 52473.....
40394	7717	Rotating Hook Bobbin Case Tension Spring for 52481.....
40409	7717	Rotating Hook Bobbin Case Latch Lever for 40393.....
Nos. 41339 TO 41346 FOR 60456		
41339	2833	Bobbin Winder Base.....
41340	2833	“ “ Frame.....
41341	2833	“ “ Spring.....
41342	2833	“ “ Pulley with 200F.....
41343	2834	“ “ Spindle.....
41344	2834	“ “ Stop Latch.....
41345	2834	“ “ “ “ Finger.....
41346	2834	“ “ “ “ Lever.....
41347	2833	Bobbin Winder for 41348, No. 60456, two each 9331 and wood screws 1 in. No. 10 R. H. B.....
41348	---	Bobbin Winder (swinging automatic, right hand) complete, Nos. 27308 and 41347
41583	5902	Bobbin Winder Frame with 457c, for 60845.....

NO.	PLATE	NAME
Nos. 41585 TO 41588 FOR 60845		
41585	5902	Bobbin Winder Pulley with 171d.....
41586	5902	“ “ Spindle.....
41587	5902	“ “ Stop Latch.....
41588	5902	“ “ “ Tripping Arm with 185h.....
41591	5902	Bobbin Winder Tension Bracket with 460c, for 41592.....
41592	5902	Bobbin Winder Tension Bracket com- plete for 41916, Nos. 12403, 24131, 41591, 41593 to 41595 and two 2455..
Nos. 41593 TO 41595 FOR 41592		
41593	5936	Bobbin Winder Tension Spring.....
41594	5936	“ “ “ Stud.....
41595	5936	“ “ “ Thread Guide..
41913	5902	“ “ Bracket with 457c, for 60845.....
41914	5902	Bobbin Winder Frame Spring for 60845..
41915	5902	“ “ 60845 with 880e and 25446, for 41916.....
41916	---	Bobbin Winder (swinging automatic, left hand) complete, Nos. 41592 and 41915
42614	5902	Bobbin Winder Stop Latch Hinge Stud for 41915.....
43944	5936	Tension Releasing Lever.....
44139	5943	Machine Hinge Plate for 44140.....
44140	---	Machine Hinge complete, Nos. 12361, 44139 and merlized wood screw $1\frac{1}{4}$ in. No. 14 (Accessories).....
44212	7711	Drip Pan with four 1 in. wire nails.....
50053d	7713	Arm Side Cover Thumb Screw.....
50083c	5897	Feed Connecting Link Hinge Stud Set Screw for 52074.....
50117E	5913	Feed Dog Screw.....
50117E	5913	Knife Holder Handle Screw for 52107....
50117E	5913	“ “ Screw for 52107.....
50190d	7713	Face Plate Thumb Screw.....
50191c	7713	Feed Lifting Rock Shaft Screw Centre..
50191c	7713	“ Rock Shaft Screw Centre.....
50234E	7713	Arm Shaft (horizontal) Gear Case Plug Screw for 52071.....
50234E	7713	Rotating Hook Shaft Gear Case Plug Screw for 52072.....
50304c	7717	Tension Stud for 52397.....
50305c	7717	“ “ Set Screw for 52083.....

NO.	PLATE	NAME
50373j	7713	Pressure Regulating Thumb Screw.....
52005	5893	Balance Wheel (power) light rim, $2\frac{1}{8}$ in. pulley, with two 448c.....
52016	5936	Presser Bar Lifter.....
52018	7717	Rotating Hook Bobbin Case Holder Posi- tion Bracket.....
52021	5911	Thread Take-up Crank for 52143.....
Nos. 52022 TO 52024 FOR 52025		
52022	5911	Thread Take-up Lever with 52130.....
52023	5911	“ “ “ Hinge Pin.....
52024	5911	“ “ “ Link.....
52025	----	Thread Take-up Lever complete for 52054, Nos. 52022 to 52024.....
52027	5911	Thread Guard (side of arm).....
52042	5896	Arm Top Cover for 52043.....
52043	5896	“ “ “ 52042 with 12403 and 24131.....
52045	5898	Rotating Hook Shaft Bushing (back) Packing (cotton).....
52045	5898	Rotating Hook Shaft Bushing (front) Packing (cotton).....
52053	5900	Face Plate Thread Guard (lower) for 52103.....
52054	----	Thread Take-up complete, Nos. 11204, 52025 and 52143.....
52059	5907	Arm Shaft (horizontal) Flanged Bushing (back).....
52060	5898	Arm Shaft (horizontal) Gear with two 1036c.....
52062	5898	Arm Shaft (upright).....
52063	5907	Balance Wheel Oil Cover.....
52071	5907	Arm Shaft (horizontal) Gear Case (two pieces) with 121E and 50234E.....
52072	5907	Rotating Hook Shaft Gear Case (two pieces) with 121E and 50234E.....
52073	5897	Feed Connecting Link Hinge Stud.....
52074	5897	“ Regulator with 50083c.....
52078	5907	Arm Shaft (horizontal) Flanged Bushing (front).....
52081	5893	Balance Wheel (stand) heavy rim, $2\frac{1}{8}$ in. pulley, with two 448c.....
52083	7717	Thread Take-up Spring Regulator with 50305c, for 52397.....
52089	5898	Rotating Hook 52123 with 40274 and three each 1253c and 1367d, for 52478
52090	5898	Rotating Hook Thread Guard for 52123



NO.	PLATE	NAME
52102	-----	Face Plate for 52103.....
52103	5907	Face Plate complete, Nos. 52053, 52102, 56086 and two 226b.....
52104	7716	Knife Bar with 2301, for 52107.....
52107	-----	Knife Bar complete, Nos. 621b, 24109, 24906, 52104, 52108 and three 50117E
52108	5913	Knife Holder with 620c, 2291 and two 223b, for 52107.....
52110	5911	Needle Bar Bushing (lower) with 52114..
52111	5911	“ “ “ (upper).....
52114	5911	“ “ Oil Cup for 52110.....
52120	7712	Arm Oil Tube with 29599, for oiling 24040
52121	-----	Rotating Hook for 52123.....
52123	-----	“ “ 52121 with 52090 and four 1053b, for 52089.....
52130	7717	Thread Take-up Lever Thread Eyelet Bushing for 52022.....
52131	7715	Throat Plate Cutting Bar for 127040....
52143	-----	Thread Take-up Crank 52021 with 775E and 24894, for 52054.....
52337	5936	Slack Thread Regulator.....
52338	5935	Presser Bar Guide Bracket with 223c and 453c.....
52359	7712	Feed Regulator Thumb Screw Stop.....
*52383	-----	Bed.....
52384	7714	Feed Lifting Rock Shaft for 52385.....
52385	-----	Feed Lifting Rock Shaft complete, Nos. 12376 and 52384.....
52386	7714	Feed Rock Shaft for 52387.....
52387	-----	Feed Rock Shaft complete, Nos. 29633 and 52386.....
52388	7714	Rotating Hook Shaft.....
52394	7717	Thread Take-up Spring for 52397.....
52397	-----	Tension complete, Nos. 1560c, 2103, 32572, 32574, 50301c, 52083, 52394 and two 2102.....
52452	5896	Feed Bar.....
52454	5900	Thread Retainer.....
52472	-----	Rotating Hook Bobbin Case for 52481..
52473	7717	Rotating Hook Bobbin Case complete for 52474, Nos. 592E, 2975, 40393 and 52481.....
52474	-----	Rotating Hook Bobbin Case 52473 with 52477, for 52478.....
*52475	-----	Rotating Hook Bobbin Case Locating Plate for 52477.....

NO.	PLATE	NAME
*52476	-----	Rotating Hook Bobbin Case Locating Plate Rivet for 52477.....
52477	7717	Rotating Hook Bobbin Case Holder with 52475 and two 52476, for 52474.....
52478	---	Rotating Hook 52089 with 52474.....
52481	-----	“ “ Bobbin Case 52472 with 591F, 1380b and 40394, for 52473.....
54897	5900	Arm Shaft (horizontal) Front Bearing Oil Cup.....
56006	5900	Arm Shaft (horizontal) Flanged Bushing (back) Oil Pad (braided cotton).....
56006	5900	Arm Shaft (horizontal) Flanged Bushing (front) Oil Pad (braided cotton).....
56013	5898	Arm Shaft (upright) Gear (lower) with two 1253c.....
56013	5898	Rotating Hook Shaft Gear with two 1253c
56015	5900	Arm Shaft (upright) Oil Tube (lower) for 127023.....
56015	5900	Arm Shaft (upright) Oil Tube (upper) for 127023.....
56086	5900	Face Plate Thread Guard (upper) for 52103.....
56099	5898	Arm Shaft (upright) Bushing (lower).....
56100	5898	“ “ “ “ (upper)....
56101	5898	“ “ “ Gear (upper) with two 1253c.....
56106	5898	Rotating Hook Shaft Bushing (back)....
56107	5898	“ “ “ “ (front)....
56848	-----	Bell Crank 5596 with 5599 and 5601, for 5598.....
56864	7712	Chain Hook (large) for 5670.....
56865	7712	“ “ (small) for 5670.....
60456	-----	Bobbin Winder for 41347, Nos. 152F, 207b, 1429b, 1550j, 41339 to 41346 and three 1430b.....
60583	-----	Knife Grinder for 126306, Nos. 261J, 27323, 27564, 27572, 27573, 27659, 60934, two 27568 and four each 310K and 1516j.....
60845	-----	Bobbin Winder for 41915, Nos. 7958, 34105, 41583, 41585 to 41588, 41913, 41914 and 42614.....
60934	-----	Knife Grinder Emery Wheel Shaft 27567 with 1508j, 27565, 27569 and 27822, for 60583.....
120342	5901	Oiler (copper plated) with 120343 (Acces- sories).....

NO.	PLATE	NAME
120343	5901	Oiler Spout, 3½ in. long, for 120342....
126304	---	Knife Grinder Knife Holder Body for 126305.....
126305	7716	Knife Grinder Knife Holder complete for 126306, Nos. 899J, 27660 and 126304...
126306	----	Knife Grinder complete, Nos. 27662, 60583, 126305 and three wood screws 1 in. No. 10.....
*127023	-----	Arm with two 56015.....
127024	7714	" Shaft (horizontal).....
127025	7715	Feed Dog.....
127026	7712	Knife (narrow).....
127027	7712	" (wide).....
127028	7716	" Bar Driving Crank (forked) for 127029.....
127029	----	Knife Bar Driving Crank Bracket complete, Nos. 2022, 16564, 24432 and 127028.....
127030	7716	Needle Bar (hollow) with 1072F.....
127031	7716	" " Crank (eccentric) with 858c, 1036c, 1037c and 1065c.....
127032	7712	Needle Bar Crank (eccentric) Sleeve....
127033	7715	Presser Foot, for ⅙ in. to ¼ in. gauges..
127034	7715	" " " ⅙ in. gauge and above
127035	7715	Throat Plate Slide for 127036 and 127040
127036	7715	Throat Plate (small needle hole) complete for 127025, Nos. 5729, 5730, 127035 and three 578d.....
127037	----	Foot Lifter complete, Nos. 76d, 766d, 802d, 1521e, 4880, 4885, 5598, 5670, 12241, 12416, 16586, 20340, 24940 and two 178E.....
127038	----	Knee Lifter complete (power table) Nos. 76d, 766d, 802d, 1521e, 5598, 12241, 12250, 12416, 16586, 20340, 24940 and two 178E.....
127040	7715	Throat Plate (large needle hole) complete for 127025, Nos. 5729, 52131, 127035 and three 578d.....
200056E	3471	Bobbin Winder Stop Latch Screw for 225382.....
200082D	3471	Bobbin Winder Tension Bracket Screw for 225382.....
200299H	3471	Bobbin Winder Stop Latch Trip Lever Hinge Screw for 225382.....
200380C	3471	Bobbin Winder Pulley Set Screw for 202473.....

NO.	PLATE	NAME
200383c	7713	Thread Unwinder Spool Rest Rod Set Screw for 202490.....
201018c	7713	Thread Unwinder Spool Rest Set Screw for 225395.....
201499B	3471	Bobbin Winder Tension Stud for 225461
201572B	3471	" " " " Thumb Nut for 225462.....
201696J	7713	Thread Unwinder Thread Guide Lock Nut for 225396.....
202277	3471	Bobbin Winder Frame Oil Packing (wick) for 225453.....
202407	3471	Bobbin Winder Tension Spring for 225462
202473	3470	" " Pulley with 200380c, for 225382.....
202478	3471	Bobbin Winder Stop Latch Trip Lever for 225382.....
202490	7233	Thread Unwinder Spool Stand with 200383c, for 225396.....
225381	3470	Bobbin Winder Spindle for 225382.....
225382	3469	Bobbin Winder (swinging automatic, right hand) complete, Nos. 200056E, 200082D, 200299H, 202473, 202478, 225381, 225433, 225444, 225453 to 225456, 225458 to 225460, 225462, 228026 and two wood screws ¾ in. No. 13 R. H. B.
225388	7233	Thread Unwinder Spool Rest Rod for 225396.....
225390	7234	Thread Cone Holder, for inverted cones..
225391	7233	" Unwinder Thread Guide for 225396.....
225392	7233	Thread Unwinder Thread Guide Rod with 208E and 225393, for 225396.....
225393	7713	Thread Unwinder Thread Guide Rod Washer for 225392.....
225395	7233	Thread Unwinder Spool Rest with 201018c, for 225396.....
225396	7233	Thread Unwinder complete, for two spools, Nos. 201696J, 202490, 225388, 225392, 225395, two 225391 and three wood screws ⅙ in. No. 13.....
225433	3469	Bobbin Winder and Tension Bracket Base for 225382.....
225438	3471	Bobbin Winder Frame Oil Well Cap for 225453.....
225444	3471	Bobbin Winder Stop Latch for 225382..

NO.	PLATE	NAME
Nos. 225453 to 225456 for 225382		
225453	3470	Bobbin Winder Frame with 202277 and 225438.....
225454	3471	Bobbin Winder Frame Hinge Pin.....
225455	3471	" " " Spring.....
225456	3471	" " " " Plunger...
Nos. 225458 to 225460 for 225382		
225458	3471	Bobbin Winder Stop Latch Thumb Lever
225459	3471	" " " " " " "
		Hinge Stud.....
225460	3471	Bobbin Winder Stop Latch Thumb Lever Joint Stud.....
225461	3471	Bobbin Winder Tension Bracket with 201499b, for 225462.....
225462	-----	Bobbin Winder Tension Bracket complete for 225382, Nos. 201572b, 202407, 225461 and two 2102.....
228026	-----	Bobbin Winder Tension Bracket Screw Washer for 225382.....

SINGER Needles should be used in SINGER Machines. These Needles and their Containers are marked with the Company's Trade Mark "SIMANCO. 34" 1

Needles in Containers marked "FOR SINGER MACHINES" are NOT **SINGER** made needles. 2

## PLATE 819—ONE-FOURTH SIZE

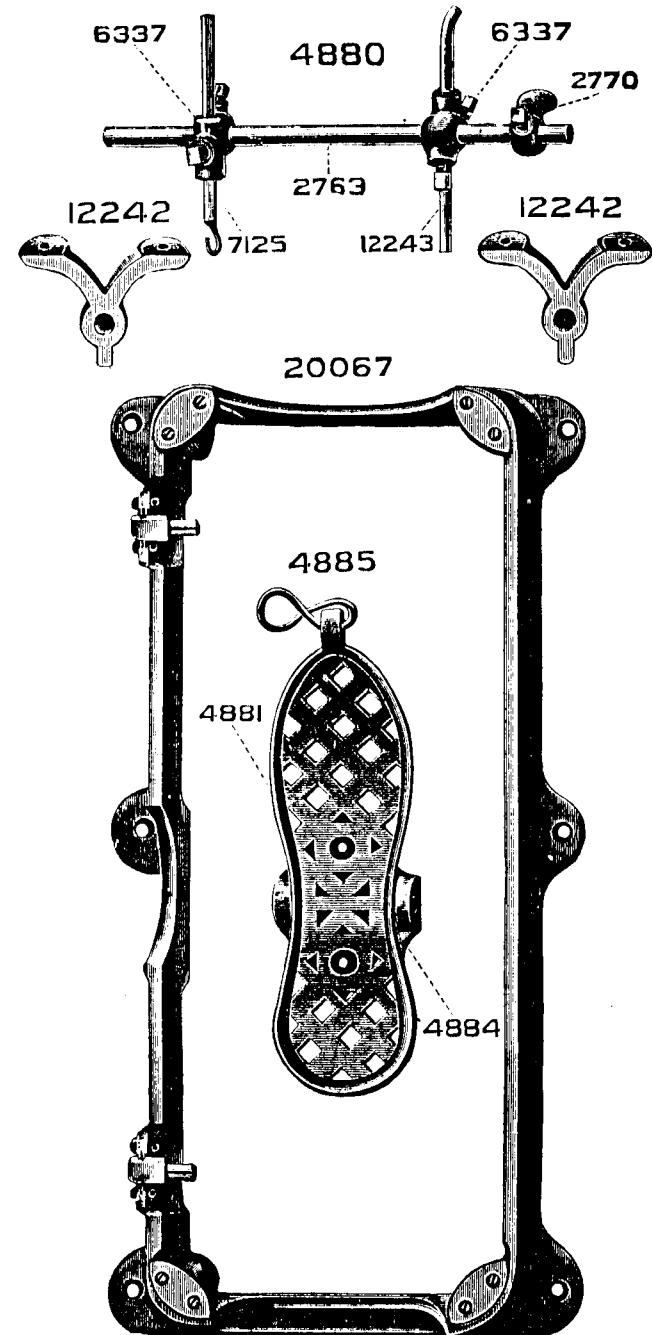

PLATE 1104—ONE-HALF SIZE

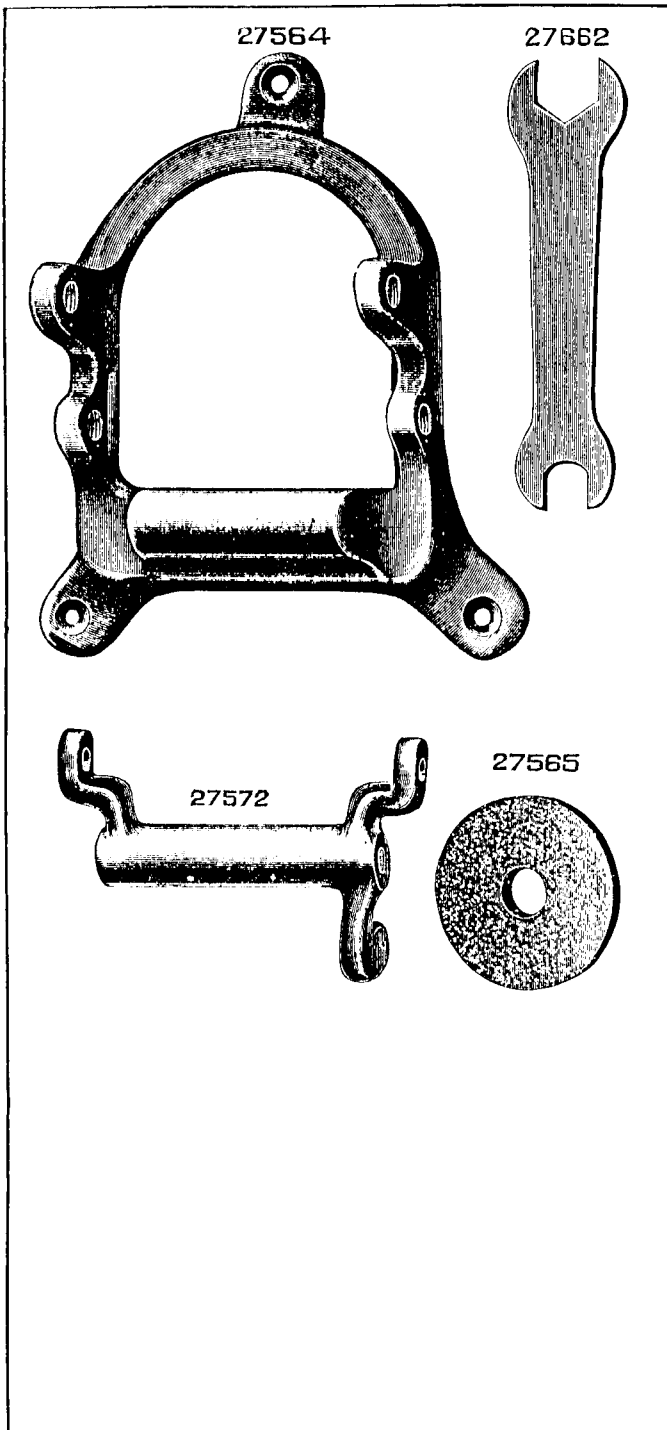

PLATE 1105—FULL SIZE

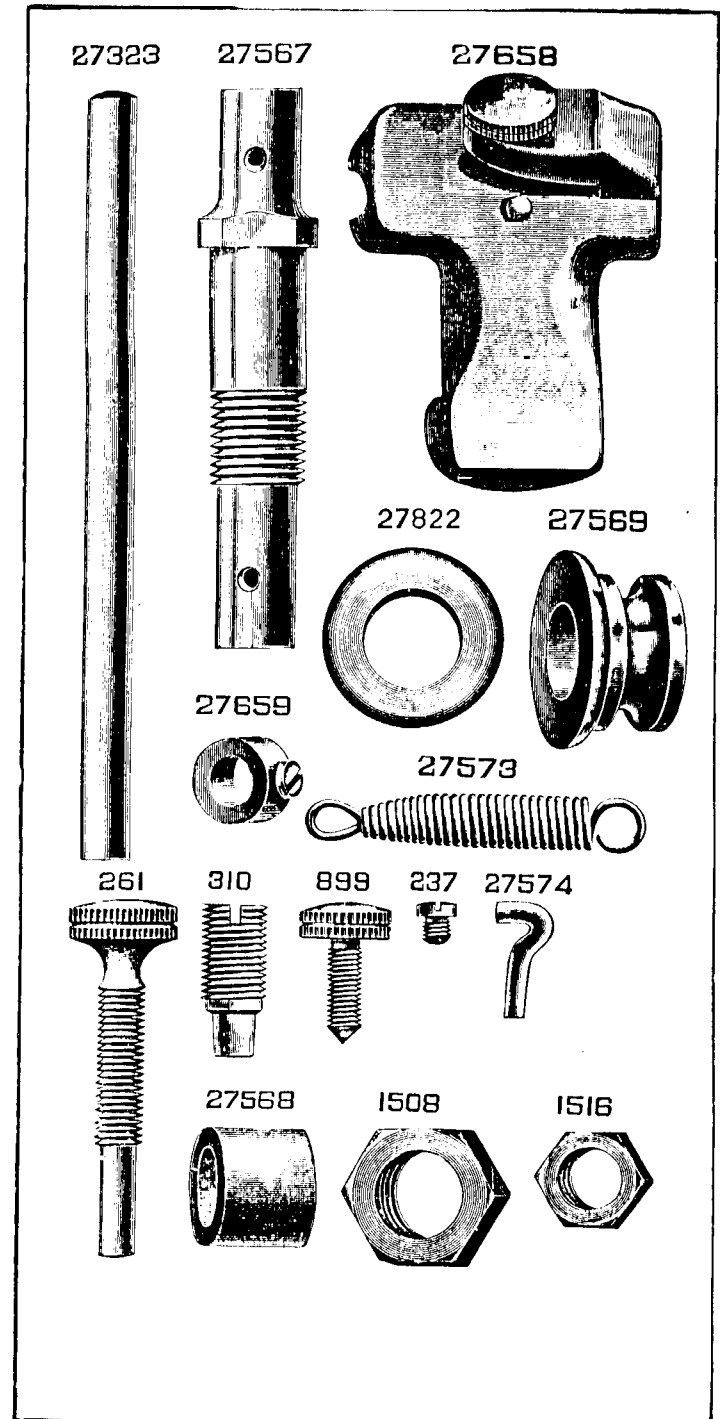

PLATE 2833--ONE-HALF SIZE

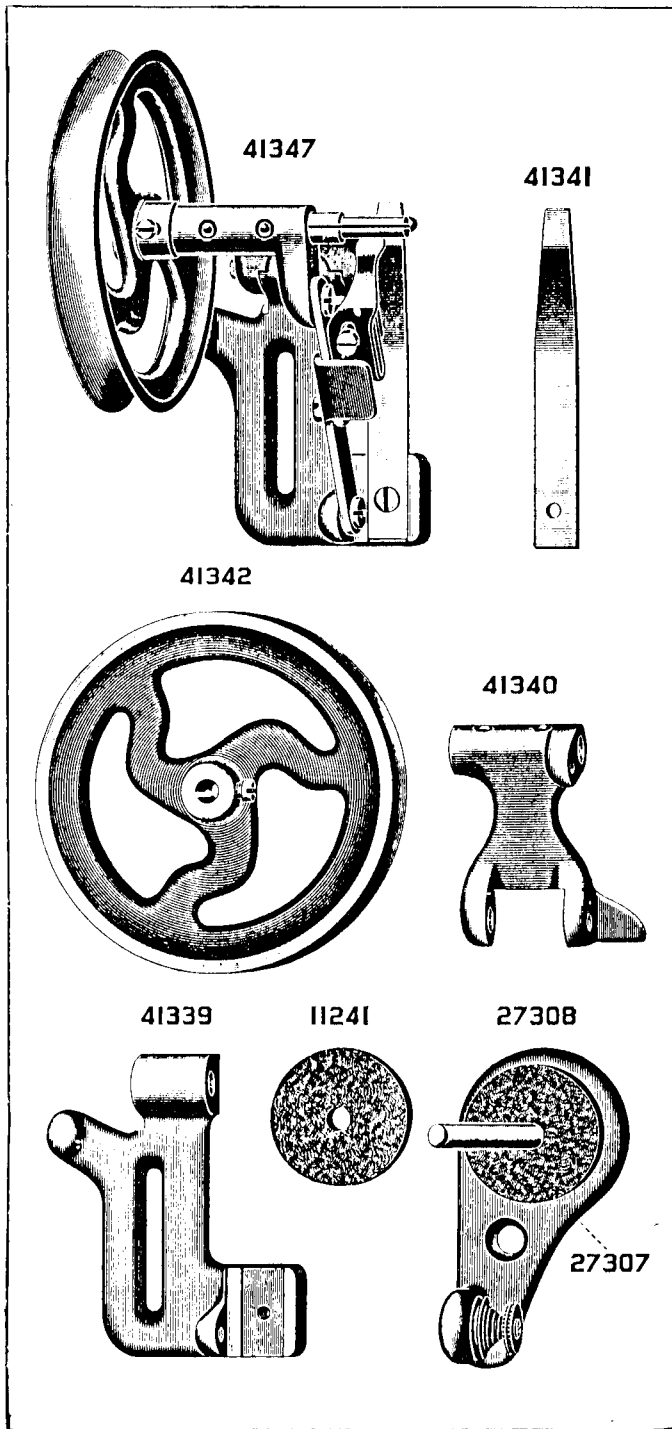

PLATE 2834--FULL SIZE

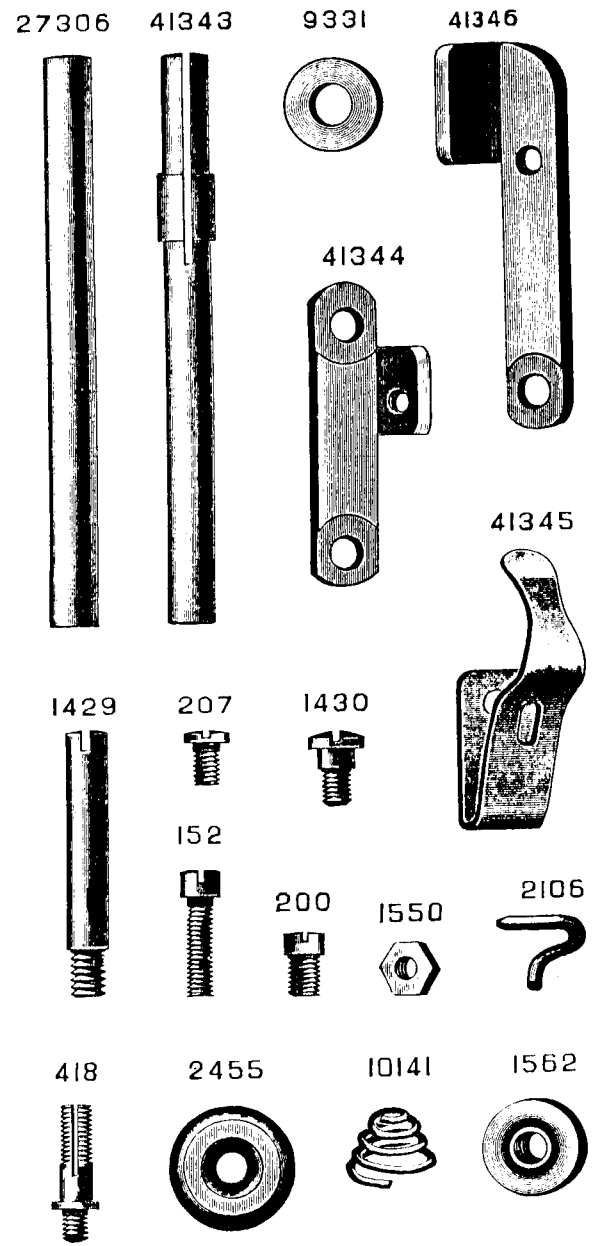

PLATE 3469—ONE-FOURTH SIZE

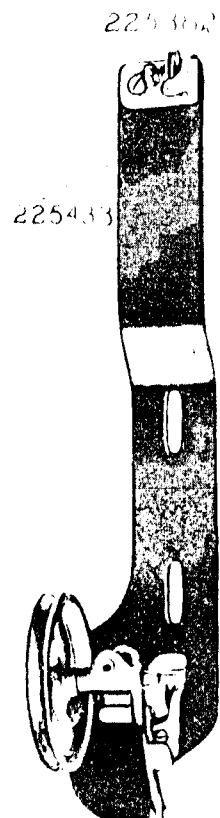

PLATE 3470—ONE-HALF SIZE

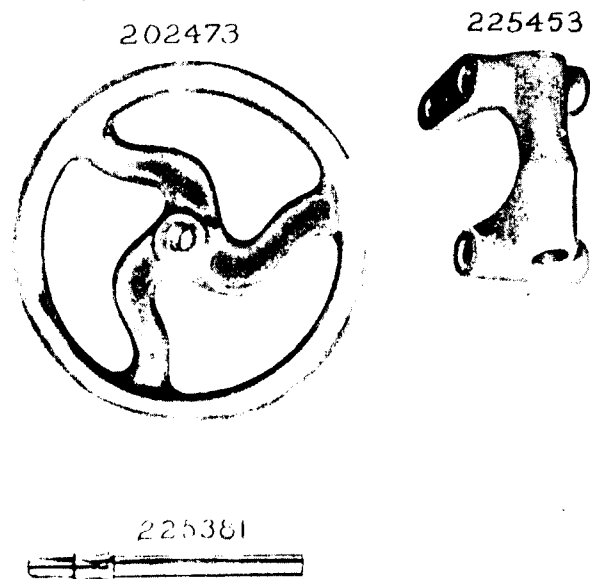

PLATE 3471—FULL SIZE

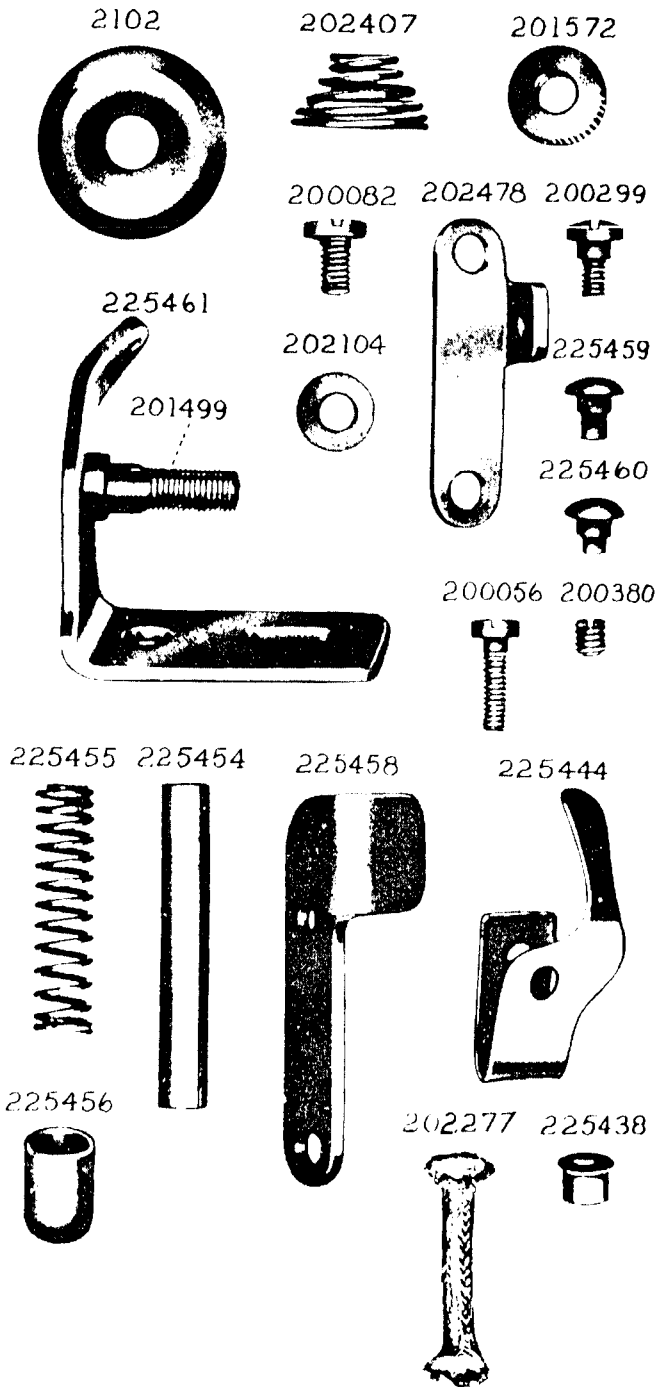

PLATE 5875—FULL SIZE

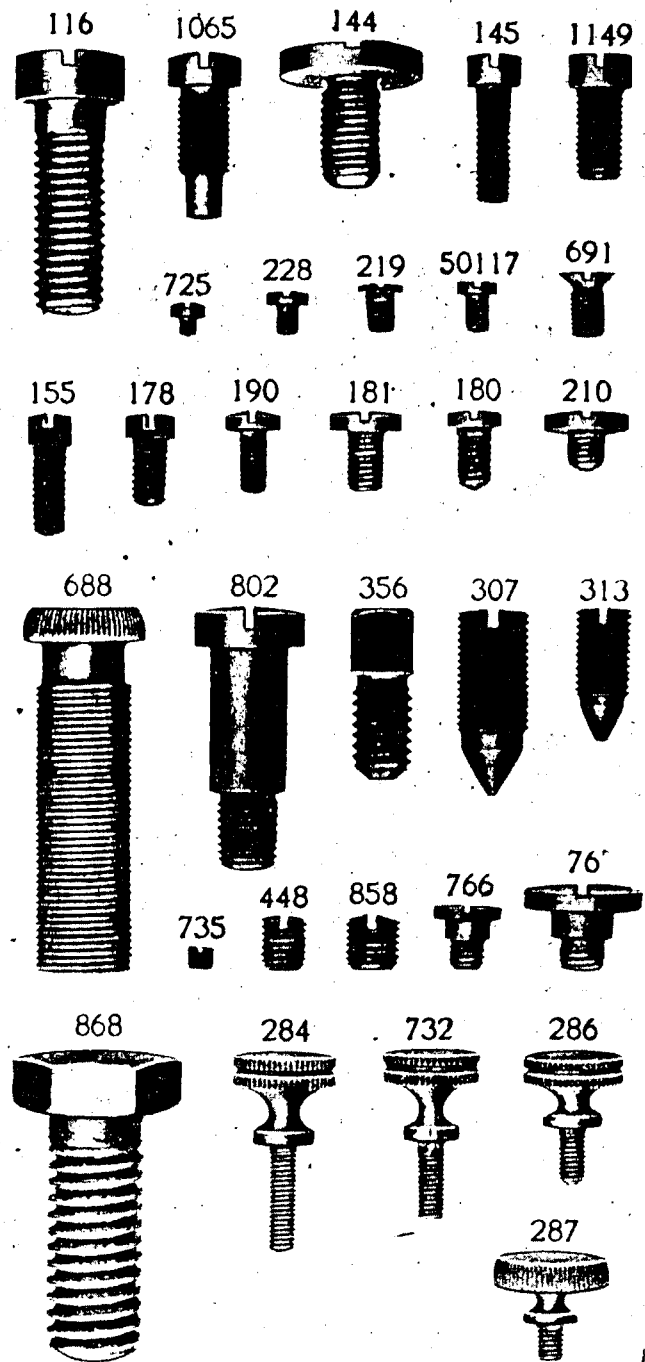
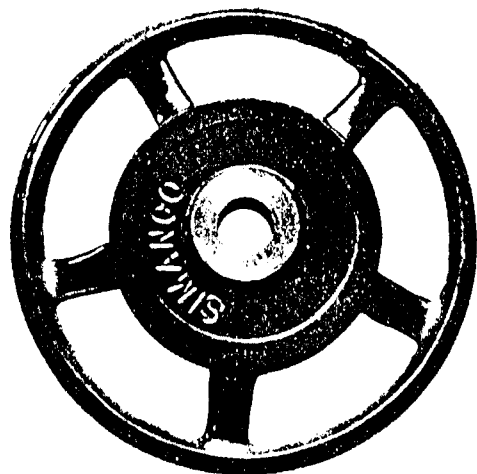

PLATE 5893—ONE-HALF SIZE

52005



52081

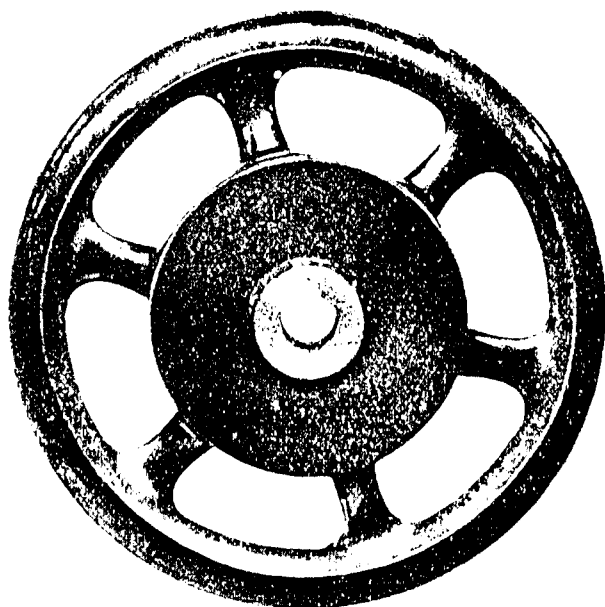
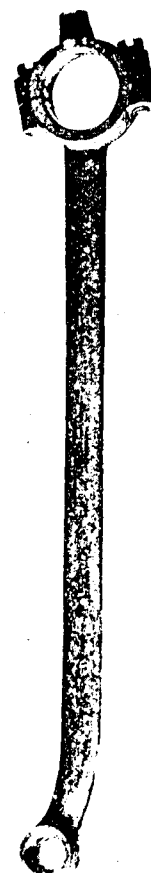

PLATE 5896—ONE-HALF SIZE

12430



12391



11167

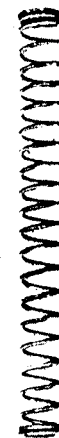

52452



24297

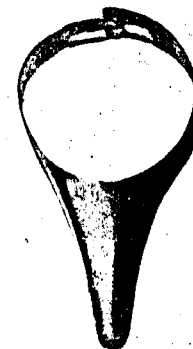

52043

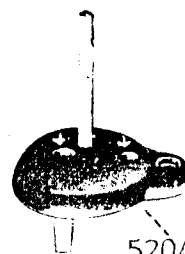

24036



43921



52042



PLATE 5897—FULL SIZE

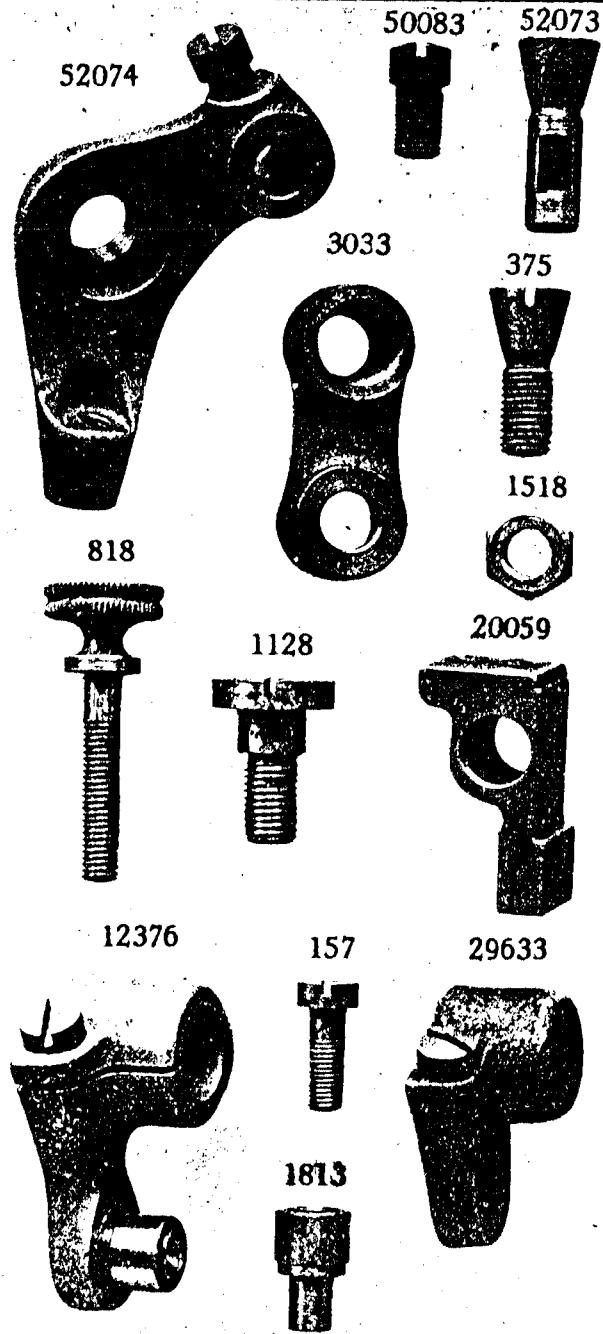

PLATE 5898—FULL SIZE

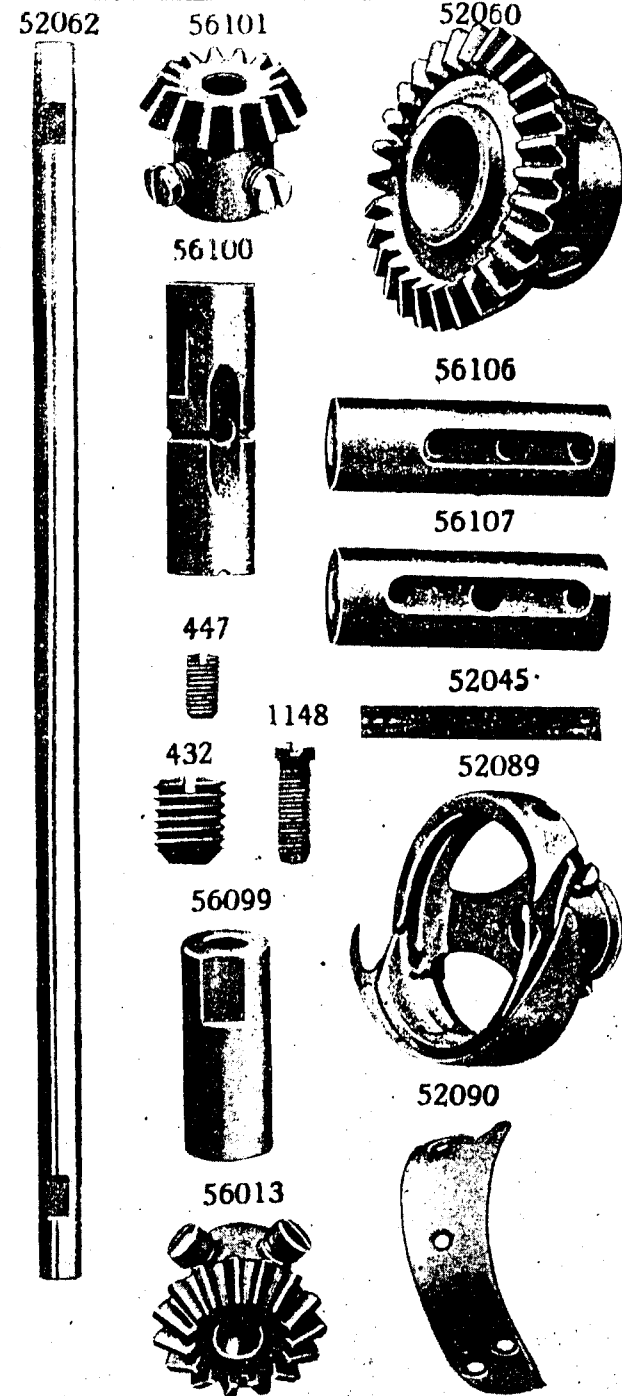

PLATE 5900—FULL SIZE

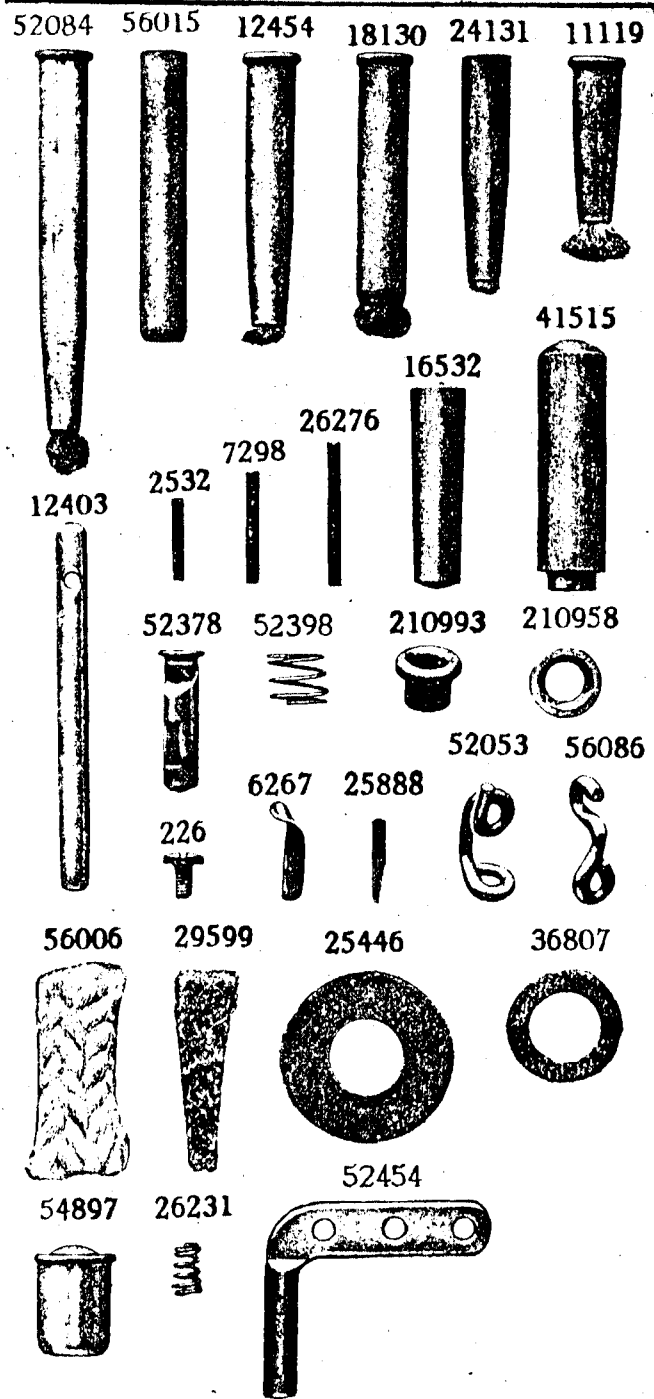

PLATE 5901—ONE-HALF SIZE

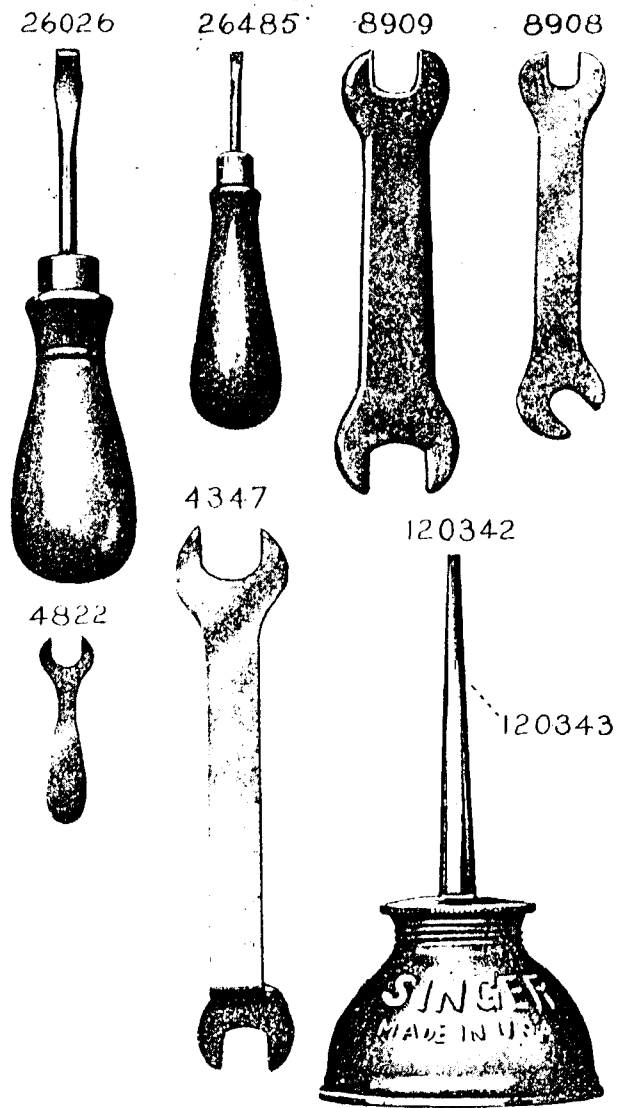
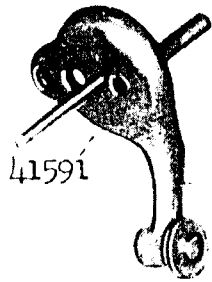

PLATE 5902 - ONE-HALF SIZE

41592

41915

41585



41591



41587

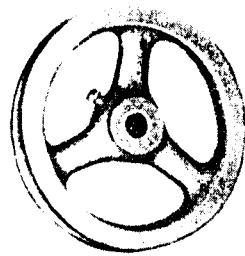

41586

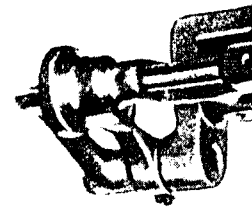

41913

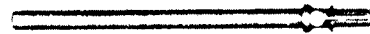

41583

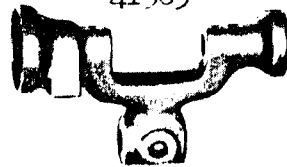

41588

42614

41914

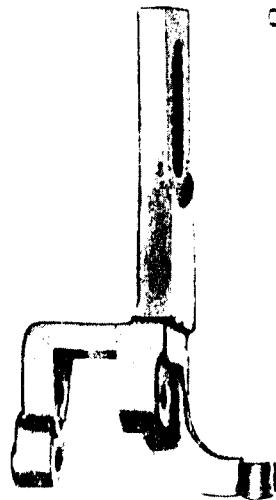

34105

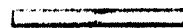
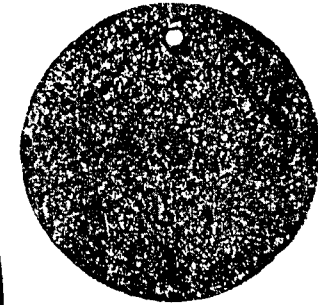
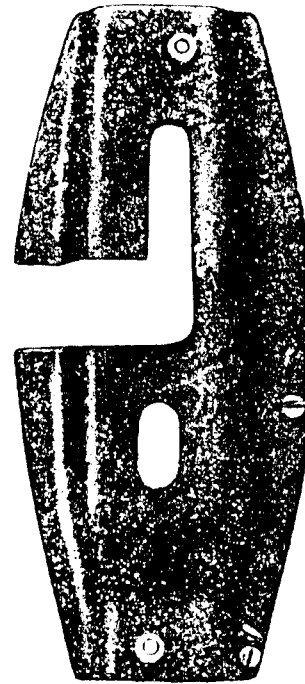

PLATE 5907 - ONE-HALF SIZE

52103

12193



12432

4307

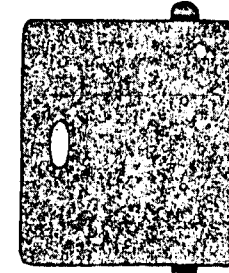

52063

52071

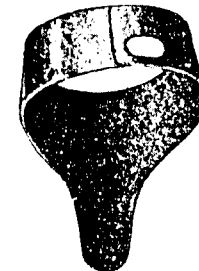

52059

52072



52078

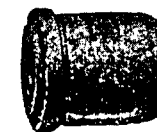

PLATE 5911—FULL SIZE

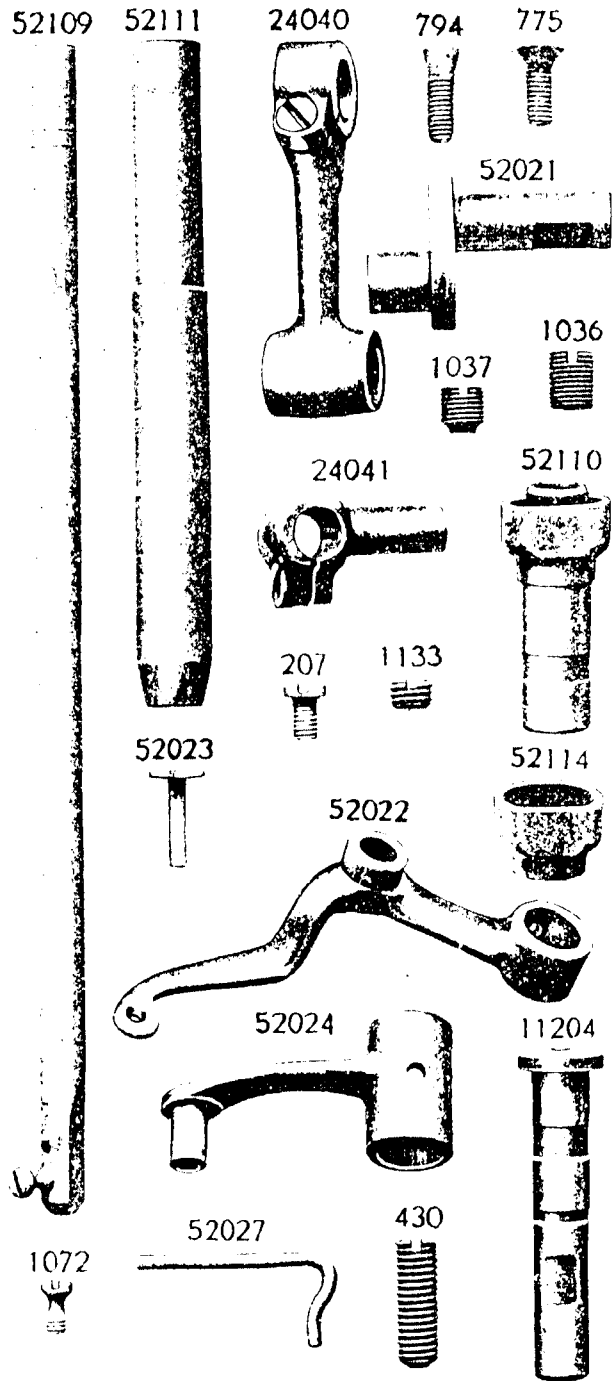

PLATE 5913—FULL SIZE

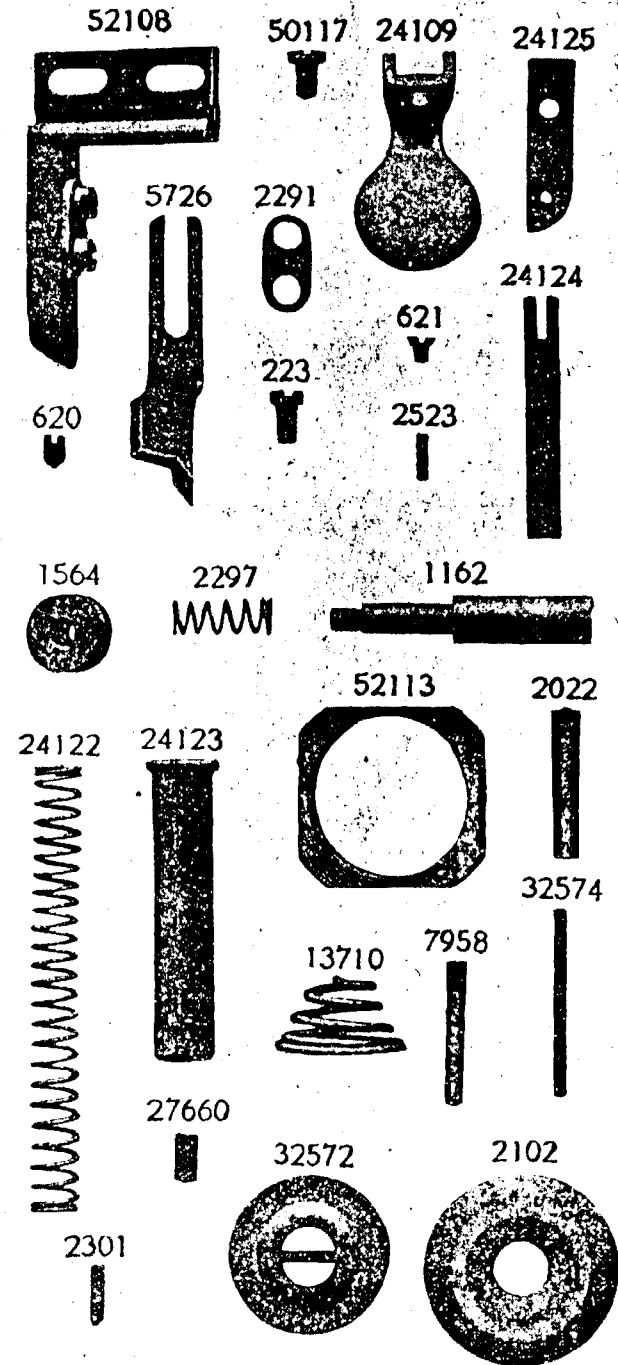



PLATE 5947—ONE-HALF SIZE

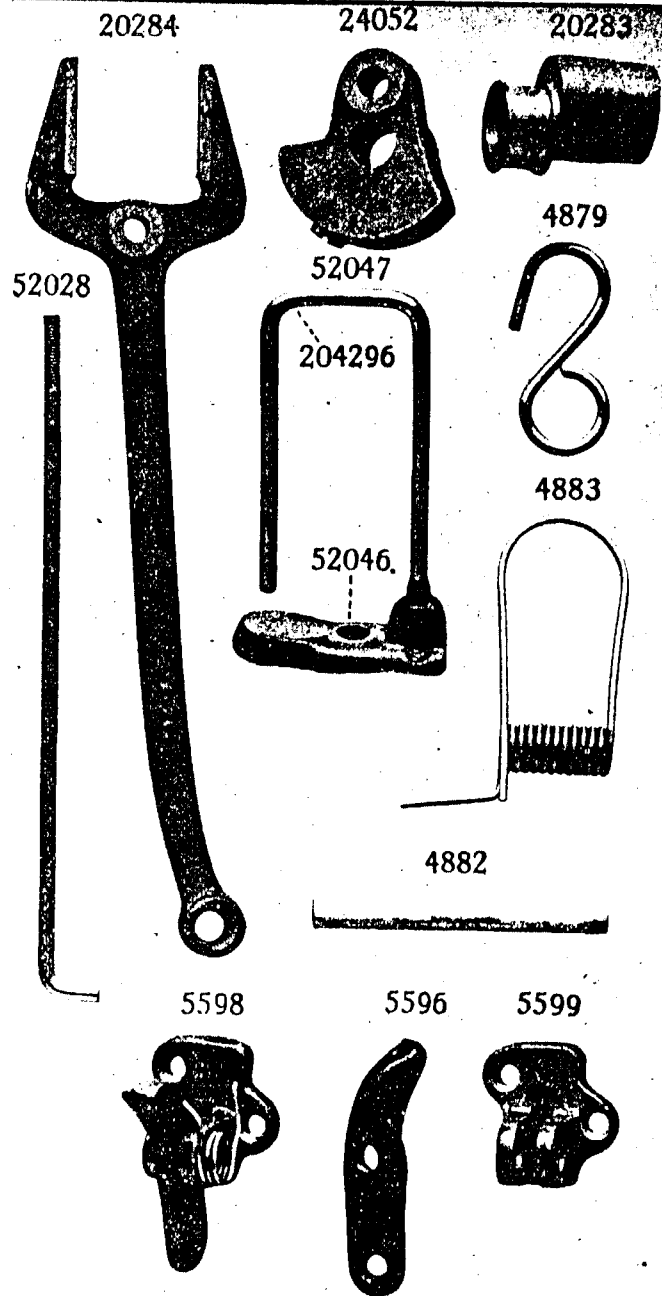

PLATE 7233—ONE-FOURTH SIZE

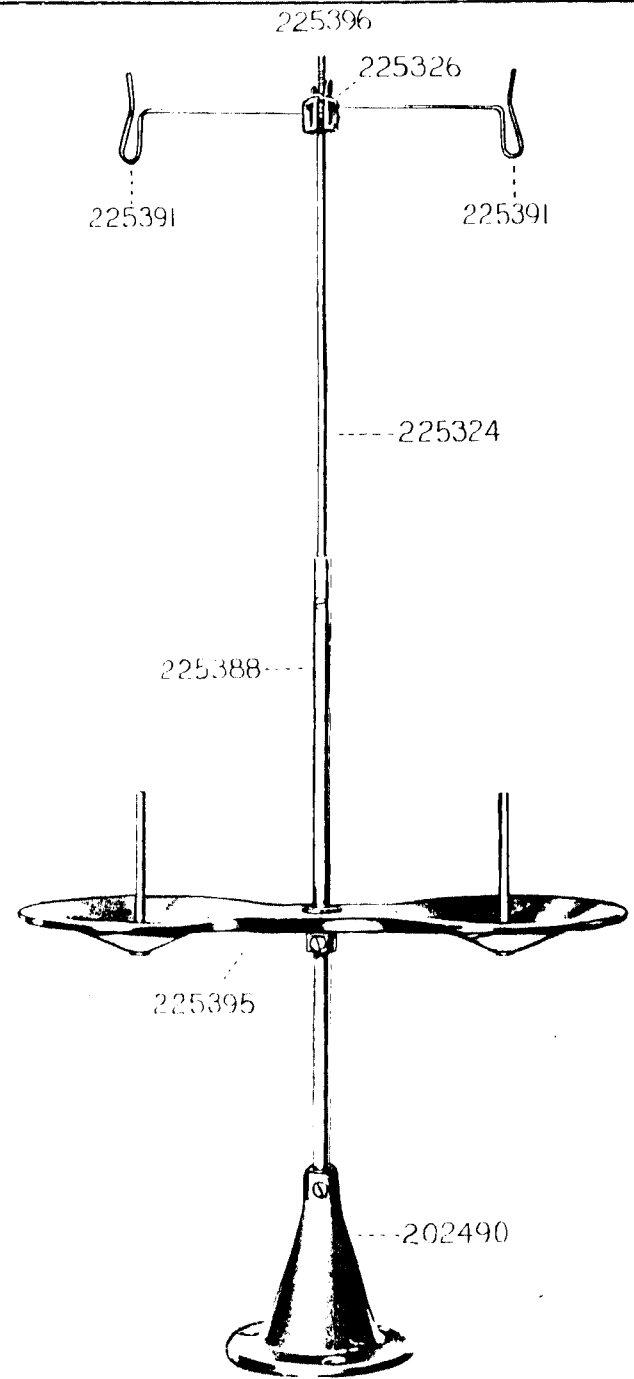

PLATE 7234—ONE-HALF SIZE

27739



225390

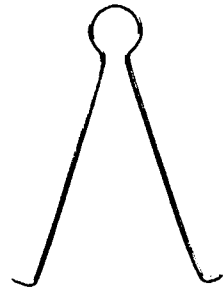

PLATE 7711—ONE-FOURTH SIZE

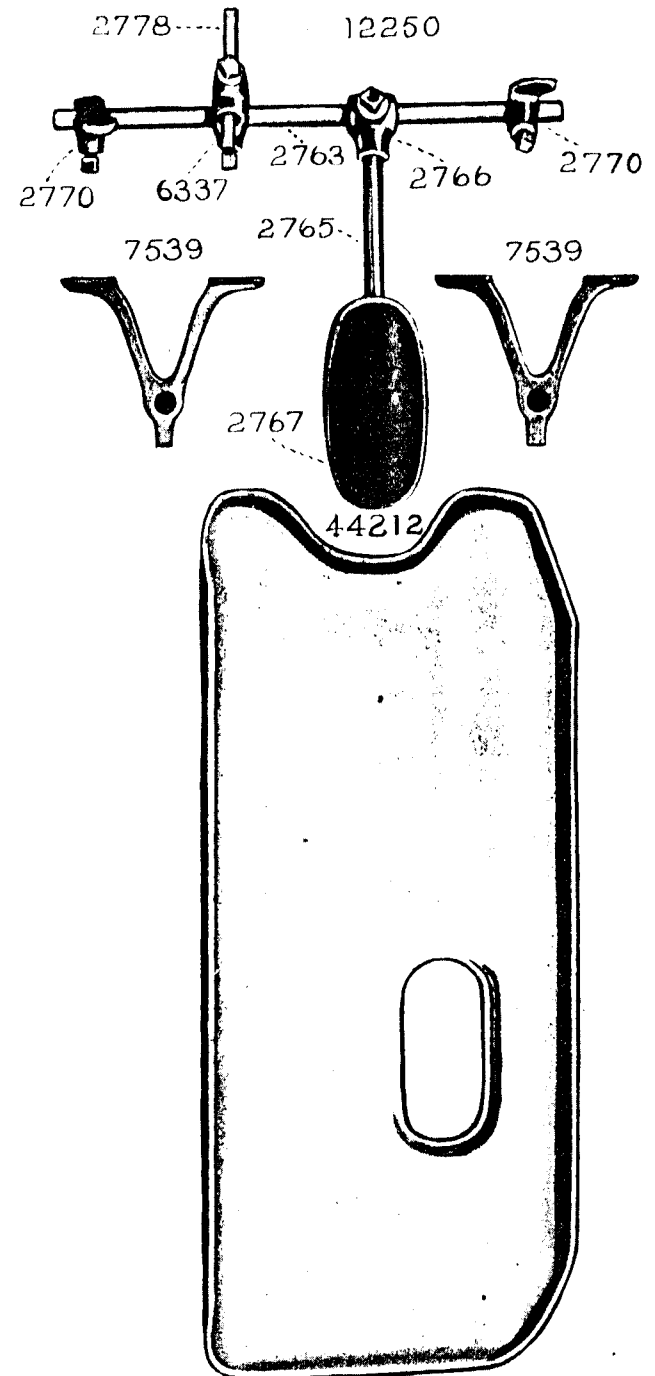

PLATE 7712—FULL SIZE

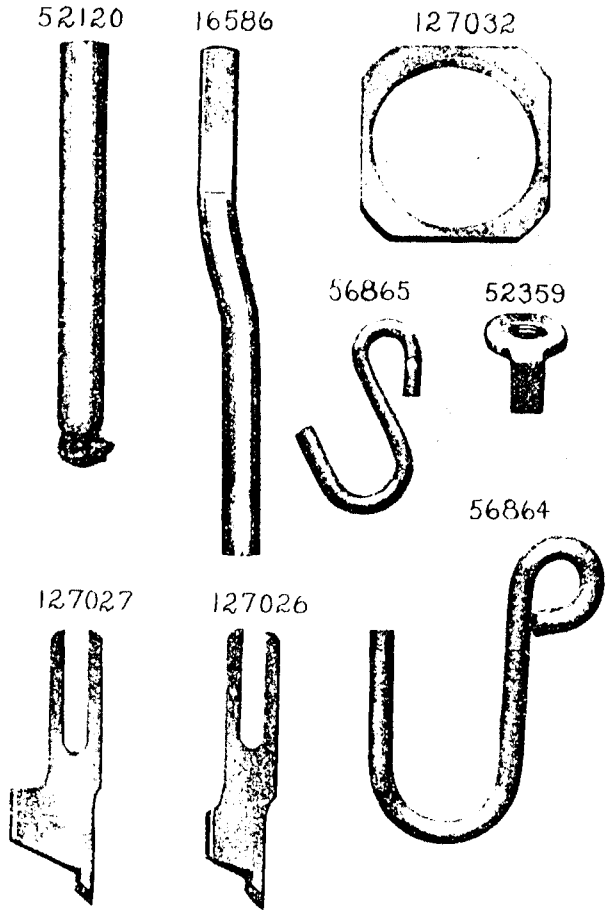

PLATE 7713—FULL SIZE

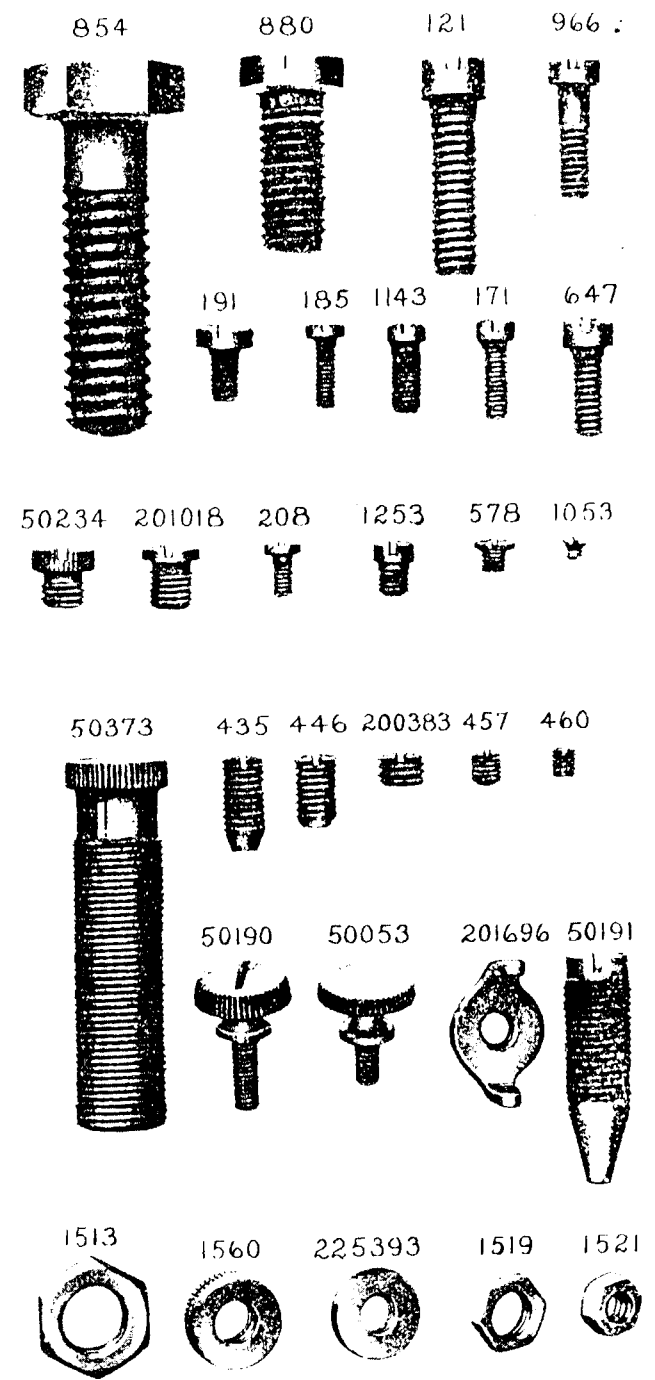



PLATE 7714—ONE-FOURTH SIZE

127024 52384 52386 52388

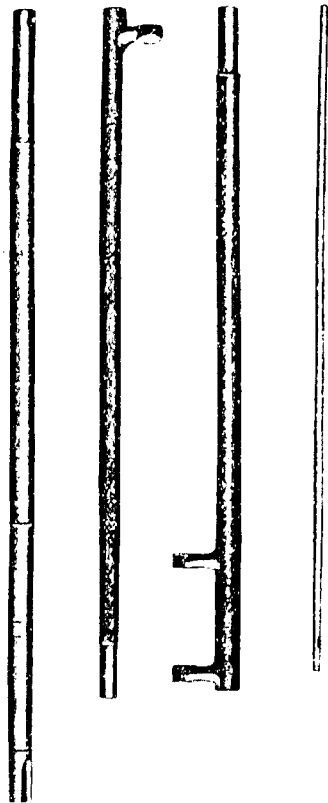
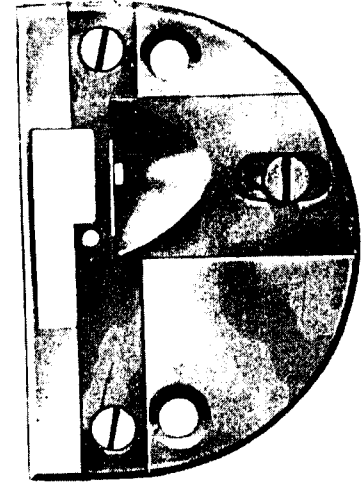

PLATE 7715—FULL SIZE

127025

127040



5730

52131



127036

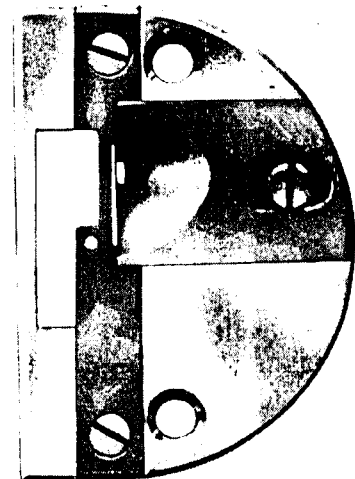

127034

127033

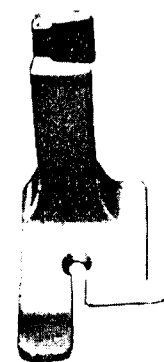

127035



PLATE 7716—ONE-HALF SIZE

20340 52104 24940 127030 24431

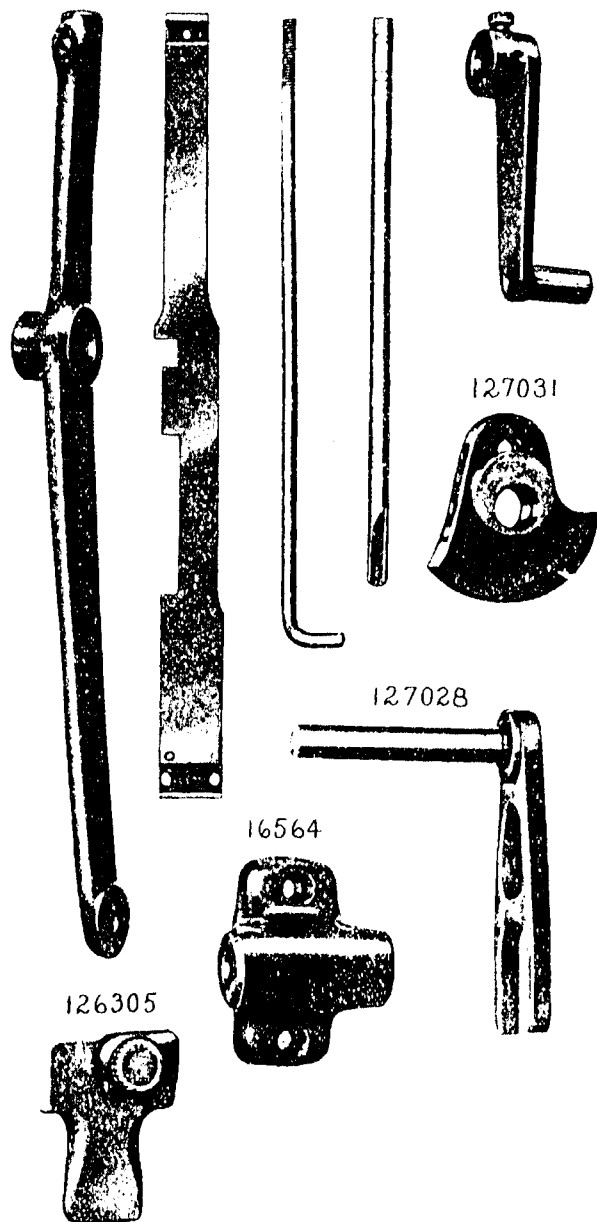

PLATE 7717—FULL SIZE

52477 52473

