

**SINGER**  
**506W2**

# LIST OF PARTS



## MACHINE No. 506w2

THE SINGER MANUFACTURING COMPANY

## INDEX

---

	PAGE
ACCESSORIES .....	14
MACHINE No. 506w2 .....	7
NUMERICAL LIST OF PARTS .....	17
STARTING TREADLE .....	14

## Instructions for Ordering

In ordering from this list, use **ONLY** the **PART** number in the **FIRST** column.

The number stamped on a Sewing Machine Part is the number of the Single Part only, except when the part includes Set Screws, Clamping Screws, Studs and Rollers Spun on, Small Wires riveted, or Parts soldered together, etc., which it is necessary to furnish in combination.

Every combination of parts sent out has its specific number which, although not stamped on Parts (except in above cases) must be used when ordering the combination.

Each number always indicates the **SAME PART** in whatever list it appears, or for whatever Machine.

The letters after some of the numbers indicate the style of finish only, as follows:

- A. Hardened, Polished and Plated.
- B. Polished and Plated.
- C. Hardened only.
- D. Polished only.
- E. Soft, not polished.
- F. Hardened and Polished.
- H. Blued.

These letters **MUST BE USED** when they appear in the list and **AFTER** the number, as in the list.

In this series

200001 to 201500 are Screw Numbers.

201501 to 201800 are Nut Numbers.

201801 to 202000 are Roller Numbers.

202001 and upward are numbers of Machine Parts.

The figures in the second column refer only to the plate in which the illustration of the part is shown and are **NOT TO BE USED** in ordering.

Two or more numbers over a cut indicate that the difference between such parts is not visible in an illustration.

Parts marked with an asterisk (\*) are furnished only when repairs are made at the factory.

## LIST OF PARTS COMPLETE

FOR

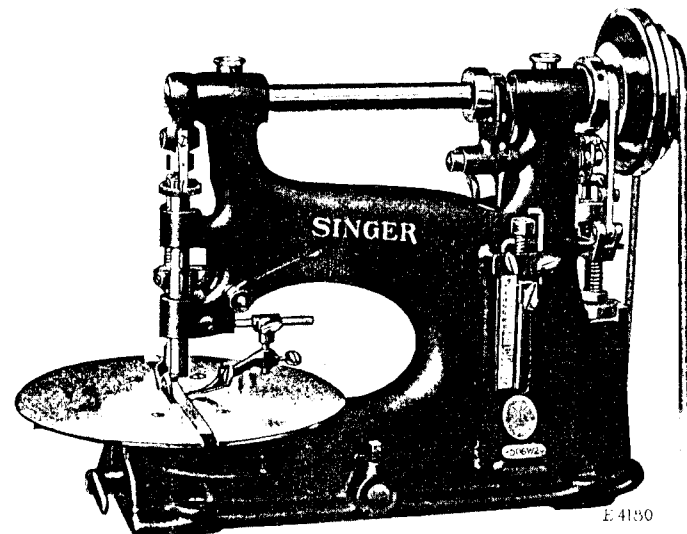

## MACHINE No. 506w2

For Perforating Designs in Shoe Vamps, Tips,  
Foxings, etc.

No.	Plate	Name
260451	14872	Auxiliary Stop Collar with 451c and 888c .....
888c	14873	Auxiliary Stop Collar Position Screw .....
451c	14873	Auxiliary Stop Collar Set Screw ..
260452	14872	" " Lever with 200100c
260453	14873	" " " Connecting Link (fork end) .....
260454	14873	Auxiliary Stop Lever Connecting Link (stud end) .....
260455	14873	Auxiliary Stop Lever Connecting Link Compensating Spring ....
350019c	14873	Auxiliary Stop Lever Connecting Link Compensating Spring Adjusting Screw .....
260457	14873	Auxiliary Stop Lever Connecting Link Compensating Spring Collar

No.	Plate	Name
260490	14873	Auxiliary Stop Lever Connecting Link Compensating Spring Collar Position Pin .....
260458	—	Auxiliary Stop Lever Connecting Link (compensating) complete, Nos. 260453 to 260455, 260457, 260490 and 350019c .....
260459	14873	Auxiliary Stop Lever Connecting Link Hinge Pin .....
200131c	14873	Auxiliary Stop Lever Connecting Link Hinge Pin Set Screw ....
350020F	14873	Auxiliary Stop Lever Connecting Link Hinge Screw .....
201525E	14873	Auxiliary Stop Lever Connecting Link Hinge Screw Nut .....
260461	14873	Auxiliary Stop Lever Hinge Pin ..
200100c	14873	" " " " " " Set Screw .....
260462	14872	Driving Flange with 260463 .....
260463	14873	" " Pin .....
260258	14873	" " Position Pin .....
260464	14874	" Pulley (grooved), three speed, 4, 5 and 6 in. diam., with 213944, 223847 and 260465 .....
260465	14874	Driving Pulley Friction Ring ....
213944	14873	" " " " " " Position Pin .....
223847	—	Driving Pulley Oil Packing (wick)
260260	14874	" Shaft .....
202260	—	" " Oil Packing (wick) (2)
200502B	14873	" " " " Thumb Screw (2) .....
202260	—	Driving Shaft Oil Wick .....
350003F	14873	" " Screw .....
260070	14873	" " Washer .....
260261	14872	Edge Guide with 350011B and 350012B .....
260262	14872	Edge Guide Bracket with 350011B
260264	14872	" " " Support .....
200347C	14873	" " " " Set Screw
350011B	14873	" " " Thumb Screw ..
260266	14873	" " Finger .....
350012B	14873	" " Thumb Screw ..
350011B	14873	" " Thumb Screw .....
260273	14872	Feed Compensating Lever with 349c .....
349c	14873	Feed Compensating Lever Set Screw .....

No.	Plate	Name
260274	14874	Feed Compensating Lever Shaft
260275	14874	" " " "
		Bracket .....
342c	14873	Feed Compensating Lever Shaft Bracket Set Screw .....
204246	14873	Feed Compensating Lever Shaft Collar with two 200383c .....
200383c	14873	Feed Compensating Lever Shaft Collar Set Screw .....
260276	14872	Feed Compensating Lever Shaft Crank with 349c .....
260277	14872	Feed Compensating Lever Shaft Crank Connection with 200347c, 201516E, 260439 and 350017c ....
200347c	14873	Feed Compensating Lever Shaft Crank Connection Set Screw ..
350017c	14873	Feed Compensating Lever Shaft Crank Connection Stud .....
201516E	14873	Feed Compensating Lever Shaft Crank Connection Stud Nut ....
260439	14873	Feed Compensating Lever Shaft Crank Connection Stud Washer
349c	14873	Feed Compensating Lever Shaft Crank Set Screw .....
260278	14875	Feed Compensating Position Stop (lower) .....
260279	14875	Feed Compensating Position Stop (upper) .....
350011B	14873	Feed Compensating Position Stop Thumb Screw (2) .....
260280	14872	Feed Dog .....
260281	14872	" " Bracket with 349c .....
349c	14873	" " " Set Screw .....
200036E	14875	" " Screw .....
210805	14875	" " Washer .....
260282	14874	" Driving Connection with 200341c .....
260283	14874	Feed Driving Connection Fork Lever .....
260466	14874	Feed Driving Connection Fork Lever Shaft .....
204246	14873	Feed Driving Connecting Fork Lever Shaft Collar with two 200383c .....
200383c	14873	Feed Driving Connection Fork Lever Shaft Collar Set Screw ..
342c	14873	Feed Driving Connection Fork Lever Shaft Set Screw .....

No.	Plate	Name
260285	14875	Feed Driving Connection Hinge Pin
200341c	14875	" " " " "
		Set Screw .....
260286	14874	Feed Driving Rock Shaft .....
204246	14873	" " " " Collar with two 200383c (2) .....
200383c	14873	Feed Driving Rock Shaft Collar Set Screw .....
260287	14875	Feed Driving Rock Shaft Slide Block .....
260289	14872	Feed Driving Rock Shaft Slide Block Crank with 350018c .....
260290	—	Feed Driving Rock Shaft Slide Block Crank 260289 with 201517E, 260287 and 350013c .....
350018c	14875	Feed Driving Rock Shaft Slide Block Crank Set Screw .....
350013c	14875	Feed Driving Rock Shaft Slide Block Hinge Screw .....
201517E	14875	Feed Driving Rock Shaft Slide Block Hinge Screw Nut .....
260291	14876	Feed Eccentric .....
260258	14873	" " Position Pin .....
260293	14876	" Lifting Connection .....
260294	14876	" " " Fork Lever ..
350013c	14875	" " " Hinge Screw (2) .....
260295	14874	Feed Lifting Frame .....
260296	14875	" Regulating Index Pin .....
260435	14875	" " " Plate .....
200583H	14875	" " " " Screw (2) .....
260297	14876	Feed Regulating Lever .....
260430	—	" " " 260297 with 201517E, 260287 and 350013c ...
260298	14876	Feed Regulating Lever Shaft .....
260299	14875	" " " " Spring (lower) .....
260432	14875	Feed Regulating Lever Shaft Spring (upper) .....
260300	14875	Feed Regulating Lever Shaft Spring (upper) Collar with two 200374c .....
200374c	14875	Feed Regulating Lever Shaft Spring (upper) Collar Set Screw
260287	14875	Feed Regulating Lever Slide Block
350013c	14875	" " " " " " Hinge Screw .....
201517E	14875	Feed Regulating Lever Slide Block Hinge Screw Nut .....

No.	Plate	Name
200729A	14875	Feed Regulating Lever Thumb Screw .....
*260467	—	Frame .....
260468	14876	Machine Starting Lever with 200131c, 200282E, 201526E and 350037c .....
203250	14875	Machine Starting Lever Position Collar with two 200393c .....
200393c	14875	Machine Starting Lever Position Collar Set Screw .....
260469	14876	Machine Starting Lever Spring
200282E	14875	" " " " " Screw .....
200527c	14875	Machine Starting Lever Stop Screw
260470	14875	" " " " " Bracket with 200527c and 201531E
200027D	14880	Machine Starting Lever Stop Screw Bracket Screw (2) .....
201531E	14880	Machine Starting Lever Stop Screw Nut .....
260408	14876	Punch Bar .....
260409	14876	" " Driving Connection with 200341c, 201522E and 215170 ....
260433	14877	Punch Bar Driving Connection Hinge Pin .....
200341c	14875	Punch Bar Driving Connection Hinge Pin Set Screw .....
201522E	14880	Punch Bar Driving Connection Hinge Pin Set Screw Check Nut
260410	14876	Punch Bar Driving Crank .....
260077	14877	" " Position Stud .....
200374c	14875	" " " " Set Screw
350014c	14877	" " Regulating Thumb Screw .....
201698c	14877	Punch Bar Regulating Thumb Screw Lock Nut .....
260443	14877	Punch Bar Regulating Thumb Screw Position Spring .....
215170	14877	Punch Bar Regulating Thumb Screw Position Spring Pin .....
200113F	14877	Punch Bar Regulating Thumb Screw Position Spring Screw ...
260414	14881	Punch Block (brass) .....
350015E	14877	" " Set Screw .....
302001	14877	Punch Holder complete .....
201909	14877	Roller Presser, $\frac{3}{8}$ in. diam., $\frac{3}{8}$ in. face (coarse) with 200551c and 201534H .....

No.	Plate	Name
204579	14877	Roller Presser Arm .....
204580	—	“ “ “ 204579 with 201909 .....
200074F	14877	Roller Presser Arm Screw .....
203958	14878	“ “ Bar with 200074F ...
260417	14878	“ “ “ Lifter with 200352c
200352c	14877	“ “ “ Set Screw..
260418	14877	“ “ “ Lifting Bracket with 200374c and 201007c .....
201007c	14877	Roller Presser Bar Lifting Bracket Set Screw .....
260419	14878	Roller Presser Bar Lifting Lever with 200341c .....
200341c	14875	Roller Presser Bar Lifting Lever Set Screw .....
260420	14878	Roller Presser Bar Lifting Lever Shaft .....
205976	14877	Roller Presser Bar Spring .....
225832	14877	“ “ “ Adjusting Collar with 200113F .....
200113F	14877	Roller Presser Bar Spring Adjust- ing Collar Set Screw .....
200551c	14877	Roller Presser Hinge Screw .....
201534H	14877	“ “ “ “ Nut ..
260421	14877	“ “ Position Stud .....
200374c	14875	“ “ “ Set Screw
260486	14879	Starting Treadle Pitman Rod (up- per) with 202302 .....
202302	14877	Starting Treadle Pitman Rod (up- per) Cotter Pin .....
227625	14877	Starting Treadle Pitman Rod Col- lar with 200113F .....
200113F	14877	Starting Treadle Pitman Rod Col- lar Set Screw .....
206628	14880	Starting Treadle Pitman Rod Spring .....
260471	14878	Stop Cam with 260489 .....
260489	14880	“ “ Pin .....
260472	14880	“ “ Roller (5) .....
260473	14880	“ “ Spring .....
260474	14878	“ Lever with 200100c and 200108F
260475	14878	“ “ Bracket with 200522c and 201513E .....
260476	14878	Stop Lever Bracket Cushion Spring
350021c	14878	“ “ “ “ “ Adjusting Screw .....
201677c	14878	Stop Lever Bracket Cushion Spring Adjusting Screw Nut .....
200363c	14880	Stop Lever Bracket Cushion Spring Adjusting Screw Set Screw ....

No.	Plate	Name
200374c	14875	Stop Lever Bracket Cushion Spring Adjusting Screw Set Screw ....
260479	14880	Stop Lever Bracket Cushion Spring Adjusting Screw Set Screw Pack- ing (brass) .....
260480	14880	Stop Lever Bracket Position Spring
260481	14878	“ “ “ Rod .....
260482	14878	“ “ “ “ Guide Brack- et with 260488 .....
260488	14880	Stop Lever Bracket Rod Guide Bracket Position Pin .....
200036D	14875	Stop Lever Bracket Rod Guide Bracket Screw .....
200522c	14880	Stop Lever Bracket Set Screw ....
201513E	14880	“ “ “ “ “ Lock Nut .....
260483	14880	Stop Lever Connecting Link .....
260484	14880	“ “ “ “ Hinge Pin .....
200108F	14880	Stop Lever Connecting Link Hinge Pin Set Screw .....
350037c	14880	Stop Lever Connecting Link Hinge Screw .....
201526E	14880	Stop Lever Connecting Link Hinge Screw Nut .....
260461	14873	Stop Lever Hinge Pin .....
200100c	14873	“ “ “ “ Set Screw..
260426	14881	Work Plate (back) .....
260427	14881	“ “ (front) .....
350016B	14880	“ “ Screw (4) .....

## ACCESSORIES

No.	Plate	Name
260493	14879	Feed Compensating Knee Lever with 201007c .....
260494	14879	Feed Compensating Knee Lever Bracket with two wood screws 1½ in., No. 12 .....
260270	14880	Feed Compensating Knee Lever Hinge Pin .....
260495	14879	Feed Compensating Knee Lever Rod .....
227227	14880	Feed Compensating Knee Lever Rod Collar with 200113r .....
200113r	14877	Feed Compensating Knee Lever Rod Collar Set Screw .....
201007c	14877	Feed Compensating Knee Lever Set Screw .....
260496	—	Feed Compensating Knee Lever complete, Nos. 260270, 260493 to 260495 and two 227227 .....
36565	14882	Oiler (copper plated) with 36566..
36566	14882	" Spout, 9 in. long, with 120117
120117	—	" " Washer (leather) .....
260416	14882	Punch Holder Wrench .....
*225484	—	Screw Driver Blade .....
*225485	—	" " Handle .....
225498	14882	Screw Driver complete (7½ in. long), Nos. 225484 and 225485 ..
260422	14879	Shaft Pulley (sectional, grooved), three speed, 4½, 5½ and 6½ in. belt diam., with two 944c .....
944c	14880	Shaft Pulley Clamping Screw .... Four wood screws 1½ in., No. 14 ..

### STARTING TREADLE

260491	14879	Starting Treadle with 350005E ....
204128	14879	" " Stand with two wood screws 1 in., No. 13 .....
260492	—	Starting Treadle complete, Nos. 260491 and two 204128 .....
260485	14879	Starting Treadle Pitman Rod (center) .....
227956	14879	Starting Treadle Pitman Rod (lower) .....

No.	Plate	Name
204126	14880	Starting Treadle Pitman Rod Clamp with two 200530c .....
200530c	14880	Starting Treadle Pitman Rod Clamp Set Screw .....
260487	—	Starting Treadle Pitman Rod 260485 with 227956 and three 204126 ..
350005E	14880	Starting Treadle Screw Eye .....

## NUMERICAL LIST OF PARTS

FOR

**MACHINE No. 506w2**

## NUMERICAL LIST OF PARTS

No.	Plate	Name
342c	14873	Feed Compensating Lever Shaft Bracket Set Screw .....
342c	14873	Feed Driving Connection Fork Lever Shaft Set Screw .....
349c	14873	Feed Compensating Lever Set Screw, for 260273 .....
349c	14873	Feed Compensating Lever Shaft Crank Set Screw, for 260276 ..
349c	14873	Feed Dog Bracket Set Screw, for 260281 .....
451c	14873	Auxiliary Stop Collar Set Screw, for 260451 .....
888c	14873	Auxiliary Stop Collar Position Screw, for 260451 .....
944c	14880	Shaft Pulley Clamping Screw, for 260422 .....
36565	14882	Oil Spout (copper plated) with 36566.
36566	14882	" Spout, 9 in. long, with 120117, for 36565 .....
120117		Oil Spout Washer (leather), for 36566 .....
90027d	14880	Machine Starting Lever Stop Screw Bracket Screw .....
90036f	14873	Feed Dog Screw .....
90036d	14873	Stop Lever Bracket Rod Guide Bracket Screw .....
90074f	14877	Roller Presser Arm Screw, for 203958 .....
90090c	14873	Auxiliary Stop Lever Hinge Pin Set Screw, for 260452 .....
90090c	14873	Stop Lever Hinge Pin Set Screw, for 260474 .....
90090f	14880	Stop Lever Connecting Link Hinge Pin Set Screw, for 260474 .....
900113f	14877	Feed Compensating Knee Lever Rod Collar Set Screw, for 227227 .....
900113f	14877	Punch Bar Regulating Thumb Screw Position Spring Screw ..
900113f	14877	Roller Presser Bar Spring Adjusting Collar Set Screw, for 225832 .....
900113f	14877	Starting Treadle Pitman Rod Collar Set Screw, for 227625 .....
900113c	14873	Auxiliary Stop Lever Connecting Link Hinge Pin Set Screw, for 260468 .....



No.	Plate	Name
200282e	14875	Machine Starting Lever Spring Screw, for 260468 .....
200341c	14875	Feed Driving Connection Hinge Pin Set Screw, for 260282 .....
200341c	14875	Punch Bar Driving Connection Hinge Pin Set Screw, for 260409 .....
200341c	14875	Roller Presser Bar Lifting Lever Set Screw, for 260412 .....
200347c	14873	Edge Guide Bracket Support Set Screw .....
200347c	14873	Feed Compensating Lever Shaft Crank Connection Set Screw, for 260277 .....
200352c	14877	Roller Presser Bar Lifter Set Screw, for 260417 .....
200363c	14880	Stop Lever Bracket Cushion Spring Adjusting Screw Set Screw ..
200374c	14875	Feed Regulating Lever Shaft Spring (upper) Collar Set Screw, for 260300 .....
200374c	14875	Punch Bar Position Stud Set Screw .....
200374c	14875	Roller Presser Position Stud Set Screw, for 260418 .....
200374c	14875	Stop Lever Bracket Cushion Spring Adjusting Screw Set Screw ..
200383c	14873	Feed Compensating Lever Shaft Collar Set Screw, for 204246 ..
200383c	14873	Feed Driving Connection Fork Lever Shaft Collar Set Screw, for 204246 .....
200383c	14873	Feed Driving Rock Shaft Collar Set Screw, for 204246 .....
200393c	14875	Machine Starting Lever Position Collar Set Screw, for 203250 ..
200502b	14873	Driving Shaft Oil Packing Thumb Screw .....
200522c	14880	Stop Lever Bracket Set Screw, for 260475 .....
200527c	14875	Machine Starting Lever Stop Screw, for 260470 .....
200530c	14880	Starting Treadle Pitman Rod Clamp Set Screw, for 204126 ..
200551c	14877	Roller Presser Hinge Screw, for 201909 .....
200583h	14875	Feed Regulating Index Plate Screw .....
200729A	14875	" " Lever Thumb Screw .....
201007c	14877	" Compensating Knee Lever Set Screw, for 260493 .....
201007c	14877	Roller Presser Bar Lifting Bracket Set Screw, for 260418 .....

No.	Plate	Name
201513f	14880	Stop Lever Bracket Set Screw Lock Nut, for 260475 .....
201516f	14873	Feed Compensating Lever Shaft Crank Connection Stud Nut, for 260277 .....
201517f	14875	Feed Driving Rock Shaft Slide Block Hinge Screw Nut, for 260290 .....
201517f	14875	Feed Regulating Lever Slide Block Hinge Screw Nut, for 260430 ..
201522f	14880	Punch Bar Driving Connection Hinge Pin Set Screw Check Nut, for 260409 .....
201525f	14873	Auxiliary Stop Lever Connecting Link Hinge Screw Nut .....
201526f	14880	Stop Lever Connecting Link Hinge Screw Nut, for 260468 .....
201534f	14880	Machine Starting Lever Stop Screw Nut, for 260470 .....
201534h	14877	Roller Presser Hinge Screw Nut, for 201909 .....
201607c	14878	Stop Lever Bracket Cushion Spring Adjusting Screw Nut .....
201698c	14877	Punch Bar Regulating Thumb Screw Lock Nut .....
201909	14877	Roller Presser, $\frac{1}{2}$ in. diam., 3 in. free (coarse), with 200551c and 201534h, for 204580 .....
202260		Driving Shaft Oil Packing (wick)
202260		" " Oil Wick .....
202292	14877	Starting Treadle Pitman Rod (upper) Cotter Pin, for 260486 ..
203250	14875	Machine Starting Lever Position Collar with two 200393c .....
203908	14878	Roller Presser Bar with 200074f ..
204126	14880	Starting Treadle Pitman Rod Clamp with two 200530c, for 260487 ..
204128	14879	Starting Treadle Stand with two wood screws 1 in., No. 13, for 260492 .....
204246	14873	Feed Compensating Lever Shaft Collar with two 200383c .....
204246	14873	Feed Driving Connection Fork Lever Shaft Collar with two 200383c .....
204246	14873	Feed Driving Rock Shaft Collar with two 200383c .....
204579	14877	Roller Presser Arm, for 204580 ..
204580		" " " 204579 with 201909 .....
205976	14877	Roller Presser Bar Spring .....

No.	Plate	Name
206628	14880	Starting Treadle Pitman Rod Spring .....
210805	14875	Feed Dog Screw Washer .....
213944	14873	Driving Pulley Friction Ring Position Pin, for 260464 .....
215170	14877	Punch Bar Regulating Thumb Screw Position Spring Pin, for 260409 .....
223847	—	Driving Pulley Oil Packing (wick), for 260464 .....
*225484	—	Screw Driver Blade, for 225498 ..
*225485	—	" " Handle, for 225498 ..
225498	14882	Screw Driver complete (7½ in. long), Nos. 225484 and 225485 ..
225832	14877	Roller Presser Bar Spring Adjust-Collar with 200113F .....
227227	14880	Feed Compensating Knee Lever Rod Collar with 200113F, for 260496 .....
227625	14877	Starting Treadle Pitman Rod Collar with 200113F .....
227956	14879	Starting Treadle Pitman Rod (lower), for 260487 .....
260070	14873	Driving Shaft Screw Washer ....
260077	14877	Punch Bar Position Stud .....
260258	14873	Driving Flange Position Pin .....
260258	14873	Feed Eccentric Position Pin .....
260260	14874	Driving Shaft .....
260261	14872	Edge Guide with 350011B and 350012B .....
260262	14872	Edge Guide Bracket with 350011B .....
260264	14872	" " " Support .....
260266	14873	" " Finger .....
260270	14880	Feed Compensating Knee Lever Hinge Pin, for 260496 .....
260273	14872	Feed Compensating Lever with 349c .....
260274	14874	Feed Compensating Lever Shaft .....
260275	14874	" " " " " Bracket .....
260276	14872	Feed Compensating Lever Shaft Crank with 349c .....
260277	14872	Feed Compensating Lever Shaft Crank Connection with 200347c, 201516E, 260439 and 350017c ....
260278	14875	Feed Compensating Position Stop (lower) .....
260279	14875	Feed Compensating Position Stop (upper) .....

No.	Plate	Name
260280	14872	Feed Dog .....
260281	14872	" " Bracket with 349c .....
260282	14874	" Driving Connection with 200341c .....
260283	14874	Feed Driving Connection Fork Lever .....
260285	14875	Feed Driving Connection Hinge Pin .....
260286	14874	" " Rock Shaft .....
260287	14875	" " " " Slide Block, for 260290 .....
260287	14875	Feed Regulating Lever Slide Block, for 260430 .....
260289	14872	Feed Driving Rock Shaft Slide Block Crank with 350018c, for 260290 .....
260290	—	Feed Driving Rock Shaft Slide Block Crank 260289 with 201517E, 260287 and 350013c .....
260291	14876	Feed Eccentric .....
260293	14876	" Lifting Connection .....
260294	14876	" " " Fork Lever ..
260295	14874	" " Frame .....
260296	14875	" Regulating Index Pin .....
260297	14876	" " Lever, for 260430 ...
260298	14876	" " " Shaft .....
260299	14875	" " " " Spring (lower) .....
260300	14875	Feed Regulating Lever Shaft Spring (upper) Collar with two 200374c .....
260408	14876	Punch Bar .....
260409	14876	" " Driving Connection with 200341c, 201522E and 215170 ....
260410	14876	Punch Bar Driving Crank .....
260414	14881	" Block (brass) .....
260416	14882	" Holder Wrench .....
260417	14878	Roller Presser Bar Lifter with 200352c .....
260418	14877	Roller Presser Bar Lifting Bracket with 200374c and 201007c .....
260419	14878	Roller Presser Bar Lifting Lever with 200341c .....
260420	14878	Roller Presser Bar Lifting Lever Shaft .....
260421	14877	Roller Presser Position Stud .....
260422	14879	Shaft Pulley (sectional, grooved), three speed, 4½, 5½ and 6½ in. belt diam., with two 944c .....

No.	Plate	Name
260426	14881	Work Plate (back) .....
260427	14881	" " (front) .....
260430	—	Feed Regulating Lever 260297 with 201517E, 260287 and 350013C .....
260432	14875	Feed Regulating Lever Shaft Spring (upper) .....
260433	14877	Punch Bar Driving Connection Hinge Pin .....
260435	14875	Feed Regulating Index Plate .....
260439	14873	" Compensating Lever Shaft Crank Connection Stud Washer, for 260277 .....
260443	14877	Punch Bar Regulating Thumb Screw Position Spring .....
260451	14872	Auxiliary Stop Collar with 451C and 888C .....
260452	14872	Auxiliary Stop Lever with 200100C
		Nos. 260453 to 260455, for 260458.
260453	14873	Auxiliary Stop Lever Connecting Link (fork end) .....
260454	14873	Auxiliary Stop Lever Connecting Link (stud end) .....
260455	14873	Auxiliary Stop Lever Connecting Link Compensating Spring .....
260457	14873	Auxiliary Stop Lever Connecting Link Compensating Spring Col- lar, for 260458 .....
260458	—	Auxiliary Stop Lever Connecting Link (compensating) complete, Nos. 260453 to 260455, 260457, 260490 and 350019C .....
260459	14873	Auxiliary Stop Lever Connecting Link Hinge Pin .....
260461	14873	Auxiliary Stop Lever Hinge Pin ..
260461	14873	Stop Lever Hinge Pin .....
260462	14872	Driving Flange with 260463 .....
260463	14873	" " Pin, for 260462 .....
260464	14874	" Pulley (grooved), three speed, 4, 5 and 6 in. diam., with 213944, 223847 and 260465 .....
260465	14874	Driving Pulley Friction Ring, for 260464 .....
260466	14874	Feed Driving Connection Fork Lev- er Shaft .....
*260467	—	Frame .....
260468	14876	Machine Starting Lever with 200131C, 200282E, 201526E and 350037C .....

No.	Plate	Name
260469	14876	Machine Starting Lever Spring ...
260470	14875	" " " Stop Screw Bracket with 200527C and 201531E
260471	14878	Stop Cam with 260489 .....
260472	14880	" " Roller .....
260473	14880	" " Spring .....
260474	14878	" Lever with 200100C and 200108F
260475	14878	" " Bracket with 200522C and 201513E .....
260476	14878	Stop Lever Bracket Cushion Spring
260479	14880	" " " " " " Adjusting Screw Set Screw Pack- ing (brass) .....
260480	14880	Stop Lever Bracket Position Spring
260481	14878	" " " Rod .....
260482	14878	" " " " Guide Brack- et with 260488 .....
260483	14880	Stop Lever Connecting Link .....
260484	14880	" " " " Hinge Pin .....
260485	14879	Starting Treadle Pitman Rod (cen- ter), for 260487 .....
260486	14879	Starting Treadle Pitman Rod (up- per) with 202302 .....
260487	—	Starting Treadle Pitman Rod 260485 with 227956 and three 204126 ..
260488	14880	Stop Lever Bracket Rod Guide Bracket Position Pin, for 260482
260489	14880	Stop Cam Pin, for 260471 .....
260490	14873	Auxiliary Stop Lever Connecting Link Compensating Spring Collar Position Pin, for 260458 .....
260491	14879	Starting Treadle with 350005E, for 260492 .....
260492	—	Starting Treadle complete, Nos. 260491 and two 204128 .....
		Nos. 260493 to 260495, for 260496.
260493	14879	Feed Compensating Knee Lever with 201007C .....
260494	14879	Feed Compensating Knee Lever Bracket with two wood screws 1½ in., No. 12 .....
260495	14879	Feed Compensating Knee Lever Rod .....
260496	—	Feed Compensating Knee Lever complete, Nos. 260270, 260493 to 260495 and two 227227 .....
302001	14877	Punch Holder complete .....

## Numerical List of Parts

No.	Plate	Name
350003F	14873	Driving Shaft Screw .....
350005E	14880	Starting Treadle Screw Eye, for 260491 .....
350011B	14873	Edge Guide Bracket Thumb Screw, for 260262 .....
350011B	14873	Edge Guide Thumb Screw, for 260261 .....
350011B	14873	Feed Compensating Position Stop Thumb Screw .....
350012B	14873	Edge Guide Finger Thumb Screw, for 260261 .....
350013C	14875	Feed Driving Rock Shaft Slide Block Hinge Screw, for 260290..
350013C	14875	Feed Lifting Connection Hinge Screw .....
350013C	14875	Feed Regulating Lever Slide Block Hinge Screw, for 260430 .....
350014C	14877	Punch Bar Regulating Thumb Screw .....
350015E	14877	Punch Block Set Screw .....
360016B	14880	Work Plate Screw .....
350017C	14873	Feed Compensating Lever Shaft Crank Connection Stud, for 260277 .....
350018C	14875	Feed Driving Rock Shaft Slide Block Crank Set Screw, for 260289
350019C	14873	Auxiliary Stop Lever Connecting Link Compensating Spring Ad- justing Screw, for 260458 .....
350020F	14873	Auxiliary Stop Lever Connecting Link Hinge Screw .....
350021C	14878	Stop Lever Bracket Cushion Spring Adjusting Screw .....
350037C	14880	Stop Lever Connecting Link Hinge Screw, for 260468 .....

PLATE 14872—FULL SIZE

260451

260462

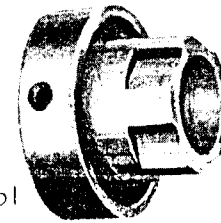

260261

260452

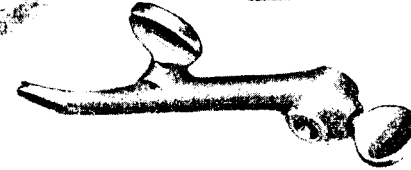

260264



260276

260262

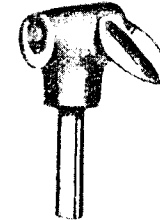
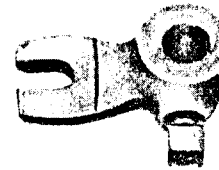

260277

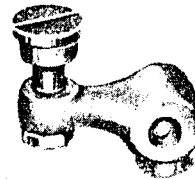
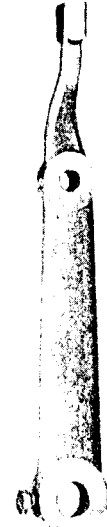

260280



260273

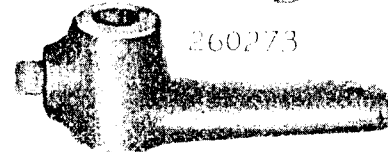

260289

260281

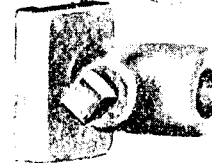
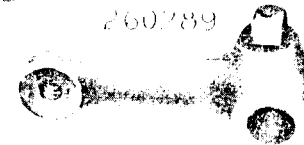

PLATE 14873—FULL SIZE

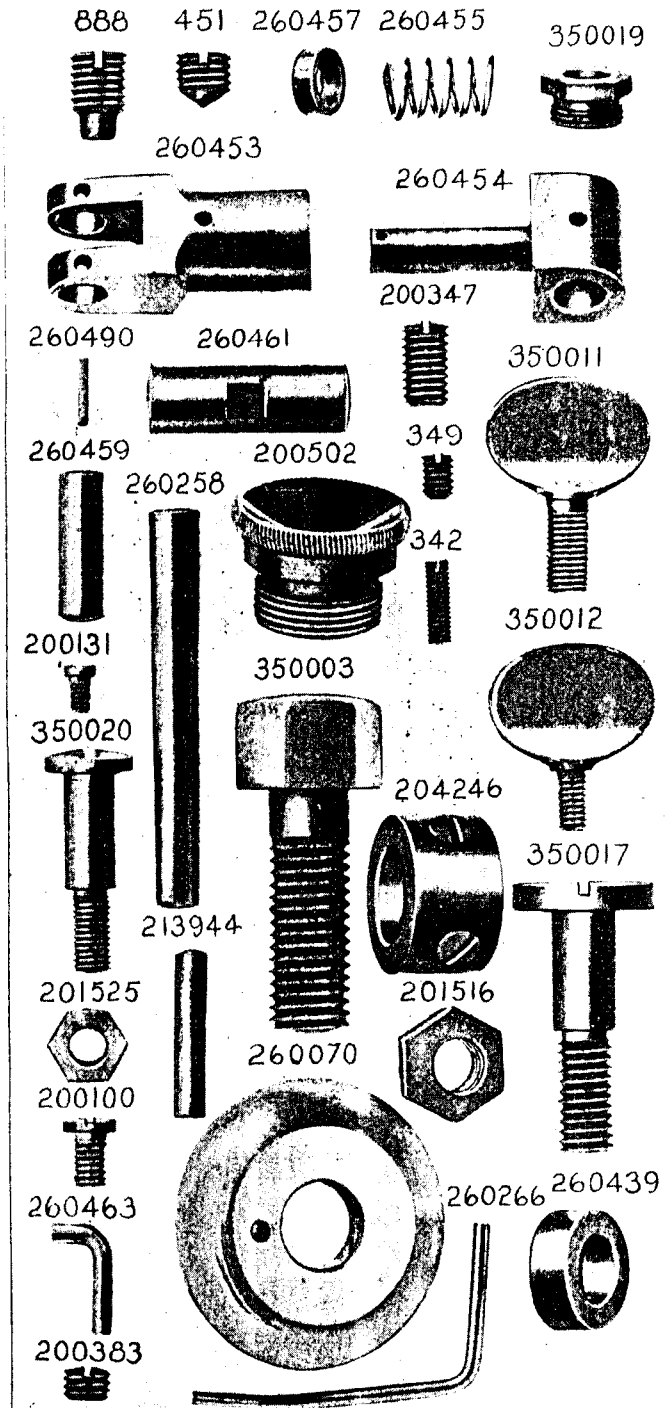

PLATE 14874—ONE-FOURTH SIZE

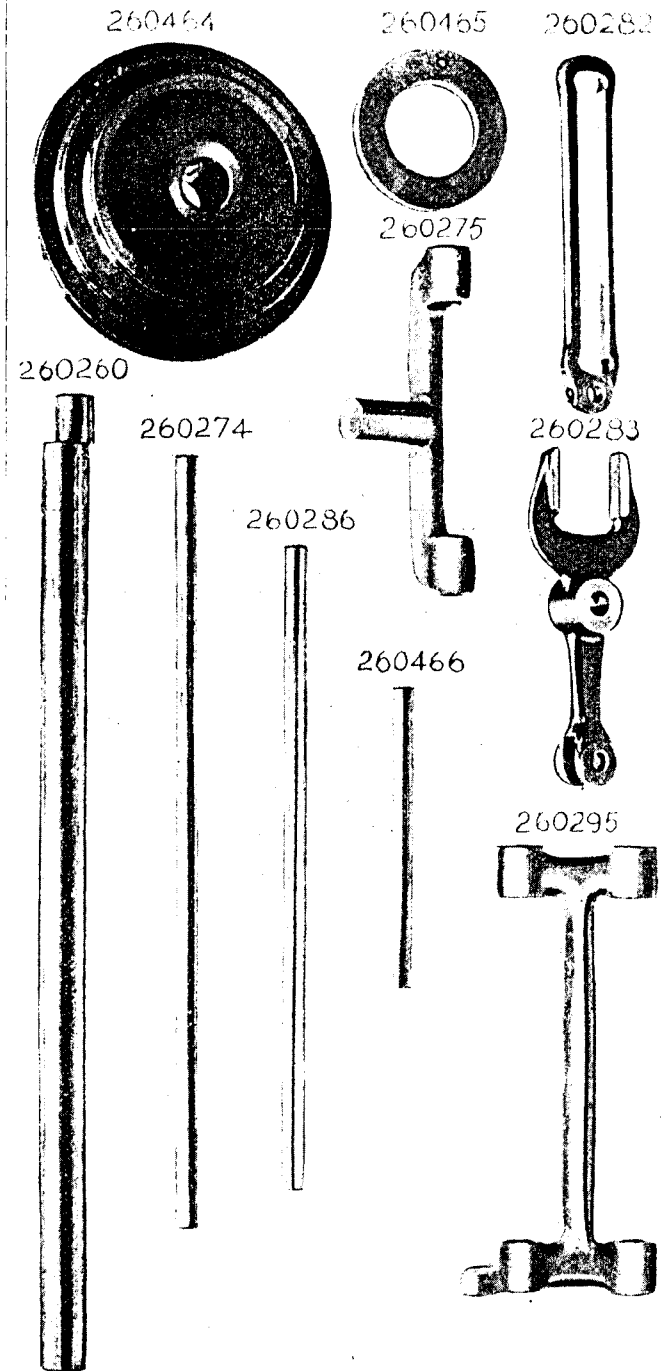

PLATE 14875-FULL SIZE

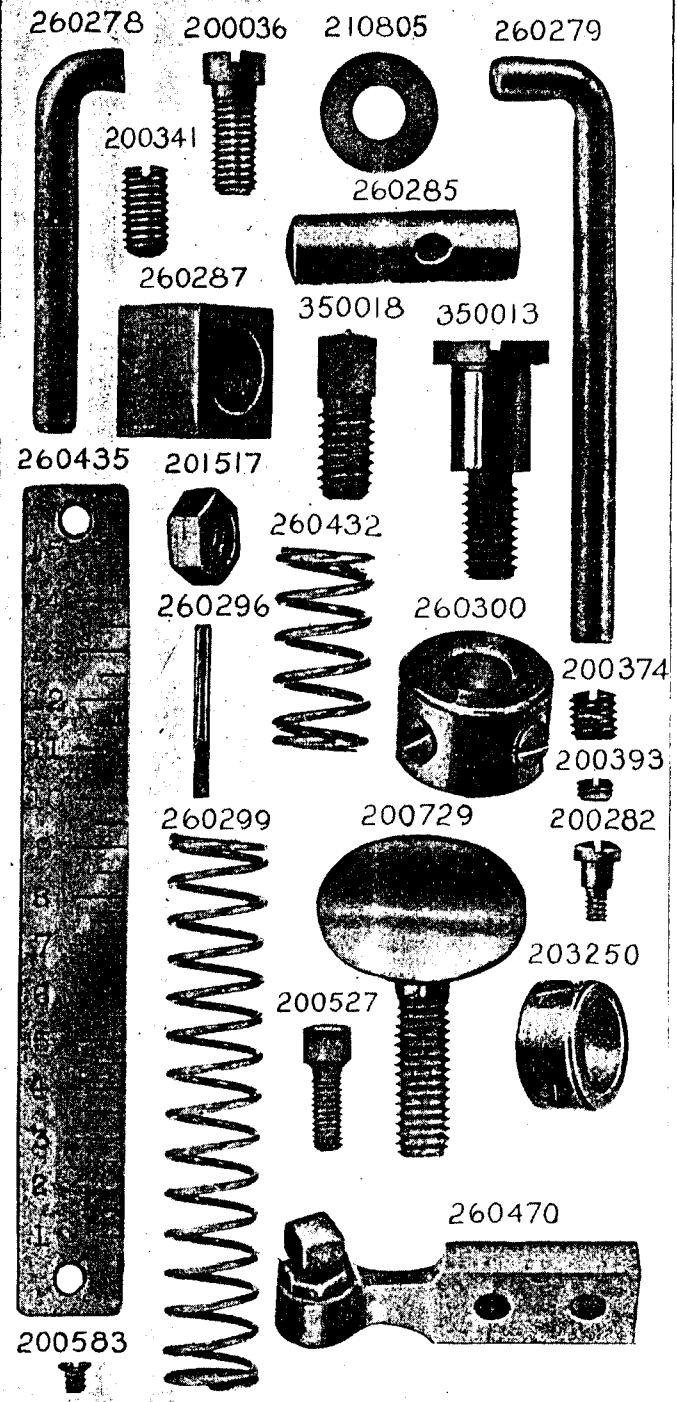

PLATE 14876-ONE-HALF SIZE

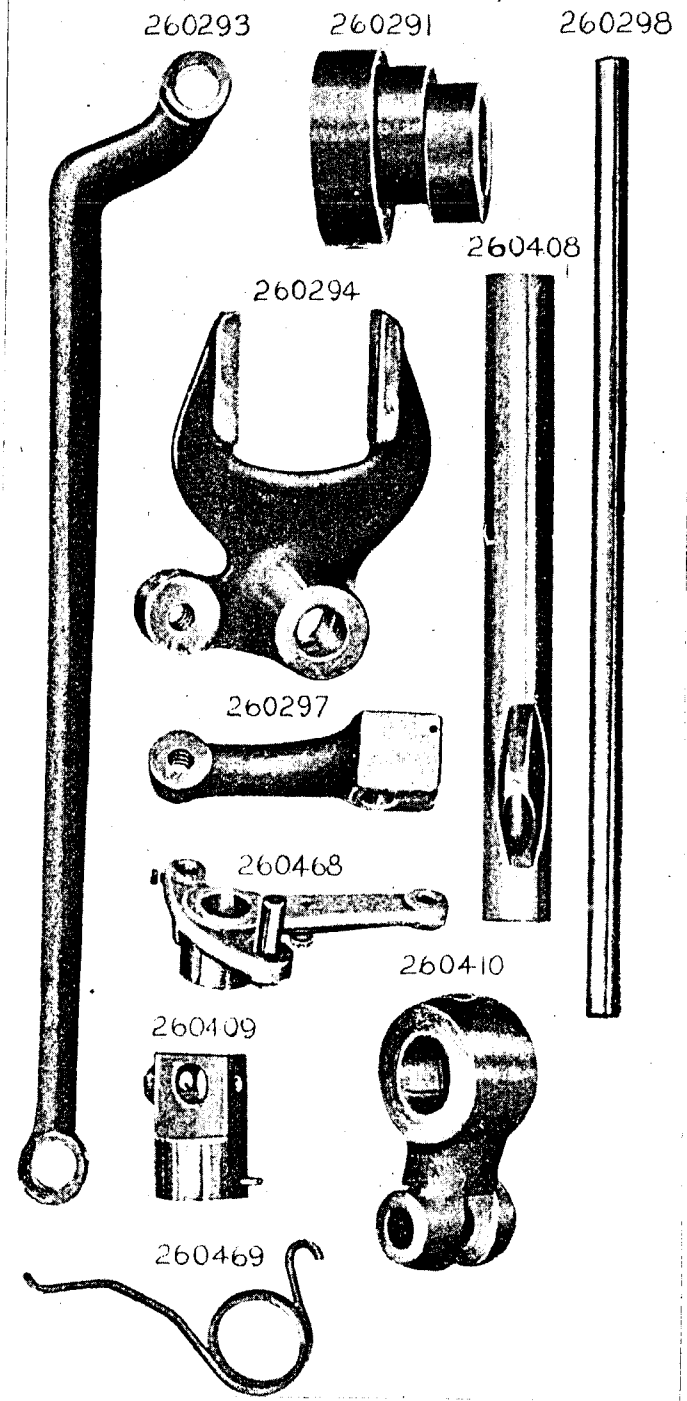

PLATE 14877—FULL SIZE

260443 260433 215170 350015

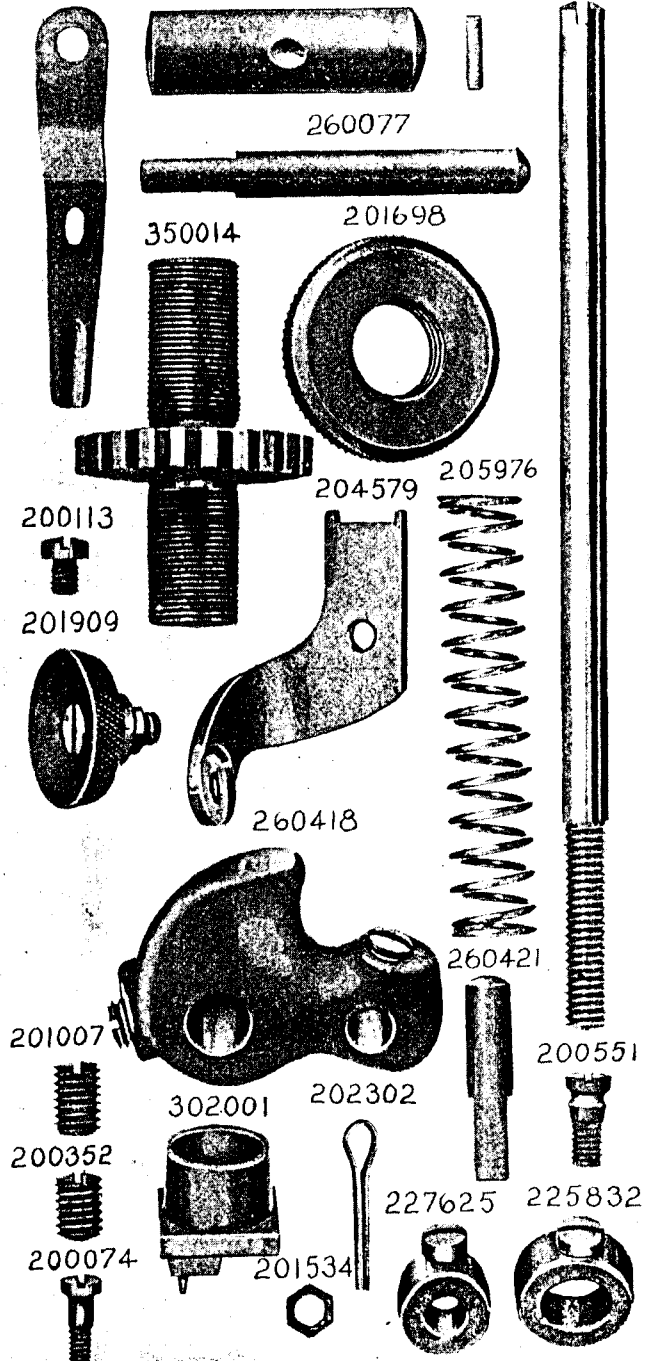

PLATE 14878—ONE-HALF SIZE

203958

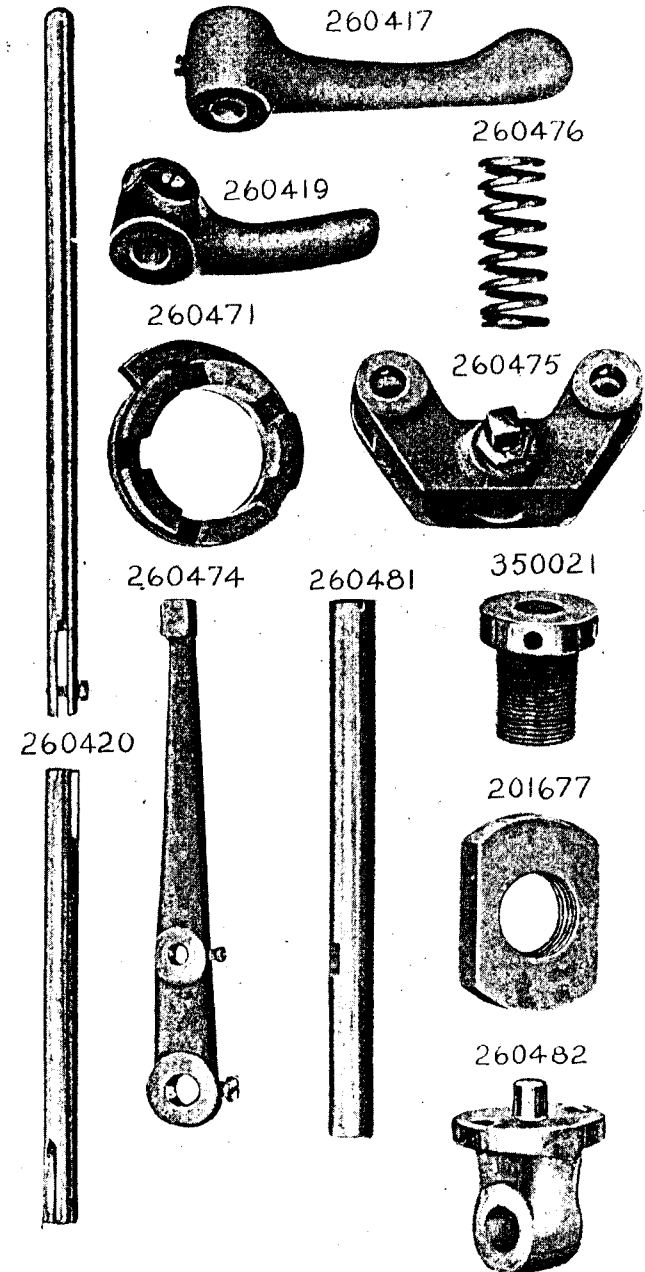



PLATE 14879—ONE-FOURTH SIZE

260486 227956 260485 260493

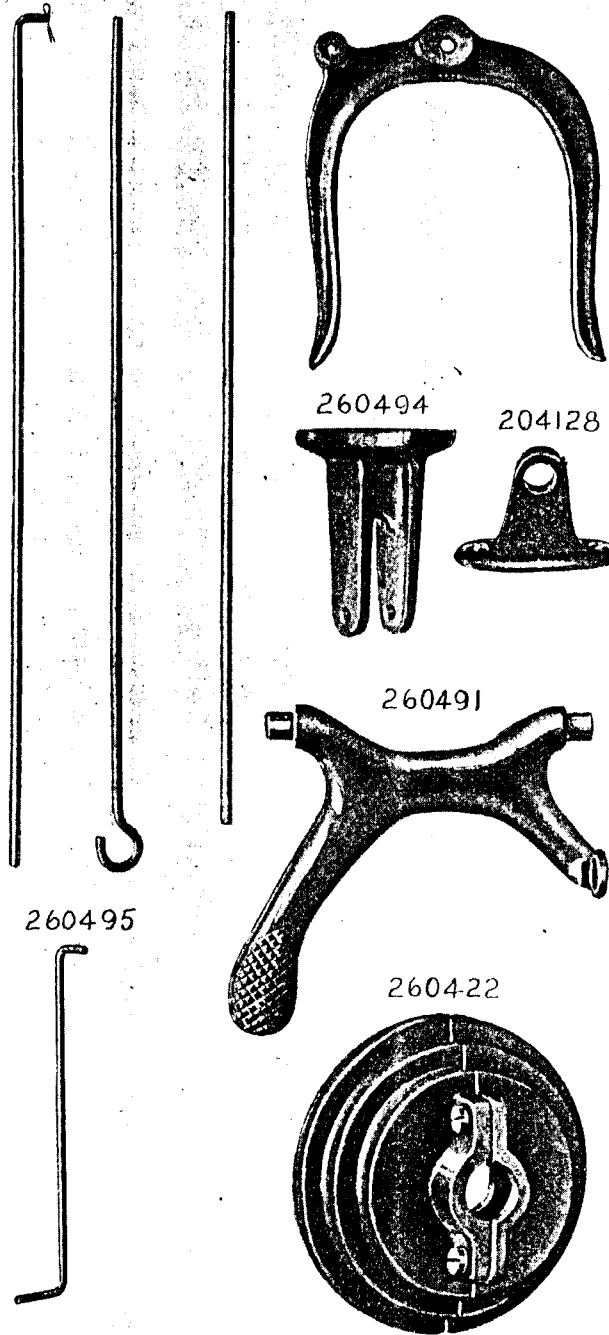

PLATE 14880—FULL SIZE

206628 260473 260480 201513 260484

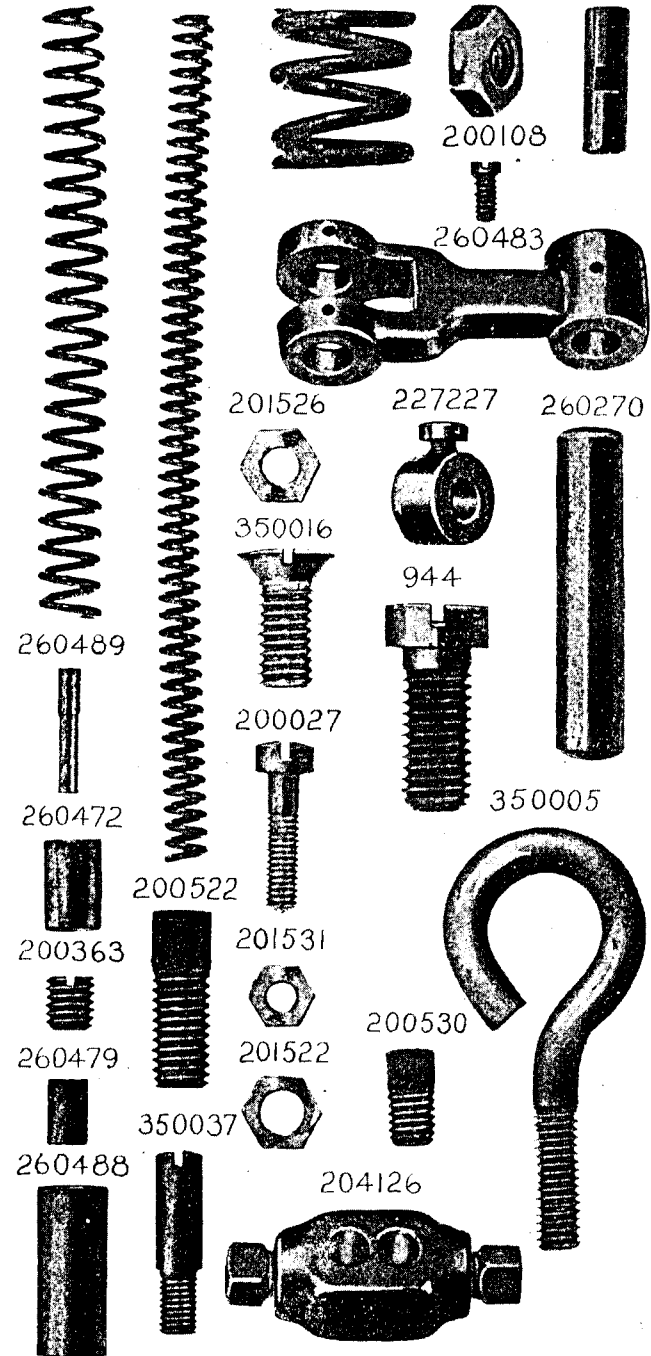
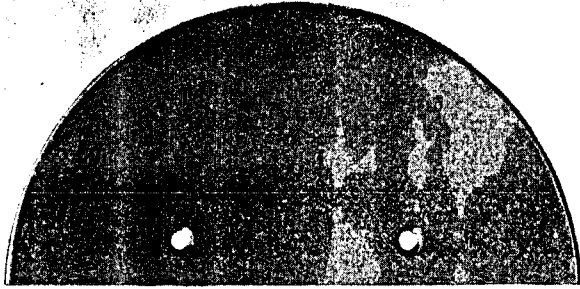
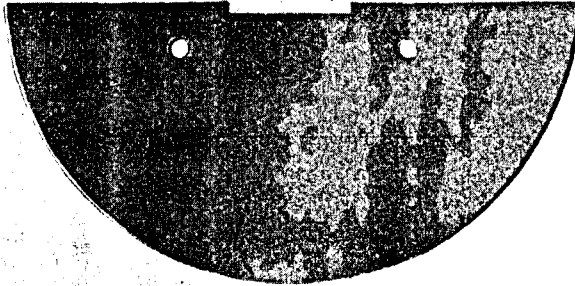

PLATE 14881—ONE-FOURTH SIZE

260426



260427



260414

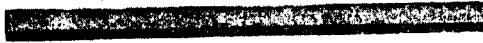
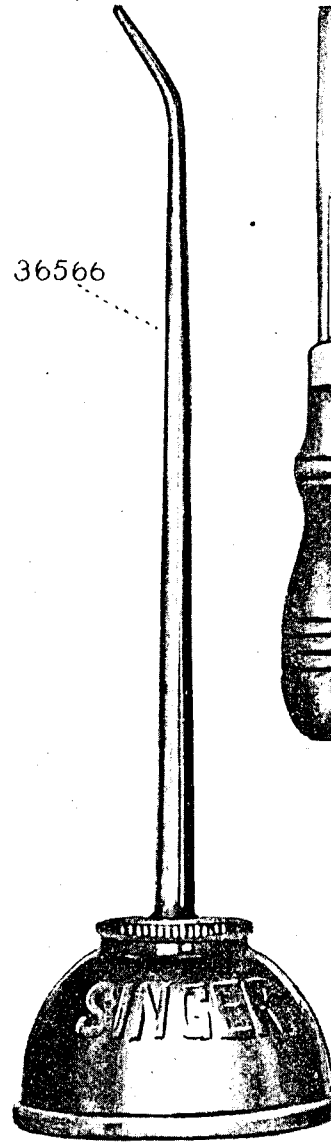

PLATE 14882—ONE-HALF SIZE

36565



36566

225498



260416

