

SINGER
143W2

71w
53)
in U.S.A.

SINGER**

143w2

THE SINGER COMPANY

**A Trade Mark of THE SINGER COMPANY

22443 22444 22442

241396

241404

241403

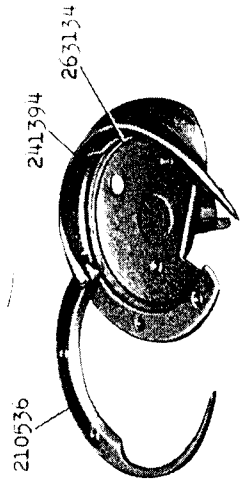

210914

210734

210913

2009640

2009620

2010163-0

263110

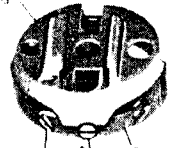

210735

210736

2009667

A A A

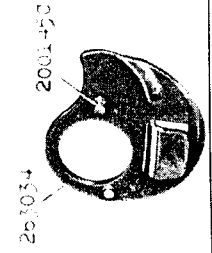

2100-6

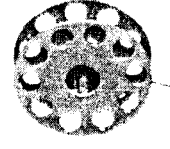
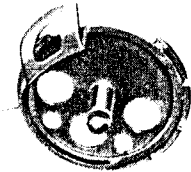

263099

15974 - 3/8

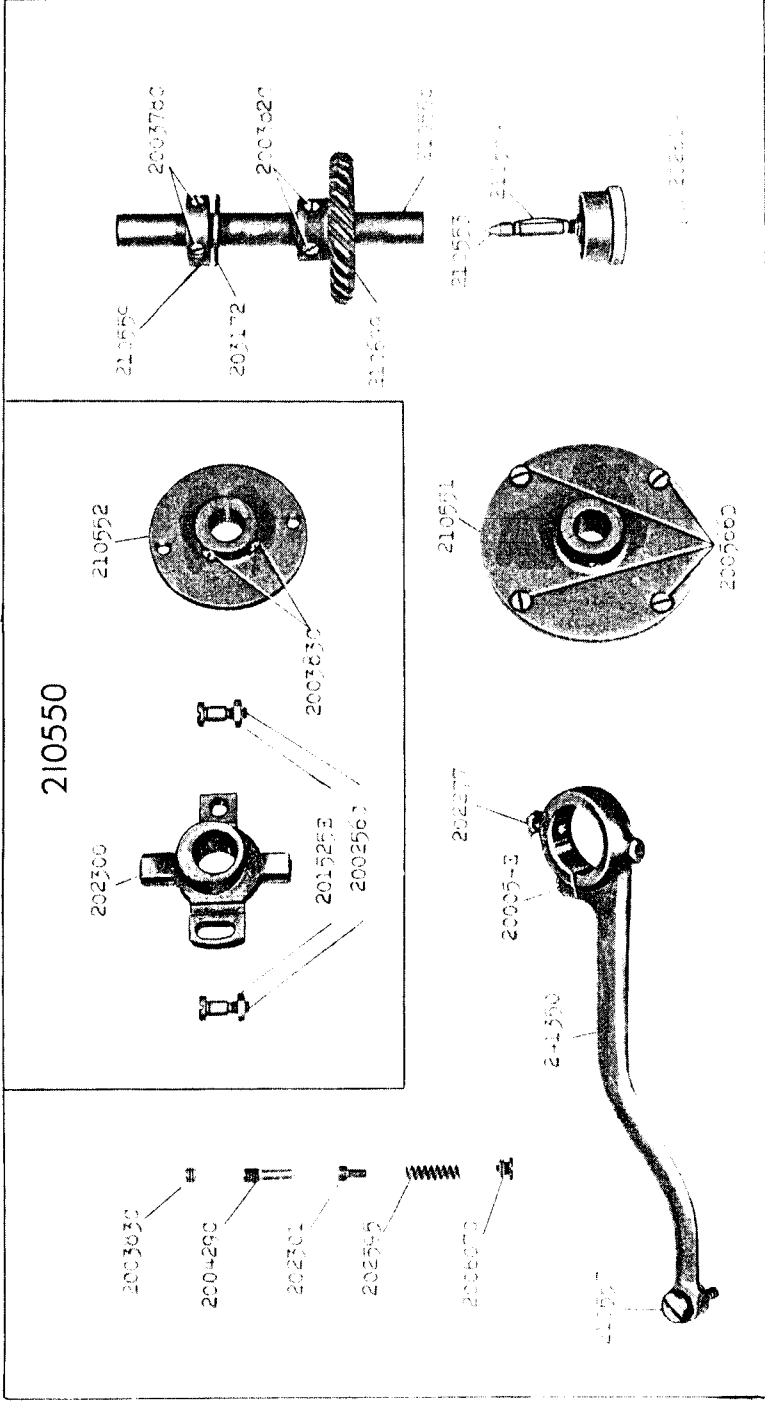

15979 - 1/2

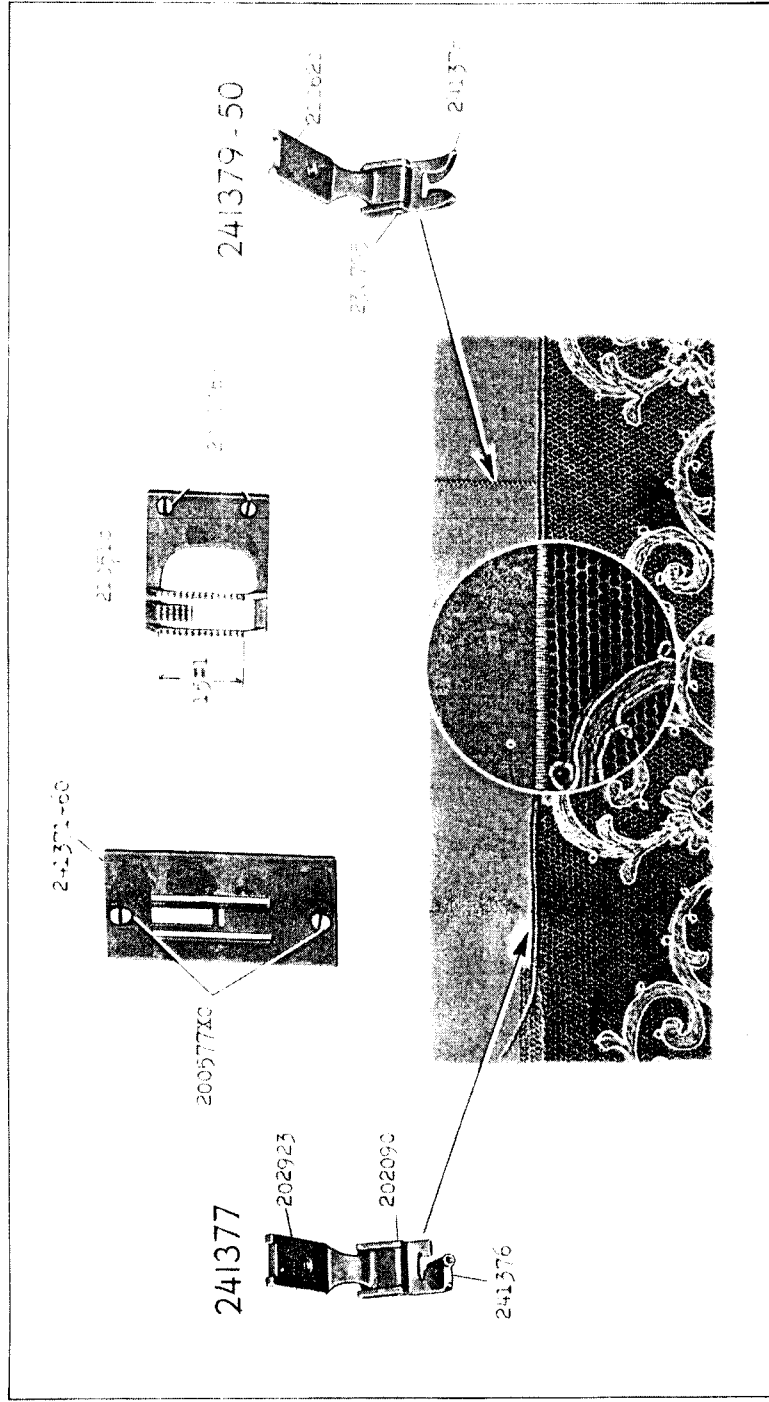

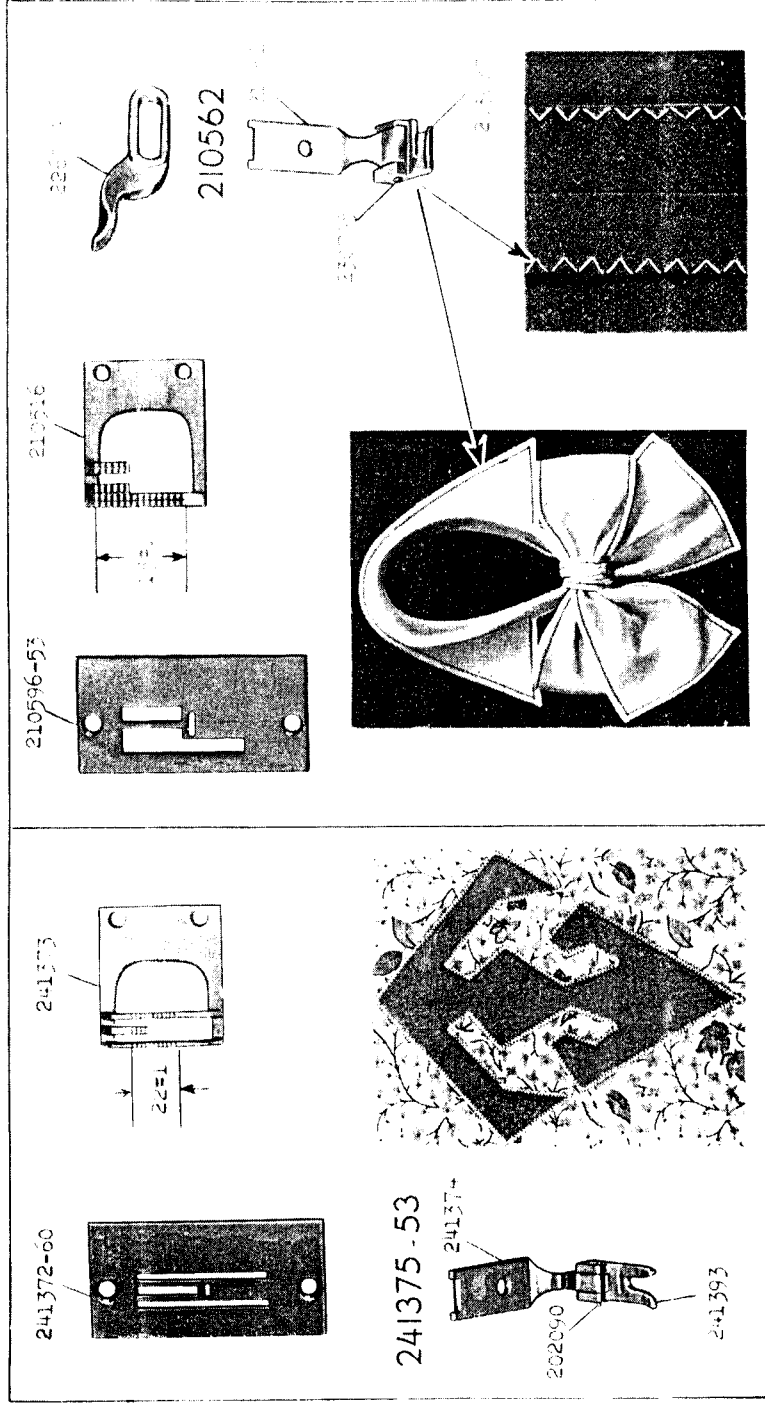
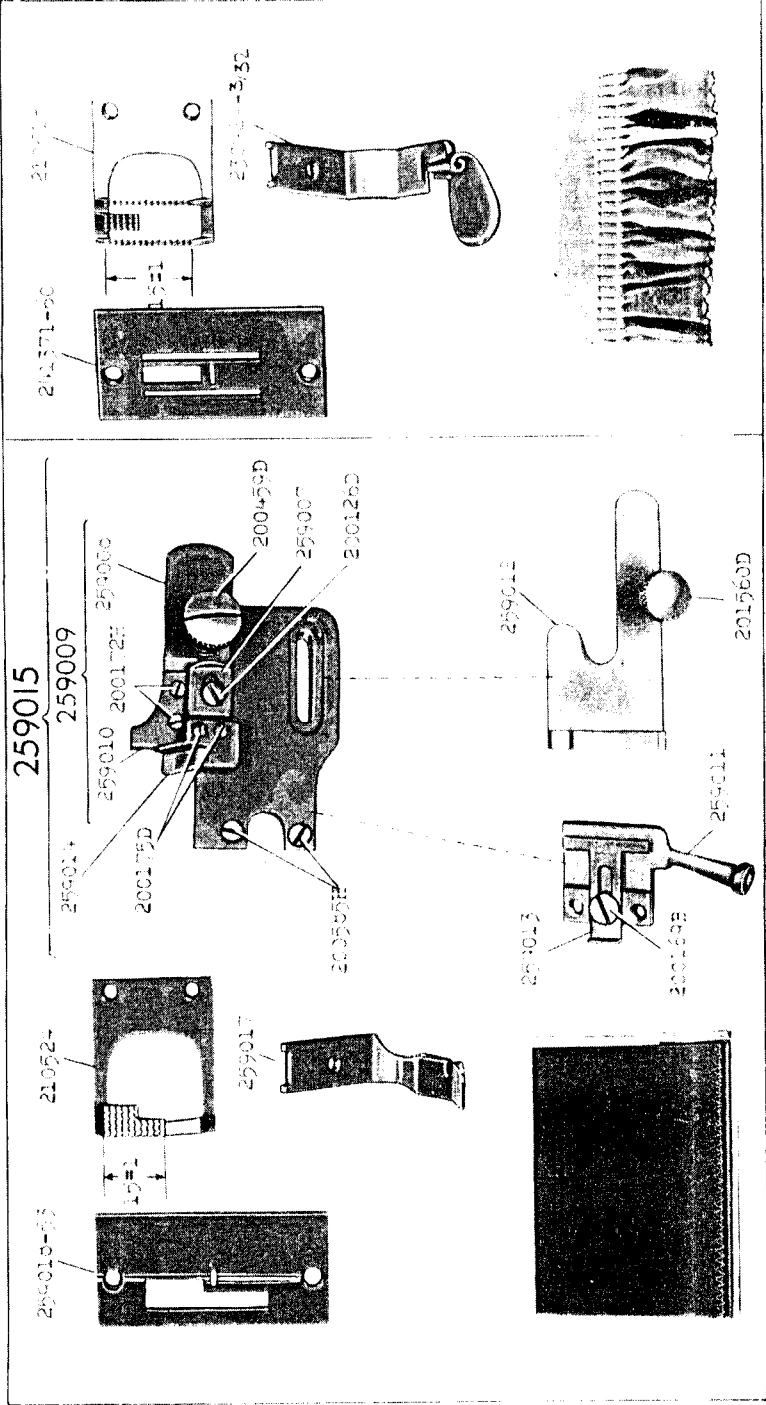

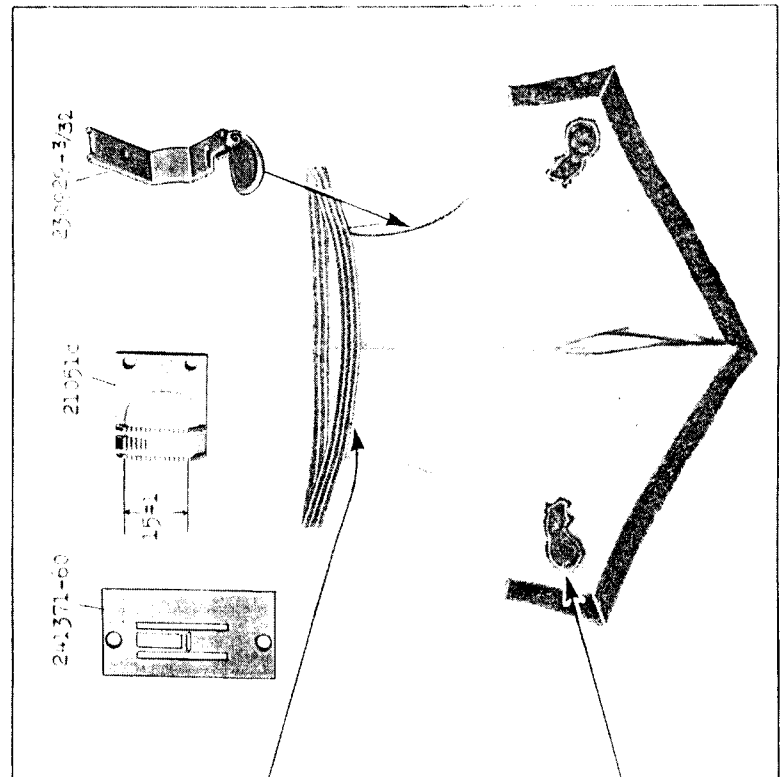
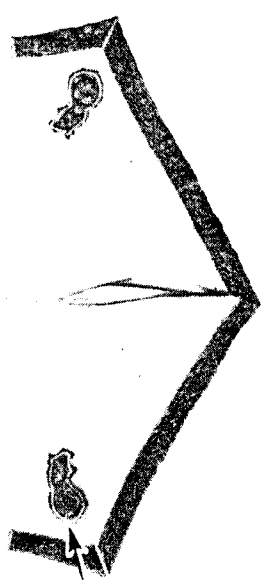
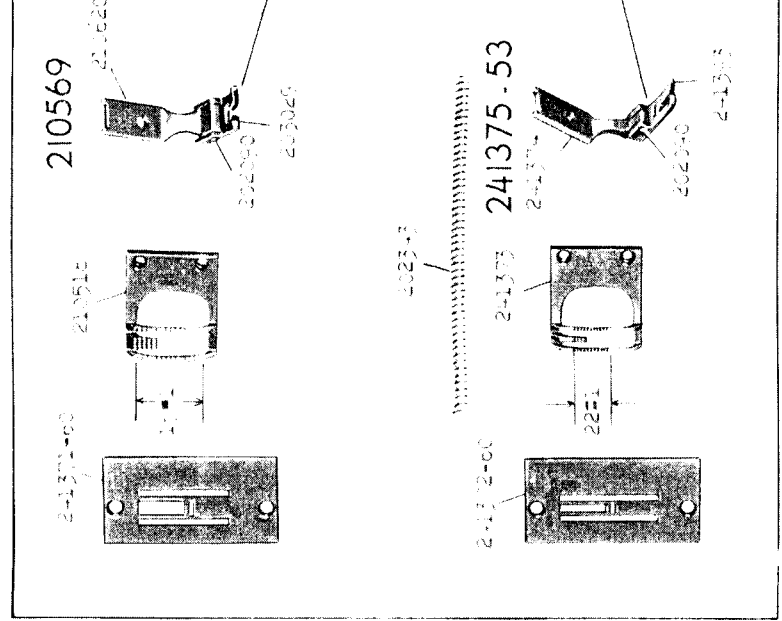
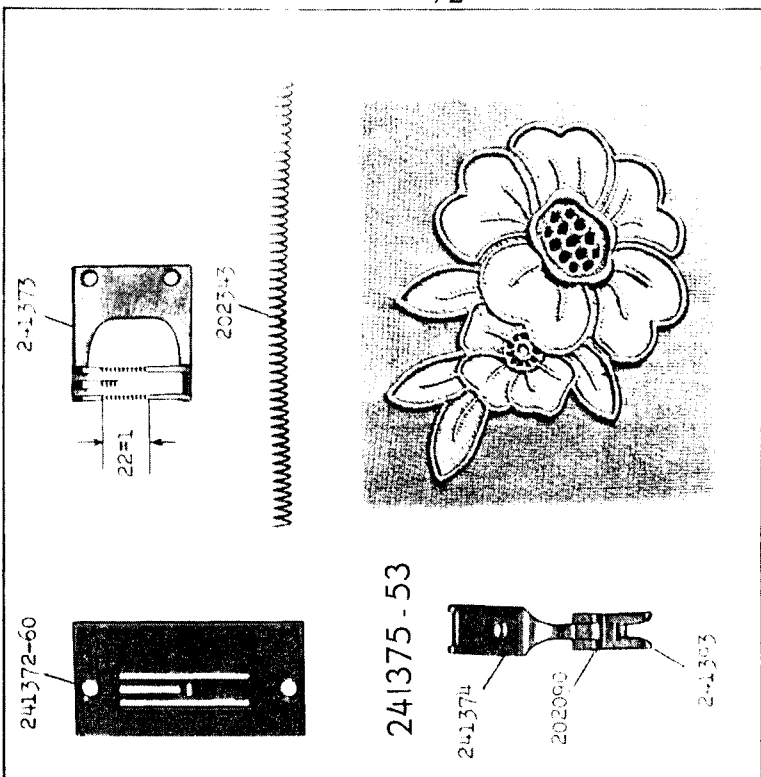
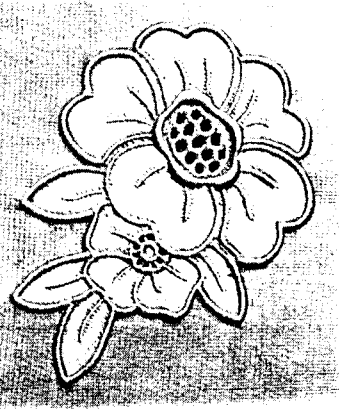
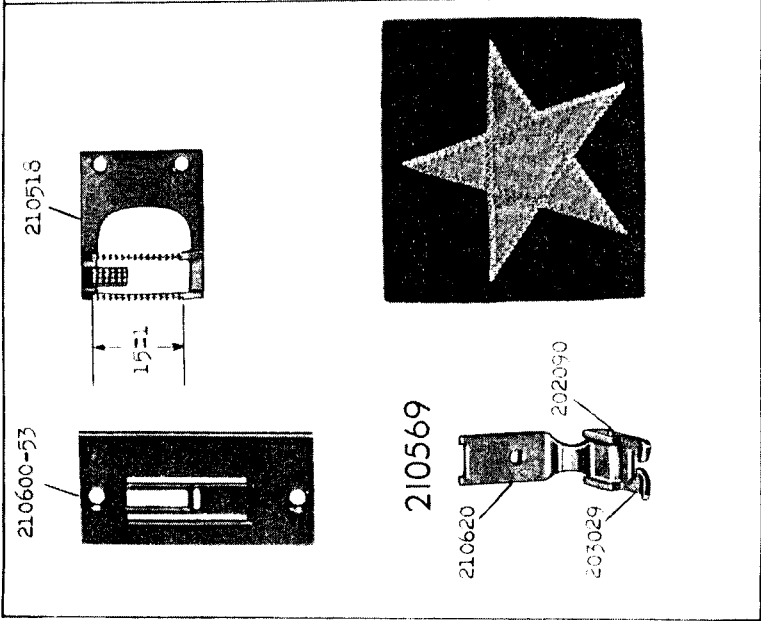

15998 - 3/8

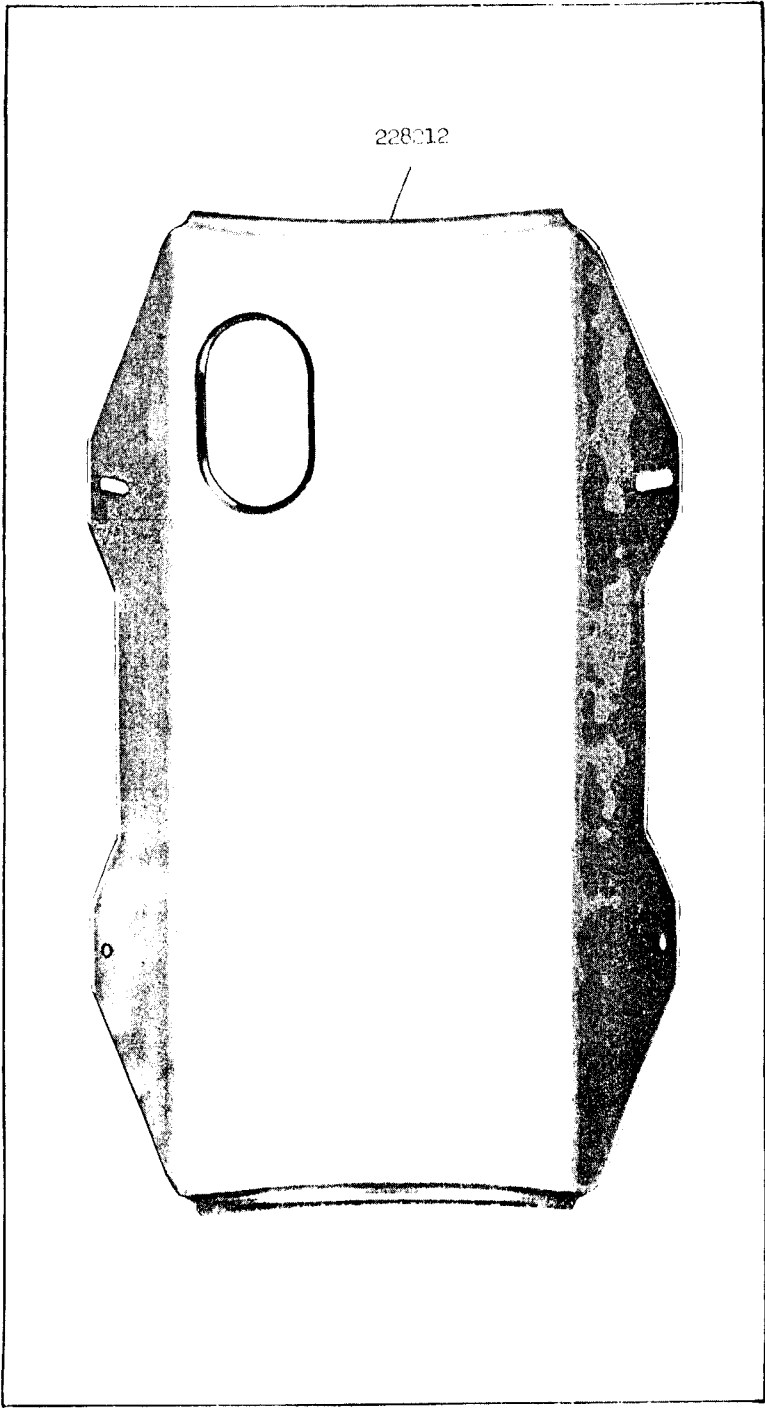

15999 - 3/8

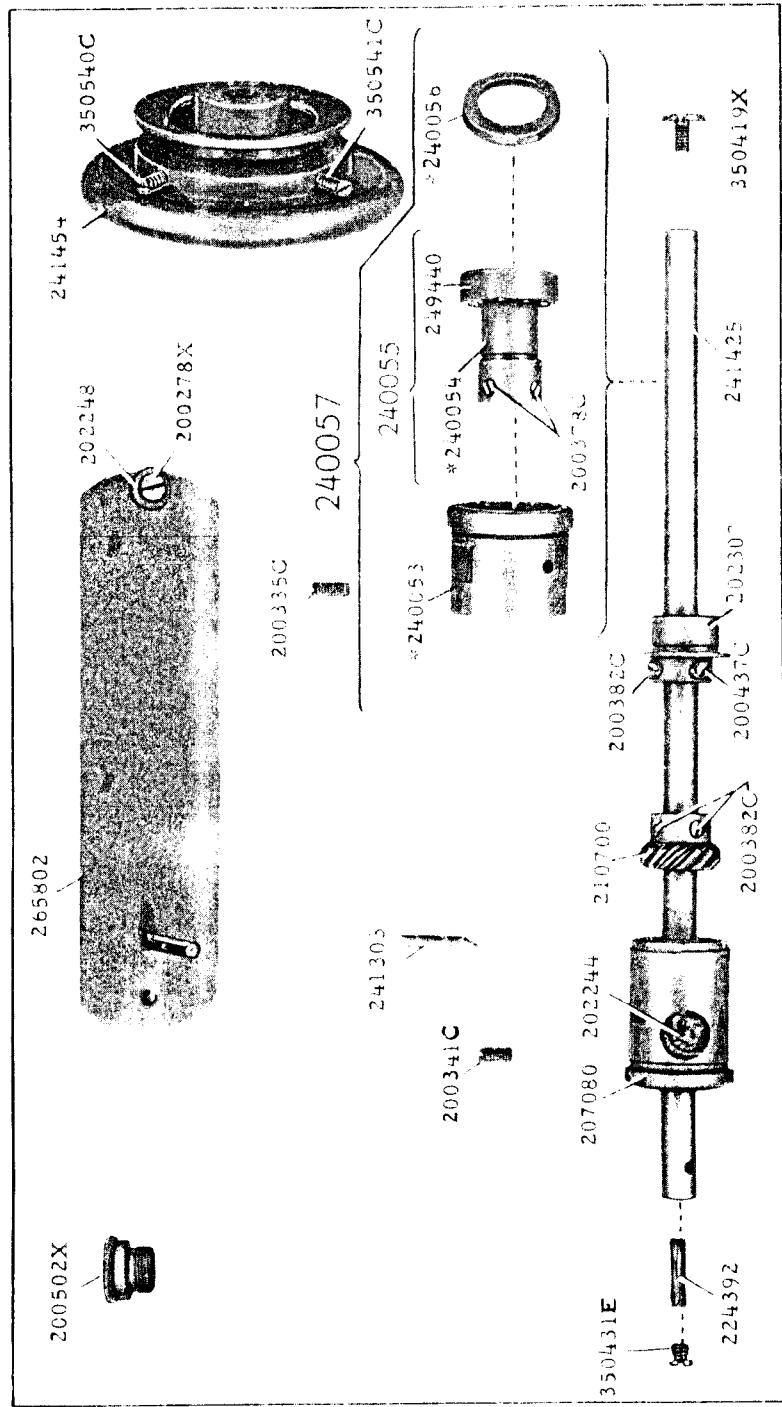

16000 - 3/8

241440

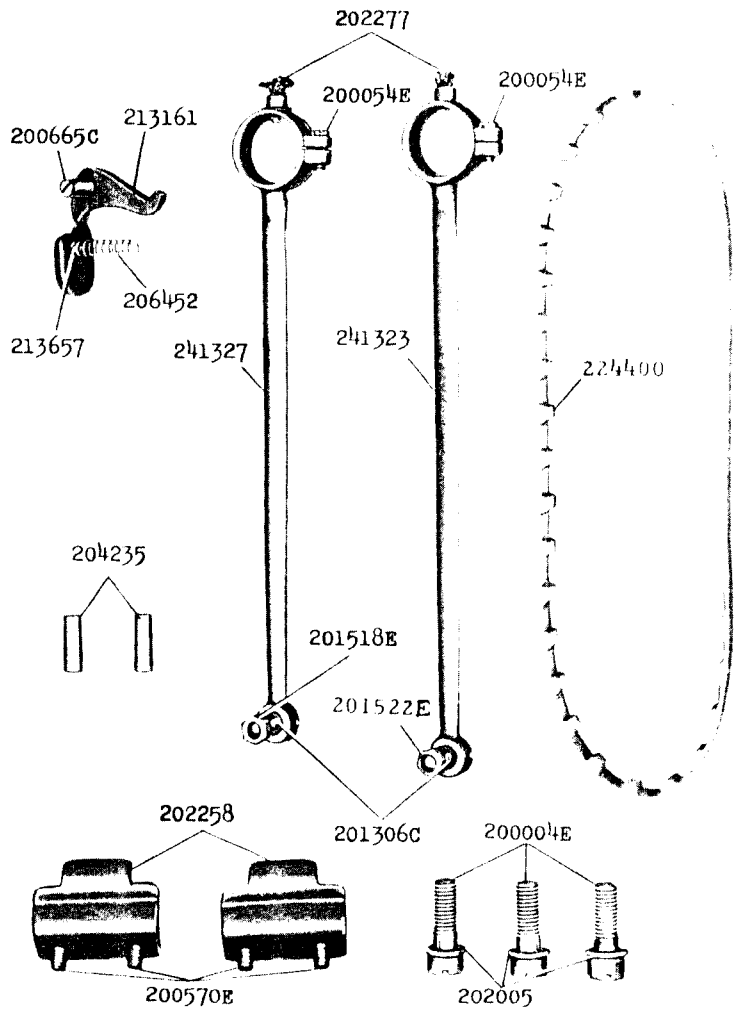
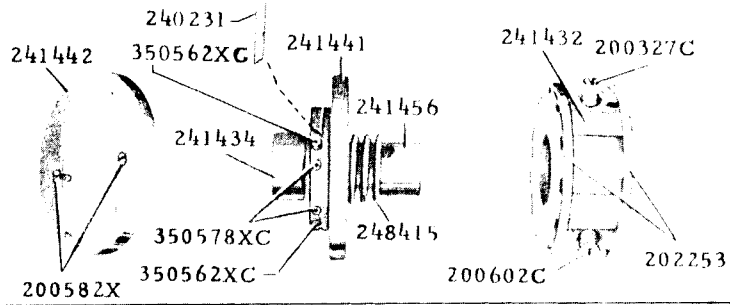

16001 - 1/3

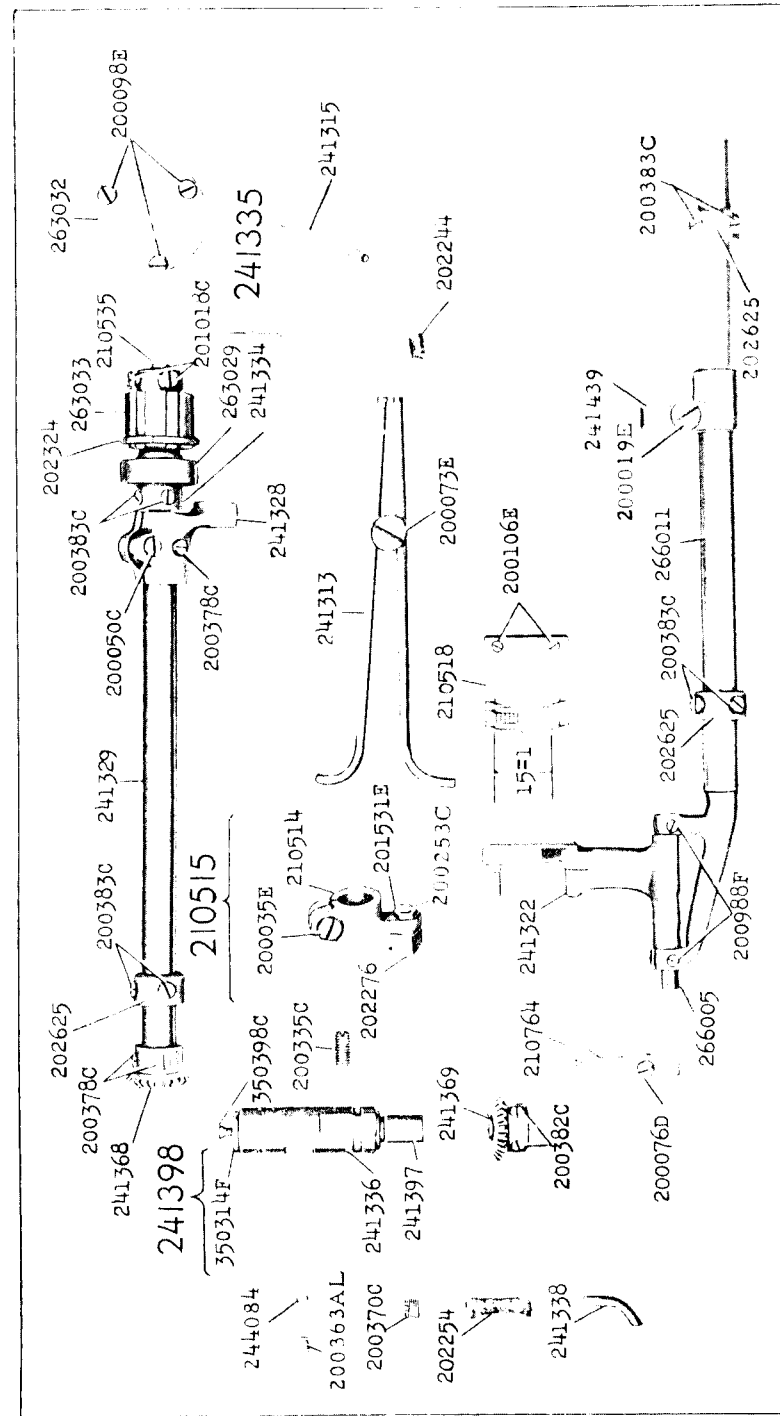

16002 - 1/2

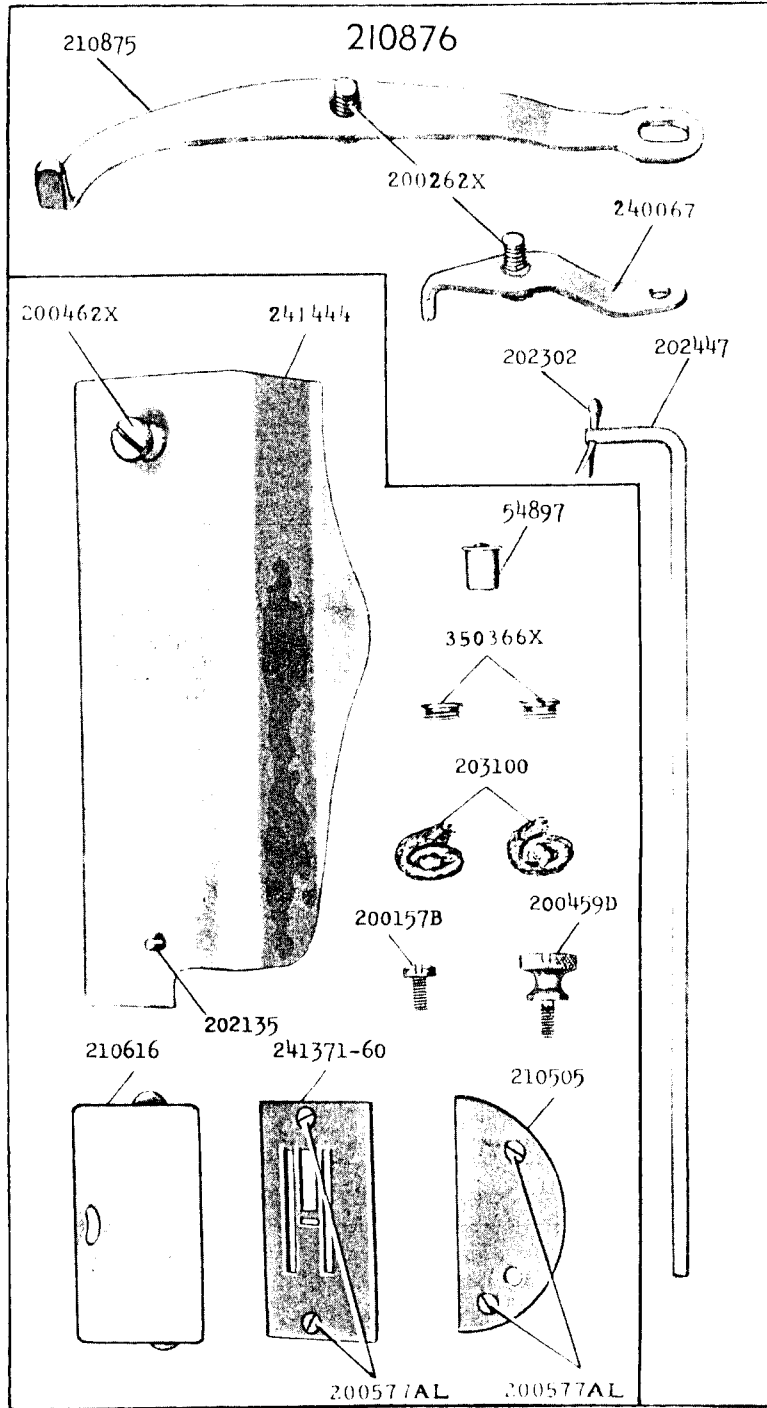

16003 - 1/2

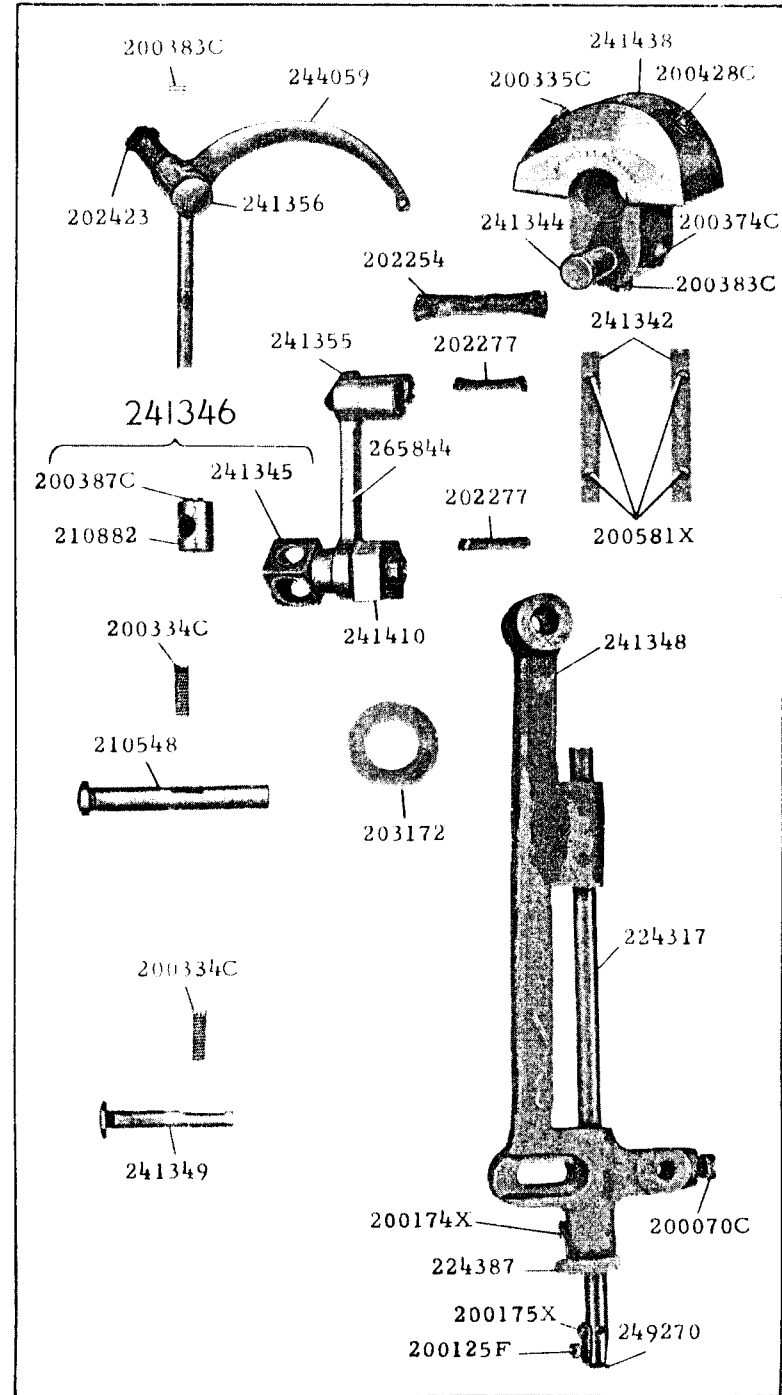

16004 - 1/2

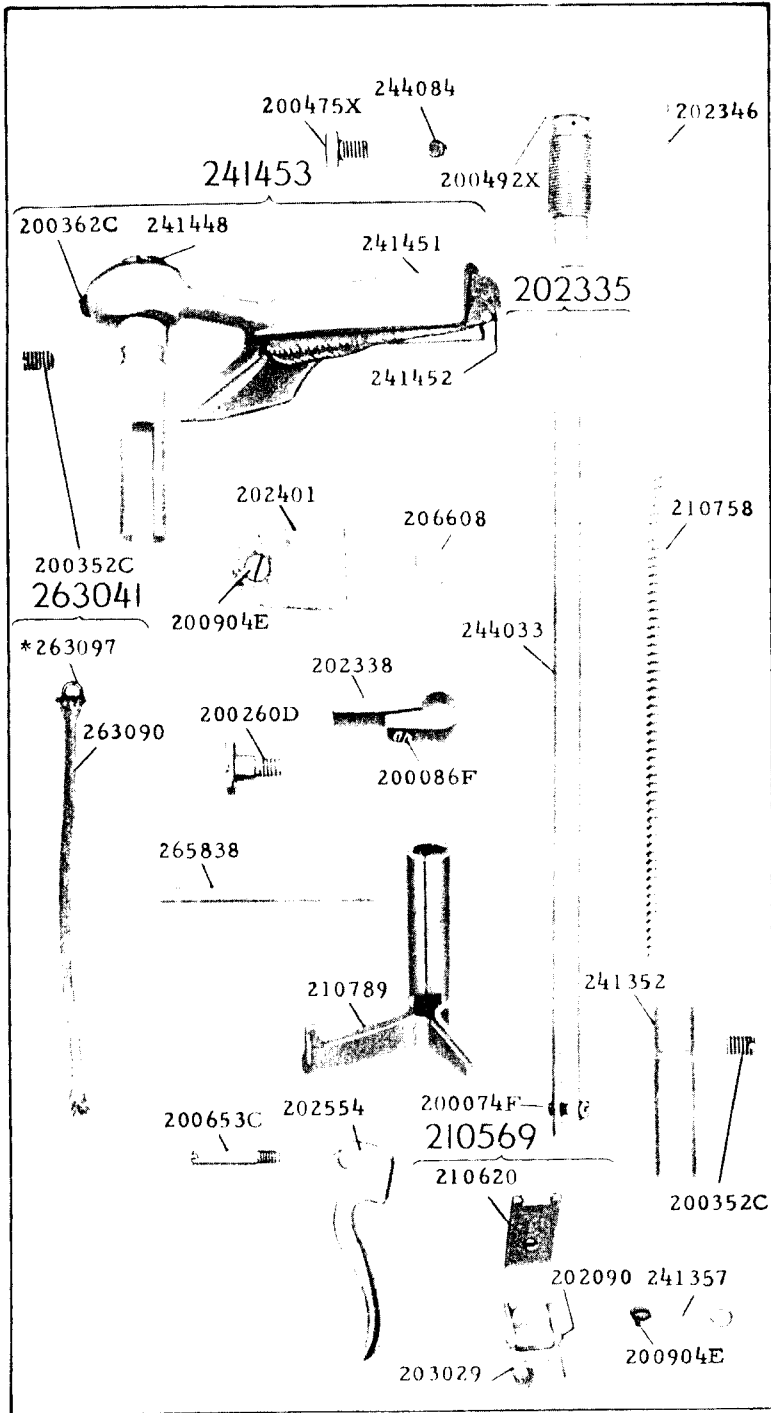

16005 - 3/4

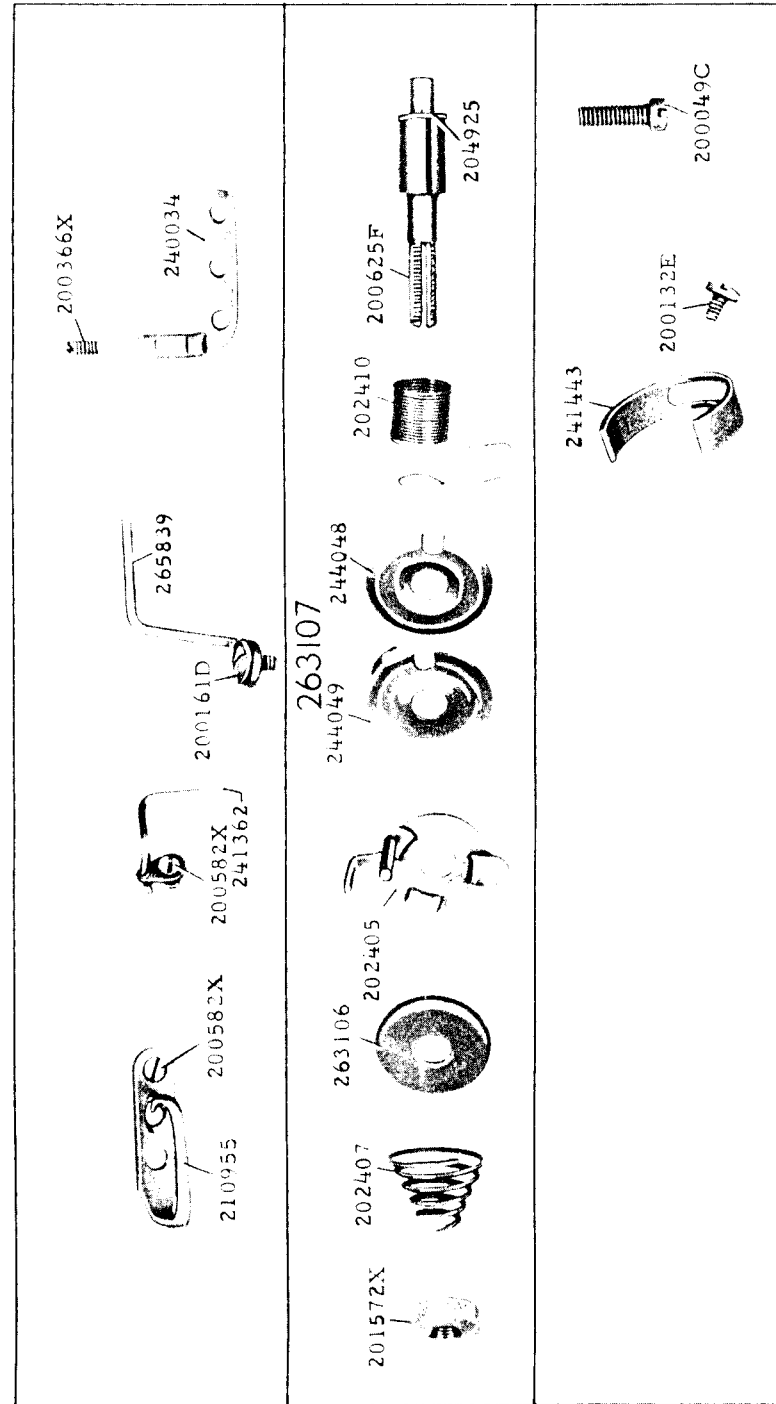

16006 - 1/2

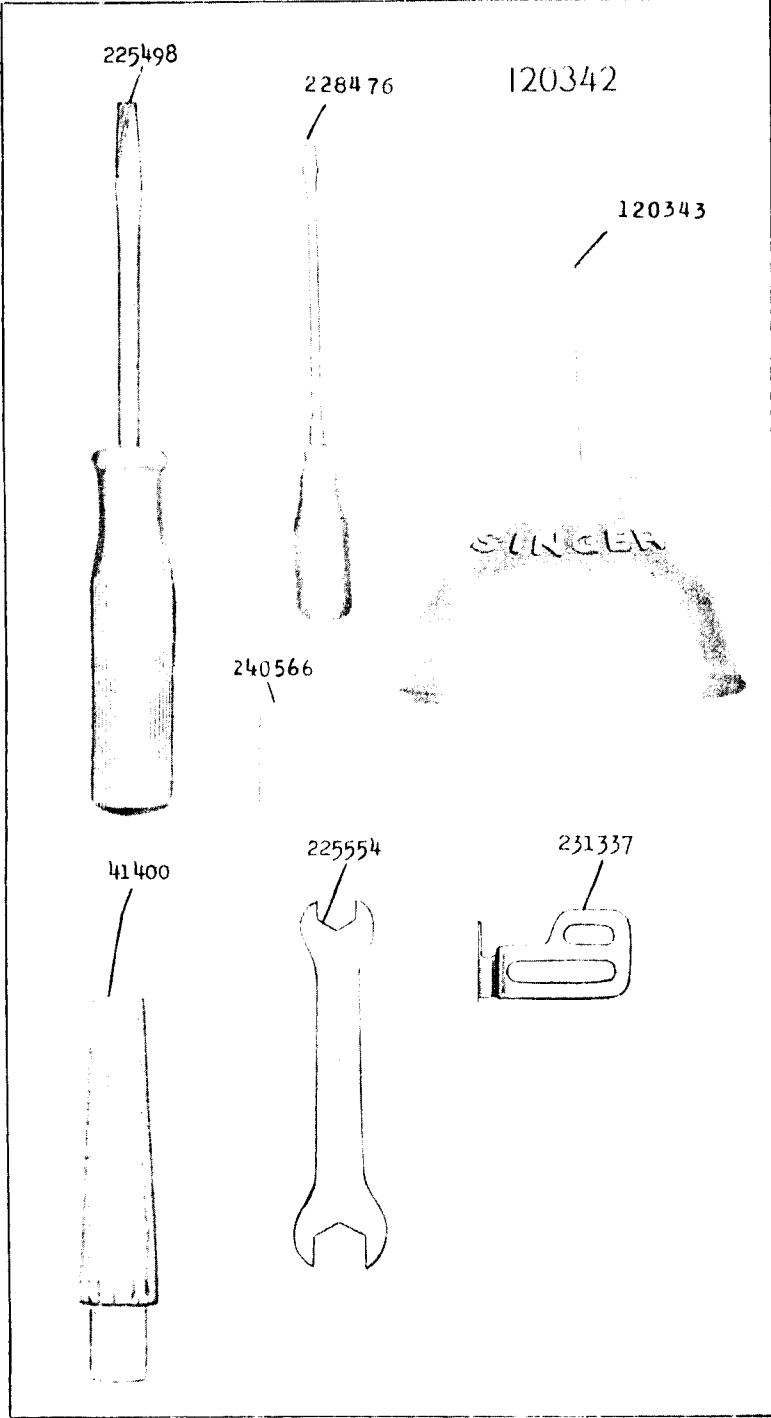

16007 - 3/8

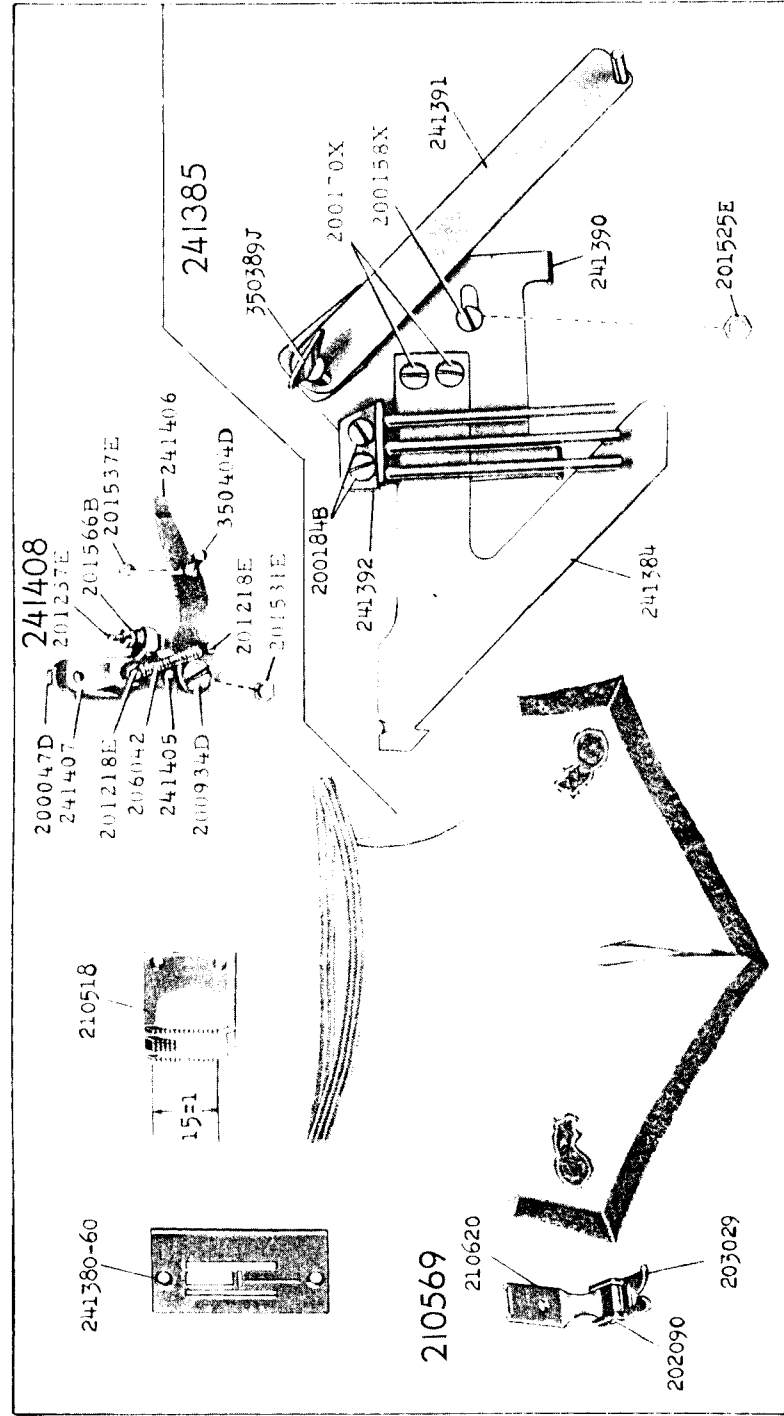

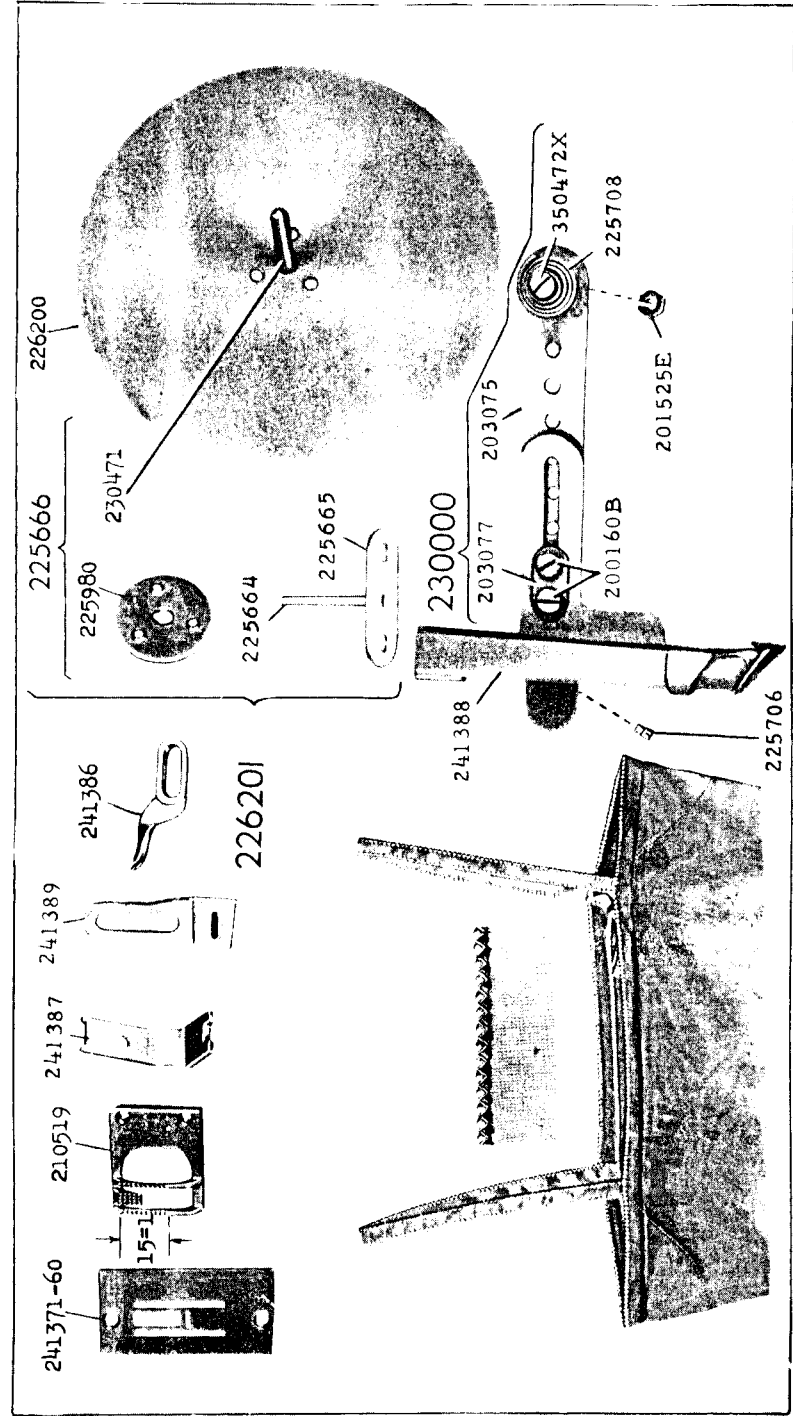
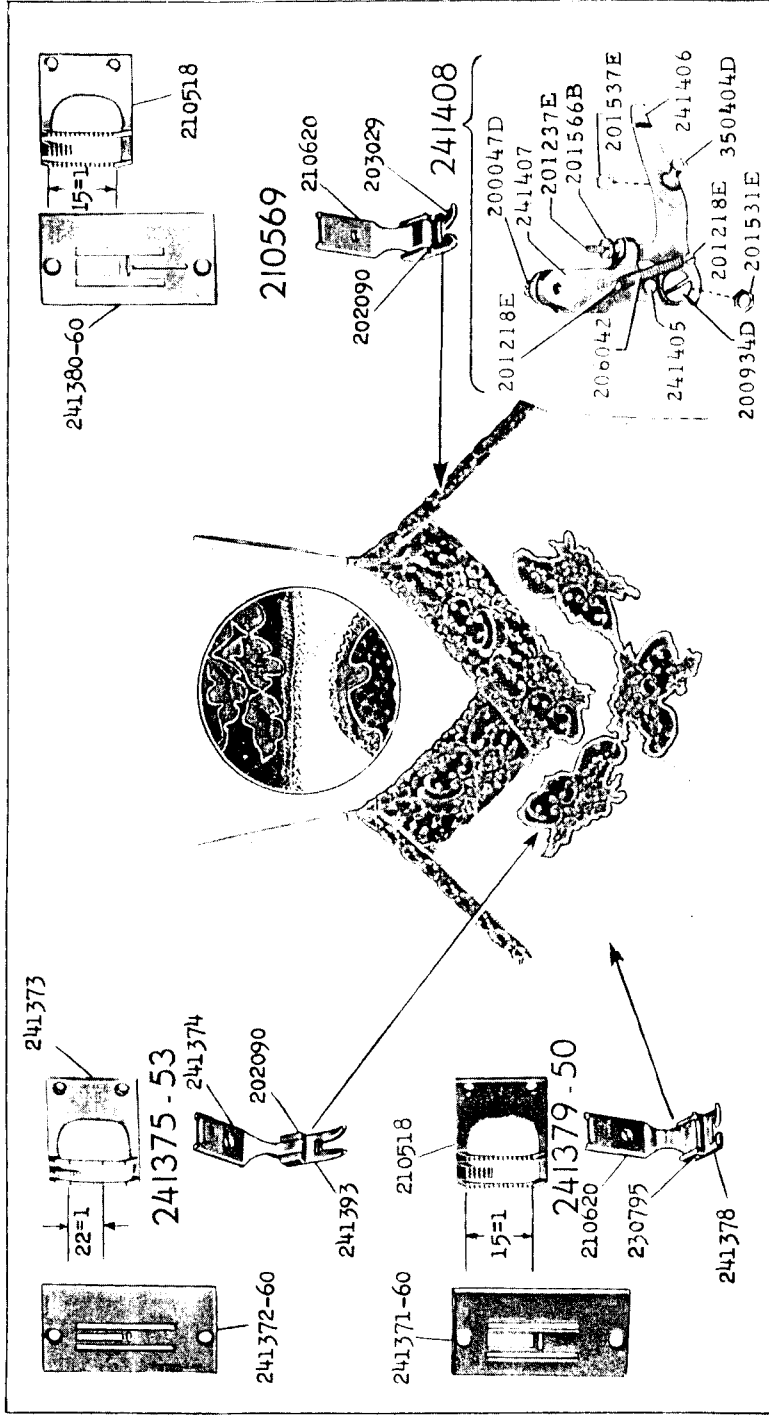

16615 - 1/2

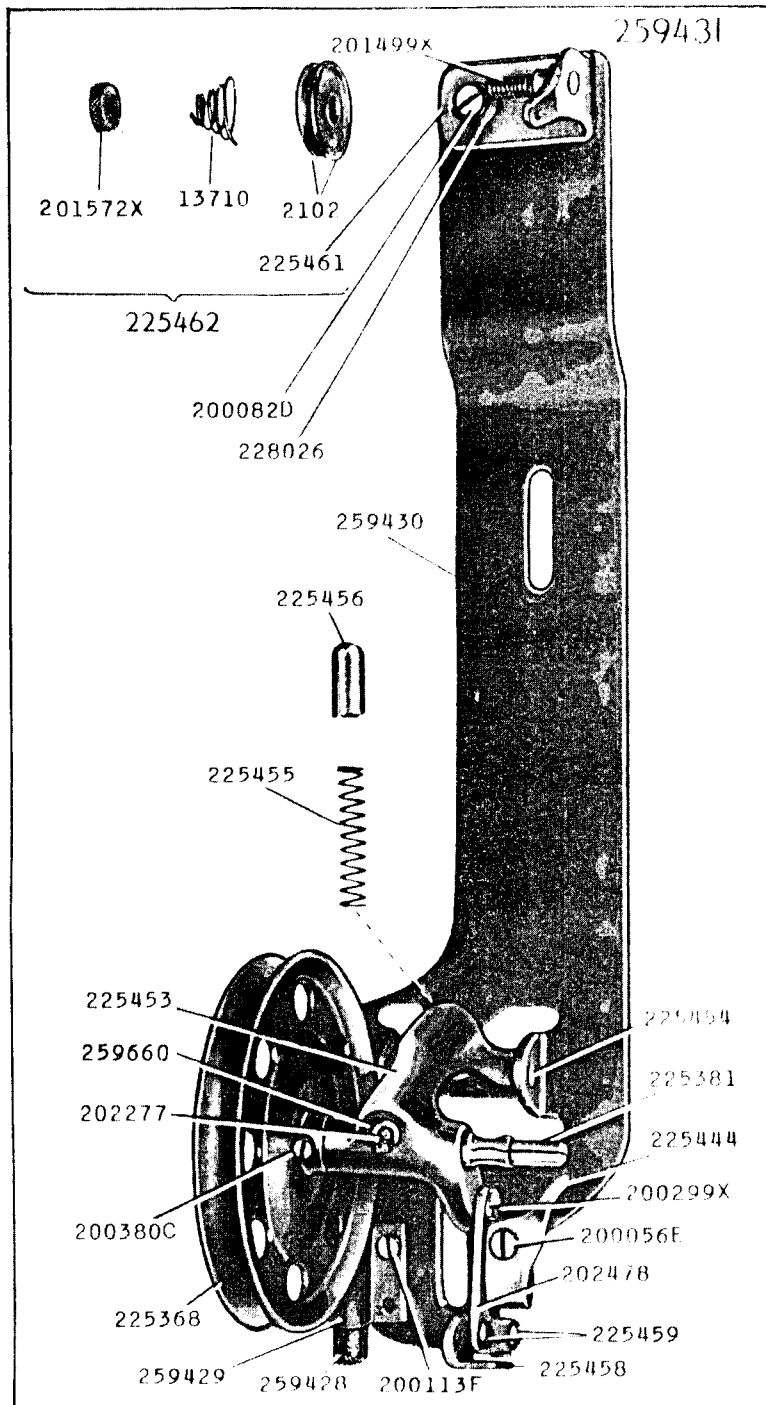

17900 - 1/6

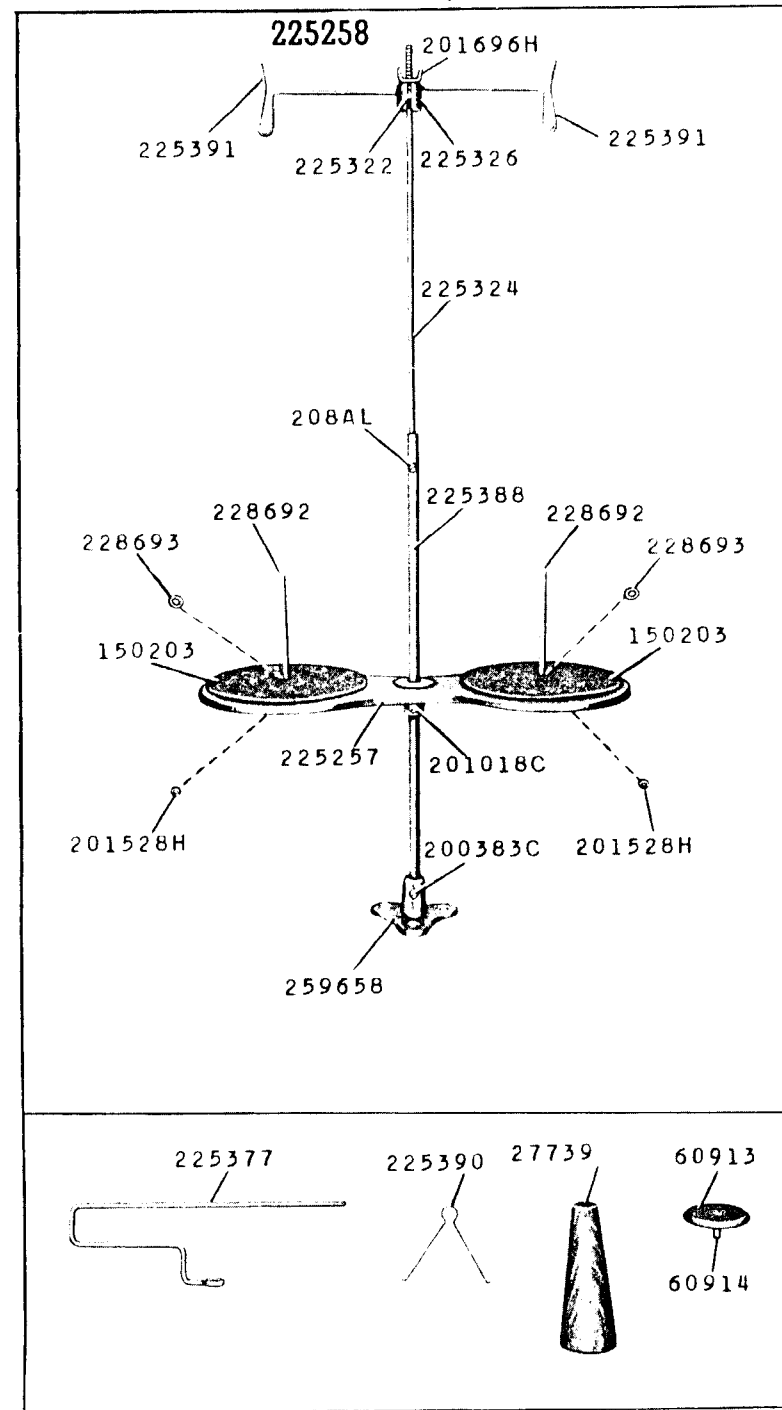

18580 - 3/8

228710

