

Singer 69-5
Singer 69-6
Singer 69-7
Singer 69-8
Singer 69-9
Singer 69-10
Singer 69-11
Singer 69-12
Singer 69-13
Singer 69-14
Singer 69-15
Singer 69-15
Singer 69-17
Singer 69-18
Singer 69-19
Singer 69-22

Form 18202—Revised
November, 1931
PRINTED IN U. S. A.

LIST
OF
PARTS



MACHINES
Nos. 69-5 to 69-19
and 69-22

THE SINGER MANUFACTURING COMPANY

COPYRIGHT, U. S. A.
1915, 1916, 1917, 1922, 1923, 1924, 1926, 1927, 1929 AND 1931
BY THE SINGER MANUFACTURING CO.
ALL RIGHTS RESERVED FOR ALL COUNTRIES

INDEX

	PAGE
ATTACHMENTS AND ACCESSORIES.....	57
BOBBIN WINDERS.....	58
BUTTON SPACING GUIDE.....	58
CLAMPS.....	55
MACHINE No. 69-5.....	7
“ “ 69-6.....	18
“ “ 69-7.....	19
“ “ 69-8.....	20
“ “ 69-9.....	22
“ “ 69-10.....	23
“ “ 69-11.....	24
“ “ 69-12.....	25
“ “ 69-13.....	26
“ “ 69-14.....	28
“ “ 69-15.....	29
“ “ 69-16.....	30
“ “ 69-17.....	33
“ “ 69-18.....	34
“ “ 69-19.....	35
“ “ 69-22.....	45
NUMERICAL LIST OF PARTS.....	67
OBSOLETE PARTS.....	63
PROTECTOR.....	59
STAND.....	60
STARTING LEVER AND FOOT LIFTER PARTS.....	61
STARTING LEVER ROCK SHAFT (FOR 1600 SERIES MOTORS) ..	61
STARTING LEVER ROCK SHAFT (FOR 1800 SERIES MOTORS) ..	61
TABLE BELT GUIDE.....	62
THREAD UNWINDER.....	62

INSTRUCTIONS FOR ORDERING

In ordering from this list, use **ONLY** the part **NUMBER** in the **FIRST** column.

The number stamped on a Sewing Machine Part is in every case the number of the single part only.

Every combination of parts sent out as such has its specific number, which, although not stamped on the parts, must be used when ordering the combination.

Each number always indicates the **SAME PART** in whatever list it appears, or for whatever machine.

The letters after some of the numbers indicate the style of finish only, as follows:

- A—Hardened, Polished, Nickel Plated and Buffed
- B—Polished, Nickel Plated and Buffed
- C—Hardened Only
- D—Polished Only
- E—Soft, Not Polished
- F—Hardened and Polished
- H—Blued
- J—Nickel Plated Only
- K—Hardened and Nickel Plated
- L—Brass Plated
- M—Oxidized
- N—Japanned, Dull
- P—Japanned, Bright
- R—Merlized
- T—Copper Plated
- T. A.—Hardened, Polished, Copper and Nickel Plated and Buffed
- T. B.—Copper and Nickel Plated and Polished
- T. J.—Copper and Nickel Plated Only
- T. K.—Hardened, Copper and Nickel Plated
- T. M.—Copper Plated and Oxidized
- T. L.—Copper and Brass Plated
- U—Zinc Plated
- V—Silver Plated
- W—Polished and Nickel Plated
- Z—Chromium Plated
- Z. B.—Polished, Nickel Plated, Buffed and Chromium Plated
- Z. J.—Nickel and Chromium Plated

These letters **MUST BE USED** when they appear in the list; and **AFTER** the number **as** in the list.

In this series:

- 1 to 1500 and 50001 to 51500 are Screw Numbers
- 1501 to 1800 and 51501 to 51800 are Nut Numbers
- 1801 to 2000 and 51801 to 52000 are Roller Numbers
- 2001 to 50000 and 52001 and upward are numbers of Machine Parts

The figures in the second column refer only to the plates, illustrating the parts, and are **NOT TO BE USED** in ordering.

Parts marked with an asterisk (*) are furnished only when repairs are made at factory.

LIST OF PARTS COMPLETE FOR

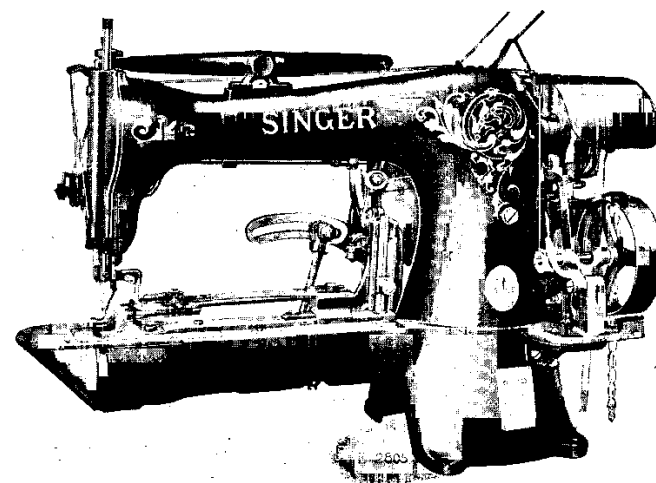

MACHINE No. 69-5

FOR SEWING FLAT BUTTONS UPON KNEE TROUSERS, COAT SLEEVES AND OTHER GARMENTS. MAKES CROSSED STITCHES IN FOUR HOLE BUTTONS AND CAN BE ADJUSTED FOR TWO HOLE AND BAR BUTTONS. MAKES EIGHTEEN CROSS AND THREE TYING STITCHES.

NO.	PLATE	NAME
*55405	—	Arm with 4449, 17844 and two 164E.....
4389	5042	" Dowel Pin.....
4448	3722	" Oil Tube, for intermediate bearing...
880E	3724	" Screw.....
17702	5000	" Shaft.....
17703	5001	" " Bushing (back).....
50333c	5042	" " " Adjusting Screw.....
1520E	3724	Arm Shaft Bushing (back) Adjusting Screw Nut.....
*4449	—	Arm Shaft Bushing (front).....
124674	8583	" Side Cover.....
190r	3710	" " " Screw.....

NO.	PLATE	NAME
18498	5044	Belt Cover.....
39290	5001	" " Bracket with 184E and 17741.
184E	5021	" " " Screw Stud.....
17741	5008	" " " Stud.....
217J	3731	" " " Screw.....
39222	5001	" Shifter.....
63976	8582	" " Clamp.....
1255D	5021	" " " Screw.....
17706	3704	Button Clamp (left) with 17723, for 17898
17707	3704	" " (right) with 17723, for 17898
17899	3708	" " (left) with 17723, for 17904
17900	3708	" " (right) with 17723, for 17904
39238	3747	" " (left) with 9311 and 17723, for 63928.....
39239	3747	Button Clamp (right) with 9311 and 17723, for 63928.....
17901	3704	Button Clamp Arm with 17711, 17714, and 23227, for 17898 and 17904.....
63927	7205	Button Clamp Arm with 17714 and 63788, for 63928.....
17710	3704	Button Clamp Arm Hinge Plate.....
1176J	3704	" " " " " Screw...
17711	3704	" " " " " Hook for 17901.....
63788	7205	" " " " " 63927.....
1175J	3704	" " " " " Hinge Screw.....
17708	3710	" " " " " Lifter with 17866.....
190J	3710	" " " " " Screw.....
17712	3710	" " " " " Pressure Spring for 17898 and 17904.....
39241	3748	Button Clamp Pressure Spring for 63928...
17713	3710	" " " " " Bracket....
1177D	3710	" " " " " " Screw
17714	3704	" " " " " Guide Block
1178J	3710	" " " " " " Screw.....
17716	3705	" " " " " Spreader for 17898 and 17904.....
39242	3748	Button Clamp Spreader for 63928.....
17717	3705	" " " " " Lever.....
50237K	3705	" " " " " " Hinge Screw
1180J	3705	" " " " " " Locking Thumb Screw.....
17718	3705	Button Clamp Spreader Lever Locking Thumb Screw Washer.....
1182J	3705	Button Clamp Spreader Screw.....
17719	3705	" " " " " Spring.....
1181J	3705	" " " " " " Screw.....
17720	3705	" " " " " Steady Pin.....

NO.	PLATE	NAME
17721	3705	Button Clamp Spring, for flat buttons, for 17898.....
17938	3705	Button Clamp Spring, for stud back buttons, for 17898.....
17902	3708	Button Clamp Spring, for flat buttons, for 17904.....
17939	3708	Button Clamp Spring, for stud back buttons, for 17904.....
39244	3747	Button Clamp Spring (left) for flat buttons, for 63928.....
39245	3747	Button Clamp Spring (right) for flat buttons, for 63928.....
39246	3748	Button Clamp Spring (left) for stud back buttons, for 63928.....
39247	3748	Button Clamp Spring (right) for stud back buttons, for 63928.....
39340	5027	Button Clamp Spring for 39341.....
39341	—	" " " " 39340 with 39342 for flat or stud back buttons, for 17904..
39342	5027	Button Clamp Spring Plate.....
236J	3705	" " " " " Screw for 17898 and 17904.....
229J	5017	Button Clamp Spring Screw for 63928....
23227	3705	" " " " " Steady Pin for 17901
9311	3747	" " " " " " " 39238 and 39239.....
17722	3705	Button Clamp Stop with two 17720, for 17898.....
17903	3708	Button Clamp Stop with two 17720, for 17904.....
39248	3748	Button Clamp Stop with two 17720, for 63928.....
1183J	3705	Button Clamp Stop Screw.....
17723	3704	" " " " " Stud.....
17898	3703	Button Clamp (universal) complete, for 14 to 36 line buttons, Nos. 236J, 1180J, 1181J, 1182J, 1183J, 17706, 17707, 17716 to 17719, 17721 or 17938, 17722, 17901, 50237K and two 1175J.....
17904	—	Button Clamp (universal) complete, for 26 to 46 line buttons, Nos. 236J, 1180J, 1181J, 1182J, 1183J, 17716 to 17719, 17899 to 17901, 17902 or 17939, 17903, 50237K and two 1175J.....

NO.	PLATE	NAME
18369	5006	Feed Regulator Bracket with 690D, 1773Z and two 160D.....
*1773Z	—	Feed Regulator Bracket Cap.....
160D	5008	" " " " Screw.....
8589	3722	" " " " Dowel Pin.....
1177E	3710	" " " " Screw.....
17744	5009	" " Hinge Stud.....
17743	5009	" " Post.....
1953	5021	" " Roller and Screw Stud with 1655c and 14017.....
1655c	5021	Feed Regulator Roller and Screw Stud Nut.....
14017	5015	Feed Regulator Roller and Screw Stud Nut Washer.....
1190c	5009	Feed Regulator Stop Screw.....
17745	5009	" " Swivel.....
1191D	5009	" " Thumb Screw.....
55319	8582	Knife (needle thread) for 55323.....
55320	8582	" (shuttle thread) for 55323.....
55321	8582	" (stationary) for 55329.....
*55322	—	" " Bracket.....
42639	8584	" " " " Pin.....
50117J	8584	" " " " Screw.....
18370	5000	" Bar with 18373 and two 17822.....
18371	5015	" " Cap.....
217J	3731	" " " " Screw.....
18372	5016	" " Connection with 17917.....
190J	3710	" " " " Screw.....
7071	5008	" " " " Washer.....
17915	5016	" " " " Slide Block.....
17917	—	" " " " 17915 with 17916.....
17916	5016	Knife Bar Connection Slide Block Stud...
39297	5016	" " Driving Lever with 190J, 1420E, 17919 and 39298.....
1382F	5016	Knife Bar Driving Lever Hinge Screw....
1681c	5016	" " " " " " Nut
39298	5016	" " " " " " Lock Stud.....
17919	5016	" " " " " " Spring
190J	3710	" " " " " " " " Screw.....
1420E	5016	Knife Bar Driving Lever Lock Stud Stop Screw.....
18373	5015	Knife Bar Rack.....
17822	5015	" " " " Rivet.....
39235	5006	" Cam Lever Body.....
39409	—	" " " " 39235 with 39460

NO.	PLATE	NAME
39329	5029	Knife Cam Lever complete, Nos. 19793 and 39409.....
18470	5028	Knife Cam Lever Bracket with 1177D....
8589	3722	" " " " Dowel Pin.....
670E	5021	" " " " Screw.....
50029c	3759	" " " " Hinge Screw.....
18471	3759	" " " " " " Bushing....
*18472	—	" " " " " " " " 18471 with 50029c.....
1177D	3710	Knife Cam Lever Hinge Screw Bushing Clamping Screw.....
1980	3759	Knife Cam Lever Roller and Screw Stud with 1654c.....
1654c	5013	Knife Cam Lever Roller and Screw Stud Nut.....
39330	3759	Knife Cam Lever Slide with 1980.....
39460	—	" " " " 39330 with 1255D and 39331.....
1255D	5021	Knife Cam Lever Slide Screw.....
39331	3759	" " " " " " Washer....
19793	5015	" " " " Steady Pin.....
17825	5015	" Holder with 17826, 17830 and two 7298.....
55323	—	Knife Holder 17825 with 1198c, 17829, 55319 and 55320.....
17826	5015	Knife Holder Pinion.....
7298	5015	" " " " Dowel Pin.....
17827	5015	" " " " Stud.....
17828	5015	" " " " Bracket with 17827.....
50018F	5021	Knife Holder Pinion Stud Bracket Screw
1698c	5021	" " " " " " " " Nut.....
1198c	5015	Knife Screw.....
17829	5015	" Thread Holder.....
17830	5015	" " " " Position Pin.....
17831	5002	Needle Bar with 237F.....
*39203	3718	" " Connecting Link.....
377c	3718	" " " " Hinge Screw
1518E	3718	" " " " " " " " Nut.....
21629	3718	Needle Bar Connecting Stud with 155c...
155c	3718	" " " " " " Set Screw...
39350	5029	" " Thread Nipper Driving Lever (adjustable) with 39351 and two 335J...
39351	3759	Needle Bar Thread Nipper Driving Lever Extension.....

NO.	PLATE	NAME
335j	3759	Needle Bar Thread Nipper Driving Lever Extension Screw.....
1196c	3721	Needle Bar Thread Nipper Driving Lever Hinge Screw.....
39352	5029	Needle Bar Thread Nipper Driving Lever Spring.....
17834	3718	Needle Bar Thread Nipper Lever with 17835.....
17835	3718	Needle Bar Thread Nipper Lever Bushing
1200d	3718	" " " " " Hinge Screw.....
39276	5009	Needle Bar Thread Nipper Lever Spring
1329j	5009	" " " " " " Screw.....
17837	5019	Needle Bar Thread Nipper Rod.....
17838	3718	" " " " " Adjusting Stud.....
1651E	5021	Needle Bar Thread Nipper Rod Adjusting Stud Lock Nut.....
17839	3718	Needle Bar Thread Nipper Rod Arm with 196F.....
196F	3718	Needle Bar Thread Nipper Rod Arm Set Screw.....
17840	5001	Needle Bar Thread Nipper Rod Support
190j	3710	" " " " " " Screw.....
237F	3724	Needle Set Screw.....
*6022	5001	Oscillating Rock Shaft with 4784.....
55278	—	Oscillating Rock Shaft complete, Nos. 1513j, 6022 and 6489.....
6489	5001	Oscillating Rock Shaft Hinge Pin.....
1513j	3724	" " " " " Nut....
4784	5009	" " " Oil Pad.....
18385	5002	" Shaft.....
18386	—	" Crank.....
18387	5017	Oscillating Shaft Crank complete, Nos. 237F, 1519E, 15171 and 18386.....
2049	5017	Oscillating Shaft Crank Pin.....
237F	5017	" " " Set Screw.....
15170	5017	" " " Slide Block.....
226E	8584	" " " " " Cap Screw.....
12424	5017	Oscillating Shaft Crank Slide Block Cap Screw Washer.....
1035c	5017	Oscillating Shaft Crank Slide Block Screw Stud.....

NO.	PLATE	NAME
1519E	5017	Oscillating Shaft Crank Slide Block Screw Stud Nut.....
15171	5017	Oscillating Shaft Crank Slide Block complete, Nos. 226E, 1035c, 12424 and 15170.....
2058	5002	Presser Bar.....
17841	3718	" " Collar with two 196F.....
196F	3718	" " " Set Screw.....
17842	3718	" " Guide Bracket with 453c.....
453c	5007	" " " Set Screw.....
17843	5006	" " Lifting Lever.....
17844	5006	" " " Bracket.....
164E	3724	" " " " " Screw..
1201c	5021	" " " " " Hinge Screw...
17845	5019	" " " " " Rod.....
17846	—	" " " " " Chain...
32675	8582	" " Spring.....
63975	8583	Pulley (loose) 2 3/4 in. diam.....
17848	5003	" " Bushing.....
2269	3722	" " " Position Pin.....
1202R	3724	" " Cap Screw.....
17942	5003	" (tight) 2 1/8 in. diam., with 2269...
2022	3722	" Pin.....
17955	—	Pulleys complete, Nos. 1202R, 1206c, 17848, 17854, 17942 and 63975.....
2996	5017	Shuttle Bobbin.....
62739	8584	" " Case.....
15140	5017	" " " Latch.....
2973	5017	" " " Lever.....
2974	5017	" " " " Fulcrum Pin.....
2975	5017	Shuttle Bobbin Case Latch Spring.....
592E	5017	" " " Stop Screw...
15141	—	Shuttle Bobbin Case Hinge, Nos. 2973, 2974 and 15140.....
15027	5017	Shuttle Bobbin Case Position Finger.....
2523	5017	" " " Rivet.....
15277	5017	Shuttle Bobbin Case complete, Nos. 591E, 592E, 2523, 2975, 15027, 15141, 15278 and 62739.....
21562	5017	Shuttle Body.....
591F	5017	" Tension Regulating Screw.....
15278	5017	" Spring.....
21561	5017	Shuttle, 1 1/4 in. diam., Nos. 2996, 15277 and 21562.....
*2542	—	Shuttle Driver.....
2441	5017	" " 2542 with two 462c.....

NO.	PLATE	NAME
2049	5017	Shuttle Driver Pin.....
462c	5017	" " Set Screw.....
18411	—	" Race Body.....
21623	5018	" " Cap.....
662d	5018	" " " Screw.....
2523	5018	" " " Steady Pin.....
18429	5018	" " Ring.....
18413	5018	" " Spring.....
1289d	5018	" " " " Screw.....
18430	5018	Shuttle Race (flexible) complete, Nos. 662d, 2523, 18411, 18429, 21623 and two each 1289d and 18413.....
171d	5018	Shuttle Race Screw.....
17853	5003	Starting Lever.....
1262c	5021	" " Hinge Screw.....
1662c	5021	" " " Nut.....
17886	5019	" " Pitman.....
17854	3721	Stop Cam.....
17855	3721	" " Interlocking Rod.....
55388	8585	" " " " Case.....
55389	—	" " " " " 5 5 3 8 8 with 18443 and two 193j.....
55418	—	Stop Cam Interlocking Rod Case 55389 with 63976 and two 1255d.....
*55285	—	Stop Cam Interlocking Rod Case 55418 with 1318d, 17855, 17863, 17864 and 39222.....
39346	5028	Stop Cam Interlocking Rod Case Bracket
55304	—	Stop Cam Interlocking Rod Case Bracket complete, Nos. 1182e, 1196c, 1204e, 1254c, 1262c, 1508e, 1662c, 17853, 17859 17861, 17862, 17872, 17873, 39346, 55285 and two 898d.....
18493	—	Stop Cam Interlocking Rod Case Bracket 55304 with 39343, 39344 and two 1186d
16532	3722	Stop Cam Interlocking Rod Case Bracket Dowel Pin.....
1343e	5021	Stop Cam Interlocking Rod Case Bracket Screw.....
1204e	3721	Stop Cam Interlocking Rod Case Hinge Screw.....
17859	5003	Stop Cam Interlocking Rod Case Socket Joint.....
898d	3721	Stop Cam Interlocking Rod Case Socket Joint Cap Screw.....
39343	5028	Stop Cam Interlocking Rod Case Spring (flat).....

NO.	PLATE	NAME
50682c	8584	Stop Cam Interlocking Rod Case Spring Adjusting Screw.....
1520e	3759	Stop Cam Interlocking Rod Case Spring Adjusting Screw Nut.....
39344	3759	Stop Cam Interlocking Rod Case Spring Bracket with 1520e and 50682c.....
1186d	5021	Stop Cam Interlocking Rod Case Spring Bracket Screw.....
17861	3721	Stop Cam Interlocking Rod Case Stop Stud.....
1254c	5021	Stop Cam Interlocking Rod Case Stop Stud Screw Bushing.....
1508e	5021	Stop Cam Interlocking Rod Case Stop Stud Screw Bushing Lock Nut.....
17862	3721	Stop Cam Interlocking Rod Case Stop Stud Spring.....
18443	5015	Stop Cam Interlocking Rod Case Wearing Block.....
193j	5015	Stop Cam Interlocking Rod Case Wearing Block Screw.....
17863	3721	Stop Cam Interlocking Rod Spring.....
17864	3721	" " " " Stop.....
1318d	3748	" " " " " Screw...
3012	3722	" " Pin.....
1206c	3721	" " Screw.....
2102	3722	Tension Disc.....
1560c	3722	" Regulating Thumb Nut.....
600c	3722	" Screw Stud.....
448c	3722	" " Set Screw.....
2103	3722	" Spring.....
2105	3722	" Thread Guard.....
*55302	—	Thread Take-up Cam.....
18392	5003	" " " 55302 with 446c....
3012	3722	" " " Pin.....
446c	3724	" " " Set Screw.....
*18393	5002	" " Lever with 1822.....
55283	—	" " " 18393 with 79c....
79c	5021	" " " Hinge Screw.....
1822	5021	" " " Roller and Stud...
2124	3722	" " Spring.....
2127	3722	" " " Regulator Plate
233j	3722	" " " " " "
		Adjusting Screw.....
17865	3710	Thread Wiper Body.....
1207d	3710	" " " Hinge Screw.....
17866	3710	" " " Hook.....
17867	3710	" " " Support.....

NO.	PLATE	NAME
641c	5021	Thread Wiper Body Support Set Screw..
17868	3710	" " " Wire.....
337j	3718	" " " " Screw.....
17869	3710	" " " " Washer..
55324	8586	Throat Plate with 55322 and two 42639..
55327	—	" " 55324 with 55325 and two 1208D.....
55325	8586	Throat Plate Needle Hole Bushing (large needle hole).....
1208D	5020	Throat Plate Needle Hole Bushing Screw..
55329	—	Throat Plate complete, Nos. 1698c, 17828, 50018f, 50117j, 55321, 55323 and 55327
691f	5015	Throat Plate Screw.....
17872	3721	Trip Lever.....
1196c	3721	" " Hinge Screw.....
17873	3721	" " Spring.....
1182E	3705	" " " Screw.....
17874	5009	Tripping Point.....
190j	3710	" " " Screw.....

MACHINE No. 69-6

FOR SEWING ON SMALL BUTTONS ONLY. FOR SHIRTS,
WAISTS, UNDERWEAR, ETC. MAKES CROSSED STITCHES
IN FOUR HOLE BUTTONS AND CAN BE ADJUSTED FOR
TWO HOLE AND BAR BUTTONS. MAKES ELEVEN CROSS
AND THREE TYING STITCHES.

This Machine is the same as 69-5, with
the following exceptions:

NO.	PLATE	NAME
18396	—	Feed Cam with two 1192c, three 17874 and six 190j, in place of 18395.....
55328	—	Throat Plate 55324 with 55326 and two 1208D.....
55326	8586	Throat Plate Needle Hole Bushing (small needle hole).....
55330	—	Throat Plate complete, Nos. 1698c, 17828, 50018f, 50117j, 55321, 55323 and 55328, in place of 55329.....

MACHINE No. 69-7

FOR SHOE TACKING. MAKES TWO STAY, NINE LONG, SEVEN
CROSS AND THREE TYING STITCHES.

This Machine is the same as 69-5, with
the following exceptions:

NO.	PLATE	NAME
63811	7205	Clamp Arm (lower) with two 17992.....
17992	3740	" " " Hook.....
63812	7205	" " (upper).....
39333	3761	" " Bracket.....
39336	3761	Clamp Arm Bracket (adjustable) complete, Nos. 129E, 1178D, 1300D, 1654c, 39333 to 39335 and 50048j, in place of 17713..
129E	3761	Clamp Arm Bracket Adjusting Screw.....
39334	3761	" " " Hinge Block.....
1300D	3761	" " " " " Screw, in place of 1177D.....
50048j	3761	Clamp Arm Bracket Hinge Screw (eccen- tric).....
1654c	3761	Clamp Arm Bracket Hinge Screw Nut....
17958	3733	" " Lifter with 17866, in place of 17708.....
190j	3710	Clamp Arm Lifter Screw.....
9330	3740	" " Pin.....
1178D	3761	" " Screw.....
39335	3761	" " " Plate.....
18490	—	Clamp complete, Nos. 1654c, 9330, 18365, 18367, 39304, 39336, 63811 and 63812, in place of 17898, 17904 and 63928.....
18397	—	Feed Cam with 17874 and two each 190j and 1192c, in place of 18395.....
39231	5005	Feed Cam Driving Worm with 1441c and 1442c, in place of 18415.....
17997	5004	Feed Cam Driving Worm Wheel with 453c, in place of 17797.....
39304	5014	Feed Plate, in place of 17800 and 17923..
55335	—	Throat Plate 55324 with 55334 and two 1208D.....
55334	8586	Throat Plate Needle Hole Bushing.....
55336	—	Throat Plate complete, Nos. 1698c, 17828, 50018f, 50117j, 55321, 55323 and 55335, in place of 55329.....

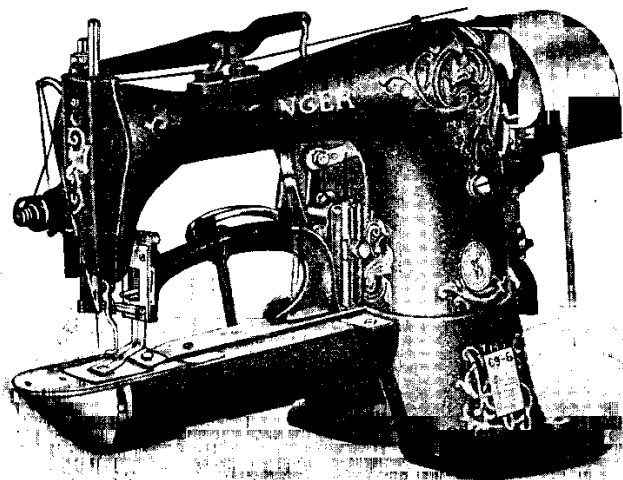

MACHINE No. 69-8

FOR BARRING POCKETS ON CLOTHING. MAKES BAR $\frac{5}{16}$ TO $\frac{5}{8}$ INCH LONG, CONSISTING OF TWELVE STAYING, TWENTY-SEVEN COVERING AND THREE TYING STITCHES.

This Machine is the same as 69-5, with the following exceptions:

NO.	PLATE	NAME
17964	3733	Arch Clamp Foot (left) with 17959.....
17965	3733	" " " (right) with 17959.....
17958	3733	" " " Lifter with 17866, in place of 17708.....
190r	3710	Arch Clamp Foot Lifter Screw.....
17959	3731	" " " Lifting Stud.....
17966	3733	" " " Plate.....
217j	3731	" " " " Screw.....
39302	3731	" " " Spring.....
17967	3733	" " " " Connection.....
1175d	3704	" " " " " Hinge Screw.....
217j	3731	Arch Clamp Foot Spring Screw.....
17968	3732	" " " Frame.....
14079	3731	" " " Dowel Pin.....
1177d	3710	" " " Screw.....

NO.	PLATE	NAME
18449	—	Arch Clamp complete, Nos. 1654c, 17964 to 17968, 17970, 18367, 18448, 39302, two each 1175d, 1177d, 14079 and five 217j, in place of 17898, 17904 and 63928
*55406	—	Arm with 4449, 17844 and two 164E, in place of 55405.....
55379	—	Feed Across Connection 55376 with 50598c and 55382, in place of 55378.....
18421	5009	Feed Across Shaft Crank (back) with 160E and 200c, in place of 18360.....
55382	8584	Feed Across Shaft Crank (back) Ball Stud, in place of 55381.....
18398	—	Feed Cam with 17874 and two each 190r and 1192c, in place of 18395.....
17970	3740	Feed Plate, in place of 17800 or 17923....
*18447	5012	" " Carrier Bar, in place of 18445.
18448	—	" " " " 18447 with 934j, 1195E, 1221c, 17743, 18366, 18390, two 55300 and four 17806, in place of 18365
39283	5009	Hand Stop Lever.....
5125L	8588	" " " Hinge Screw.....
39284	5000	" " " Rod.....
21678	5009	" " " " Collar with 1019c..
1019c	5009	" " " " Set Screw...
39285	5009	" " " " Connection.....
93F	5009	" " " Connection Screw.....
39286	5009	" " " Guide Stud (back).....
39287	5009	" " " " (front).....
1565D	5009	" " " Head.....
24122	5009	" " " Spring.....
39348	5028	Stop Cam Interlocking Rod Case Bracket
55305	—	Stop Cam Interlocking Rod Case Bracket complete, Nos. 1182E, 1196c, 1204E, 1254c, 1262c, 1508E, 1662c, 17853, 17859, 17861, 17862, 17872, 17873, 39348, 55285 and two 898D, in place of 55304.....
18494	—	Stop Cam Interlocking Rod Case Bracket 55305 with 39343, 39344 and two 1186D, in place of 18493.....

MACHINE No. 69-9

FOR BARRING BUTTONHOLES IN FINE WORK AND FOR FASTENING BOWS OR OTHER ORNAMENTS UPON SHOES OR GARMENTS. MAKES BAR $\frac{1}{8}$ TO $\frac{1}{4}$ INCH LONG, CONSISTING OF SEVEN STAYING, ELEVEN COVERING AND THREE TYING STITCHES.

This Machine is the same as 69-5, with the following exceptions:

NO.	PLATE	NAME
18431	5011	Arch Clamp Foot (left) with 17959.....
18432	5011	" " " (right) with 17959.....
17958	3733	" " " Lifter with 17866, in place of 17708.....
190j	3710	Arch Clamp Foot Lifter Screw.....
17959	3731	" " " Lifting Stud.....
18433	5011	" " " Plate.....
217j	3731	" " " Screw.....
39302	3731	" " " Spring.....
18434	5011	" " " Connection.....
1175j	3704	" " " " Hinge Screw.....
217j	3731	Arch Clamp Foot Spring Screw.....
18435	5010	" " " Frame.....
14079	3731	" " " Dowel Pin.....
181D	3738	" " " Screw.....
18436	—	Arch Clamp complete, Nos. 1654c, 18367, 18431 to 18435, 18438, 18459, 39302, two each 181D, 1175j, 14079 and five 217j, in place of 17898, 17904 and 63928.....
55379	—	Feed Across Connection 55376 with 50598c and 55382, in place of 55378.....
18421	5009	Feed Across Shaft Crank (back) with 160e and 200c, in place of 18360.....
55382	8584	Feed Across Shaft Crank (back) Ball Stud, in place of 55381.....
18399	—	Feed Cam with two each 1192c, 17874 and four 190j, in place of 18395.....
18459	5011	Feed Plate, in place of 17800 or 17923.....
*18437	5012	" " " Carrier Bar, in place of 18445.....
18438	—	" " " " 18437 with 934j, 1195e, 1221c, 17743, 18366, 18390 two 55300 and four 17806, in place of 18365.....
55328	—	Throat Plate 55324 with 55326 and two 1208D.....

NO.	PLATE	NAME
55326	8586	Throat Plate Needle Hole Bushing (small needle hole).....
55330	—	Throat Plate complete, Nos. 1698c, 17828, 50018F, 50117j, 55321, 55323 and 55328, in place of 55329.....

MACHINE No. 69-10

FITTED WITH CLAMP. FOR CLOSING BUTTONHOLE BEFORE BARRING.

This Machine is the same as 69-5, with the following exceptions:

NO.	PLATE	NAME
17976	3737	Clamp Arm (lower) left.....
17977	3737	" " " right.....
17978	3737	" " " Bracket.....
181D	3738	" " " " Screw.....
7401	3738	" " " " Steady Pin..
90D	3738	" " " " Hinge Screw.....
17979	3738	" " " (upper) left, with 17986 and 39257.....
17980	3738	Clamp Arm (upper) right, with 17986 and 39257.....
17981	3737	Clamp Arm (upper) Bracket.....
14008	3737	" " " " Hinge Pin...
90D	3738	" " " " Hinge Screw.....
39257	5009	" " " " Hook.....
17958	3733	" " " " Lifter with 17866, in place of 17708.....
190j	3710	Clamp Arm (upper) Lifter Screw.....
17982	3738	" " " Pressure Spring.....
17713	3710	" " " " Bracket.....
1177D	3710	" " " " " Screw....
1178D	3710	" " " " " Screw.....
17983	3737	" " " Spreader Lever.....
957K	3738	" " " " Cap Screw.....
17984	3738	" " " " Friction Washer...
17985	3738	" " " " Hinge Stud.....
17986	3738	" " " " Stud.....
18452	—	Clamp complete, Nos. 181D, 957K, 1177D, 1178D, 14008, 17713, 17976 to 17984, 17988, 17989, 18367, 18451, two 7401 and four each 90D and 17806, in place of 17898, 17904 and 63928.....

NO.	PLATE	NAME
18399	—	Feed Cam with two each 1192c, 17874 and four 190r, in place of 18395.....
17988	3737	Feed Plate (left).....
17989	3737	“ “ (right).....
17806	5013	“ “ Rivet.....
*18450	5012	“ “ Carrier Bar, in place of 18445
18451	—	“ “ “ “ 18450 with 934r, 1221c, 17743, 17985, 18366, 18390 and two 55300, in place of 18365.....
55328	—	Throat Plate 55324 with 55326 and two 1208d.....
55326	8586	Throat Plate Needle Hole Bushing (small needle hole).....
55330	—	Throat Plate complete, Nos. 1698c, 17828, 50018f, 50117r, 55321, 55323 and 55328, in place of 55329.....

MACHINE No. 69-11

FOR SEWING STRAPS UPON UNDERWEAR AND OTHER GARMENTS. MAKES BAR $\frac{3}{8}$ TO $\frac{7}{8}$ INCH LONG, CONSISTING OF THREE STAYING, THIRTY-SIX COVERING AND THREE TYING STITCHES.

This Machine is the same as 69-5, with the following exceptions:

NO.	PLATE	NAME
17957	3731	Arch Clamp Foot with 17959.....
39206	3731	“ “ “ Lifter with 17866, in place of 17708.....
190r	3710	Arch Clamp Foot Lifter Screw.....
17959	3731	“ “ “ Lifting Stud.....
17960	3731	“ “ “ Plate.....
217r	3731	“ “ “ Screw.....
39303	3731	“ “ “ Spring.....
217r	3731	“ “ “ Screw (lower)....
1175d	3704	“ “ “ “ “ (upper)....
39250	5010	“ “ “ Frame.....
14079	3731	“ “ “ Dowel Pin.....
181d	3738	“ “ “ Screw.....
18453	—	Arch Clamp complete, Nos. 1175d, 1654c, 17957, 17960, 17963, 18367, 18438, 39250, 39303, two each 181d, 14079 and five 217r, in place of 17898, 17904 and 63928.....

NO.	PLATE	NAME
55379	—	Feed Across Connection 55376 with 50598c and 55382, in place of 55378.....
18421	5009	Feed Across Shaft Crank (back) with 160e and 200c, in place of 18360.....
55382	8584	Feed Across Shaft Crank (back) Ball Stud, in place of 55381.....
18401	—	Feed Cam with 17874 and two each 190r and 1192c, in place of 18395.....
17963	3731	Feed Plate, in place of 17800 and 17923..
*18437	5012	“ “ Carrier Bar, in place of 18445.
18438	—	“ “ “ “ 18437 with 934r, 1195e, 1221c, 17743, 18366, 18390, two 55300 and four 17806, in place of 18365
18426	5000	Knife Bar with 18373 and two 17822, in place of 18370.....
55332	—	Throat Plate 55324 with 55331 and two 1208d.....
55331	8586	Throat Plate Needle Hole Bushing.....
55333	—	Throat Plate complete, Nos. 1698c, 17828, 50018f, 50117r, 55321, 55323 and 55332, in place of 55329.....

MACHINE No. 69-12

FOR SHOE TACKING. MAKES TACK UP TO $\frac{3}{8}$ IN. LONG, CONSISTING OF TWO STAY, NINE LONG AND SEVEN CROSS STITCHES.

This Machine is the same as 69-5, with the following exceptions:

NO.	PLATE	NAME
63811	7205	Clamp Arm (lower) with two 17992.....
17992	3740	“ “ “ Hook.....
63812	7205	“ “ (upper).....
39333	3761	“ “ Bracket.....
39336	3761	Clamp Arm Bracket (adjustable) complete, Nos. 129e, 1178d, 1300d, 1654c, 39333 to 39335 and 50048r, in place of 17713..
129e	3761	Clamp Arm Bracket Adjusting Screw.....
39334	3761	“ “ “ Hinge Block.....
1300d	3761	“ “ “ “ “ Screw, in place of 1177d.....
50048r	3761	Clamp Arm Bracket Hinge Screw (eccentric).....
1654c	3761	Clamp Arm Bracket Hinge Screw Nut....
17958	3733	“ “ Lifter with 17866, in place of 17708.....

NO.	PLATE	NAME
190r	3710	Clamp Arm Lifter Screw.....
9330	3740	" " Pin.....
1178d	3761	" " Screw.....
39335	3761	" " " Plate.....
18490	---	Clamp complete, Nos. 1654c, 9330, 18365, 18367, 39304, 39336, 63811 and 63812, in place of 17898, 17904 and 63928.....
55380	---	Feed Across Connection 55376 with 50598c and 55383, in place of 55378.....
18421	5009	Feed Across Shaft Crank (back) with 160r and 200c, in place of 18360.....
55383	8584	Feed Across Shaft Crank (back) Ball Stud, in place of 55381.....
18402	---	Feed Cam with two each 1192c, 17874 and four 190r, in place of 18395.....
39211	5005	Feed Cam Driving Worm with 1441c and 1442c, in place of 18415.....
39212	5002	Feed Cam Driving Worm Wheel with 453c, in place of 17797.....
39304	5014	Feed Plate, in place of 17800 and 17923..
55335	---	Throat Plate 55324 with 55334 and two 1208d.....
55334	8586	Throat Plate Needle Hole Bushing.....
55336	---	Throat Plate complete, Nos. 1698c, 17828, 50018f, 50117j, 55321, 55323 and 55335, in place of 55329.....

MACHINE No. 69-13

**MAKES ELEVEN CROSS AND THREE FASTENING OR TYING
STITCHES. FOR TACKING BOWS OR OTHER ORNAMENTS
TO SHOES.**

**This Machine is the same as 69-5, with
the following exceptions:**

NO.	PLATE	NAME
17999	3739	Clamp Arm with two 39257.....
39333	3761	" " Bracket.....
39336	3761	Clamp Arm Bracket (adjustable) com- plete, Nos. 129e, 1178d, 1300d, 1654c, 39333 to 39335 and 50048r, in place of 17713.....
129e	3761	Clamp Arm Bracket Adjusting Screw.....
39334	3761	" " " Hinge Block.....
1300d	3761	" " " " " Screw, in place of 1177d.....

NO.	PLATE	NAME
50048r	3761	Clamp Arm Bracket Hinge Screw (eccen- tric).....
1654c	3761	Clamp Arm Bracket Hinge Screw Nut....
39257	5009	" " Hook.....
17958	3733	" " Lifter with 17866, in place of 17708.....
190r	3710	Clamp Arm Lifter Screw.....
1178d	3761	" " Screw.....
39335	3761	" " " Plate.....
18491	---	Clamp complete, Nos. 1654c, 17999, 18365, 18367, 39258 and 39336, in place of 17898, 17904 and 63928.....
18403	---	Feed Cam with two 1192c, three 17874 and six 190r, in place of 18395.....
39258	5014	Feed Plate (thin) in place of 17800.....
39362	---	" " (thick) in place of 17923.....
55328	---	" " 55324 with 55326 and two 1208d.....
55326	8586	Throat Plate Needle Hole Bushing (small needle hole).....
55330	---	Throat Plate complete, Nos. 1698c, 17828, 50018f, 50117j, 55321, 55323 and 55328, in place of 55329.....

**Genuine Singer Needles and their Con-
tainers are marked with the Company's
Trade Mark "SIMANCO." 1**

**Needles in Containers marked
"For Singer Machines"
are not Singer made needles. 2**

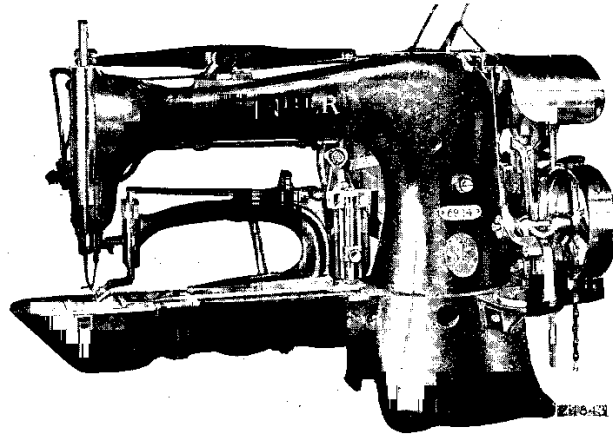

MACHINE No. 69-14

FOR TACKING BLUCHER SHOES. MAKES TACK $\frac{7}{32}$ TO $\frac{1}{16}$ INCH LONG, CONSISTING OF EIGHTEEN STAYING IN TWO PARALLEL LINES AND THREE TYING STITCHES.

This Machine is the same as 69-5, with the following exceptions:

NO.	PLATE	NAME
18473	5030	Arch Clamp Foot (left).....
55384	—	“ “ “ “ 18473 with 219k and 63731.....
18475	5030	Arch Clamp Foot (right).....
55385	—	“ “ “ “ 18475 with 219k and 63732.....
17958	3733	Arch Clamp Foot Lifter with 17866, in place of 17708.....
190j	3710	Arch Clamp Foot Lifter Screw.....
63726	8582	“ “ “ Lifting Stud.....
18477	5030	“ “ “ Plate.....
190j	3710	“ “ “ “ Screw.....
219k	5030	“ “ “ Screw.....
63731	—	“ “ “ Shank (left) with 63726
63732	—	“ “ “ “ (right) with 63726
63733	8585	“ “ “ Spring.....
1229f	5021	“ “ “ Adjusting Screw
1547j	5021	“ “ “ “ “
		Lock Nut.....

NO.	PLATE	NAME
63734	8583	Arch Clamp Frame.....
14079	3731	“ “ “ Dowel Pin.....
181d	3738	“ “ “ Screw.....
55386	—	Arch Clamp complete, Nos. 1654c, 18367, 18477, 18484, 18486, 55384, 55385, 63734, two each 181d, 1229f, 1547j, 14079, 63733 and four 190j, in place of 17898, 17904 and 63928.....
18404	—	Feed Cam with two each 190j, 1192c and 17874, in place of 18395.....
18484	5030	Feed Plate, in place of 17800 and 17923...
*18485	5012	“ “ Carrier Bar, in place of 18445
18486	—	“ “ “ “ 18485 with 810d, 934j, 1195e, 1221c, 18366, 18390, 18488, 18489, two 55300 and four 17806, in place of 18365.....
18487	5029	Feed Regulator with 1953, in place of 17742.....
18488	3759	Feed Regulator Post, in place of 17743...
18489	3759	“ “ “ Guide.....
810d	3759	“ “ “ “ Cap Screw...
55328	—	Throat Plate 55324 with 55326 and two 1208d.....
55326	8586	Throat Plate Needle Hole Bushing (small needle hole).....
55330	—	Throat Plate complete, Nos. 1698c, 17828, 50018f, 50117j, 55321, 55323 and 55328, in place of 55329.....

MACHINE No. 69-15

FOR STITCHING LARGE BUTTONS UPON COATS, CLOAKS, OVERCOATS, ETC. MAKES CROSSED STITCHES IN FOUR HOLE BUTTONS AND CAN BE ADJUSTED FOR TWO HOLE AND BAR BUTTONS. NEEDLE THROW $\frac{3}{8}$ TO $\frac{1}{2}$ INCH. MAKES EIGHTEEN CROSS AND THREE TYING STITCHES.

This Machine is the same as 69-5, with the following exceptions:

NO.	PLATE	NAME
18464	3764	Button Clamp (left) with 9311 and 17723
18465	3764	“ “ (right) with 9311 and 17723
18466	3764	“ “ Stop with two 17720.....

NO.	PLATE	NAME
63929	—	Button Clamp (universal) complete, for 26 to 55 line buttons, Nos. 1180j, 1181j, 1182j, 1183j, 17717 to 17719, 18464 to 18466, 39242, 39244 or 39246, 39245 or 39247, 50237κ, 63927 and two each 229j and 1175j, in place of 17898, 17904 and 63928.....
18405	—	Feed Cam with 17874 and two each 190j and 1192c, in place of 18395.....
39231	5005	Feed Cam Driving Worm with 1441c and 1442c, in place of 18415.....
17997	5004	Feed Cam Driving Worm Wheel with 453c, in place of 17797.....
18468	3764	Feed Plate, in place of 17800 and 17923..
39312	5029	" Regulator with 1953, in place of 17742.....
18469	5029	Feed Regulator Bracket with 690d, 39310 and two 160d, in place of 18369.....
*39310	—	Feed Regulator Bracket Cap, in place of 17732.....
39313	3759	Feed Regulator Swivel, in place of 17745

MACHINE No. 69-16

FOR TACKING MEN'S AND BOYS' BLUCHER SHOES. MAKES TACK $\frac{3}{8}$ TO $\frac{1}{4}$ INCH LONG, CONSISTING OF EIGHTEEN STITCHES IN TWO PARALLEL LINES AND THREE TYING STITCHES. HAS LONG BEAK SHUTTLE.

This Machine is the same as 69-5, with the following exceptions:

NO.	PLATE	NAME
18473	5030	Arch Clamp Foot (left).....
55384	—	" " " " 18473 with 219κ and 63731.....
18475	5030	Arch Clamp Foot (right).....
55385	—	" " " " 18475 with 219κ and 63732.....
17958	3733	Arch Clamp Foot Lifter with 17866, in place of 17708.....
190j	3710	Arch Clamp Foot Lifter Screw.....
63726	8582	" " " " Lifting Stud.....
18477	5030	" " " " Plate.....
190j	3710	" " " " Screw.....
219κ	5030	" " " " Screw.....

NO.	PLATE	NAME
63731	—	Arch Clamp Foot Shank (left) with 63726
63732	—	" " " " (right) with 63726
63733	8585	" " " " Spring.....
1229f	5021	" " " " Adjusting Screw
1547j	5021	" " " " " "
		Lock Nut.....
63734	8583	Arch Clamp Frame.....
14079	3731	" " " " Dowel Pin.....
181j	5021	" " " " Screw.....
55386	—	Arch Clamp complete, Nos. 1654c, 18367, 18477, 18484, 18486, 55384, 55385, 63734, two each 181j, 1229f, 1547j, 14079, 63733 and four 190j, in place of 17898, 17904 and 63928.....
*55408	—	Cylinder, in place of 55407.....
18406	—	Feed Cam with two each 190j, 1192c and 17874, in place of 18395.....
18484	5030	Feed Plate, in place of 17800 and 17923..
*18485	5012	" " " " Carrier Bar, in place of 18445
18486	—	" " " " 18485 with 810d, 934j, 1195e, 1221c, 18366, 18390, 18488, 18489, two 55300 and four 17806, in place of 18365.....
18487	5029	Feed Regulator with 1953, in place of 17742.....
18488	3759	Feed Regulator Post, in place of 17743...
18489	3759	" " " " Guide.....
810d	3759	" " " " Cap Screw...
55397	8582	Knife (needle thread) in place of 55319...
55398	—	" Holder 17825 with 1198c, 17829, 55320 and 55397, in place of 55323.....
55399	—	Knife (stationary) Bracket, in place of 55322.....
6023	5028	Oscillating Shaft, in place of 18385.....
2073	3702	Shuttle Bobbin, in place of 2996.....
2211	3702	" " " " Retaining Spring.....
2212	3702	" " " " Rivet...
*39295	—	" Body with 398e, 2082, 2084, 2211 and two 2212.....
*2075	—	Shuttle Cover.....
*44001	—	" " 2075 with 112d, 466h, 2078, 2080, 2086 and 2090.....
2076	3702	Shuttle Cover Hinge Pin.....
2078	3702	" Delivery Eye Thread Guard.....
2080	3702	" " " " Rivet
2082	3702	" Main Spring.....
398e	3702	" " " " Screw.....

NO.	PLATE	NAME
2084	3702	Shuttle Main Spring Steady Pin.....
466H	3702	" Tension Regulating Screw.....
2086	3702	" " Spring.....
2090	3702	" " " Plate.....
112D	3702	" " " Screw.....
39296	3702	Shuttle complete, Nos. 2073, 2076, 39295 and 44001, in place of 21561.....
39487	3702	Shuttle Driver with two 457c, in place of 2441.....
457c	3702	Shuttle Driver Set Screw.....
55400	---	Shuttle Race Body, in place of 18411.....
55271	5032	" " Ring, in place of 18429.....
55401	---	Shuttle Race complete, Nos. 55271, 55400, and two each 1289D and 18413, in place of 18430.....
198D	5021	Shuttle Race Screw, in place of 171D.....
*63749	---	Thread Take-up Cam, in place of 55302..
39204	5028	" " " 63749 with 446c, in place of 18392.....
3072	5028	Thread Take-up Lever with 1819, in place of 18393.....
56756	---	Thread Take-up Lever 3072 with 76c, in place of 55283.....
76c	8584	Thread Take-up Lever Hinge Screw, in place of 79.....
1819	8584	Thread Take-up Lever Roller and Stud, in place of 1822.....
55402	8587	Throat Plate with 55399 and two 42639..
55403	---	" " 55402 with 55325 and two 1208D.....
55325	8586	Throat Plate Needle Hole Bushing (large needle hole).....
55404	---	Throat Plate complete, Nos. 1698c, 17828, 50018F, 50117J, 55321, 55398 and 55403, in place of 55329.....

Genuine Singer Needles and their Containers are marked with the Company's Trade Mark "SIMANCO." 1

Needles in Containers marked "For Singer Machines" are not Singer made needles. 2

MACHINE No. 69-17

FOR STITCHING TWO OR FOUR HOLE GROOVED BUTTONS ON MEN'S AND BOYS' CLOTHING. MAKES TWO SEPARATE BARS IN FOUR HOLE BUTTONS; NO CROSS STITCHES BETWEEN THE BARS. AFTER THE FIRST BAR IS COMPLETED AND THE THREAD CUT, THE CLAMP AUTOMATICALLY BRINGS THE BUTTON INTO POSITION FOR THE SECOND BAR. MAKES EIGHTEEN STITCHES, INCLUDING THREE TYING STITCHES, TO EACH BAR.

This Machine is the same as 69-5, with the following exceptions:

NO.	PLATE	NAME
55308	---	Feed Cam with two each 1192c, 17874 and four 190J, in place of 18395.....
39211	5005	Feed Cam Driving Worm with 1441c and 1442c, in place of 18415.....
39212	5002	Feed Cam Driving Worm Wheel with 453c, in place of 17797.....

Genuine Singer Needles and their Containers are marked with the Company's Trade Mark "SIMANCO." 1

Needles in Containers marked "For Singer Machines" are not Singer made needles. 2

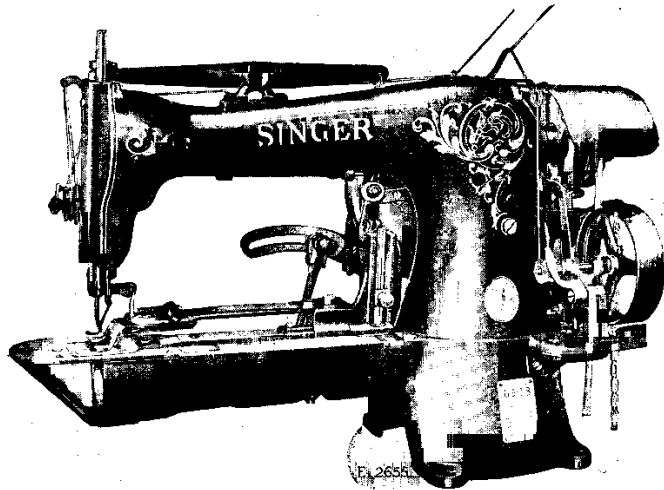

MACHINE No. 69-18

FOR STITCHING TWO OR FOUR HOLE GROOVED BUTTONS ON MEN'S AND BOYS' CLOTHING. MAKES TWO SEPARATE BARS IN FOUR HOLE BUTTONS; NO CROSS STITCHES BETWEEN THE BARS. AFTER THE FIRST BAR IS COMPLETED AND THE THREAD CUT, THE CLAMP AUTOMATICALLY BRINGS THE BUTTON INTO POSITION FOR THE SECOND BAR. MAKES NINE STITCHES, INCLUDING THREE TYING STITCHES, TO EACH BAR.

This Machine is the same as 69-5, with the following exceptions:

NO.	PLATE	NAME
55309	—	Feed Cam with two 1192c, four each 190j and 17874, in place of 18395.....
39211	5005	Feed Cam Driving Worm with 1441c and 1442c, in place of 18415.....
39212	5002	Feed Cam Driving Worm Wheel with 453c, in place of 17797.....
55328	—	Throat Plate 55324 with 55326 and two 1208d.....
55326	8586	Throat Plate Needle Hole Bushing (small needle hole).....
55330	—	Throat Plate complete, Nos. 1698c, 17828, 50018f, 50117i, 55321, 55323 and 55328, in place of 55329.....

LIST OF PARTS COMPLETE FOR

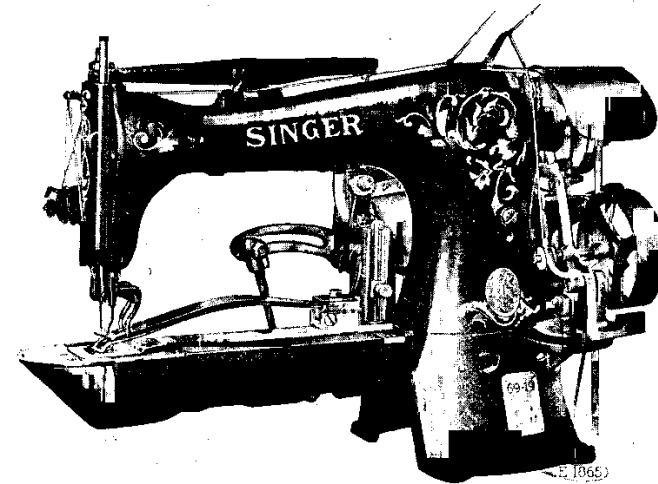

MACHINE No. 69-19

FOR SHOE TACKING. MAKES TACK UP TO 3/8 INCH LONG, CONSISTING OF TWO STAY, NINE LONG AND SEVEN CROSS STITCHES. HAS LONG BEAK SHUTTLE. OTHERWISE SAME AS NO. 69-12 MACHINE.

NO.	PLATE	NAME
*55405	—	Arm with 4449, 17844 and two 164e.....
4389	5042	" Dowel Pin.....
4448	3722	" Oil Tube, for intermediate bearing...
880e	3724	" Screw.....
17702	5000	" Shaft.....
17703	5001	" " Bushing (back).....
50333c	5042	" " " " Adjusting Screw
1520e	3724	" " " " " " " " " "
		Nut.....
*4449	—	Arm Shaft Bushing (front).....
124674	8583	" Side Cover.....
190j	3710	" " " Screw.....
18498	5044	Belt Cover.....
39290	5001	" " Bracket with 184e and 17741.

NO.	PLATE	NAME
184E	5021	Belt Cover Bracket Screw Stud.....
17741	5008	" " " Stud.....
217J	3731	" " Screw.....
39222	5001	" Shifter.....
63976	8582	" " Clamp.....
1255D	5021	" " " Screw.....
63811	7205	Clamp Arm (lower) with two 17992.....
17992	3740	" " " Hook.....
63812	7205	" " (upper).....
39333	3761	" " Bracket.....
39336	3761	Clamp Arm Bracket (adjustable) complete, Nos. 129E, 1178D, 1300D, 1654C, 39333 to 39335 and 50048J.....
129E	3761	Clamp Arm Bracket Adjusting Screw....
39334	3761	" " " Hinge Block.....
1300D	3761	" " " " Screw..
50048J	3761	" " " " Screw (eccentric).....
1654C	3761	Clamp Arm Bracket Hinge Screw Nut....
17958	3733	" " Lifter with 17866.....
190J	3710	" " " Screw.....
9330	3740	" " Pin.....
1178D	3761	" " Screw.....
39335	3761	" " " Plate.....
18490	—	Clamp complete, Nos. 1654C, 9330, 18365, 18367, 39304, 39336, 63811 and 63812..
4292	5002	Crank Connecting Rod.....
375C	3724	" " " Hinge Screw.....
1518E	3718	" " " " Nut.
*55408	—	Cylinder.....
18388	5008	" Block.....
1300D	3748	" " Screw.....
18427	5001	" End Cover with 18428, 18444 and three 4604.....
18428	5008	Cylinder End Cover Bracket.....
18444	5008	" " " " Hinge Pin...
4604	5008	" " " " Rivet.....
18379	5008	" " " Spring.....
217E	3731	" " " " Screw.....
17724	5001	Face Plate.....
*63736	—	" " 17724 with 2105.....
17725	—	Face Plate complete, Nos. 448C, 600C, 1560C, 2103, 2107, 2124, 2127, 63736 and two each 233J and 2102.....
164J	3724	Face Plate Screw.....
2107	3722	" " Thread Guard.....
233J	3722	" " " " Screw.....

NO.	PLATE	NAME
55376	8585	Feed Across Connection with 21358, 55377 and four 1057E.....
55378	—	Feed Across Connection 55376 with 50598C and 55381.....
*21358	—	Feed Across Connection Cap (lower)....
1057E	8584	" " " " " Screw
*55377	—	" " " " (upper)....
1057E	8584	" " " " " Screw
18356	5006	" " Regulator with 1952.....
50598C	8584	" " " Ball Screw Stud
1676C	5008	" " " " " " Nut.....
17738	5008	Feed Across Regulator Ball Screw Stud Nut Washer.....
18357	5008	Feed Across Regulator Hinge Stud.....
690D	3748	" " " " " Clamping Screw.....
1952	5008	Feed Across Regulator Roller and Stud...
18358	5002	" " Shaft.....
18359	5008	" " " Collar with two 200F...
200F	5008	" " " " Set Screw.....
18421	5009	" " " Crank (back) with 160E and 200C.....
55381	8584	Feed Across Shaft Crank (back) Ball Stud
200C	5008	" " " " " " " Set Screw.....
160E	5008	Feed Across Shaft Crank (back) Clamping Screw.....
18362	5007	Feed Across Shaft Crank (front) with 160E and 18363.....
160E	5008	Feed Across Shaft Crank (front) Clamping Screw.....
18363	5007	Feed Across Shaft Crank (front) Stud
18364	5007	" " " " " " " Slide Block.....
17766	—	Feed Cam with two each 1192C, 17874 and four 190J.....
39211	5005	Feed Cam Driving Worm with 1441C and 1442C.....
1442C	5021	Feed Cam Driving Worm Position Screw..
1441C	5021	" " " " " Set Screw.....
39212	5002	" " " " " Wheel with 453C
3012	3722	" " " " " Pin.....
453C	5007	" " " " " Set Screw
18384	5007	" " Pin.....
1192C	3724	" " Set Screw.....
62155	8585	" " Shaft.....

NO.	PLATE	NAME
50018F	5021	Knife Holder Pinion Stud Bracket Screw
1698c	5021	" " " " " "
		Nut.....
1198c	5015	Knife Screw.....
17829	5015	" Thread Holder.....
17830	5015	" " " Position Pin.....
17831	5002	Needle Bar with 237F.....
*39203	3718	" " Connecting Link.....
377c	3718	" " " Hinge Screw
1518E	3718	" " " " " "
		Nut.....
21629	3718	Needle Bar Connecting Stud with 155c...
155c	3718	" " " " Set Screw...
39350	5029	" " Thread Nipper Driving Lever (adjustable) with 39351 and two 335J..
39351	3759	Needle Bar Thread Nipper Driving Lever Extension.....
335J	3759	Needle Bar Thread Nipper Driving Lever Extension Screw.....
1196c	3721	Needle Bar Thread Nipper Driving Lever Hinge Screw.....
39352	5029	Needle Bar Thread Nipper Driving Lever Spring.....
17834	3718	Needle Bar Thread Nipper Lever with 17835.....
17835	3718	Needle Bar Thread Nipper Lever Bushing
1200D	3718	" " " " " Hinge Screw.....
39276	5009	Needle Bar Thread Nipper Lever Spring
1329J	5009	" " " " " "
		Screw.....
17837	5019	Needle Bar Thread Nipper Rod.....
17838	3718	" " " " " Adjusting Stud.....
1651E	5021	Needle Bar Thread Nipper Rod Adjusting Stud Lock Nut.....
17839	3718	Needle Bar Thread Nipper Rod Arm with 196F.....
196F	3718	Needle Bar Thread Nipper Rod Arm Set Screw.....
17840	5001	Needle Bar Thread Nipper Rod Support
190J	3710	" " " " " "
		Screw.....
237F	3724	Needle Set Screw.....
*6022	5001	Oscillating Rock Shaft with 4784.....
16806	—	" " " 6022 with 56812....
3052	8585	" " " Hinge Pin.....

NO.	PLATE	NAME
56812	—	Oscillating Rock Shaft Hinge Pin 3052 with 1513J.....
1513J	3724	Oscillating Rock Shaft Hinge Pin Nut....
4784	5009	" " " Oil Pad.....
6023	5028	" Shaft.....
18386	—	" " Crank.....
18387	5017	Oscillating Shaft Crank complete, Nos. 237F, 1519E, 15171 and 18386.....
2049	5017	Oscillating Shaft Crank Pin.....
237F	5017	" " " Set Screw.....
15170	5017	" " " Slide Block.....
226E	8584	" " " " " Cap Screw.....
12424	5017	Oscillating Shaft Crank Slide Block Cap Screw Washer.....
1035c	5017	Oscillating Shaft Crank Slide Block Screw Stud.....
1519E	5017	Oscillating Shaft Crank Slide Block Screw Stud Nut.....
15171	5017	Oscillating Shaft Crank Slide Block comple- te, Nos. 226E, 1035c, 12424 and 15170
2058	5002	Presser Bar.....
17841	3718	" " Collar with two 196F.....
196F	3718	" " " Set Screw.....
17842	3718	" " Guide Bracket with 453c.....
453c	5007	" " " " Set Screw....
17843	5006	" " Lifting Lever.....
17844	5006	" " " " Bracket.....
164E	3724	" " " " " Screw..
1201c	5021	" " " " Hinge Screw...
17845	5019	" " " " Rod.....
17846	—	" " " " " Chain....
32675	8582	" " Spring.....
63975	8583	Pulley (loose) 2¾ in. diam.....
17848	5003	" " Bushing.....
2269	3722	" " " Position Pin.....
1202R	3724	" " Cap Screw.....
17942	5003	" (tight) 2⅞ in. diam., with 2269....
2022	3722	" " Pin.....
17955	—	Pulleys complete, Nos. 1202R, 1206c, 17848, 17854, 17942 and 63975.....
2073	3702	Shuttle Bobbin.....
2211	3702	" " Retaining Spring.....
2212	3702	" " " Rivet...
*39295	—	" Body with 398E, 2082, 2084, 2211 and two 2212.....
*2075	—	Shuttle Cover.....

NO.	PLATE	NAME
*44001	-----	Shuttle Cover 2075 with 112d, 466h, 2078, 2080, 2086 and 2090.....
2076	3702	Shuttle Cover Hinge Pin.....
2078	3702	" Delivery Eye Thread Guard.....
2080	3702	" " " " Rivet
2082	3702	" Main Spring.....
398E	3702	" " " Screw.....
2084	3702	" " " Steady Pin.....
466h	3702	" Tension Regulating Screw.....
2086	3702	" " Spring.....
2090	3702	" " " Plate.....
112d	3702	" " " Screw.....
39296	3702	Shuttle complete, Nos. 2073, 2076, 39295 and 44001.....
39487	3702	Shuttle Driver with two 457c.....
2049	3702	" " Pin.....
457c	3702	" " Set Screw.....
55400	-----	" Race Body.....
55271	5032	" " Ring.....
18413	5018	" " " Spring.....
1289d	5018	" " " " Screw.....
55401	-----	Shuttle Race complete, Nos. 55271, 55400 and two each 1289d and 18413.....
198d	5021	Shuttle Race Screw.....
17853	5003	Starting Lever.....
1262c	5021	" " Hinge Screw.....
1662c	5021	" " " " Nut.....
17886	5019	" " Pitman.....
17854	3721	Stop Cam.....
17855	3721	" " Interlocking Rod.....
55388	8585	" " " " Case.....
55389	-----	" " " " " " 5 3 8 8 with 18443 and two 193j.....
55418	-----	Stop Cam Interlocking Rod Case 55389 with 63976 and two 1255d.....
*55285	-----	Stop Cam Interlocking Rod Case 55418 with 1318d, 17855, 17863, 17864 and 39222.....
39346	5028	Stop Cam Interlocking Rod Case Bracket
55304	-----	Stop Cam Interlocking Rod Case Bracket complete, Nos. 1182E, 1196c, 1204E, 1254c, 1262c, 1508E, 1662c, 17853, 17859, 17861, 17862, 17872, 17873, 39346, 55285 and two 898d.....
18493	-----	Stop Cam Interlocking Rod Case Bracket 55304 with 39343, 39344 and two 1186d

NO.	PLATE	NAME
16532	3722	Stop Cam Interlocking Rod Case Bracket Dowel Pin.....
1343E	5021	Stop Cam Interlocking Rod Case Bracket Screw.....
1204E	3721	Stop Cam Interlocking Rod Case Hinge Screw.....
17859	5003	Stop Cam Interlocking Rod Case Socket Joint.....
898d	3721	Stop Cam Interlocking Rod Case Socket Joint Cap Screw.....
39343	5028	Stop Cam Interlocking Rod Case Spring (flat).....
50682c	8584	Stop Cam Interlocking Rod Case Spring Adjusting Screw.....
1520E	3759	Stop Cam Interlocking Rod Case Spring Adjusting Screw Nut.....
39344	3759	Stop Cam Interlocking Rod Case Spring Bracket with 1520E and 50682c.....
1186d	5021	Stop Cam Interlocking Rod Case Spring Bracket Screw.....
17861	3721	Stop Cam Interlocking Rod Case Stop Stud.....
1254c	5021	Stop Cam Interlocking Rod Case Stop Stud Screw Bushing.....
1508E	5021	Stop Cam Interlocking Rod Case Stop Stud Screw Bushing Lock Nut.....
17862	3721	Stop Cam Interlocking Rod Case Stop Stud Spring.....
18443	5015	Stop Cam Interlocking Rod Case Wearing Block.....
193j	5015	Stop Cam Interlocking Rod Case Wearing Block Screw.....
17863	3721	Stop Cam Interlocking Rod Spring.....
17864	3721	" " " " Stop.....
1318d	3748	" " " " " Screw...
3012	3722	" " Pin.....
1206c	3721	" " Screw.....
2102	3722	Tension Disc.....
1560c	3722	" Regulating Thumb Nut.....
600c	3722	" Screw Stud.....
448c	3722	" " " Set Screw.....
2103	3722	" Spring.....
2105	3722	" Thread Guard.....
*63749	-----	Thread Take-up Cam.....
39204	5028	" " " 63749 with 446c....
3012	3722	" " " Pin.....
446c	3724	" " " Set Screw.....

NO.	PLATE	NAME
3072	5028	Thread Take-up Lever with 1819.....
56756	—	“ “ “ 3072 with 76c.....
76c	8584	“ “ “ Hinge Screw.....
1819	8584	“ “ “ Roller and Stud...
2124	3722	“ “ “ Spring.....
2127	3722	“ “ “ Regulator Plate
233j	3722	“ “ “ “ “
		Adjusting Screw.....
17865	3710	Thread Wiper Body.....
1207D	3710	“ “ “ Hinge Screw.....
17866	3710	“ “ “ Hook.....
17867	3710	“ “ “ Support.....
641c	5021	“ “ “ Set Screw...
17868	3710	“ “ “ Wire.....
337j	3718	“ “ “ Screw.....
17869	3710	“ “ “ Washer..
55402	8587	Throat Plate with 55399 and two 42639..
55403	—	“ “ 55402 with 55325 and two 1208D.....
55325	8586	Throat Plate Needle Hole Bushing (large needle hole).....
1208D	5020	Throat Plate Needle Hole Bushing Screw
55404	—	Throat Plate complete, Nos. 1698c, 17828, 50018F, 50117j, 55321, 55398 and 55403
691F	5015	Throat Plate Screw.....
17872	3721	Trip Lever.....
1196c	3721	“ “ Hinge Screw.....
17873	3721	“ “ Spring.....
1182E	3705	“ “ “ Screw.....
17874	5009	Tripping Point.....
190j	3710	“ “ “ Screw.....

Genuine Singer Needles and their Containers are marked with the Company's Trade Mark "SIMANCO." 1

Needles in Containers marked "For Singer Machines" are not Singer made needles. 2

LIST OF PARTS COMPLETE FOR

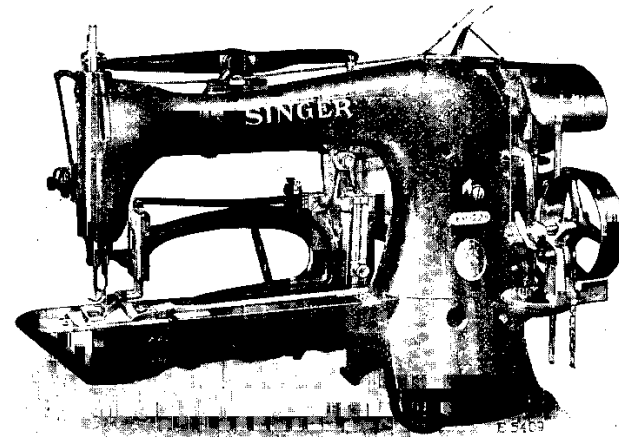

MACHINE No. 69-22

FOR STITCHING LAUNDRY TAGS ON SHIRTS, UNDERWEAR, ETC. ALSO FOR TACKING BLUCHER SHOES. THE MACHINE IS FITTED WITH A WORK HOLDING CLAMP AND FEED CAM FOR SEWING A RECTANGLE $3\frac{3}{64}$ INCH BY $1\frac{15}{64}$ INCH, CONSISTING OF TWENTY-ONE STITCHES, INCLUDING THE TYING STITCHES.

NO.	PLATE	NAME
55390	8582	Arch Clamp Foot (left) for 55391.....
55410	8588	“ “ “ “ 55411.....
55391	—	“ “ “ “ 55390 with 219K and 63731, for 55394.....
55411	—	Arch Clamp Foot (left) 55410 with 219K and 63731, for 55414.....
63731	—	Arch Clamp Foot Shank (left) with 63726
55392	8582	“ “ “ (right) for 55393.....
55412	8588	“ “ “ “ 55413.....
55393	—	“ “ “ “ 55392 with 219K and 63732, for 55394.....
55413	—	Arch Clamp Foot (right) 55412 with 219K and 63732, for 55414.....

NO.	PLATE	NAME
63732	---	Arch Clamp Foot Shank (right) with 63726
17958	3733	" " " Lifter with 17866.....
190j	3710	" " " Screw.....
63726	8582	" " " Lifting Stud.....
219k	5030	" " " Screw.....
18477	5030	" " " Plate.....
190j	3710	" " " Screw.....
63733	8585	" " " Spring.....
1229f	5021	" " " Adjusting Screw
1547j	5021	" " " " " " "
		Lock Nut.....
63734	8583	Arch Clamp Frame.....
14079	3731	" " " Dowel Pin.....
181d	3738	" " " Screw.....
55394	---	Arch Clamp complete, Nos. 1654c, 18367, 18477, 18486, 55391, 55393, 55396, 63734, two each 181d, 1229f, 1547j, 14079, 63733 and four 190j.....
55414	---	Arch Clamp complete, Nos. 1654c, 18367, 18477, 18486, 55411, 55413, 55417, 63734, two each 181d, 1229f, 1547j, 14079, 63733 and four 190j (For Singer Clydebank only).....
*55405	---	Arm with 4449, 17844 and two 164e.....
4389	5042	" Dowel Pin.....
4448	3722	" Oil Tube, for intermediate bearing....
880e	3724	" Screw.....
17702	5000	" Shaft.....
17703	5001	" Bushing (back).....
50333c	5042	" " " Adjusting Screw.....
1520e	3724	Arm Shaft Bushing (back) Adjusting Screw Nut.....
*4449	---	Arm Shaft Bushing (front).....
124674	8583	" Side Cover.....
190j	3710	" " " Screw.....
18498	5044	Belt Cover.....
39290	5001	" " Bracket with 184e and 17741.
184e	5021	" " " Screw Stud.....
17741	5008	" " " Stud.....
217j	3731	" " " Screw.....
39222	5001	" Shifter.....
63976	8582	" " Clamp.....
1255d	5021	" " " Screw.....
4292	5002	Crank Connecting Rod.....
375c	3724	" " " Hinge Screw.....
1518e	3718	" " " " " Nut.

NO.	PLATE	NAME
*55407	---	Cylinder.....
18388	5008	" Block.....
1300d	3748	" " Screw.....
18427	5001	" End Cover with 18428, 18444 and three 4604.....
18428	5008	Cylinder End Cover Bracket.....
18444	5008	" " " " Hinge Pin...
4604	5008	" " " " Rivet.....
18379	5008	" " " Spring.....
217e	3731	" " " " Screw.....
17724	5001	Face Plate.....
*63736	---	" " 17724 with 2105.....
17725	---	Face Plate complete, Nos. 448c, 600c, 1560c, 2103, 2107, 2124, 2127, 63736 and two each 233j and 2102.....
164d	3724	Face Plate Screw.....
2107	3722	" " Thread Guard.....
233j	3722	" " " " Screw.....
55376	8585	Feed Across Connection with 21358, 55377 and four 1057e.....
55378	---	Feed Across Connection 55376 with 50598c and 55381.....
*21358	---	Feed Across Connection Cap (lower)....
1057e	8584	" " " " " Screw
*55377	---	" " " " " (upper)....
1057e	8584	" " " " " Screw
18356	5006	" " Regulator with 1952.....
50598c	8584	" " " Ball Screw Stud...
1676c	5008	" " " " " " Nut
17738	5008	" " " " " " "
		Washer.....
18357	5008	Feed Across Regulator Hinge Stud.....
690d	3748	" " " " " Clamp- ing Screw.....
1952	5008	Feed Across Regulator Roller and Stud...
18358	5002	" " Shaft.....
18359	5008	" " " Collar with two 200f...
200f	5008	" " " " Set Screw.....
18360	5008	" " " Crank (back) with 160e and 200c.....
55381	8584	Feed Across Shaft Crank (back) Ball Stud
200c	5008	" " " " " " "
		Set Screw.....
160e	5008	Feed Across Shaft Crank (back) Clamp- ing Screw.....
18362	5007	Feed Across Shaft Crank (front) with 160e and 18363.....

NO.	PLATE	NAME
160E	5008	Feed Across Shaft Crank (front) Clamping Screw.....
18363	5007	Feed Across Shaft Crank (front) Stud
18364	5007	" " " " " "
		Slide Block.....
55395	8585	Feed Cam with two each 190J, 1192c and 17874.....
18415	5007	Feed Cam Driving Worm with 1441c and 1442c.....
1442c	5021	Feed Cam Driving Worm Position Screw.
1441c	5021	" " " " Set Screw.....
17797	5004	" " " " Wheel with 453c.....
3012	3722	Feed Cam Driving Worm Wheel Pin....
453c	5007	" " " " " Set Screw
18384	5007	" " Pin.....
1192c	3724	" " Set Screw.....
62155	8585	" " Shaft.....
1653c	3724	" " Nut.....
55396	8582	" Plate for 55394.....
55417	8588	" " 55414.....
*18485	5012	" " Carrier Bar.....
18486	—	" " " " 18485 with 810D, 934J, 1195E, 1221c, 18366, 18390, 18488, 18489, two 55300 and four 17806.....
18366	5007	Feed Plate Carrier Bar Block.....
18367	5007	" " " " " Cover.....
1221c	5007	" " " " " Screw.....
55300	5042	" " " " " Steady Pin.
17805	5007	" " " " " Pivot Block.....
1194D	5007	" " " " " Screw
18390	5007	" " " " " Plate.....
934J	5007	" " " " " Screw.....
1654c	5013	" " Nut.....
17806	5013	" " Position Stud.....
1195E	5013	" " Screw Stud.....
39361	8583	" Regulator with 1953.....
18469	5029	" " Bracket with 690D, 39310 and two 160D.....
*39310	—	Feed Regulator Bracket Cap.....
160D	5008	" " " " Screw.....
8589	3722	" " " Dowel Pin.....
1177E	3710	" " " Screw.....
17744	5009	" " Hinge Stud.....
18488	3759	" " Post.....
18489	3759	" " Guide.....

NO.	PLATE	NAME
810D	3759	Feed Regulator Post Guide Cap Screw...
1953	5021	" " Roller and Screw Stud with 1655c and 14017.....
1655c	5021	Feed Regulator Roller and Screw Stud Nut
14017	5015	" " " " " " " Washer.....
1190c	5009	Feed Regulator Stop Screw.....
39313	3759	" " Swivel.....
1191D	5009	" " Thumb Screw.....
55319	8582	Knife (needle thread) for 55323.....
55320	8582	" (shuttle thread) for 55323.....
55321	8582	" (stationary) for 55329.....
*55322	—	" " Bracket.....
42639	8584	" " " Pin.....
50117J	8584	" " Screw.....
18370	5000	" Bar with 18373 and two 17822.....
18371	5015	" " Cap.....
217J	3731	" " " Screw.....
18372	5016	" " Connection with 17917.....
190J	3710	" " " Screw.....
7071	5008	" " " " Washer.....
17915	5016	" " " Slide Block.....
17917	—	" " " " " 17915 with 17916.....
17916	5016	Knife Bar Connection Slide Block Stud...
39297	5016	" " Driving Lever with 190J, 1420E, 17919 and 39298.....
1382F	5016	Knife Bar Driving Lever Hinge Screw....
1681c	5016	" " " " " " Nut
39298	5016	" " " " Lock Stud.....
17919	5016	" " " " " " Spring
190J	3710	" " " " " " " Screw.....
1420E	5016	Knife Bar Driving Lever Lock Stud Stop Screw.....
18373	5015	Knife Bar Rack.....
17822	5015	" " " Rivet.....
39235	5006	" Cam Lever Body.....
39409	—	" " " " 39235 with 39460
39329	5029	Knife Cam Lever complete, Nos. 19793 and 39409.....
18470	5028	Knife Cam Lever Bracket with 1177D.....
8589	3722	" " " " Dowel Pin.....
670E	5021	" " " " Screw.....
50029c	3759	" " " Hinge Screw.....
18471	3759	" " " " " Bushing....
*18472	—	" " " " " " 18471 and 50029c.....

NO.	PLATE	NAME
1177D	3710	Knife Cam Lever Hinge Screw Bushing Clamping Screw.....
1980	3759	Knife Cam Lever Roller and Screw Stud with 1654c.....
1654c	5013	Knife Cam Lever Roller and Screw Stud Nut.....
39330	3759	Knife Cam Lever Slide with 1980.....
39460	—	“ “ “ “ 39330 with 1255D and 39331.....
1255D	5021	Knife Cam Lever Slide Screw.....
39331	3759	“ “ “ “ Washer....
19793	5015	“ “ “ Steady Pin.....
17825	5015	“ Holder with 17826, 17830 and two 7298.....
55323	—	Knife Holder 17825 with 1198c, 17829, 55319 and 55320.....
17826	5015	Knife Holder Pinion.....
7298	5015	“ “ “ Dowel Pin.....
17827	5015	“ “ “ Stud.....
17828	5015	“ “ “ Bracket with 17827.....
50018F	5021	Knife Holder Pinion Stud Bracket Screw
1698c	5021	“ “ “ “ “ “ Nut.....
1198c	5015	Knife Screw.....
17829	5015	“ Thread Holder.....
17830	5015	“ “ “ Position Pin.....
17831	5002	Needle Bar with 237F.....
*39203	3718	“ “ Connecting Link.....
377c	3718	“ “ “ “ Hinge Screw
1518E	3718	“ “ “ “ “ “ Nut.....
21629	3718	Needle Bar Connecting Stud with 155c...
155c	3718	“ “ “ “ Set Screw...
39350	5029	“ “ Thread Nipper Driving Lever (adjustable) with 39351 and two 335J..
39351	3759	Needle Bar Thread Nipper Driving Lever Extension.....
335J	3759	Needle Bar Thread Nipper Driving Lever Extension Screw.....
1196c	3721	Needle Bar Thread Nipper Driving Lever Hinge Screw.....
39352	5029	Needle Bar Thread Nipper Driving Lever Spring.....
17834	3718	Needle Bar Thread Nipper Lever with 17835.....

NO.	PLATE	NAME
17835	3718	Needle Bar Thread Nipper Lever Bushing
1200D	3718	“ “ “ “ “ Hinge Screw.....
39276	5009	Needle Bar Thread Nipper Lever Spring
1329D	5009	“ “ “ “ “ “ Screw.....
17837	5019	Needle Bar Thread Nipper Rod.....
17838	3718	“ “ “ “ “ Adjusting Stud.....
1651E	5021	Needle Bar Thread Nipper Rod Adjusting Stud Lock Nut.....
17839	3718	Needle Bar Thread Nipper Rod Arm with 196F.....
196F	3718	Needle Bar Thread Nipper Rod Arm Set Screw.....
17840	5001	Needle Bar Thread Nipper Rod Support
190J	3710	“ “ “ “ “ “ Screw.....
237F	3724	Needle Set Screw.....
*6022	5001	Oscillating Rock Shaft with 4784.....
55278	—	Oscillating Rock Shaft complete, Nos. 1513, 6022 and 6489.....
6489	5001	Oscillating Rock Shaft Hinge Pin.....
1513J	3724	“ “ “ “ “ Nut....
4784	5009	“ “ “ Oil Pad.....
18385	5002	“ Shaft.....
18386	—	“ “ Crank.....
18387	5017	Oscillating Shaft Crank complete, Nos. 237F, 1519E, 15171 and 18386.....
2049	5017	Oscillating Shaft Crank Pin.....
237F	5017	“ “ “ Set Screw.....
15170	5017	“ “ “ Slide Block.....
226E	8584	“ “ “ “ “ Cap Screw.....
12424	5017	Oscillating Shaft Crank Slide Block Cap Screw Washer.....
1035c	5017	Oscillating Shaft Crank Slide Block Screw Stud.....
1519E	5017	Oscillating Shaft Crank Slide Block Screw Stud Nut.....
15171	5017	Oscillating Shaft Crank Slide Block complete, Nos. 226E, 1035c, 12424 and 15170
2058	5002	Presser Bar.....
17841	3718	“ “ Collar with two 196F.....
196F	3718	“ “ “ Set Screw.....
17842	3718	“ “ Guide Bracket with 453c.....
453c	5007	“ “ “ “ Set Screw.....

NO.	PLATE	NAME
17843	5006	Presser Bar Lifting Lever.....
17844	5006	" " " " Bracket.....
164E	3724	" " " " " Screw..
1201c	5021	" " " " Hinge Screw...
17845	5019	" " " " Rod.....
17846	—	" " " " " Chain.....
32675	8582	" " " Spring.....
63975	8583	Pulley (loose) 2¼ in. diam.....
17848	5003	" " " Bushing.....
2269	3722	" " " Position Pin.....
1202R	3724	" " " Cap Screw.....
17942	5003	" (tight) 2½ in. diam., with 2269...
2022	3722	" " " Pin.....
17955	—	Pulleys complete, Nos. 1202R, 1206C, 17848, 17854, 17942 and 63975.....
2996	5017	Shuttle Bobbin.....
62739	8584	" " " Case.....
15140	5017	" " " Latch.....
2973	5017	" " " " Lever.....
2974	5017	" " " " " Fulcrum Pin.....
2975	5017	Shuttle Bobbin Case Latch Spring.....
592E	5017	" " " " Stop Screw...
15141	—	" " " Hinge, Nos. 2973, 2974 and 15140.....
15027	5017	Shuttle Bobbin Case Position Finger....
2523	5017	" " " " " Rivet
15277	5017	Shuttle Bobbin Case complete, Nos. 591F, 592E, 2523, 2975, 15027, 15141, 15278 and 62739.....
21562	5017	Shuttle Body.....
591F	5017	" Tension Regulating Screw.....
15278	5017	" " Spring.....
21561	5017	Shuttle, 1½ in. diam., Nos. 2996, 15277 and 21562.....
*2542	—	Shuttle Driver.....
2441	5017	" " 2542 with two 462c.....
2049	5017	" " Pin.....
462c	5017	" " Set Screw.....
18411	—	" Race Body.....
21623	5018	" " Cap.....
662D	5018	" " " Screw.....
2523	5018	" " " Steady Pin.....
18429	5018	" " Ring.....
18413	5018	" " " Spring.....
1289D	5018	" " " " Screw.....

NO.	PLATE	NAME
18430	5018	Shuttle Race (flexible) complete, Nos. 662D, 2523, 18411, 18429 21623 and two each 1289D and 18413.....
171D	5018	Shuttle Race Screw.....
17853	5003	Starting Lever.....
1262c	5021	" " Hinge Screw.....
1662c	5021	" " " " Nut.....
17886	5019	" " " Pitman.....
17854	3721	Stop Cam.....
17855	3721	" " Interlocking Rod.....
55388	8585	" " " " Case.....
55389	—	" " " " " 5 5 3 8 8 with 18443 and two 193J.....
55418	—	Stop Cam Interlocking Rod Case 55389 with 63976 and two 1255D.....
*55285	—	Stop Cam Interlocking Rod Case 55418 with 1318D, 17855, 17863, 17864 and 39222.....
39346	5028	Stop Cam Interlocking Rod Case Bracket
55304	—	Stop Cam Interlocking Rod Case Bracket complete, Nos. 1182E, 1196C, 1204E, 1254C, 1262C, 1508E, 1662C, 17853, 17859, 17861, 17862, 17872, 17873, 39346, 55285 and two 898D.....
18493	—	Stop Cam Interlocking Rod Case Bracket 55304 with 39343, 39344 and two 1186D
16532	3722	Stop Cam Interlocking Rod Case Bracket Dowel Pin.....
1343E	5021	Stop Cam Interlocking Rod Case Bracket Screw.....
1204E	3721	Stop Cam Interlocking Rod Case Hinge Screw.....
17859	5003	Stop Cam Interlocking Rod Case Socket Joint.....
898D	3721	Stop Cam Interlocking Rod Case Socket Joint Cap Screw.....
39343	5028	Stop Cam Interlocking Rod Case Spring (flat).....
50682c	8584	Stop Cam Interlocking Rod Case Spring Adjusting Screw.....
1520E	3759	Stop Cam Interlocking Rod Case Spring Adjusting Screw Nut.....
39344	3759	Stop Cam Interlocking Rod Case Spring Bracket with 1520E and 50682c.....
1186D	5021	Stop Cam Interlocking Rod Case Spring Bracket Screw.....

NO.	PLATE	NAME
17861	3721	Stop Cam Interlocking Rod Case Stop Stud.....
1254c	5021	Stop Cam Interlocking Rod Case Stop Stud Screw Bushing.....
1508E	5021	Stop Cam Interlocking Rod Case Stop Stud Screw Bushing Lock Nut.....
17862	3721	Stop Cam Interlocking Rod Case Stop Stud Spring.....
18443	5015	Stop Cam Interlocking Rod Case Wearing Block.....
193j	5015	Stop Cam Interlocking Rod Case Wearing Block Screw.....
17863	3721	Stop Cam Interlocking Rod Spring.....
17864	3721	" " " " Stop.....
1318D	3748	" " " " Screw.....
3012	3722	" " Pin.....
1206c	3721	" " Screw.....
2102	3722	Tension Disc.....
1560c	3722	" Regulating Thumb Nut.....
600c	3722	" Screw Stud.....
448c	3722	" " " Set Screw.....
2103	3722	" Spring.....
2105	3722	" Thread Guard.....
*55302	—	Thread Take-up Cam.....
18392	5003	" " " 55302 with 446c....
3012	3722	" " " Pin.....
446c	3724	" " " Set Screw.....
*18393	5002	" " Lever with 1822.....
55283	—	" " " 18393 with 79c....
79c	5021	" " " Hinge Screw.....
1822	5021	" " " Roller and Stud....
2124	3722	" " Spring.....
2127	3722	" " " Regulator Plate....
233j	3722	" " " " " Adjusting Screw.....
17865	3710	Thread Wiper Body.....
1207D	3710	" " " Hinge Screw.....
17866	3710	" " " Hook.....
17867	3710	" " " Support.....
641c	5021	" " " Set Screw....
17868	3710	" " " Wire.....
337D	3718	" " " " Screw.....
17869	3710	" " " " Washer..
55324	8586	Throat Plate with 55322 and two 42639..
55327	—	" " 55324 with 55325 and two 1208D.....

NO.	PLATE	NAME
55325	8586	Throat Plate Needle Hole Bushing (large needle hole).....
1208D	5020	Throat Plate Needle Hole Bushing Screw
55329	—	Throat Plate complete, Nos. 1698c, 17828, 50018F, 50117J, 55321, 55323 and 55327.....
691F	5015	Throat Plate Screw.....
17872	3721	Trip Lever.....
1196c	3721	" " Hinge Screw.....
17873	3721	" " Spring.....
1182E	3705	" " " Screw.....
17874	5009	Tripping Point.....
190j	3710	" " Screw.....

CLAMPS

BUTTON CLAMP (End Opening)

FOR 69-5 AND 69-6 MACHINES

NO.	PLATE	NAME
17926	3706	Button Clamp with 1220E and 17928....
17927	3706	" " Arm with 17714 and 63788
63788	7205	" " Hook.....
17928	3706	" " Position Stud.....
17712	3710	" " Pressure Spring.....
17714	3704	" " " Guide Block
1220E	3706	" " Screw Stud.....
17929	3706	" " Spring, for flat buttons....
17930	3706	" " " " stud back buttons.....
1208D	5020	Button Clamp Spring Screw.....
1656D	3706	" " Thumb Nut.....
17931	—	Button Clamp (end opening) complete, Nos. 17926, 17929 or 17930 and two 1208D.....
17932	—	Button Clamp (end opening) with Arm complete, Nos. 1656D, 17927 and 17931

BUTTON CLAMP (Side Opening)

FOR 69-5 AND 69-6 MACHINES

NO.	PLATE	NAME
17933	3707	Button Clamp with 1220E and 17928....
17927	3706	" " Arm with 17714 and 63788
63788	7205	" " " Hook.....

NO.	PLATE	NAME
17928	3706	Button Clamp Position Stud.....
17712	3710	" " Pressure Spring.....
17714	3704	" " " " Guide Block.....
1220E	3706	" " Screw Stud.....
17934	3707	" " Spring, for flat buttons....
17935	3707	" " " " stud back buttons.....
1208D	5020	Button Clamp Spring Screw.....
1656D	3706	" " Thumb Nut.....
17936	—	Button Clamp (side opening) complete, Nos. 17933, 17934 or 17935 and two 1208D.....
17937	—	Button Clamp (side opening) with Arm complete, Nos. 1656D, 17927 and 17936.....

CLAMP FOR HOOKS AND EYES

FOR 69-5 AND 69-6 MACHINES

NO.	PLATE	NAME
17906	3709	Clamp (left) with 23219.....
17907	3709	" (right).....
17908	3709	" Arm with 17714 and 63788.....
63788	7205	" " Hook.....
1175E	3704	" Hinge Screw.....
17911	3709	" Hook Stop.....
1208D	5020	" " Screw.....
17712	3710	" Pressure Spring.....
17714	3704	" " " " Guide Block.....
1219D	3709	" Spreader Stud.....
1657D	3709	" " " " Thumb Nut.....
17718	3705	" " " " " Washer.....
17909	3709	" " Spring.....
1182E	3705	" " Screw.....
17910	3709	" Spring.....
1208D	5020	" " Screw.....
23219	3709	" " Steady Pin.....
17912	—	Clamp complete, for hooks and eyes, Nos. 1182E, 1219D, 1657D, 17718, 17906 to 17911 and two each 1175E and 1208D..

CLAMP FOR TYING FRENCH KNOTS

FOR 69-5 MACHINE

NO.	PLATE	NAME
17946	3729	Clamp with 17948.....
17947	3729	" Arm with 17714 and 63788.....

NO.	PLATE	NAME
63788	7205	Clamp Arm Hook.....
17948	3729	" Hinge Stud.....
17949	3729	" " " Pin.....
1263D	3729	" Leveling Thumb Screw.....
17950	3729	" " " " Stop Bracket.....
220J	3729	" " " " " " " Screw.....
17712	3710	Clamp Pressure Spring.....
17714	3704	" " " " Guide Block.....
17951	3729	" Stretching Ring.....
1264D	3729	" " " Hinge Screw.....
17952	3729	" " " Spring.....
220J	3729	" " " " Adjusting Screw.....
578K	3729	Clamp Stretching Ring Spring Screw....
17953	—	Clamp complete, for tying French knots, Nos. 578K, 1263D, 17946, 17947, 17949 to 17952, two 1264D and three 220J....
17954	5014	Feed Plate.....
39205	5023	Guide with 460C.....
460C	5021	" Set Screw.....

ATTACHMENTS AND ACCESSORIES

NO.	PLATE	NAME
18419	—	Cylinder Base Plate with two 453C.....
18420	5005	" " " Hinge Connection...
18423	5005	" " " " " Hinge Pin.....
453C	5005	Cylinder Base Plate Hinge Connection Hinge Pin Set Screw.....
18424	5022	Cylinder Base Plate (hinged) complete, Nos. 18419, two each 18420, 18423, three wood screws 1¼ in. No. 12 and four 134D.....
134D	5005	Cylinder Base Plate Screw.....
41400	5023	Machine Rest Pin (wood).....
120346	4079	Oiler (copper plated) with 120347.....
120347	4079	" Spout, 9 in. long.....
11831	5023	Screw Driver (large).....
26026	5023	" " (machine).....
26485	5023	" " (shuttle tension).....
10875	5023	Wrench for 1518 and 1520.....
27662	5023	" " 1508.....
17905	5023	" " 1178, 1654 and 1676.....
22003	5023	" " 1651.....

BUTTON SPACING GAUGE

NO.	PLATE	NAME
124950	8588	Button Spacing Gauge.....
124706	8589	" " " Holder.....
124951	8589	" " " Plate.....
181J	3738	" " " " Screw.....
9525	8588	" " " " " Washer.....
217J	3731	" " " " " Screw.....
7071	5008	" " " " " Washer.....
124952	—	Button Spacing Gauge complete, Nos. 181J, 9525, 124706, 124950, 124951 and two each 217J, 7071 and wood screws 1 in. No. 10 R. H.....

BOBBIN WINDERS

BOBBIN WINDER

(SWINGING AUTOMATIC, LEFT HAND)

FOR 2996

FOR 69-5 TO 69-15, 69-17, 69-18 AND 69-22 MACHINES

NO.	PLATE	NAME
41598	5041	Base with 27916 and two 28084.....
1186c	3781	" Screw.....
15072	5009	Bobbin Position Pin.....
126391	8583	Bracket.....
129E	3761	" Screw.....
27916	3781	Brake (leather).....
28084	3781	" Rivet.....
27321	5041	Frame.....
50356D	5042	" Hinge Screw.....
1620J	5042	" " " Nut.....
41825	3781	" Spring.....
41600	5041	Pulley with 155c.....
155c	3718	" Set Screw.....
27849	8582	Spindle.....
27538	5041	" 27849 with 15072, 27850 and 41828
27850	8582	" Collar.....
41828	8582	" Pin.....
27328	5041	Stop Latch.....
35D	3724	" " Hinge Screw.....
60769	3780	Tension Bracket.....
60770	3780	Tension Bracket complete, Nos. 419E, 1562J, 8422, 9780, 43808, 60769 and two 2455.....

NO.	PLATE	NAME
9780	3781	Tension Bracket Position Stud.....
161D	3724	" " Screw.....
2455	3781	" Disc.....
1562J	3722	" Regulating Thumb Nut.....
419E	5042	" Screw Stud.....
43808	5042	" Spring.....
8422	3781	" Thread Guide.....
41604	5041	Bobbin Winder, Nos. 35D, 1620J, 27321, 27328, 27538, 41598, 41600, 41825 and 50356D.....
41716	—	Bobbin Winder (swinging automatic, left hand) complete, Nos. 161D, 41604, 60770 and two 1186c.....

BOBBIN WINDER

(SWINGING AUTOMATIC, LEFT HAND)

FOR 2073

FOR 69-16 AND 69-19 MACHINES

This Bobbin Winder is the same as No. 41716 with the following exceptions:

NO.	PLATE	NAME
27305	3781	Spindle, in place of 27849.....
27326	3781	Stop Latch, in place of 27328.....
41713	3780	Bobbin Winder, Nos. 35D, 1620J, 27305, 27321, 27326, 41598, 41600, 41825 and 50356D, in place of 41604.....
41714	—	Bobbin Winder (swinging automatic, left hand) complete, Nos. 161D, 41713, 60770 and two 1186c.....

PROTECTOR

NO.	PLATE	NAME
39489	7008	Arm with 39490.....
160c	7009	" Clamping Screw.....
39490	—	Blade.....
39491	7008	Bracket with two each 426c and 448c....
426c	7009	" Adjusting Screw.....
50351D	7009	" Screw.....
39492	7009	Crank with 160c.....
39493	7009	" Bracket with 1120c and two 454c..
454c	7009	" " Set Screw.....
52598	7009	" Hinge Stud.....
1120c	7009	" " Set Screw.....
39494	7008	Rod.....
15261	7009	" Collar with 237F.....
237F	7009	" " Set Screw.....

PROTECTOR

NO.	PLATE	NAME
39495	7009	Rod Connection.....
176D	7009	" " Screw.....
1099F	7009	" Screw Stud.....
39496	7008	" Sleeve.....
448c	7009	" " Set Screw.....
39497	7009	" Spring.....
15261	7009	" " Collar with 237F.....
237F	7009	" " " Set Screw.....
63753	—	Protector (front of needle) Nos. 1099F, 39489, 39491 to 39494, 39496, 39497, 52598 and two 15261.....
39498	—	Protector (front of needle) complete, Nos. 39495, 63753 and two each 176D and 50351D.....

STAND 25297

NO.	PLATE	NAME
126508	9090	Leg.....
51057R	20332	" Bolt with 1522E.....
1522E	20332	" " Nut.....
126509	20332	" " " Socket Washer.....
46707	9090	" Brace with wood screw 1 in. No. 16
126530	9090	" Cross Member, 15½ in. long.....
51057R	20332	" " " Bolt with 1522E.....
1522E	20332	" " " " Nut.....
126509	20332	" " " " " Socket Washer.....
12620	20332	Leg Cross Member Bolt Washer.....
126758	—	Leg with Rail complete, Nos. 126530, 126532, two 126508, three 12620 and four each 51057R and 126509.....
126532	9090	Rail, 16 in. long.....
51057R	20332	" Bolt with 1522E.....
1522E	20332	" " Nut.....
126509	20332	" " " Socket Washer.....
46711	9090	Treadle Support.....
50297R	20332	" " Bolt with 1522E.....
46712	—	" " " 50297R with 12620 and 46713.....
1522E	20332	Treadle Support Bolt Nut.....
46713	8589	" " " Packing.....
12620	20332	" " " Washer.....
25297	—	Stand (steel work) complete, Nos. 46711 and two each 46707, 46712 and 126758

STARTING LEVER AND FOOT
LIFTER PARTS

NO.	PLATE	NAME
17876	5022	Treadle with 443c.....
17877	5000	" Pitman Rod (lower).....
17878	5000	" " " (upper).....
17879	5000	" " " Clamp with two 161D
161D	3724	" " " " Screw.....
17880	5000	Treadle Pitman complete, Nos. 17877 to 17879.....
17881	5005	Treadle Shaft.....
443c	5042	" " Set Screw.....
17882	5005	" Spring.....
17883	5022	" Stand.....
17884	—	Treadle complete, Nos. 17876, 17881 to 17883 and two wood screws 1 in. No. 10
17885	—	Treadle and Pitman complete, Nos. 17880 and 17884.....

STARTING LEVER ROCK SHAFT

FOR 1600 SERIES MOTORS

NO.	PLATE	NAME
14224	—	Chain, length 10¼ in., with 56864.....
56864	5042	" Hook.....
7124	7242	Rock Shaft.....
27683	7242	" " Arm with two 356c.....
356c	8588	" " " Set Screw.....
16128	7242	" " Hanger with two wood screws 1 in. No. 10.....
2770	7242	Rock Shaft Stop Dog with 356c.....
356c	8588	" " " " Set Screw.....
63981	—	Starting Lever Rock Shaft complete, Nos. 2770, 7124, 14224 and two each 16128 and 27683.....

STARTING LEVER ROCK SHAFT

FOR 1800 SERIES MOTORS

NO.	PLATE	NAME
55433	—	Chain, length 10¼ in., with 56865.....
56865	8588	" Hook.....
55431	—	Rock Shaft.....
27683	7242	" " Arm with two 356c.....
356c	8588	" " " Set Screw.....
21327	8589	" " Hanger with two wood screws 1 in. No. 10.....

NO.	PLATE	NAME
32134	—	Rock Shaft Spring.....
2770	7242	" " Stop Dog with 356c.....
356c	8588	" " " " Set Screw.....
55432	—	Starting Lever Rock Shaft complete, Nos. 32134, 55431, 55433, wood screw 1 in. No. 12 F. H. and two each 2770, 21327 and 27683.....

TABLE BELT GUIDE

NO.	PLATE	NAME
39218	5022	Belt Guide with two 168E.....
168E	5021	" " Set Screw.....
17892	5022	Bracket with two 153E.....
17893	5022	Pulley.....
39219	5022	" Shaft (long) with 17896 and 63973
63973	—	" " " Wick (braided cotton)
39220	5022	" " (short) with 17896 and 63974
63974	—	" " " Wick (braided cotton)
17896	5005	" " Plug.....
153E	5021	" " Set Screw.....
39221	—	Table Belt Guide complete, Nos. 17892, 39219, 39220, two each 17893, 39218 and three wood screws 1¼ in. No. 12...

THREAD UNWINDER

FOR TWO SPOOLS

NO.	PLATE	NAME
225395	7233	Spool Rest with 201018c.....
225388	7233	" " Rod.....
200383c	8584	" " " Set Screw.....
201018c	8584	" " " Set Screw.....
202490	7233	" Stand with 200383c.....
225391	7233	Thread Guide.....
201696J	8584	" " Lock Nut.....
225326	20332	" " Position Cup.....
225324	7233	" " Rod with 208E and 225322
208E	8584	" " " Screw.....
225322	20332	" " " Washer.....
225396	7233	Thread Unwinder complete, Nos. 201696J, 202490, 225324, 225326, 225388, 225395, two 225391 and three wood screws ⅞ in. No. 12.....
27739	7234	Thread Cone (wood) for large cones.....
225390	7234	" " Holder, for inverted cones

NOTE: Nos. 27739 and 225390 are used with,
but not included in 225396

OBSOLETE PARTS

NO.	PLATE	NAME
18460	5027	Arch Clamp Foot (left) with 17959, for 18462.....
18461	5027	Arch Clamp Foot (right) with 17959, for 18462.....
18480	3739	Arch Clamp Foot Spring (heavy) for 69-14 and 69-16 Machines.....
18462	—	Arch Clamp complete for 69-14 Machine, Nos. 1654c, 18367, 18433 to 18435, 18438, 18460, 18461, 18463, 39302, two each 181D, 1175D, 14079 and five 217J
*18351	—	Arm with 4449, 17844 and two 164E, for 69-5 Machine.....
*18439	—	Arm with 4449, 17844 and two 164E, for all machines except 69-8.....
*18457	—	Arm with 4449, 17844 and two 164E, for 69-8 Machine.....
2002	3722	Arm Dowel Pin.....
435c	3724	" Shaft Bushing (back) Adjusting Screw
23373	3741	Belt Cover.....
17940	5019	" Shifter.....
17705	5019	" " for 17847 and 17849.....
39201	5019	" "
39223	5008	" " Clamp for 55284 and 55285...
1174D	3724	" " Screw for 17705 and 17940...
1255D	5021	" " " " 39201.....
41715	5023	Bobbin Winder Bracket for 18352 and 55269, for 41714 and 41716.....
17991	5019	Clamp Arm (lower) with two 17992, for 18490.....
17993	5019	Clamp Arm (upper) for 18490.....
158E	3724	Crank Connecting Rod Cap Screw for 4292
*18352	—	Cylinder for 69-5 to 69-15, 69-17, 69-18 and 69-22 Machines.....
*55269	—	Cylinder for 69-16 and 69-19 Machines...
18378	5024	" End Cover with 7569.....
7569	5005	" " " Hinge Pin for 18378.
18353	5006	Feed Across Connection with 18354 and two 175E.....
*18354	—	Feed Across Connection Cap for 18353...
175E	5021	" " " " Screw for 18353.....
18355	5008	Feed Across Knuckle Joint.....
17739	5008	" " Regulator Adjusting Stud Sleeve.....

NO.	PLATE	NAME
18361	5007	Feed Across Shaft Crank (back) Ball Stud for 69-5 to 69-7, 69-10 and 69-13 to 69-18 Machines.....
18422	5009	Feed Across Shaft Crank (back) Ball Stud for 69-8, 69-9 and 69-11 Machines.....
18456	5016	Feed Across Shaft Crank (back) Ball Stud for 69-12 Machine.....
1652D	5021	Feed Across Regulating Adjusting Stud Thumb Nut.....
17796	5005	Feed Cam Driving Worm with 453c, for 69-5, 69-6 and 69-8 to 69-11 Machines
2117	3722	Feed Cam Driving Worm Pin.....
1299c	5007	" " " " Position Screw.
453c	5007	" " " " Set Screw for 17796.....
17798	5024	Feed Cam Shaft.....
18416	5004	" " " ".....
18417	5004	" " " Bracket.....
17799	5024	" " " ".....
1177D	3710	" " " " Screw (back)...
1193D	3724	" " " " " (front)...
17975	5013	" Plate for 18436.....
18463	5025	" " " 18462.....
18389	5015	Knife (needle thread) for 55296.....
17808	5015	" (shuttle thread) for 55296.....
1201c	5021	" Bar Driving Lever Hinge Screw....
18375	5006	" Cam Lever Bracket for 1197.....
1197D	3724	" " " Hinge Screw.....
5944	5015	" " " Slide Steady Pin.....
*55296	—	" Holder 17825 with 1198c, 17808, 17829 and 18389, for 55306.....
17833	5001	Needle Bar Thread Nipper Driving Lever Spring.....
17836	3718	Needle Bar Thread Nipper Lever Spring for 337.....
337J	3718	Needle Bar Thread Nipper Lever Spring Screw.....
17847	5024	Pulley (loose) 2½ in. diam.....
17941	5003	" " 2⅞ in. diam., for 17955....
17849	5024	" (tight) 2½ in. diam., with 2269....
18377	5025	Shuttle Race Ring.....
18412	5026	" " " for 18414.....
18414	5026	Shuttle Race (flexible) complete for 18378, Nos. 662D, 2523, 18411, 18412, 21623 and two each 1289D and 18413.....

NO.	PLATE	NAME
1203c	3724	Starting Lever Hinge Screw.....
196F	3718	" " Treadle Extension Set Screw for 17943.....
17943	3741	Starting Lever Treadle with 196F and 443c, for 17945.....
17944	3741	Starting Lever Treadle Extension for 17945.....
17945	—	Starting Lever Treadle complete for 17891, Nos. 17881 to 17883, 17943, 17944 and two wood screws 1 in. No. 10
17891	—	Starting Lever Treadle and Pitman complete, Nos. 17880 and 17945.....
39202	8585	Stop Cam Interlocking Rod Case.....
55387	8583	" " " " " for 18492
*55284	—	" " " " " 1 8 4 4 0 with 1318D, 17855, 17863, 17864, 39222, 39223 and two 1255D, for 18442 and 18458.....
18492	5028	Stop Cam Interlocking Rod Case 55387 with 18443 and two 193J, for 55285....
18440	5003	Stop Cam Interlocking Rod Case with 18443 and two 193J, for 18442, 18458 and 55284.....
18441	5003	Stop Cam Interlocking Rod Case Bracket for 18442.....
39288	5003	Stop Cam Interlocking Rod Case Bracket for 18458.....
18442	—	Stop Cam Interlocking Rod Case Bracket complete for all machines except 69-8, Nos. 1182E, 1196c, 1204E, 1254c, 1262c, 1508E, 1662c, 17853, 17859 to 17862, 17872, 17873, 18441, 55284 and two 898D
18458	—	Stop Cam Interlocking Rod Case Bracket complete for 69-8 Machine, Nos. 1182E, 1196c, 1204E, 1254c, 1262c, 1508E, 1662c, 17853, 17859 to 17862, 17872, 17873, 39288, 55284 and two 898D.....
18380	5019	Stop Cam Interlocking Rod Case Extension for 1255.....
1255D	5021	Stop Cam Interlocking Rod Case Extension Screw for 18380.....
17860	3721	Stop Cam Interlocking Rod Case Spring for 18442 and 18458.....
430c	3759	Stop Cam Interlocking Rod Case Spring Adjusting Screw for 39344.....
17748	3722	Thread Eyelet (top of arm).....

OBSOLETE PARTS

NO.	PLATE	NAME
18382	—	Throat Plate with 17924 and two 1208d, for round bottom buttons, for 55306...
55306	—	Throat Plate 18382 with 1698c, 17828, 50018r and 55296, for all machines except 69-11.....
17924	5020	Throat Plate Needle Hole Bushing (small needle hole) for 18382.....

Genuine Singer Needles and their Containers are marked with the Company's Trade Mark "SIMANCO." 1

Needles in Containers marked "For Singer Machines" are not Singer made needles. 2

NUMERICAL LIST OF PARTS
FOR
MACHINES
Nos. 69-5 to 69-19
and 69-22

NUMERICAL LIST OF PARTS

NO.	PLATE	NAME
35D	3724	Bobbin Winder Stop Latch Hinge Screw for 41604 and 41713.....
76c	8584	Thread Take-up Lever Hinge Screw for 56756.....
79c	5021	Thread Take-up Lever Hinge Screw for 55283.....
90D	3738	Clamp Arm (lower) Hinge Screw for 18452.....
90D	3738	Clamp Arm (upper) Hinge Screw for 18452.....
93F	5009	Hand Stop Lever Connection Screw for 69-8 Machine.....
112D	3702	Shuttle Tension Spring Screw for 44001..
129E	3761	Bobbin Winder Bracket Screw for 41714 and 41716.....
129E	3761	Clamp Arm Bracket Adjusting Screw for 39336.....
134D	5005	Cylinder Base Plate Screw for 18424....
153E	5021	Table Belt Guide Pulley Shaft Set Screw for 17892.....
155c	3718	Bobbin Winder Pulley Set Screw for 41600.....
155c	3718	Needle Bar Connecting Stud Set Screw for 21629.....
158E	3724	Crank Connecting Rod Cap Screw for 4292, obsolete.....
160E	5008	Feed Across Shaft Crank (back) Clamp- ing Screw for 18360 and 18421.....
160E	5008	Feed Across Shaft Crank (front) Clamp- ing Screw for 18362.....
160D	5008	Feed Regulator Bracket Cap Screw for 18369 and 18469.....
160c	7009	Protector Arm Clamping Screw for 39492
161D	3724	Bobbin Winder Tension Bracket Screw for 41714 and 41716.....
161D	3724	Treadle Pitman Rod Clamp Screw for 17879.....
164J	3724	Face Plate Screw.....
164E	3724	Presser Bar Lifting Lever Bracket Screw for 18351, 18439, 18457, 55405 and 55406.....
168E	5021	Table Belt Guide Set Screw for 39218...
171D	5018	Shuttle Race Screw for all machines except 69-16 and 69-19.....

NUMERICAL LIST OF PARTS

NO.	PLATE	NAME
175E	5021	Feed Across Connection Cap Screw for 18353, obsolete.....
176D	7009	Protector Rod Connection Screw for 39498.....
181D	3738	Arch Clamp Frame Screw for 18436, 18453, 18462, 55386, 55394 and 55414.....
181J	3738	Button Spacing Gauge Plate Screw for 124952.....
181D	3738	Clamp Arm (lower) Bracket Screw for 18452.....
184E	5021	Belt Cover Bracket Screw Stud for 39290.....
190J	3710	Arch Clamp Foot Lifter Screw for 69-8, 69-9, 69-11, 69-14, 69-16 and 69-22 Machines.....
190J	3710	Arch Clamp Foot Plate Screw for 55386, 55394 and 55414.....
190J	3710	Arm Side Cover Screw.....
190J	3710	Button Clamp Lifter Screw for 69-5, 69-6, 69-15, 69-17 and 69-18 Machines.....
190J	3710	Clamp Arm Lifter Screw for 69-7, 69-12, 69-13 and 69-19 Machines.....
190J	3710	Clamp Arm (upper) Lifter Screw for 69-10 Machine.....
190J	3710	Knife Bar Connection Screw.....
190J	3710	" " Driving Lever Lock Stud Spring Screw for 39297.....
190J	3710	Needle Bar Thread Nipper Rod Support Screw.....
190J	3710	Tripping Point Screw for 17766, 18395 to 18399, 18401 to 18406, 55308, 55309 and 55395.....
193J	5015	Stop Cam Interlocking Rod Case Wearing Block Screw for 18440, 18492 and 55389.....
196F	3718	Needle Bar Thread Nipper Rod Arm Set Screw for 17839.....
196F	3718	Presser Bar Collar Set Screw for 17841.....
196F	3718	Starting Lever Treadle Extension Set Screw for 17943, obsolete.....
198D	5021	Shuttle Race Screw for 69-16 and 69-19 Machines.....
200F	5008	Feed Across Shaft Collar Set Screw for 18359.....
200C	5008	Feed Across Shaft Crank (back) Ball Stud Set Screw for 18360 and 18421.....
208E	8584	Thread Unwinder Thread Guide Rod Screw for 225324.....

NUMERICAL LIST OF PARTS

NO.	PLATE	NAME
217J	3731	Arch Clamp Foot Plate Screw for 18436, 18449, 18453 and 18462.....
217J	3731	Arch Clamp Foot Spring Screw for 18436, 18449 and 18462.....
217J	3731	Arch Clamp Foot Spring Screw (lower) for 18453.....
217J	3731	Belt Cover Screw.....
217J	3731	Button Spacing Gauge Screw for 124952.....
217E	3731	Cylinder End Cover Spring Screw.....
217J	3731	Knife Bar Cap Screw.....
219K	5030	Arch Clamp Foot Screw for 55384, 55385, 55391, 55393, 55411 and 55413.....
220J	3729	Clamp Leveling Thumb Screw Stop Bracket Screw for 17953.....
220J	3729	Clamp Stretching Ring Spring Adjusting Screw for 17953.....
226E	8584	Oscillating Shaft Crank Slide Block Cap Screw for 15171.....
229J	5017	Button Clamp Spring Screw for 63928 and 63929.....
233J	3722	Face Plate Thread Guard Screw for 17725.....
233J	3722	Thread Take-up Spring Regulator Plate Adjusting Screw for 17725.....
236J	3705	Button Clamp Spring Screw for 17898 and 17904.....
237F	3724	Needle Set Screw for 17831.....
237F	5017	Oscillating Shaft Crank Set Screw for 18387.....
237F	7009	Protector Rod Collar Set Screw for 15261.....
237F	7009	" " Spring Collar Set Screw for 15261.....
335J	3759	Needle Bar Thread Nipper Driving Lever Extension Screw for 39350.....
337J	3718	Needle Bar Thread Nipper Lever Spring Screw, obsolete.....
337J	3718	Thread Wiper Body Wire Screw.....
356C	8588	Starting Lever Rock Shaft Arm Set Screw for 27683.....
356C	8588	Starting Lever Rock Shaft Stop Dog Set Screw for 2770.....
375C	3724	Crank Connecting Rod Hinge Screw.....
377C	3718	Needle Bar Connecting Link Hinge Screw.....
398E	3702	Shuttle Main Spring Screw for 39295.....
419E	5042	Bobbin Winder Tension Screw Stud for 60770.....

NUMERICAL LIST OF PARTS

NO.	PLATE	NAME
426c	7009	Protector Bracket Adjusting Screw for 39491.....
430c	3759	Stop Cam Interlocking Rod Case Spring Adjusting Screw for 39344, obsolete....
435c	3724	Arm Shaft Bushing (back) Adjusting Screw, obsolete.....
443c	5042	Treadle Shaft Set Screw for 17876 and 17943.....
446c	3724	Thread Take-up Cam Set Screw for 18392 and 39204.....
448c	7009	Protector Rod Sleeve Set Screw for 39491
448c	3722	Tension Screw Stud Set Screw for 17725
453c	5005	Cylinder Base Plate Hinge Connection Hinge Pin Set Screw for 18419.....
453c	5007	Feed Cam Driving Worm Set Screw for 17796, obsolete.....
453c	5007	Feed Cam Driving Worm Wheel Set Screw for 17797, 17997 and 39212.....
453c	5007	Presser Bar Guide Bracket Set Screw for 17842.....
454c	7009	Protector Crank Bracket Set Screw for 39493.....
457c	3702	Shuttle Driver Set Screw for 39487.....
460c	5021	Guide Set Screw for 39205.....
462c	5017	Shuttle Driver Set Screw for 2441.....
466H	3702	" Tension Regulating Screw for 44001.....
578K	3729	Clamp Stretching Ring Spring Screw for 17953.....
591F	5017	Shuttle Tension Regulating Screw for 15277.....
592E	5017	Shuttle Bobbin Case Latch Stop Screw for 15277.....
600c	3722	Tension Screw Stud for 17725.....
641c	5021	Thread Wiper Body Support Set Screw
662D	5018	Shuttle Race Cap Screw for 18414 and 18430.....
670E	5021	Knife Cam Lever Bracket Screw.....
690D	3748	Feed Across Regulator Hinge Stud Clamping Screw for 18369 and 18469..
691F	5015	Throat Plate Screw.....
810D	3759	Feed Regulator Post Guide Cap Screw for 18486.....
880E	3724	Arm Screw.....
898D	3721	Stop Cam Interlocking Rod Case Socket Joint Cap Screw for 18442, 18458, 55304 and 55305.....

NUMERICAL LIST OF PARTS

NO.	PLATE	NAME
934J	5007	Feed Plate Carrier Bar Plate Screw for 18365, 18438, 18448, 18451 and 18486
957K	3738	Clamp Spreader Lever Cap Screw for 18452.....
1019c	5009	Hand Stop Lever Rod Collar Set Screw for 21678.....
1035c	5017	Oscillating Shaft Crank Slide Block Screw Stud for 15171.....
1057E	8584	Feed Across Connection Cap (lower) Screw for 55376.....
1057E	8584	Feed Across Connection Cap (upper) Screw for 55376.....
1099F	7009	Protector Rod Screw Stud for 63753.....
1120c	7009	" Crank Hinge Stud Set Screw for 39493.....
1174D	3724	Belt Shifter Screw for 17705 and 17940, obsolete.....
1175D	3704	Arch Clamp Foot Spring Connection Hinge Screw for 18436, 18449 and 18462.....
1175J	3704	Arch Clamp Foot Spring Screw (upper) for 18453.....
1175J	3704	Button Clamp Hinge Screw for 17898, 17904, 63928 and 63929.....
1175E	3704	Clamp Hinge Screw for 17912.....
1176J	3704	Button Clamp Arm Hinge Plate Screw for 69-5, 69-6, 69-15, 69-17 and 69-18 Machines.....
1177D	3710	Arch Clamp Frame Screw for 18449.....
1177D	3710	Button Clamp Pressure Spring Bracket Screw for 69-5, 69-6, 69-15, 69-17 and 69-18 Machines.....
1177D	3710	Clamp Pressure Spring Bracket Screw for 18452.....
1177D	3710	Feed Cam Shaft Bracket Screw (back) obsolete.....
1177E	3710	Feed Regulator Bracket Screw.....
1177D	3710	Knife Cam Lever Hinge Screw Bushing Clamping Screw for 18470.....
1178J	3710	Button Clamp Pressure Spring Screw for 69-5, 69-6, 69-15, 69-17 and 69-18 Machines.....
1178D	3761	Clamp Arm Screw for 39336.....
1178D	3710	" Pressure Spring Screw for 18452..
1180J	3705	Button Clamp Spreader Lever Locking Thumb Screw for 17898, 17904, 63928 and 63929.....

NO.	PLATE	NAME
1181J	3705	Button Clamp Spreader Spring Screw for 17898, 17904, 63928 and 63929....
1182J	3705	Button Clamp Spreader Screw for 17898, 17904, 63928 and 63929.....
1182E	3705	Clamp Spreader Spring Screw for 17912.
1182E	3705	Trip Lever Spring Screw for 18442, 18458, 55304 and 55305.....
1183J	3705	Button Clamp Stop Screw for 17898, 17904, 63928 and 63929.....
1186C	3781	Bobbin Winder Base Screw for 41714 and 41716.....
1186D	5021	Stop Cam Interlocking Rod Case Spring Bracket Screw for 18493 and 18494...
1190C	5009	Feed Regulator Stop Screw.....
1191D	5009	" " Thumb Screw.....
1192C	3724	" Cam Set Screw for 17766, 18395 to 18399, 18401 to 18406, 55308, 55309 and 55395.....
1193D	3724	Feed Cam Shaft Bracket Screw (front) obsolete.....
1194D	5007	Feed Plate Carrier Bar Pivot Block Screw.....
1195E	5013	Feed Plate Screw Stud for 18365, 18438, 18448 and 18486.....
1196C	3721	Needle Bar Thread Nipper Driving Lever Hinge Screw.....
1196C	3721	Trip Lever Hinge Screw for 18442, 18458, 55304 and 55305.....
1197D	3724	Knife Cam Lever Hinge Screw, obsolete.
1198C	5015	" Screw for 55296, 55323 and 55398
1200D	3718	Needle Bar Thread Nipper Lever Hinge Screw.....
1201C	5021	Knife Bar Driving Lever Hinge Screw, obsolete.....
1201C	5021	Presser Bar Lifting Lever Hinge Screw..
1202R	3724	Pulley (loose) Cap Screw for 17955.....
1203C	3724	Starting Lever Hinge Screw, obsolete....
1204E	3721	Stop Cam Interlocking Rod Case Hinge Screw for 18442, 18458, 55304 and 55305.....
1206C	3721	Stop Cam Screw for 17955.....
1207D	3710	Thread Wiper Body Hinge Screw.....
1208D	5020	Button Clamp Spring Screw for 17931 and 17936.....
1208D	5020	Clamp Hook Stop Screw for 17912.....
1208D	5020	" Spring Screw for 17912.....

NO.	PLATE	NAME
1208D	5020	Throat Plate Needle Hole Bushing Screw for 18382, 55327, 55328, 55332, 55335 and 55403.....
1219D	3709	Clamp Spreader Stud for 17912.....
1220E	3706	Button Clamp Screw Stud for 17926 and 17933.....
1221C	5007	Feed Plate Carrier Bar Block Screw for 18365, 18438, 18448, 18451 and 18486
1229F	5021	Arch Clamp Foot Spring Adjusting Screw for 55386, 55394 and 55414.....
1254C	5021	Stop Cam Interlocking Rod Case Stop Stud Screw Bushing for 18442, 18458, 55304 and 55305.....
1255D	5021	Belt Shifter Screw for 39201, obsolete...
1255D	5021	" " Clamp Screw for 55284 and 55418.....
1255D	5021	Knife Cam Lever Slide Screw for 39460..
1255D	5021	Stop Cam Interlocking Rod Case Extension Screw for 18380, obsolete....
1262C	5021	Starting Lever Hinge Screw for 18442, 18458, 55304 and 55305.....
1263D	3729	Clamp Leveling Thumb Screw for 17953
1264D	3729	" Stretching Ring Hinge Screw for 17953.....
1289D	5018	Shuttle Race Ring Spring Screw for 18414, 18430 and 55401.....
1299C	5007	Feed Cam Driving Worm Position Screw, obsolete.....
1300D	3761	Clamp Arm Bracket Hinge Block Screw for 39336.....
1300D	3748	Cylinder Block Screw.....
1318D	3748	Stop Cam Interlocking Rod Stop Screw for 55284 and 55285.....
1329J	5009	Needle Bar Thread Nipper Lever Spring Screw.....
1343E	5021	Stop Cam Interlocking Rod Case Bracket Screw.....
1382F	5016	Knife Bar Driving Lever Hinge Screw...
1420E	5016	" " " " Lock Stud Stop Screw for 39297.....
1441C	5021	Feed Cam Driving Worm Set Screw for 18415, 39211 and 39231.....
1442C	5021	Feed Cam Driving Worm Position Screw for 18415, 39211 and 39231.....
1508E	5021	Stop Cam Interlocking Rod Case Stop Stud Screw Bushing Lock Nut for 18442, 18458, 55304 and 55305.....

NUMERICAL LIST OF PARTS

NO.	PLATE	NAME
1513J	3724	Oscillating Rock Shaft Hinge Pin Nut for 55278 and 56812.....
1518E	3718	Crank Connecting Rod Hinge Screw Nut
1518E	3718	Needle Bar Connecting Link Hinge Screw Nut.....
1519E	5017	Oscillating Shaft Crank Slide Block Screw Stud Nut for 18387.....
1520E	3724	Arm Shaft Bushing (back) Adjusting Screw Nut.....
1520E	3759	Stop Cam Interlocking Rod Case Spring Adjusting Screw Nut for 39344.....
1522E	20332	Leg Bolt Nut for 51057.....
1522E	20332	" Cross Member Bolt Nut for 51057..
1522E	20332	Rail Bolt Nut for 51057.....
1522E	20332	Treadle Support Bolt Nut for 50297.....
1547J	5021	Arch Clamp Foot Spring Adjusting Screw Lock Nut for 55386, 55394 and 55414
1560c	3722	Tension Regulating Thumb Nut for 17725.....
1562J	3722	Bobbin Winder Tension Regulating Thumb Nut for 60770.....
1565D	5009	Hand Stop Lever Head for 69-8 Machine
1620J	5042	Bobbin Winder Frame Hinge Screw Nut for 41604 and 41713.....
1651E	5021	Needle Bar Thread Nipper Rod Adjusting Stud Lock Nut.....
1652D	5021	Feed Across Regulator Adjusting Stud Thumb Nut, obsolete.....
1653c	3724	Feed Cam Shaft Nut.....
1654c	3761	Clamp Arm Bracket Hinge Screw Nut for 39336.....
1654c	5013	Feed Plate Nut for 18436, 18449, 18453, 18462, 18490, 18491, 55386, 55394, 55414 and for 69-5, 69-6, 69-10, 69-12, 69-15 and 69-17 to 69-19 Machines....
1654c	5013	Knife Cam Lever Roller and Screw Stud Nut for 1980.....
1655c	5021	Feed Regulator Roller and Screw Stud Nut for 1953.....
1656D	3706	Button Clamp Thumb Nut for 17932 and 17937.....
1657D	3709	Clamp Spreader Stud Thumb Nut for 17912.....
1662c	5021	Starting Lever Hinge Screw Nut for 18442, 18458, 55304 and 55305.....
1676c	5008	Feed Across Regulator Ball Screw Stud Nut.....

NUMERICAL LIST OF PARTS

NO.	PLATE	NAME
1681c	5016	Knife Bar Driving Lever Hinge Screw Nut.....
1698c	5021	Knife Holder Pinion Stud Bracket Screw Nut for 55306, 55329, 55330, 55333, 55336 and 55404.....
1819	8584	Thread Take-up Lever Roller and Stud for 3072.....
1822	5021	Thread Take-up Lever Roller and Stud for 18393.....
1952	5008	Feed Across Regulator Roller and Stud for 18356.....
1953	5021	Feed Regulator Roller and Screw Stud with 1655c and 14017, for 17742, 18487, 39312 and 39361.....
1980	3759	Knife Cam Lever Roller and Screw Stud with 1654c, for 39330.....
2002	3722	Arm Dowel Pin, obsolete.....
2022	3722	Pulley (tight) Pin.....
2049	5017	Oscillating Shaft Crank Pin.....
2049	5017	Shuttle Driver Pin.....
2058	5002	Presser Bar.....
2073	3702	Shuttle Bobbin for 39296.....
*2075	—	" Cover for 44001.....
2076	3702	" " Hinge Pin for 39296.....
2078	3702	" Delivery Eye Thread Guard for 44001.....
2080	3702	Shuttle Delivery Eye Thread Guard Rivet for 44001.....
2082	3702	Shuttle Main Spring for 39295.....
2084	3702	" " " Steady Pin for 39295
2086	3702	" Tension Spring for 44001.....
2090	3702	" " " Plate for 44001..
2102	3722	Tension Disc for 17725.....
2103	3722	" Spring for 17725.....
2105	3722	" Thread Guard for 63736.....
2107	3722	Face Plate Thread Guard for 17725.....
2117	3722	Feed Cam Driving Worm Pin, obsolete..
2124	3722	Thread Take-up Spring for 17725.....
2127	3722	" " " Regulator Plate for 17725.....
2211	3702	Shuttle Bobbin Retaining Spring for 39295.....
2212	3702	Shuttle Bobbin Retaining Spring Rivet for 39295.....
2269	3722	Pulley (loose) Bushing Position Pin for 17849 and 17942.....

NO.	PLATE	NAME
2441	5017	Shuttle Driver 2542 with two 462c, for all Machines except 69-16 and 69-19..
2455	3781	Bobbin Winder Tension Disc for 60770
2523	5017	Shuttle Bobbin Case Position Finger Rivet for 15277.....
2523	5018	Shuttle Race Cap Steady Pin for 18414 and 18430.....
*2542	—	Shuttle Driver for 2441.....
2770	7242	Starting Lever Rock Shaft Stop Dog with 356c, for 55432 and 63981.....
2973	5017	Shuttle Bobbin Case Latch Lever for 15141.....
2974	5017	Shuttle Bobbin Case Latch Lever Fulcrum Pin for 15141.....
2975	5017	Shuttle Bobbin Case Latch Spring for 15277.....
2996	5017	Shuttle Bobbin for 21561.....
3012	3722	Feed Cam Driving Worm Wheel Pin....
3012	3722	Stop Cam Pin.....
3012	3722	Thread Take-up Cam Pin.....
3052	8585	Oscillating Rock Shaft Hinge Pin for 56812.....
3072	5028	Thread Take-up Lever with 1819, for 56756.....
4292	5002	Crank Connecting Rod.....
4389	5042	Arm Dowel Pin.....
4448	3722	" Oil Tube, for intermediate bearing.
*4449	—	" Shaft Bushing (front) for 18351, 18439, 18457, 55405 and 55406.....
4604	5008	Cylinder End Cover Bracket Rivet for 18427.....
4784	5009	Oscillating Rock Shaft Oil Pad for 6022..
5944	5015	Knife Cam Lever Slide Steady Pin, obsolete.....
*6022	5001	Oscillating Rock Shaft with 4784, for 16806 and 55278.....
6023	5028	Oscillating Shaft for 69-16 and 69-19 Machines.....
6489	5001	Oscillating Rock Shaft Hinge Pin for 55278.....
7071	5008	Button Spacing Gauge Screw Washer for 124952.....
7071	5008	Knife Bar Connection Screw Washer....
7124	7242	Starting Lever Rock Shaft for 63981....
7298	5015	Knife Holder Pinion Dowel Pin for 17825
7401	3738	Clamp Arm (lower) Bracket Steady Pin for 18452.....

NO.	PLATE	NAME
7569	5005	Cylinder End Cover Hinge Pin for 18378, obsolete.....
8422	3781	Bobbin Winder Tension Thread Guide for 60770.....
8589	3722	Feed Regulator Bracket Dowel Pin....
8589	3722	Knife Cam Lever Bracket Dowel Pin....
9311	3747	Button Clamp Spring Steady Pin for 18464, 18465, 39238 and 39239.....
9330	3740	Clamp Arm Pin for 18490.....
9525	8588	Button Spacing Gauge Plate Screw Washer for 124952.....
9780	3781	Bobbin Winder Tension Bracket Position Stud for 60770.....
10875	5023	Wrench for 1518 and 1520 (Attachments and Accessories).....
11831	5023	Screw Driver, large (Attachments and Accessories).....
12424	5017	Oscillating Shaft Crank Slide Block Cap Screw Washer for 15171.....
12620	20332	Leg Cross Member Bolt Washer for 126758.....
12620	20332	Rail Bolt Washer for 126758.....
12620	20332	Treadle Support Bolt Washer for 46712..
14008	3737	Clamp Arm (upper) Bracket Hinge Pin for 18452.....
14017	5015	Feed Regulator Roller and Screw Stud Nut Washer for 1953.....
14079	3731	Arch Clamp Frame Dowel Pin for 18436, 18449, 18453, 18462, 55386, 55394 and 55414.....
14224	—	Starting Lever Rock Shaft Chain, length 10¼ in., with 56864, for 63981.....
15027	5017	Shuttle Bobbin Case Position Finger for 15277.....
15072	5009	Bobbin Winder Bobbin Position Pin for 27538.....
15140	5017	Shuttle Bobbin Case Latch for 15141....
15141	—	" " " Hinge for 15277, Nos. 2973, 2974 and 15140.....
15170	5017	Oscillating Shaft Crank Slide Block for 15171.....
15171	5017	Oscillating Shaft Crank Slide Block complete for 18387, Nos. 226E, 1035c, 12424 and 15170.....
15261	7009	Protector Rod Collar with 237F, for 63753
15261	7009	" " Spring Collar with 237F, for 63753.....

NO.	PLATE	NAME
15277	5017	Shuttle Bobbin Case complete for 21561, Nos. 591f, 592E, 2523, 2975, 15027, 15141, 15278 and 62739.....
15278	5017	Shuttle Tension Spring for 15277.....
16128	7242	Starting Lever Rock Shaft Hanger with two wood screws 1 in. No. 10, for 63981
16532	3722	Stop Cam Interlocking Rod Case Bracket Dowel Pin.....
16806	—	Oscillating Rock Shaft 6022 with 56812, for 69-19 Machine.....
17702	5000	Arm Shaft.....
17703	5001	“ “ Bushing (back).....
17705	5019	Belt Shifter for 17847 and 17849, obsolete
17706	3704	Button Clamp (left) with 17723, for 17898.....
17707	3704	Button Clamp (right) with 17723, for 17898.....
17708	3710	Button Clamp Lifter with 17866, for 69-5, 69-6, 69-15, 69-17 and 69-18 Machines.....
17710	3704	Button Clamp Arm Hinge Plate for 69-5, 69-6, 69-15, 69-17 and 69-18 Machines
17711	3704	Button Clamp Arm Hook for 17901.....
17712	3710	“ “ Pressure Spring for 17898, 17904, 17932 and 17937.....
17712	3710	Clamp Pressure Spring for 17912 and 17953.....
17713	3710	Button Clamp Pressure Spring Bracket for 69-5, 69-6, 69-15, 69-17 and 69-18 Machines.....
17713	3710	Clamp Pressure Spring Bracket for 18452
17714	3704	Button Clamp Pressure Spring Guide Block for 17901, 17927 and 63927.....
17714	3704	Clamp Pressure Spring Guide Block for 17908 and 17947.....
17716	3705	Button Clamp Spreader for 17898 and 17904.....
17717	3705	Button Clamp Spreader Lever for 17898, 17904, 63928 and 63929.....
17718	3705	Button Clamp Spreader Lever Locking Thumb Screw Washer for 17898, 17904, 63928 and 63929.....
17718	3705	Clamp Spreader Stud Thumb Nut Washer for 17912.....
17719	3705	Button Clamp Spreader Spring for 17898, 17904, 63928 and 63929.....

NO.	PLATE	NAME
17720	3705	Button Clamp Spreader Steady Pin for 17722, 17903, 18466 and 39248.....
17721	3705	Button Clamp Spring, for flat buttons, for 17898.....
17722	3705	Button Clamp Stop with two 17720, for 17898.....
17723	3704	Button Clamp Stud for 17706, 17707, 17899, 17900, 18464, 18465, 39238 and 39239.....
17724	5001	Face Plate for 63736.....
17725	—	Face Plate complete, Nos. 448c, 600c, 1560c, 2103, 2107, 2124, 2127, 63736 and two each 233j and 2102.....
*17732	—	Feed Regulator Bracket Cap for 18369..
17738	5008	“ Across Regulator Ball Screw Stud Nut Washer.....
17739	5008	Feed Across Regulator Adjusting Stud Sleeve, obsolete.....
17741	5008	Belt Cover Bracket Stud for 39290.....
17742	5006	Feed Regulator with 1953, for 69-5 to 69-13 and 69-17 to 69-19 Machines....
17743	5009	Feed Regulator Post for 18365, 18438, 18448 and 18451.....
17744	5009	Feed Regulator Hinge Stud.....
17745	5009	“ “ Swivel for all machines except 69-15 and 69-22.....
17748	3722	Thread Eyelet (top of arm) obsolete....
17766	—	Feed Cam with two each 1192c, 17874 and four 190j, for 69-19 Machine.....
17796	5005	Feed Cam Driving Worm with 453c, for 69-5, 69-6 and 69-8 to 69-11 Machines, obsolete.....
17797	5004	Feed Cam Driving Worm Wheel with 453c, for 69-5, 69-6, 69-8 to 69-11, 69-13, 69-14, 69-16 and 69-22 Machines
17798	5024	Feed Cam Shaft, obsolete.....
17799	5024	“ “ “ Bracket, obsolete.....
17800	5013	“ Plate (thin) for flat buttons, for 69-5, 69-6, 69-17 and 69-18 Machines..
17805	5007	Feed Plate Carrier Bar Pivot Block....
17806	5013	“ “ Position Stud for 18365, 18438, 18448 and 18486.....
17806	5013	Face Plate Rivet for 18452.....
17808	5015	Knife (shuttle thread) for 55296, obsolete
17822	5015	“ Bar Rack Rivet for 18370 and 18426.....

NO.	PLATE	NAME
17825	5015	Holder with 17826, 17830 and two 7298, for 55296, 55323 and 55398.....
17826	5015	Knife Holder Pinion for 17825.....
17827	5015	" " " Stud for 17828.....
17828	5015	" " " " Bracket with 17827, for 55306, 55329, 55330, 55333, 55336 and 55404.....
17829	5015	Knife Thread Holder for 55296, 55323 and 55398.....
17830	5015	Knife Thread Holder Position Pin for 17825.....
17831	5002	Needle Bar with 237F.....
17833	5001	" " Thread Nipper Driving Lever Spring, obsolete.....
17834	3718	Needle Bar Thread Nipper Lever with 17835.....
17835	3718	Needle Bar Thread Nipper Lever Bushing for 17834.....
17836	3718	Needle Bar Thread Nipper Lever Spring for 337, obsolete.....
17837	5019	Needle Bar Thread Nipper Rod.....
17838	3718	" " " " " Adjusting Stud.....
17839	3718	Needle Bar Thread Nipper Rod Arm with 196F.....
17840	5001	Needle Bar Thread Nipper Rod Support.....
17841	3718	Presser Bar Collar with two 196F.....
17842	3718	" " Guide Bracket with 453c....
17843	5006	" " Lifting Lever.....
17844	5006	" " " " Bracket for 18351, 18439, 18457, 55405 and 55406.
17845	5019	Presser Bar Lifting Lever Rod.....
17846	—	" " " " Chain.....
17847	5024	Pulley (loose) 2½ in. diam., obsolete....
17848	5003	" " Bushing for 17955.....
17849	5024	" (tight) 2½ in. diam., with 2269, obsolete.....
17853	5003	Starting Lever for 18442, 18458, 55304 and 55305.....
17854	3721	Stop Cam for 17955.....
17855	3721	" " Interlocking Rod for 55284 and 55285.....
17859	5003	Stop Cam Interlocking Rod Case Socket Joint for 18442, 18458, 55304 and 55305
17860	3721	Stop Cam Interlocking Rod Case Spring for 18442 and 18458, obsolete.....

NO.	PLATE	NAME
17861	3721	Stop Cam Interlocking Rod Case Stop Stud for 18442, 18458, 55304 and 55305
17862	3721	Stop Cam Interlocking Rod Case Stop Stud Spring for 18442, 18458, 55304 and 55305.....
17863	3721	Stop Cam Interlocking Rod Spring for 55284 and 55285.....
17864	3721	Stop Cam Interlocking Rod Stop for 55284 and 55285.....
17865	3710	Thread Wiper Body.....
17866	3710	" " " Hook for 17708, 17958 and 39206.....
17867	3710	Thread Wiper Body Support.....
17868	3710	" " " Wire.....
17869	3710	" " " " Screw Washer.
17872	3721	Trip Lever for 18442, 18458, 55304 and 55305.....
17873	3721	Trip Lever Spring for 18442, 18458, 55304 and 55305.....
17874	5009	Tripping Point for 17766, 18395 to 18399, 18401 to 18406, 55308, 55309 and 55395
17876	5022	Treadle with 443c, for 17884.....
Nos. 17877 to 17879 for 17880		
17877	5000	Treadle Pitman Rod (lower).....
17878	5000	" " " (upper).....
17879	5000	" " " Clamp with two 161D.....
17880	5000	Treadle Pitman complete for 17885 and 17891, Nos. 17877 to 17879.....
Nos. 17881 to 17883 for 17884 and 17945		
17881	5005	Treadle Shaft.....
17882	5005	" Spring.....
17883	5022	" Stand.....
17884	—	Treadle complete for 17885, Nos. 17876, 17881 to 17883 and two wood screws 1 in. No. 10.....
17885	—	Treadle and Pitman complete, Nos. 17880 and 17884.....
17886	5019	Starting Lever Pitman.....
17891	—	Starting Lever Treadle and Pitman complete, Nos. 17880 and 17945, obsolete.
17892	5022	Table Belt Guide Bracket with two 153e, for 39221.....
17893	5022	Table Belt Guide Pulley for 39221.....
17896	5005	" " " " Shaft Plug for 39219 and 39220.....

NO.	PLATE	NAME
17898	3703	Button Clamp (universal) complete, for 14 to 36 line buttons, for 69-5, 69-6, 69-17 and 69-18 Machines, Nos. 236J, 1180J, 1181J, 1182J, 1183J, 17706, 17707, 17716 to 17719, 17721 or 17938, 17722, 17901, 50237K and two 1175J...
17899	3708	Button Clamp (left) with 17723, for 17904
17900	3708	" (right) with 17723, for 17904.....
17901	3704	Button Clamp Arm with 17711, 17714, and 23227, for 17898 and 17904.....
17902	3708	Button Clamp Spring, for flat buttons, for 17904.....
17903	3708	Button Clamp Stop with two 17720, for 17904.....
17904	---	Button Clamp (universal) complete, for 26 to 46 line buttons, for 69-5, 69-6, 69-17, 69-18 Machines, Nos. 236J, 1180J, 1181J, 1182J, 1183J, 17716 to 17719, 17899 to 17901, 17902 or 17939, 17903, 50237K and two 1175J.....
17905	5023	Wrench for 1178, 1654 and 1676 (Attachments and Accessories).....
Nos. 17906 TO 17911 FOR 17912		
17906	3709	Clamp (left) with 23219.....
17907	3709	" (right).....
17908	3709	" Arm with 17714 and 63788.....
17909	3709	" Spreader Spring.....
17910	3709	" Spring.....
17911	3709	" Hook Stop.....
17912	---	Clamp complete, for hooks and eyes, for 69-5 and 69-6 Machines, Nos. 1182E, 1219D, 1657D, 17718, 17906 to 17911 and two each 1175E and 1208D.....
17915	5016	Knife Bar Connection Slide Block for 17917.....
17916	5016	Knife Bar Connection Slide Block Stud for 17917.....
17917	---	Knife Bar Connection Slide Block 17915 with 17916, for 18372.....
17919	5016	Knife Bar Driving Lever Lock Stud Spring for 39297.....
17923	5013	Feed Plate (thick) for round bottom buttons, for 69-5, 69-6, 69-17 and 69-18 Machines.....

NO.	PLATE	NAME
17924	5020	Throat Plate Needle Hole Bushing (small needle hole) for 18382, obsolete..
17926	3706	Button Clamp with 1220E and 17928, for 17931.....
17927	3706	Button Clamp Arm with 17714 and 63788, for 17932 and 17937.....
17928	3706	Button Clamp Position Stud for 17926 and 17933.....
17929	3706	Button Clamp Spring, for flat buttons, for 17931.....
17930	3706	Button Clamp Spring, for stud back buttons, for 17931.....
17931	---	Button Clamp (end opening) complete for 17932, Nos. 17926, 17929 or 17930 and two 1208D.....
17932	---	Button Clamp (end opening) with arm complete for 69-5 and 69-6 Machines, Nos. 1656D, 17927 and 17931.....
Nos. 17933 TO 17935 FOR 17936		
17933	3707	Button Clamp with 1220E and 17928....
17934	3707	" " Spring, for flat buttons...
17935	3707	" " " " stud back buttons.....
17936	---	Button Clamp (side opening) complete for 17937, Nos. 17933, 17934 or 17935 and two 1208D.....
17937	---	Button Clamp (side opening) with Arm complete for 69-5 and 69-6 Machines, Nos. 1656D, 17927 and 17936.....
17938	3705	Button Clamp Spring, for stud back buttons, for 17898.....
17939	3708	Button Clamp Spring, for stud back buttons, for 17904.....
17940	5019	Belt Shifter, obsolete.....
17941	5003	Pulley (loose) 2 3/8 in. diam., for 17955, obsolete.....
17942	5003	Pulley (tight) 2 3/8 in. diam., with 2269, for 17955.....
17943	3741	Starting Lever Treadle with 196E and 443C, for 17945, obsolete.....
17944	3741	Starting Lever Treadle Extension for 17945, obsolete.....
17945	---	Starting Lever Treadle complete, for 17891, Nos. 17881 to 17883, 17943, 17944 and two wood screws 1 in. No. 10, obsolete.....

84 NUMERICAL LIST OF PARTS

NO.	PLATE	NAME
17946	3729	Clamp with 17948, for 17953.....
17947	3729	" Arm with 17714 and 63788, for 17953.....
17948	3729	Clamp Hinge Stud for 17946.....
Nos. 17949 to 17952 FOR 17953		
17949	3729	Clamp Hinge Stud Pin.....
17950	3729	Clamp Leveling Thumb Screw Stop Bracket.....
17951	3729	Clamp Stretching Ring.....
17952	3729	" " " Spring.....
17953	—	Clamp complete, for tying French knots for 69-5 Machine, Nos. 578K, 1263D, 17946, 17947, 17949 to 17952, two 1264D and three 220J.....
17954	5014	Feed Plate for 17953.....
17955	—	Pulleys complete, Nos. 1202R, 1206C, 17848, 17854, 17942 and 63975.....
17957	3731	Arch Clamp Foot with 17959, for 18453
17958	3733	" " " Lifter with 17866, for 69-8, 69-9, 69-14, 69-16 and 69-22 Machines.....
17958	3733	Clamp Arm Lifter with 17866, for 69-7, 69-12, 69-13 and 69-19 Machines.....
17958	3733	Clamp Arm (upper) Lifter with 17866, for 69-10 Machine.....
17959	3731	Arch Clamp Foot Lifting Stud for 17957, 17964, 17965, 18431, 18432, 18460 and 18461.....
17960	3731	Arch Clamp Foot Plate for 18453.....
17963	3731	Feed Plate for 18453.....
Nos. 17964 to 17968 FOR 18449		
17964	3733	Arch Clamp Foot (left) with 17959.....
17965	3733	" " " (right) with 17959.....
17966	3733	" " " Plate.....
17967	3733	" " " Spring Connection.....
17968	3732	" " " Frame.....
17970	3740	Feed Plate for 18449.....
17975	5013	" " " 18436, obsolete.....
Nos. 17976 to 17984 FOR 18452		
17976	3737	Clamp Arm (lower) left.....
17977	3737	" " " right.....

NUMERICAL LIST OF PARTS 85

NO.	PLATE	NAME
17978	3737	Clamp Arm (lower) Bracket.....
17979	3738	" " (upper) left, with 17986 and 39257.....
17980	3738	Clamp Arm (upper) right, with 17986 and 39257.....
17981	3737	Clamp Arm (upper) Bracket.....
17982	3738	" Pressure Spring.....
17983	3737	" Spreader Lever.....
17984	3738	" " " Friction Washer.
17985	3738	" " " Hinge Stud for 18451.....
17986	3738	Clamp Spreader Stud for 17979 and 17980.....
17988	3737	Feed Plate (left) for 18452.....
17989	3737	" " (right) for 18452.....
17991	5019	Clamp Arm (lower) with two 17992, for 18490, obsolete.....
17992	3740	Clamp Arm (lower) Hook for 17991 and 63811.....
17993	5019	Clamp Arm (upper) for 18490, obsolete..
17997	5004	Feed Cam Driving Worm Wheel with 453c, for 69-7 and 69-15 Machines....
17999	3739	Clamp Arm with two 39257, for 18491
*18351	—	Arm with 4449, 17844 and two 164E, for 69-5 Machine, obsolete.....
*18352	—	Cylinder for 69-5 to 69-15, 69-17, 69-18 and 69-22 Machines, obsolete.....
18353	5006	Feed Across Connection with 18354 and two 175E, obsolete.....
*18354	—	Feed Across Connection Cap for 18353, obsolete.....
18355	5008	Feed Across Knuckle Joint, obsolete....
18356	5006	" " Regulator with 1952.....
18357	5008	" " " Hinge Stud.....
18358	5002	" " " Shaft.....
18359	5008	" " " Collar with two 200F
18360	5008	" " " Crank (back) with 160E and 200c, for 69-5 to 69-7, 69-10, 69-13 to 69-18 and 69-22 Machines..
18361	5007	Feed Across Shaft Crank (back) Ball Stud for 69-5 to 69-7, 69-10 and 69-13 to 69-18 Machines, obsolete.....
18362	5007	Feed Across Shaft Crank (front) with 160E and 18363.....

NO.	PLATE	NAME
18363	5007	Feed Across Shaft Crank (front) Stud for 18362.....
18364	5007	Feed Across Shaft Crank (front) Stud Slide Block.....
18365	—	Feed Plate Carrier Bar 18445 with 934j, 1195e, 1221c, 17743, 18366, 18390, two 55300 and four 17806, for 18490, 18491 and 69-5, 69-6, 69-15, 69-17 and 69-18 Machines.....
18366	5007	Feed Plate Carrier Bar Block for 18365, 18438, 18448, 18451 and 18486.....
18367	5007	Feed Plate Carrier Bar Block Cover for 18436, 18449, 18452, 18453, 18462, 18490, 18491, 55386, 55394, 55414 and 69-5, 69-6, 69-15, 69-17 and 69-18 Machines.....
18369	5006	Feed Regulator Bracket with 690d, 17732 and two 160d, for all machines except 69-15 and 69-22.....
18370	5000	Knife Bar with 18373 and two 17822, for all machines except 69-11.....
18371	5015	Knife Bar Cap.....
18372	5016	“ “ Connection with 17917.....
18373	5015	“ “ Rack for 18370 and 18426....
18375	5006	“ Cam Lever Bracket for 1197, obsolete.....
18377	5025	Shuttle Race Ring, obsolete.....
18378	5024	Cylinder End Cover with 7569, obsolete
18379	5008	“ “ “ Spring.....
18380	5019	Stop Cam Interlocking Rod Case Extension for 1255, obsolete.....
18382	—	Throat Plate with 17924 and two 1208d, for round bottom buttons, for 55306, obsolete.....
18384	5007	Feed Cam Pin.....
18385	5002	Oscillating Shaft for all machines except 69-16 and 69-19.....
18386	—	Oscillating Shaft Crank for 18387.....
18387	5017	Oscillating Shaft Crank complete, Nos. 237f, 1519e, 15171 and 18386.....
18388	5008	Cylinder Block.....
18389	5015	Knife (needle thread) for 55296, obsolete
18390	5007	Feed Plate Carrier Bar Plate for 18365, 18438, 18448, 18451 and 18486.....
18392	5003	Thread Take-up Cam 55302 with 446c, for all machines except 69-16 and 69-19

NO.	PLATE	NAME
*18393	5002	Thread Take-up Lever with 1822, for 55283.....
18395	5004	Feed Cam with two each 1192c, 17874 and four 190j, for 69-5 Machine.....
18396	—	Feed Cam with two 1192c, three 17874 and six 190j, for 69-6 Machine.....
18397	—	Feed Cam with 17874 and two each 190j and 1192c, for 69-7 Machine.....
18398	—	Feed Cam with 17874 and two each 190j and 1192c, for 69-8 Machine.....
18399	—	Feed Cam with two each 1192c, 17874 and four 190j, for 69-9 and 69-10 Machines.....
18401	—	Feed Cam with 17874 and two each 190j and 1192c, for 69-11 Machine.....
18402	—	Feed Cam with two each 1192c, 17874 and four 190j, for 69-12 Machine.....
18403	—	Feed Cam with two 1192c, three 17874 and six 190j, for 69-13 Machine.....
18404	—	Feed Cam with two each 190j, 1192c and 17874, for 69-14 Machine.....
18405	—	Feed Cam with 17874 and two each 190j and 1192c, for 69-15 Machine.....
18406	—	Feed Cam with two each 190j, 1192c, and 17874, for 69-16 Machine.....
18411	—	Shuttle Race Body for 18414 and 18430.
18412	5026	“ “ Ring for 18414, obsolete....
18413	5018	“ “ “ Spring for 18414, 18430 and 55401.....
18414	5026	Shuttle Race (flexible) complete for 18378, Nos. 662d, 2523, 18411, 18412, 21623 and two each 1289d and 18413, obsolete.....
18415	5007	Feed Cam Driving Worm with 1441c and 1442c, for 69-5, 69-6, 69-8 to 69-11, 69-13, 69-14, 69-16 and 69-22 Machines
18416	5004	Feed Cam Shaft, obsolete.....
18417	5004	“ “ “ Bracket, obsolete.....
18419	—	Cylinder Base Plate with two 453c, for 18424.....
18420	5005	Cylinder Base Plate Hinge Connection for 18424.....
18421	5009	Feed Across Shaft Crank (back) with 160e and 200c, for 69-8, 69-9, 69-11, 69-12 and 69-19 Machines.....

88 NUMERICAL LIST OF PARTS

NO.	PLATE	NAME
18422	5009	Feed Across Shaft Crank (back) Ball Stud for 69-8, 69-9 and 69-11 Machines, obsolete.
18423	5005	Cylinder Base Plate Hinge Connection Hinge Pin for 18424.
18424	5022	Cylinder Base Plate (hinged) complete, Nos. 18419, two each 18420, 18423, three wood screws 1¼ in. No. 12 and four 134d (Attachments and Accessories).
18426	5000	Knife Bar with 18373 and two 17822, for 69-11 Machine.
18427	5001	Cylinder End Cover with 18428, 18444 and three 4604.
18428	5008	Cylinder End Cover Bracket for 18427.
18429	5018	Shuttle Race Ring for 18430.
18430	5018	Shuttle Race (flexible) complete for all machines except 69-16 and 69-19, Nos. 662d, 2523, 18411, 18429, 21623 and two each 1289d and 18413.
18431	5011	Arch Clamp Foot (left) with 17959, for 18436.
18432	5011	Arch Clamp Foot (right) with 17959 for 18436.
Nos. 18433 to 18435 FOR 18436 and 18462		
18433	5011	Arch Clamp Foot Plate.
18434	5011	" " " Spring Connection.
18435	5010	" " Frame.
18436	—	Arch Clamp complete for 69-9 Machine, Nos. 1654c, 18367, 18431 to 18435, 18438, 18459, 39302, two each 181d, 1175j, 14079 and five 217j.
*18437	5012	Feed Plate Carrier Bar for 18438.
18438	—	" " " " 18437 with 934j, 1195e, 1221c, 17743, 18366, 18390, two 55300 and four 17806, for 18436, 18453 and 18462.
*18439	—	Arm with 4449, 17844 and two 164e, for all machines except 69-8, obsolete.
18440	5003	Stop Cam Interlocking Rod Case with 18443 and two 193j, for 18442, 18458 and 55284, obsolete.
18441	5003	Stop Cam Interlocking Rod Case Bracket for 18442, obsolete.

NUMERICAL LIST OF PARTS 89

NO.	PLATE	NAME
18442	—	Stop Cam Interlocking Rod Case Bracket complete for all machines except 69-8, Nos. 1182e, 1196c, 1204e, 1254c, 1262c, 1508e, 1662c, 17853, 17859 to 17862, 17872, 17873, 18441, 55284 and two 898d, obsolete.
18443	5015	Stop Cam Interlocking Rod Case Wearing Block for 18440, 18492 and 55389.
18444	5008	Cylinder End Cover Bracket Hinge Pin for 18427.
*18445	5002	Feed Plate Carrier Bar for 18365.
*18447	5012	" " " " " 18448.
18448	—	" " " " 18447 with 934j, 1195e, 1221c, 17743, 18366, 18390, two 55300 and four 17806, for 18449.
18449	—	Arch Clamp complete for 69-8 Machine, Nos. 1654c, 17964 to 17968, 17970, 18367, 18448, 39302, two each 1175d, 1177d, 14079 and five 217j.
*18450	5012	Feed Plate Carrier Bar for 18451.
18451	—	" " " " 18450 with 934j, 1221c, 17743, 17985, 18366, 18390 and two 55300, for 18452.
18452	—	Clamp complete for 69-10 Machine, Nos. 181d, 957k, 1177d, 1178d, 14008, 17713, 17976 to 17984, 17988, 17989, 18367, 18451, two 7401 and four each 90d and 17806.
18453	—	Arch Clamp complete for 69-11 Machine, Nos. 1175d, 1654c, 17957, 17960, 17963, 18367, 18438, 39250, 39303, two each 181d, 14079 and five 217j.
18456	5016	Feed Across Shaft Crank (back) Ball Stud for 69-12 Machine, obsolete.
*18457	—	Arm with 4449, 17844 and two 164e, for 69-8 Machine, obsolete.
18458	—	Stop Cam Interlocking Rod Case Bracket complete for 69-8 Machine, Nos. 1182e, 1196c, 1204e, 1254c, 1262c, 1508e, 1662c, 17853, 17859 to 17862, 17872, 17873, 39288, 55284 and two 898d, obsolete.
18459	5011	Feed Plate for 18436.
18460	5027	Arch Clamp Foot (left) with 17959, for 18462, obsolete.

NO.	PLATE	NAME
18461	5027	Arch Clamp Foot (right) with 17959, for 18462, obsolete.....
18462	---	Arch Clamp complete for 69-14 Machine, Nos. 1654c, 18367, 18433 to 18435, 18438, 18460, 18461, 18463, 39302, two each 181D, 1175D, 14079 and five 217J, obsolete.....
18463	5025	Feed Plate for 18462, obsolete.....
Nos. 18464 to 18466 for 63929		
18464	3764	Button Clamp (left) with 9311 and 17723
18465	3764	" " (right) with 9311 and 17723.....
18466	3764	Button Clamp Stop with two 17720.....
18468	3764	Feed Plate for 69-15 Machine.....
18469	5029	" Regulator Bracket with 690D, 39310 and two 160D, for 69-15 and 69-22 Machines.....
18470	5028	Knife Cam Lever Bracket with 1177D...
18471	3759	" " Hinge Screw Bushing for 18472.....
*18472	---	Knife Cam Lever Hinge Screw Bushing 18471 with 50029c.....
18473	5030	Arch Clamp Foot (left) for 55384.....
18475	5030	" " (right) for 55385.....
18477	5030	" " " Plate for 55386, 55394 and 55414.....
18480	3739	Arch Clamp Foot Spring (heavy) for 69-14 and 69-16 Machines, obsolete...
18484	5030	Feed Plate for 55386.....
*18485	5012	" " Carrier Bar for 18486.....
18486	---	" " " " 18485 with 810D, 934J, 1195E, 1221C, 18366, 18390, 18488, 18489, two 55300 and four 17806, for 55386, 55394 and 55414.....
18487	5029	Feed Regulator with 1953, for 69-14 and 69-16 Machines.....
18488	3759	Feed Regulator Post for 18486.....
18489	3759	" " " Guide for 18486....
18490	---	Clamp complete, for 69-7, 69-12 and 69-19 Machines, Nos. 1654c, 9330, 18365, 18367, 39304, 39336, 63811 and 63812.....

NO.	PLATE	NAME
18491	---	Clamp complete for 69-13 Machine, Nos. 1654c, 17999, 18365, 18367, 39258 and 39336.....
18492	5028	Stop Cam Interlocking Rod Case 55387 with 18443 and two 193J, for 55285, obsolete.....
18493	---	Stop Cam Interlocking Rod Case Bracket 55304 with 39343, 39344 and two 1186D, for all machines except 69-8....
18494	---	Stop Cam Interlocking Rod Case Bracket 55305 with 39343, 39344 and two 1186D, for 69-8 Machine.....
18498	5044	Belt Cover.....
19793	5015	Knife Cam Lever Slide Steady Pin for 39329.....
21327	8589	Starting Lever Rock Shaft Hanger with two wood screws 1 in. No. 10, for 55432
*21358	---	Feed Across Connection Cap (lower) for 55376.....
21561	5017	Shuttle, 1 $\frac{1}{8}$ in. diam., for all machines except 69-16 and 69-19, Nos. 2996, 15277 and 21562.....
21562	5017	Shuttle Body for 21561.....
21623	5018	" Race Cap for 18414 and 18430..
21629	3718	Needle Bar Connecting Stud with 155c..
21678	5009	Hand Stop Lever Rod Collar with 1019c, for 69-8 Machine.....
22003	5023	Wrench for 1651 (Attachments and Accessories).....
23219	3709	Clamp Spring Steady Pin for 17906.....
23227	3705	Button Clamp Spring Steady Pin for 17901.....
23373	3741	Belt Cover, obsolete.....
24122	5009	Hand Stop Lever Spring for 69-8 Machine
25297	---	Stand (steel work) complete, Nos. 46711 and two each 46707, 46712 and 126758
26026	5023	Screw Driver, machine (Attachments and Accessories).....
26485	5023	Screw Driver, shuttle tension (Attachments and Accessories).....
27305	3781	Bobbin Winder Spindle for 41713.....
27321	5041	" " Frame for 41604 and 41713.....

NO.	PLATE	NAME
27326	3781	Bobbin Winder Stop Latch for 41713....
27328	5041	" " " " " 41604....
27538	5041	" " Spindle 27849 with 15072, 27850 and 41828, for 41604.....
27662	5023	Wrench for 1508 (Attachments and Accessories).....
27683	7242	Starting Lever Rock Shaft Arm with two 356c, for 55432 and 63981.....
27739	7234	Thread Unwinder Thread Cone (wood) for large cones, for 225396.....
27849	8582	Bobbin Winder Spindle for 27538.....
27850	8582	" " " Collar for 27538..
27916	3781	" " Brake (leather) for 41598
28084	3781	" " " Rivet for 41598..
32134	—	Starting Lever Rock Shaft Spring for 55432.....
32675	8582	Presser Bar Spring.....
39201	5019	Belt Shifter, obsolete.....
39202	8585	Stop Cam Interlocking Rod Case, ob- solete.....
*39203	3718	Needle Bar Connecting Link.....
39204	5028	Thread Take-up Cam 63749 with 446c, for 69-16 and 69-19 Machines.....
39205	5023	Guide with 460c, for 17953.....
39206	3731	Arch Clamp Foot Lifter with 17866, for 69-11 Machine.....
39211	5005	Feed Cam Driving Worm with 1441c and 1442c, for 69-12 and 69-17 to 69-19 Machines.....
39212	5002	Feed Cam Driving Worm Wheel with 453c for 69-12 and 69-17 to 69-19 Machines.....
Nos. 39218 to 39220 FOR 39221		
39218	5022	Table Belt Guide with two 168E.....
39219	5022	" " " Pulley Shaft (long) with 17896 and 63973.....
39220	5022	Table Belt Guide Pulley Shaft (short) with 17896 and 63974.....
39221	—	Table Belt Guide complete, Nos. 17892, 39219, 39220, two each 17893, 39218 and three wood screws 1¼ in. No. 12..
39222	5001	Belt Shifter for 55284 and 55285.....
39223	5008	" " Clamp for 55284 and 55285, obsolete.....
39231	5005	Feed Cam Driving Worm with 1441c and 1442c, for 69-7 and 69-15 Machines...

NO.	PLATE	NAME
39235	5006	Knife Cam Lever Body for 39409.....
39238	3747	Button Clamp (left) with 9311 and 17723, for 63928.....
39239	3747	Button Clamp (right) with 9311 and 17723, for 63928.....
39241	3748	Button Clamp Pressure Spring for 63928
39242	3748	" " Spreader for 63928 and 63929.....
Nos. 39244 to 39247 FOR 63928 AND 63929		
39244	3747	Button Clamp Spring (left) for flat buttons.....
39245	3747	Button Clamp Spring (right) for flat buttons.....
39246	3748	Button Clamp Spring (left) for stud back buttons.....
39247	3748	Button Clamp Spring (right) for stud back buttons.....
39248	3748	Button Clamp Stop with two 17720, for 63928.....
39250	5010	Arch Clamp Frame for 18453.....
39257	5009	Clamp Arm Hook for 17999.....
39257	5009	" " (upper) Hook for 17979 and 17980.....
39258	5014	Feed Plate (thin) for 18491.....
39276	5009	Needle Bar Thread Nipper Lever Spring
Nos. 39283 to 39287 FOR 69-8 MACHINE		
39283	5009	Hand Stop Lever.....
39284	5000	" " " Rod.....
39285	5009	" " " " Connection.....
39286	5009	" " " Guide Stud (back)....
39287	5009	" " " " " (front)....
39288	5003	Stop Cam Interlocking Rod Case Bracket for 18458, obsolete.....
39290	5001	Belt Cover Bracket with 184E and 17741
*39295	—	Shuttle Body with 398E, 2082, 2084, 2211 and two 2212, for 39296.....
39296	3702	Shuttle complete for 69-16 and 69-19 Machines, Nos. 2073, 2076, 39295 and 44001.....
39297	5016	Knife Bar Driving Lever with 190J, 1420E, 17919 and 39298.....
39298	5016	Knife Bar Driving Lever Lock Stud for 39297.....
39302	3731	Arch Clamp Foot Spring for 18436, 18449 and 18462.....

NO.	PLATE	NAME
39303	3731	Arch Clamp Foot Spring for 18453.....
39304	5014	Feed Plate for 18490.....
*39310	—	Regulator Bracket Cap for 18469..
39312	5029	“ “ with 1953, for 69-15 Machine.....
39313	3759	Feed Regulator Swivel for 69-15 and 69-22 Machines.....
39329	5029	Knife Cam Lever complete, Nos. 19793 and 39409.....
39330	3759	Knife Cam Lever Slide with 1980, for 39460.....
39331	3759	Knife Cam Lever Slide Screw Washer for 39460.....
Nos. 39333 TO 39335 FOR 39336		
39333	3761	Clamp Arm Bracket.....
39334	3761	“ “ “ Hinge Block.....
39335	3761	“ “ Screw Plate.....
39336	3761	Clamp Arm Bracket (adjustable) complete for 18490 and 18491, Nos. 129e, 1178d, 1300d, 1654c, 39333 to 39335 and 50048j.....
39340	5027	Button Clamp Spring for 39341.....
39341	—	“ “ “ 39340 with 39342, for flat or stud back buttons, for 17904.....
39342	5027	Button Clamp Spring Plate for 39341...
39343	5028	Stop Cam Interlocking Rod Case Spring (flat) for 18493 and 18494.....
39344	3759	Stop Cam Interlocking Rod Case Spring Bracket with 1520e and 50682c, for 18493 and 18494.....
39346	5028	Stop Cam Interlocking Rod Case Bracket for 55304.....
39348	5028	Stop Cam Interlocking Rod Case Bracket for 55305.....
39350	5029	Needle Bar Thread Nipper Driving Lever (adjustable) with 39351 and two 335j.....
39351	3759	Needle Bar Thread Nipper Driving Lever Extension for 39350.....
39352	5029	Needle Bar Thread Nipper Driving Lever Spring.....
39361	8583	Feed Regulator with 1953, for 69-22 Machine.....
39362	—	Feed Plate (thick) for 69-13 Machine....
39409	—	Knife Cam Lever Body 39235 with 39460, for 39329.....

NO.	PLATE	NAME
39460	—	Knife Cam Lever Slide 39330 with 1255d and 39331, for 39409.....
39487	3702	Shuttle Driver with two 457c, for 69-16 and 69-19 Machines.....
39489	7008	Protector Arm with 39490, for 63753....
39490	—	“ Blade for 39489.....
Nos. 39491 TO 39494 FOR 63753		
39491	7008	Protector Bracket with two each 426c and 448c.....
39492	7009	Protector Crank with 160c.....
39493	7009	“ “ Bracket with 1120c and two 454c.....
39494	7008	Protector Rod.....
39495	7009	“ “ Connection for 39498.....
39496	7008	“ “ Sleeve for 63753.....
39497	7009	“ “ Spring for 63753.....
39498	—	Protector (front of needle) complete, Nos. 39495, 63753 and two each 176d and 50351d.....
41400	5023	Machine Rest Pin, wood (Attachments and Accessories).....
41598	5041	Bobbin Winder Base with 27916 and two 28084, for 41604 and 41713.....
41600	5041	Bobbin Winder Pulley with 155c, for 41604 and 41713.....
41604	5041	Bobbin Winder for 41716, Nos. 35d, 1620r, 27321, 27328, 27538, 41598, 41600, 41825 and 50355d.....
41713	3780	Bobbin Winder for 41714, Nos. 35d, 1620r, 27305, 27321, 27326, 41598, 41600, 41825 and 50356d.....
41714	—	Bobbin Winder (swinging automatic, left hand) complete for 2073, for 69-16 and 69-19 Machines, Nos. 161d, 41713, 60770 and two 1186c.....
41715	5023	Bobbin Winder Bracket for 18352 and 55269, for 41714 and 41716, obsolete..
41716	—	Bobbin Winder (swinging automatic, left hand) complete for 2996, for 69-5, 69-15, 69-17, 69-18 and 69-22 Machines, Nos. 161d, 41604, 60770 and two 1186c.....
41825	3781	Bobbin Winder Frame Spring for 41604 and 41713.....
41828	8582	Bobbin Winder Spindle Collar Pin for 27538.....

NO.	PLATE	NAME
42639	8584	Knife (stationary) Bracket Pin for 55324 and 55402.....
43808	5042	Bobbin Winder Tension Spring for 60770
*44001	—	Shuttle Cover 2075 with 112D, 466H, 2078, 2080, 2086 and 2090, for 39296..
46707	9090	Leg Brace with wood screw 1 in. No. 16, for 25297.....
46711	9090	Treadle Support for 25297.....
46712	—	“ “ Bolt 50297R with 12620 and 46713, for 25297.....
46713	8589	Treadle Support Bolt Packing for 46712.
50018F	5021	Knife Holder Pinion Stud Bracket Screw for 55306, 55329, 55330, 55333, 55336 and 55404.....
50029C	3759	Knife Cam Lever Hinge Screw for 18472
50048J	3761	Clamp Arm Bracket Hinge Screw (eccentric) for 39336.....
50117J	8584	Knife (stationary) Screw for 55329, 55330, 55333, 55336 and 55404.....
50237K	3705	Button Clamp Spreader Lever Hinge Screw for 17898, 17904, 63928 and 63929.....
50297R	20332	Treadle Support Bolt with 1522E, for 46712.....
50333C	5042	Arm Shaft Bushing (back) Adjusting Screw.....
50351D	7009	Protector Bracket Screw for 39498.....
50356D	5042	Bobbin Winder Frame Hinge Screw for 41604 and 41713.....
50598C	8584	Feed Across Regulator Ball Screw Stud for 55378 to 55380.....
50682C	8584	Stop Cam Interlocking Rod Case Spring Adjusting Screw for 39344.....
51057R	20332	Leg Bolt with 1522E, for 126758.....
51057R	20332	“ Cross Member Bolt with 1522E, for 126758.....
51057R	20332	Rail Bolt with 1522E, for 126758.....
51251J	8588	Hand Stop Lever Hinge Screw for 69-8 Machine.....
52598	7009	Protector Crank-Hinge Stud for 63753...
*55269	—	Cylinder for 69-16 and 69-19 Machines; obsolete.....
55271	5032	Shuttle Race Ring for 55401.....
55278	—	Oscillating Rock Shaft complete for all machines except 69-19, Nos. 1513J, 6022 and 6489.....

NO.	PLATE	NAME
55283	—	Thread Take-up Lever 18393 with 79c, for all machines except 69-16 and 69-19
*55284	—	Stop Cam Interlocking Rod Case 18440 with 1318D, 17855, 17863, 17864, 39222, 39223 and two 1255D, for 18442 and 18458, obsolete.....
*55285	—	Stop Cam Interlocking Rod Case 55418 with 1318D, 17855, 17863, 17864 and 39222, for 55304 and 55305.....
*55296	—	Knife Holder 17825 with 1198c, 17808, 17829 and 18389, for 55306, obsolete...
55300	5042	Feed Plate Carrier Bar Block Steady Pin for 18365, 18438, 18448, 18451 and 18486.....
*55302	—	Thread Take-up Cam for 18392.....
55304	—	Stop Cam Interlocking Rod Case Bracket complete for 18493, Nos. 1182E, 1196c, 1204E, 1254c, 1262c, 1508E, 1662c, 17853, 17859, 17861, 17862, 17872, 17873, 39346, 55285 and two 898D....
55305	—	Stop Cam Interlocking Rod Case Bracket complete for 18494, Nos. 1182E, 1196c, 1204E, 1254c, 1262c, 1508E, 1662c, 17853, 17859, 17861, 17862, 17872, 17873, 39348, 55285 and two 898D....
55306	—	Throat Plate 18382 with 1698c, 17828, 50018F and 55296, for all machines except 69-11, obsolete.....
55308	—	Feed Cam with two each 1192c, 17874 and four 190J, for 69-17 Machine.....
55309	—	Feed Cam with two 1192c, four each 190J, and 17874, for 69-18 Machine.....
55319	8582	Knife (needle thread) for 55323.....
55320	8582	“ (shuttle thread) for 55323 and 55398.....
55321	8582	Knife (stationary) for 55329, 55330, 55333, 55336 and 55404.....
*55322	—	Knife (stationary) Bracket for 55324....
55323	—	“ Holder 17825 with 1198c, 17829, 55319 and 55320, for 55329, 55330, 55333 and 55336.....
55324	8586	Throat Plate with 55322 and two 42639, for 55327, 55328, 55332 and 55335....
55325	8586	Throat Plate Needle Hole Bushing (large needle hole) for 55327 and 55403.....
55326	8586	Throat Plate Needle Hole Bushing (small needle hole) for 55328.....

NO.	PLATE	NAME
55327	—	Throat Plate 55324 with 55325 and two 1208d, for 55329.....
55328	—	Throat Plate 55324 with 55326 and two 1208d, for 55330.....
55329	—	Throat Plate complete for 69-5, 69-8, 69-15, 69-17 and 69-22 Machines, Nos. 1698c, 17828, 50018F, 50117J, 55321, 55323 and 55327.....
55330	—	Throat Plate complete for 69-6, 69-9, 69-10, 69-13, 69-14 and 69-18 Machines, Nos. 1698c, 17828, 50018F, 50117J, 55321, 55323 and 55328.....
55331	8586	Throat Plate Needle Hole Bushing for 55332.....
55332	—	Throat Plate 55324 with 55331 and two 1208d, for 55333.....
55333	—	Throat Plate complete for 69-11 Machine, Nos. 1698c, 17828, 50018F, 50117J, 55321, 55323 and 55332.....
55334	8586	Throat Plate Needle Hole Bushing for 55335.....
55335	—	Throat Plate 55324 with 55334 and two 1208d, for 55336.....
55336	—	Throat Plate complete for 69-7 and 69-12 Machines, Nos. 1698c, 17828, 50018F, 50117J, 55321, 55323 and 55335.....
55376	8585	Feed Across Connection with 21358, 55377 and four 1057e, for 55378 to 55380.....
*55377	—	Feed Across Connection Cap (upper) for 55376.....
55378	—	Feed Across Connection 55376 with 50598c and 55381, for 69-5 to 69-7, 69-10, 69-13 to 69-19 and 69-22 Machines.....
55379	—	Feed Across Connection 55376 with 50598c and 55382, for 69-8, 69-9 and 69-11 Machines.....
55380	—	Feed Across Connection 55376 with 50598c and 55383, for 69-12 Machine
55381	8584	Feed Across Shaft Crank (back) Ball Stud for 55378.....
55382	8584	Feed Across Shaft Crank (back) Ball Stud for 55379.....
55383	8584	Feed Across Shaft Crank (back) Ball Stud for 55380.....

NO.	PLATE	NAME
55384	—	Arch Clamp Foot (left) 18473 with 219K and 63731, for 55386.....
55385	—	Arch Clamp Foot (right) 18475 with 219K and 63732, for 55386.....
55386	—	Arch Clamp complete for 69-14 and 69-16 Machines, Nos. 1654c, 18367, 18477, 18484, 18486, 55384, 55385, 63734, two each 181d, 1229F, 1547J, 14079, 63733 and four 190J.....
55387	8583	Stop Cam Interlocking Rod Case for 18492, obsolete.....
55388	8585	Stop Cam Interlocking Rod Case for 55389.....
55389	—	Stop Cam Interlocking Rod Case 55388 with 18443 and two 193J, for 55418.....
55390	8582	Arch Clamp Foot (left) for 55391.....
55391	—	" " " " 55390 with 219K and 63731, for 55394.....
55392	8582	Arch Clamp Foot (right) for 55393.....
55393	—	" " " " 55392 with 219K and 63732, for 55394.....
55394	—	Arch Clamp complete for 69-22 Machine, Nos. 1654c, 18367, 18477, 18486, 55391, 55393, 55396, 63734, two each 181d, 1229F, 1547J, 14079, 63733 and four 190J.....
55395	8585	Feed Cam with two each 190J, 1192c and 17874, for 69-22 Machine.....
55396	8582	Feed Plate for 55394.....
55397	8582	Knife (needle thread) for 55398.....
55398	—	" Holder 17825 with 1198c, 17829, 55320 and 55397, for 55404.....
55399	—	Knife (stationary) Bracket for 55402.....
55400	—	Shuttle Race Body for 55401.....
55401	—	Shuttle Race complete for 69-16 and 69-19 Machines, Nos. 55271, 55400 and two each 1289d and 18413.....
55402	8587	Throat Plate with 55399 and two 42639, for 55403.....
55403	—	Throat Plate 55402 with 55325 and two 1208d, for 55404.....
55404	—	Throat Plate complete for 69-16 and 69-19 Machines, Nos. 1698c, 17828, 50018F, 50117J, 55321, 55398 and 55403.....
*55405	—	Arm with 4449, 17844 and two 164E, for all machines except 69-8.....

NO.	PLATE	NAME
*55406	—	Arm with 4449, 17844 and two 164e, for 69-8 Machine.....
*55407	—	Cylinder for all machines except 69-16 and 69-19.....
*55408	—	Cylinder for 69-16 and 69-19 Machines..
55410	8588	Arch Clamp Foot (left) for 55411.....
55411	—	“ “ “ “ 55410 with 219κ and 63731, for 55414.....
55412	8588	Arch Clamp Foot (right) for 55413.....
55413	—	“ “ “ “ 55412 with 219κ and 63732, for 55414.....
55414	—	Arch Clamp complete for 69-22 Machine, Nos. 1654c, 18367, 18477, 18486, 55411, 55413, 55417, 63734, two each 181D, 1229F, 1547J, 14079, 63733 and four 190J (For Singer Clydebank only).....
55417	8588	Feed Plate for 55414.....
55418	—	Stop Cam Interlocking Rod Case 55389 with 63976 and two 1255D, for 55285.
55431	—	Starting Lever Rock Shaft for 55432....
55432	—	Starting Lever Rock Shaft complete for 1800 Series Motors, Nos. 32134, 55431, 55433, wood screw 1 in. No. 12 F. H. and two each 2770, 21327 and 27683...
55433	—	Starting Lever Rock Shaft Chain, 10¼ in. long, with 56865, for 55432.....
56756	—	Thread Take-up Lever 3072 with 76c, for 69-16 and 69-19 Machines.....
56812	—	Oscillating Rock Shaft Hinge Pin 3052 with 1513r, for 16806.....
56864	5042	Starting Lever Rock Shaft Chain Hook for 14224.....
56865	8588	Starting Lever Rock Shaft Chain Hook for 55433.....
60769	3780	Bobbin Winder Tension Bracket for 60770.....
60770	3780	Bobbin Winder Tension Bracket complete for 41714 and 41716, Nos. 419e, 1562J, 8422, 9780, 43808, 60769 and two 2455.....
62155	8585	Feed Cam Shaft.....
62739	8584	Shuttle Bobbin Case for 15277.....
63726	8582	Arch Clamp Foot Lifting Stud for 63731 and 63732.....
63731	—	Arch Clamp Foot Shank (left) with 63726, for 55384, 55391 and 55411.....

NO.	PLATE	NAME
63732	—	Arch Clamp Foot Shank (right) with 63726, for 55385, 55393 and 55413....
63733	8585	Arch Clamp Foot Spring for 55386, 55394 and 55414.....
63734	8583	Arch Clamp Frame for 55386, 55394 and 55414.....
*63736	—	Face Plate 17724 with 2105, for 17725....
*63749	—	Thread Take-up Cam for 39204.....
63753	—	Protector (front of needle) for 39498, Nos. 1099F, 39489, 39491 to 39494, 39496, 39497, 52598 and two 15261.....
63788	7205	Button Clamp Arm Hook for 17927 and 63927.....
63788	7205	Clamp Arm Hook for 17908 and 17947..
63811	7205	“ “ (lower) with two 17992, for 18490.....
63812	7205	Clamp Arm (upper) for 18490.....
63927	7205	Button Clamp Arm with 17714 and 63788 for 63928 and 63929.....
63928	—	Button Clamp (universal) complete, for 10 to 50 line thin buttons, for 69-5, 69-6, 69-17 and 69-18 Machines, Nos. 1180J, 1181J, 1182J, 1183J, 17717 to 17719, 39238, 39239, 39242, 39244 or 39246, 39245 or 39247, 39248, 50237κ, 63927 and two each 229J and 1175J...
63929	—	Button Clamp (universal) complete, for 26 to 55 line buttons, for 69-15 Machine, Nos. 1180J, 1181J, 1182J, 1183J, 17717 to 17719, 18464 to 18466, 39242, 39244 or 39246, 39245 or 39247, 50237κ, 63927 and two each 229J and 1175J....
63973	—	Table Belt Guide Pulley Shaft (long) Wick (braided cotton) for 39219.....
63974	—	Table Belt Guide Pulley Shaft (short) Wick (braided cotton) for 39220.....
63975	8583	Pulley (loose) 2¼ in. diam., for 17955
63976	8582	Belt Shifter Clamp for 55418.....
63981	—	Starting Lever Rock Shaft complete for 25291, Nos. 2770, 7124, 14224 and two each 16128 and 27683.....
120346	4079	Oiler (copper plated) with 120347 (Attachments and Accessories).....
120347	4079	Oiler Spout, 9 in. long, for 120346.....
124674	8583	Arm Side Cover.....
124706	8589	Button Spacing Gauge Holder for 12495 2
124950	8588	“ “ “ for 124952.....

NUMERICAL LIST OF PARTS

NO.	PLATE	NAME
124951	8589	Button Spacing Gauge Plate for 124952..
124952	—	Button Spacing Gauge complete, Nos. 181J, 9525, 124706, 124950, 124951 and two each 217J, 7071 and wood screws 1 in. No. 10 R. H.....
126391	8583	Bobbin Winder Bracket for 55407 and 55408, for 41714 and 41716.....
126508	9090	Leg for 126758.....
126509	20332	" Bolt Nut Socket Washer for 126758
126509	20332	" Cross Member Bolt Nut Socket Washer for 126758.....
126509	20332	Rail Bolt Nut Socket Washer for 126758..
126530	9090	Leg Cross Member, 15½ in. long, for 126758.....
126532	9090	Rail, 16 in. long, for 126758.....
126758	—	Leg with Rail complete for 25297, Nos. 126530, 126532, two 126508, three 12620 and four each 51057R and 126509
200383c	8584	Thread Unwinder Spool Rest Rod Set Screw for 202490.....
201018c	8584	Thread Unwinder Spool Rest Set Screw for 225395.....
201696J	8584	Thread Unwinder Thread Guide Lock Nut for 225396.....
202490	7233	Thread Unwinder Spool Stand with 200383c, for 225396.....
225322	20332	Thread Unwinder Thread Guide Rod Washer for 225324.....
225324	7233	Thread Unwinder Thread Guide Rod with 208E and 225322, for 225396.....
225326	20332	Thread Unwinder Thread Guide Position Cup for 225396.....
225388	7233	Thread Unwinder Spool Rest Rod for 225396.....
225390	7234	Thread Unwinder Thread Cone Holder, for inverted cones, for 225396.....
225391	7233	Thread Unwinder Thread Guide for 225396.....
225395	7233	Thread Unwinder Spool Rest with 201018c, for 225396.....
225396	7233	Thread Unwinder complete, for two spools, Nos. 201696J, 202490, 225324, 225326, 225388, 225395, two 225391 and three wood screws ¼ in. No. 12...

PLATE 3702—FULL SIZE



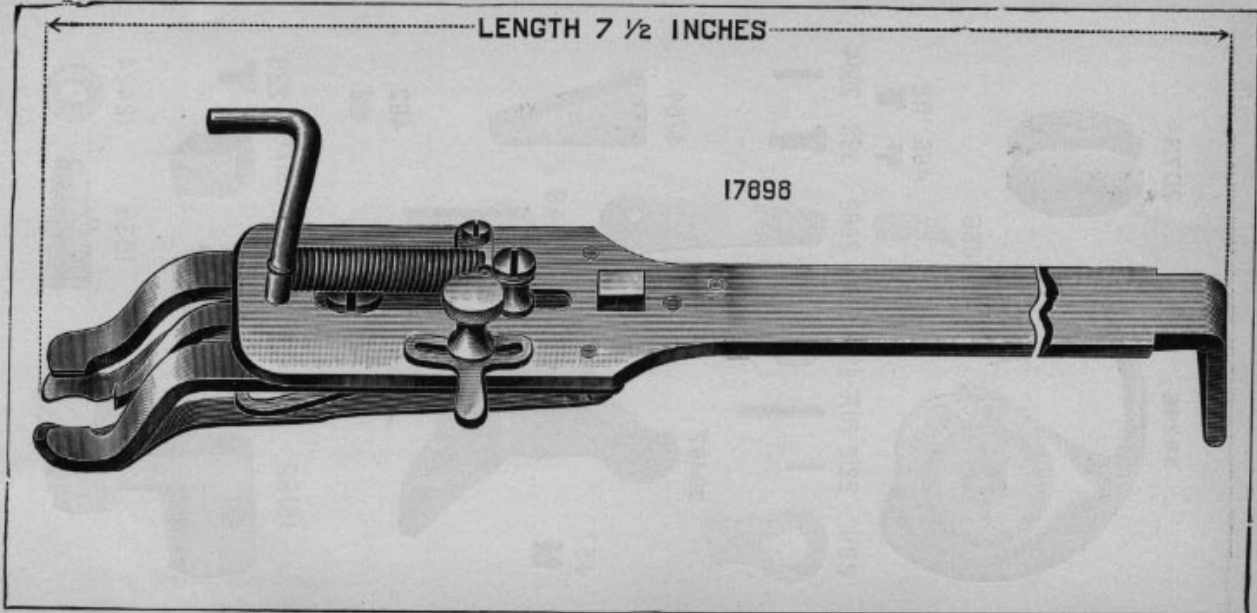

LENGTH 7 1/2 INCHES

17898

PLATE 3703—FULL SIZE

PLATE 3704—FULL SIZE

LENGTH 7 IN. INCHES

17690



PLATE 3704—FULL SIZE

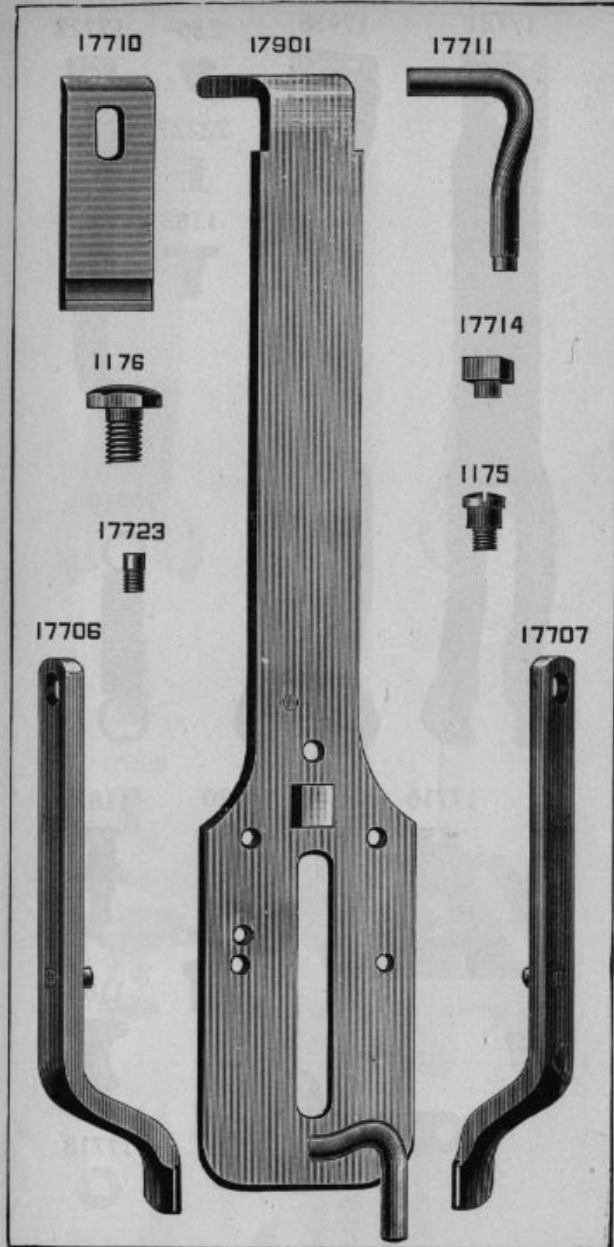

PLATE 3705—FULL SIZE

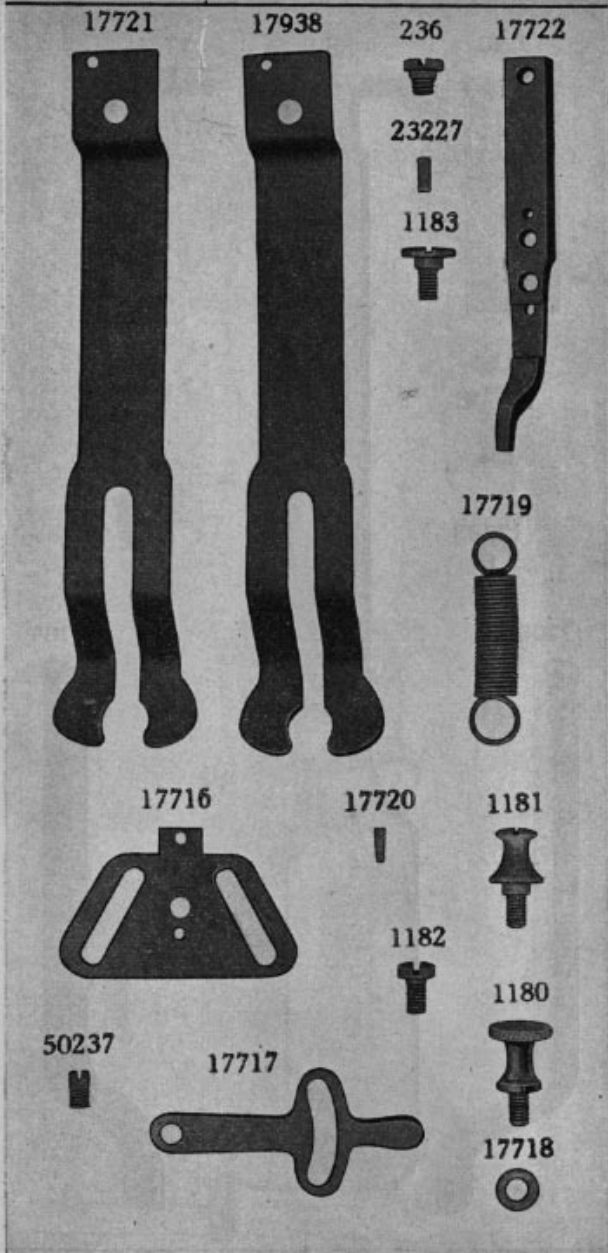

PLATE 3706—FULL SIZE

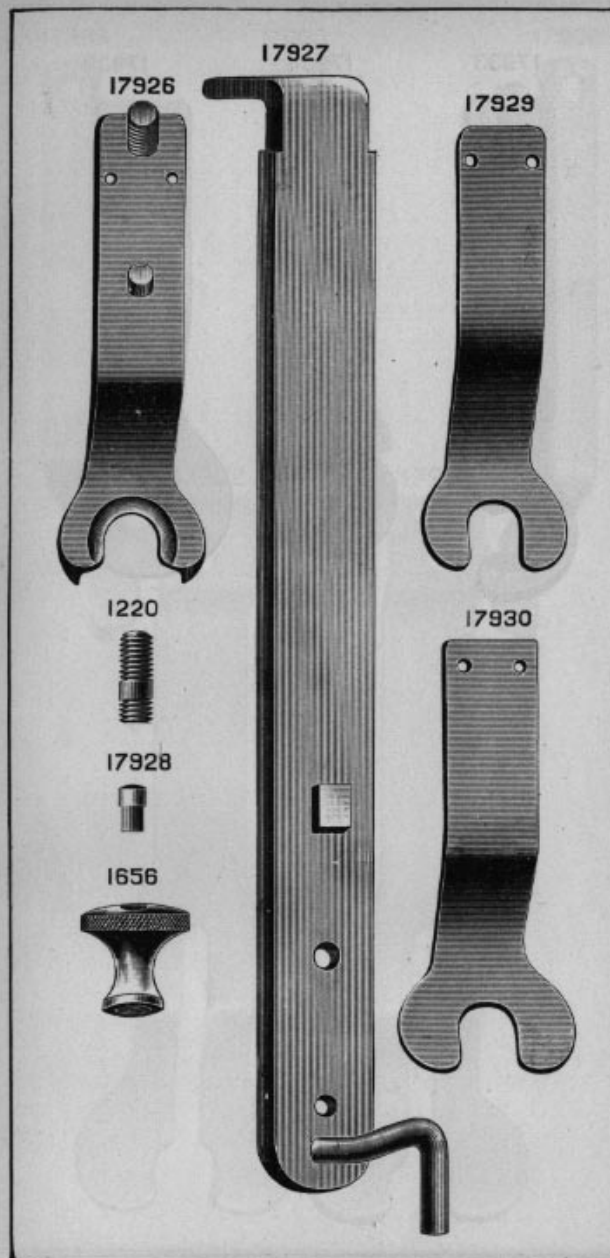

PLATE 3707—FULL SIZE

17933



17934



17935

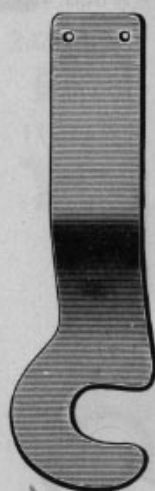
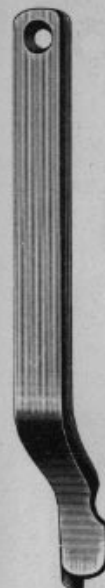
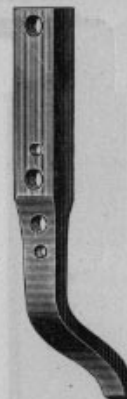

PLATE 3708—FULL SIZE

17899



17903



17900



17902



17939

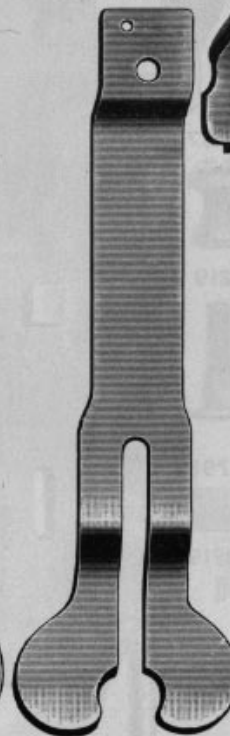

PLATE 3709—FULL SIZE

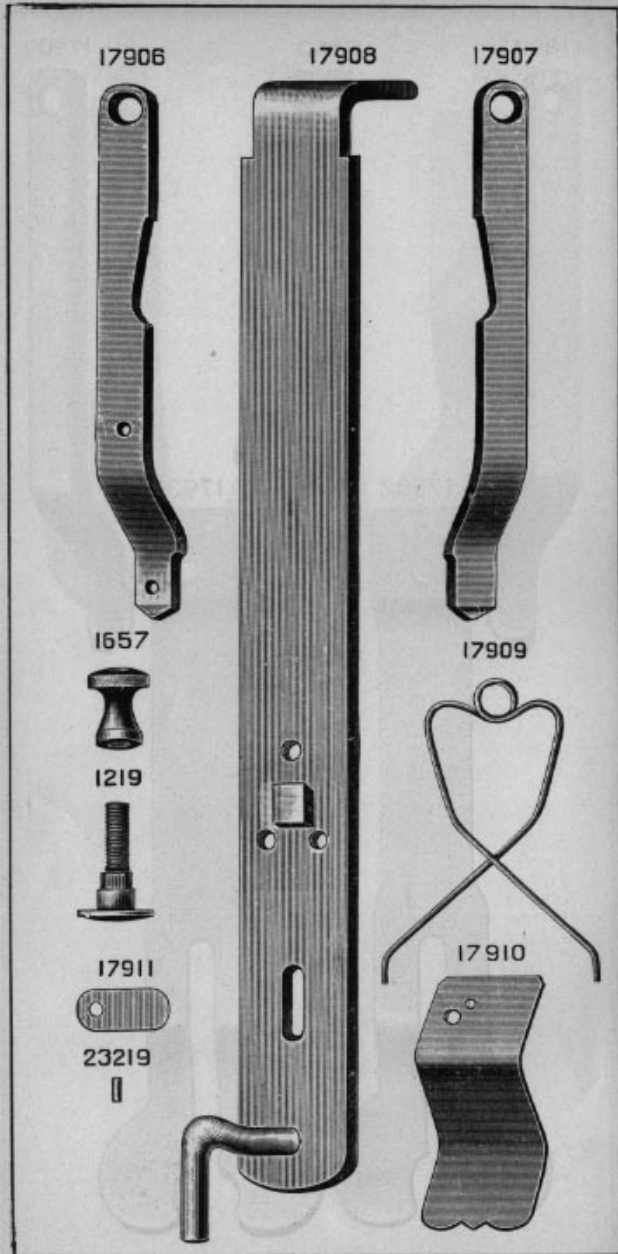

PLATE 3710—FULL SIZE

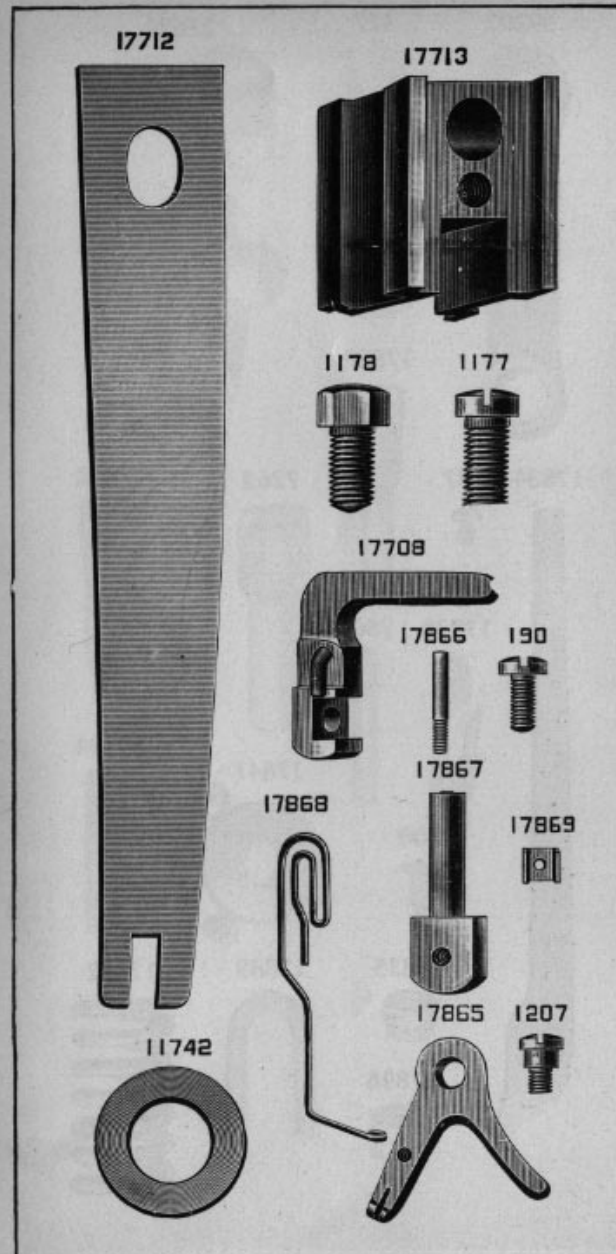

PLATE 3718—FULL SIZE

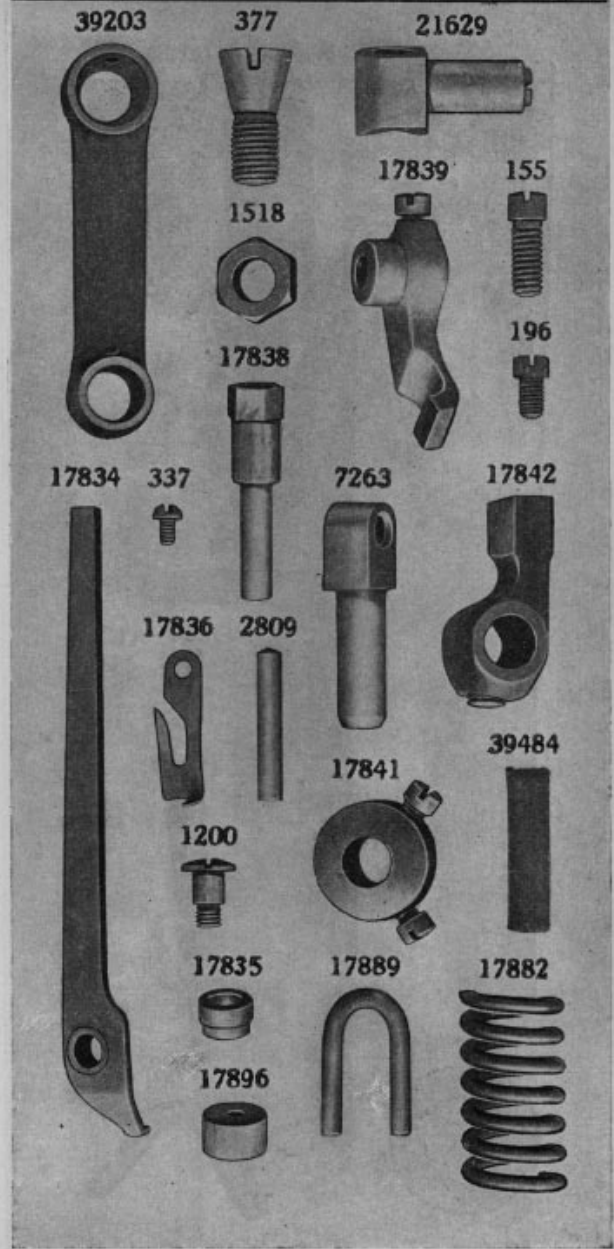

PLATE 3721—FULL SIZE

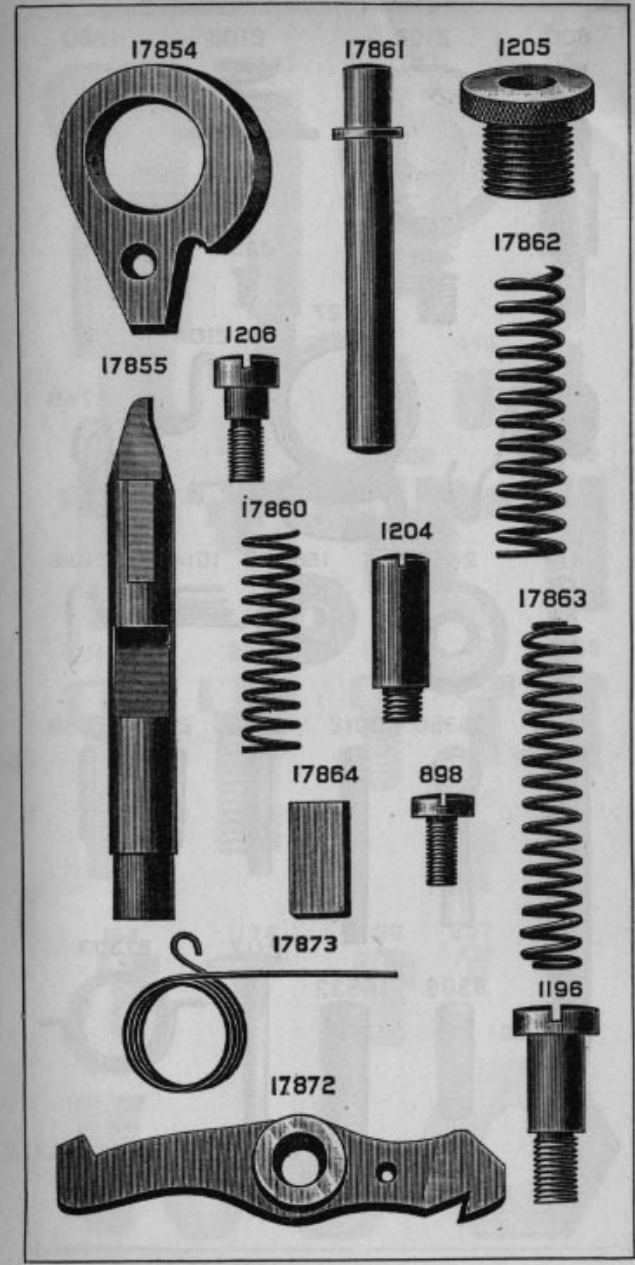

PLATE 3722—FULL SIZE

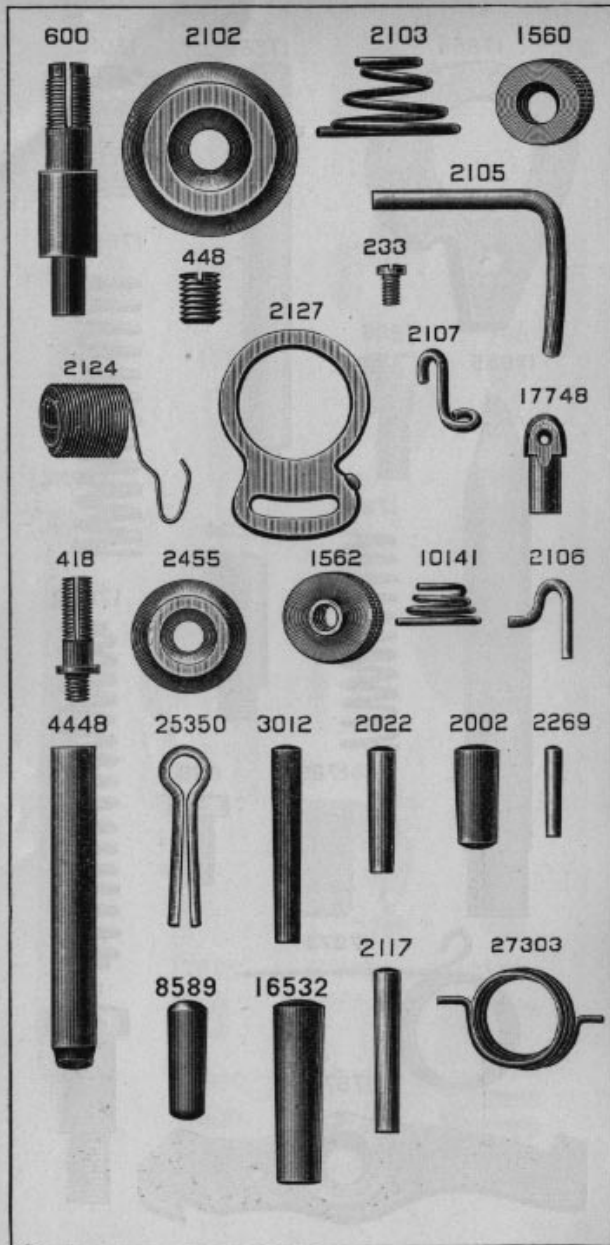

PLATE 3724—FULL SIZE

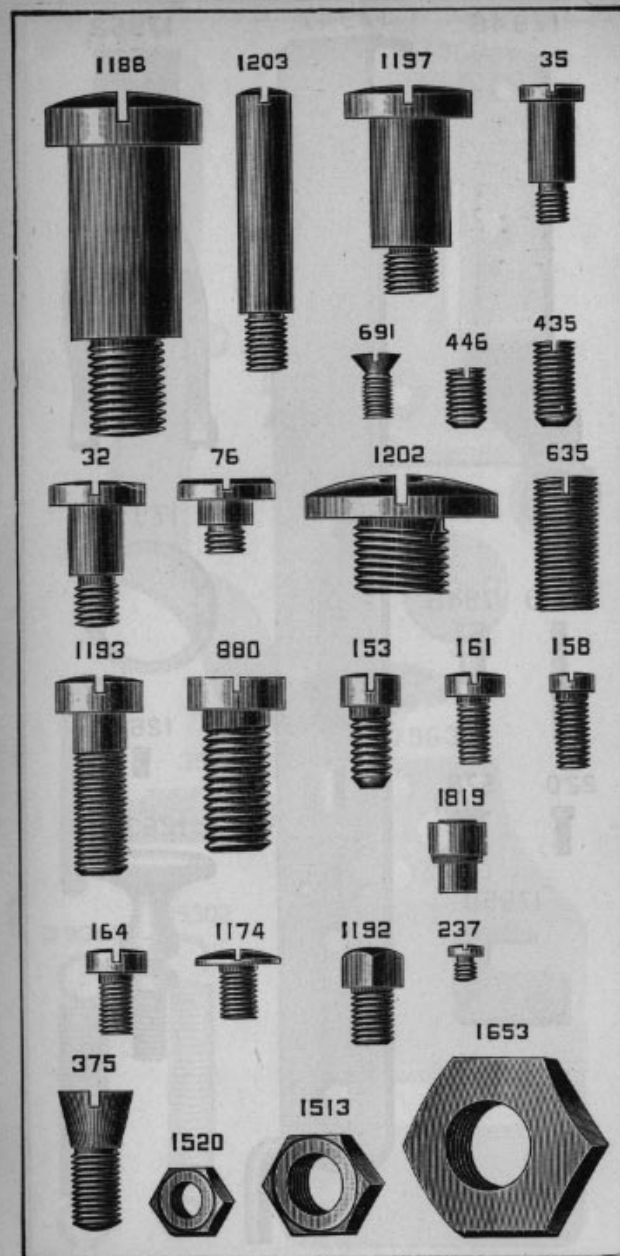

PLATE 3729—FULL SIZE

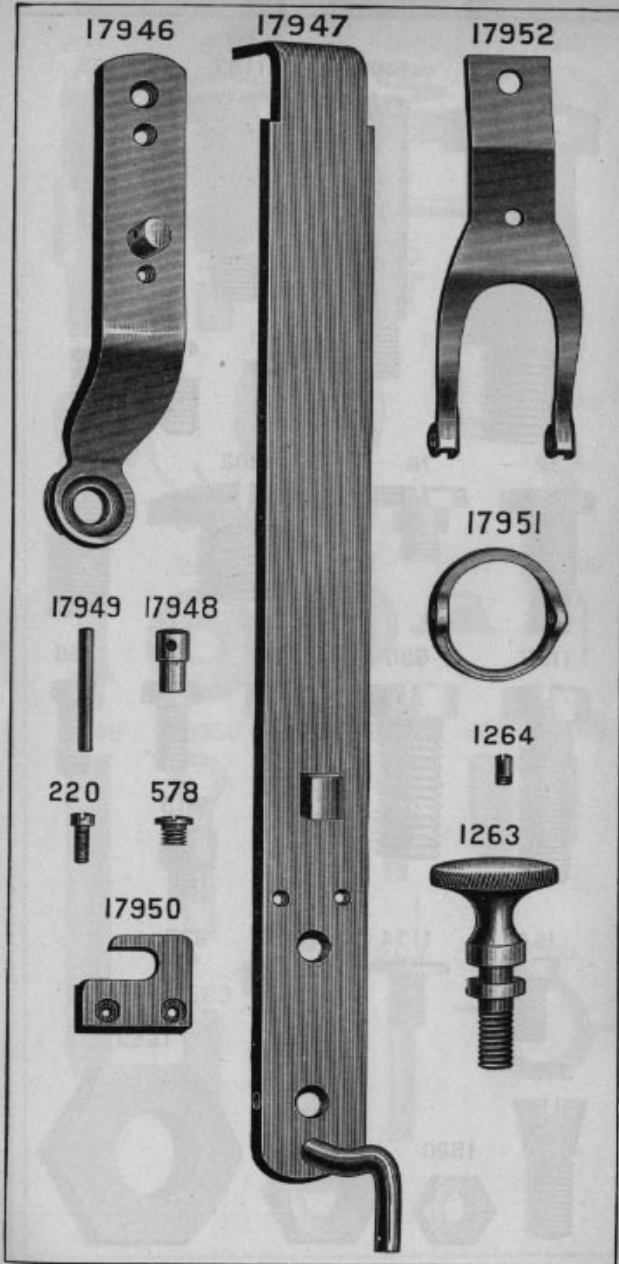

PLATE 3731—FULL SIZE

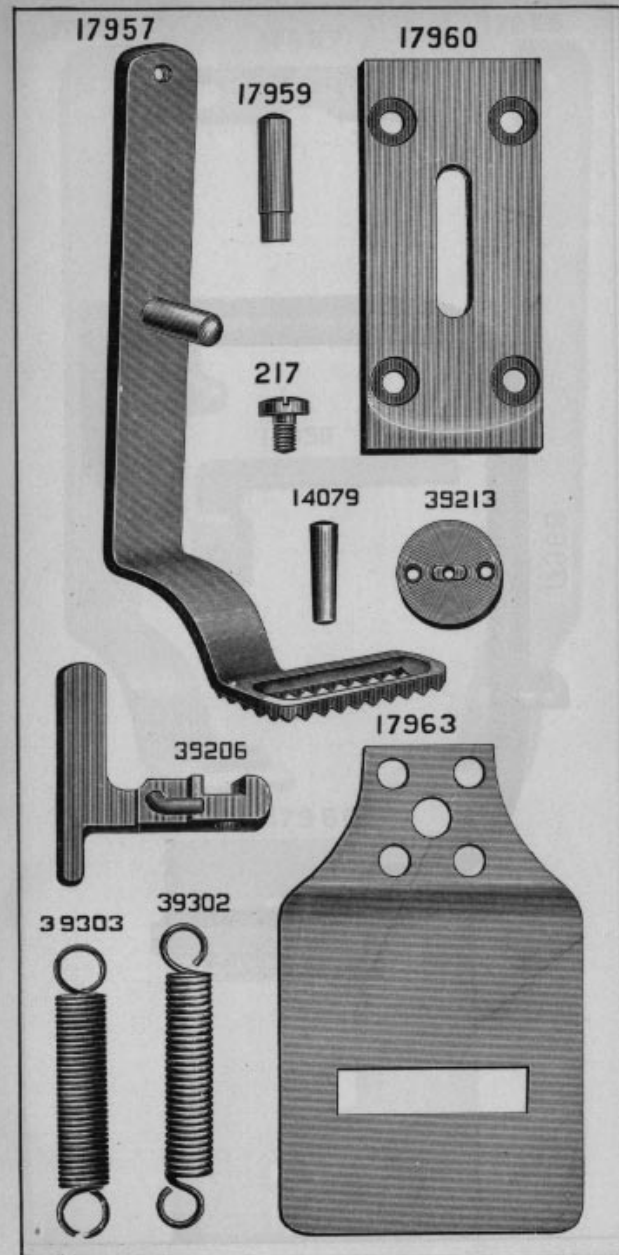

PLATE 3732—ONE-HALF SIZE

17968

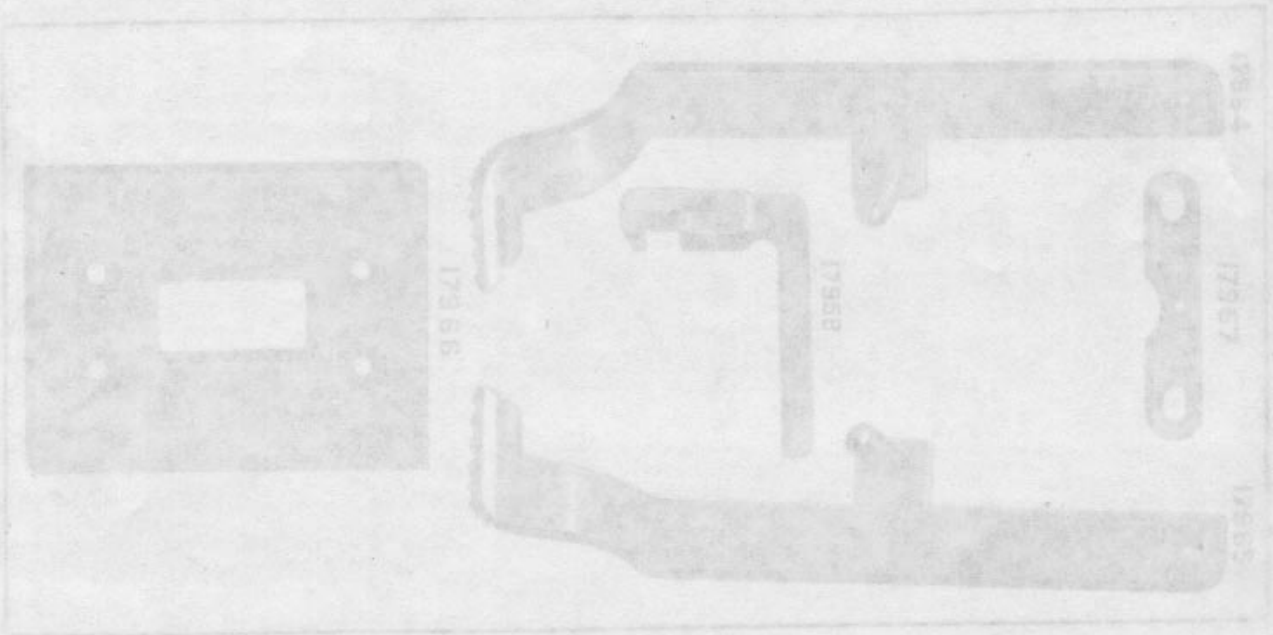

PLATE 3733—FULL SIZE

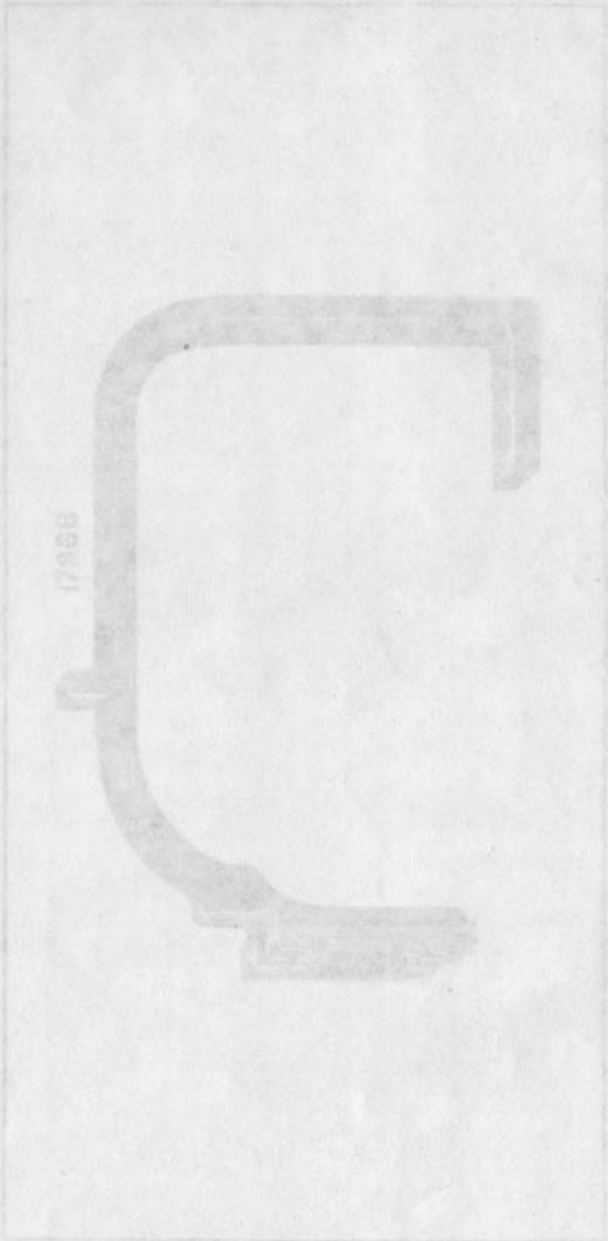

PLATE 3733—FULL SIZE

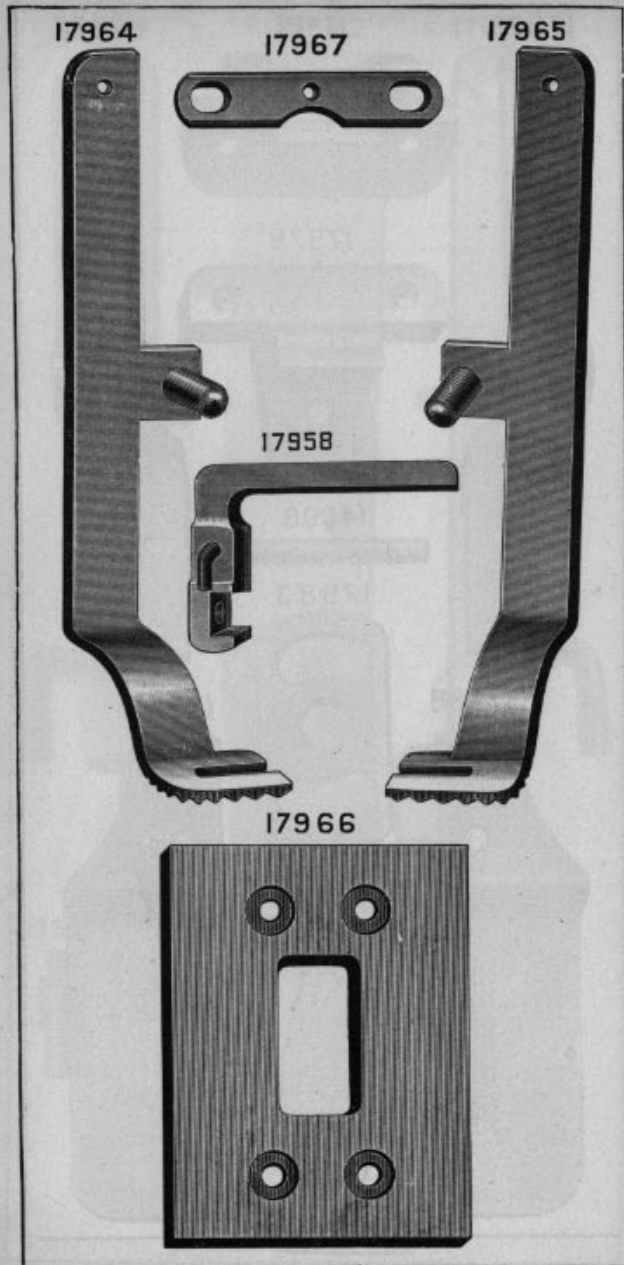

PLATE 3737—FULL SIZE

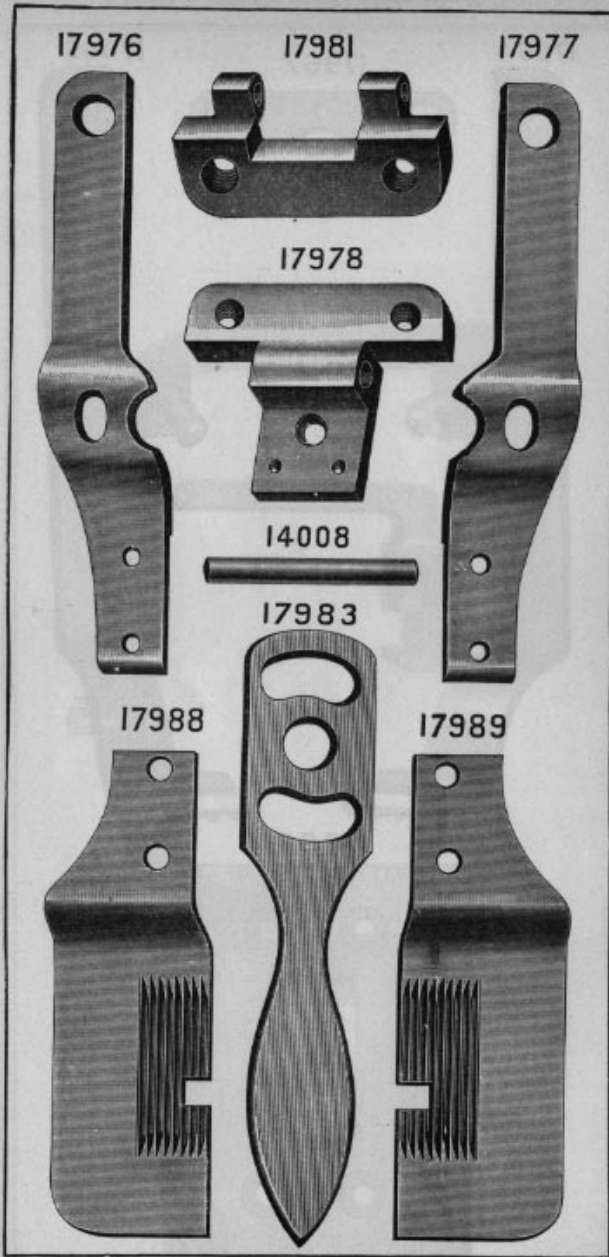

PLATE 3738—FULL SIZE

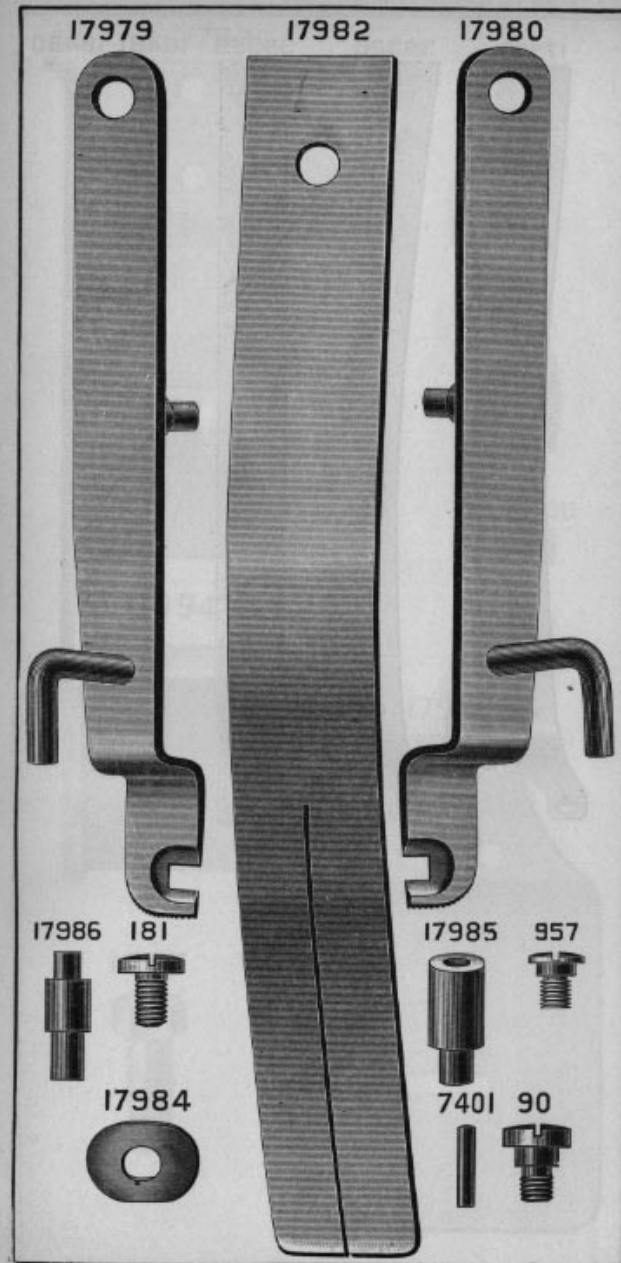

PLATE 3739—ONE-HALF SIZE

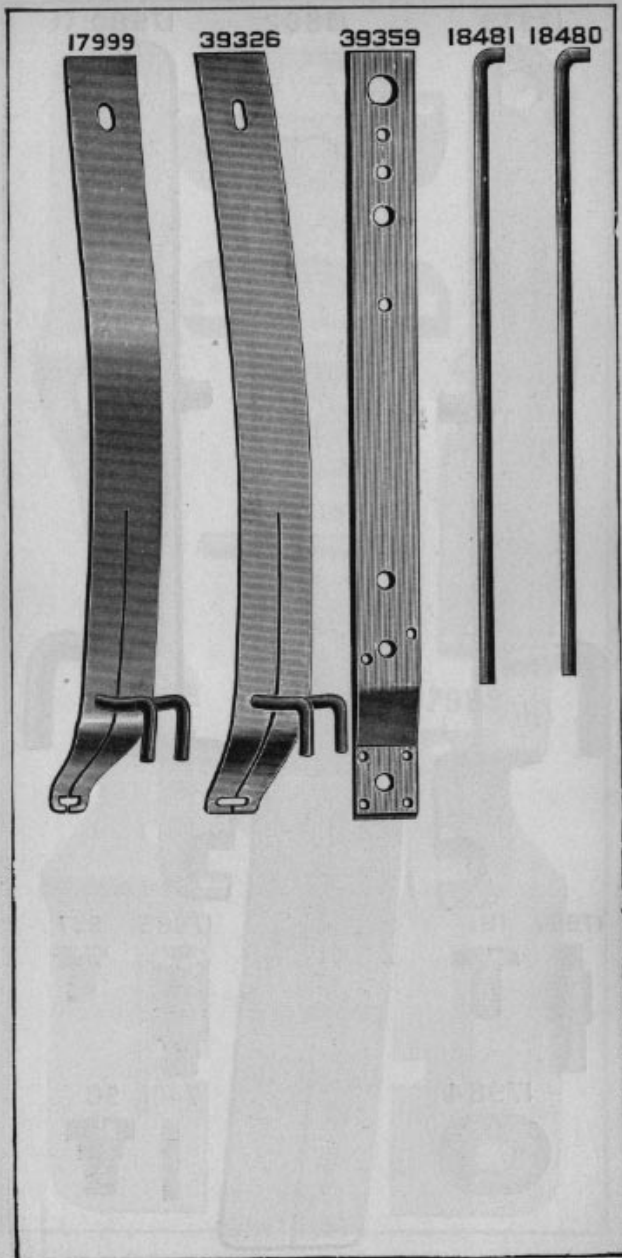

PLATE 3740—FULL SIZE

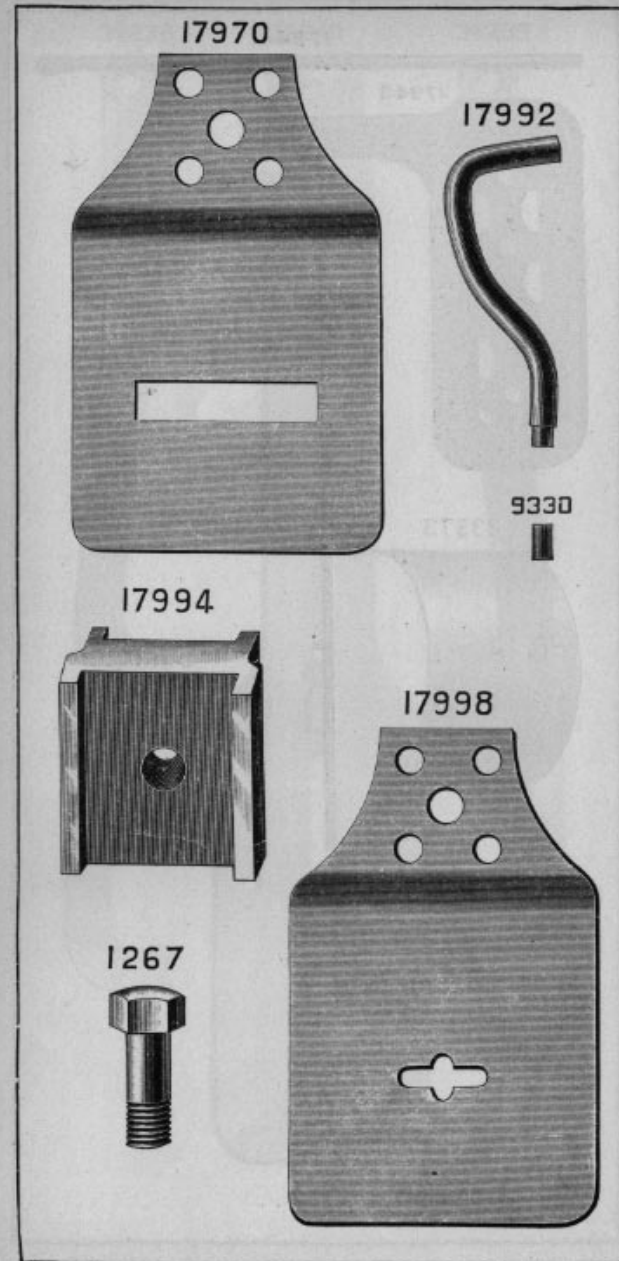

PLATE 3741—ONE-FOURTH SIZE

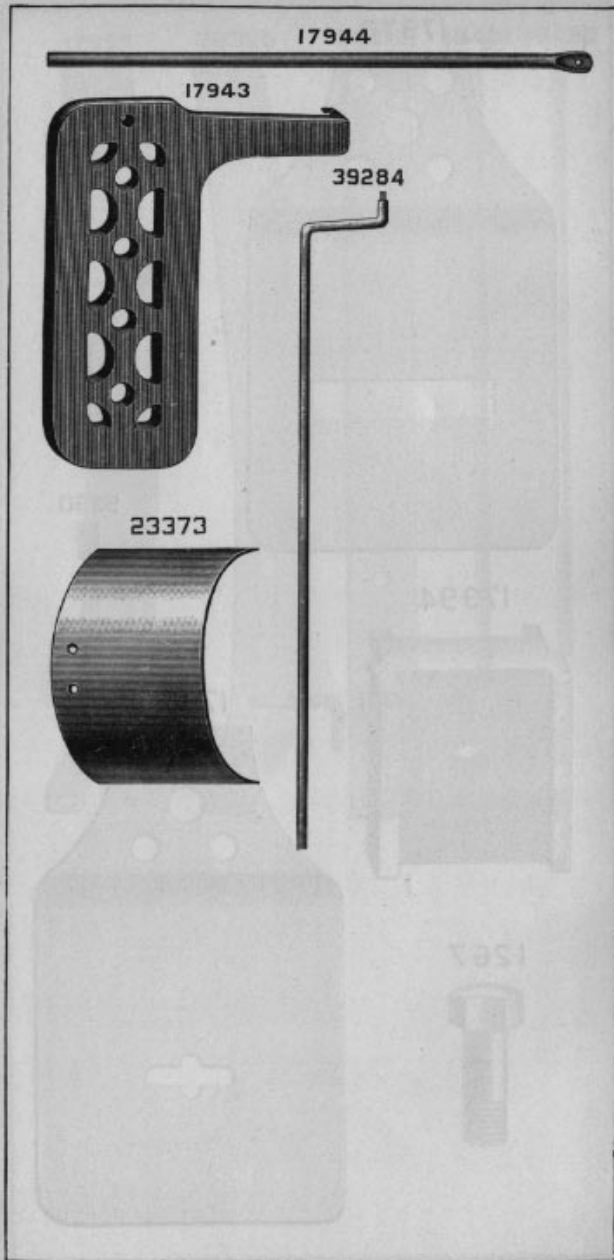

PLATE 3747—FULL SIZE

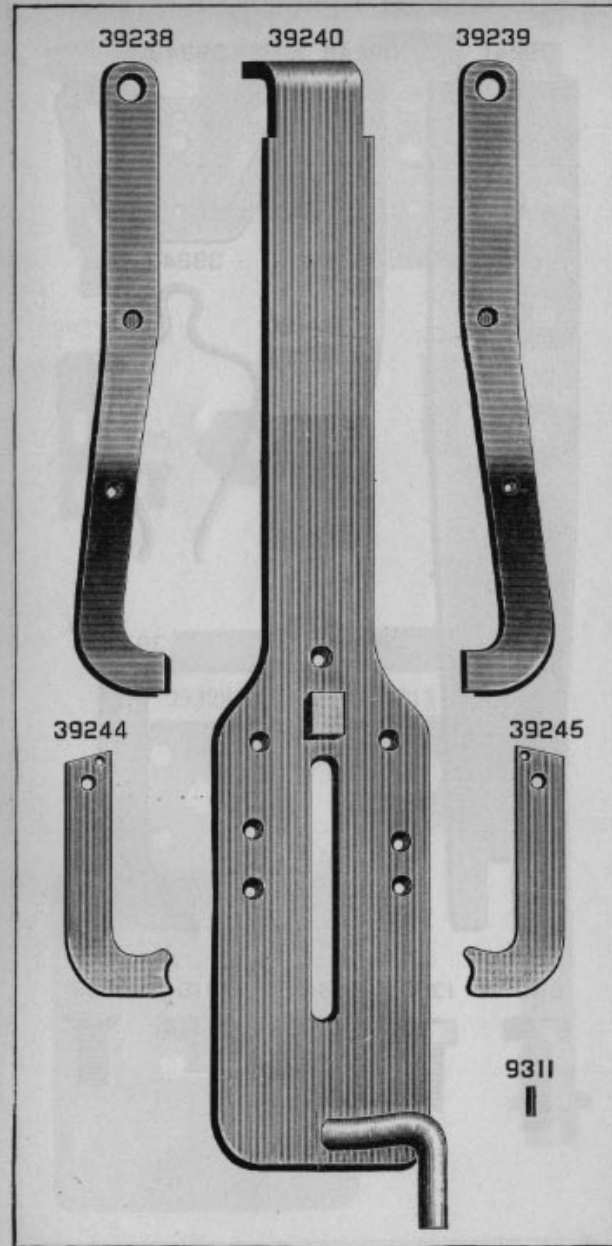

PLATE 3748—FULL SIZE

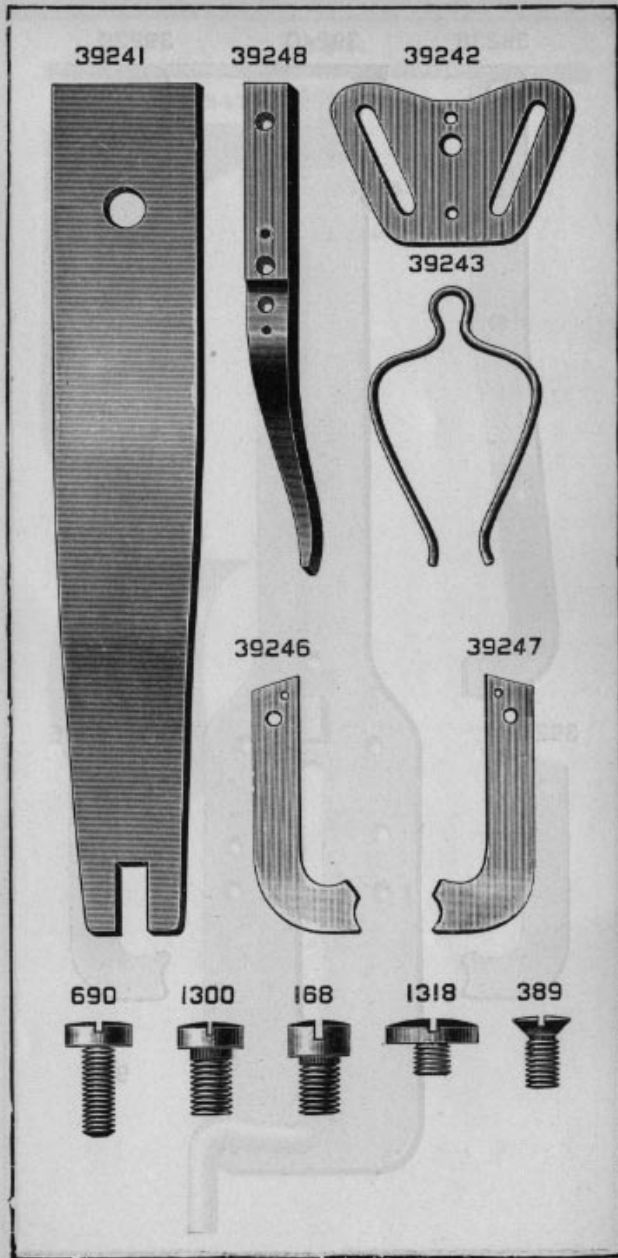

PLATE 3759—FULL SIZE

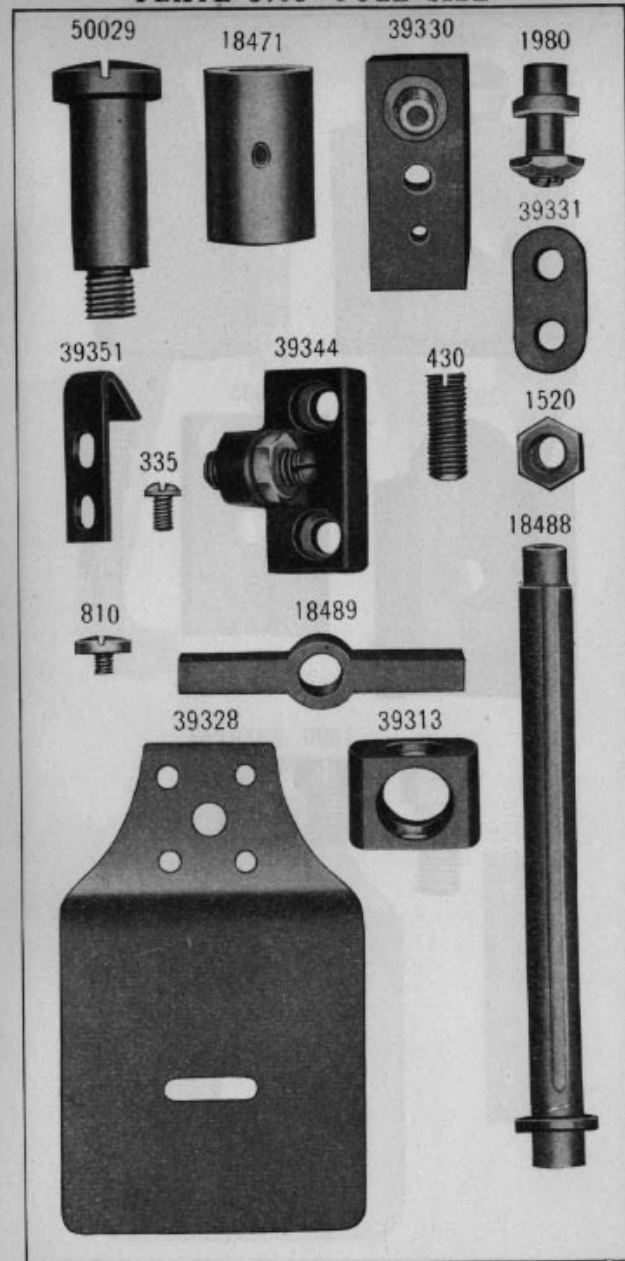

PLATE 3761—FULL SIZE

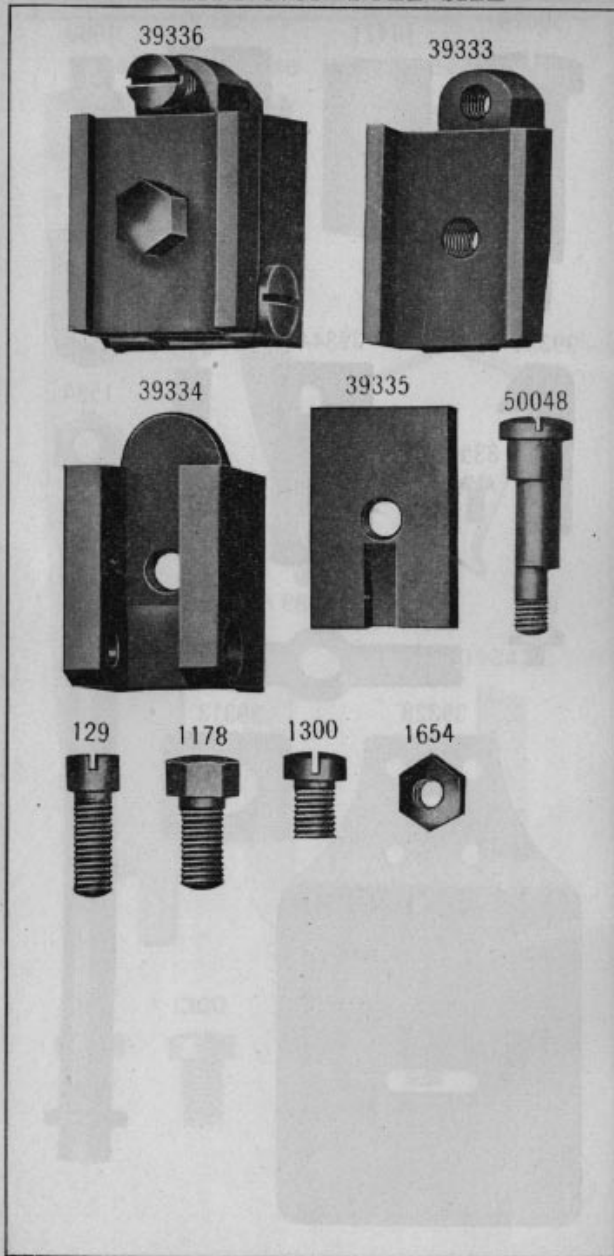

PLATE 3764—FULL SIZE

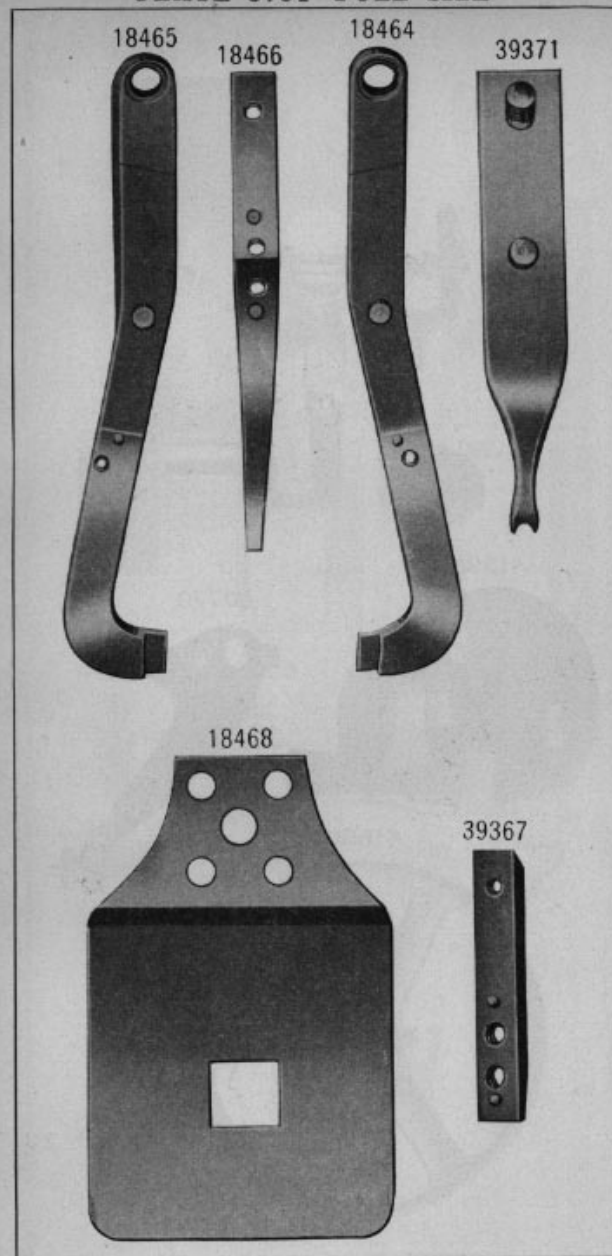
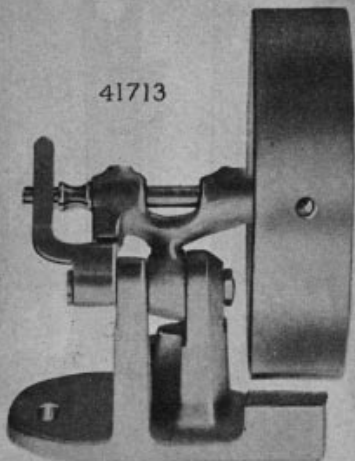
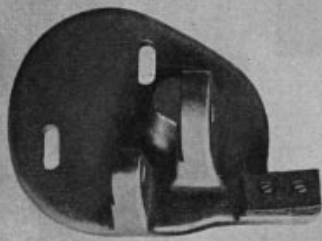

PLATE 3780—ONE-HALF SIZE

41713



41598



60770



60769

41600

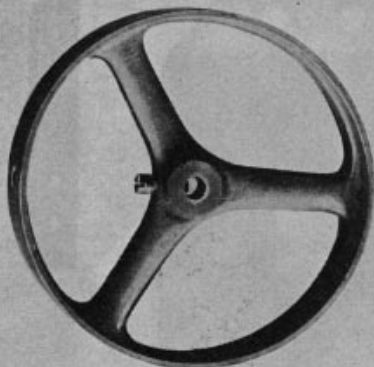
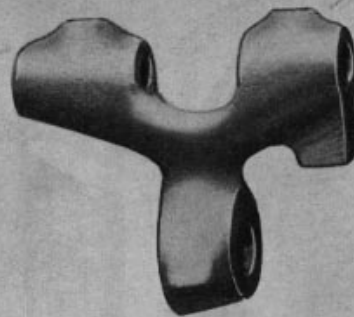

PLATE 3781—FULL SIZE

27321



9780



27305



419



27916



28084

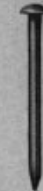

27326

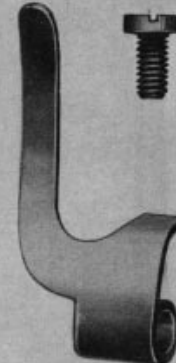

161



41825



43808



1562



1186



2455



1620



8422



50356



35



155



PLATE 4079—ONE-HALF SIZE

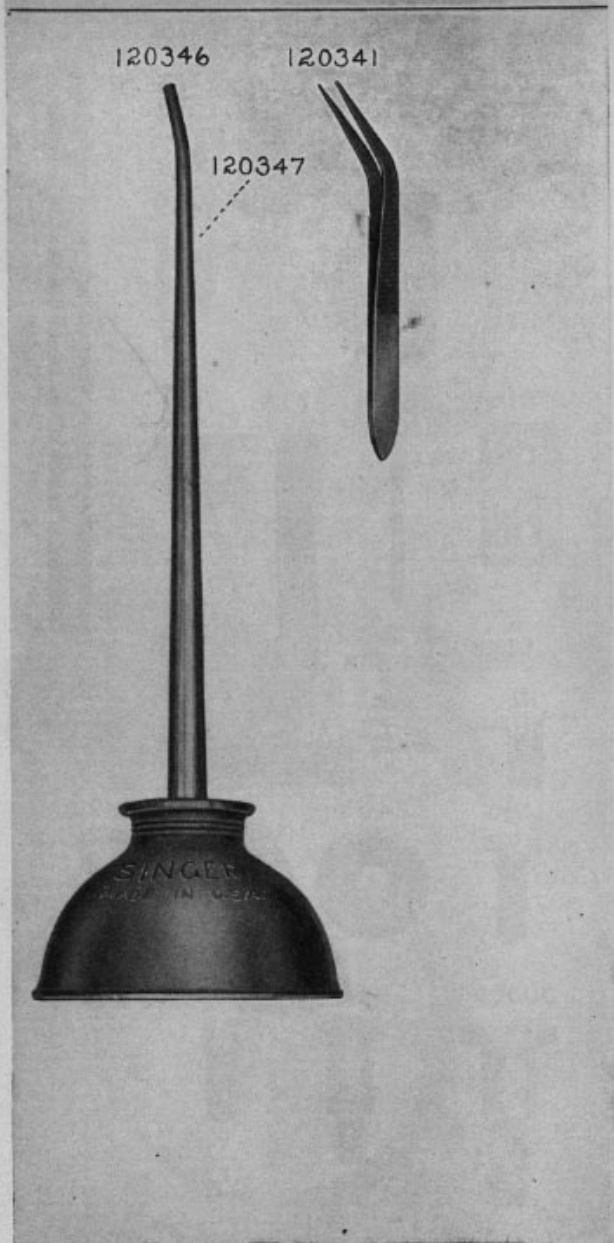

PLATE 5000—ONE-FOURTH SIZE

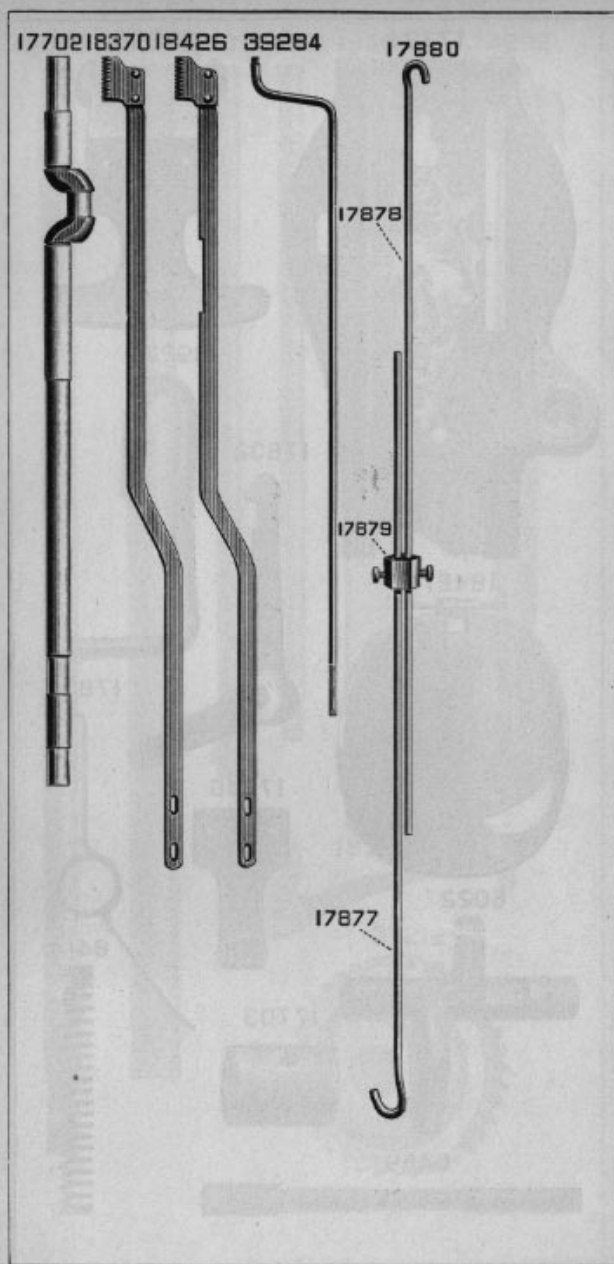

PLATE 5001—ONE-HALF SIZE

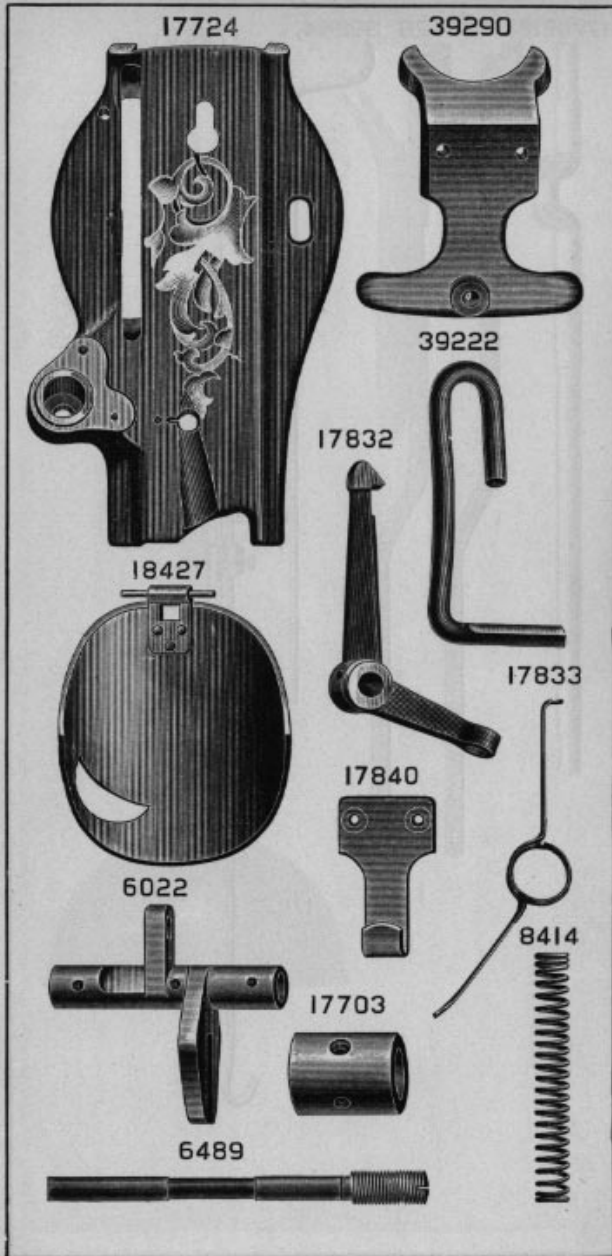

PLATE 5002—ONE-HALF SIZE

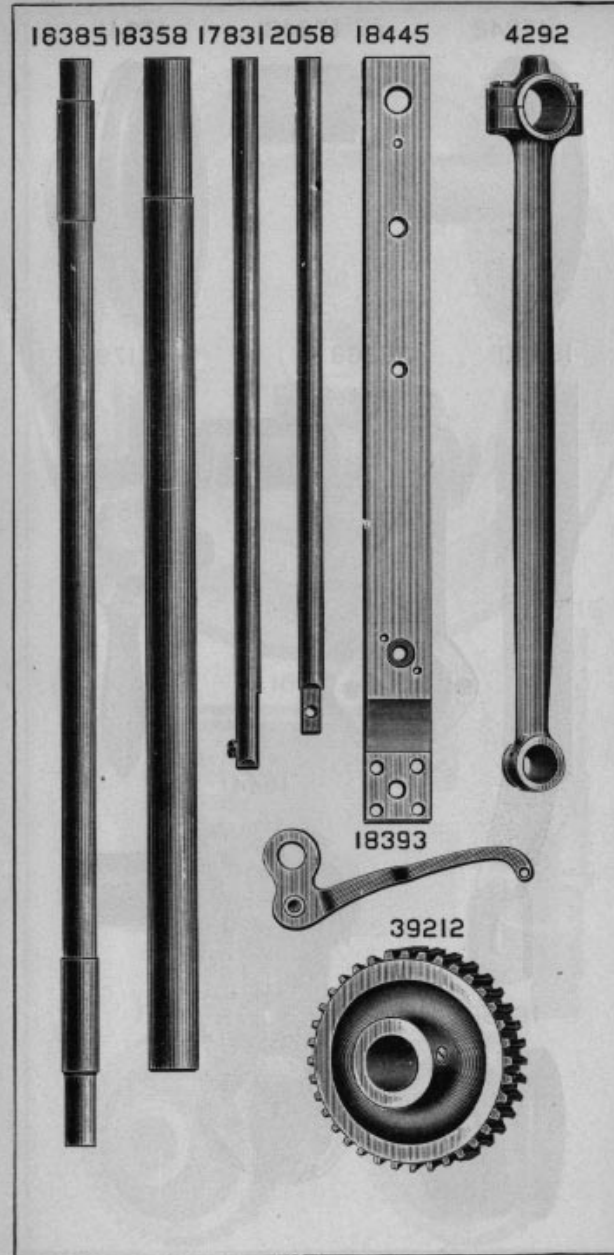

PLATE 5003—ONE-HALF SIZE

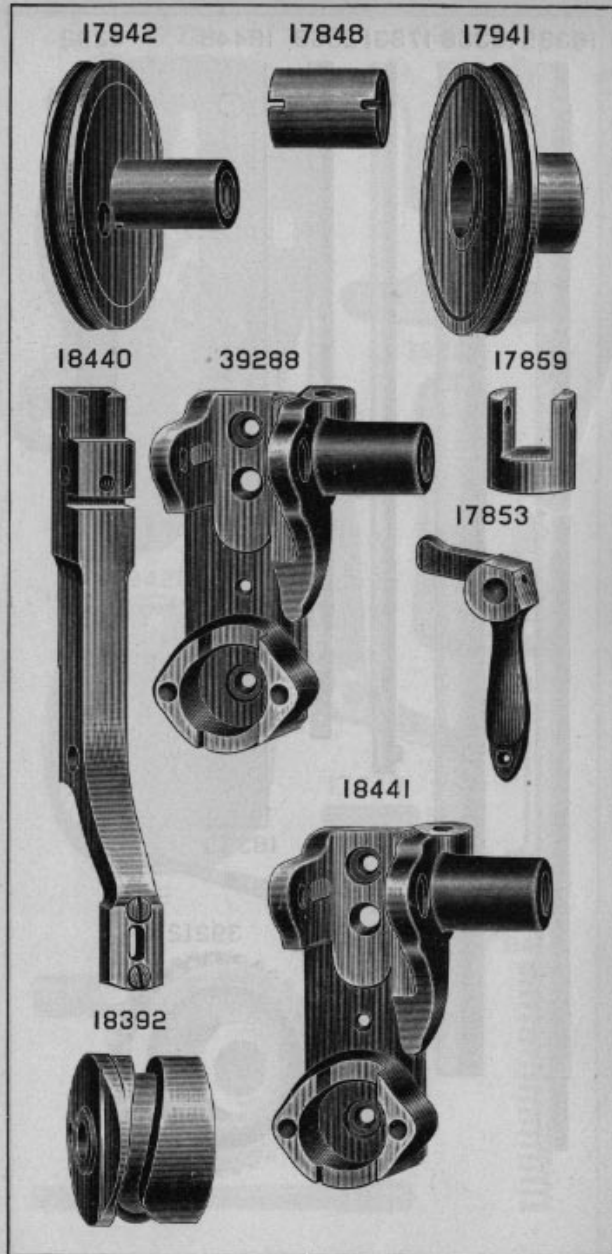

PLATE 5004—ONE-HALF SIZE

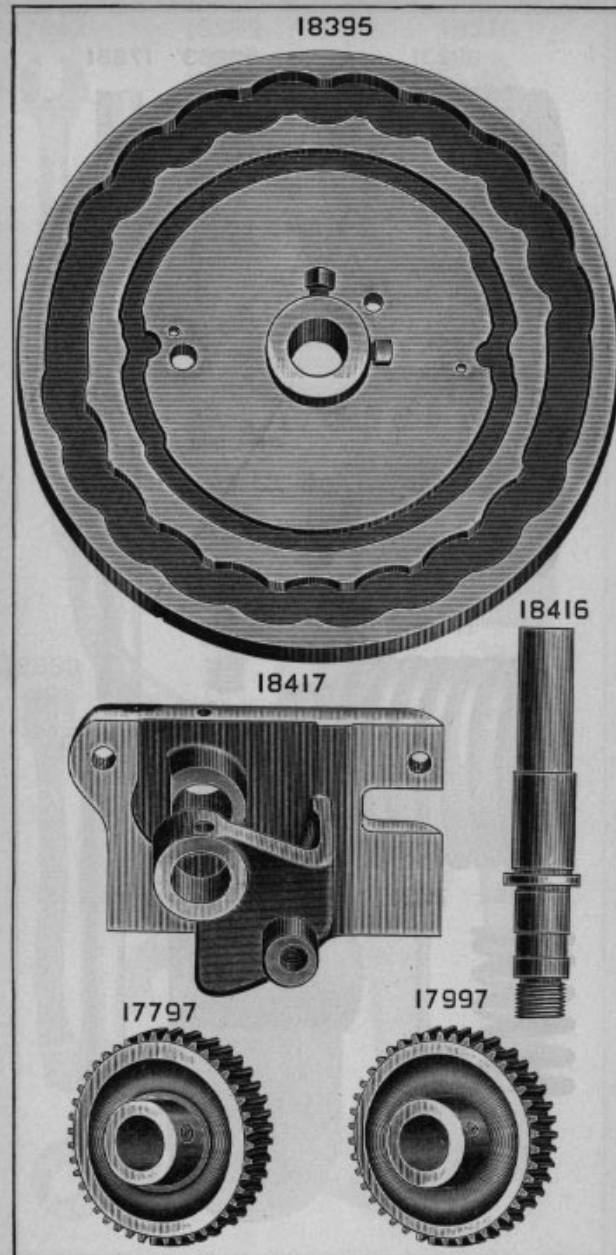

PLATE 5005—FULL SIZE

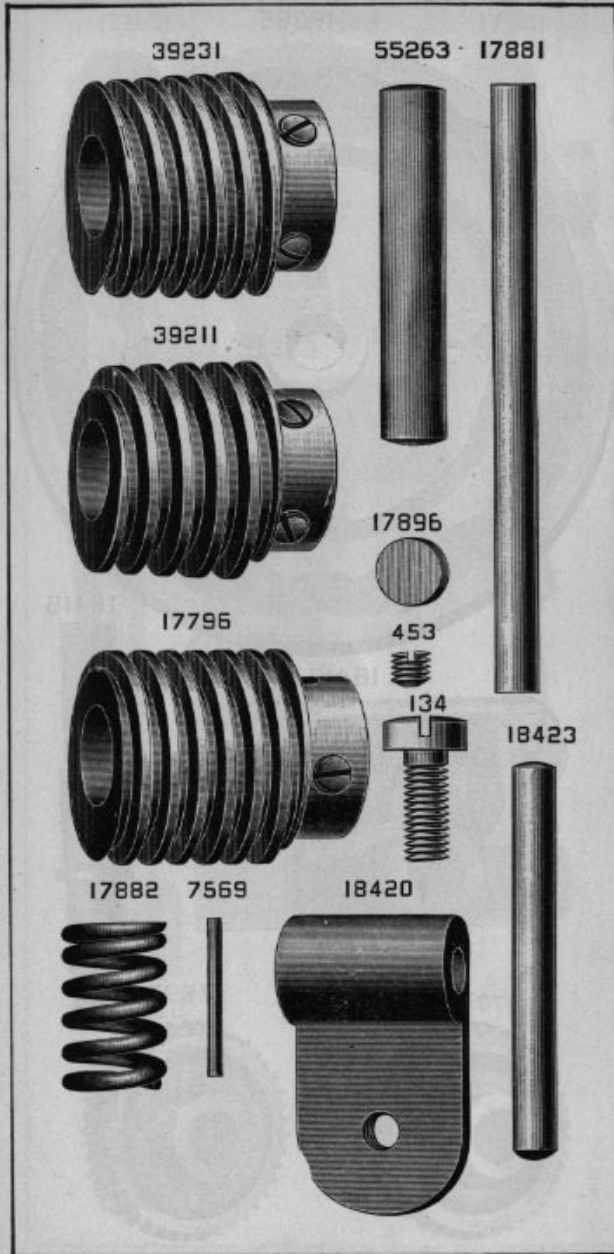

PLATE 5006—ONE-HALF SIZE

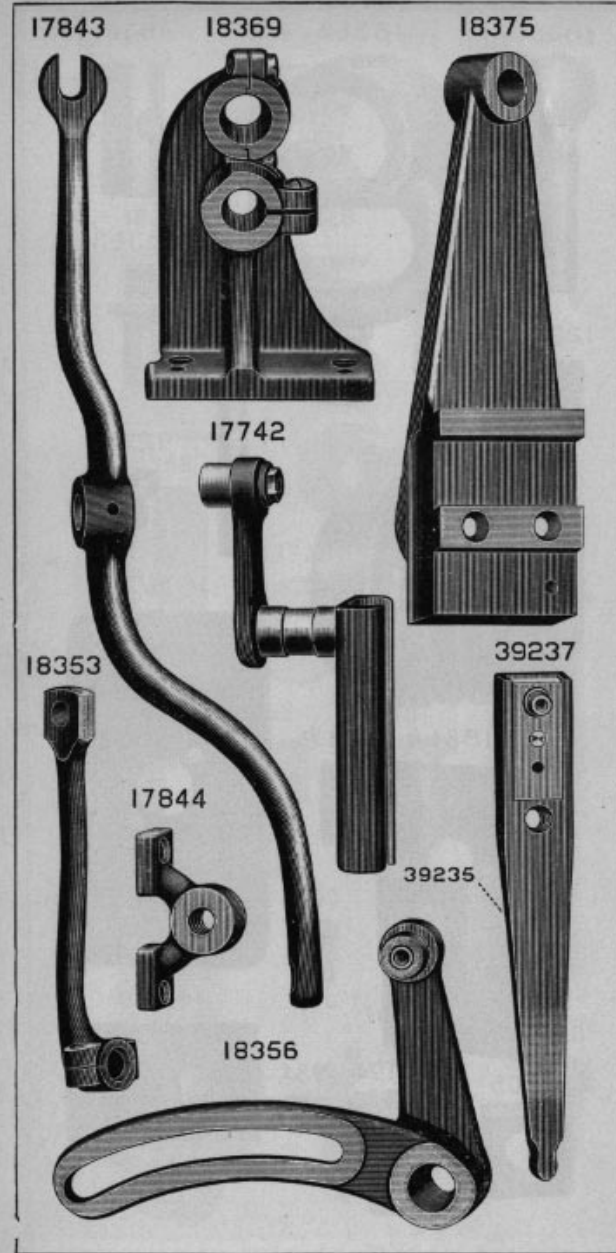

PLATE 5007—FULL SIZE

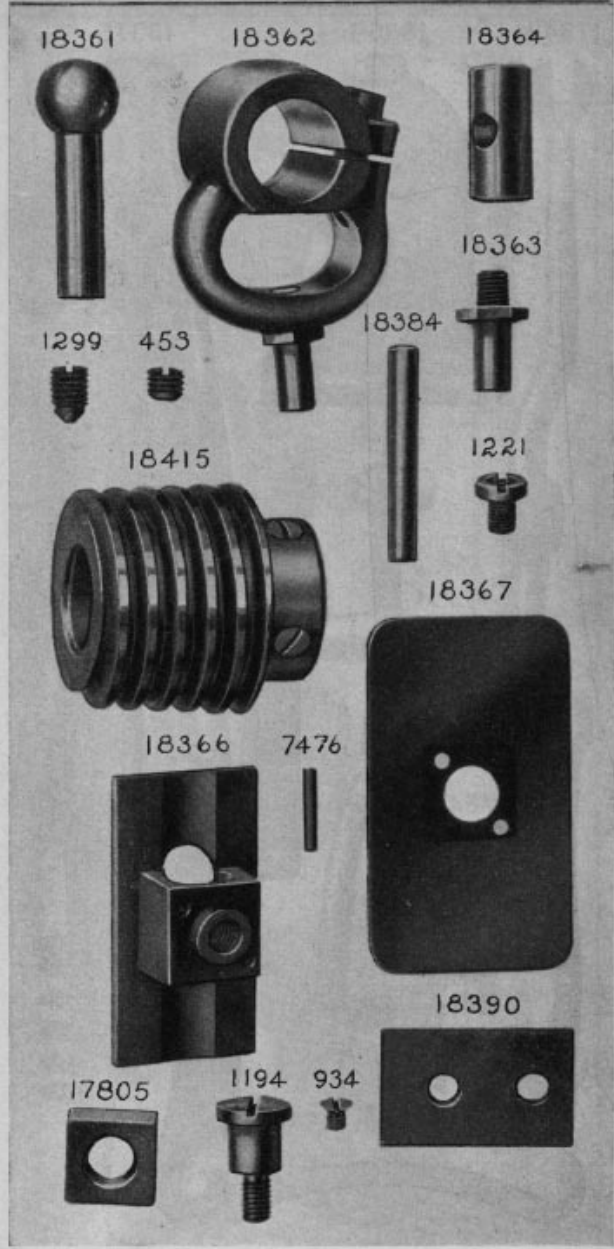

PLATE 5008—FULL SIZE

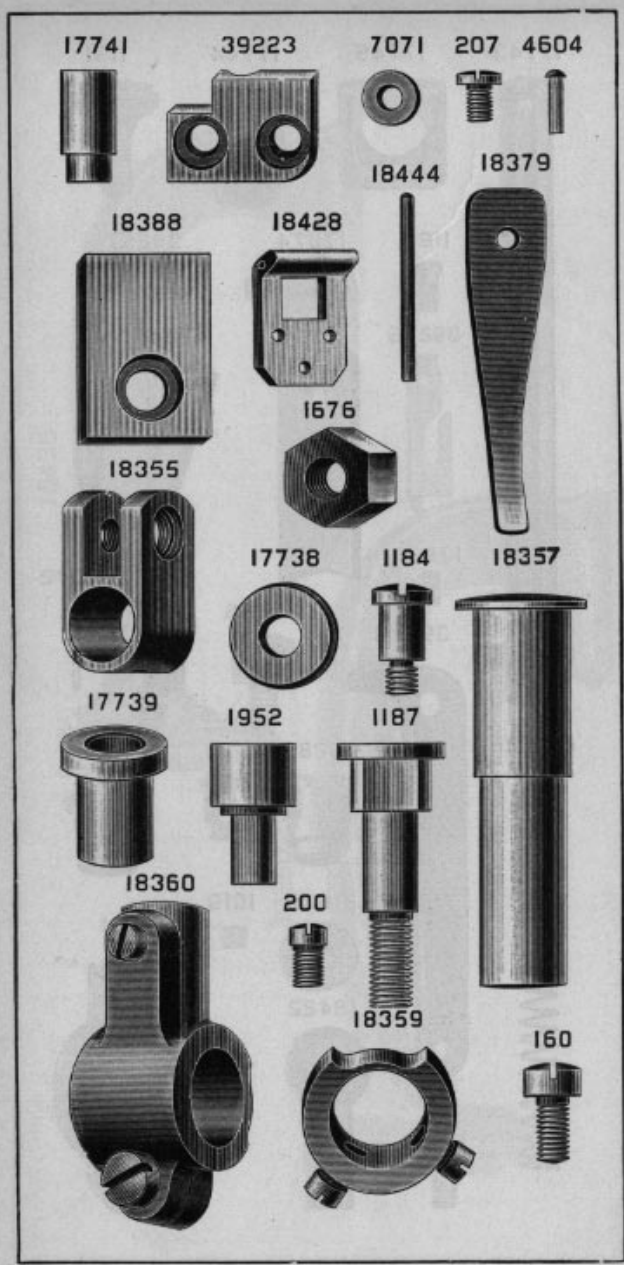
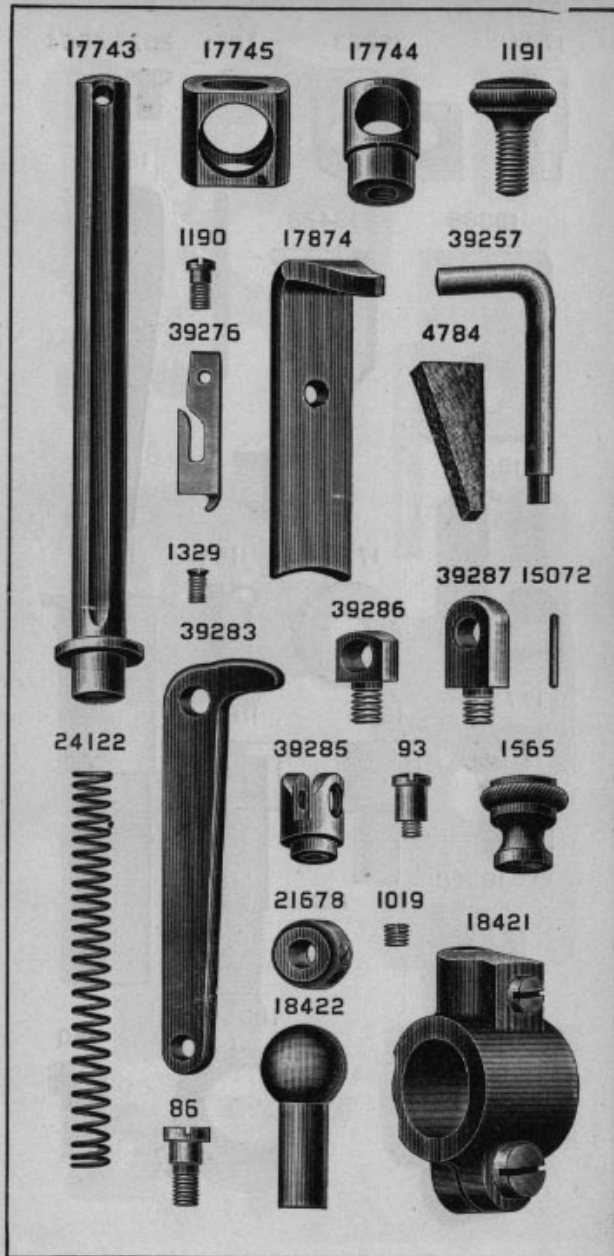

PLATE 5009—FULL SIZE



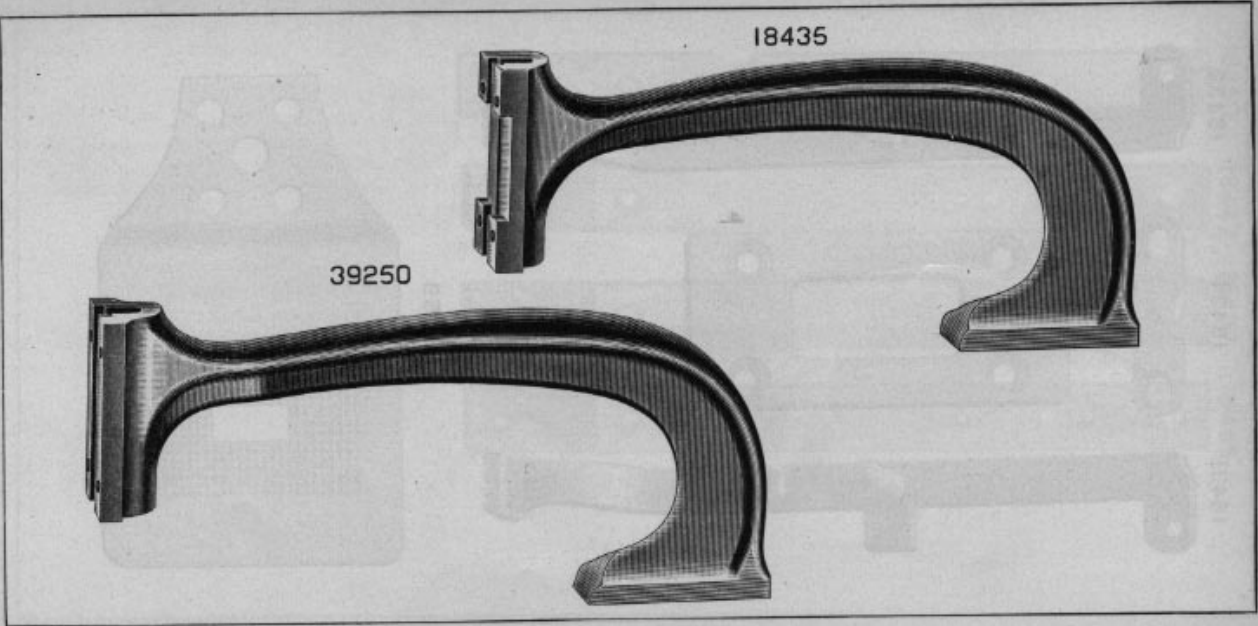

PLATE 5010—ONE-HALF SIZE

PLATE 5011—FULL SIZE

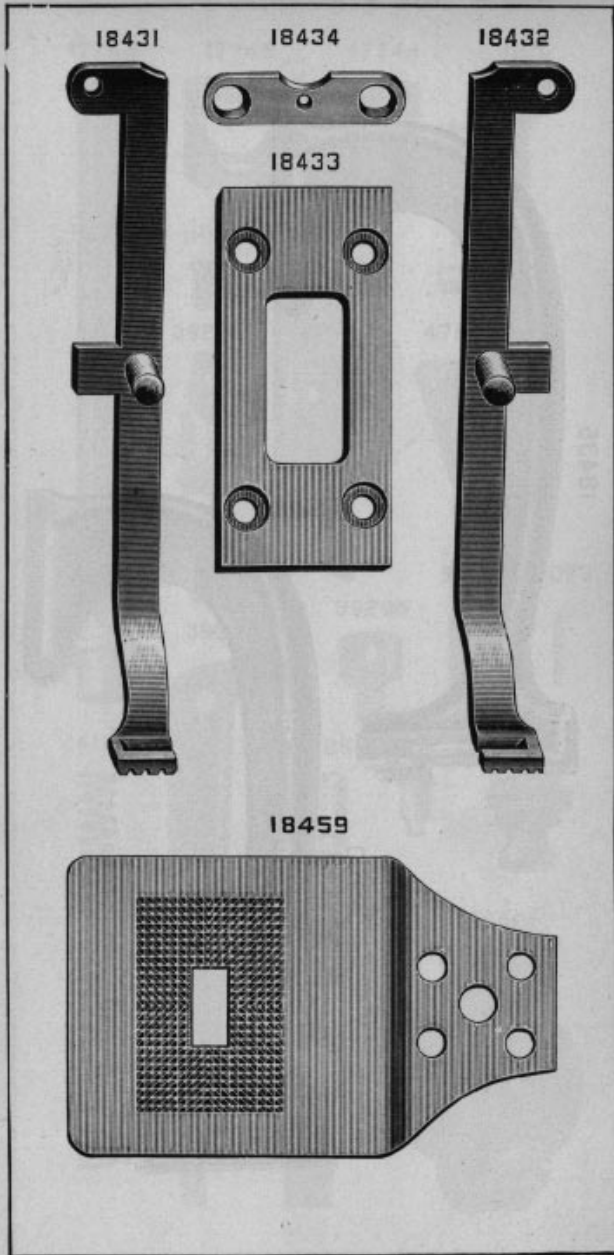

PLATE 5012—ONE-HALF SIZE

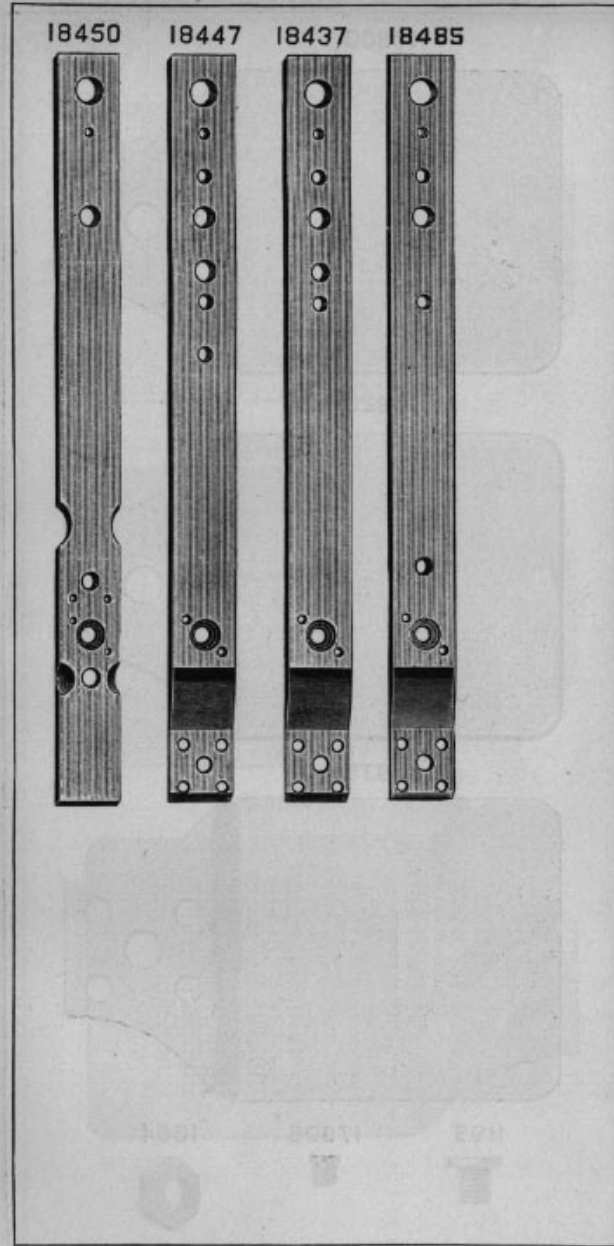
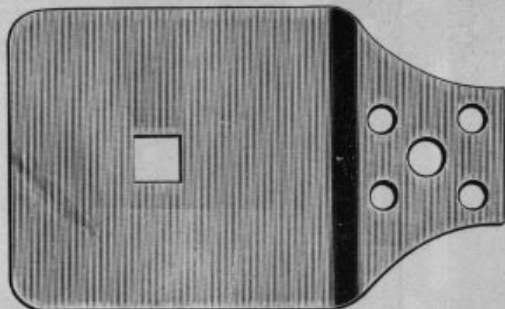
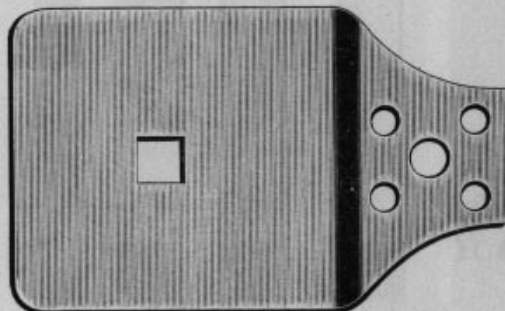

PLATE 5013—FULL SIZE

17800



17923



17975

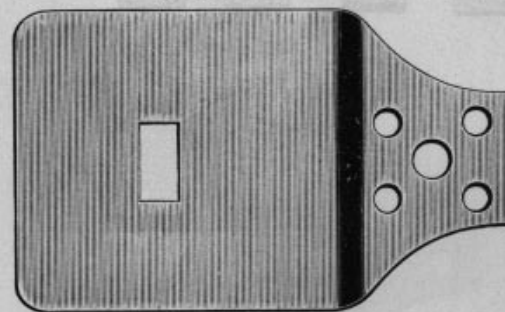
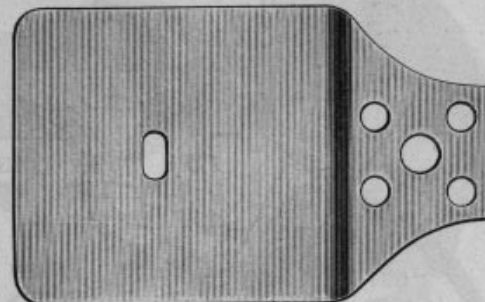
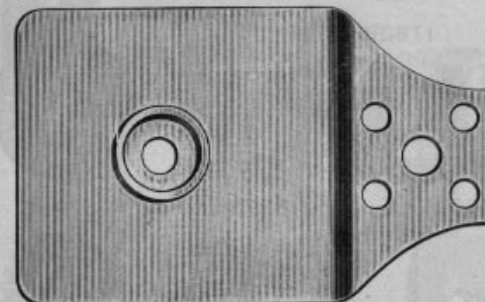

PLATE 5014—FULL SIZE

39258



17954



39304

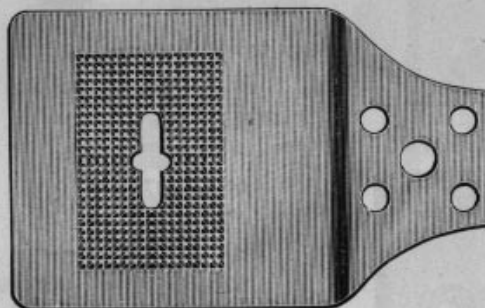

PLATE 5015—FULL SIZE

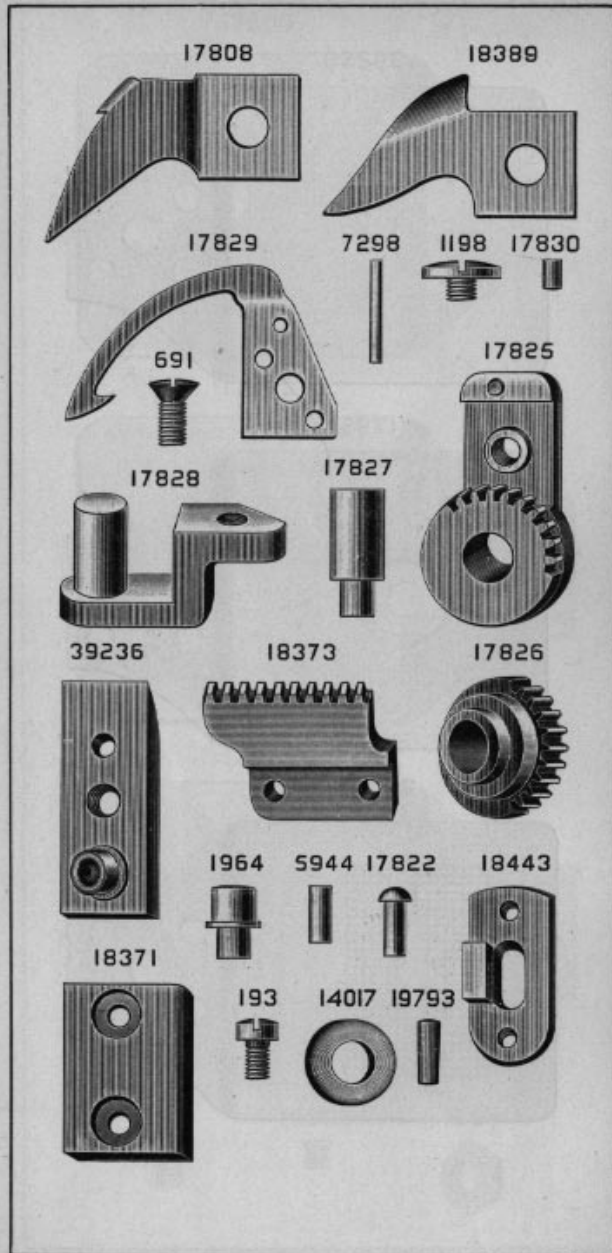

PLATE 5016—FULL SIZE

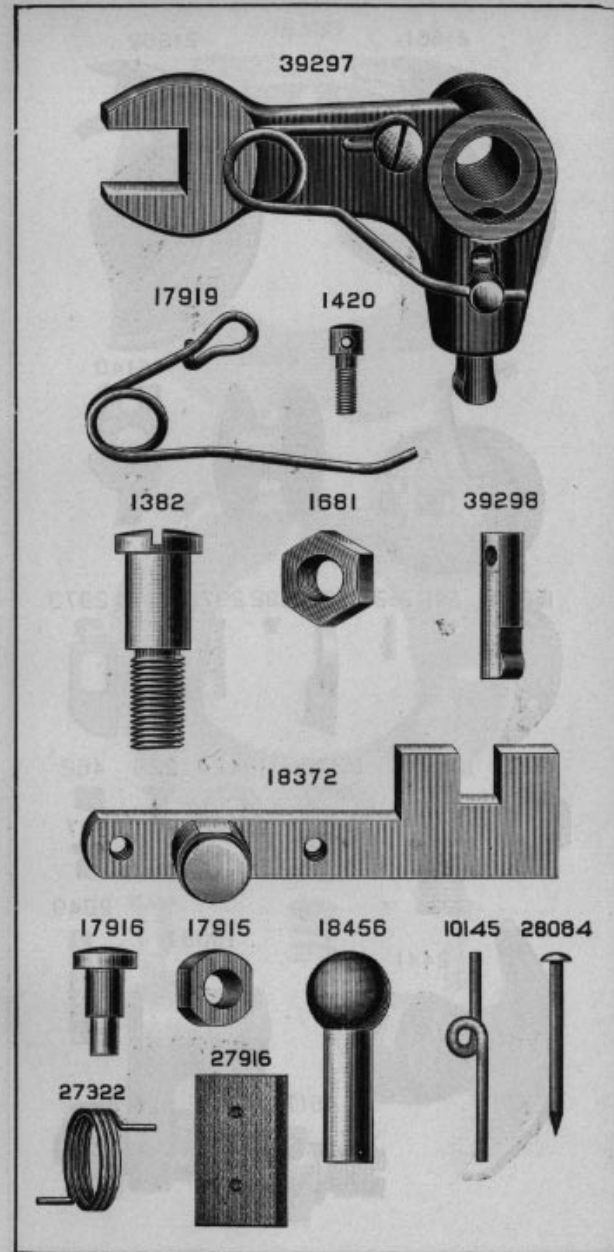

PLATE 5017—FULL SIZE

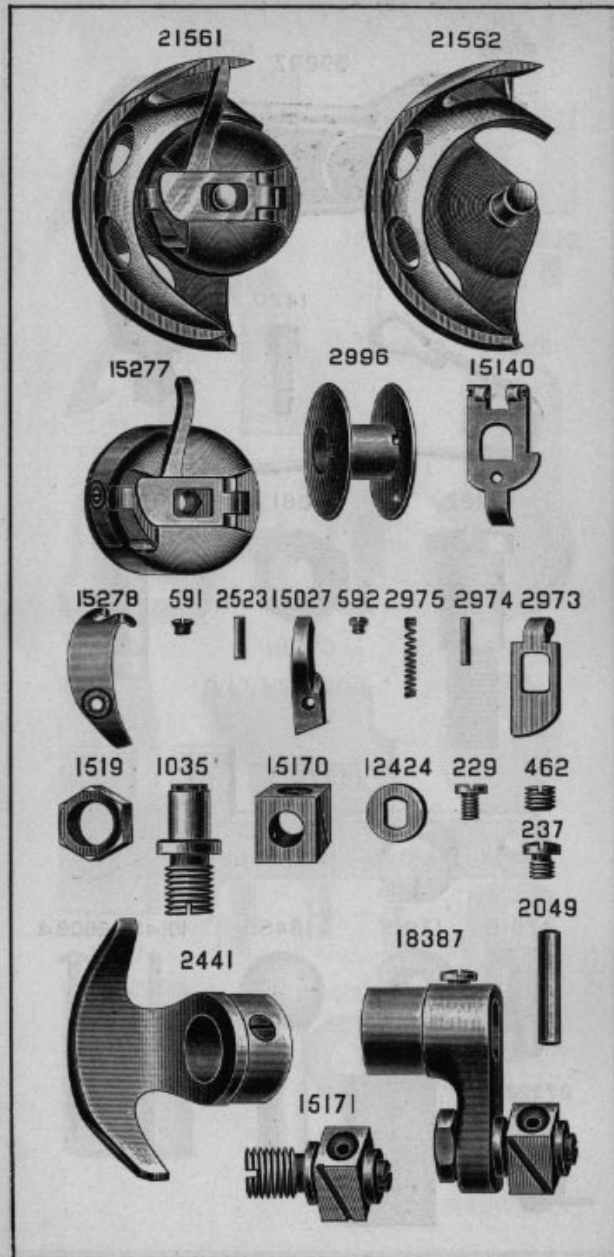

PLATE 5018—FULL SIZE

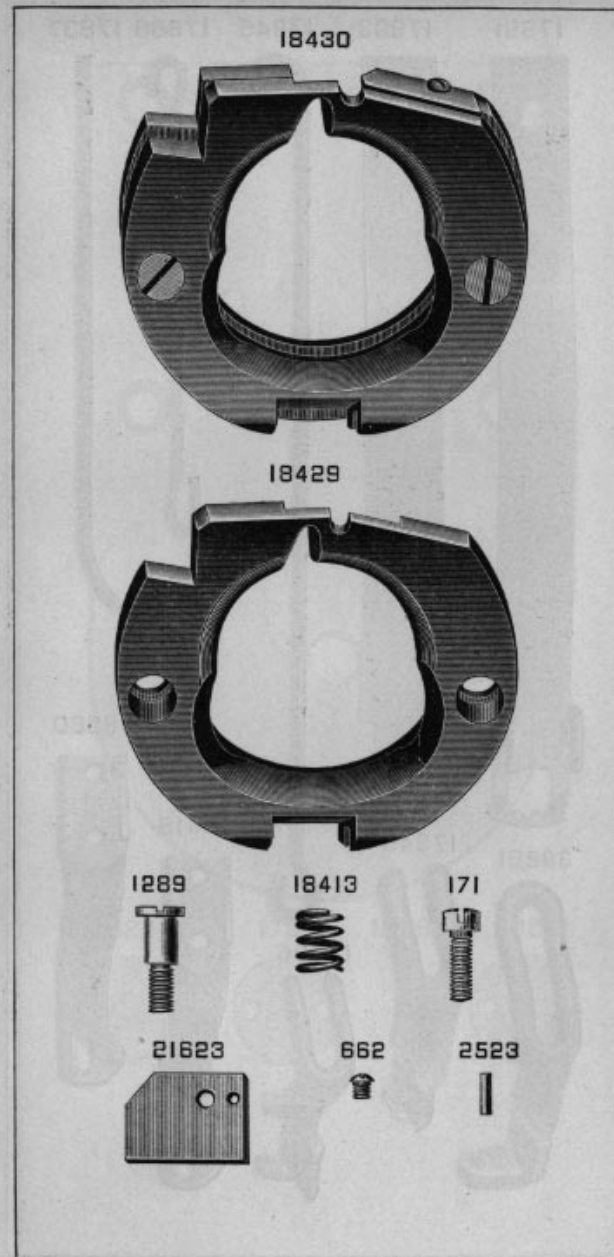

PLATE 5019—ONE-HALF SIZE

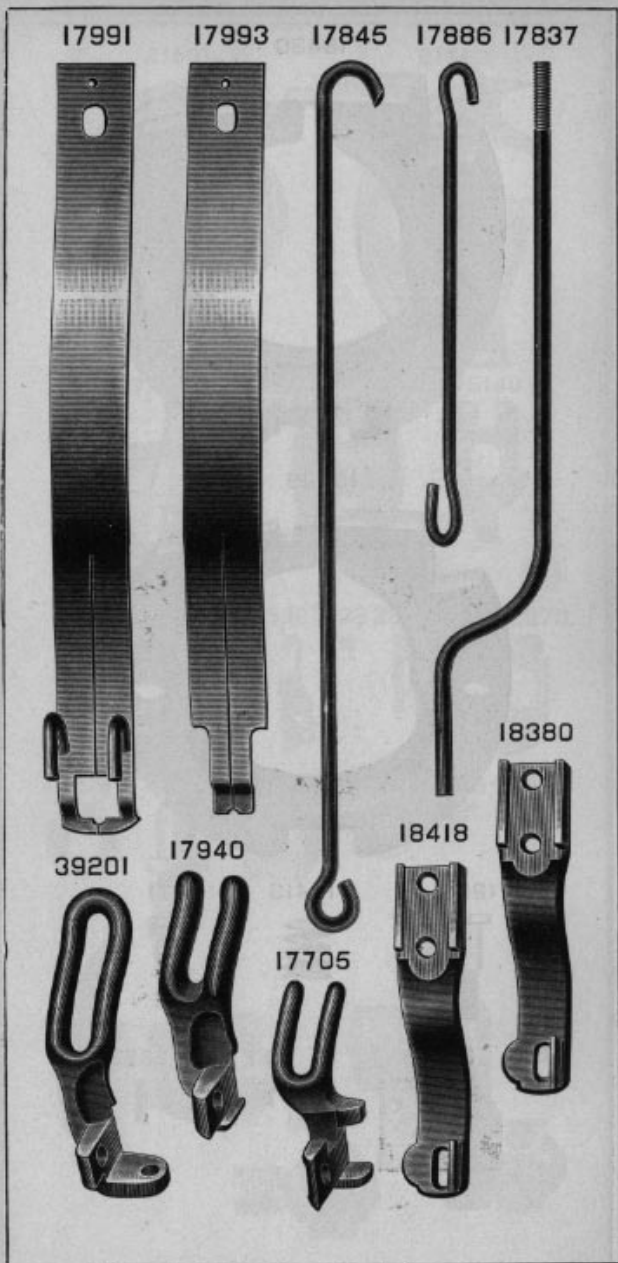

PLATE 5020—FULL SIZE

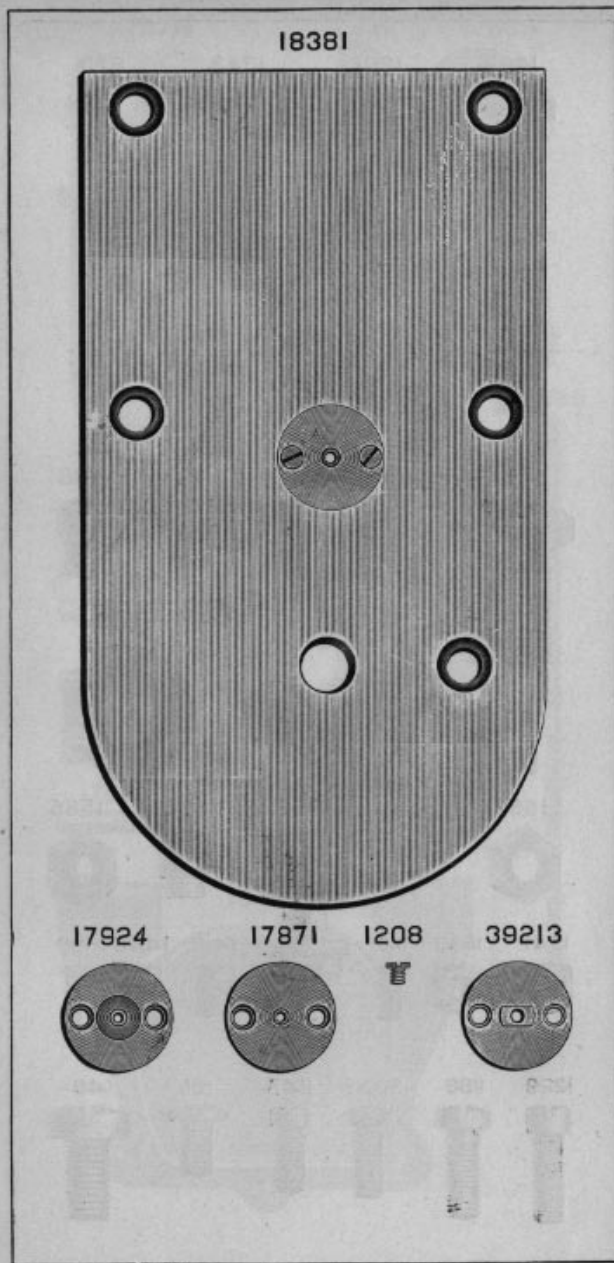

PLATE 5021—FULL SIZE

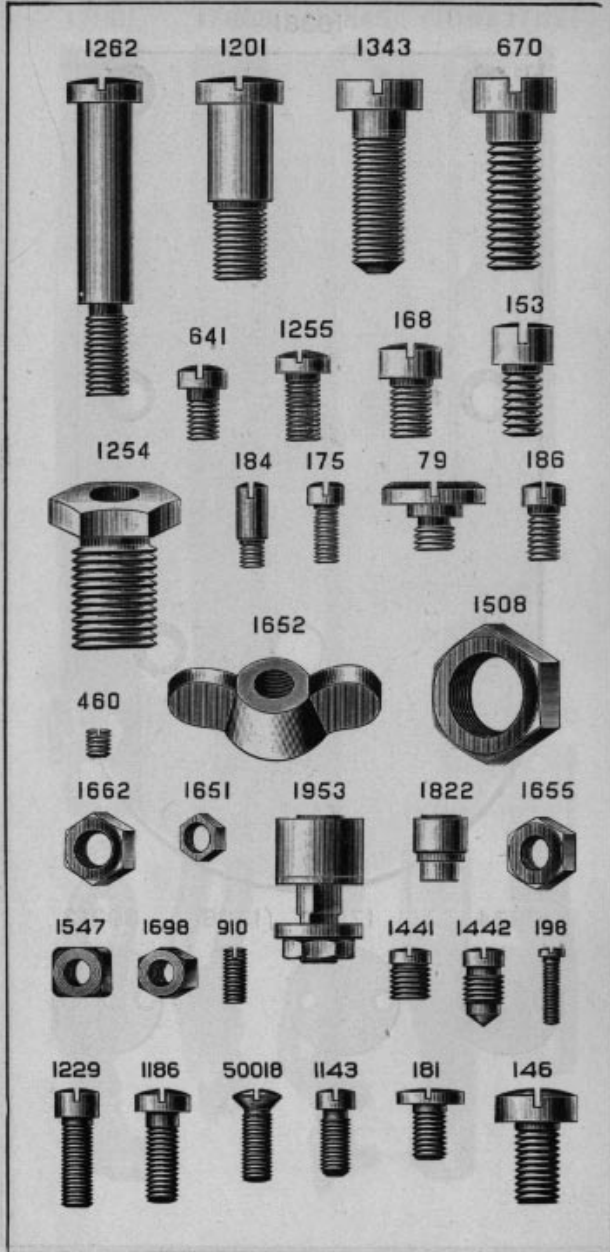

PLATE 5022—ONE-FOURTH SIZE

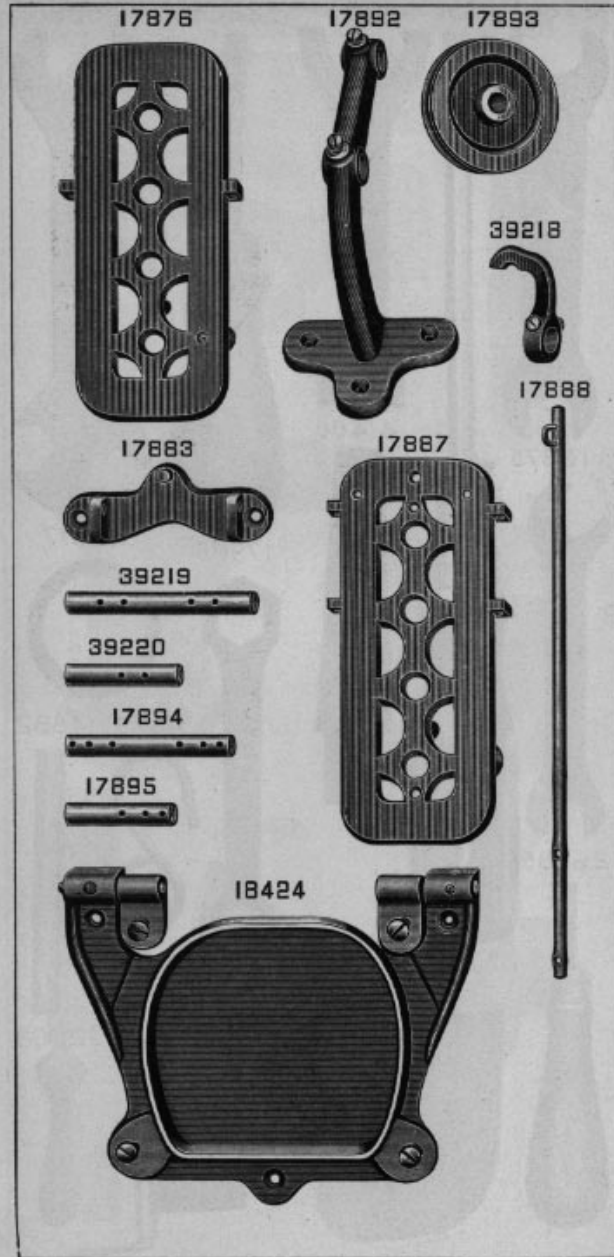

PLATE 5023—ONE-HALF SIZE

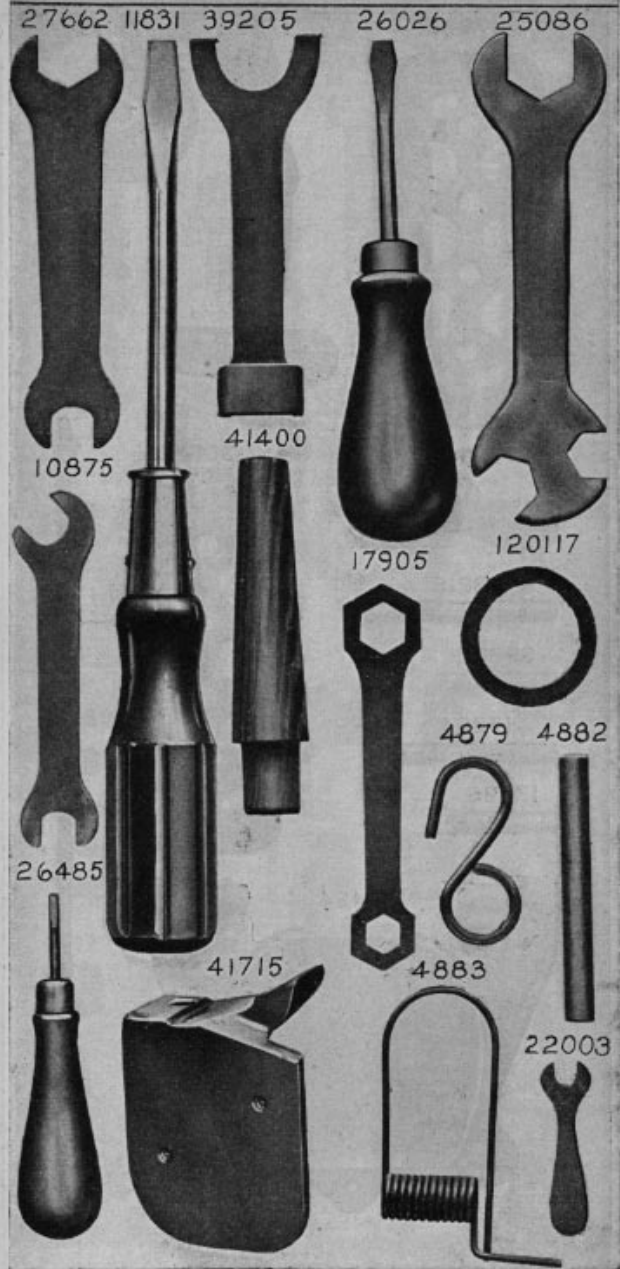

PLATE 5024—ONE-HALF SIZE

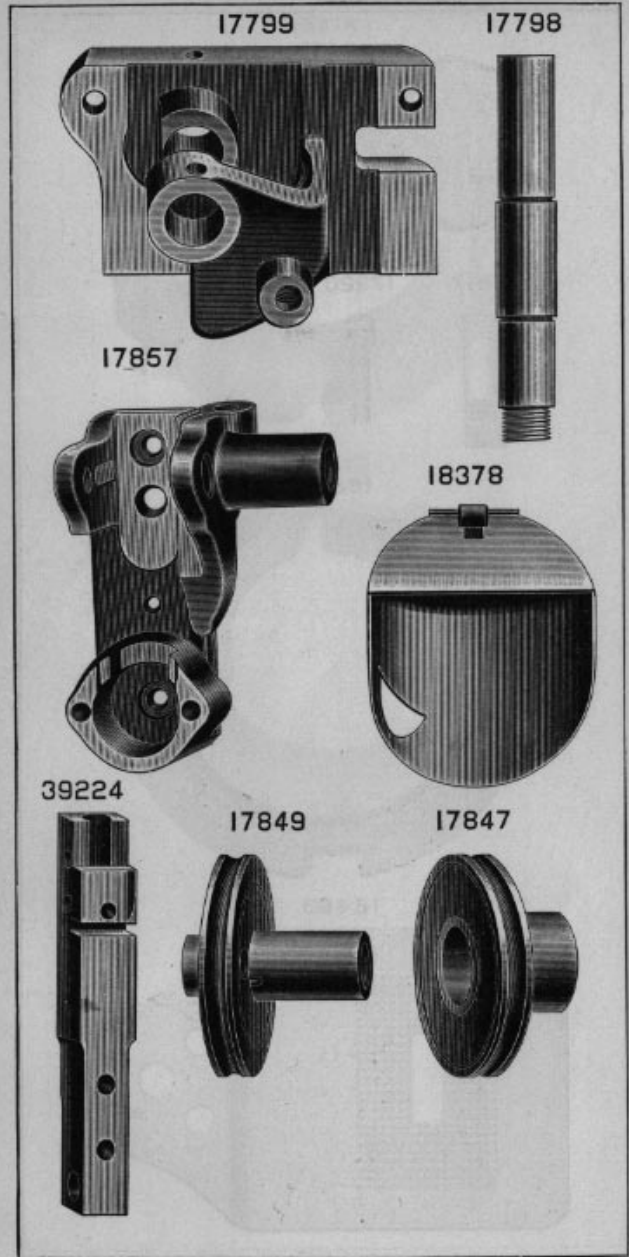

PLATE 5025—FULL SIZE

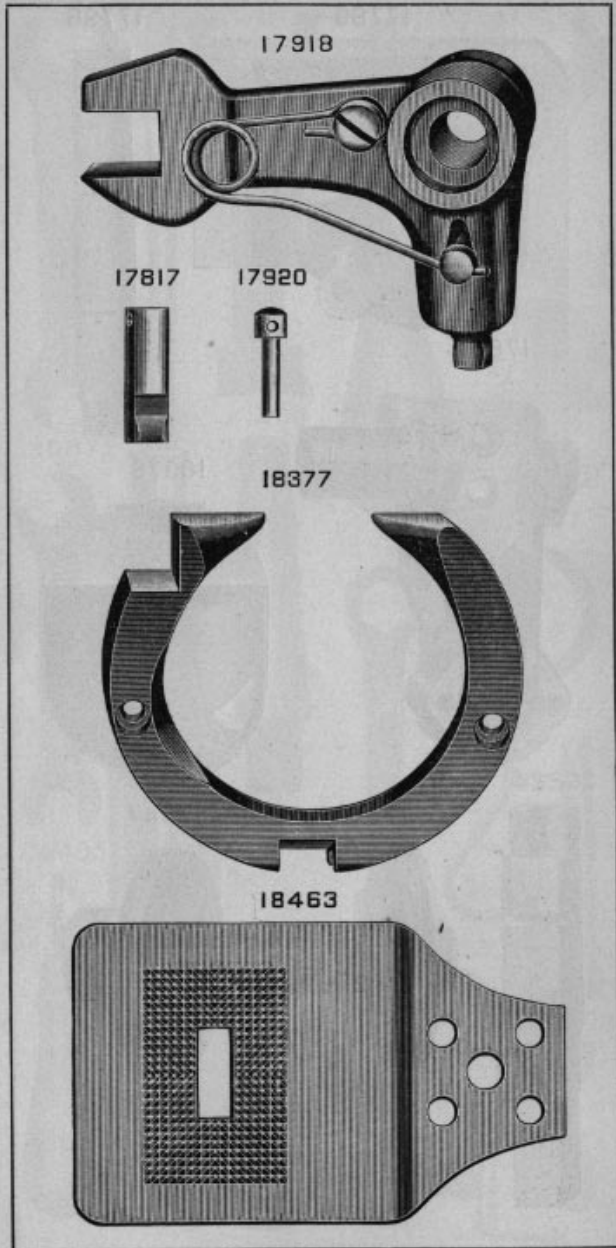

PLATE 5026—FULL SIZE

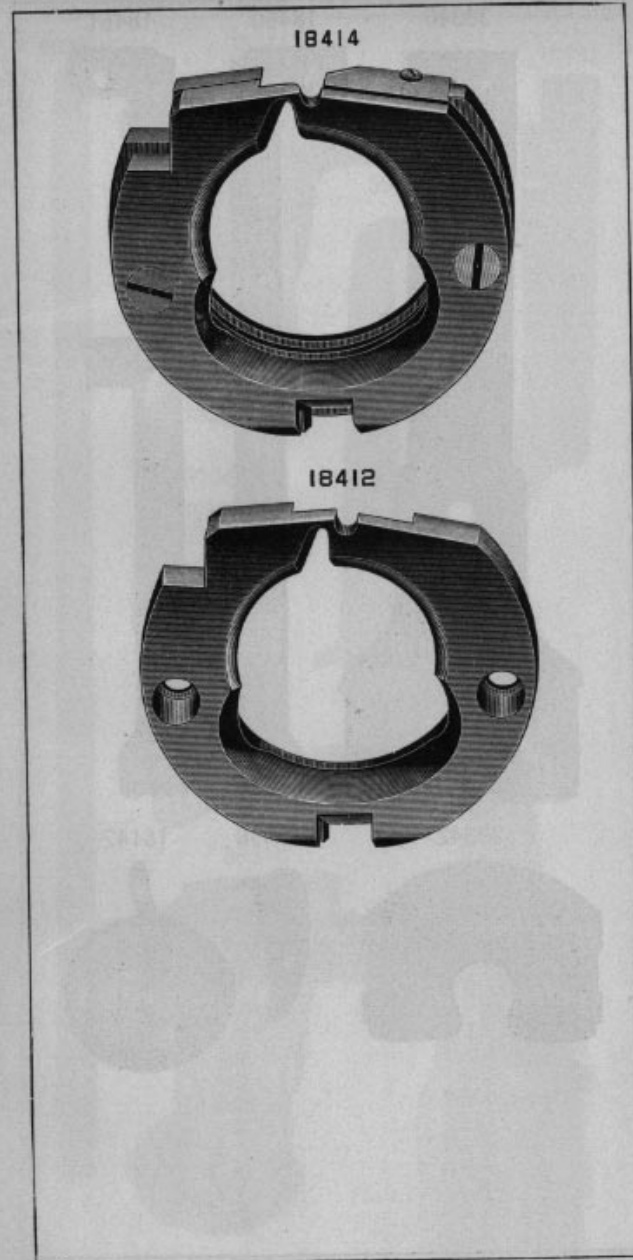

PLATE 5027—FULL SIZE

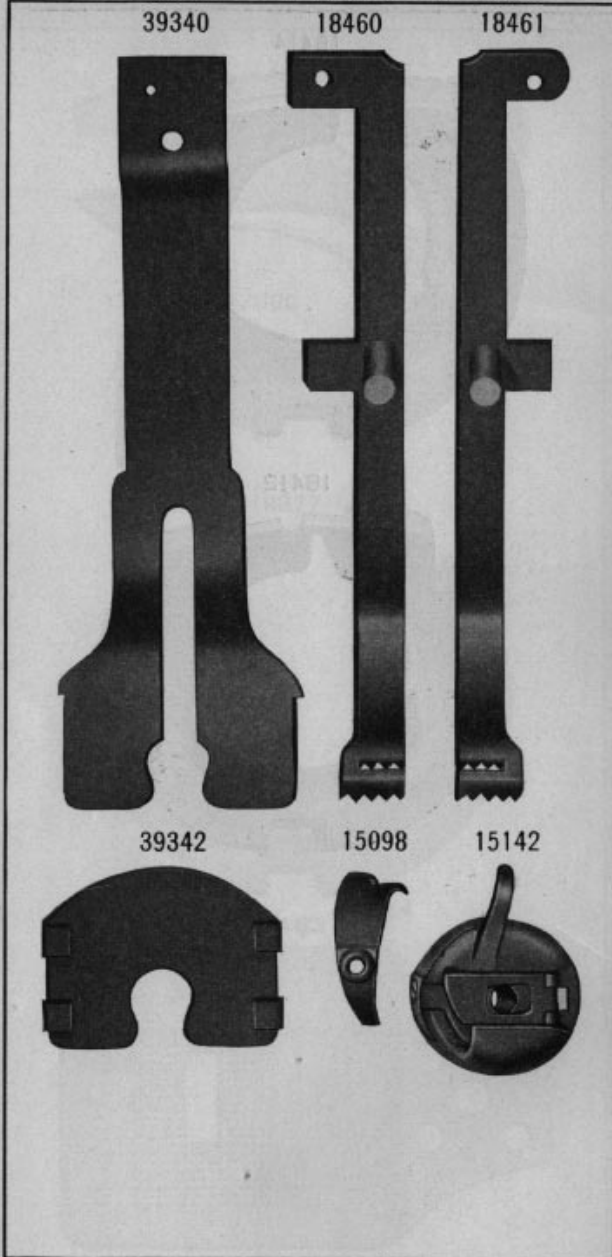

PLATE 5028—ONE-HALF SIZE

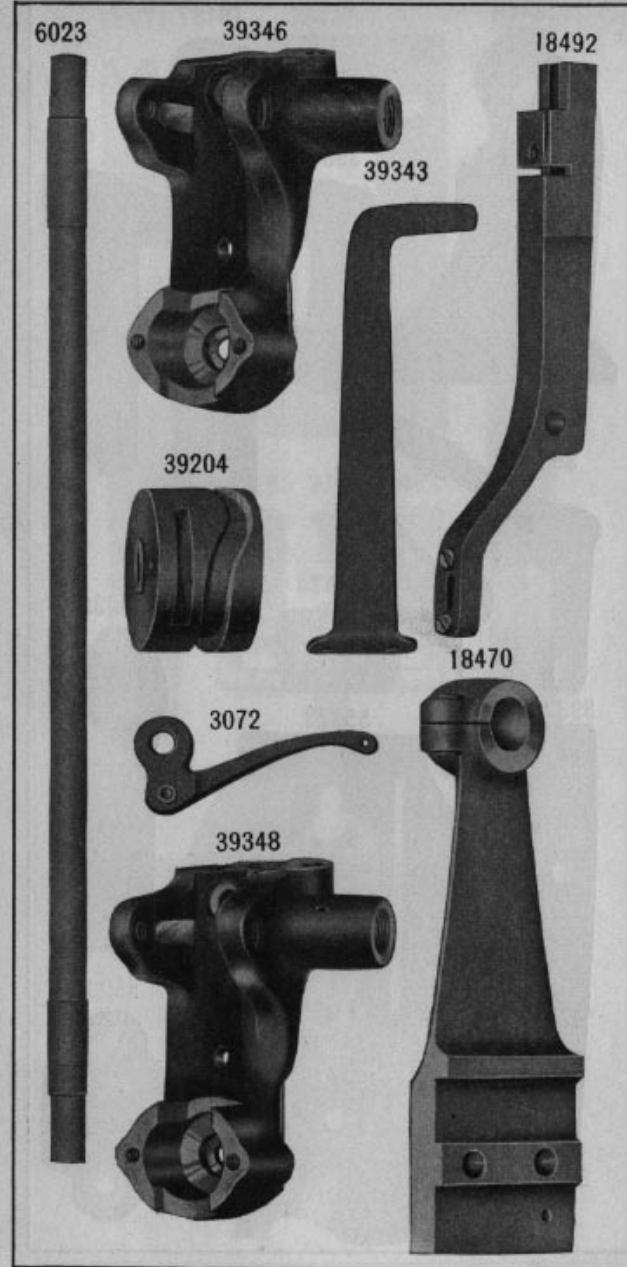

PLATE 5029—ONE-HALF SIZE



PLATE 5030—FULL SIZE

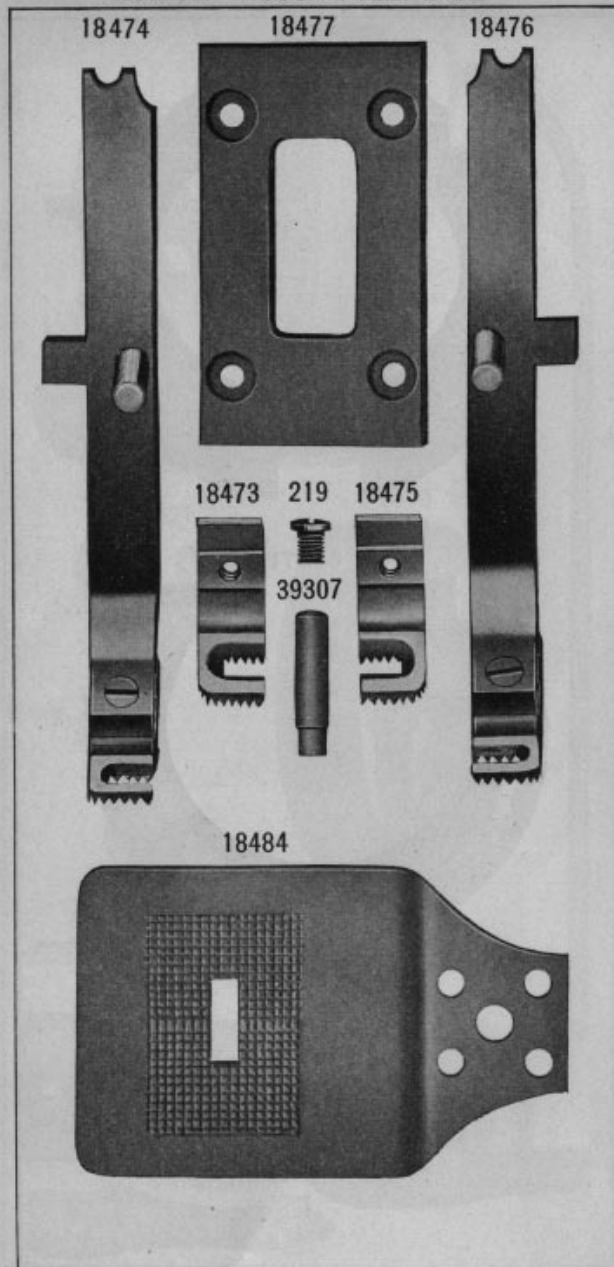

PLATE 5032—FULL SIZE

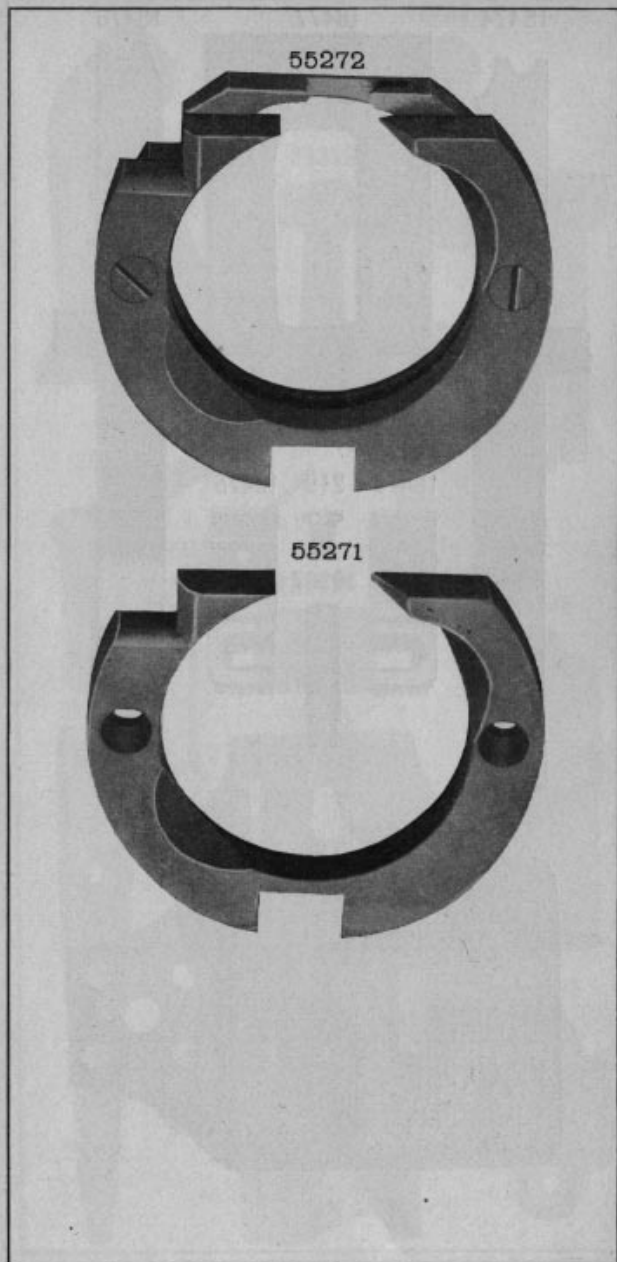

PLATE 5041—ONE-HALF SIZE

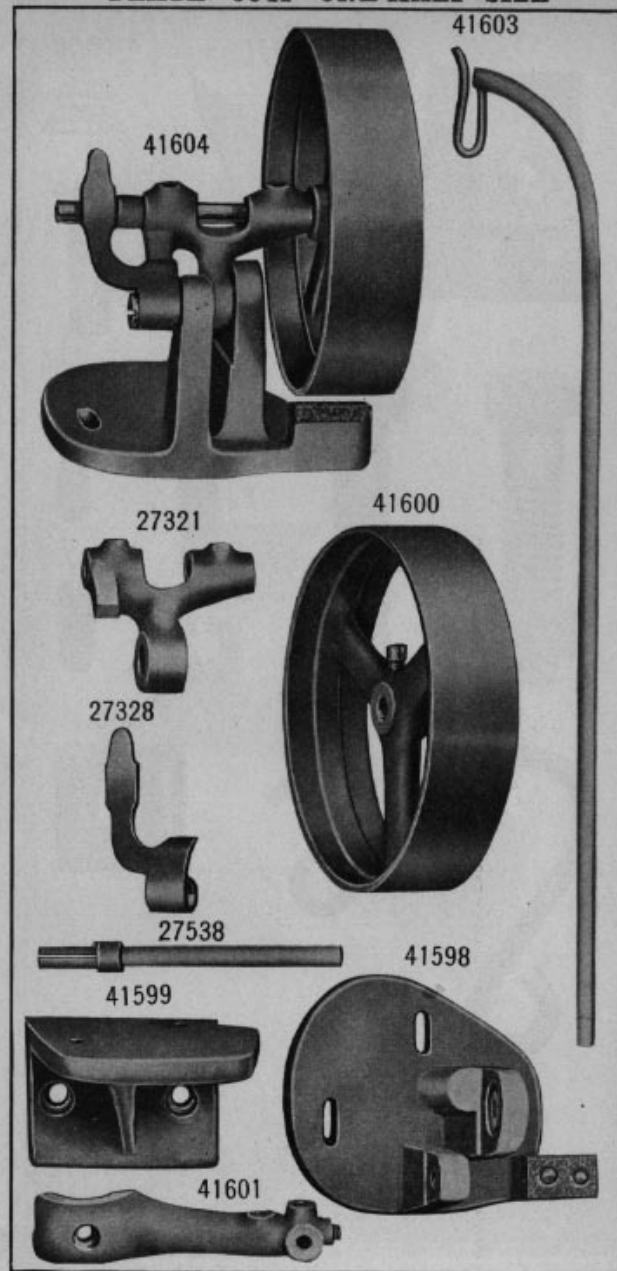

PLATE 5042—FULL SIZE

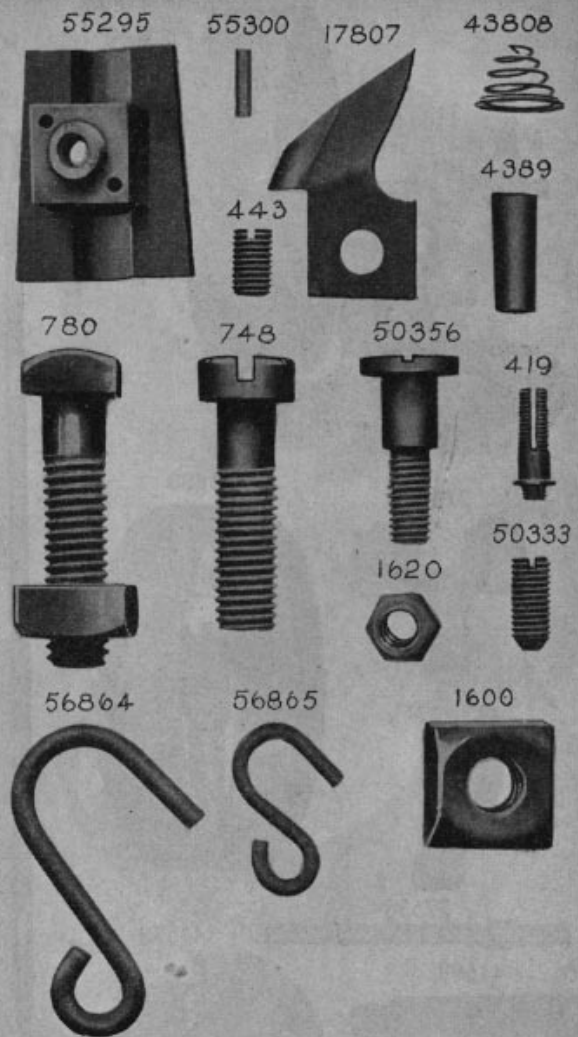

PLATE 5044—ONE-FOURTH SIZE

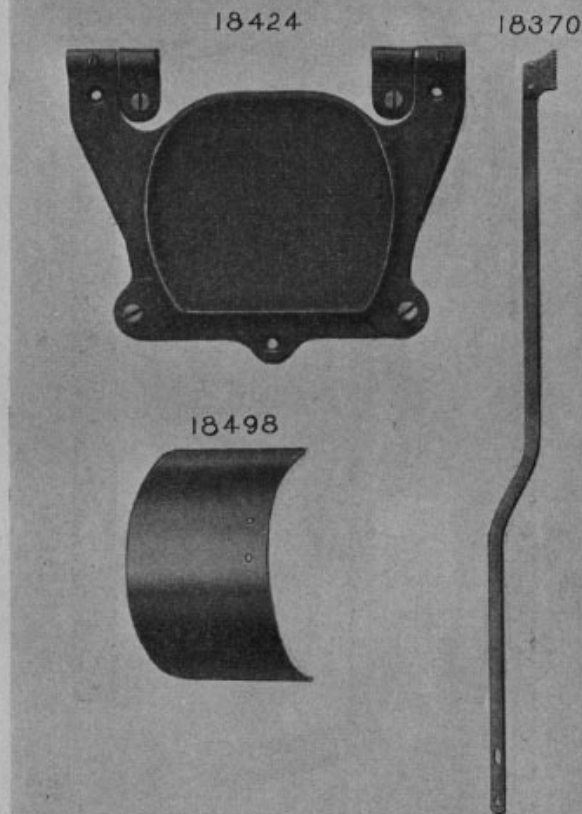

PLATE 7008—ONE-HALF SIZE

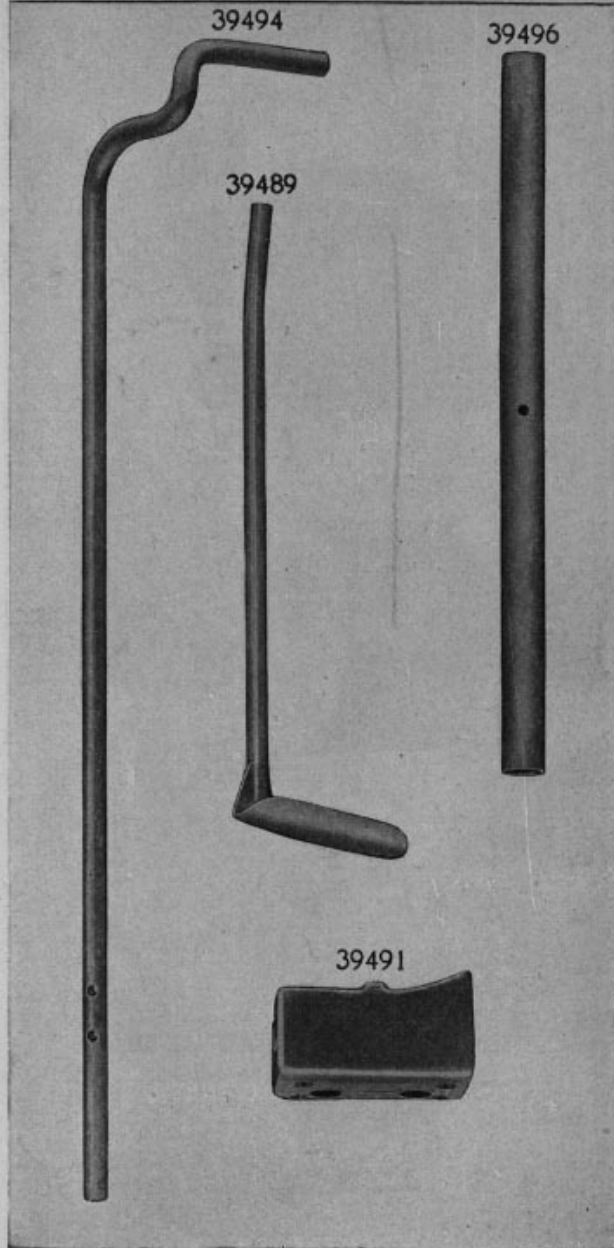

PLATE 7009—FULL SIZE

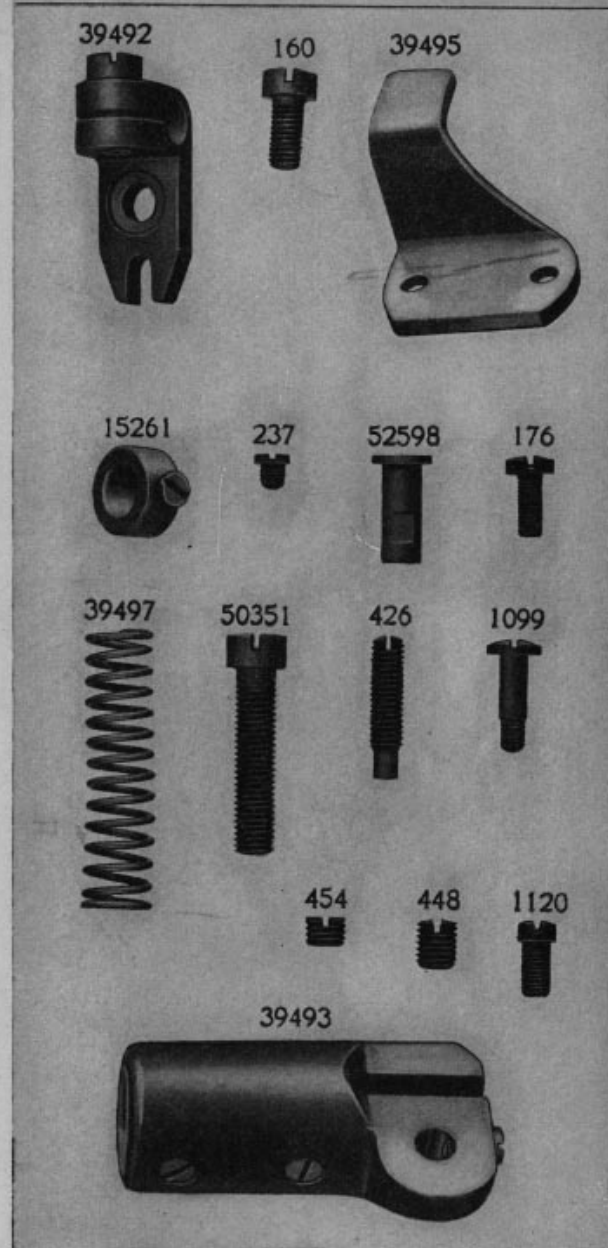
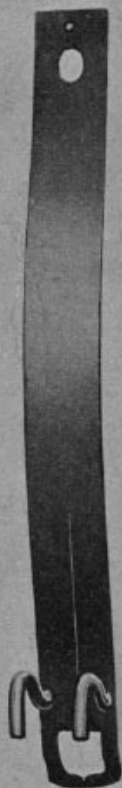

PLATE 7205—ONE-HALF SIZE

63811



63812



63927



63788

PLATE 7233—ONE-FOURTH SIZE

225396

225326

225391

225391

225324

225388

225395

202490

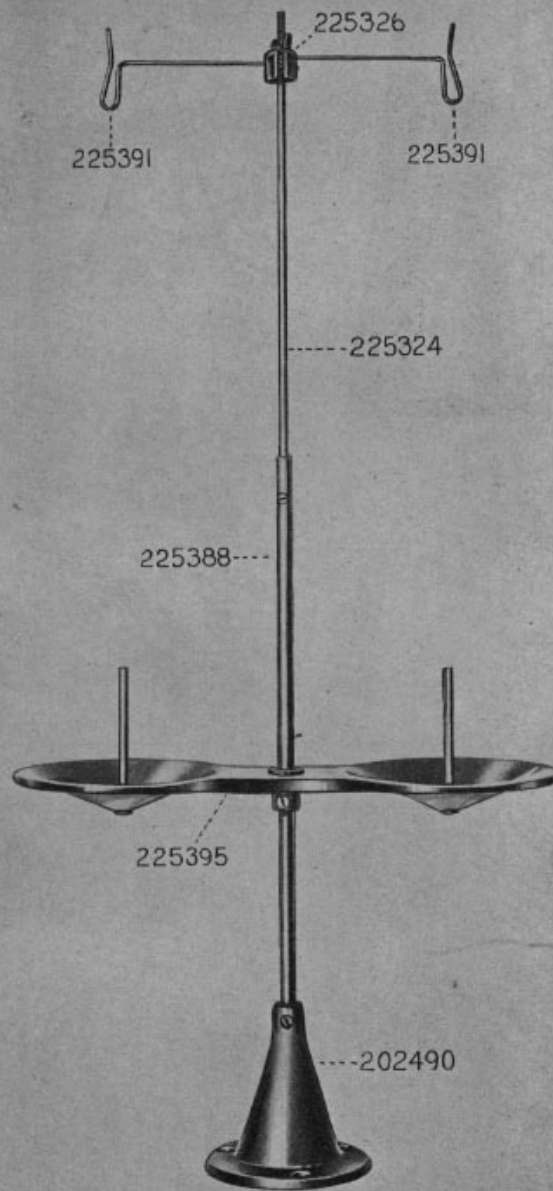

PLATE 7234—ONE-HALF SIZE

27739



225390

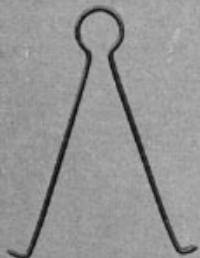

PLATE 7242—ONE-HALF SIZE

7124



27683



46676



2770



46677

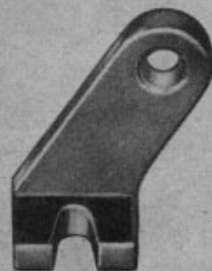

16128



PLATE 8582—FULL SIZE

55396

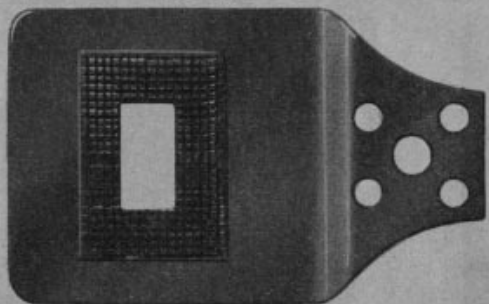

55390 55392 63726 27849 32675



55319

55320

41828



55321

55397



63976



9281

27850



PLATE 8583—ONE-HALF SIZE

63734

55387

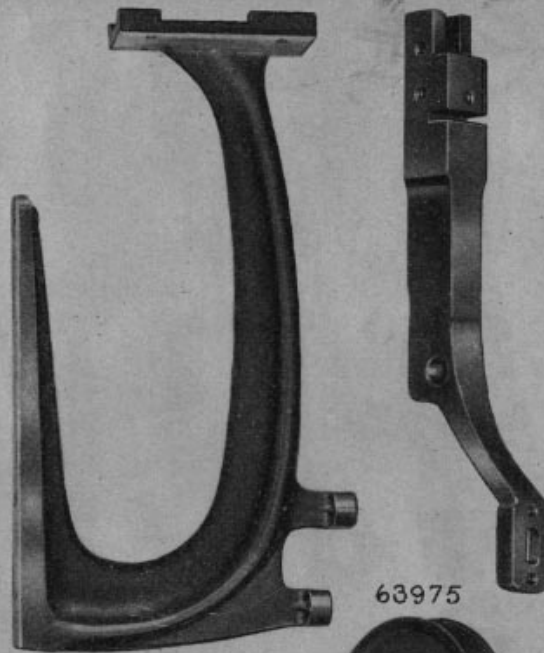

63975

39361

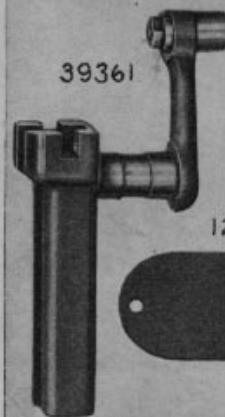

124674

126391

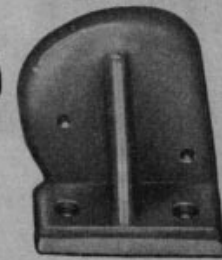
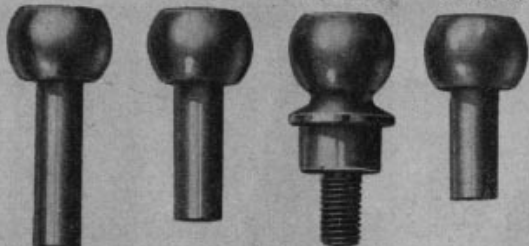

PLATE 8584—FULL SIZE

55381 55383 50598 55382



62739 1057 50682 145



201696 1819 201018 200383



76 226 208 50117 42639



1524

225393

PLATE 8585—ONE-HALF SIZE

55395

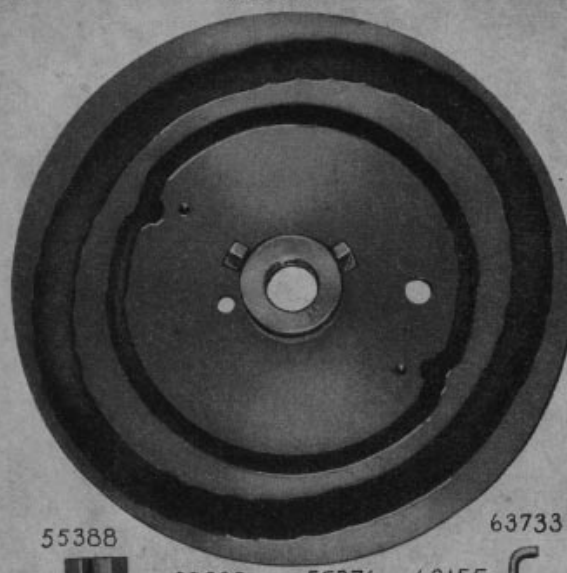

55388

63733

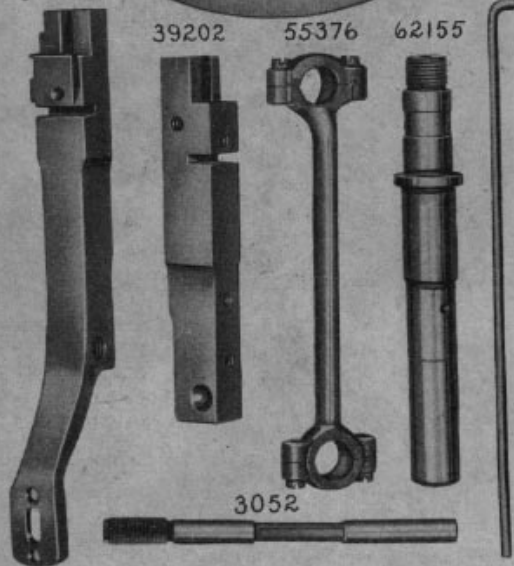

39202

55376

62155

3052

PLATE 8586—FULL SIZE

55324

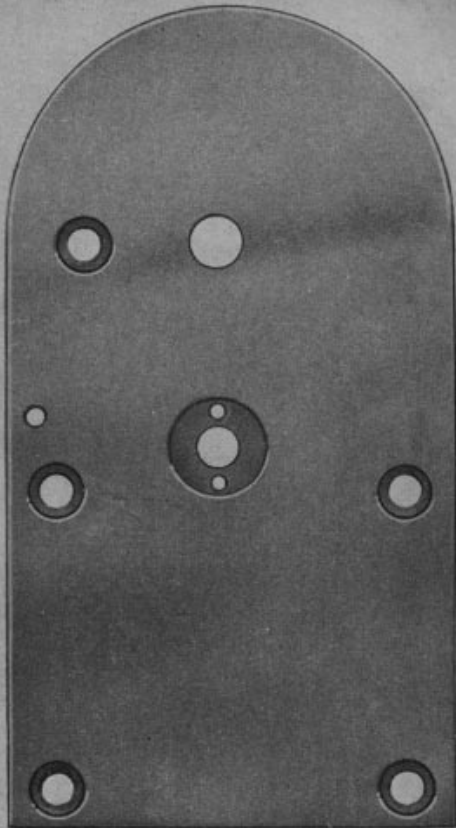

55325



55326



55331



55334



PLATE 8587—FULL SIZE

55402

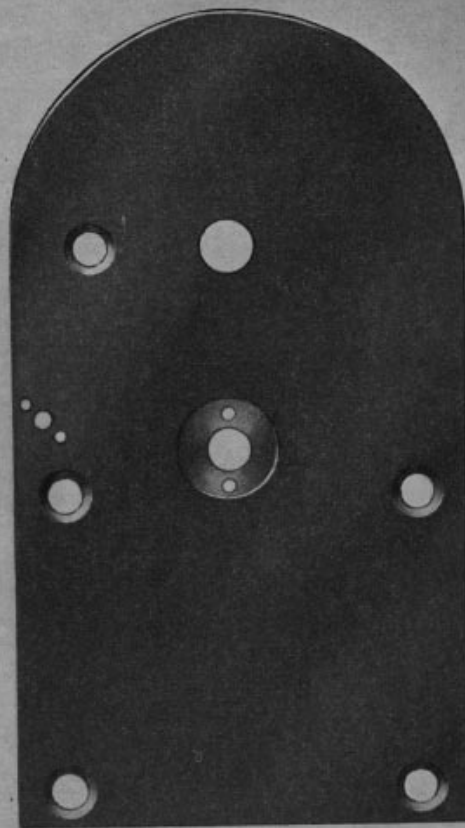
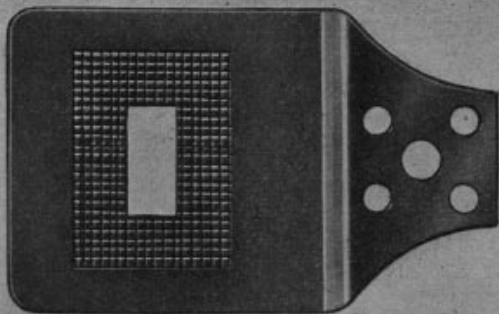

PLATE 8588—FULL SIZE

55417



55410



55412



56865



9525



51251



356



124950

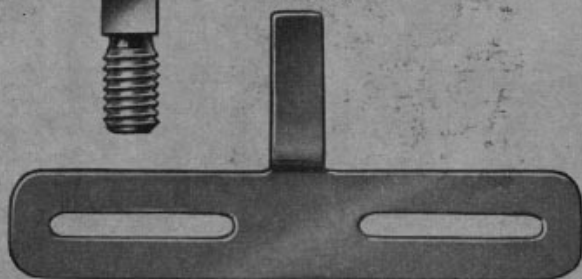
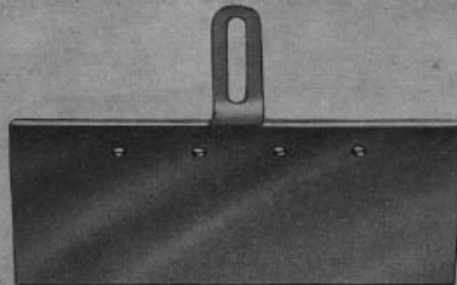
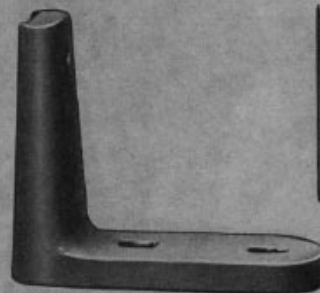

PLATE 8589—ONE-HALF SIZE

124951



124706



46713

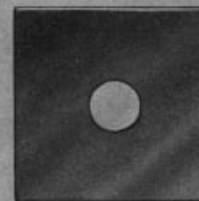

21327



46707



126530



126532

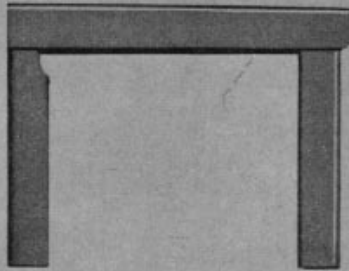

126508

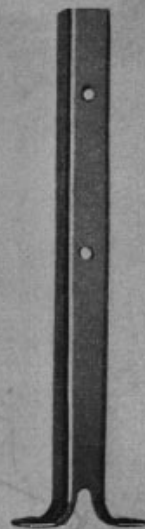

46711

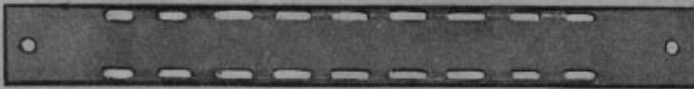

PLATE 9090-ONE-EIGHTH SIZE

PLATE 20332—FULL SIZE

