

ACCESSORIES

CAT. 3651-05

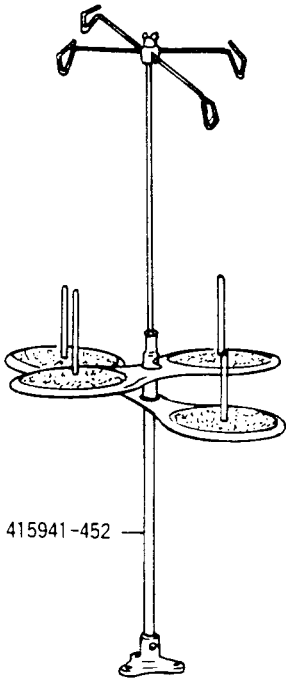

415941-452

415966

415967

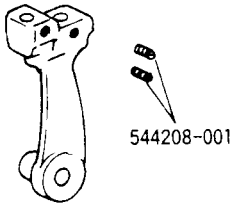

544208-001

792D 100A-NEEDLE GAUGE 3/16" (4.8mm)

415971-012

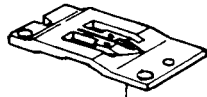

156723-012



156722



518204

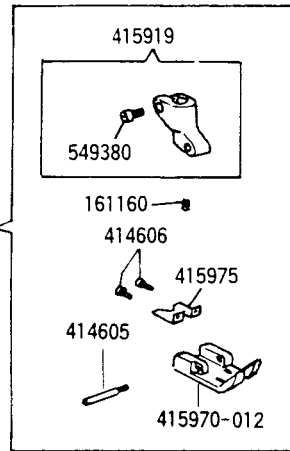

415919

549380

161160

414606

415975

414605

415970-012

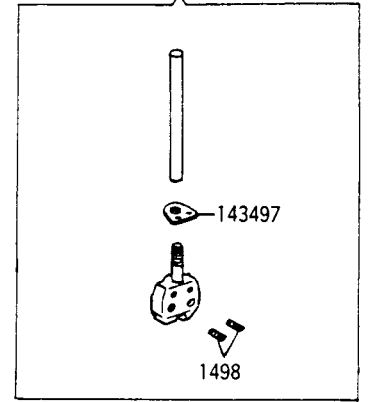

143497



1498

792D 100A-NEEDLE GAUGE 1/4" (6.4mm)

415971-016

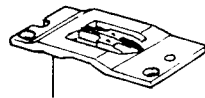

156964

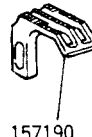

157190



518203

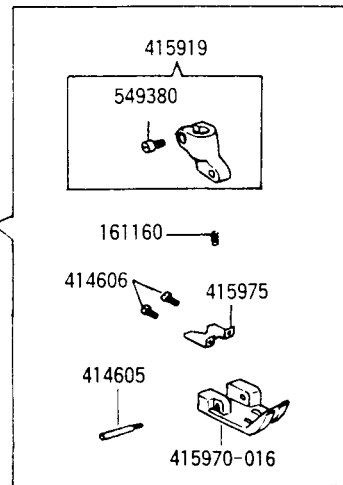

415919

549380

161160

414606

415975

414605

415970-016

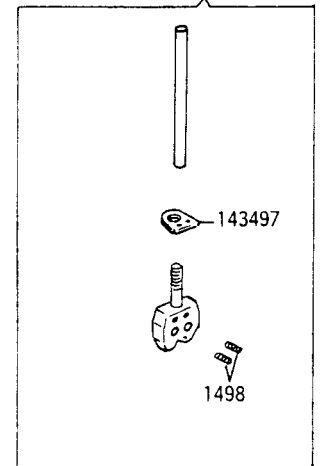

143497



1498

AVAILABLE AT EXTRA CHARGE

792D 200A / 300A-NEEDLE GAUGE 3/16" (4.8mm)

415971-012

109051-823

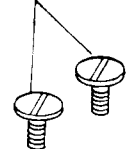

156058



415974-008 (200A (MH))
415974-012 (300A (H))

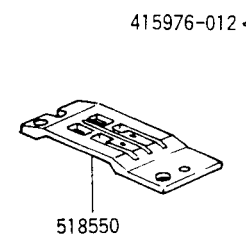

518550

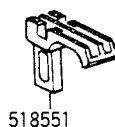

518551



518204

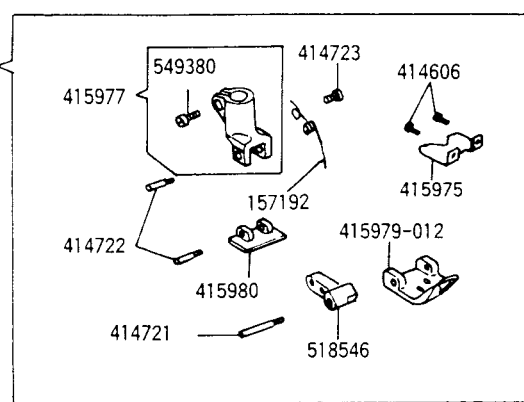

415976-012

415977

549380

414723

414606

415975

414722

157192

415979-012

414721

415980

518546

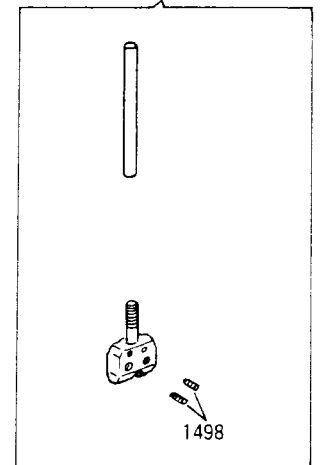

1498

NUMERICAL LIST OF PARTS FOR MACHINE 792D 100A/200A/300A

AVAILABLE AT EXTRA CHARGE

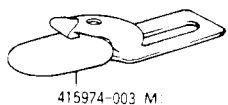
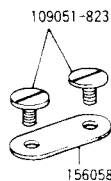

AVAILABLE AT EXTRA CHARGE

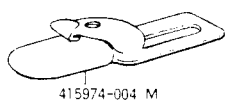
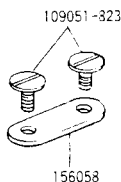

AVAILABLE AT EXTRA CHARGE

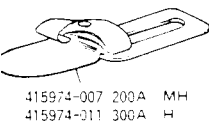
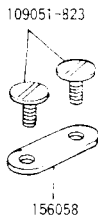

PART NO.	DESCRIPTION	PART NO.	DESCRIPTION
1498	Needle Set Screw (2)	415982-016	Presser Foot Plate (front) (for 200/300A)
2102	Looper Thread Tension Disc (4)	415983	Presser Foot Plate (back) (for 200/300A)
2102	Needle Thread Tension Disc (4)	415984	Needle Bar Eccentric Stud and Needle Bar Connecting Link Complete, Nos. 415985, 504118, 540661 and 540662 (for 300A)
32572	Looper Thread Tension Presser Disc (2)	415985	Needle Bar Eccentric Stud (for 300A)
32572	Needle Thread Tension Releasing Disc (2)	415986	Looper Cover Plate (large) Complete, Nos. 146689 to 146691, 415987, 518175, two 543804-003 and four 414720-452
143497	Needle Bar Thread Guard (for 100A)	415987	Looper Cover Plate (large)
156316	Looper Thread Guide (2)	504114	Thread Guide Stop Set Screw (2)
156316	Needle Thread Guide (2)	518059	Thread Guide Stop
156376	Looper Thread Tension Spring (2)	518064	Thread Guide Stop (2)
156722	Feed Dog (22 teeth per inch) (for 100A)	518201	Looper (back)
156723-012	Throat Plate (for 100A)	518203	Looper (front)
156801	Looper Thread Guide (2)	518204	Looper (front)
156801	Needle Thread Guide (2)	518542-016	Throat Plate (for 200/300A)
156964	Throat Plate (for 100A)	518543	Feed Dog (12 teeth per inch) (for 200/300A)
157190	Feed Dog (22 teeth per inch) (for 100A)	518546	Presser Foot Plate Connection (for 200/300A)
157192	Presser Foot Plate (back) Spring (for 200/300A)	518550	Throat Plate (for 200/300A)
161160	Presser Foot Spring (for 100A)	518551	Feed Dog (15 teeth per inch) (for 200/300A)
202407	Needle Thread Tension Spring (2)	541182	Needle Thread Tension Stud Nut (2)
411154	Needle Thread Tension Stud Nut Washer (2)	544208-001	Looper Set Screw (2)
414605	Presser Foot Screw Stud (for 100A)	545404-451	Looper Thread Tension Stud Nut (2)
414606	Chain Cutter Screw (2)	549380	Presser Foot Clamping Screw
414721	Presser Foot Screw Stud (for 200/300A)	CAT. 3651-05	Needle (#14) (2) (for 100A)
414722	Presser Foot Screw Stud (2) (for 200/300A)	CAT. 3651-05	Needle (#16) (2) (for 200A)
414723	Presser Foot Plate (back) Spring Retainer Screw (for 200/300A)	CAT. 3651-05	Needle (#19) (2) (for 300A)
415807	Looper Thread Tension Complete (2)		
415808	Looper Thread Tension Stud (2)		
415808	Needle Thread Tension Stud (2)		
415809	Needle Thread Tension Complete (2)		
415813	Needle Thread Tension Release Arm		
415814	Needle Thread Tension Release Pivot Stud		
415919	Presser Foot (shank) with 549380 (for 100A)		
415956	Arm Top Cover and Tension Complete, Nos. 415811 to 415814, 414957, 504048, 543801-005, 545175-451, two Each 415807, 415809 and 415810, four Each 156316 and 156801		
415957	Arm Top Cover		
415958	Thread Guide Complete		
415963	Needle Guide and Bracket Complete, Nos. 415838, 415964, 504135 and 543804-003		
415964	Needle Guide Complete		
415966	Looper Frame with Looper Lever and Driving Lever Complete, Nos. 415876, 415880, 415933, two Each 518153, 543803-004 and 545421, four Each 518073 and 518101		
415967	Looper Lever with two 544208-001		
415969-012	Presser Foot Complete, Nos. 161160, 414605, 415919, 415970-012, 415975 and two 414606 (for 100A)		
415969-016	Presser Foot Complete, Nos. 161160, 414605, 415919, 415970-016, 415975 and two 414606 (for 100A)		
415970-012	Presser Foot Plate (for 100A)		
415970-016	Presser Foot Plate (for 100A)		
415971-012	Needle Bar with Holder, 143497 and two 1498 (for 100A)		
415971-012	Needle Bar with Holder and two 1498 (for 200/300A)		
415971-016	Needle Bar with Holder, 143497 and two 1498 (for 100A)		
415971-016	Needle Bar with Holder and two 1498 (for 200/300A)		
415975	Chain Cutter		
415976-012	Presser Foot (simple hinged) Complete, Nos. 157192, 414606, 414721, 414723, 415975, 415977, 415979-012, 415980, 518546 and two 414722 (for 200/300A)		
415977	Presser Foot (shank) with 549380 (for 200/300A)		
415979-012	Presser Foot Plate (front) (for 200/300A)		
415980	Presser Foot Plate (back) (for 200/300A)		
415981-016	Presser Foot (simple hinged) Complete, Nos. 157192, 414606, 414721, 414723, 415975, 415977, 415982-016, 415983, 518546 and two 414722 (for 200/300A)		
415982-016	Presser Foot Plate (front) (for 200/300A)		
415983	Presser Foot Plate (back) (for 200/300A)		
415984	Needle Bar Eccentric Stud and Needle Bar Connecting Link Complete, Nos. 415985, 504118, 540661 and 540662 (for 300A)		
415985	Needle Bar Eccentric Stud (for 300A)		
415986	Looper Cover Plate (large) Complete, Nos. 146689 to 146691, 415987, 518175, two 543804-003 and four 414720-452		
415987	Looper Cover Plate (large)		
504114	Thread Guide Stop Set Screw (2)		
518059	Thread Guide Stop		
518064	Thread Guide Stop (2)		
518201	Looper (back)		
518203	Looper (front)		
518204	Looper (front)		
518542-016	Throat Plate (for 200/300A)		
518543	Feed Dog (12 teeth per inch) (for 200/300A)		
518546	Presser Foot Plate Connection (for 200/300A)		
518550	Throat Plate (for 200/300A)		
518551	Feed Dog (15 teeth per inch) (for 200/300A)		
541182	Needle Thread Tension Stud Nut (2)		
544208-001	Looper Set Screw (2)		
545404-451	Looper Thread Tension Stud Nut (2)		
549380	Presser Foot Clamping Screw		
CAT. 3651-05	Needle (#14) (2) (for 100A)		
CAT. 3651-05	Needle (#16) (2) (for 200A)		
CAT. 3651-05	Needle (#19) (2) (for 300A)		
ACCESSORIES			
415941-452	Thread Unwinder Complete (for four spools)		
CAT. 3651-05	Needle (#14) (4) (for 100A)		
CAT. 3651-05	Needle (#16) (4) (for 200A)		
CAT. 3651-05	Needle (#19) (4) (for 300A)		
AVAILABLE AT EXTRA CHARGE			
109051-823	Lap Seam Feller Clamping Screw		
156058	Lap Seam Feller Clamping Plate		
415974-003	Lap Seam Feller Complete (3.16 M) (for 100A)		
415974-004	Lap Seam Feller Complete (3.14 M) (for 100A)		
415974-007	Lap Seam Feller Complete (3.16 MH) (for 200A)		
415974-008	Lap Seam Feller Complete (3.14 MH) (for 200A)		
415974-011	Lap Seam Feller Complete (3.16 H) (for 300A)		
415974-012	Lap Seam Feller Complete (3.14 H) (for 300A)		