

# **SINGER**

**22W23, W25, W38, W111, W113, W133,  
W207**

Form 1874w  
FEBRUARY, 1925  
PRINTED IN U. S. A.

# LIST OF PARTS



**MACHINES**  
Nos. 22w23, 22w25,  
22w38, 22w111, 22w113,  
22w133 and 22w207

---

THE SINGER MANUFACTURING COMPANY

# Instructions for Ordering

In ordering from this list, use **ONLY** the **PART** number in the **FIRST** column.

The number stamped on a Sewing Machine Part is the number of the Single Part only, except when the part includes Set Screws, Clamping Screws, Studs and Rollers Spun on, Small Wires riveted, or Parts soldered together, etc., which it is necessary to furnish in combination.

Every combination of parts sent out has its specific number which, although not stamped on Parts (except in above cases) must be used when ordering the combination.

Each number always indicates the **SAME PART** in whatever list it appears, or for whatever Machine.

The letters after some of the numbers indicate the style of finish only, as follows:

- A. Hardened, Polished and Plated.
- B. Polished and Plated.
- C. Hardened only.
- D. Polished only.
- E. Soft, not polished.
- F. Hardened and Polished.
- H. Blued.

These letters **MUST BE USED** when they appear in the list and **AFTER** the number, as in the list.

In this series

- 200001 to 201500 are Screw Numbers.
- 201501 to 201800 are Nut Numbers.
- 201801 to 202000 are Roller Numbers.
- 202001 and upward are numbers of Machine Parts.

The figures in the second column refer only to the plate in which the illustration of the part is shown and are **NOT TO BE USED** in ordering.

Two or more numbers over a cut indicate that the difference between such parts is not visible in an illustration.

Parts marked with an asterisk (\*) are furnished only when repairs are made at the factory.

## LIST OF PARTS COMPLETE

FOR

## MACHINE No. 22w23

DROP FEED

For Collars and Cuffs

In gauges from  $\frac{3}{8}$  to  $\frac{1}{4}$  inch

No.	Plate	Name
*204161	---	Arm with 200439c, 202036 and 204705 .....
204163	12305	Arm Cap .....
200278H	12311	" " Screw .....
202248	12307	" " " Washer .....
200963E	12311	" Screw (3) .....
202005	12308	" " Washer (3) .....
203202	12333	" Shaft .....
204705	12334	" " Bushing (front) .....
200439c	12311	" " " Position Screw ..
204440	12333	" " Connection with four 200054E (2) .....
200054E	12307	Arm Shaft Connection Screw ....
202299	---	" " Oil Packing (wick) (2)
204805	13329	Balance Wheel, 5 $\frac{1}{4}$ in. diam. (belt groove 2 $\frac{3}{4}$ in. diam.), with 200328c and 200335c .....
200062H	12311	Balance Wheel Adjusting Screw ..
200328c	12311	" " Position Screw ....
200335c	12311	" " Set Screw .....
*203300	---	Bed with 202062, 203248, 203249, two each 200362c, 200516E, 200840E and 202299 .....
202258	12345	Bed Hinge Connection (2) .....
200570E	12311	" " " Screw (4) ....
203329	11802	" Slide (back) .....
203301	12334	" " (front) .....
203208	12312	Bobbin (2) .....
203210	12312	" Case Base with 202056, 203211 to 203213 and 203216 ...
203211	12312	Bobbin Case Base Latch .....
*202056	---	" " " " Pin .....
203212	12312	" " " " Plunger ..
203213	12312	" " " " Spring ...

No.	Plate	Name
203209	12312	Bobbin Case Cap with 200984c, 203214, 203215 and two 200594c...
203214	12312	Bobbin Case Tension Spring .....
200984c	12312	" " " " Regulating Screw .....
200594c	12312	Bobbin Case Tension Spring Screw
203215	12312	" " Thread Guide .....
200594c	12312	" " " " Screw ..
203216	12312	" " Washer (cloth) .....
203217	12312	Bobbin Case complete, Nos. 203209 and 203210 .....
221432	---	Compound Presser Bar 202506 with 202737 and 202874 .....
204533	12333	Face Plate with 200366n, 204730, two each 200368n, 202090, 204281 and three 200397n .....
200053c	12311	Face Plate Screw .....
204730	12386	" " Thread Guide .....
200397n	12309	" " " " Set Screw
221444	11804	Face Plate complete, Nos. 200135e, 200319c, 200577n, 204277 to 204279, 204533, 204555, 213873, two each 200309e, 204059 and 213872 .....
203303	12334	Feed Bar with 204189 .....
203309	---	" " 203303 with 200214e, 201525e and 204200 .....
200214e	12386	Feed Bar Hinge Screw .....
201525e	12386	" " " " Nut .....
214424	11142	" " Spring .....
204189	12306	" " " Hook .....
211642	13142	" Dog, for 211641 .....
211648	13142	" " " 211647 .....
211654	13141	" " " 211653 .....
211784	13143	" " " 211782 .....
200106e	12311	" " Screw (2) .....
200075e	11801	" " Support Screw .....
201535e	11801	" " " " Nut .....
213032	11801	" Driving Cam with 200378c and 200437c .....
204192	---	Feed Driving Cam Fork Lever with 204195 and 204293 .....
204193	12334	Feed Driving Cam Fork Lever Connection with 200668c and 201525e
204194	12306	Feed Driving Cam Fork Lever Connection Clamp with 200031f .....
200031f	12311	Feed Driving Cam Fork Lever Connection Clamp Pinch Screw .....
200668c	12386	Feed Driving Cam Fork Lever Connection Clamp Screw Stud .....

No.	Plate	Name
201525e	12386	Feed Driving Cam Fork Lever Connection Clamp Screw Stud ..
200002e	12332	Feed Driving Cam Fork Lever Connection Hinge Screw .....
201522e	12332	Feed Driving Cam Fork Lever Connection Hinge Screw Nut .....
*204195	---	Feed Driving Cam Fork Lever Shaft .....
204197	12306	Feed Driving Cam Fork Lever Shaft Collar with 200113f .....
200113f	12308	Feed Driving Cam Fork Lever Shaft Collar Set Screw .....
204293	12308	Feed Driving Cam Fork Lever Shaft Position Pin .....
204196	12307	Feed Driving Cam Fork Lever Shaft Sleeve (split) .....
200043c	12311	Feed Driving Cam Fork Lever Shaft Sleeve Set Screw .....
201524e	12332	Feed Driving Cam Fork Lever Shaft Sleeve Set Screw Nut ...
204198	12334	Feed Driving Cam Fork Lever complete, Nos. 204192 and 204194 ..
200437c	12311	Feed Driving Cam Position Screw
200378c	12311	" " " Set Screw ....
204199	12333	" " Rock Shaft .....
206554	---	" " " " 204199 with 200002e, 201522e and 204193 ...
202305	12307	Feed Driving Rock Shaft Center (2)
200043c	12311	" " " " " Set Screw (2) .....
204200	12305	Feed Driving Rock Shaft Crank with 204189 (on left side) and two 200383c .....
200383c	12311	Feed Driving Rock Shaft Crank Set Screw .....
203454	11801	Feed Lifting Cam with 200353c and 202126 .....
204202	12308	Feed Lifting Cam Fork with 200027e
200027e	12332	" " " " Pinch Screw
202126	12308	" " " Position Pin ....
200353c	11801	" " " Set Screw .....
203305	12334	" " Rock Shaft .....
203315	12334	" " " " 203305 with 203238 .....
202305	12307	Feed Lifting Rock Shaft Center (2)
200043c	12311	" " " " " Set Screw (2) .....
202276	12308	Feed Lifting Rock Shaft Slide Block .....

No.	Plate	Name
203238	12308	Feed Lifting Rock Shaft Slide Block 202276 with 200243e and 201531e .....
200243e	12332	Feed Lifting Rock Shaft Slide Block Hinge Screw .....
201531e	12308	Feed Lifting Rock Shaft Slide Block Hinge Screw Nut .....
204206	12306	Feed Regulating Handle .....
204207	12334	" " " 204206 with 200098e, 202622, 204208 to 204210, 204213 and 204925 .....
204208	12307	Feed Regulating Handle Adjustable Stop .....
200098e	12307	Feed Regulating Handle Adjustable Stop Screw .....
204925	12306	Feed Regulating Handle Adjustable Stop Screw Washer .....
204209	12307	Feed Regulating Handle Position Pin .....
204210	12306	Feed Regulating Handle Shaft .....
204211	12306	" " " " Crank with 200098e .....
204212	12307	Feed Regulating Handle Shaft Crank Link .....
200271e	12311	Feed Regulating Handle Shaft Crank Link Hinge Screw (lower) .....
200291e	12307	Feed Regulating Handle Shaft Crank Link Hinge Screw (upper) .....
200098e	12307	Feed Regulating Handle Shaft Crank Set Screw .....
204213	12307	Feed Regulating Handle Shaft Sleeve (split) .....
200362c	12311	Feed Regulating Handle Shaft Sleeve Set Screw .....
202622	12306	Feed Regulating Handle Shaft Sleeve Washer .....
202036	12332	Feed Regulating Handle Stop Pin .....
204214	---	Feed Regulating Handle complete, Nos. 200291e, 204207, 204211 and 204212 .....
*203674	---	Hook (sewing) .....
203675	11801	" 203674 with 201253e, 201376e and 203251 .....
203676	---	Hook and Bobbin Case complete, Nos. 203217 and 203675 .....
203241	11007	Hook Bevel Gear Socket, 24 teeth .....
200555H	11007	" " " " Screw .....
203242	11007	" " Pinion, 24 teeth, with two 200383c (2) .....

No.	Plate	Name
200383c	12311	Hook Bevel Pinion Set Screw .....
203306	12333	" Counter Shaft .....
203244	11007	" " " Collar with two 200393c .....
200393c	11007	Hook Counter Shaft Collar Set Screw .....
203245	11007	Hook Counter Shaft Driving Gear, 44 teeth, with 200362c and 200439c .....
200439c	12311	Hook Counter Shaft Driving Gear Position Screw .....
200362c	12311	Hook Counter Shaft Driving Gear Set Screw .....
203246	11007	Hook Counter Shaft Gear, 22 teeth, with two 200383c .....
200383c	12311	Hook Counter Shaft Gear Set Screw .....
202299	---	" " " Oil Packing (wick) .....
200840e	11007	Hook Counter Shaft Oil Packing (wick) Stop Screw .....
203247	12333	Hook Driving Shaft .....
203248	12234	" " " Bearing with 202299 .....
202299	---	Hook Driving Shaft Bearing Oil Packing (wick) .....
202126	12308	Hook Driving Shaft Bearing Position Pin .....
200516e	12311	Hook Driving Shaft Bearing Screw .....
203249	11007	" " " Bushing (eccentric) .....
202299	---	Hook Driving Shaft Bushing Oil Packing (wick) .....
200362c	12311	Hook Driving Shaft Bushing Set Screw .....
213141	11801	Hook Driving Shaft Collar with two 200393c .....
200393c	11007	Hook Driving Shaft Collar Set Screw .....
203251	12312	Hook Gib .....
201376e	13136	" " Hinge Screw .....
201253e	13136	" " Screw .....
203307	12335	" Saddle (left or right) with 202299 .....
202299	---	Hook Saddle Oil Packing (wick) .....
200006e	11007	" " Screw (4) .....
225585	11007	" " " Washer (4) .....
213035	11029	" Washer .....
213741	11805	Hook Saddle complete, Nos. 200555H, 203241, 203307, 203676 and 213035 .....

No.	Plate	Name
203677	—	Hook Saddle Combination(left and right) complete, Nos. two 213741
208490	—	Knee Lifter Connection Lever ....
227311	—	" " " " 208490 with 227302, 227308 and two 200262H .....
200262H	12306	Knee Lifter Connection Lever Hinge Screw .....
227308	11125	Knee Lifter Connection Lever Lifting Rod with 202302 .....
202302	12306	Knee Lifter Connection Lever Lifting Rod Cotter Pin .....
227302	11125	Knee Lifter Lifting Lever .....
200262H	12306	" " " " Hinge Screw .....
231390	11802	Needle Bar (hollow) .....
204248	12307	" " Connecting Link ....
200658C	12307	" " " " Hinge Screw Stud .....
200380C	12319	Needle Bar Connecting Link Hinge Screw Stud Set Screw .....
204249	12308	Needle Bar Connecting Stud with 200072C and 202277 .....
202277	—	Needle Bar Connecting Stud Oil Packing (wick) .....
200072C	12308	Needle Bar Connecting Stud Pinch Screw .....
204326	—	Needle Bar Packing Cord (2) ....
200504E	12386	" " Screw Bushing (lower)
200503B	12386	" " " " (upper)
231383	13140	" Holder, in gauges from $\frac{3}{16}$ to $\frac{1}{4}$ in., in steps of $\frac{1}{32}$ in., with 201030F and two 200141F .....
201030F	13136	Needle Holder Screw .....
200141F	12332	" Set Screw .....
202506	11802	Presser Bar (hollow) .....
202509	13084	" " Auxiliary Bar with 200543H .....
202510	13084	Presser Bar Auxiliary Bar Collar with 200141F .....
200141F	12332	Presser Bar Auxiliary Bar Collar Set Screw .....
200543H	13084	Presser Bar Auxiliary Bar Foot Screw .....
202512	13084	Presser Bar Auxiliary Bar Pin ....
202513	13084	" " " " Spring..
*206904	—	" " Bracket .....

No.	Plate	Name
202507	13084	Presser Bar Bracket 206904 with 200387C .....
202874	—	Presser Bar Bracket 202507 with 202509, 202510, 202512 and 202513
200387C	12376	Presser Bar Bracket Set Screw ...
204252	12308	" " Lifter .....
200550C	12311	" " " Hinge Screw ..
204253	12308	" " Lifting Bracket with 200086C .....
200086C	12308	Presser Bar Lifting Bracket Pinch Screw .....
204254	12307	Presser Bar Lifting Bracket Position Guide .....
200362C	12311	Presser Bar Lifting Bracket Position Guide Set Screw .....
204327	12306	Presser Bar Packing Washer (felt)
200504E	12386	" " Screw Bushing (lower)
204255	13135	" " Spring .....
202737	13084	" " Stop Collar with 200380C .....
200380C	12319	Presser Bar Stop Collar Set Screw
200491B	12305	" " Thumb Screw (pressure regulating) .....
229550	13084	Presser Foot, 46 needle hole, in gauges from $\frac{3}{16}$ to $\frac{1}{8}$ in., in steps of $\frac{1}{32}$ inch .....
222292	13144	Presser Foot, 46 needle hole, in gauges $\frac{3}{16}$ and $\frac{1}{4}$ inch .....
203225	11802	Take-up Cam with 200335C, 200380C, 200383C, 200430C and 200658C ..
203172	12307	Take-up Cam Friction Washer ...
200430C	12311	" " Position Screw .....
200383C	12311	" " " " Check Screw .....
200335C	12311	Take-up Cam Set Screw .....
204553	12386	" Lever .....
206601	—	" " 204553 with 204263 ..
204263	12386	" " Bearing with 204264..
204264	12306	" " " Position Pin ..
200042F	12311	" " " Screw .....
201816	12307	" " Roller .....
204554	12386	Take-up Lever complete, Nos. 200042F, 201816 and 206601 ....
202402	12309	Tension Disc .....
202090	12309	" " Position Pin .....
204555	12332	" Release Lever .....
200309F	10483	" " " Screw .....
202075	12309	" " Plunger .....
208489	—	" " Slide .....
206608	13136	" " " Spring .....

No.	Plate	Name
204270	11801	Tension Spring .....
200632B	12309	" Stud .....
200397H	12309	" " Set Screw .....
201572B	10881	" Thumb Nut .....
204271	12309	" Washer .....
213872	13136	Tension complete, Nos. 200632B, 201572B, 202075, 204270, 204271 and two 202402 .....
204273	12308	Thread Controller Adjusting Collar with 200684H (for Presser Bar) ..
200684H	12308	Thread Controller Adjusting Collar Screw .....
204274	12309	Thread Controller Plate .....
200577H	12311	" " " Screw ...
202098	12309	" " Roller .....
204275	12309	" " Guard .....
202084	12309	" " " Washer .....
200300C	12309	" " " Screw .....
202085	11868	" " Spring .....
204333	12309	" " " Guard .....
200581H	12309	" " " " Screw .....
204277	12309	" " " Stop .....
204278	12309	" " " Driving Gear .....
200319C	12309	Thread Controller Spring Stop Driv- ing Gear Hinge Screw .....
200135E	12309	Thread Controller Spring Stop Screw .....
204279	12309	Thread Controller Spring Stud with 204925 .....
200366H	12309	Thread Controller Spring Stud Set Screw .....
204925	12306	Thread Controller Spring Stud Washer .....
205987	12309	Thread Controller complete, Nos. 200300C, 200581H, 202084, 202098, 204274, 204275 and 204333 .....
213873	11801	Thread Controller and Spring com- plete, Nos. 202085 and 205987 ..
203313	12386	Thread Guide .....
204556	12386	" " .....
204281	12309	" Retainer Guide Wire .....
202091	12309	" " Sleeve .....
202092	12309	" " Spring .....
204058	12309	" " Stud .....
200368H	12309	" " " Set Screw .....
204059	12309	Thread Retainer complete, Nos. 202091, 202092 and 204058 .....

No.	Plate	Name
211641	13146	Throat Plate, 50 needle hole, for needle sizes 14 and 15, in $\frac{3}{16}$ in. gauge, for 211642 .....
211647	13146	Throat Plate, 50 needle hole, for needle sizes 14 and 15, in $\frac{1}{4}$ in. gauge, for 211648 .....
211653	13146	Throat Plate, 50 needle hole, for needle sizes 14 and 15, in gauges $\frac{3}{16}$ and $\frac{1}{4}$ in., for 211654 .....
211782	13146	Throat Plate, 50 needle hole, for needle sizes 14 and 15, in gauges $\frac{3}{16}$ and $\frac{1}{4}$ in., for 211784 .....
200161D	12319	Throat Plate Clamp Screw .....
202062	12308	" " Position Pin .....
200577H	12311	" " Screw .....





No.	Plate	Name
213639	11801	Cord Guiding Eccentric Shaft Collar with 200380c .....
200380c	12319	Cord Guiding Eccentric Shaft Collar Set Screw .....
202576	11036	Cord Guiding Eccentric Shaft Washer .....
200097c	11036	Cord Guiding Eccentric Shaft Washer Screw .....
213415	11029	Cord Tension Bracket with two each 200618B, 202090 and 202571 ..
200577H	12311	Cord Tension Bracket Screw (2) ..
202402	12309	" " Disc .....
202090	12309	" " Position Pin .....
202579	11036	" " Spring .....
202580	11036	" " Washer .....
200618B	11029	" " Stud .....
202571	11029	" " Thread Leader .....
201572B	10881	" " Thumb Nut .....
213670	—	Cord Tension Bracket complete, Nos. 213415, two each 201572B, 202579, 202580 and four 202402 ..
204533	12333	Face Plate with 200366H, 204730, two each 200368H, 202090, 204281 and three 200397H .....
200053c	12311	Face Plate Screw .....
204730	12386	" " Thread Guide .....
200397H	12309	" " Set Screw .....
204874	12333	Face Plate complete, Nos. 200135E, 200319c, 200577H, 204277 to 204280, 204533, 204555, two each 200309E, 204059 and 204272 .....
203303	12334	Feed Bar with 204189 .....
203309	—	" " 203303 with 200214E, 201525E and 204200 .....
200214E	12386	Feed Bar Hinge Screw .....
201525E	12386	" " Nut .....
214424	11142	" " Spring .....
204189	12306	" " Hook .....
211298	13142	" Dog, for 211879 .....
212571	11813	" " 211614 .....
200106E	12311	" " Screw (2) .....
200075E	11801	" " Support Screw .....
201535E	11801	" " Nut .....
203233	12305	" Driving Cam with 200382c and 200437c .....
204192	—	Feed Driving Cam Fork Lever with 204195 and 204293 .....
204193	12334	Feed Driving Cam Fork Lever Connection with 200668c and 201525E ..

No.	Plate	Name
204194	12306	Feed Driving Cam Fork Lever Connection Clamp with 200031E ....
200031E	12311	Feed Driving Cam Fork Lever Connection Clamp Pinch Screw ....
200668c	12386	Feed Driving Cam Fork Lever Connection Clamp Screw Stud .....
201525E	12386	Feed Driving Cam Fork Lever Connection Clamp Screw Stud Nut ..
200002E	12332	Feed Driving Cam Fork Lever Connection Hinge Screw .....
201522E	12332	Feed Driving Cam Fork Lever Connection Hinge Screw Nut .....
*204195	—	Feed Driving Cam Fork Lever Shaft .....
204197	12306	Feed Driving Cam Fork Lever Shaft Collar with 200113E .....
200113E	12308	Feed Driving Cam Fork Lever Shaft Collar Set Screw .....
204293	12308	Feed Driving Cam Fork Lever Shaft Position Pin .....
204196	12307	Feed Driving Cam Fork Lever Shaft Sleeve (split) .....
200043c	12311	Feed Driving Cam Fork Lever Shaft Sleeve Set Screw .....
201524E	12332	Feed Driving Cam Fork Lever Shaft Sleeve Set Screw Nut ....
204198	12334	Feed Driving Cam Fork Lever complete, Nos. 204192 and 204194 ..
200437c	12311	Feed Driving Cam Position Screw .....
200382c	11142	" " Set Screw ....
204199	12323	" " Rock Shaft .....
206554	—	" " " " 204199 with 200002E, 201522E and 204193 ...
202305	12307	Feed Driving Rock Shaft Center (2) ..
200043c	12311	" " " " " Set Screw (2) .....
204200	12305	Feed Driving Rock Shaft Crank with 204189 (on left side) and two 200383c .....
200383c	12311	Feed Driving Rock Shaft Crank Set Screw .....
203235	12308	Feed Lifting Cam with 202126 ...
204202	12308	" " Fork with 200027E ..
200027E	12332	" " Pinch Screw .....
202126	12308	" " Position Pin ...
200045E	12332	" " Screw .....
203305	12334	" " Rock Shaft .....
203315	12334	" " " " 203305 with 203238 .....

No.	Plate	Name
202305	12307	Feed Lifting Rock Shaft Center (2)
200043c	12311	" " " " " Set Screw (2) .....
202276	12308	Feed Lifting Rock Shaft Slide Block .....
203238	12308	Feed Lifting Rock Shaft Slide Block 202276 with 200243e and 201531e .....
200243e	12332	Feed Lifting Rock Shaft Slide Block Hinge Screw .....
201531e	12308	Feed Lifting Rock Shaft Slide Block Hinge Screw Nut .....
204206	12306	Feed Regulating Handle .....
204207	12334	" " " 204206 with 200098f, 202622, 204208 to 204210, 204213 and 204925 .....
204208	12307	Feed Regulating Handle Adjustable Stop .....
200098f	12307	Feed Regulating Handle Adjustable Stop Screw .....
204925	12306	Feed Regulating Handle Adjustable Stop Screw Washer .....
204209	12307	Feed Regulating Handle Position Pin .....
204210	12306	Feed Regulating Handle Shaft .....
204211	12306	" " " " Crank with 200098f .....
204212	12307	Feed Regulating Handle Shaft Crank Link .....
200271e	12311	Feed Regulating Handle Shaft Crank Link Hinge Screw (lower)
200291e	12307	Feed Regulating Handle Shaft Crank Link Hinge Screw (upper)
200098f	12307	Feed Regulating Handle Shaft Crank Set Screw .....
204213	12307	Feed Regulating Handle Shaft Sleeve (split) .....
200362c	12311	Feed Regulating Handle Shaft Sleeve Set Screw .....
202622	12306	Feed Regulating Handle Shaft Sleeve Washer .....
202036	12332	Feed Regulating Handle Stop Pin
204214	---	Feed Regulating Handle complete, Nos. 200291e, 204207, 204211 and 204212 .....
*203239	---	Hook (sewing) .....
203240	12312	" 203239 with 201253e, 201376f and 203251 .....
203290	12312	Hook and Bobbin Case complete, Nos. 203217 and 203240 .....

No.	Plate	Name
203241	11007	Hook Bevel Gear Socket, 24 teeth
200555h	11007	" " " " Screw ...
203242	11007	" " Pinion, 24 teeth, with two 200383c (2) .....
200383c	12311	Hook Bevel Pinion Set Screw ....
203306	12333	" Counter Shaft .....
203244	11007	" " " Collar with two 200393c .....
200393c	11007	Hook Counter Shaft Collar Set Screw .....
203245	11007	Hook Counter Shaft Driving Gear, 44 teeth, with 200362c and 200439c
213154	12305	Hook Counter Shaft Driving Gear 203245 with 200045e and 203235..
200439c	12311	Hook Counter Shaft Driving Gear Position Screw .....
200362c	12311	Hook Counter Shaft Driving Gear Set Screw .....
203246	11007	Hook Counter Shaft Gear, 22 teeth, with two 200383c .....
200383c	12311	Hook Counter Shaft Gear Set Screw
202299	---	" " " Oil Packing (wick) .....
200840e	11007	Hook Counter Shaft Oil Packing (wick) Stop Screw .....
203247	12333	Hook Driving Shaft .....
203248	12234	" " " Bearing with 202299 .....
202299	---	Hook Driving Shaft Bearing Oil Packing (wick) .....
202126	12308	Hook Driving Shaft Bearing Posi- tion Pin .....
200516e	12311	Hook Driving Shaft Bearing Screw
203249	11007	" " " Bushing (eccen- tric) .....
202299	---	Hook Driving Shaft Bushing Oil Packing (wick) .....
200362c	12311	Hook Driving Shaft Bushing Set Screw .....
213141	11801	Hook Driving Shaft Collar with two 200393c .....
200393c	11007	Hook Driving Shaft Collar Set Screw .....
203251	12312	Hook Gib .....
201376f	13136	" " Hinge Screw .....
201253e	13136	" " Screw .....
203307	12335	" Saddle (left or right) with 202299 .....

No.	Plate	Name
202299	---	Hook Saddle Oil Packing (wick) ..
200006E	11007	" " Screw (4) .....
225585	11007	" " Washer (4) .....
203254	12312	" Washer .....
203308	12335	Hook Saddle complete, Nos. 200555u, 203241, 203254, 203290 and 203307 .....
203462	---	Hook Saddle Combination (left and right) complete, Nos. two 203308
208490	---	Knee Lifter Connection Lever ....
213877	11802	" " " " Lifting Rod with 202302 .....
202302	12306	Knee Lifter Connection Lever Lifting Rod Cotter Pin .....
227302	11125	Knee Lifter Lifting Lever .....
231390	11802	Needle Bar (hollow) .....
204248	12307	" " Connecting Link .....
200658c	12307	" " " " Hinge Screw Stud .....
201519E	12307	Needle Bar Connecting Link Hinge Screw Stud Nut .....
204249	12308	Needle Bar Connecting Stud with 200072c and 202277 .....
202277	---	Needle Bar Connecting Stud Oil Packing (wick) .....
200072c	12308	Needle Bar Connecting Stud Pinch Screw .....
204326	---	Needle Bar Packing Cord (2) ....
200504E	12386	" " Screw Bushing (lower)
200503R	12386	" " " " (upper)
231383	13140	" Holder, in gauges $\frac{3}{8}$ , $\frac{1}{2}$ , $\frac{5}{8}$ and $\frac{3}{4}$ in., with 201030E and two 200141E .....
201030E	13136	Needle Holder Screw .....
200141E	12332	" Set Screw .....
204251	12334	Presser Bar (hollow) with 200074E
204252	12308	" " Lifter .....
200550c	12311	" " " Hinge Screw ...
204253	12308	" " Lifting Bracket with 200086c .....
200086c	12308	Presser Bar Lifting Bracket Pinch Screw .....
204254	12307	Presser Bar Lifting Bracket Position Guide .....
200362c	12311	Presser Bar Lifting Bracket Position Guide Set Screw .....

No.	Plate	Name
204327	12306	Presser Bar Packing Washer (felt)
200504E	12386	" " Screw Bushing (lower)
204255	13135	" " Spring .....
200491B	12305	" " Thumb Screw (pressure regulating) .....
213042	11029	Presser Foot, 46 needle hole, in gauges $\frac{3}{8}$ , $\frac{1}{2}$ , $\frac{5}{8}$ and $\frac{3}{4}$ inch ..
200074E	12308	Presser Foot Screw .....
212920	---	Take-up Cam with 200335c and 200430c .....
203268	12334	Take-up Cam 212920 with 200383c, 200658c and 201519E .....
203172	12307	Take-up Cam Friction Washer ....
200430c	12311	" " Position Screw .....
200383c	12311	" " " " Check Screw .....
200335c	12311	Take-up Cam Set Screw .....
204553	12386	" Lever .....
206601	---	" " 204553 with 204263 ..
204263	12386	" " Bearing with 204264 ..
204264	12306	" " " Position Pin ..
200042E	12311	" " " Screw .....
201816	12307	" " Roller .....
204554	12386	Take-up Lever complete, Nos. 200042E, 201816 and 206601 .....
202402	12309	Tension Disc .....
202090	12309	" " Position Pin .....
204555	12332	" Release Lever .....
200309E	10483	" " " Screw .....
202075	12309	" " Plunger .....
208489	---	" " Slide .....
206608	13136	" " " Spring .....
202407	10881	" Spring .....
200632B	12309	" Stud .....
200397H	12309	" " Set Screw .....
201572B	10881	" Thumb Nut .....
204271	12309	" Washer .....
204272	12309	Tension complete, Nos. 200632B, 201572B, 202075, 202407, 204271 and two 202402 .....
204273	12308	Thread Controller Adjusting Collar with 200684H (for Presser Bar) ..
200684H	12308	Thread Controller Adjusting Collar Screw .....
204274	12309	Thread Controller Plate .....
200577H	12311	" " " Screw .....
202098	12309	" " Roller .....
204275	12309	" " " Guard .....
202084	12309	" " " " Washer

No.	Plate	Name
200300c	12309	Thread Controller Roller Screw ..
204276	12309	" " Spring .....
204333	12309	" " " Guard .....
200581H	12309	" " " " Screw
204277	12309	" " " Stop .....
204278	12309	" " " " Driving Gear .....
200319c	12309	Thread Controller Spring Stop Driving Gear Hinge Screw .....
200135E	12309	Thread Controller Spring Stop Screw .....
204279	12309	Thread Controller Spring Stud with 204925 .....
200366H	12309	Thread Controller Spring Stud Set Screw .....
204925	12306	Thread Controller Spring Stud Washer .....
205987	12309	Thread Controller complete, Nos. 200300c, 200581H, 202084, 202098, 204274, 204275 and 204333 .....
204280	12309	Thread Controller and Spring com- plete, Nos. 204276 and 205987 ..
203313	12386	Thread Guide .....
204556	12386	" " .....
204281	12309	" Retainer Guide Wire .....
202091	12309	" " Sleeve .....
202092	12309	" " Spring .....
204058	12309	" " Stud .....
200368H	12309	" " " Set Screw .....
204059	12309	Thread Retainer complete, Nos. 202091, 202092 and 204058 .....
211879	13147	Throat Plate, 50 needle hole, for needle sizes 14 and 15, in gauges $\frac{3}{32}$ , $\frac{1}{8}$ and $\frac{5}{32}$ in., for 211298 .....
211614	11813	Throat Plate, 50 needle hole, for needle sizes 14 and 15, in $\frac{3}{16}$ in. gauge, for 212571 .....
200161D	12319	Throat Plate Clamp Screw .....
202062	12308	" " Position Pin .....
200577H	12311	" " Screw .....

## LIST OF PARTS COMPLETE

For

## MACHINE No. 22w38

DROP FEED

For Stitching and Trimming Fabrics

In gauges from  $\frac{3}{32}$  to  $\frac{1}{2}$  inch

No.	Plate	Name
*204441	----	Arm with 200439c, 202036 and 204351 .....
215948	----	Arm Bracket .....
200189H	11140	" " Screw (3) .....
215949	----	" " Switch Handle .....
215950	13139	" " " " 215949 with 201481c, 201528H and 201842
215951	13135	Arm Bracket Switch Handle Spring
200161H	12319	" " " " " " Screw .....
200859H	11140	Arm Bracket Switch Handle Stud
204346	11140	" " " " " " Bushing .....
201528H	11801	Arm Bracket Switch Handle Stud Nut .....
204347	11140	Arm Bracket Switch Handle Stud Spring .....
204443	11142	Arm Bracket Switch Spring .....
204349	11142	" " " " Hook ..
208491	----	Arm Bracket complete, Nos. 200161H, 200391c, 200859H, 201528H, 204346, 204347, 204448, 215948, 215950, 215951 and 215953 .....
204163	12305	Arm Cap .....
200278H	12311	" " Screw .....
202248	12307	" " Washer .....
200963E	12311	" Screw (3) .....
202005	12308	" " Washer (3) .....
203202	12333	" Shaft .....
204351	11142	" " Bushing (front) .....
200439c	12311	" " " Position Screw ..
204440	12333	" " Connection with four 200054E (2) .....
200054E	12307	Arm Shaft Connection Screw .....

No.	Plate	Name
204805	13329	Balance Wheel, 5½ in. diam. (belt groove 2¾ in. diam.), with 200328c and 200335c .....
200062H	12311	Balance Wheel Adjusting Screw ..
200328c	12311	" " Position Screw .....
200335c	12311	" " Set Screw .....
203300	—	Bed with 202062, 203248, 203249, two each 200362c, 200516e, 200840e and 202299 .....
202258	12345	Bed Hinge Connection (2) .....
200570e	12311	" " " Screw (4) .....
203329	11802	" Slide (back) .....
203301	12334	" " (front) .....
203470	11236	Bobbin (2) .....
*203498	—	" Case .....
203648	13136	" " Latch .....
*202056	—	" " " Pin .....
203473	13136	" " " Plunger .....
203474	13136	" " " Spring .....
203499	11235	" " Lever .....
203476	—	" " " Eccentric .....
204243	11801	" " " " Position Pin .....
203506	11235	" " " Fulcrum .....
200056e	10884	" " " " Screw .....
203478	11235	" " " Slide Stud .....
203214	12312	" " Tension Spring .....
200984c	12312	" " " " Regulat- ing Screw .....
200594c	12312	Bobbin Case Tension Spring Screw .....
203216	12312	" " Washer (cloth) .....
203500	11235	Bobbin Case complete, Nos. 200594c, 200984c, 202056, 203214, 203216, 203473, 203474, 203498 and 203648 .....
204533	12333	Face Plate with 200366H, 204730, two each 200368H, 202090, 204281 and three 200397H .....
200053c	12311	Face Plate Screw .....
204730	12386	" " Thread Guide .....
200397H	12309	" " " " Set Screw .....
204874	12333	Face Plate complete, Nos. 200135E, 200319c, 200577H, 204277 to 204280, 204533, 204555, two each 200309E, 204059 and 204272 .....
203303	12334	Feed Bar with 204189 .....
203309	—	" " 203303 with 200214e, 201525E and 204200 .....
200214e	12386	Feed Bar Hinge Screw .....
201525e	12386	" " " " Nut .....
214424	11142	" " Spring .....

No.	Plate	Name
204189	12306	Feed Bar Spring Hook .....
211884	13142	" Dog, for 222298 .....
211805	13143	" " " 222334 .....
222235	13141	" " " 222238 .....
211809	13141	" " " 212050 .....
200106E	12311	" " Screw (2) .....
203233	12305	" Driving Cam with 200382c and 200437c .....
204192	—	Feed Driving Cam Fork Lever with 204195 and 204293 .....
204193	12334	Feed Driving Cam Fork Lever Con- nection with 200668c and 201525e .....
204194	12306	Feed Driving Cam Fork Lever Con- nection Clamp with 200031E .....
200031E	12311	Feed Driving Cam Fork Lever Con- nection Clamp Pinch Screw .....
200668c	12386	Feed Driving Cam Fork Lever Con- nection Clamp Screw Stud .....
201525e	12386	Feed Driving Cam Fork Lever Con- nection Clamp Screw Stud Nut .....
200002E	12332	Feed Driving Cam Fork Lever Con- nection Hinge Screw .....
201522e	12332	Feed Driving Cam Fork Lever Con- nection Hinge Screw Nut .....
*204195	—	Feed Driving Cam Fork Lever Shaft .....
204197	12306	Feed Driving Cam Fork Lever Shaft Collar with 200113E .....
200113E	12308	Feed Driving Cam Fork Lever Shaft Collar Set Screw .....
204293	12308	Feed Driving Cam Fork Lever Shaft Position Pin .....
204196	12307	Feed Driving Cam Fork Lever Shaft Sleeve (split) .....
200043c	12311	Feed Driving Cam Fork Lever Shaft Sleeve Set Screw .....
201524e	12332	Feed Driving Cam Fork Lever Shaft Sleeve Set Screw Nut .....
204198	12334	Feed Driving Cam Fork Lever com- plete, Nos. 204192 and 204194 .....
200437c	12311	Feed Driving Cam Position Screw .....
200382c	11142	" " " Set Screw .....
204199	12333	" " Rock Shaft .....
206554	—	" " " " 204199 with 200002e, 201522e and 204193 .....
202305	12307	Feed Driving Rock Shaft Center (2) .....
200043c	12311	" " " " " Set Screw (2) .....

No.	Plate	Name
204200	12305	Feed Driving Rock Shaft Crank with 204189 (on left side) and two 200383c .....
200383c	12311	Feed Driving Rock Shaft Crank Set Screw .....
203235	12308	Feed Lifting Cam with 202126 ....
204202	12308	" " " Fork with 200027E
200027E	12332	" " " " Pinch Screw
202126	12308	" " " Position Pin ...
200045E	12332	" " " Screw .....
203305	12334	" " Rock Shaft .....
203315	12334	" " " " 203305 with 203238 .....
202305	12307	Feed Lifting Rock Shaft Center (2)
200043c	12311	" " " " " Set Screw (2) .....
202276	12308	Feed Lifting Rock Shaft Slide Block .....
203238	12308	Feed Lifting Rock Shaft Slide Block 202276 with 200243E and 201531E .....
200243E	12332	Feed Lifting Rock Shaft Slide Block Hinge Screw .....
201531E	12308	Feed Lifting Rock Shaft Slide Block Hinge Screw Nut .....
204206	12306	Feed Regulating Handle .....
204207	12334	" " " 204206 with 200098E, 202622, 204208 to 204210, 204213 and 204925 .....
204208	12307	Feed Regulating Handle Adjustable Stop .....
200098E	12307	Feed Regulating Handle Adjustable Stop Screw .....
204925	12306	Feed Regulating Handle Adjustable Stop Screw Washer .....
204209	12307	Feed Regulating Handle Position Pin .....
204210	12306	Feed Regulating Handle Shaft ....
204211	12306	" " " " Crank with 200098E .....
204212	12307	Feed Regulating Handle Shaft Crank Link .....
200271E	12311	Feed Regulating Handle Shaft Crank Link Hinge Screw (lower)
200291E	12307	Feed Regulating Handle Shaft Crank Link Hinge Screw (upper)
200098E	12307	Feed Regulating Handle Shaft Crank Set Screw .....
204213	12307	Feed Regulating Handle Shaft Sleeve (split) .....

No.	Plate	Name
200362c	12311	Feed Regulating Handle Shaft Sleeve Set Screw .....
202622	12306	Feed Regulating Handle Shaft Sleeve Washer .....
202036	12332	Feed Regulating Handle Stop Pin..
204214	-----	Feed Regulating Handle complete, Nos. 200291E, 204207, 204211 and 204212 .....
*203511	-----	Hook (sewing) .....
203512	11235	" 203511 with 203513 and two 201253F .....
203514	11235	Hook and Bobbin Case complete, Nos. 203500 and 203512 .....
213810	13139	Hook Bevel Gear Socket, 24 teeth
200555H	11007	" " " " Screw ...
203242	11007	" " Pinion, 24 teeth, with two 200383c (2) .....
200383c	12311	Hook Bevel Pinion Set Screw ....
203306	12333	" Counter Shaft .....
203244	11007	" " " Collar with two 200393c .....
200393c	11007	Hook Counter Shaft Collar Set Screw .....
203245	11007	Hook Counter Shaft Driving Gear, 44 teeth, with 200362c and 200439c
213154	12305	Hook Counter Shaft Driving Gear 203245 with 200045E and 203235..
200439c	12311	Hook Counter Shaft Driving Gear Position Screw .....
200362c	12311	Hook Counter Shaft Driving Gear Set Screw .....
203246	11007	Hook Counter Shaft Gear, 22 teeth, with two 200383c .....
200383c	12311	Hook Counter Shaft Gear Set Screw
202299	-----	" " " Oil Packing (wick) .....
200840E	11007	Hook Counter Shaft Oil Packing (wick) Stop Screw .....
203247	12333	Hook Driving Shaft .....
203248	12334	" " " Bearing with 202299 .....
202299	-----	Hook Driving Shaft Bearing Oil Packing (wick) .....
202126	12308	Hook Driving Shaft Bearing Position Pin .....
200516E	12311	Hook Driving Shaft Bearing Screw
203249	11007	" " " Bushing (eccentric) .....
202299	-----	Hook Driving Shaft Bushing Oil Packing (wick) .....

No.	Plate	Name
200362c	12311	Hook Driving Shaft Bushing Set Screw .....
213141	11801	Hook Driving Shaft Collar with two 200393c .....
200393c	11007	Hook Driving Shaft Collar Set Screw .....
203513	11235	Hook Gib .....
201253F	13136	" " Screw .....
203508	11236	" Saddle (left or right) with 200056E .....
200006E	11007	Hook Saddle Screw (4) .....
202622	12306	" " " Washer (4) ...
213036	---	" Washer .....
203516	11235	" " 213036 with 203476 and two 204243 .....
203518	11236	Hook Saddle complete, Nos. 200555H, 203478, 203499, 203506, 203508, 203514, 203516 and 213810
203519	---	Hook Saddle Combination (left and right) complete, Nos. two 203518
208490	---	Knee Lifter Connection Lever ....
227311	---	" " " " 208490 with 227302, 227308 and two 200262H .....
200262H	12306	Knee Lifter Connection Lever Hinge Screw .....
227308	11125	Knee Lifter Connection Lever Lifting Rod with 202302 .....
202302	12306	Knee Lifter Connection Lever Lifting Rod Cotter Pin .....
227302	11125	Knee Lifter Lifting Lever .....
200262H	12306	" " " " Hinge Screw .....
213759	13138	Knife .....
213130	11140	" Adjusting Block, in gauges $\frac{1}{8}$ , $\frac{3}{16}$ , $\frac{1}{4}$ and $\frac{5}{16}$ inch .....
204447	13137	Knife Bar with 200094F .....
204448	---	" " 204447 with 204452 ....
215953	13139	" " Bell Crank with 200337c, 201528H, 204349 and 204449 .....
204449	11142	Knife Bar Bell Crank Bearing ...
201481c	13136	" " " " Driving Screw Stud .....
201528H	11801	Knife Bar Bell Crank Driving Screw Stud Nut .....
200391c	11140	Knife Bar Bell Crank Position Screw .....

No.	Plate	Name
200337c	13136	Knife Bar Bell Crank Stop Screw
201528H	11801	" " " " " " " Nut .....
204370	11142	Knife Bar Driving Cam with 200347c and 200434c .....
200434c	11142	Knife Bar Driving Cam Position Screw .....
201808	---	Knife Bar Driving Cam Roller and Stud .....
201842	11142	Knife Bar Driving Cam Roller and Stud 201808 with 201528H .....
201528H	11801	Knife Bar Driving Cam Roller and Stud Nut .....
200347c	12376	Knife Bar Driving Cam Set Screw
204452	11140	" Holder .....
200094F	11140	" " Screw .....
200126D	11140	" Screw, for $\frac{1}{8}$ in. gauge block
200076D	11140	" " " $\frac{1}{8}$ and $\frac{3}{16}$ in. gauge blocks .....
200056D	10884	Knife Screw, for $\frac{1}{4}$ and $\frac{3}{8}$ in. gauge blocks .....
203715	11802	Needle Bar (hollow) .....
231390	11802	" " " " .....
204248	12307	" " Connecting Link ....
200658c	12307	" " " " Hinge Screw Stud .....
201519E	12307	Needle Bar Connecting Link Hinge Screw Stud Nut .....
204249	12308	Needle Bar Connecting Stud with 200072c and 202277 .....
202277	---	Needle Bar Connecting Stud Oil Packing (wick) .....
200072c	12308	Needle Bar Connecting Stud Pinch Screw .....
204326	---	Needle Bar Packing Cord (2) ....
200868	11140	" " Screw Bushing (lower)
200867B	11140	" " " " (upper)
229662	13140	" Holder, in gauges $\frac{3}{32}$ , $\frac{1}{8}$ , $\frac{5}{32}$ , $\frac{3}{16}$ and $\frac{1}{2}$ in., for trimming .045, .060, .085 and .125 in., with 200141F, 200389c and two 200581H, for Needle Bar 203715 .....
231400	13140	Needle Holder, in gauges from $\frac{1}{4}$ to $\frac{3}{4}$ in., in steps of $\frac{1}{8}$ in., for trimming .045, .060 and .085 in., with 201030F and two 200389c, for Needle Bar 231390 .....
200581H	12309	Needle Holder Screw .....
201030F	13136	" " " " .....

## Parts for Machine No. 22w38

No.	Plate	Name
200141F	12332	Needle Set Screw .....
200389c	13136	" " " .....
204251	12334	Presser Bar (hollow) with 200074F
204252	12308	" " Lifter .....
200550c	12311	" " " Hinge Screw ...
204455	11140	" " Lifting Bracket with 200387c .....
204254	12307	Presser Bar Lifting Bracket Posi- tion Guide .....
200362c	12311	Presser Bar Lifting Bracket Posi- tion Guide Set Screw .....
200387c	12376	Presser Bar Lifting Bracket Set Screw .....
204327	12306	Presser Bar Packing Washer (felt)
200868	11140	" " Screw Bushing (lower)
204255	13135	" " Spring .....
200493B	11140	" " Thumb Screw (pres- sure regulating) .....
229123	13144	Presser Foot, 46 needle hole, in gauges from $\frac{1}{16}$ to $\frac{1}{8}$ in., in steps of $\frac{1}{32}$ inch .....
229124	13144	Presser Foot, 46 needle hole, in gauges from $\frac{1}{16}$ to $\frac{1}{8}$ in., in steps of $\frac{1}{32}$ inch .....
200074F	12308	Presser Foot Screw .....
212920	—	Take-up Cam with 200335c and 200430c .....
203268	12334	Take-up Cam 212920 with 200383c, 200658c and 201519c .....
200430c	12311	Take-up Cam Position Screw ....
200383c	12311	" " " " Check Screw .....
200335c	12311	Take-up Cam Set Screw .....
204553	12386	" Lever .....
206601	—	" " 204553 with 204263 ..
204263	12386	" " Bearing with 204264 ..
204264	12306	" " " Position Pin ..
200042F	12311	" " " Screw .....
201816	12307	" " Roller .....
204554	12386	Take-up Lever complete, Nos. 200042F, 201816 and 206601 .....
202402	12309	Tension Disc .....
202090	12309	" " Position Pin .....
204555	12332	" Release Lever .....
200309E	10483	" " " Screw .....
202075	12309	" " Plunger .....
204456	11803	" " Slide .....
204457	11142	" " " Spring .....
202407	10881	" Spring .....
200632B	12309	" Stud .....

## Parts for Machine No. 22w38

No.	Plate	Name
200397H	12309	Tension Stud Set Screw .....
201572B	10881	" Thumb Nut .....
204271	12309	" Washer .....
204272	12309	Tension complete, Nos. 200632B, 201572B, 202075, 202407, 204271 and two 202402 .....
204458	11140	Thread Controller Adjusting Collar with 200684H (for Presser Bar) ..
200684H	12308	Thread Controller Adjusting Collar Screw .....
204274	12309	Thread Controller Plate .....
200577H	12311	" " " Screw ....
202098	12309	" " Roller .....
204275	12309	" " " Guard .....
202084	12309	" " " " Washer
200300c	12309	" " " Screw .....
204276	12309	" " Spring .....
204333	12309	" " " Guard .....
200581H	12309	" " " " Screw ..
204277	12309	" " " Stop .....
204278	12309	" " " " Driving Gear .....
200319c	12309	Thread Controller Spring Stop Driv- ing Gear Hinge Screw .....
200135E	12309	Thread Controller Spring Stop Screw .....
204279	12309	Thread Controller Spring Stud with 204925 .....
200366H	12309	Thread Controller Spring Stud Set Screw .....
204925	12306	Thread Controller Spring Stud Washer .....
205987	12309	Thread Controller complete, Nos. 200300c, 200581H, 202084, 202098, 204274, 204275 and 204333 .....
204280	12309	Thread Controller and Spring com- plete, Nos. 204276 and 205987 ..
204459	11803	Thread Guide .....
203313	12386	" " .....
204281	12309	" Retainer Guide Wire .....
202091	12309	" " Sleeve .....
202092	12309	" " Spring .....
204058	12309	" " Stud .....
200368H	12309	" " " Set Screw ....
204059	12309	Thread Retainer complete, Nos. 202091, 202092 and 204058 .....





No.	Plate	Name
203214	12312	Bobbin Case Tension Spring .....
200984c	12312	" " " " Regulat- ing Screw .....
200594c	12312	Bobbin Case Tension Spring Screw
203215	12312	" " Thread Guide .....
200594c	12312	" " " " Screw ..
203216	12312	" " Washer (cloth) .....
203217	12312	Bobbin Case complete, Nos. 203209 and 203210 .....
204533	12333	Face Plate with 200366n, 204730, two each 200368n, 202090, 204281 and three 200397n .....
200053c	12311	Face Plate Screw .....
204730	12386	" " Thread Guide .....
200397n	12309	" " " " Set Screw
204874	12333	Face Plate complete, Nos. 200135e, 200319c, 200577n, 204277 to 204280, 204533, 204555, two each 200309e, 204059 and 204272 .....
203303	12334	Feed Bar with 204189 .....
203309	—	" " 203303 with 200214n, 201525e and 204200 .....
200214e	12386	Feed Bar Hinge Screw .....
201525e	12386	" " " " Nut .....
214424	11142	" " Spring .....
204189	12306	" " " Hook .....
211298	13142	" Dog, for 211191 .....
212571	11813	" " " 211050 .....
236411	13143	" " " 211054 .....
236419	11813	" " " 211058 .....
236423	13143	" " " 211061 .....
212474	11814	" " " 211064 .....
212169	11814	" " " 211067 .....
211674	12092	" " " 211672 .....
211679	12093	" " " 211677 .....
211685	12093	" " " 211682 .....
200106e	12311	" " Screw (2) .....
200075e	11801	" " Support Screw .....
201535e	11801	" " " " Nut .....
203233	12305	" Driving Cam with 200382c and 200437c .....
204192	—	Feed Driving Cam Fork Lever with 204195 and 204293 .....
204193	12334	Feed Driving Cam Fork Lever Con- nection with 200668c and 201525e
204194	12306	Feed Driving Cam Fork Lever Con- nection Clamp with 200031e .....
200031f	12311	Feed Driving Cam Fork Lever Con- nection Clamp Pinch Screw .....

No.	Plate	Name
200668c	12386	Feed Driving Cam Fork Lever Con- nection Clamp Screw Stud .....
201525e	12386	Feed Driving Cam Fork Lever Con- nection Clamp Screw Stud Nut ..
200002e	12332	Feed Driving Cam Fork Lever Con- nection Hinge Screw .....
201522e	12332	Feed Driving Cam Fork Lever Con- nection Hinge Screw Nut .....
*204195	—	Feed Driving Cam Fork Lever Shaft .....
204197	12306	Feed Driving Cam Fork Lever Shaft Collar with 200113e .....
200113e	12308	Feed Driving Cam Fork Lever Shaft Collar Set Screw .....
204293	12308	Feed Driving Cam Fork Lever Shaft Position Pin .....
204196	12307	Feed Driving Cam Fork Lever Shaft Sleeve (split) .....
200043c	12311	Feed Driving Cam Fork Lever Shaft Sleeve Set Screw .....
201524e	12332	Feed Driving Cam Fork Lever Shaft Sleeve Set Screw Nut .....
204198	12334	Feed Driving Cam Fork Lever com- plete, Nos. 204192 and 204194 ..
200437c	12311	Feed Driving Cam Position Screw
200382c	11142	" " " " Set Screw .....
204294	12333	" " Rock Shaft .....
206555	—	" " " " 204294 with 200002e, 201522e and 204193 .....
202305	12307	Feed Driving Rock Shaft Center (2)
200043c	12311	" " " " " Set Screw (2) .....
204200	12305	Feed Driving Rock Shaft Crank with 204189 (on left side) and two 200383c .....
200383c	12311	Feed Driving Rock Shaft Crank Set Screw .....
203235	12308	Feed Lifting Cam with 202126 .....
204202	12308	" " " Fork with 200027e
200027e	12332	" " " " Pinch Screw
202126	12308	" " " Position Pin ...
200045e	12332	" " " Screw .....
203305	12334	" " Rock Shaft .....
203315	12334	" " " " 203305 with 203238 .....
202305	12307	Feed Lifting Rock Shaft Center (2)
200043c	12311	" " " " " Set Screw (2) .....
202276	12308	Feed Lifting Rock Shaft Slide Block .....



No.	Plate	Name
203308	12335	Hook Saddle complete, Nos. 200555H, 203241, 203254, 203290 and 203307 .....
203462	---	Hook Saddle Combination (left and right) complete, Nos. two 203308 .....
208490	---	Knee Lifter Connection Lever .....
227312	---	" " " " 208490 with 227303, 227308 and two 200262H .....
200262H	12306	Knee Lifter Connection Lever Hinge Screw .....
227308	11125	Knee Lifter Connection Lever Lifting Rod with 202302 .....
202302	12306	Knee Lifter Connection Lever Lifting Rod Cotter Pin .....
227303	11125	Knee Lifter Lifting Lever .....
200262H	12306	" " " " Hinge Screw .....
231390	11802	Needle Bar (hollow) .....
204248	12307	" " Connecting Link .....
200658C	12307	" " " " Hinge Screw Stud .....
201519E	12307	Needle Bar Connecting Link Hinge Screw Stud Nut .....
204249	12308	Needle Bar Connecting Stud with 200072C and 202277 .....
202277	---	Needle Bar Connecting Stud Oil Packing (wick) .....
200072C	12308	Needle Bar Connecting Stud Pinch Screw .....
204326	---	Needle Bar Packing Cord (2) .....
200504E	12386	" " Screw Bushing (lower) .....
200503B	12386	" " " " (upper) .....
231383	13140	" Holder, in gauges from $\frac{1}{4}$ to $\frac{1}{2}$ in., in steps of $\frac{1}{16}$ in., with 201030F and two 200141F .....
231385	13140	Needle Holder, in gauges from $\frac{1}{4}$ to $\frac{3}{4}$ in., in steps of $\frac{1}{16}$ in., with 201030F and two 200141F .....
201030F	13136	Needle Holder Screw .....
200141F	12332	" Set Screw .....
204251	12334	Presser Bar (hollow) with 200074F .....
204252	12308	" " Lifter .....
200550C	12311	" " " Hinge Screw .....
204253	12308	" " Lifting Bracket with 200086C .....
200086C	12308	Presser Bar Lifting Bracket Pinch Screw .....

No.	Plate	Name
204254	12307	Presser Bar Lifting Bracket Position Guide .....
200362C	12311	Presser Bar Lifting Bracket Position Guide Set Screw .....
204327	12306	Presser Bar Packing Washer (felt) .....
200504E	12386	" " Screw Bushing (lower) .....
204258	12386	" " Spring (heavy) .....
200491B	12305	" " Thumb Screw (pressure regulating) .....
229102	12332	Presser Foot, 46 needle hole, in gauges $\frac{1}{4}$ , $\frac{5}{16}$ , $\frac{3}{8}$ and $\frac{7}{16}$ inch .....
229103	14004	Presser Foot, 46 needle hole, in gauges $\frac{1}{4}$ , $\frac{5}{16}$ and $\frac{3}{8}$ inch .....
229104	12164	Presser Foot, 46 needle hole, in gauges from $\frac{1}{16}$ to $\frac{1}{2}$ in., in steps of $\frac{1}{16}$ inch .....
229105	12164	Presser Foot, 46 needle hole, in gauges $\frac{1}{16}$ and $\frac{3}{16}$ inch .....
229106	12164	Presser Foot, 46 needle hole, in gauges $\frac{1}{16}$ , $\frac{3}{16}$ , $\frac{1}{4}$ and $\frac{5}{16}$ inch .....
229107	12164	Presser Foot, 46 needle hole, in gauges $\frac{3}{16}$ and $\frac{1}{2}$ inch .....
200074F	12308	Presser Foot Screw .....
226057	11018	Quilter Bracket with 200481B .....
200118E	11803	" " Screw .....
200481B	11018	" Thumb Screw .....
212920	---	Take-up Cam with 200335C and 200430C .....
203268	12334	Take-up Cam 212920 with 200383C, 200658C and 201519E .....
203172	12307	Take-up Cam Friction Washer .....
200430C	12311	" " Position Screw .....
200383C	12311	" " " " Check Screw .....
200335C	12311	Take-up Cam Set Screw .....
204553	12386	" Lever .....
206601	---	" " 204553 with 204263 .....
204263	12386	" " Bearing with 204264 .....
204264	12306	" " " Position Pin .....
200042F	12311	" " " Screw .....
201816	12307	" " Roller .....
204554	12386	Take-up Lever complete, Nos. 200042F, 201816 and 206601 .....
202402	12309	Tension Disc .....
202090	12309	" " Position Pin .....
204555	12332	" Release Lever .....
200309E	10483	" " " Screw .....
202075	12309	" " Plunger .....
208489	---	" " Slide .....
206608	13136	" " " Spring .....

No.	Plate	Name
202407	10881	Tension Spring .....
200632B	12309	" Stud .....
200397H	12309	" " Set Screw .....
201572B	10881	" Thumb Nut .....
204271	12309	" Washer .....
204272	12309	Tension complete, Nos. 200632B, 201572B, 202075, 202407, 204271 and two 202402 .....
204273	12308	Thread Controller Adjusting Collar with 200684H (for Presser Bar) ..
200684H	12308	Thread Controller Adjusting Collar Screw .....
204274	12309	Thread Controller Plate .....
200577H	12311	" " " Screw .....
202098	12309	" " Roller .....
204275	12309	" " " Guard .....
202084	12309	" " " Washer .....
200300c	12309	" " " Screw .....
204276	12309	" " Spring .....
204333	12309	" " " Guard .....
200581H	12309	" " " " Screw .....
204277	12309	" " " Stop .....
204278	12309	" " " " Driving Gear .....
200319c	12309	Thread Controller Spring Stop Driv- ing Gear Hinge Screw .....
200135E	12309	Thread Controller Spring Stop Screw .....
204279	12309	Thread Controller Spring Stud with 204925 .....
200366H	12309	Thread Controller Spring Stud Set Screw .....
204925	12306	Thread Controller Spring Stud Washer .....
205987	12309	Thread Controller complete, Nos. 200300c, 200581H, 202084, 202098, 204274, 204275 and 204333 .....
204280	12309	Thread Controller and Spring com- plete, Nos. 204276 and 205987 ..
203313	12386	Thread Guide .....
204556	12386	" " .....
204281	12309	" Retainer Guide Wire .....
202091	12309	" " Sleeve .....
202092	12309	" " Spring .....
204058	12309	" " Stud .....
200368H	12309	" " " Set Screw .....
204059	12309	Thread Retainer complete, Nos. 202091, 202092 and 204058 .....

No.	Plate	Name
211191	13148	Throat Plate, 46 needle hole, for needle sizes 16 and 18, in $\frac{1}{8}$ in. gauge, for 211298 .....
211050	11813	Throat Plate, 46 needle hole, for needle sizes 16 and 18, in gauges $\frac{3}{8}$ and $\frac{5}{8}$ in., for 212571 .....
211054	11813	Throat Plate, 46 needle hole, for needle sizes 16 and 18, in gauges $\frac{3}{8}$ and $\frac{1}{2}$ in., for 236411 .....
211058	11813	Throat Plate, 46 needle hole, for needle sizes 16 and 18, in gauges $\frac{3}{8}$ and $\frac{5}{8}$ in., for 236419 .....
211061	11814	Throat Plate, 46 needle hole, for needle sizes 16 and 18, in gauges $\frac{1}{2}$ and $\frac{3}{4}$ in., for 236423 .....
211064	11814	Throat Plate, 46 needle hole, for needle sizes 16 and 18, in gauges $\frac{1}{2}$ and $\frac{3}{4}$ in., for 212474 .....
211067	11814	Throat Plate, 46 needle hole, for needle sizes 16 and 18, in gauges $\frac{1}{2}$ and $\frac{1}{2}$ in., for 212169 .....
211672	12092	Throat Plate, 46 needle hole, for needle sizes 16 and 18, in gauges $\frac{1}{2}$ , $\frac{3}{8}$ and $\frac{1}{2}$ in., for 211674 .....
211677	12093	Throat Plate, 46 needle hole, for needle sizes 16 and 18, in gauges $\frac{5}{8}$ , $\frac{3}{4}$ and $\frac{1}{2}$ in., for 211679 .....
211682	12093	Throat Plate, 46 needle hole, for needle sizes 16 and 18, in gauges $\frac{3}{8}$ and $\frac{1}{2}$ in., for 211685 .....
200161D	12319	Throat Plate Clamp Screw .....
202062	12308	" " Position Pin .....
200577H	12311	" " Screw .....

**LIST OF PARTS COMPLETE**  
FOR  
**MACHINE No. 22w113**

DROP FEED. ALTERNATING PRESSERS

For Tailoring

In gauges from  $\frac{1}{8}$  to  $\frac{3}{4}$  inch

No.	Plate	Name
*204497	----	Arm with 200439c, 202036 and 204705 .....
204163	12305	Arm Cap .....
200278u	12311	" " Screw .....
202248	12307	" " Washer .....
200963e	12311	" Screw (3) .....
202005	12308	" " Washer (3) .....
213010	13137	" Shaft .....
204705	12334	" " Bushing (front) .....
200439c	12311	" " " Position Screw ..
204440	12333	" " Connection with four 200054E (2) .....
200054E	12307	Arm Shaft Connection Screw .....
202299	----	" " Oil Packing (wick) (2) .....
204805	13329	Balance Wheel, 5 $\frac{1}{2}$ in. diam. (belt groove 2 $\frac{3}{4}$ in. diam.), with 200328c and 200335c .....
200062u	12311	Balance Wheel Adjusting Screw ..
200328c	12311	" " Position Screw .....
200335c	12311	" " Set Screw .....
*213052	----	Bed with 202062, 203248, 203249, two each 200362c, 200516e, 200840e and 202299 .....
202258	12345	Bed Hinge Connection (2) .....
200570E	12311	" " " Screw (4) .....
203329	11802	" Slide (back) .....
203301	12334	" " (front) .....
203208	12312	Bobbin (2) .....
203210	12312	" Case Base with 202056, 203211 to 203213 and 203216 .....
203211	12312	Bobbin Case Base Latch .....
*202056	----	" " " " Pin .....
203212	12312	" " " " Plunger ..
203213	12312	" " " " Spring ..

No.	Plate	Name
203209	12312	Bobbin Case Cap with 200984c, 203214, 203215 and two 200594c..
203214	12312	Bobbin Case Tension Spring .....
200984c	12312	" " " " Regulat- ing Screw .....
200594c	12312	Bobbin Case Tension Spring Screw
203215	12312	" " Thread Guide .....
200594c	12312	" " " " Screw ..
203216	12312	" " Washer (cloth) .....
203217	12312	Bobbin Case complete, Nos. 203209 and 203210 .....
213746	11804	Face Plate with 200366u, 202087, 204730, two each 200368u, 202090, 204281 and three 200397u .....
200053c	12311	Face Plate Screw .....
204730	12386	" " Thread Guide .....
200397u	12309	" " " " Set Screw
213747	11804	Face Plate complete, Nos. 200577u, 202088, 203766, 204280, 213746, two each 200309e, 204059 and 204272 .....
203303	12334	Feed Bar with 204189 .....
203309	----	" " 203303 with 200214e, 201525e and 204200 .....
200214e	12386	Feed Bar Hinge Screw .....
201525e	12386	" " " " Nut .....
214424	11142	" " Spring .....
204189	12306	" " " Hook .....
211652	13141	" Dog, for 211859 .....
212571	11813	" " " 211050 .....
236411	13143	" " " 211054 .....
236419	11813	" " " 211058 .....
236423	13143	" " " 211061 .....
212474	11814	" " " 211064 .....
212169	11814	" " " 211067 .....
211674	12092	" " " 211672 .....
211679	12093	" " " 211677 .....
211685	12093	" " " 211682 .....
200106e	12311	" " Screw (2) .....
200075e	11801	" " Support Screw .....
201535e	11801	" " " " Nut .....
203233	12305	" Driving Cam with 200382c and 200437c .....
204192	----	Feed Driving Cam Fork Lever with 204195 and 204293 .....
204193	12334	Feed Driving Cam Fork Lever Con- nection with 200668c and 201525e
204194	12306	Feed Driving Cam Fork Lever Con- nection Clamp with 200031e .....

No.	Plate	Name
200031F	12311	Feed Driving Cam Fork Lever Connection Clamp Pinch Screw ....
200668C	12386	Feed Driving Cam Fork Lever Connection Clamp Screw Stud ....
201525E	12386	Feed Driving Cam Fork Lever Connection Clamp Screw Stud Nut ..
200002E	12332	Feed Driving Cam Fork Lever Connection Hinge Screw .....
201522E	12332	Feed Driving Cam Fork Lever Connection Hinge Screw Nut .....
*204195	---	Feed Driving Cam Fork Lever Shaft .....
204197	12306	Feed Driving Cam Fork Lever Shaft Collar with 200113n .....
200113F	12308	Feed Driving Cam Fork Lever Shaft Collar Set Screw .....
204293	12308	Feed Driving Cam Fork Lever Shaft Position Pin .....
204196	12307	Feed Driving Cam Fork Lever Shaft Sleeve (split) .....
200043C	12311	Feed Driving Cam Fork Lever Shaft Sleeve Set Screw .....
201524E	12332	Feed Driving Cam Fork Lever Shaft Sleeve Set Screw Nut ...
204198	12334	Feed Driving Cam Fork Lever complete, Nos. 204192 and 204194 ..
200437C	12311	Feed Driving Cam Position Screw
200382C	11142	" " " Set Screw .....
204294	12333	" " Rock Shaft .....
206555	---	" " " " 204294 with 200002E, 201522E and 204193 ....
202305	12307	Feed Driving Rock Shaft Center (2)
200043C	12311	" " " " " Set Screw (2) .....
204200	12305	Feed Driving Rock Shaft Crank with 204189 (on left side) and two 200383C .....
200383C	12311	Feed Driving Rock Shaft Crank Set Screw .....
203235	12308	Feed Lifting Cam with 202126 ...
204202	12308	" " " Fork with 200027E
200027E	12332	" " " Pinch Screw
202126	12308	" " " Position Pin ...
200045E	12332	" " " Screw .....
203305	12334	" " Rock Shaft .....
203315	12334	" " " " 203305 with 203238 .....
202305	12307	Feed Lifting Rock Shaft Center (2)
200043C	12311	" " " " " Set Screw (2) .....

No.	Plate	Name
202276	12308	Feed Lifting Rock Shaft Slide Block .....
203238	12308	Feed Lifting Rock Shaft Slide Block 202276 with 200243E and 201531E .....
200243E	12332	Feed Lifting Rock Shaft Slide Block Hinge Screw .....
201531E	12308	Feed Lifting Rock Shaft Slide Block Hinge Screw Nut .....
204206	12306	Feed Regulating Handle .....
204207	12334	" " " 204206 with 200098E, 202622, 204208 to 204210, 204213 and 204925 .....
204208	12307	Feed Regulating Handle Adjustable Stop .....
200098E	12307	Feed Regulating Handle Adjustable Stop Screw .....
204925	12306	Feed Regulating Handle Adjustable Stop Screw Washer .....
204209	12307	Feed Regulating Handle Position Pin .....
204210	12306	Feed Regulating Handle Shaft ....
204211	12306	" " " " Crank with 200098E .....
204212	12307	Feed Regulating Handle Shaft Crank Link .....
200271E	12311	Feed Regulating Handle Shaft Crank Link Hinge Screw (lower)
200291E	12307	Feed Regulating Handle Shaft Crank Link Hinge Screw (upper)
200098E	12307	Feed Regulating Handle Shaft Crank Set Screw .....
204213	12307	Feed Regulating Handle Shaft Sleeve (split) .....
200362C	12311	Feed Regulating Handle Shaft Sleeve Set Screw .....
202622	12306	Feed Regulating Handle Shaft Sleeve Washer .....
202036	12332	Feed Regulating Handle Stop Pin
204214	---	Feed Regulating Handle complete, Nos. 200291E, 204207, 204211 and 204212 .....
*203239	---	Hook (sewing) .....
203240	12312	" 203239 with 201253E, 201376E and 203251 .....
203290	12312	Hook and Robbin Case complete, Nos. 203217 and 203240 .....
203241	11007	Hook Bevel Gear Socket, 24 teeth...
200555n	11007	" " " " Screw ....

No.	Plate	Name
203242	11007	Hook Bevel Pinion, 24 teeth, with two 200383c (2) .....
200383c	12311	Hook Bevel Pinion Set Screw ....
203306	12333	" Counter Shaft .....
203244	11007	" " " Collar with two 200393c .....
200393c	11007	Hook Counter Shaft Collar Set Screw .....
203245	11007	Hook Counter Shaft Driving Gear, 44 teeth, with 200362c and 200439c .....
213154	12305	Hook Counter Shaft Driving Gear 203245 with 200045E and 203235 .....
200439c	12311	Hook Counter Shaft Driving Gear Position Screw .....
200362c	12311	Hook Counter Shaft Driving Gear Set Screw .....
203246	11007	Hook Counter Shaft Gear, 22 teeth, with two 200383c .....
200383c	12311	Hook Counter Shaft Gear Set Screw .....
202299	---	Hook Counter Shaft Oil Packing (wick) .....
200840E	11007	Hook Counter Shaft Oil Packing (wick) Stop Screw .....
213624	12333	Hook Driving Shaft .....
203248	12334	" " " Bearing with 202299 .....
202299	---	Hook Driving Shaft Bearing Oil Packing (wick) .....
202126	12308	Hook Driving Shaft Bearing Position Pin .....
200516E	12311	Hook Driving Shaft Bearing Screw .....
203249	11007	" " " Bushing (eccentric) .....
202299	---	Hook Driving Shaft Bushing Oil Packing (wick) .....
200362c	12311	Hook Driving Shaft Bushing Set Screw .....
213141	11801	Hook Driving Shaft Collar with two 200393c .....
200393c	11007	Hook Driving Shaft Collar Set Screw .....
203251	12312	Hook Gib .....
201376F	13136	" " Hinge Screw .....
201253F	13136	" " Screw .....
203307	12335	" Saddle (left or right) with 202299 .....
202299	---	Hook Saddle Oil Packing (wick) .....
200006E	11007	" " Screw (4) .....
225585	11007	" " " Washer (4) .....

No.	Plate	Name
203254	12312	Hook Washer .....
203308	12335	Hook Saddle complete, Nos. 200555n, 203241, 203254, 203290 and 203307 .....
203462	---	Hook Saddle Combination (left and right) complete, Nos. two 203398 .....
208490	---	Knee Lifter Connection Lever ....
227312	---	" " " " 208490 with 227303, 227308 and two 200262n .....
200262n	12806	Knee Lifter Connection Lever Hinge Screw .....
227308	11125	Knee Lifter Connection Lever Lifting Rod with 202392 .....
202302	12306	Knee Lifter Connection Lever Lifting Rod Cotter Pin .....
227303	11125	Knee Lifter Lifting Lever .....
200262n	12306	" " " " Hinge Screw .....
204475	10483	Lifting Lever with 200122n .....
208389	---	" " 204475 with 200935E, 201534E, 204478 and 206659 .....
213004	11018	Lifting Lever Driving Crank .....
204478	10483	" " " " Link ...
200122n	10483	" " " " " Stop Screw .....
200400c	11018	Lifting Lever Driving Crank Position Screw .....
200387c	12376	Lifting Lever Driving Crank Position Screw Set Screw .....
204479	11801	Lifting Lever Driving Crank Position Screw Set Screw Packing (brass) .....
200181D	10483	Lifting Lever Stop Screw .....
204480	10483	" " Stud Lifting Bracket with 200086c and 200181D .....
208390	---	Lifting Lever Stud Lifting Bracket 204480 with 208389 .....
200086c	12308	Lifting Lever Stud Lifting Bracket Pinch Screw .....
229641	14004	Lifting Presser Foot, 46 needle hole, in gauges $\frac{1}{4}$ and $\frac{3}{8}$ in., for 206671 .....
229642	14004	Lifting Presser Foot, 46 needle hole, in gauges $\frac{5}{16}$ and $\frac{3}{4}$ in., for 206661 .....
229650	14067	Lifting Presser Foot, 46 needle hole, in gauges $\frac{1}{2}$ , $\frac{5}{8}$ , $\frac{3}{4}$ , $\frac{7}{8}$ and $1$ in., for 229651 .....



No.	Plate	Name
229652	14067	Lifting Presser Foot, 46 needle hole, in gauges from $\frac{13}{16}$ to $\frac{5}{8}$ in., in steps of $\frac{1}{16}$ in., for 229653 .....
229654	14004	Lifting Presser Foot, 46 needle hole, in gauges $\frac{11}{16}$ , $\frac{11}{16}$ , $\frac{11}{16}$ and $\frac{3}{4}$ in., for 229655 .....
200074F	12308	Lifting Presser Foot Screw .....
231390	11802	Needle Bar (hollow) .....
204418	-----	" " Connecting Link .....
204249	12308	" " " Stud with 200072c and 202277 .....
202277	-----	Needle Bar Connecting Stud Oil Packing (wick) .....
200072c	12308	Needle Bar Connecting Stud Pinch Screw .....
204326	-----	Needle Bar Packing Cord (2) .....
200504E	12386	" " Screw Bushing (lower)
200503B	12386	" " " " (upper)
231383	13140	" Holder, in gauges from $\frac{1}{2}$ to $\frac{1}{2}$ in., in steps of $\frac{1}{16}$ in., with 201030F and two 200141F .....
231385	13140	Needle Holder, in gauges from $\frac{1}{2}$ to $\frac{3}{4}$ in., in steps of $\frac{1}{16}$ in., with 201030F and two 200141F .....
201030F	13136	Needle Holder Screw .....
200141F	12332	" Set Screw .....
204251	12334	Presser Bar (hollow) with 200074F
204252	12308	" " Lifter .....
200550c	12311	" " " Hinge Screw .....
204481	13135	" " Lifting Bracket Position Guide .....
200362c	12311	Presser Bar Lifting Bracket Position Guide Set Screw .....
204327	12306	Presser Bar Packing Washer (felt)
200504E	12386	" " Screw Bushing (lower)
204482	11142	" " Spring .....
200491B	12305	" " Thumb Screw (pressure regulating) .....
201506B	11018	Presser Bar Thumb Screw Check Nut .....
213925	13329	Take-up Cam with 200347c, 200383c, 200387c, 200400c, 200430c and 204479 .....
203172	12307	Take-up Cam Friction Washer .....
200430c	12311	" " Position Screw .....
200383c	12311	" " " " Check Screw .....

No.	Plate	Name
200347c	12376	Take-up Cam Set Screw .....
213005	11018	Take-up Cam complete, Nos. 204418, 213004 and 213925 .....
204553	12386	Take-up Lever .....
206601	-----	" " 204553 with 204263..
204263	12386	" " Bearing with 204264
204264	12306	" " " Position Pin..
200042F	12311	" " " Screw .....
201816	12307	" " Roller .....
204554	12386	Take-up Lever complete, Nos. 200042F, 201816 and 206601 .....
202402	12309	Tension Disc .....
202090	12309	" " Position Pin .....
203766	11803	" Release Lever .....
200309E	10483	" " " Screw .....
202075	12309	" " Plunger .....
206530	13136	" " Slide .....
206608	13136	" " " Spring .....
202407	10881	" Spring .....
200632B	12309	" Stud .....
200397H	12309	" " Set Screw .....
201572B	10881	" Thumb Nut .....
204271	12309	" Washer .....
204272	12309	Tension complete, Nos. 200632a, 201572B, 202075, 202407, 204271 and two 202402 .....
204274	12309	Thread Controller Plate .....
200577H	12311	" " " Screw .....
202098	12309	" " Roller .....
204275	12309	" " " Guard .....
202084	12309	" " " " Washer .....
200300c	12309	" " " Screw .....
204276	12309	" " Spring .....
204333	12309	" " " Guard .....
200581H	12309	" " " " Screw..
202087	13136	" " " Stop .....
202088	10483	" " " Stud with 204925 .....
200366H	12309	Thread Controller Spring Stud Set Screw .....
204925	12306	Thread Controller Spring Stud Washer .....
205987	12309	Thread Controller complete, Nos. 200300c, 200581H, 202084, 202098, 204274, 204275 and 204333 .....
204280	12309	Thread Controller and Spring complete, Nos. 204276 and 205987 ..
204556	12386	Thread Guide .....



**LIST OF PARTS COMPLETE**  
**FOR**  
**MACHINE No. 22w133**

**DROP FEED**

For Ornamenting Shirt Waists, Skirts, Cloaks, Etc.

With the Briar Stitch

In gauges  $\frac{1}{4}$  and  $\frac{3}{8}$  inch

No.	Plate	Name
*213060	—	Arm with 200439c, 202036 and 204705 .....
213062	11804	Arm Bracket with 200113F .....
200224H	12306	" " Screw .....
213078	11804	" " Shaft .....
213079	11041	" " " Bevel Gear with two 200387c .....
200387c	12376	Arm Bracket Shaft Bevel Gear Set Screw .....
213085	11805	Arm Bracket Shaft Gear (4 stitch) with two 200387c .....
200387c	12376	Arm Bracket Shaft Gear Set Screw
204163	12305	" Cap .....
200278H	12311	" " Screw .....
202248	12307	" " " Washer .....
200963E	12311	" " Screw (3) .....
202005	12308	" " Washer (3) .....
213622	12333	" Shaft .....
204705	12334	" " Bushing (front) .....
200439c	12311	" " " Position Screw ..
204440	12333	" " Connection with four 200054E (2) .....
200054E	12307	Arm Shaft Connection Screw .....
202299	—	" " Oil Packing (wick) (2)
213061	11804	Balance Wheel. 5 $\frac{1}{2}$ in. diam. (bolt groove 2 $\frac{3}{4}$ in. diam.), with 200328c, 200335c and two 200079H .....
200062H	12311	Balance Wheel Adjusting Screw ..
200328c	12311	" " Position Screw ....
200335c	12311	" " Set Screw .....
*213052	—	Bed with 202062, 203248, 203249, two each 200362c, 200516E, 200849E and 202299 .....

No.	Plate	Name
202258	12345	Bed Hinge Connection (2) .....
200570E	12311	" " " Screw (2) ....
203329	11802	" Slide (back) .....
203301	12334	" " (front) .....
203208	12312	Bobbin (2) .....
203210	12312	" Case Base with 202056, 203211 to 203213 and 203216 .....
203211	12312	Bobbin Case Base Latch .....
*202056	—	" " " " Pin .....
203212	12312	" " " " Plunger ..
203213	12312	" " " " Spring .....
203209	12312	" " Cap with 200984c, 203214, 203215 and two 200594c ..
203214	12312	Bobbin Case Tension Spring .....
200984c	12312	" " " " Regulat- ing Screw .....
200594c	12312	Bobbin Case Tension Spring Screw
203215	12312	" " Thread Guide .....
200594c	12312	" " " " Screw ..
203216	—	" " Washer (cloth) .....
203217	12312	Bobbin Case complete, Nos. 203209 and 203210 .....
213088	11041	Cord Carrier .....
213089	11042	" " Lever with two 200110D
213669	11042	" " " 213089 with 213090
213087	11042	" " " Cam with two 200387c .....
200387c	12376	Cord Carrier Lever Cam Set Screw
221435	—	" " " Joint .....
213090	11041	" " " " 221435 with 200682E and 213091 .....
200682E	11041	Cord Carrier Lever Joint Hinge Screw .....
213091	11041	Cord Carrier Lever Joint Swivel with 200086D and 200122D .....
200086D	12308	Cord Carrier Lever Joint Swivel Pinch Screw .....
200122D	10483	Cord Carrier Lever Joint Swivel Screw .....
213065	11042	Cord Carrier Lever Rocker .....
213066	11042	" " " " 213065 with 200220E, 201806 and two 201525E .....
201834	11041	Cord Carrier Lever Rocker Ball Roller .....
201816	12307	Cord Carrier Lever Rocker Roller
201806	11041	" " " " " " 201816 with 200823c .....
200823c	—	Cord Carrier Lever Rocker Roller Screw Stud .....

No.	Plate	Name
201525E	12386	Cord Carrier Lever Rocker Roller and Stud Nut .....
200220E	11041	Cord Carrier Lever Rocker Screw Stud .....
201525E	12386	Cord Carrier Lever Rocker Screw Stud Nut .....
200110D	11803	Cord Carrier Screw .....
213086	11805	Driving Gear (4 stitch) .....
200079H	12311	" " Screw .....
213080	11042	Embroidery Thread Draw Base Plate with 200632B, 202090, 202979 and two 202571 .....
200096D	11868	Embroidery Thread Draw Base Plate Screw .....
213067	11868	Embroidery Thread Draw Lever with 200120C .....
213068	11868	Embroidery Thread Draw Lever Spring .....
213063	11041	Embroidery Thread Draw Lever Spring Bracket .....
213064	11043	Embroidery Thread Draw Lever Spring Bracket Check Lever ...
200918D	11041	Embroidery Thread Draw Lever Spring Bracket Check Lever Hinge Screw .....
214361	11803	Embroidery Thread Draw Lever Spring Bracket Check Lever Spring .....
213057	11041	Embroidery Thread Draw Lever Spring Bracket Check Lever Stop .....
200136D	11041	Embroidery Thread Draw Lever Spring Bracket Check Lever Stop Screw .....
200136D	11041	Embroidery Thread Draw Lever Spring Screw .....
200120C	11041	Embroidery Thread Draw Lever Spring Stop Screw .....
213069	11043	Embroidery Thread Draw Operating Lever .....
200585H	11868	Embroidery Thread Draw Operating Lever Adjusting Screw .....
200288H	11041	Embroidery Thread Draw Operating Lever Screw Stud .....
201537H	12319	Embroidery Thread Draw Operating Lever Screw Stud Nut .....
202402	12309	Embroidery Thread Draw Tension Disc .....
202090	12309	Embroidery Thread Draw Tension Disc Position Pin .....

No.	Plate	Name
213671	11041	Embroidery Thread Draw Tension Spring .....
200632B	12309	Embroidery Thread Draw Tension Stud .....
201572B	10881	Embroidery Thread Draw Tension Thumb Nut .....
204271	12309	Embroidery Thread Draw Tension Washer .....
202571	11029	Embroidery Thread Draw Thread Leader .....
202979	11803	Embroidery Thread Draw Thread Leader .....
213081		Embroidery Thread Draw Attachment complete, Nos. 200288H, 200585H, 200918D, 201537H, 201572B, 204271, 213057, 213063, 213064, 213067 to 213069, 213080, 213671, 214361, two 202402 and three 200136D .....
213058	11804	Face Plate with 200366H, 204730, two each 200368H, 202090, 204281 and three 200397H .....
200053C	12311	Face Plate Screw .....
204730	12386	" " Thread Guide .....
200397H	12309	" " " " Set Screw .....
213059	11804	Face Plate complete, Nos. 200135E, 200319C, 200577H, 204277 to 204280, 204555, 213058, two each 200096D, 200309E, 204059 and 204272 .....
213674	---	Face Plate complete, Nos. 213059 and 213081 .....
203303	12334	Feed Bar with 204189 .....
203309	---	" " 203303 with 200214E, 201525E and 204200 .....
200214E	12386	Feed Bar Hinge Screw .....
201525E	12386	" " " " Nut .....
214124	11142	" " Spring .....
204189	12306	" " " Hook .....
213894	13143	" Dog. for 213893 .....
212836	13142	" " " 211771 .....
200106E	12311	" " Screw (2) .....
200075E	11801	" " Support Screw .....
201535E	11801	" " " " Nut .....
203233	12305	" Driving Cam with 200382C and 200437C .....
204192	---	Feed Driving Cam Fork Lever with 204195 and 204293 .....
204193	12334	Feed Driving Cam Fork Lever Connection with 200668C and 201525E .....

No.	Plate	Name
204194	12306	Feed Driving Cam Fork Lever Connection Clamp with 200031F
200031F	12311	Feed Driving Cam Fork Lever Connection Clamp Pinch Screw
200668c	12386	Feed Driving Cam Fork Lever Connection Clamp Screw Stud
201525E	12386	Feed Driving Cam Fork Lever Connection Clamp Screw Stud Nut
200002E	12332	Feed Driving Cam Fork Lever Connection Hinge Screw
201522E	12332	Feed Driving Cam Fork Lever Connection Hinge Screw Nut
204195	---	Feed Driving Cam Fork Lever Shaft
204197	12306	Feed Driving Cam Fork Lever Shaft Collar with 200113F
200113F	12308	Feed Driving Cam Fork Lever Shaft Collar Set Screw
204293	12308	Feed Driving Cam Fork Lever Shaft Position Pin
204196	12307	Feed Driving Cam Fork Lever Shaft Sleeve (split)
200043c	12311	Feed Driving Cam Fork Lever Shaft Sleeve Set Screw
201524E	12332	Feed Driving Cam Fork Lever Shaft Sleeve Set Screw Nut
204198	12334	Feed Driving Cam Fork Lever complete, Nos. 204192 and 204194
200437c	12311	Feed Driving Cam Position Screw
200382c	11142	" " " Set Screw
204294	12333	" " Rock Shaft
206555	---	" " " 204294 with 200002E, 201522E and 204193
202305	12307	Feed Driving Rock Shaft Center (2)
200043c	12311	" " " " " Set Screw (2)
204200	12305	Feed Driving Rock Shaft Crank with 204189 (on left side) and two 200383c
200383c	12311	Feed Driving Rock Shaft Crank Set Screw
203235	12308	Feed Lifting Cam with 202126
204202	12308	" " " Fork with 200027E
200027E	12332	" " " Pinch Screw
202126	12308	" " " Position Pin
200045E	12332	" " " Screw
203305	12334	" " Rock Shaft
203315	12334	" " " 203305 with 203238

No.	Plate	Name
202305	12307	Feed Lifting Rock Shaft Center (2)
200043c	12311	" " " " " Set Screw (2)
202276	12308	Feed Lifting Rock Shaft Slide Block
203238	12308	" " " " " " 202276 with 200243E and 201531E
200243E	12332	Feed Lifting Rock Shaft Slide Block Hinge Screw
201531E	12308	Feed Lifting Rock Shaft Slide Block Hinge Screw Nut
204206	12306	Feed Regulating Handle
204207	12334	" " " 204206 with 200098E, 202622, 204208 to 204210, 204213 and 204925
204208	12307	Feed Regulating Handle Adjustable Stop
200098E	12307	Feed Regulating Handle Adjustable Stop Screw
204925	12306	Feed Regulating Handle Adjustable Stop Screw Washer
204209	12307	Feed Regulating Handle Position Pin
204210	12306	Feed Regulating Handle Shaft
204211	12306	" " " " Crank with 200098E
204212	12307	Feed Regulating Handle Shaft Crank Link
200271E	12311	Feed Regulating Handle Shaft Crank Link Hinge Screw (lower)
200291E	12307	Feed Regulating Handle Shaft Crank Link Hinge Screw (upper)
200098E	12307	Feed Regulating Handle Shaft Crank Set Screw
204213	12307	Feed Regulating Handle Shaft Sleeve (split)
200362c	12311	Feed Regulating Handle Shaft Sleeve Set Screw
202622	12306	Feed Regulating Handle Shaft Sleeve Washer
202036	12332	Feed Regulating Handle Stop Pin
204214	---	Feed Regulating Handle complete, Nos. 200291E, 204207, 204211 and 204212
203239	---	Hook (sewing)
203240	12312	" 203239 with 201253E, 201376E and 203251
203290	12312	Hook and Bobbin Case complete, Nos. 203217 and 203240

No.	Plate	Name
203241	11007	Hook Bevel Gear Socket, 24 teeth
200555H	11007	" " " " Screw ....
203242	11007	" " Pinion, 24 teeth, with two 200383c (2) .....
200383c	12311	Hook Bevel Pinion Set Screw ....
203306	12333	" Counter Shaft .....
203244	11007	" " " Collar with two 200393c .....
200393c	11007	Hook Counter Shaft Collar Set Screw .....
203245	11007	Hook Counter Shaft Driving Gear, 44 teeth, with 200362c and 200439c
213154	12305	Hook Counter Shaft Driving Gear 203245 with 200045e and 203235..
200439c	12311	Hook Counter Shaft Driving Gear Position Screw .....
200362c	12311	Hook Counter Shaft Driving Gear Set Screw .....
203246	11007	Hook Counter Shaft Gear, 22 teeth, with two 200383c .....
200383c	12311	Hook Counter Shaft Gear Set Screw
202299	---	" " " Oil Packing (wick) .....
200840E	11007	Hook Counter Shaft Oil Packing (wick) Stop Screw .....
213624	12333	Hook Driving Shaft .....
203248	12234	" " " Bearing with 202299 .....
202299	---	Hook Driving Shaft Bearing Oil Packing (wick) .....
202126	12308	Hook Driving Shaft Bearing Posi- tion Pin .....
200516E	12311	Hook Driving Shaft Bearing Screw
203249	11007	" " " Bushing (eccen- tric) .....
202299	---	Hook Driving Shaft Bushing Oil Packing (wick) .....
200362c	12311	Hook Driving Shaft Bushing Set Screw .....
213141	11801	Hook Driving Shaft Shaft Collar with two 200393c .....
200393c	11007	Hook Driving Shaft Collar Set Screw .....
203251	12312	Hook Gib .....
201376F	13136	" " Hinge Screw .....
201253F	13136	" " Screw .....
203307	12335	" Saddle (left or right) with 202299 .....

No.	Plate	Name
202299	---	Hook Saddle Oil Packing (wick) ..
200006E	11007	" " Screw (4) .....
225585	11007	" " " Washer (4) .....
203254	12312	" Washer .....
203308	12335	Hook Saddle complete, Nos. 200555H, 203241, 203254, 203290 and 203307 .....
203462	---	Hook Saddle Combination (left and right) complete, Nos. two 203308
231390	11802	Needle Bar (hollow) .....
204248	12307	" " Connecting Link .....
200658c	12307	" " " " Hinge Screw Stud .....
201519E	12307	Needle Bar Connecting Link Hinge Screw Stud Nut .....
204249	12308	Needle Bar Connecting Stud with 200072c and 202277 .....
202277	---	Needle Bar Connecting Stud Oil Packing (wick) .....
200072c	12308	Needle Bar Connecting Stud Pinch Screw .....
204326	---	Needle Bar Packing Cord (2) ....
200504E	12386	" " Screw Bushing (lower)
200503B	12386	" " " " (upper)
231401	13140	" Holder, in gauges $\frac{1}{4}$ and $\frac{3}{8}$ in., with 201030E and two 20041E ..
201030E	13136	Needle Holder Screw .....
20041E	12332	" Set Screw .....
204251	12334	Presser Bar (hollow) with 200074E
204253	12308	" " Lifting Bracket with 200086c .....
200086c	12308	Presser Bar Lifting Bracket Pinch Screw .....
204254	12307	Presser Bar Lifting Bracket Posi- tion Guide .....
200362c	12311	Presser Bar Lifting Bracket Posi- tion Guide Set Screw .....
204327	12306	Presser Bar Packing Washer (felt)
200504E	12386	" " Screw Bushing (lower)
204255	13135	" " Spring .....
200491B	12305	" " Thumb Screw (pres- sure regulating) .....
213096	11043	Presser Foot, in gauges $\frac{1}{4}$ and $\frac{3}{8}$ inch
200074E	12308	" " Screw .....
213082	11042	" Lifter and Shaft .....
213083	11043	" " Bearing .....
200113E	12308	" " " Screw .....
213084	11042	" " Lever with two 200380c
200380c	12319	" " " Set Screw .....

No.	Plate	Name
213076	11042	Slide Block with 201527E and 201806
213094	11805	" " Cam, $\frac{1}{4}$ in. gauge, with two 200386c .....
213073	13139	Slide Block Cam, $\frac{3}{8}$ in. gauge, with two 200386c .....
200386c	11868	Slide Block Cam Set Screw .....
213070	11805	" " Lever with two 200119B
204923	—	" " " Adjusting Slide Bushing .....
200791E	11803	Slide Block Lever Adjusting Slide Screw .....
201581B	11803	Slide Block Lever Adjusting Slide Wing Nut .....
213723	11044	Slide Block Lever Connection with 213724 and two 200110B .....
200746c	11044	Slide Block Lever Connection Ball Screw Stud .....
*213724	—	Slide Block Lever Connection Ball Screw Stud Cap .....
200110B	11803	Slide Block Lever Connection Ball Screw Stud Cap Screw .....
201531E	12308	Slide Block Lever Connection Ball Screw Stud Nut .....
204924	11044	Slide Block Lever Connection Washer .....
200110B	11803	Slide Block Lever Connection Washer Screw .....
201806	11041	Slide Block Roller and Stud .....
201527E	11043	" " " " " Nut ..
200258D	11803	" " Screw .....
213766	11043	" " " Washer .....
212920	—	Take-up Cam with 200335c and 200430c .....
203268	12334	Take-up Cam 212920 with 200383c, 200658c and 201519E .....
203172	12307	Take-up Cam Friction Washer ....
200430c	12311	" " Position Screw .....
200383c	12311	" " " " Check Screw .....
200335c	12311	Take-up Cam Set Screw .....
204553	12386	" Lever .....
206601	—	" " 204553 with 204263 ..
204263	12386	" " Bearing with 204264 ..
204264	12306	" " " Position Pin ..
200042F	12311	" " " Screw .....
201816	12307	" " Roller .....
204554	12386	Take-up Lever complete, Nos. 200042F, 201816 and 206601 .....

No.	Plate	Name
202402	12309	Tension Disc .....
202090	12309	" " Position Pin .....
204555	12332	" Release Lever .....
200309E	10483	" " " Screw .....
202075	12309	" " Plunger .....
208489	—	" " Slide .....
206608	13136	" " " Spring .....
202407	10881	" Spring .....
200632B	12309	" Stud .....
200397H	12309	" " Set Screw .....
201572B	10881	" Thumb Nut .....
204271	12309	" Washer .....
204272	12309	Tension complete, Nos. 200632B, 201572B, 202075, 202407, 204271 and two 202402 .....
204273	12308	Thread Controller Adjusting Collar with 200684H (for Presser Bar) ..
200684H	12308	Thread Controller Adjusting Collar Screw .....
204274	12309	Thread Controller Plate .....
200577H	12311	" " " Screw ....
202098	12309	" " Roller .....
204275	12309	" " " Guard .....
202084	12309	" " " " Washer .....
200300c	12309	" " " Screw .....
204276	12309	" " Spring .....
204333	12309	" " " Guard .....
200581H	12309	" " " " Screw .....
204277	12309	" " " Stop .....
204278	12309	" " " " Driving Gear .....
200319c	12309	Thread Controller Spring Stop Driving Gear Hinge Screw .....
200135E	12309	Thread Controller Spring Stop Screw .....
204279	12309	Thread Controller Spring Stud with 204925 .....
200366H	12309	Thread Controller Spring Stud Set Screw .....
204925	12306	Thread Controller Spring Stud Washer .....
205987	12309	Thread Controller complete, Nos. 200300c, 200581H, 202084, 202098, 204274, 204275 and 204333 .....
204280	12309	Thread Controller and Spring complete, Nos. 204276 and 205987 ..
203313	12386	Thread Guide .....
204556	12386	" " .....
204281	12309	" Retainer Guide Wire .....
202091	12309	" " Sleeve .....

No.	Plate	Name
202092	12309	Thread Retainer Spring .....
204058	12309	" " Stud .....
200368H	12309	" " Set Screw .....
204059	12309	Thread Retainer complete, Nos. 202091, 202092 and 204058 .....
213893	13149	Throat Plate, 50 needle hole, for needle sizes 14 and 15, in $\frac{1}{4}$ in. gauge, for 213894 .....
211771	13149	Throat Plate, 50 needle hole, for needle sizes 14 and 15, in $\frac{3}{8}$ in. gauge, for 212836 .....
200161D	12319	Throat Plate Clamp Screw .....
202062	12308	" " Position Pin .....
200577H	12311	" " Screw .....
213074	11044	Upright Shaft .....
213075	11044	" " Bevel Gear with 200386c and 200446c .....
200446c	11803	Upright Shaft Bevel Gear Position Screw .....
200386c	11868	Upright Shaft Bevel Gear Set Screw
202574	11036	" " Collar with 200380c .....
200380c	12319	" " " Set Screw .....

## LIST OF PARTS COMPLETE

FOR

**MACHINE No. 22w207**

DROP FEED. ALTERNATING PRESSERS

For Stitching Buff Wheels

In gauges from  $\frac{1}{4}$  to  $\frac{3}{8}$  inch

No.	Plate	Name
*222201	-----	Arm with 200431c, 202036 and 222216 .....
204163	12305	Arm Cap .....
200278H	12311	" " Screw .....
202248	12307	" " " Washer .....
201235	13135	" Position Pin (2) .....
200010E	11011	" Screw (3) .....
202005	12308	" " Washer (3) .....
231431	13137	" Shaft .....
222216	13139	" " Bushing (front) .....
200431c	11808	" " " Position Screw ..
204706	13137	" " Connection with four 200054E (2) .....
200054E	12307	Arm Shaft Connection Screw .....
231432	13137	Balance Wheel (belt groove $4\frac{1}{2}$ in. diam.) with 200347c and 200363c
222205	13135	Balance Wheel Friction Washer ..
231433	13135	" " Key .....
200347c	12376	" " Set Screw .....
200363c	12332	" " " " .....
*222207	-----	Bed with 202062, 203248, 203249, two each 200362c, 200516E, 200840E and 202299 .....
202258	12345	Bed Hinge Connection (2) .....
200570E	12311	" " " Screw (4) .....
203329	11802	" Slide (back) .....
203301	12334	" " (front) .....
203470	11236	Bobbin (2) .....
*203670	-----	" Case .....
203648	13136	" " Latch .....
*202056	-----	" " " Pin .....
203473	13136	" " " Plunger .....
203474	13136	" " " Spring .....
203499	11235	" " Lever .....
203476	-----	" " " Eccentric .....



No.	Plate	Name
204243	11801	Bobbin Case Lever Eccentric Position Pin .....
203506	11235	Bobbin Case Lever Fulcrum .....
200056E	10884	" " " " Screw ..
203478	11235	" " " Slide Stud .....
203214	12312	" " " Tension Spring .....
200984C	12312	" " " " Regulat- ing Screw .....
200594C	12312	Bobbin Case Tension Spring Screw
203216	12312	" " Washer (cloth) .....
203669	11808	Bobbin Case complete, Nos. 200594C, 200984C, 202056, 203214, 203216, 203473, 203474, 203648 and 203670
222320	---	Face Plate with 200366H, 202087, 204185, 204730, two each 202090, 204281, three each 200368H and 200397H .....
200053C	12311	Face Plate Screw .....
204185	13136	" " Thread Guide .....
200368H	12309	" " " " Set Screw
222321	13137	Face Plate complete, Nos. 200577H, 204731, 204795, 222251, 222320, two each 200309E, 204059 and 221223
213422	13139	Feed Bar with 204189 .....
213370	---	" " 213422 with 200214E, 201525E and 204200 .....
200214E	12386	Feed Bar Hinge Screw .....
201525E	12386	" " " " Nut .....
214424	11142	" " Spring .....
204189	12306	" " Hook .....
211754	13141	" Dog, for 222212 .....
231448	13141	" " " 231449 .....
200106E	12311	" " Screw (2) .....
200075E	11801	" " Support Screw .....
201535E	11801	" " " " Nut .....
204285	11868	" Driving Cam with 200382C and 200437C .....
204192	---	Feed Driving Cam Fork Lever with 204195 and 204293 .....
204193	12334	Feed Driving Cam Fork Lever Con- nection with 200668C and 201525E
204194	12306	Feed Driving Cam Fork Lever Con- nection Clamp with 200031E .....
200031E	12311	Feed Driving Cam Fork Lever Con- nection Clamp Pinch Screw .....
200668C	12386	Feed Driving Cam Fork Lever Con- nection Clamp Screw Stud .....
201525E	12386	Feed Driving Cam Fork Lever Con- nection Clamp Screw Stud Nut..

No.	Plate	Name
200002E	12332	Feed Driving Cam Fork Lever Con- nection Hinge Screw .....
201522E	12332	Feed Driving Cam Fork Lever Con- nection Hinge Screw Nut .....
*204195	---	Feed Driving Cam Fork Lever Shaft .....
204197	12306	Feed Driving Cam Fork Lever Shaft Collar with 200113E .....
200113E	12308	Feed Driving Cam Fork Lever Shaft Collar Set Screw .....
204293	12308	Feed Driving Cam Fork Lever Shaft Position Pin .....
204196	12307	Feed Driving Cam Fork Lever Shaft Sleeve (split) .....
200043C	12311	Feed Driving Cam Fork Lever Shaft Sleeve Set Screw .....
201524E	12332	Feed Driving Cam Fork Lever Shaft Sleeve Set Screw Nut ....
204198	12334	Feed Driving Cam Fork Lever com- plete, Nos. 204192 and 204194 ..
200437C	12311	Feed Driving Cam Position Screw
200382C	11142	" " " " Set Screw .....
204294	12333	" " Rock Shaft .....
206555	---	" " " " 204294 with 200002E, 201522E and 204193 ....
202305	12307	Feed Driving Rock Shaft Center (2)
200043C	12311	" " " " " " Set Screw (2) .....
204200	12305	Feed Driving Rock Shaft Crank with 204189 (on left side) and two 200383C .....
200383C	12311	Feed Driving Rock Shaft Crank Set Screw .....
203235	12308	Feed Lifting Cam with 202126 ....
204202	12308	" " " Fork with 200027E
200027E	12332	" " " " Pinch Screw
202126	12308	" " " Position Pin ....
200045E	12332	" " " Screw .....
203305	12334	" " Rock Shaft .....
203315	12334	" " " " 203305 with 203238 .....
202305	12307	Feed Lifting Rock Shaft Center (2)
200043C	12311	" " " " " " Set Screw (2) .....
202276	12308	Feed Lifting Rock Shaft Slide Block .....
203238	12308	Feed Lifting Rock Shaft Slide Block 202276 with 200243E and 201531E .....

No.	Plate	Name
200243E	12332	Feed Lifting Rock Shaft Slide Block Hinge Screw .....
201531E	12308	Feed Lifting Rock Shaft Slide Block Hinge Screw Nut .....
204206	12306	Feed Regulating Handle .....
204288	11805	" " " 204206 with 200098F, 202622, 204208, 204209, 204213, 204289 and 204925 .....
204208	12307	Feed Regulating Handle Adjustable Stop .....
200098F	12307	Feed Regulating Handle Adjustable Stop Screw .....
204925	12306	Feed Regulating Handle Adjustable Stop Screw Washer .....
204209	12307	Feed Regulating Handle Position Pin .....
204289	13135	Feed Regulating Handle Shaft .....
204211	12306	" " " " Crank with 200098F .....
204212	12307	Feed Regulating Handle Shaft Crank Link .....
200271E	12311	Feed Regulating Handle Shaft Crank Link Hinge Screw (lower) .....
200291E	12307	Feed Regulating Handle Shaft Crank Link Hinge Screw (upper) .....
200098F	12307	Feed Regulating Handle Shaft Crank Set Screw .....
204213	12307	Feed Regulating Handle Shaft Sleeve (split) .....
200362c	12311	Feed Regulating Handle Shaft Sleeve Set Screw .....
202622	12306	Feed Regulating Handle Shaft Sleeve Washer .....
202036	12332	Feed Regulating Handle Stop Pin .....
204298	---	Feed Regulating Handle complete, Nos. 200291E, 204211, 204212 and 204288 .....
231442	---	Hook (sewing) .....
231443	13136	" 231442 with 201253F, 201376F and 203251 .....
231444	---	Hook and Bobbin Case complete, Nos. 203669 and 231443 .....
231445	13139	Hook Bevel Gear Socket, 24 teeth .....
201401H	13136	" " " " Screw .....
201537H	12319	" " " " Nut .....
222319	13140	" " Pinion, 24 teeth, with 200383c and 200441c .....
200441c	13136	Hook Bevel Pinion Position Screw .....
200383c	12311	" " " Set Screw .....
222209	13137	" Counter Shaft .....

No.	Plate	Name
203244	11007	Hook Counter Shaft Collar with two 200393c .....
200393c	11007	Hook Counter Shaft Collar Set Screw .....
203245	11007	Hook Counter Shaft Driving Gear, 44 teeth, with 200362c and 200439c .....
213154	12305	Hook Counter Shaft Driving Gear 203245 with 200045E and 203235 .....
200439c	12311	Hook Counter Shaft Driving Gear Position Screw .....
200362c	12311	Hook Counter Shaft Driving Gear Set Screw .....
203246	11007	Hook Counter Shaft Gear, 22 teeth, with two 200383c .....
200383c	12311	Hook Counter Shaft Gear Set Screw .....
202299	---	" " " Oil Packing (wick) .....
200840E	11007	Hook Counter Shaft Oil Packing (wick) Stop Screw .....
213624	12333	Hook Driving Shaft .....
203248	12334	" " " Bearing with 202299 .....
202299	---	Hook Driving Shaft Bearing Oil Packing (wick) .....
202126	12308	Hook Driving Shaft Bearing Position Pin .....
200516E	12311	Hook Driving Shaft Bearing Screw .....
203249	11007	" " " Bushing (eccentric) .....
202299	---	Hook Driving Shaft Bushing Oil Packing (wick) .....
200362c	12311	Hook Driving Shaft Bushing Set Screw .....
213141	11801	Hook Driving Shaft Collar with two 200393c .....
200393c	11007	Hook Driving Shaft Collar Set Screw .....
203251	12312	Hook Gib .....
201376F	13136	" " Hinge Screw .....
201253F	13136	" " Screw .....
203508	11236	" Saddle (left or right) with 200056E .....
200006E	11007	Hook Saddle Screw (4) .....
202622	12306	" " " Washer (4) .....
203455	---	" Washer .....
203461	11808	" " 203455 with 203476 and two 204243 .....

No.	Plate	Name
231446	13139	Hook Saddle complete, Nos. 201401n, 201537n, 203461, 203478, 203499, 203506, 203508, 231444 and 231445 .....
231447	—	Hook Saddle Combination (left and right) complete, Nos. two 231446
207846	13139	Knee Lifter Connection Lever with 202446 .....
207847	—	Knee Lifter Connection Lever 207846 with 200224n, 200262n, 207849 and 227310 .....
200224n	12306	Knee Lifter Connection Lever Hinge Screw .....
227310	13137	Knee Lifter Connection Lever Lifting Rod with 202302 .....
202302	12306	Knee Lifter Connection Lever Lifting Rod Cotter Pin .....
202446	12306	Knee Lifter Connection Lever Pin
207849	13137	" " Lifting Lever .....
200262n	12306	" " " " Hinge Screw .....
204786	10486	Lifting Lever with 200122n and 204189 .....
231440	—	Lifting Lever 204786 with 200935e, 201534e, 204789 and 231439 .....
204788	13135	Lifting Lever Driving Crank .....
204789	10486	" " " " Link
200122n	10483	" " " " " " Stop Screw .....
200400c	11018	Lifting Lever Driving Crank Position Screw .....
200387c	12376	Lifting Lever Driving Crank Position Screw Set Screw .....
204479	11801	Lifting Lever Driving Crank Position Screw Set Screw Packing (brass) .....
200181d	10483	Lifting Lever Stop Screw .....
204790	10486	" " Stud Lifting Bracket with 200086c and 200181d .....
231441	—	Lifting Lever Stud Lifting Bracket 204790 with 231440 .....
200086c	12308	Lifting Lever Stud Lifting Bracket Pinch Screw .....
222211	14004	Lifting Presser Foot, 35 needle hole, in gauges from $\frac{1}{4}$ to $\frac{3}{4}$ in. in steps of $\frac{1}{16}$ in. for 229649 ..
201031f	13136	Lifting Presser Foot Screw .....
231397	13139	Needle Bar (hollow) .....
231437	13135	" " Connecting Link .....

No.	Plate	Name
204249	12308	Needle Bar Connecting Stud with 200072c and 202277 .....
202277	—	Needle Bar Connecting Stud Oil Packing (wick) .....
200072c	12308	Needle Bar Connecting Stud Pinch Screw .....
204326	—	Needle Bar Packing Cord (2) ....
200504e	12386	" " Screw Bushing (lower)
200503n	12386	" " " " (upper)
231383	13140	" Holder, in gauges from $\frac{1}{4}$ to $\frac{1}{2}$ in. in steps of $\frac{1}{16}$ in., with 201030f and two 200141f .....
231385	13140	Needle Holder, in gauges from $\frac{1}{4}$ to $\frac{3}{4}$ in. in steps of $\frac{1}{16}$ in., with 201030f and two 200141f .....
201030f	13136	Needle Holder Screw .....
200141f	12332	" Set Screw .....
222210	13137	Presser Bar with 201031f .....
204719	11808	" " Lifter .....
200550c	12311	" " " Hinge Screw ...
222287	13135	" " Lifting Bracket with 200387c .....
204720	11808	Presser Bar Lifting Bracket Position Guide .....
200362c	12311	Presser Bar Lifting Bracket Position Guide Set Screw .....
200387c	12376	Presser Bar Lifting Bracket Set Screw .....
204327	12306	Presser Bar Packing Washer (felt)
200504e	12386	" " Screw Bushing (lower)
204721	11808	" " Spring .....
200491b	12305	" " Thumb Screw (pressure regulating) .....
201506b	11018	Presser Bar Thumb Screw Check Nut .....
213015	13139	Take-up Cam with 200335c, 200383c, 200387c, 200400c, 200430c and 204479 .....
231433	13135	Take-up Cam Key .....
200430c	12311	" " Position Screw .....
200383c	12311	" " " " Check Screw .....
200335c	12311	Take-up Cam Set Screw .....
200383c	12311	" " " " Check Screw
222205	13135	" " Thrust Washer .....
221450	—	Take-up Cam complete, Nos. 204788, 213015 and 231437 .....

No.	Plate	Name
204553	12386	Take-up Lever .....
204723	13135	" " Bearing with 204264
204264	12306	" " " Position Pin..
200042F	12311	" " " Screw .....
201816	12307	" " " Roller .....
213109	----	Take-up Lever complete, Nos. 200042F, 201816, 204553 and 204723
202402	12309	Tension Disc .....
202090	12309	" " Position Pin .....
222251	11868	" Release Lever .....
222254	11868	" " " Operating Lever
200585H	11868	" " " " " "
		Screw .....
200309E	10483	Tension Release Lever Screw ....
202075	12309	" " Plunger .....
222285	13136	" " Slide with 222284 ..
222284	----	" " " Spring .....
222286	----	Tension Release Slide complete, Nos. 222254, 222285 and two 200585H .....
225708	13136	Tension Spring .....
201375J	13136	" Stud .....
200397H	12309	" " Set Screw .....
201572B	10881	" Thumb Nut .....
204271	12309	" Washer .....
221223	----	Tension complete, Nos. 201375J, 201572B, 202075, 204271, 225708 and two 202402 .....
204274	12309	Thread Controller Plate .....
200577H	12311	" " " Screw ...
202098	12309	" " " Roller .....
204275	12309	" " " Guard .....
202084	12309	" " " Washer
200300C	12309	" " " Screw .....
204726	11808	" " Spring .....
204333	12309	" " " Guard .....
200581H	12309	" " " " Screw..
202087	13136	" " " Stop .....
204795	10486	" " " Stud with 204925 .....
200366H	12309	Thread Controller Spring Stud Set Screw .....
204925	12306	Thread Controller Spring Stud Washer .....
204730	12386	Thread Controller Thread Guard..
200397H	12309	" " " " Set Screw .....
205987	12309	Thread Controller complete, Nos. 200300C, 200581H, 202084, 202098, 204274, 204275 and 204333 .....

No.	Plate	Name
204731	11808	Thread Controller and Spring com- plete, Nos. 204726 and 205987 ...
203313	12386	Thread Guide .....
204281	12309	" Retainer Guide Wire .....
202091	12309	" " Sleeve .....
202092	12309	" " Spring .....
204058	12309	" " Stud .....
200368H	12309	" " " Set Screw .....
204059	12309	Thread Retainer complete, Nos. 202091, 202092 and 204058 .....
231438	13138	Throat Plate, 31 needle hole, for needle sizes 25 and 26, in gauges from $\frac{1}{4}$ to $\frac{3}{8}$ in., in steps of $\frac{1}{32}$ in., for 211754 .....
231449	13149	Throat Plate, 31 needle hole, for needle sizes 25 and 26, in gauges from $\frac{1}{16}$ to $\frac{3}{4}$ in., in steps of $\frac{1}{32}$ in., for 231448 .....
200161D	12319	Throat Plate Clamp Screw .....
202062	12308	" " Position Pin .....
200577H	12311	" " Screw .....
231439	13139	Vibrating Presser Bar with 206108
222213	13135	" " " Adjustable Stop with 200113F .....
222214	----	Vibrating Presser Bar Adjustable Stop 222213 with 221439 and two 201215F .....
221439	13135	Vibrating Presser Bar Adjustable Stop Finger .....
201215F	13136	Vibrating Presser Bar Adjustable Stop Finger Screw .....
200113F	12308	Vibrating Presser Bar Adjustable Stop Set Screw .....
200935F	11803	Vibrating Presser Bar Hinge Screw
201534E	11868	" " " " " Nut .....
204797	13135	Vibrating Presser Bar Spring (spiral) .....
206108	13136	Vibrating Presser Bar Spring Hook
204189	12306	" " " " "
229649	14067	" " Foot, in gauges from $\frac{1}{4}$ to $\frac{3}{4}$ in., in steps of $\frac{1}{32}$ in., for 222211 .....
200098F	12307	Vibrating Presser Foot Screw .....
203357	11803	" " " " Washer

## ACCESSORIES

FOR MACHINE No. 22w23

No.	Plate	Name
200157B	12332	Attachment Screw .....
203208	12312	Bobbin (10) .....
*225482	—	" Case Screw Driver Blade ...
*225483	—	" " " " Handle ...
225497	12345	Bobbin Case Screw Driver complete, Nos. 225482 and 225483 ..
128 x 3	—	Needles, six each, sizes 12 and 14
225191	—	Drip Pan with four wood screws $\frac{1}{2}$ in., No. 5 .....
41400	12345	Machine Rest Pin (wood) .....
36578	12345	Oiler with 36579 .....
36579	12345	" Spout, 3 $\frac{1}{2}$ in. long, with 120117
120117	—	" " Washer (leather) .....
*225484	—	Screw Driver Blade .....
*225485	—	" " Handle .....
225498	12345	Screw Driver complete (7 $\frac{1}{4}$ in. long), Nos. 225484 and 225485 ..
225554	12345	Wrench (steel) .....
202511	13084	" .....

### BOBBIN WINDER

225453	10884	Frame with 202277 and 225438 ....
225454	10884	" Hinge Pin .....
202277	—	" Oil Packing (wick) .....
225438	10884	" " Well Cap .....
225455	10884	" Spring .....
225456	10884	" " Plunger .....
202473	10885	Pulley with 200380c .....
200380c	12319	" Set Screw .....
225381	10884	Spindle .....
225444	10884	Stop Latch .....
200056E	10884	" " Screw .....
225458	10884	" " Thumb Lever .....
225459	10884	" " " " Hinge Stud
225460	10884	" " " " Joint Stud
202478	10884	" " Trip Lever .....
200299H	10884	" " " " Hinge Screw
225461	10881	Tension Bracket with 201499B ....
200082D	10881	" " Screw .....
228026	10884	" " " Washer .....

No.	Plate	Name
2102	10881	Tension Disc .....
202407	10881	" Spring .....
201499B	10881	" Stud .....
201572B	10881	" " Thumb Nut .....
225462	10881	Bobbin Winder Tension Bracket complete, Nos. 201572B, 202407, 225461 and two 2102 .....
225433	10885	Bobbin Winder and Tension Bracket Base .....
225382	10885	Universal Bobbin Winder complete, Nos. 200056E, 200082D, 200299H, 202473, 202478, 225381, 225433, 225444, 225453 to 225456, 225458 to 225460, 225462, 228026 and two wood screws $\frac{3}{4}$ in., No. 13, R.H.B.

### KNEE LIFTER

227781	11125	Knee Lifter Rock Lever with 200522c and 200529c .....
227782	—	Knee Lifter Rock Lever 227781 with two each 202451 and 202452 ...
227783	11125	Knee Lifter Rock Lever 227782 with 202985 and 227784 .....
202453	11125	Knee Lifter Rock Lever Knee Plate with 200526c .....
202985	—	Knee Lifter Rock Lever Knee Plate 202453 with 202455 .....
202455	11125	Knee Lifter Rock Lever Knee Plate Arm (short) .....
200522c	12319	Knee Lifter Rock Lever Knee Plate Arm Set Screw .....
200526c	12319	Knee Lifter Rock Lever Knee Plate Set Screw .....
202451	11125	Knee Lifter Rock Lever Lug with two wood screws $\frac{3}{4}$ in., No. 13H
202452	12319	Knee Lifter Rock Lever Lug Hinge Pin .....
227784	11125	Knee Lifter Rock Lever Rod, 3 in. long, with 227785 .....
*227785	—	Knee Lifter Rock Lever Rod Cap or Oil Guard .....
200529c	12319	Knee Lifter Rock Lever Rod Set Screw .....

(Other Knee Lifter Parts are listed with parts of machine head.)

## THREAD UNWINDER

No.	Plate	Name
225389	14083	Spool Rest (for one spool) with 201018c .....
225395	14083	Spool Rest (for two spools) with 201018c .....
225388	14083	Spool Rest Rod .....
200383c	12311	" " " Set Screw .....
201018c	13138	" " Set Screw .....
202490	14083	" Stand with 200383c .....
225391	14083	Thread Guide .....
201696j	13138	" " Lock Nut .....
225392	14083	" " Rod with 208e and 225393 .....
208E	13138	Thread Guide Rod Screw .....
225393	13136	" " " Washer .....
225397	14083	Thread Unwinder (for three spools) complete, Nos. 201696j, 202490, 225388, 225389, 225392, 225395, three each 225391 and wood screws $\frac{3}{8}$ in., No. 13 .....

## FOR MACHINE No. 22w25

Same as for 22w23 with the following exception:

202511	13084	Wrench (not used) .....
--------	-------	-------------------------

## FOR MACHINE No. 22w38

Same as for 22w23 with the following exceptions:

203470	11236	Bobbin (10), in place of 203208 ...
213759	13138	Knife (3) .....
126 x 3	---	Needles, four each, sizes 16, 18 and 20, in place of 128 x 3 .....
		(202511 Wrench, not used) .....

## FOR MACHINE No. 22w111

Same as for 22w23 with the following exceptions:

225181	---	Drip Pan with four wood screws $\frac{1}{2}$ in., No. 5, in place of 225191 ...
--------	-----	---

No.	Plate	Name
226056	11018	Quilter .....
126 x 3	---	Needles, four each, sizes 16, 18 and 20, in place of 128 x 3 .....
		(202511 Wrench, not used) .....

## KNEE LIFTER

227781	11125	Knee Lifter Rock Lever with 200522c and 200529c .....
227782	---	Knee Lifter Rock Lever 227781 with two each 202451 and 202452 ...
227787	---	Knee Lifter Rock Lever 227782 with 202203 and 227784, in place of 227783 .....
202453	11125	Knee Lifter Rock Lever Knee Plate with 200526c .....
202203	---	Knee Lifter Rock Lever Knee Plate 202453 with 202454 .....
202454	11125	Knee Lifter Rock Lever Knee Plate Arm (long) .....
200522c	12319	Knee Lifter Rock Lever Knee Plate Arm Set Screw .....
200526c	12319	Knee Lifter Rock Lever Knee Plate Set Screw .....
202451	11125	Knee Lifter Rock Lever Lug with two wood screws $\frac{3}{8}$ in., No. 13u .....
202452	12319	Knee Lifter Rock Lever Lug Hinge Pin .....
227784	11125	Knee Lifter Rock Lever Rod, 3 in. long, with 227785 .....
*227785	---	Knee Lifter Rock Lever Rod Cap or Oil Guard .....
200529c	12319	Knee Lifter Rock Lever Rod Set Screw .....

(Other Knee Lifter Parts are listed with parts of machine head.)

## FOR MACHINE No. 22w113

Same as for 22w23 with the following exceptions:

225181	---	Drip Pan with four wood screws $\frac{1}{2}$ in., No. 5, in place of 225191 ...
227787	---	Knee Lifter Rock Lever, in place of 227783 .....
126 x 3	---	Needles, four each, sizes 16, 18 and 20, in place of 128 x 3 .....
		(202511 Wrench, not used) .....

## FOR MACHINE No. 22w133

Same as for 22w23 with the following exceptions:

No.	Plate	Name
225181	—	Drip Pan with four wood screws $\frac{1}{2}$ in., No. 5, in place of 225191 ... (227783 Knee Lifter Rock Lever, not used) ..... (202511 Wrench, not used) .....

## EDGE FOLDER

230802	11857	Edge Folder (left) .....
230803	11857	" " (right) .....
230260	13138	" " Base .....
200170b	13138	" " Screw .....
230804	11857	Edge Folder complete, Nos. 230260, 230802, 230803 and two 200170b...

## EDGE GUIDE

230805	11857	Edge Guide (left) .....
230806	11857	" " (right) .....
230808	13138	" " (double, for paper) ...
230260	13138	" " Base .....
200170b	13138	" " Screw .....
230807	11857	Edge Guide complete, Nos. 230260, 230805, 230806 and two 200170b...

## FOR MACHINE No. 22w207

Same as for 22w23 with the following exceptions:

203470	11236	Bobbin (10), in place of 203208 ....
225181	—	Drip Pan with four wood screws $\frac{1}{2}$ in., No. 5, in place of 225191 ...
227787	—	Knee Lifter Rock Lever, in place of 227783 .....
129 x 1	—	Needles, twelve, size 22, in place of 128 x 3 .....
		(202511 Wrench, not used) .....

## FEED DOGS

No.	Plate	Name
211010	13141	Feed Dog, for 211748 .....
236411	13143	" " " 211053 and 211054 ..
211246	13143	" " " 211726 and 211727 ..
211298	13142	" " " 211191 and 211879 ..
211642	13142	" " " 211641 .....
211646	13142	" " " 211645 .....
211648	13142	" " " 211647 .....
211652	13141	" " " 211859 .....
211654	13141	" " " 211653 .....
211669	12092	" " " 211666 and 211667 ..
211670	12092	" " " 211666 and 211667 ..
211674	12092	" " " 211671 and 211672 ..
211675	12092	" " " 211671 and 211672 ..
211679	12093	" " " 211677 .....
211680	12093	" " " 211677 .....
211684	12093	" " " 211682 .....
211685	12093	" " " 211682 .....
211717	12099	" " " 211715 and 211716 ..
211718	12099	" " " 211715 and 211716 ..
211721	12099	" " " 211720 .....
211722	12099	" " " 211720 .....
211725	12100	" " " 211724 .....
211728	12100	" " " 211726 and 211727 ..
211729	12100	" " " 211726 and 211727 ..
211732	12100	" " " 211731 .....
211733	12100	" " " 211731 .....
211754	13141	" " " 222212 and 231438 ..
211761	13141	" " " 211759 and 211760 ..
211762	13141	" " " 211759 and 211760 ..
211765	12104	" " " 211764 .....
211766	12104	" " " 211764 .....
211769	12104	" " " 211768 .....
211770	12104	" " " 211768 .....
211784	13143	" " " 211782 and 211783 ..
211805	13143	" " " 222334 .....
211809	13141	" " " 211952 and 212050 ..
211884	13142	" " " 222298 .....
211904	13142	" " " 212091 .....
211933	13141	" " " 211764 .....
211934	13141	" " " 211768 .....
211995	13141	" " " 211191 and 211879 ..
236423	13143	" " " 211060 and 211061 ..
212169	11814	" " " 211066 and 211067 ..
231516	13143	" " " 212242 .....
212474	11814	" " " 211063 and 211064 ..

No.	Plate	Name
212571	11813	Feed Dog, for 211050 and 211614 ..
211644	13142	" " " 211643 .....
212836	13142	" " " 211771 .....
213894	13143	" " " 213893 .....
222235	13141	" " " 222238 and 222239 ..
231448	13141	" " " 231449 .....
236419	11813	" " " 211057 and 211058 ..

## NEEDLE HOLDERS

231383	13140	Needle Holder, in gauges from $\frac{1}{16}$ to $\frac{1}{4}$ in., in steps of $\frac{1}{32}$ in., with 201030F and two 200141F, for Machines Nos. 22w23, 22w25, 22w111, 22w113 and 22w207 .....
231385	13140	Needle Holder, in gauges from $\frac{1}{16}$ to $\frac{3}{8}$ in., in steps of $\frac{1}{32}$ in., with 201030F and two 200141F, for Machines Nos. 22w111, 22w113 and 22w207 .....
229662	13140	Needle Holder, in gauges from $\frac{1}{16}$ to $\frac{1}{4}$ in., in steps of $\frac{1}{32}$ in., for trimming .045, .060 and .085 in., with 200141F, 200389C and two 200581U, for Needle Bar 203715, for Machine No. 22w38 .....
231400	13140	Needle Holder, in gauges from $\frac{1}{16}$ to $\frac{3}{8}$ in., in steps of $\frac{1}{32}$ in., for trimming .045, .060 and .085 in., with 201030F and two 200389C, for Needle Bar 231390, for Machine No. 22w38 .....
231401	13140	Needle Holder, in gauges $\frac{1}{16}$ and $\frac{3}{8}$ in., with 201030F and two 200141F, for Machine No. 22w133 .....

## PRESSER FEET

FOR MACHINE No. 22w23

No.	Plate	Name
229550	13084	Presser Foot, 46 needle hole, in gauges from $\frac{1}{16}$ to $\frac{3}{8}$ in., in steps of $\frac{1}{32}$ inch .....
222292	13144	Presser Foot, 46 needle hole, in gauges $\frac{1}{16}$ and $\frac{1}{4}$ inch .....

FOR MACHINE No. 22w25

213042	11029	Presser Foot, 46 needle hole, in gauges $\frac{1}{16}$ , $\frac{1}{8}$ , $\frac{3}{16}$ and $\frac{1}{4}$ inch ...
--------	-------	--

FOR MACHINE No. 22w38

230795	13138	Presser Foot Hinge Pin .....
222236	-----	" " Plate, for 222237 .....
202923	-----	" " Shank .....
229123	13144	Presser Foot, 46 needle hole, in gauges from $\frac{1}{16}$ to $\frac{3}{8}$ in., in steps of $\frac{1}{32}$ inch .....
229124	13144	Presser Foot, 46 needle hole, in gauges from $\frac{1}{16}$ to $\frac{3}{8}$ in., in steps of $\frac{1}{32}$ inch .....
222237	13144	Presser Foot (hinged) complete, 50 needle hole, in gauges $\frac{1}{16}$ and $\frac{1}{4}$ in., Nos. 202923, 222236 and 230795

FOR MACHINE No. 22w111

229102	12332	Presser Foot, 46 needle hole, in gauges $\frac{1}{16}$ , $\frac{1}{8}$ , $\frac{3}{16}$ and $\frac{1}{4}$ inch ....
229103	14004	Presser Foot, 46 needle hole, in gauges $\frac{1}{16}$ , $\frac{1}{8}$ and $\frac{3}{16}$ inch .....
229104	12164	Presser Foot, 46 needle hole, in gauges from $\frac{1}{16}$ to $\frac{1}{4}$ in., in steps of $\frac{1}{32}$ inch .....
229105	12164	Presser Foot, 46 needle hole, in gauges $\frac{1}{16}$ and $\frac{1}{4}$ inch .....
229106	12164	Presser Foot, 46 needle hole, in gauges $\frac{1}{16}$ , $\frac{1}{8}$ , $\frac{3}{16}$ and $\frac{1}{4}$ inch ...



## Presser Feet

No.	Plate	Name
229107	12164	Presser Foot, 46 needle hole, in gauges $\frac{3}{8}$ and $\frac{1}{2}$ inch .....
230795	---	Presser Foot Hinge Pin .....
229132	---	" " Plate, for 229133 ....
229134	---	" " " " 229135 ....
229138	---	" " " " 229139 ....
229140	---	" " " " 229141 ....
229095	---	" " " " 229096 ....
229097	---	" " " " 229098 ....
229099	---	" " " " 229100 ....
202923	---	" " Shank .....
229133	14005	Presser Foot (hinged) complete, 46 needle hole, in gauges $\frac{3}{8}$ , $\frac{1}{2}$ , $\frac{5}{8}$ and $\frac{3}{4}$ in., Nos. 202923, 229132 and 230795 .....
229135	14005	Presser Foot (hinged) complete, 46 needle hole, in gauges $\frac{11}{16}$ , $\frac{3}{4}$ , $\frac{13}{16}$ and $\frac{7}{8}$ in., Nos. 202923, 229134 and 230795 .....
229139	13144	Presser Foot (hinged) complete, 46 needle hole, in gauges from $\frac{11}{16}$ to $\frac{7}{8}$ in., in steps of $\frac{1}{16}$ in., Nos. 202923, 229138 and 230795 .....
229141	13144	Presser Foot (hinged) complete, 46 needle hole, in gauges $\frac{3}{8}$ , $\frac{11}{16}$ , $\frac{3}{4}$ and $\frac{7}{8}$ in., Nos. 202923, 229140 and 230795 .....
229096	13144	Presser Foot (hinged) complete, 46 needle hole, in gauges $\frac{3}{8}$ , $\frac{1}{2}$ , $\frac{5}{8}$ and $\frac{3}{4}$ in., Nos. 202923, 229095 and 230795 .....
229098	13138	Presser Foot (hinged) complete, 46 needle hole, in gauges $\frac{11}{16}$ , $\frac{3}{4}$ , $\frac{13}{16}$ and $\frac{7}{8}$ in., Nos. 202923, 229097 and 230795 .....
229100	13138	Presser Foot (hinged) complete, 46 needle hole, in gauges from $\frac{11}{16}$ to $\frac{7}{8}$ in., in steps of $\frac{1}{16}$ in., Nos. 202923, 229099 and 230795 .....

## FOR MACHINE No. 22w113

206669	14005	Lifting Presser Foot, 46 needle hole, in $\frac{1}{2}$ in. gauge, for 206670..
206708	14005	Lifting Presser Foot, 50 needle hole, in $\frac{1}{2}$ in. gauge, for 206710..
206709	14005	Lifting Presser Foot, 46 needle hole, in $\frac{1}{2}$ in. gauge, for 206710 ..

## Presser Feet

No.	Plate	Name
206711	14005	Lifting Presser Foot, 46 needle hole, in gauges $\frac{3}{8}$ and $\frac{1}{2}$ in., for 206713 .....
206712	14005	Lifting Presser Foot, 50 needle hole, in gauges $\frac{3}{8}$ and $\frac{1}{2}$ in., for 206713 .....
222305	14067	Lifting Presser Foot, 46 needle hole, in gauges from $\frac{1}{2}$ to $\frac{3}{4}$ in., in steps of $\frac{1}{16}$ in., for strip work, for 229649 .....
229667	14004	Lifting Presser Foot, 46 needle hole, in gauges from $\frac{11}{16}$ to $\frac{7}{8}$ in., in steps of $\frac{1}{16}$ in., for felling, for 229653 .....
229624	14005	Lifting Presser Foot, in $\frac{1}{2}$ in. gauge, for 206675 and 206714 .....
229641	14004	Lifting Presser Foot, 46 needle hole, in gauges $\frac{1}{2}$ , $\frac{5}{8}$ , $\frac{3}{4}$ and $\frac{7}{8}$ in., for 206671 .....
229642	14004	Lifting Presser Foot, 46 needle hole, in gauges $\frac{3}{8}$ and $\frac{5}{8}$ in., for 206661 .....
229646	14067	Lifting Presser Foot, 50 needle hole, in gauges $\frac{3}{8}$ , $\frac{1}{2}$ and $\frac{1}{4}$ in., for 206690 .....
229650	14067	Lifting Presser Foot, 46 needle hole, in gauges $\frac{1}{2}$ , $\frac{5}{8}$ , $\frac{3}{4}$ , $\frac{11}{16}$ and $\frac{3}{4}$ in., for 229651 .....
229652	14067	Lifting Presser Foot, 46 needle hole, in gauges from $\frac{11}{16}$ to $\frac{7}{8}$ in., in steps of $\frac{1}{16}$ in., for 229653 ...
229654	14004	Lifting Presser Foot, 46 needle hole, in gauges $\frac{11}{16}$ , $\frac{3}{4}$ , $\frac{13}{16}$ and $\frac{7}{8}$ in., for 229655 .....
206661	11839	Vibrating Presser Foot, for 229642
206670	11839	" " " " 206669
206675	11839	" " " " 229624
206690	11839	" " " " 229646
206710	11839	" " " " 206708 and 206709 .....
206713	11839	Vibrating Presser Foot, for 206711 and 206712 .....
206714	11839	Vibrating Presser Foot, for 229624
229651	14067	" " " " 229650
229653	14067	" " " " in gauges from $\frac{11}{16}$ to $\frac{7}{8}$ in., in steps of $\frac{1}{16}$ in., for 229652 and 229667 .....
229655	14004	Vibrating Presser Foot, in gauges $\frac{11}{16}$ , $\frac{3}{4}$ , $\frac{13}{16}$ and $\frac{7}{8}$ in., for 229654 ..

## Presser Feet

No.	Plate	Name
206671	11839	Vibrating Presser Foot, for 229641
229649	14067	" " " in gauges from $\frac{1}{4}$ to $\frac{3}{4}$ in., in steps of $\frac{1}{32}$ in., for 222305 .....

## FOR MACHINE No. 22w133

213096	11043	Presser Foot, in gauges $\frac{1}{4}$ and $\frac{3}{4}$ inch .....
--------	-------	---

## FOR MACHINE No. 22w207

222211	14004	Lifting Presser Foot, 35 needle hole, in gauges from $\frac{1}{4}$ to $\frac{3}{4}$ in., in steps of $\frac{1}{32}$ in., for 229649 ...
229649	14067	Vibrating Presser Foot, in gauges from $\frac{1}{4}$ to $\frac{3}{4}$ in., in steps of $\frac{1}{32}$ in., for 222211 .....

## THROAT PLATES

## FOR MACHINE No. 22w23

No.	Plate	Name
211641	13146	Throat Plate, 50 needle hole, for needle sizes 14 and 15, in $\frac{3}{16}$ in. gauge, for 211642 .....
211643	13146	Throat Plate, 50 needle hole, for needle sizes 14 and 15, in $\frac{1}{4}$ in. gauge, for 211644 .....
211645	13146	Throat Plate, 50 needle hole, for needle sizes 14 and 15, in $\frac{5}{16}$ in. gauge, for 211646 .....
211647	13146	Throat Plate, 50 needle hole, for needle sizes 14 and 15, in gauges $\frac{1}{4}$ , $\frac{5}{16}$ and $\frac{3}{8}$ in., for 211648 .....
211653	13146	Throat Plate, 50 needle hole, for needle sizes 14 and 15, in gauges $\frac{5}{16}$ and $\frac{3}{8}$ in., for 211654 .....
211782	13146	Throat Plate, 50 needle hole, for needle sizes 14 and 15, in gauges $\frac{3}{8}$ and $\frac{1}{2}$ in., for 211784 .....
211783	13147	Throat Plate, 46 needle hole, for needle sizes 16 and 18, in gauges $\frac{3}{8}$ and $\frac{1}{2}$ in., for 211784 .....

## FOR MACHINE No. 22w25

211879	13147	Throat Plate, 50 needle hole, for needle sizes 14 and 15, in gauges $\frac{3}{8}$ , $\frac{1}{2}$ and $\frac{5}{8}$ in., for 211298 and 211995 .....
211614	11813	Throat Plate, 50 needle hole, for needle sizes 14 and 15, in $\frac{3}{8}$ in. gauge, for 212571 .....

## FOR MACHINE No. 22w38

211952	11823	Throat Plate, 50 needle hole, for needle sizes 14 and 15, in gauges from $\frac{1}{8}$ to $\frac{3}{4}$ in., in steps of $\frac{1}{32}$ in., with 200178D, 200587D, 211416 and 211426, trims opposite the needle and .060 and .085 in. to right of seam, for 211809 .....
--------	-------	---

No.	Plate	Name
212050	13147	Throat Plate, 50 needle hole, for needle sizes 14 and 15, in gauges $\frac{1}{8}$ , $\frac{15}{32}$ and $\frac{1}{2}$ in., with 200178D, 200587D, 211416 and 211426, trims opposite the needle and .060, .085, .115 and .125 in. to right of seam, for 211809 .....
222238	13147	Throat Plate, 50 needle hole, for needle sizes 14 and 15, in gauges $\frac{15}{32}$ and $\frac{1}{2}$ in., with 200178D, 200587D, 211416 and 211426, trims opposite the needle and .060, .085, .115 and .125 in. to right of seam, for 222235 .....
222239	13147	Throat Plate, 46 needle hole, for needle sizes 16 and 18, in gauges $\frac{1}{2}$ and $\frac{15}{16}$ in., with 200178D, 200587D, 211416 and 211426, trims opposite the needle and .060, .085, .115 and .125 in. to right of seam, for 222235 .....
222298	13147	Throat Plate, 50 needle hole, for needle sizes 14 and 15, in $\frac{3}{8}$ in. gauge, with 200178D, 200587D, 211416 and 211426, trims opposite the needle and .060 and .085 in. to right of seam, for 211884 ....
222334	13148	Throat Plate, 50 needle hole, for needle sizes 14 and 15, in $\frac{1}{4}$ in. gauge, with 200178D, 200587D, 211416 and 211426, trims opposite the needle and .060 and .085 in. to right of seam, for 211805 ...

## FOR MACHINE No. 22w111

211050	11813	Throat Plate, 46 needle hole, for needle sizes 16 and 18, in gauges $\frac{5}{16}$ and $\frac{3}{8}$ in., for 212571 .....
211053	11813	Throat Plate, 50 needle hole, for needle sizes 14 and 15, in gauges $\frac{1}{4}$ and $\frac{5}{16}$ in., for 236411 .....
211054	11813	Throat Plate, 46 needle hole, for needle sizes 16 and 18, in gauges $\frac{5}{16}$ and $\frac{1}{2}$ in., for 236411 .....
211057	11813	Throat Plate, 50 needle hole, for needle sizes 14 and 15, in gauges $\frac{5}{16}$ and $\frac{3}{8}$ in., for 236419 .....

No.	Plate	Name
211058	11813	Throat Plate, 46 needle hole, for needle sizes 16 and 18, in gauges $\frac{5}{16}$ and $\frac{3}{8}$ in., for 236419 .....
211060	11814	Throat Plate, 50 needle hole, for needle sizes 14 and 15, in gauges $\frac{15}{32}$ and $\frac{1}{2}$ in., for 236423 .....
211061	11814	Throat Plate, 46 needle hole, for needle sizes 16 and 18, in gauges $\frac{15}{32}$ and $\frac{1}{2}$ in., for 236423 .....
211063	11814	Throat Plate, 50 needle hole, for needle sizes 14 and 15, in gauges $\frac{15}{32}$ and $\frac{3}{8}$ in., for 212474 .....
211064	11814	Throat Plate, 46 needle hole, for needle sizes 16 and 18, in gauges $\frac{15}{32}$ and $\frac{3}{8}$ in., for 212474 .....
211066	11814	Throat Plate, 50 needle hole, for needle sizes 14 and 15, in gauges $\frac{15}{32}$ and $\frac{1}{2}$ in., for 212169 .....
211067	11814	Throat Plate, 46 needle hole, for needle sizes 16 and 18, in gauges $\frac{15}{32}$ and $\frac{1}{2}$ in., for 212169 .....
211191	13148	Throat Plate, 46 needle hole, for needle sizes 16 and 18, in $\frac{1}{4}$ in. gauge, for 211298 and 211995 ..
211614	11813	Throat Plate, 50 needle hole, for needle sizes 14 and 15, in gauges $\frac{3}{8}$ and $\frac{15}{32}$ in., for 212571 .....
211666	12092	Throat Plate, 50 needle hole, for needle sizes 14 and 15, in gauges $\frac{3}{8}$ , $\frac{15}{32}$ , $\frac{1}{4}$ , $\frac{15}{32}$ and $\frac{1}{2}$ in., for 211669 and 211670 .....
211667	12092	Throat Plate, 46 needle hole, for needle sizes 16 and 18, in gauges $\frac{3}{8}$ , $\frac{15}{32}$ , $\frac{1}{4}$ , $\frac{15}{32}$ and $\frac{1}{2}$ in., for 211669 and 211670 .....
211671	12092	Throat Plate, 50 needle hole, for needle sizes 14 and 15, in gauges $\frac{3}{8}$ , $\frac{15}{32}$ , $\frac{1}{4}$ , $\frac{15}{32}$ and $\frac{1}{2}$ in., for 211674 and 211675 .....
211672	12092	Throat Plate, 46 needle hole, for needle sizes 16 and 18, in gauges $\frac{3}{8}$ , $\frac{15}{32}$ , $\frac{1}{4}$ , $\frac{15}{32}$ and $\frac{1}{2}$ in., for 211674 and 211675 .....
211677	12093	Throat Plate, 46 needle hole, for needle sizes 16 and 18, in gauges $\frac{15}{32}$ , $\frac{3}{8}$ , $\frac{15}{32}$ and $\frac{11}{16}$ in., for 211679 and 211680 .....
211682	12093	Throat Plate, 46 needle hole, for needle sizes 16 and 18, in gauges $\frac{15}{32}$ and $\frac{3}{8}$ in., for 211684 and 211685

No.	Plate	Name
211715	12099	Throat Plate, 50 needle hole, for needle sizes 14 and 15, in gauges from $\frac{1}{16}$ to $\frac{1}{8}$ in., in steps of $\frac{1}{32}$ in., for 211717 and 211718 .....
211716	12099	Throat Plate, 46 needle hole, for needle sizes 16 and 18, in gauges from $\frac{1}{16}$ to $\frac{1}{8}$ in., in steps of $\frac{1}{32}$ in., for 211717 and 211718 .....
211720	12099	Throat Plate, 46 needle hole, for needle sizes 16 and 18, in gauges from $\frac{1}{16}$ to $\frac{1}{8}$ in., in steps of $\frac{1}{32}$ in., for 211721 and 211722 .....
211724	12100	Throat Plate, 46 needle hole, for needle sizes 16 and 18, in gauges from $\frac{1}{16}$ to $\frac{1}{8}$ in., in steps of $\frac{1}{32}$ in., for 211725 .....
211726	12100	Throat Plate, 50 needle hole, for needle sizes 14 and 15, in gauges from $\frac{1}{16}$ to $\frac{1}{8}$ in., in steps of $\frac{1}{32}$ in., for 211246, 211728 and 211729 .....
211727	12100	Throat Plate, 46 needle hole, for needle sizes 16 and 18, in gauges from $\frac{1}{16}$ to $\frac{1}{8}$ in., in steps of $\frac{1}{32}$ in., for 211729 .....
211731	12100	Throat Plate, 46 needle hole, for needle sizes 16 and 18, in gauges from $\frac{1}{16}$ to $\frac{1}{8}$ in., in steps of $\frac{1}{32}$ in., for 211732 and 211733 .....
211748	13148	Throat Plate, 46 needle hole, for needle sizes 16 and 18, in gauges from $\frac{1}{16}$ to $\frac{1}{8}$ in., in steps of $\frac{1}{32}$ in., for 211010 .....
211759	13148	Throat Plate, 50 needle hole, for needle sizes 14 and 15, in gauges $\frac{1}{16}$ , $\frac{1}{8}$ , $\frac{3}{16}$ , $\frac{1}{4}$ and $\frac{5}{16}$ in., for 211761 and 211762 .....
211760	13148	Throat Plate, 46 needle hole, for needle sizes 16 and 18, in gauges $\frac{1}{16}$ , $\frac{1}{8}$ , $\frac{3}{16}$ , $\frac{1}{4}$ and $\frac{5}{16}$ in., for 211761 and 211762 .....
211764	12104	Throat Plate, 46 needle hole, for needle sizes 16 and 18, in gauges $\frac{1}{16}$ , $\frac{1}{8}$ , $\frac{3}{16}$ and $\frac{1}{4}$ in., for 211765, 211766 and 211933 .....
211768	12104	Throat Plate, 46 needle hole, for needle sizes 16 and 18, in $\frac{3}{16}$ in. gauge, for 211769, 211770 and 211934 .....

No.	Plate	Name
211879	13147	Throat Plate, 50 needle hole, for needle sizes 14 and 15, in gauges $\frac{1}{16}$ , $\frac{1}{8}$ and $\frac{3}{16}$ in., for 211298 and 211995 .....

## FOR MACHINE No. 22w113

211050	11813	Throat Plate, 46 needle hole, for needle sizes 16 and 18, in gauges $\frac{1}{16}$ and $\frac{1}{8}$ in., for 212571 .....
211053	11813	Throat Plate, 50 needle hole, for needle sizes 14 and 15, in gauges $\frac{1}{16}$ and $\frac{1}{8}$ in., for 236411 .....
211054	11813	Throat Plate, 46 needle hole, for needle sizes 16 and 18, in gauges $\frac{1}{16}$ and $\frac{1}{8}$ in., for 236411 .....
211057	11813	Throat Plate, 50 needle hole, for needle sizes 14 and 15, in gauges $\frac{1}{16}$ and $\frac{1}{8}$ in., for 236419 .....
211058	11813	Throat Plate, 46 needle hole, for needle sizes 16 and 18, in gauges $\frac{1}{16}$ and $\frac{1}{8}$ in., for 236419 .....
211060	11814	Throat Plate, 50 needle hole, for needle sizes 14 and 15, in gauges $\frac{1}{16}$ and $\frac{1}{8}$ in., for 236423 .....
211061	11814	Throat Plate, 46 needle hole, for needle sizes 16 and 18, in gauges $\frac{1}{16}$ and $\frac{1}{8}$ in., for 236423 .....
211063	11814	Throat Plate, 50 needle hole, for needle sizes 14 and 15, in gauges $\frac{1}{16}$ and $\frac{1}{8}$ in., for 212474 .....
211064	11814	Throat Plate, 46 needle hole, for needle sizes 16 and 18, in gauges $\frac{1}{16}$ and $\frac{1}{8}$ in., for 212474 .....
211066	11814	Throat Plate, 50 needle hole, for needle sizes 14 and 15, in gauges $\frac{1}{16}$ and $\frac{1}{8}$ in., for 212169 .....
211067	11814	Throat Plate, 46 needle hole, for needle sizes 16 and 18, in gauges $\frac{1}{16}$ and $\frac{1}{8}$ in., for 212169 .....
211191	13148	Throat Plate, 46 needle hole, for needle sizes 16 and 18, in $\frac{1}{4}$ in. gauge, for 211298 and 211995 ..
211614	11813	Throat Plate, 50 needle hole, for needle sizes 14 and 15, in gauges $\frac{1}{16}$ and $\frac{1}{8}$ in., for 212571 .....

No.	Plate	Name
211666	12092	Throat Plate, 50 needle hole, for needle sizes 14 and 15, in gauges $\frac{3}{8}$ , $\frac{13}{16}$ , $\frac{7}{8}$ , $\frac{15}{16}$ and $\frac{1}{2}$ in., for 211669 and 211670 .....
211667	12092	Throat Plate, 46 needle hole, for needle sizes 16 and 18, in gauges $\frac{3}{8}$ , $\frac{13}{16}$ , $\frac{7}{8}$ , $\frac{15}{16}$ and $\frac{1}{2}$ in., for 211669 and 211670 .....
211671	12092	Throat Plate, 50 needle hole, for needle sizes 14 and 15, in gauges $\frac{1}{2}$ , $\frac{11}{16}$ , $\frac{3}{4}$ , $\frac{13}{16}$ and $\frac{3}{4}$ in., for 211674 and 211675 .....
211672	12092	Throat Plate, 46 needle hole, for needle sizes 16 and 18, in gauges $\frac{1}{2}$ , $\frac{11}{16}$ , $\frac{3}{4}$ , $\frac{13}{16}$ and $\frac{3}{4}$ in., for 211674 and 211675 .....
211677	12093	Throat Plate, 46 needle hole, for needle sizes 16 and 18, in gauges $\frac{11}{16}$ , $\frac{3}{4}$ , $\frac{13}{16}$ and $\frac{1}{2}$ in., for 211679 and 211680 .....
211682	12093	Throat Plate, 46 needle hole, for needle sizes 16 and 18, in gauges $\frac{3}{8}$ and $\frac{7}{8}$ in., for 211684 and 211685 .....
211748	13148	Throat Plate, 46 needle hole, for needle sizes 16 and 18, in gauges from $\frac{3}{16}$ to $\frac{3}{4}$ in., in steps of $\frac{1}{16}$ in., for 211010 .....
211759	13148	Throat Plate, 50 needle hole, for needle sizes 14 and 15, in gauges $\frac{1}{2}$ , $\frac{11}{16}$ , $\frac{3}{4}$ , $\frac{13}{16}$ and $\frac{3}{4}$ in., for 211761 and 211762 .....
211760	13148	Throat Plate, 46 needle hole, for needle sizes 16 and 18, in gauges $\frac{1}{2}$ , $\frac{11}{16}$ , $\frac{3}{4}$ , $\frac{13}{16}$ and $\frac{3}{4}$ in., for 211761 and 211762 .....
211764	12104	Throat Plate, 46 needle hole, for needle sizes 16 and 18, in gauges $\frac{3}{8}$ , $\frac{13}{16}$ , $\frac{7}{8}$ , $\frac{15}{16}$ and $\frac{1}{2}$ in., for 211765, 211766 and 211933 .....
211768	12104	Throat Plate, 46 needle hole, for needle sizes 16 and 18, in $\frac{3}{4}$ in. gauge, for 211769 .....
211859	13148	Throat Plate, 46 needle hole, for needle sizes 16 and 18, in $\frac{1}{4}$ in. gauge, for 211652 .....
211879	13147	Throat Plate, 50 needle hole, for needle sizes 14 and 15, in gauges $\frac{3}{8}$ , $\frac{1}{2}$ and $\frac{5}{8}$ in., for 211298 and 211995 .....

No.	Plate	Name
212091	13149	Throat Plate, 46 needle hole, for needle sizes 16 and 18, in $\frac{1}{8}$ in. gauge, for 211904 .....

## FOR MACHINE No. 22w133

211771	13149	Throat Plate, 50 needle hole, for needle sizes 14 and 15, in $\frac{3}{8}$ in. gauge, for 212836 .....
213893	13149	Throat Plate, 50 needle hole, for needle sizes 14 and 15, in $\frac{1}{4}$ in. gauge, for 213894 .....

## FOR MACHINE No. 22w207

222212	13149	Throat Plate, 40 needle hole, for needle sizes 20 and 22, in gauges from $\frac{1}{4}$ to $\frac{3}{8}$ in., in steps of $\frac{1}{16}$ in., for 211754 .....
212242	13149	Throat Plate, 40 needle hole, for needle sizes 20 and 22, in $\frac{3}{4}$ in. gauge, for 231516 .....
231449	13149	Throat Plate, 31 needle hole, for needle sizes 25 and 26, in gauges from $\frac{1}{8}$ to $\frac{3}{4}$ in., in steps of $\frac{1}{16}$ in., for 231448 .....
231438	13138	Throat Plate, 31 needle hole, for needle sizes 25 and 26, in gauges from $\frac{1}{4}$ to $\frac{3}{8}$ in., in steps of $\frac{1}{16}$ in., for 211754 .....

## MISCELLANEOUS PARTS

## Used in conjunction with Thread Unwinder

60913	14083	Spool Weight with 60914 .....
60914	-----	“ “ Center Pin .....
225377	14083	“ Wire, for small spools .....

## OBSOLETE PARTS

No.	Plate	Name
222206	13150	Balance Wheel Locking Pin, for Machine No. 22w207 .....
202470	12320	Bobbin Winder Base .....
202471	12320	" " Frame .....
202472	12319	" " " Spring .....
202474	12320	" " Spindle .....
202477	12319	" " Stop Latch Thumb Lever .....
202480	12320	Bobbin Winder Spool Holder Base with 200355u and 202484 .....
202481	12320	Bobbin Winder Spool Holder Base Spool Pin .....
202482	12319	Bobbin Winder Spool Holder Tension Disc (lower or upper) .....
202483	12319	Bobbin Winder Spool Holder Tension Disc Spring (brass) .....
202484	12319	Bobbin Winder Spool Holder Tension Disc Thread Guide .....
202485	12320	Bobbin Winder Spool Holder complete, Nos. 200011e, 202480, 202481, 202483, two 202482 and one wood screw 1 in., No. 13 .....
227522	12319	Bobbin Winder Stop Latch .....
227523	12320	Bobbin Winder complete, Nos. 200056e, 200161d, 200221d, 201537u, 202470 to 202474, 202477, 202478, 227522, three 200299u and two round head wood screws $\frac{3}{4}$ in., No. 13 .....
213110	—	Face Plate with 200366u, 202087, 204185, 204730, two each 202090, 204281, three each 200368u and 200397u, for 213111 .....
213111	13137	Face Plate complete, Nos. 200577u, 204731, 204795, 213110, two each 204059 and 206639, for Machine No. 22w207 .....
*213605	—	Feed Driving Cam Fork Lever Slide Block .....
*213604	—	Feed Driving Cam Fork Lever Slide Block with 200116c .....
213606	13041	Feed Driving Cam Fork Lever Slide Block 213604 with 213605 .....

No.	Plate	Name
203250	11007	Hook Driving Shaft Collar with two 200393c .....
204870	12333	Needle Bar (hollow), for all Machines except No. 22w38 .....
229663	11802	Needle Bar (hollow), for Machine No. 22w38 .....
204792	10486	Needle Bar Connecting Link with 200188c, for Machine No. 22w207 .....
203703	12164	Needle Holder, in gauges $\frac{3}{16}$ , $\frac{1}{4}$ and $\frac{5}{16}$ in., with 200068u and two 200141e, for Machines Nos. 22w23, 22w25 and 22w111 .....
203704	12332	Needle Holder, in gauges from $\frac{3}{16}$ to $\frac{1}{2}$ in., in steps of $\frac{1}{32}$ in., with 200068u and two 200141e, for Machines Nos. 22w23, 22w111 and 22w133 .....
203705	13150	Needle Holder, in gauges from $\frac{1}{16}$ to $\frac{3}{4}$ in., in steps of $\frac{1}{16}$ in., with 200068u and two 200141e, for Machine No. 22w111 .....
203714	13150	Needle Holder, in gauges $\frac{1}{4}$ and $\frac{5}{16}$ in., with 200068u and two 200141e, for Machine No. 22w113 .....
213896	13150	Needle Holder, in gauges from $\frac{3}{16}$ to $\frac{1}{2}$ in., in steps of $\frac{1}{32}$ in., with 200068u and two 200141e, for Machine No. 22w113 .....
213897	13150	Needle Holder, in gauges from $\frac{1}{16}$ to $\frac{3}{4}$ in., in steps of $\frac{1}{16}$ in., with 200068u and two 200141e, for Machine No. 22w113 .....
213918	13150	Needle Holder, in gauges from $\frac{3}{16}$ to $\frac{3}{4}$ in., in steps of $\frac{1}{16}$ in., for trimming .060 and .085 in., with 200068u, 200141e and 200389c, for Needle Bar 204870, for Machine No. 22w38 .....
229665	13150	Needle Holder, in gauges from $\frac{3}{16}$ to $\frac{3}{8}$ in., in steps of $\frac{1}{32}$ in., for trimming .035, .045, .060, .085 and .125 in., with 200141e, 200389c and two 200581u, for Needle Bar 229663, for Machine No. 22w38 .....
213100	11868	Take-up Cam Key, for Machine No. 22w207 .....
206639	—	Tension complete, Nos. 200632b, 201572b, 202407, 204271 and two 202402 .....

No.	Plate	Name
215612	—	Vibrating Presser Bar, for 204489..
204489	13041	" " " 215612 with 204493 and two 200138d, for Ma- chine No. 22w113 .....
215628	—	Vibrating Presser Bar, for 204488..
204488	13041	" " " 215628 with 204493 and two 200138d, for Ma- chine No. 22w113 .....
204492	13041	Vibrating Presser Bar Position Guide, for Machine No. 22w113..
204625	13041	Vibrating Presser Foot, for Ma- chine No. 22w113 .....
204631	13041	Vibrating Presser Foot, for Ma- chine No. 22w113 .....
204635	13150	Vibrating Presser Foot, for Ma- chine No. 22w113 .....
229643	14004	Vibrating Presser Foot, for Ma- chine No. 22w113 .....
229647	14067	Vibrating Presser Foot, for Ma- chine No. 22w113 .....

## NUMERICAL LIST OF PARTS

No.	Plate	Name
208E	13138	Thread Unwinder Thread Guide Rod Screw, for 224392 .....
2102	10881	Bobbin Winder Tension Disc, for 225462 .....
36578	12345	Oiler with 36579 .....
36579	12345	" Spout, 3½ in. long, with 120117, for 36578 .....
41400	12345	Machine Rest Pin (wood) .....
60913	14083	Spool Weight with 60914 .....
60914	—	" " Center Pin, for 60913
120117	—	Oiler Spout Washer (leather), for 36578 .....
200002E	12332	Feed Driving Cam Fork Lever Con- nection Hinge Screw, for 206554 and 206555 .....
200006E	11007	Hook Saddle Screw .....
200010E	11044	Arm Screw, for Machine No. 22w207
200011E	12319	Bobbin Winder Spool Holder Ten- sion Disc Screw, for 202485 ....
200027E	12332	Feed Lifting Cam Fork Pinch Screw, for 204202 .....
200031E	12311	Feed Driving Cam Fork Lever Con- nection Clamp Pinch Screw, for 204194 .....
200042E	12311	Take-up Lever Bearing Screw, for 204554 and 213109 .....
200043C	12311	Feed Driving Cam Fork Lever Shaft Sleeve Set Screw .....
200043C	12311	Feed Driving Rock Shaft Center Set Screw .....
200043C	12311	Feed Lifting Rock Shaft Center Set Screw .....
200045E	12332	Feed Lifting Cam Screw, for 213154
200053C	12311	Face Plate Screw .....
200053C	12311	Vibrating Presser Bar Position Stop Screw, for Machine No. 22w113 .....
200054E	12307	Arm Shaft Connection Screw, for 204440 and 204706 .....
200056E	10884	Bobbin Case Lever Fulcrum Screw, for 203508 .....
200056E	10884	Bobbin Winder Stop Latch Screw, for 225382 and 227523 .....

PLATE 10483—FULL SIZE

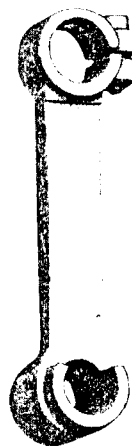
200181



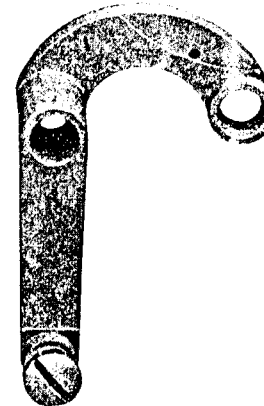
202088



204484



204475



200309



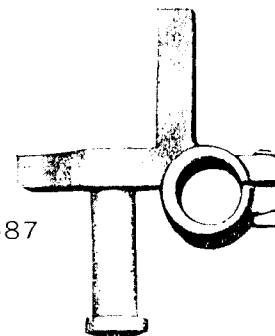
200122



200188



204480



200685



204487



200587



204478





PLATE 10486—FULL SIZE

204789



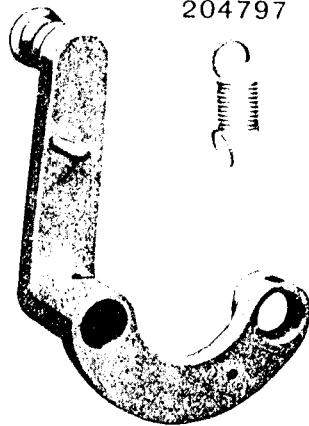
204795



204794



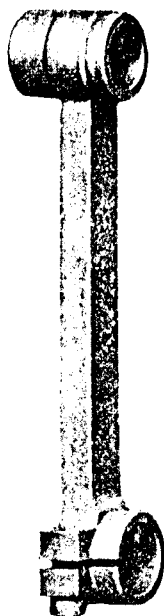
204786



204797



204792



204790

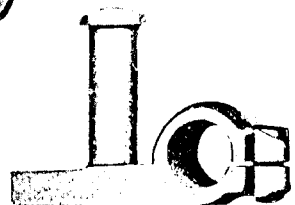
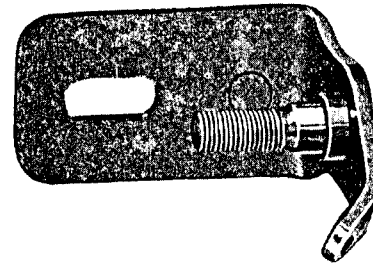


PLATE 10881—FULL SIZE

225461



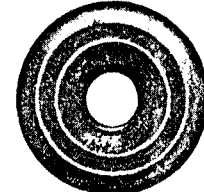
200082



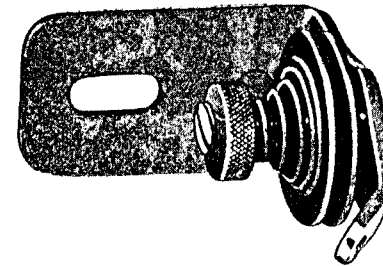
202104



2102



225462



202407



201499



201572



PLATE 10884—FULL SIZE

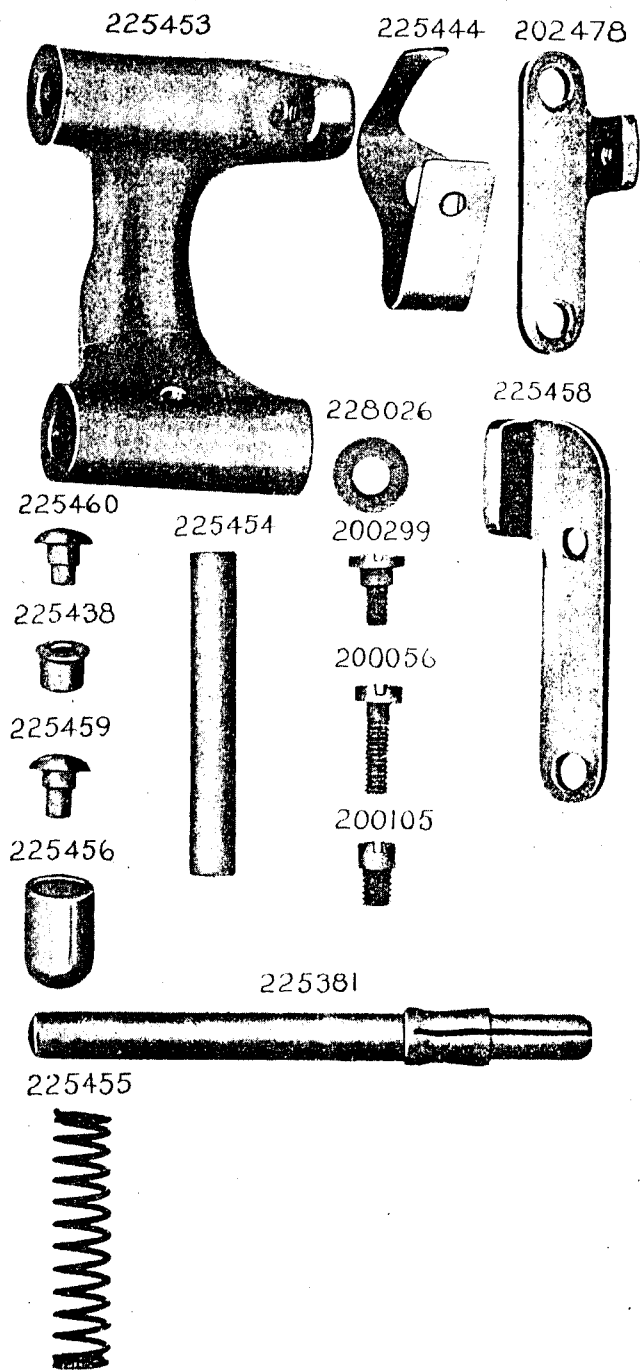


PLATE 10885—ONE-FOURTH SIZE

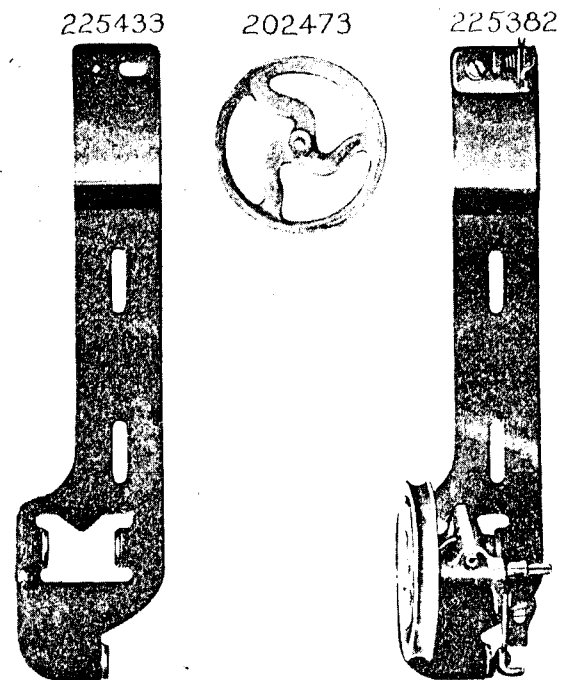


PLATE 11007—FULL SIZE

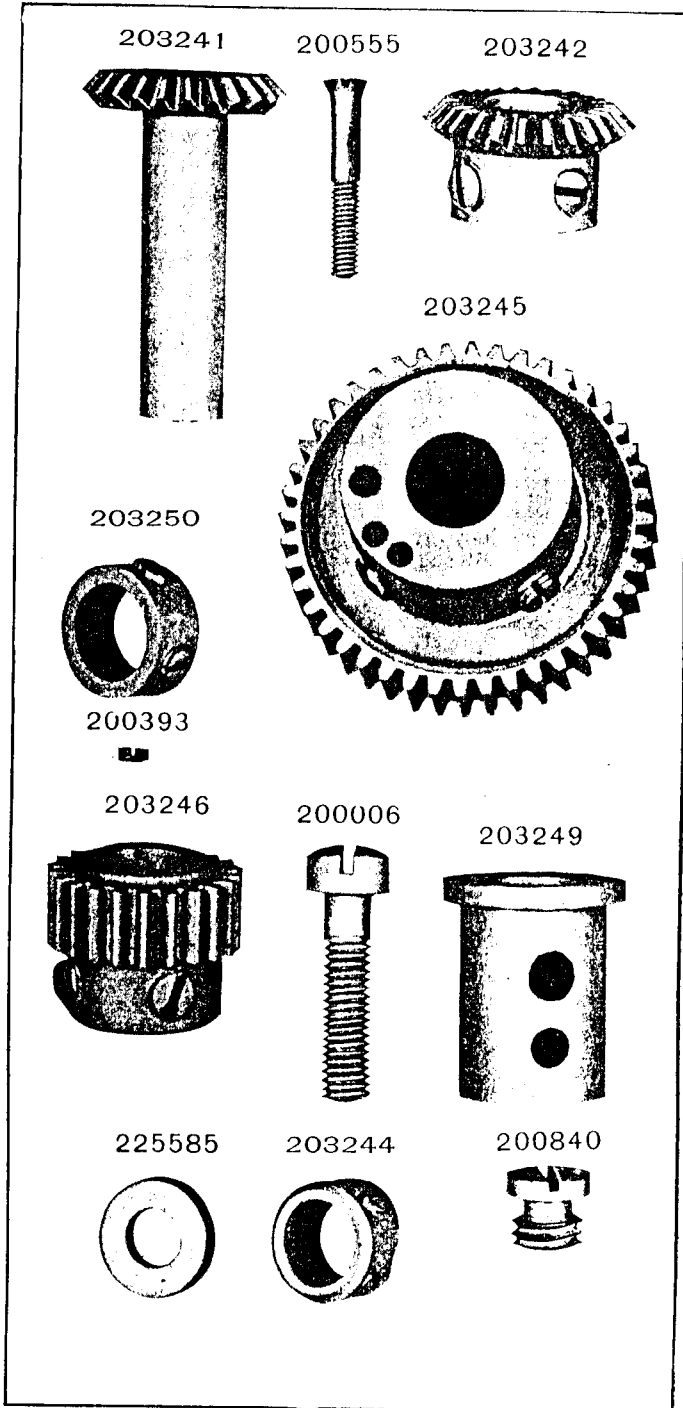


PLATE 11018—FULL SIZE

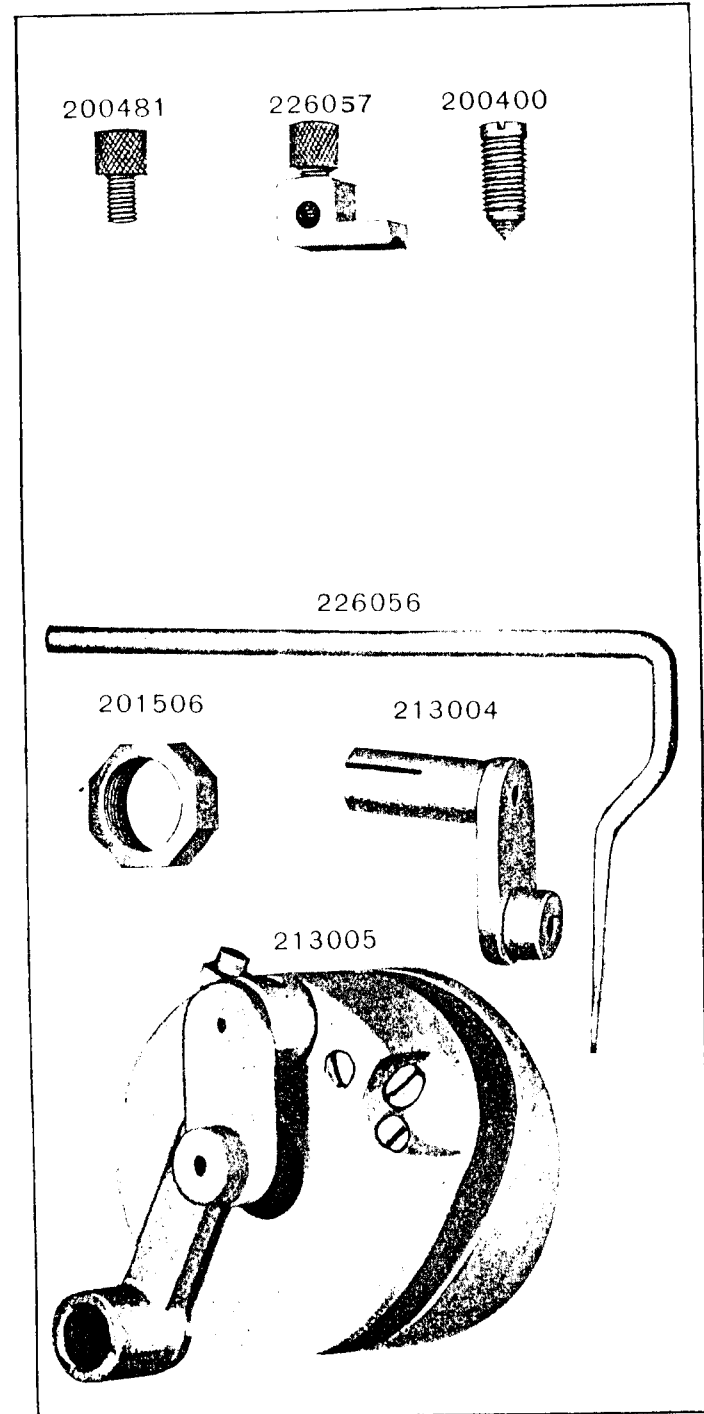


PLATE 11029—FULL SIZE

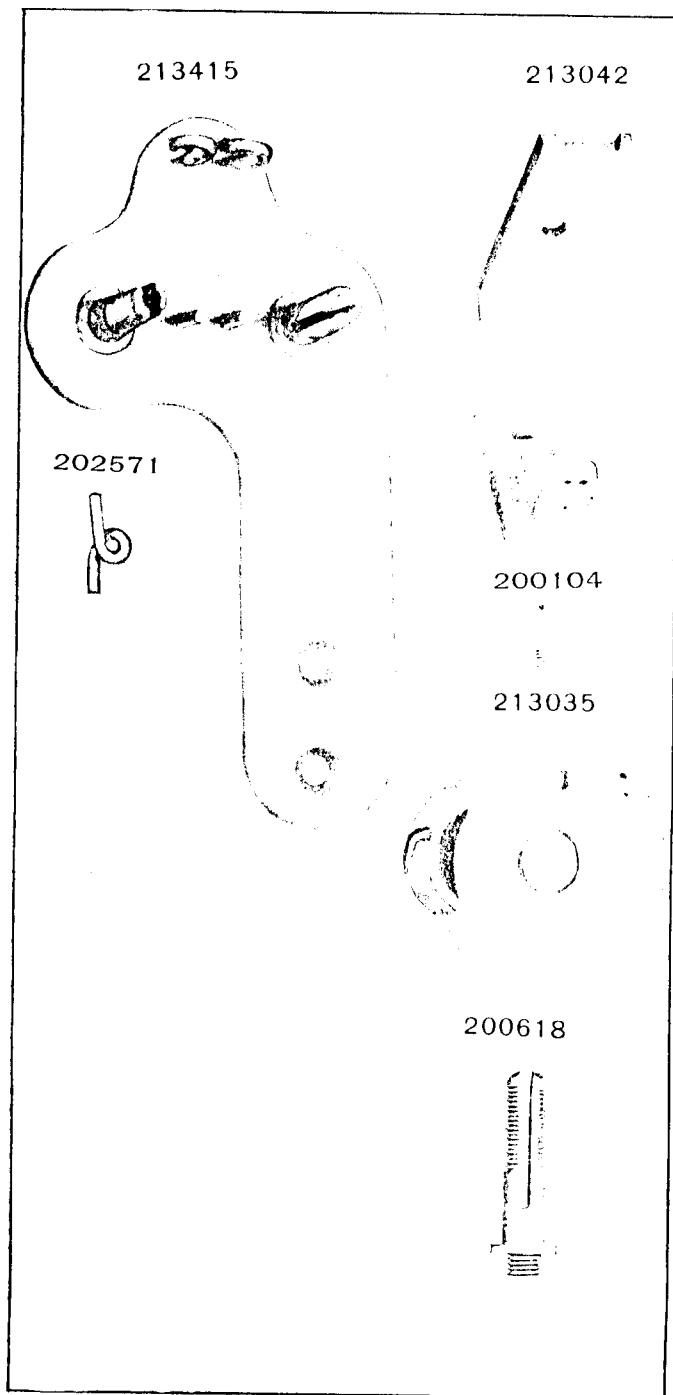


PLATE 11035—FULL SIZE

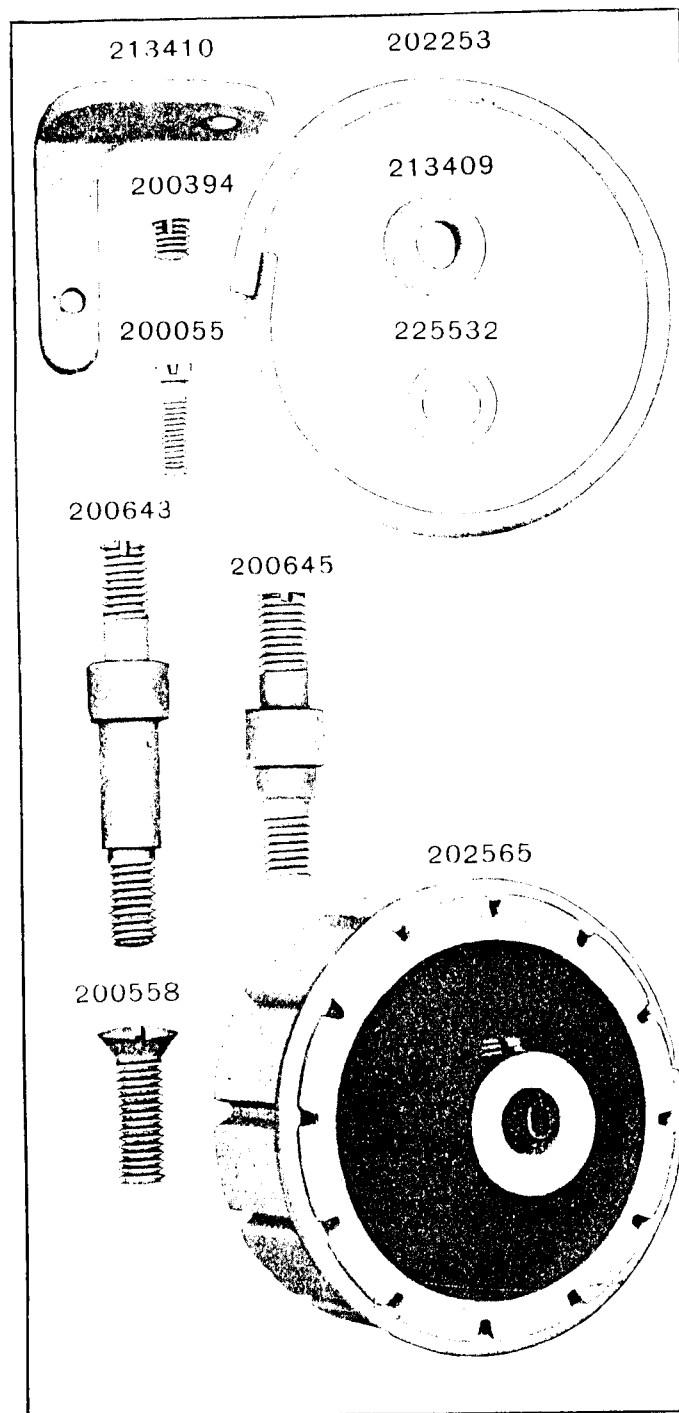


PLATE 11036—FULL SIZE

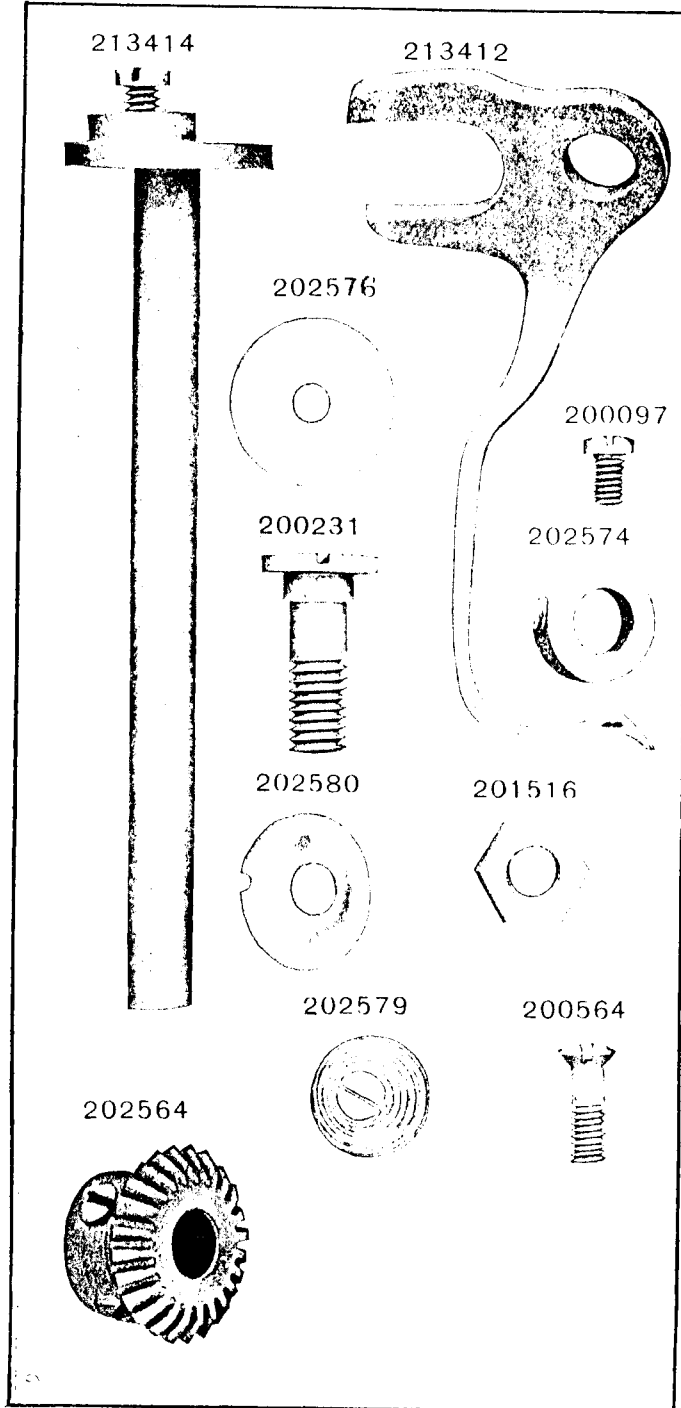


PLATE 11041—FULL SIZE

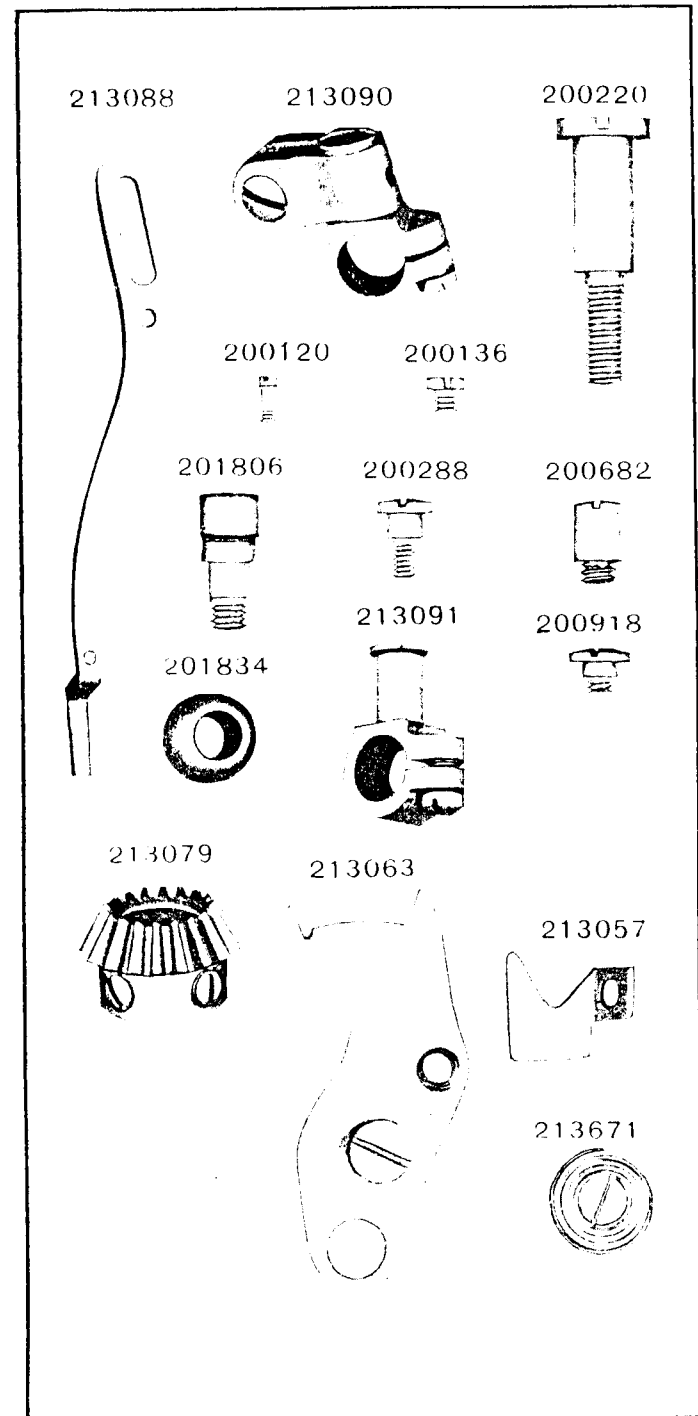


PLATE 11042—ONE-HALF SIZE

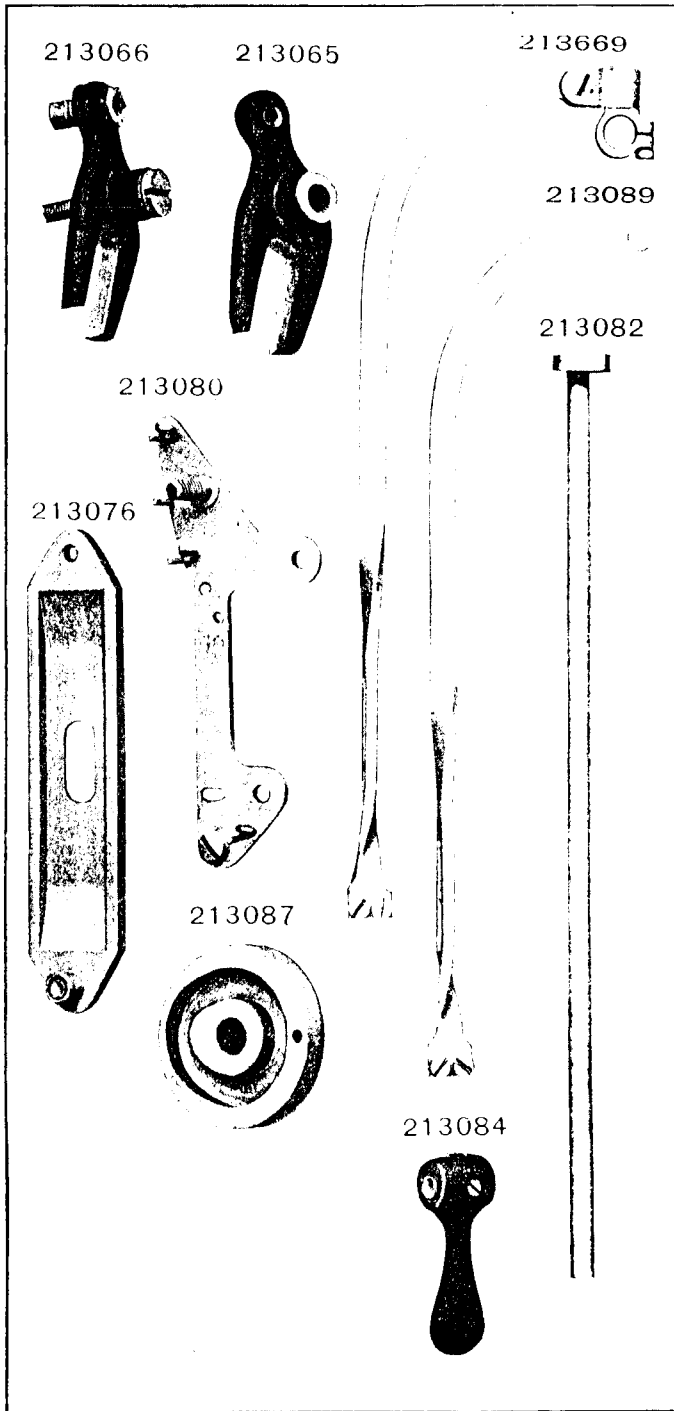


PLATE 11043—FULL SIZE

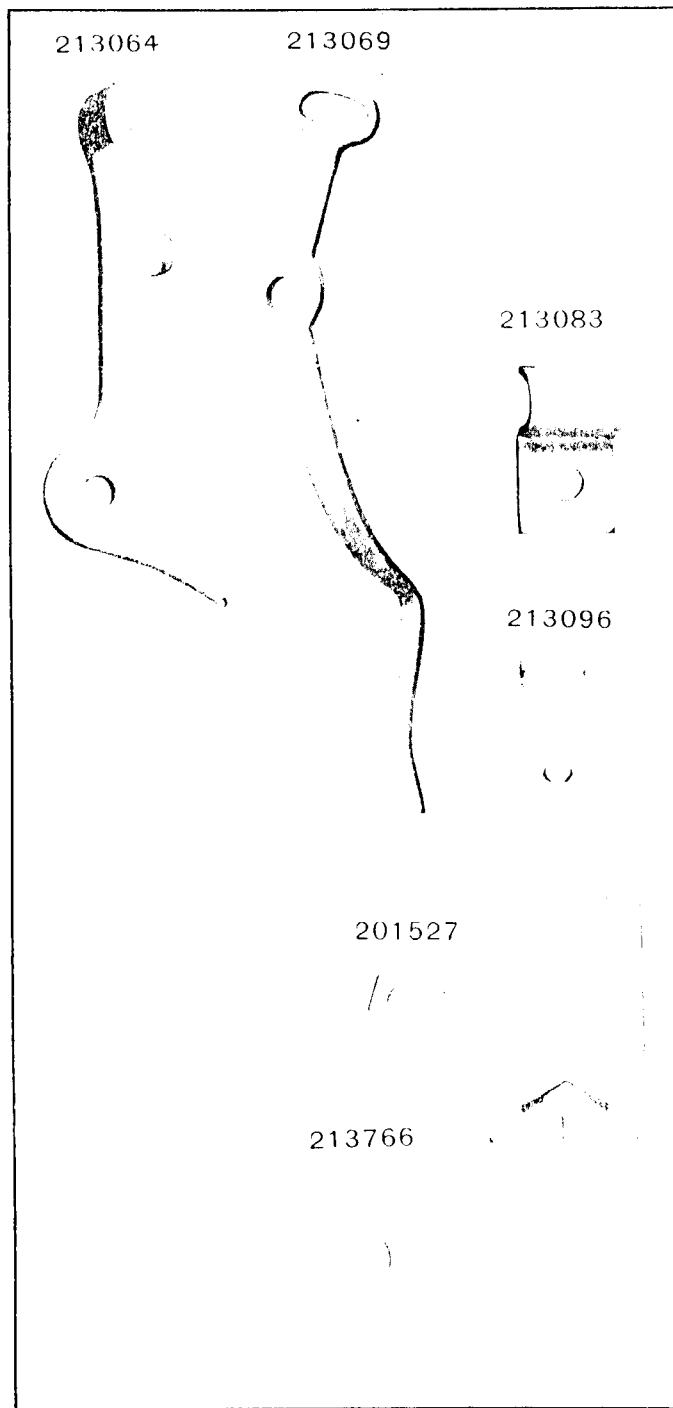


PLATE 11044—FULL SIZE

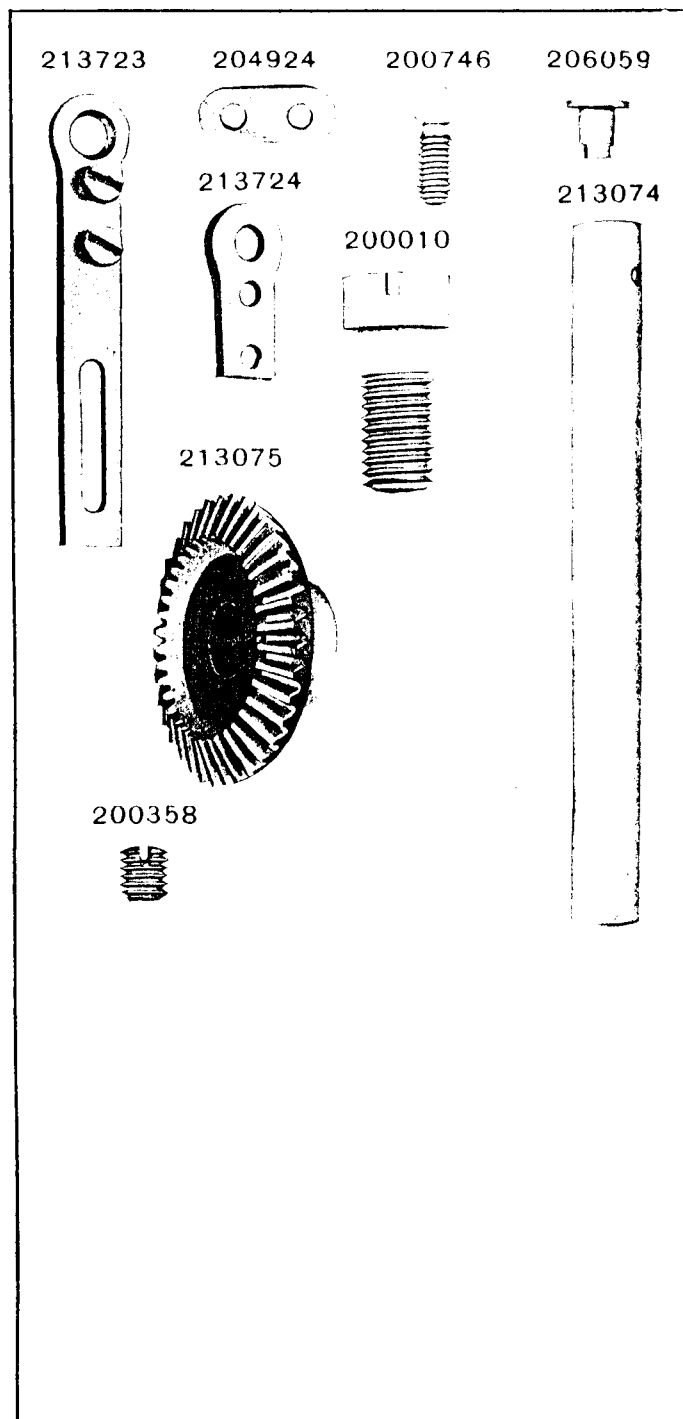


PLATE 11125 —ONE—FOURTH SIZE

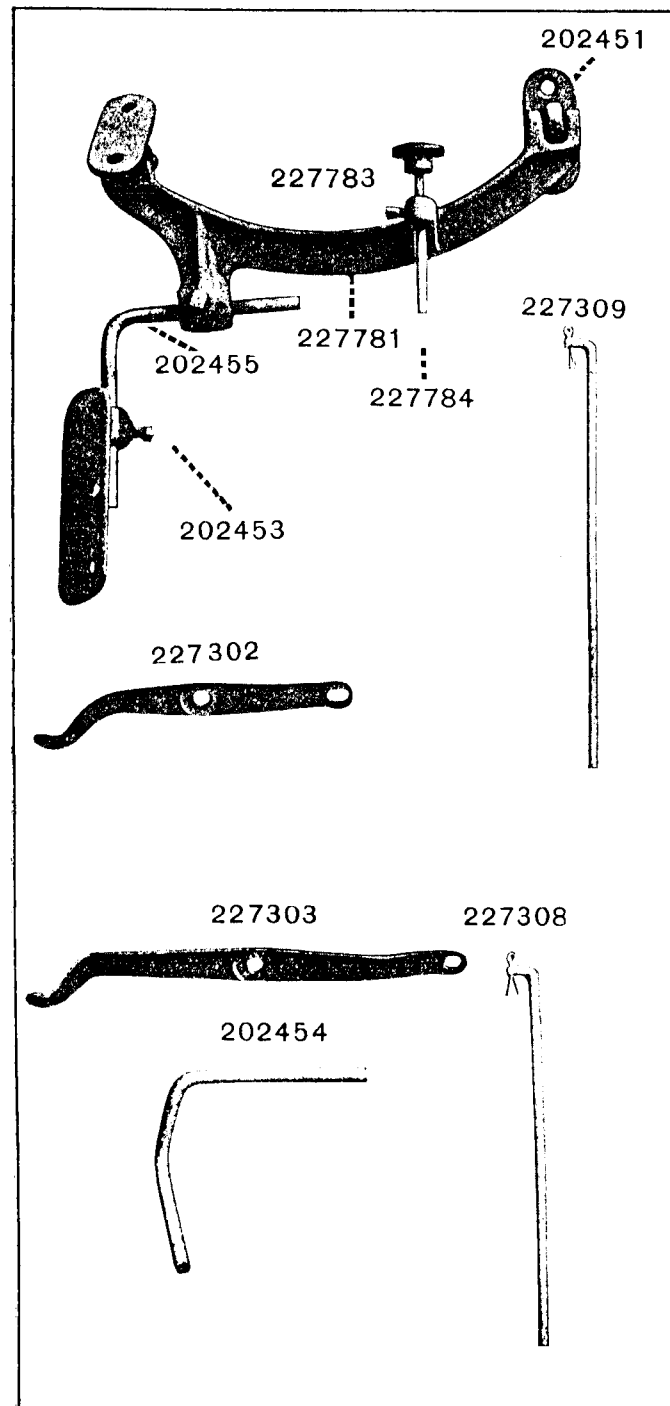


PLATE 11140 - FULL SIZE

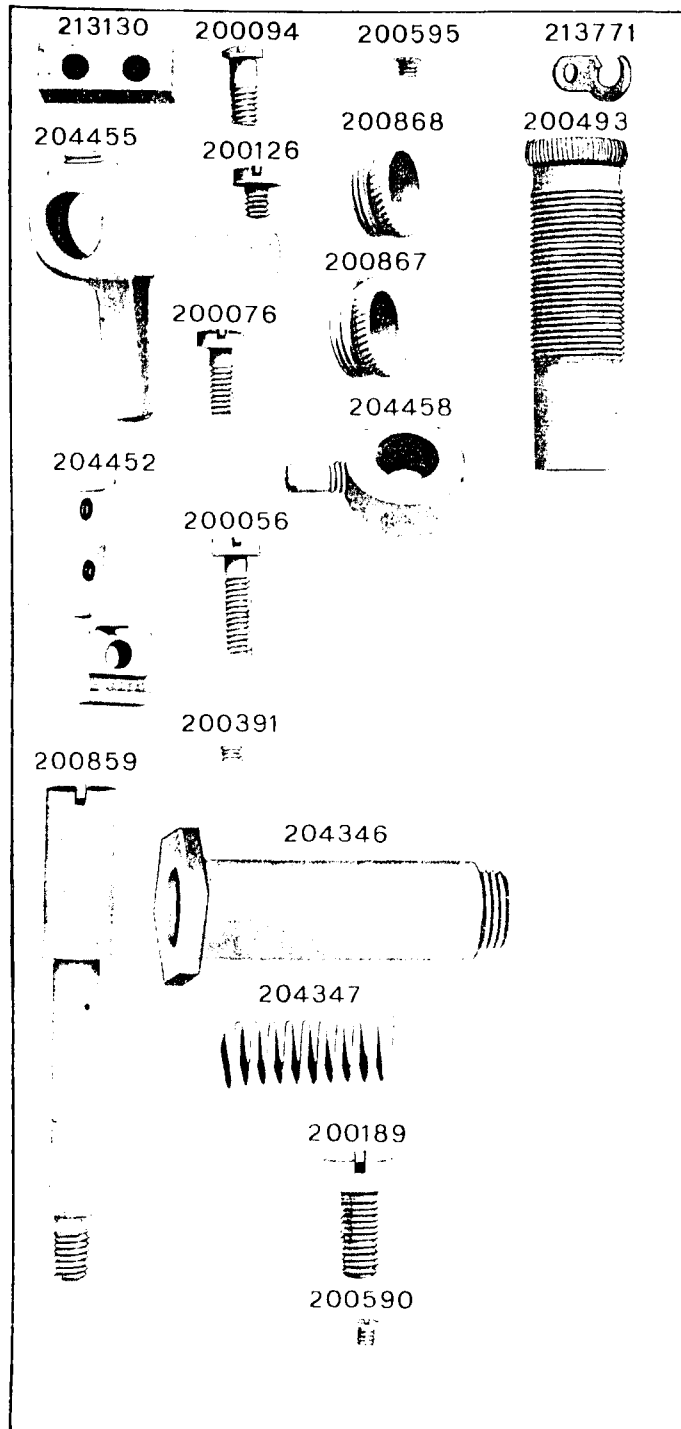


PLATE 11142 - FULL SIZE

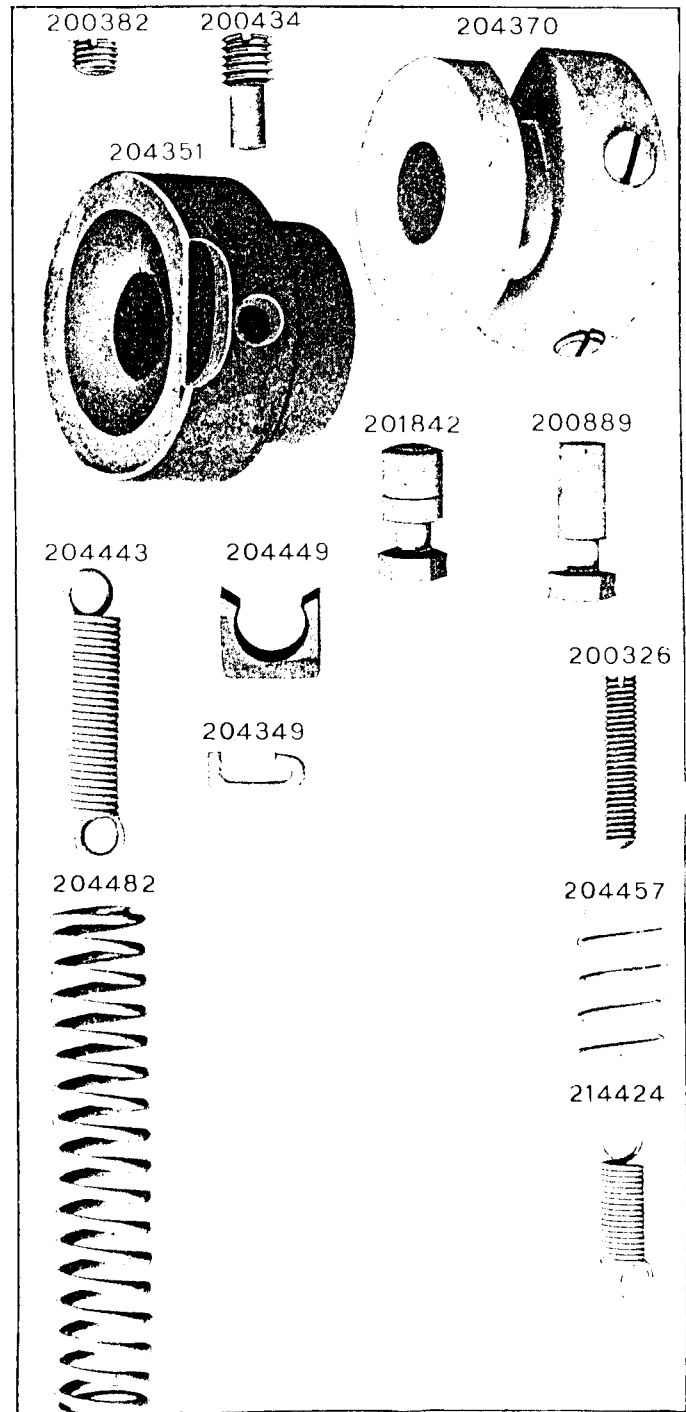




PLATE 11235—FULL SIZE

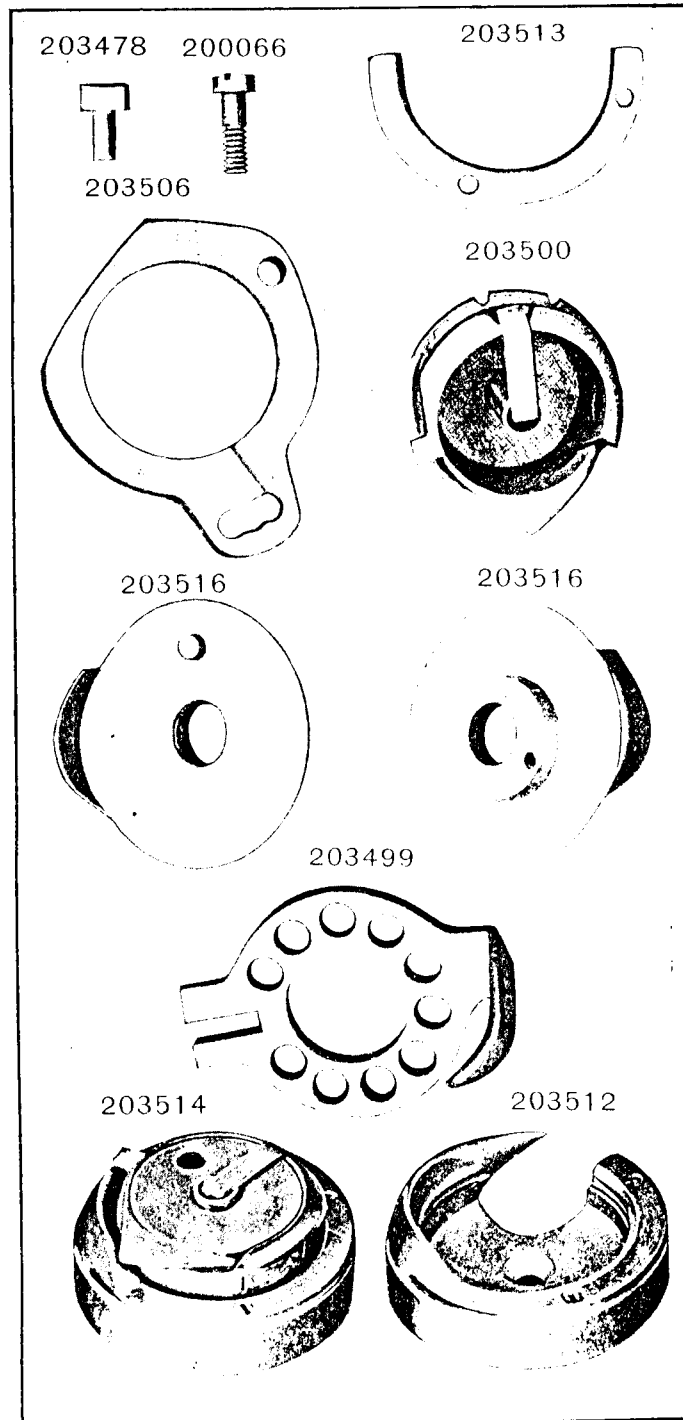


PLATE 11236—ONE-HALF SIZE

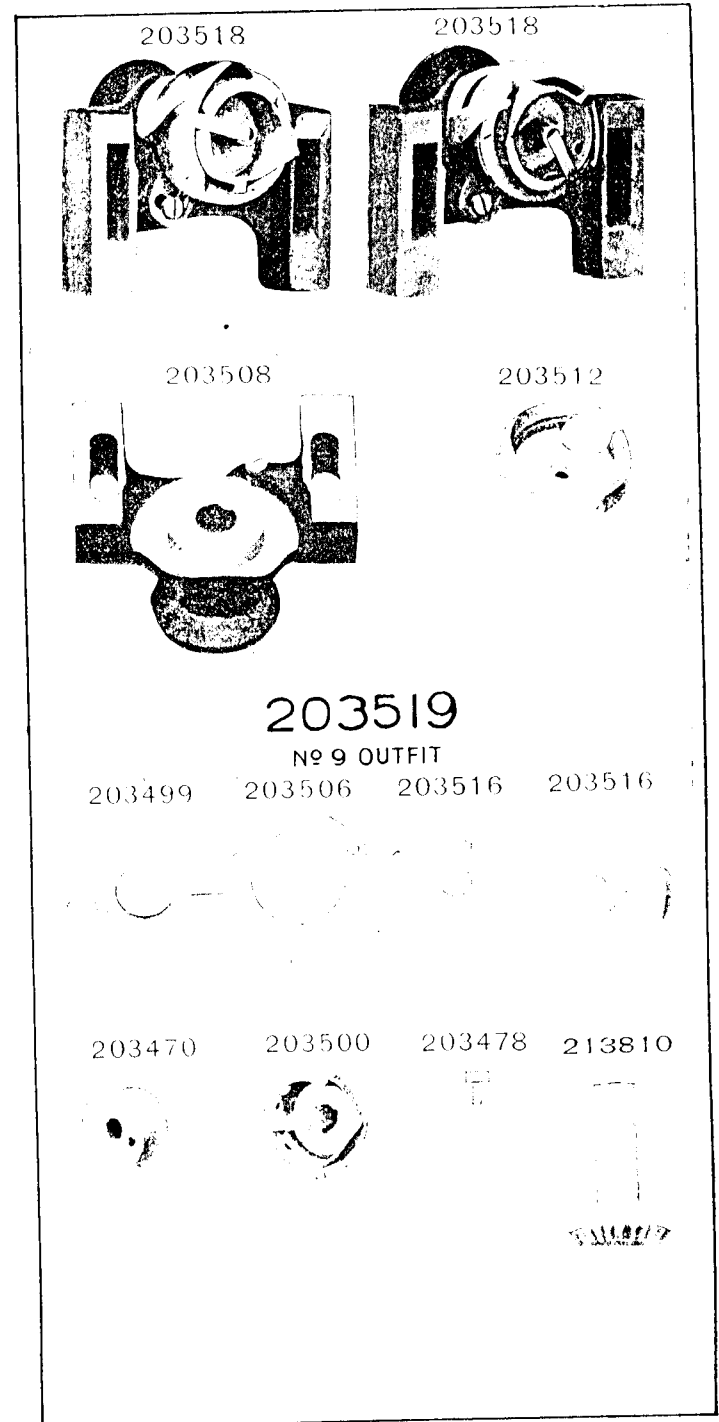


PLATE 11801—FULL SIZE

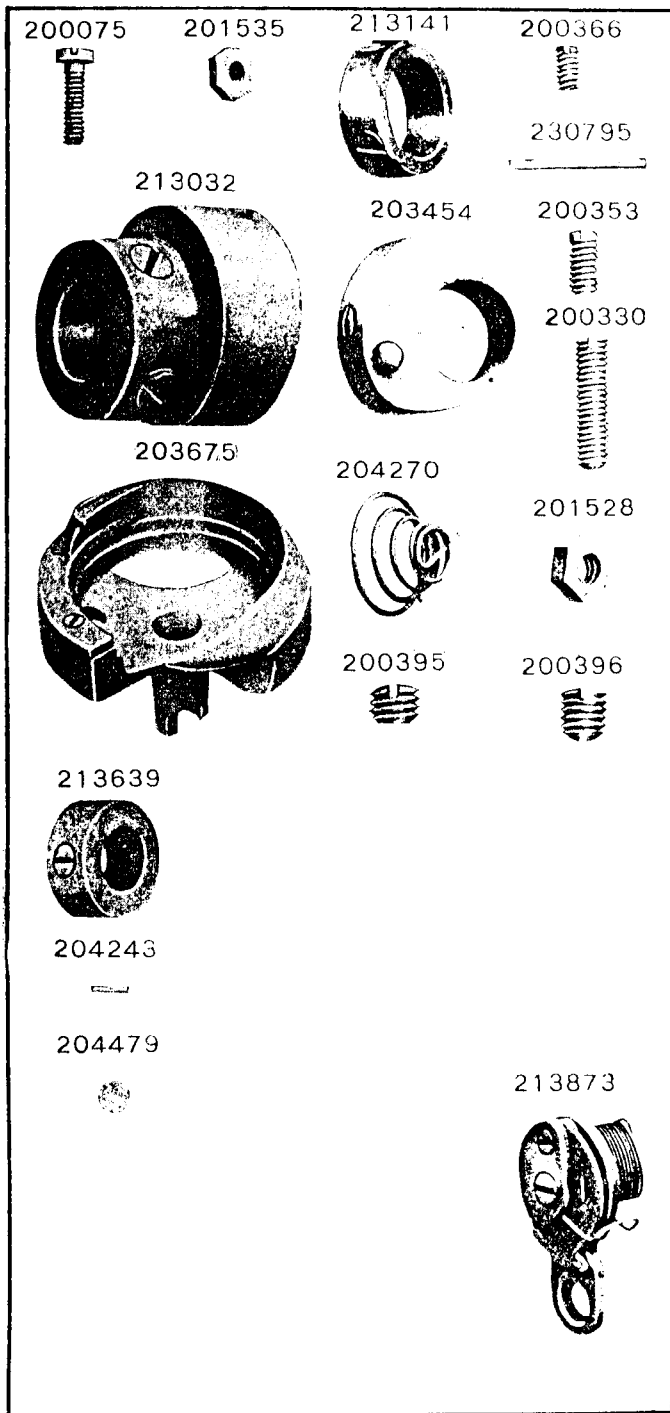


PLATE 11802—ONE-HALF SIZE

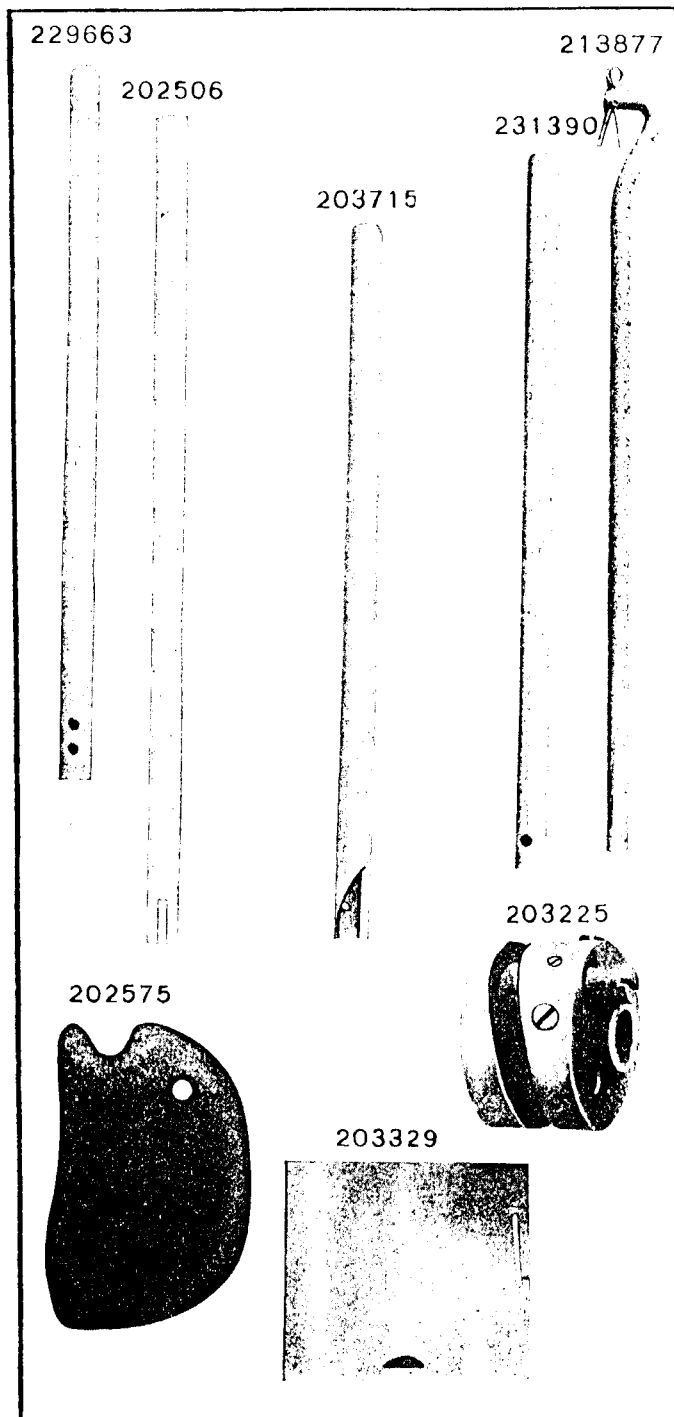


PLATE 11803--FULL SIZE

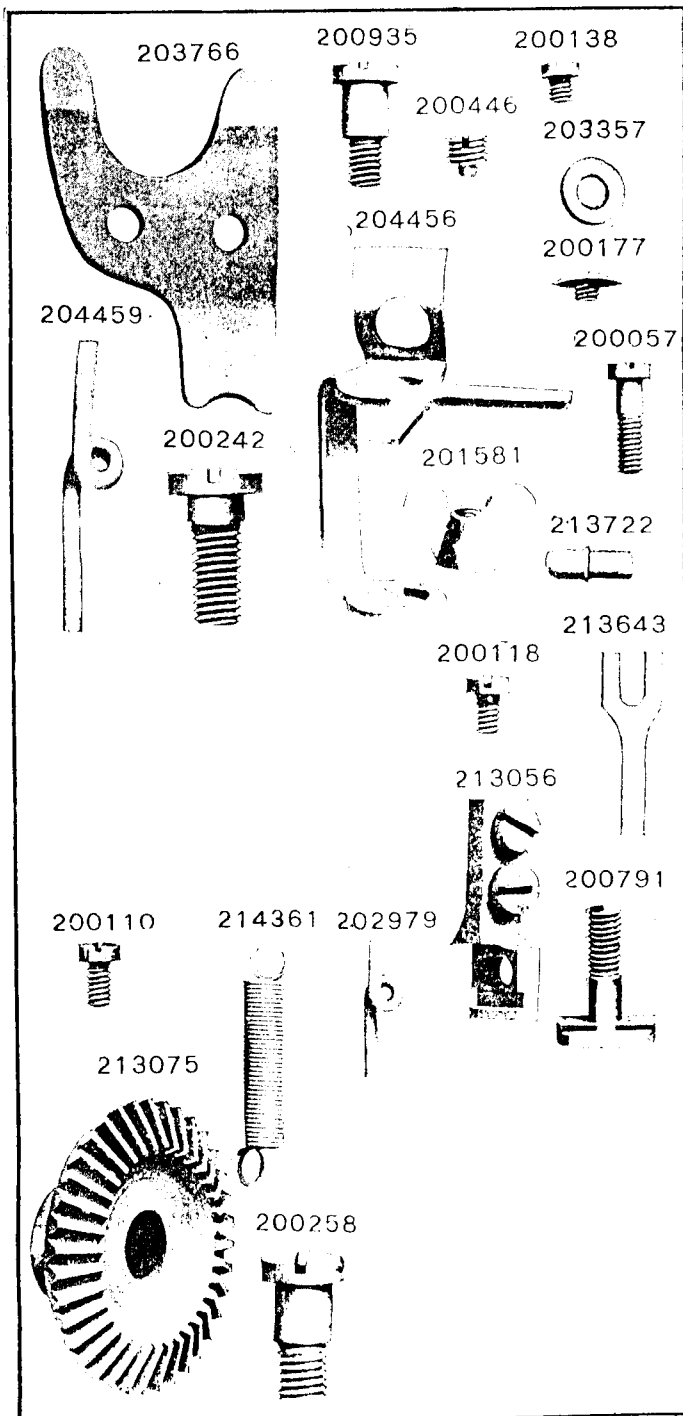


PLATE 11804--ONE-FOURTH SIZE

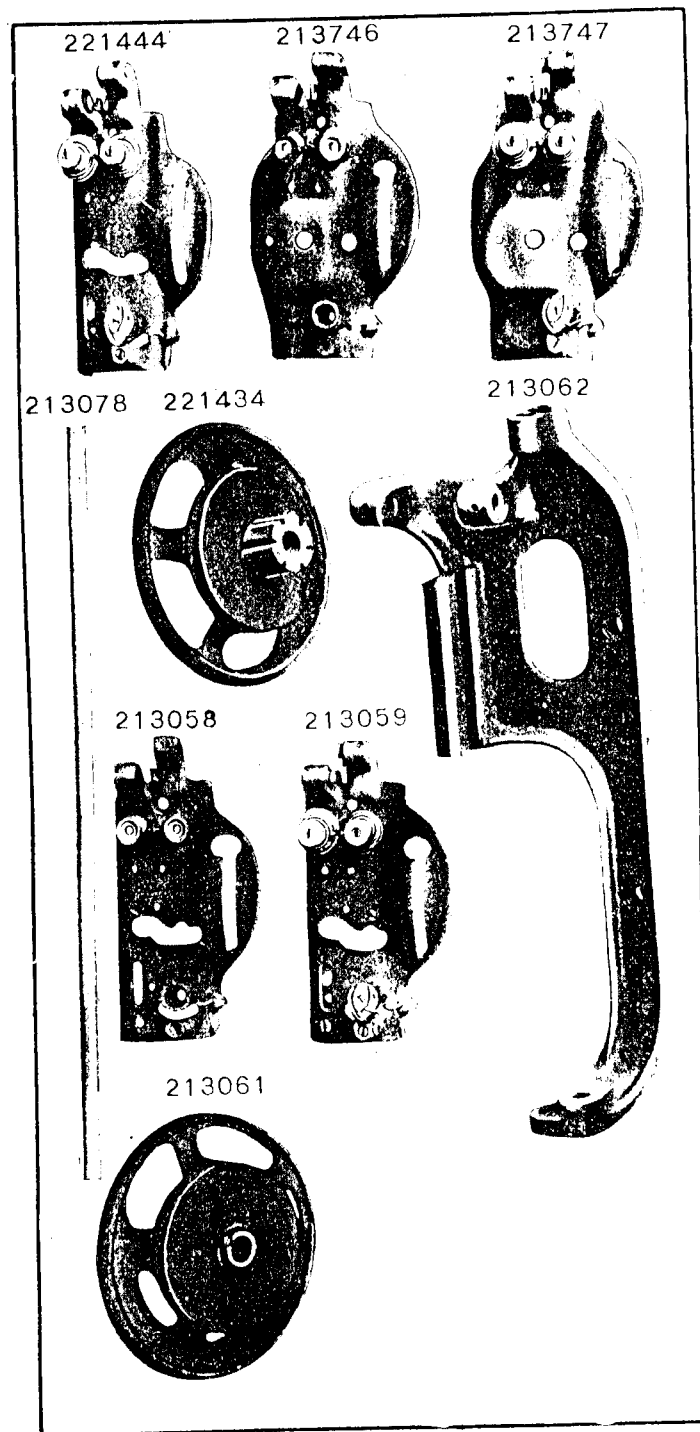


PLATE 11805 - ONE-HALF SIZE

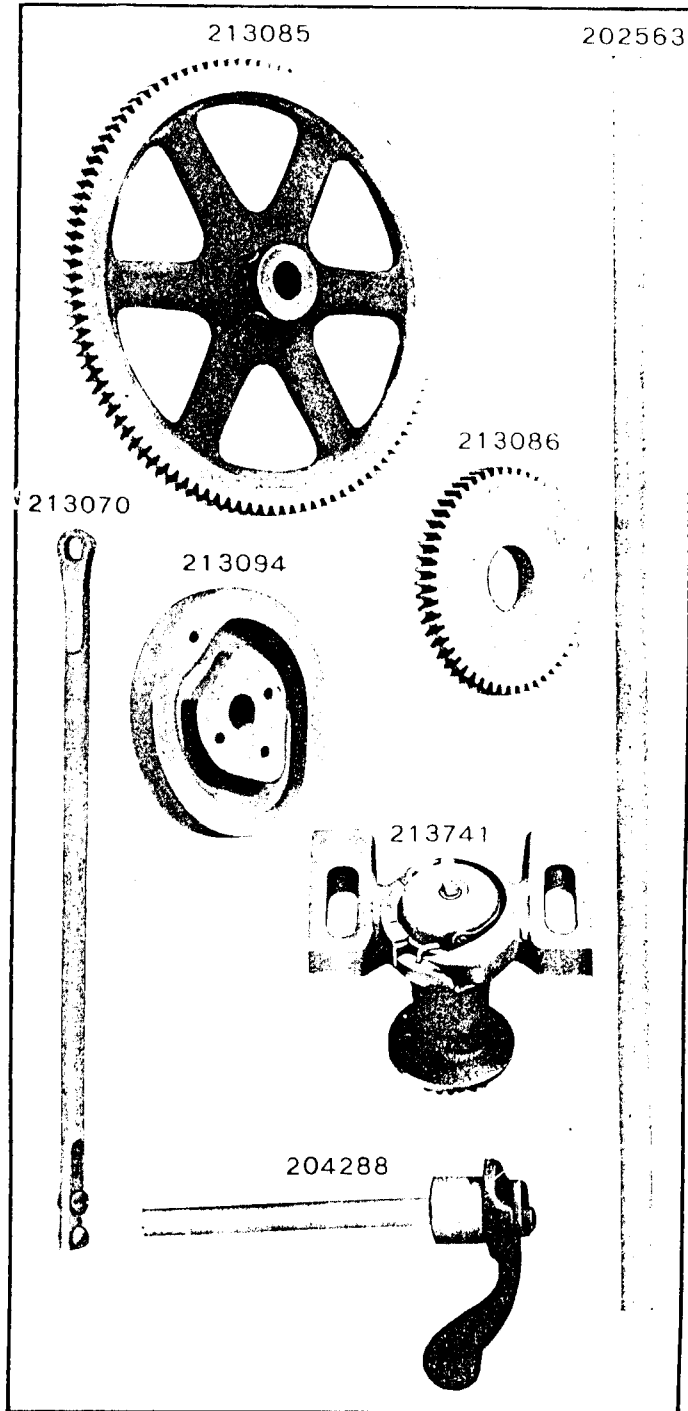


PLATE 11808 - FULL SIZE

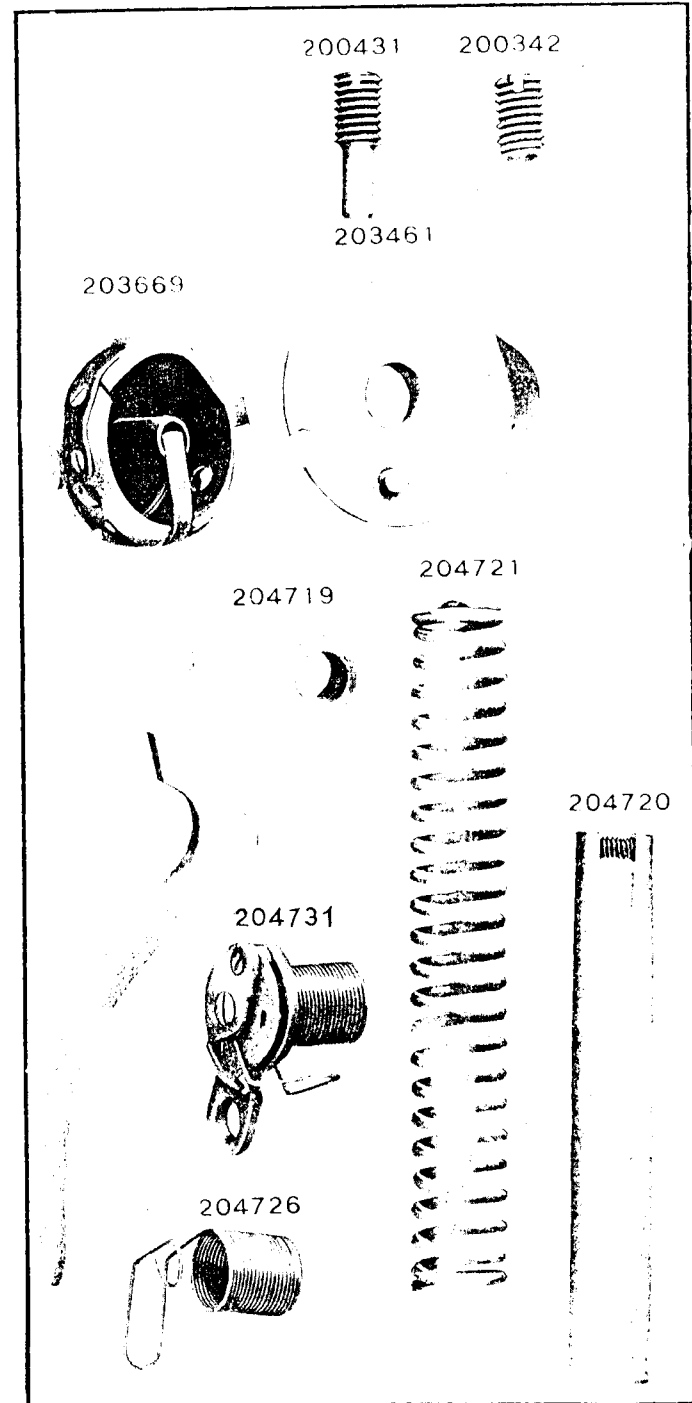
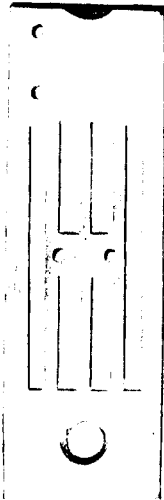
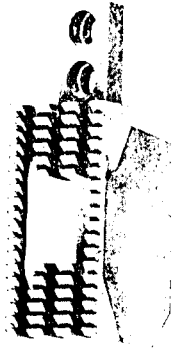


PLATE 11813 -FULL SIZE

211052  
211053  
211054



236411



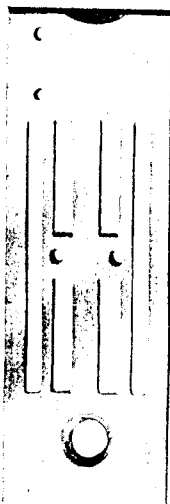
212571



211048  
211050  
211614



211056  
211057  
211058



236419

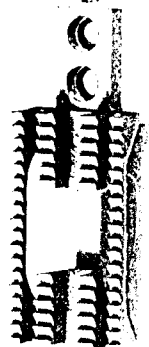
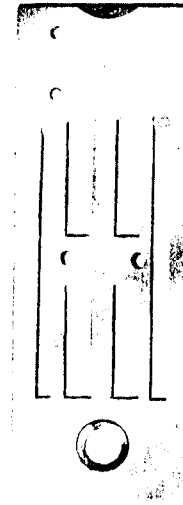


PLATE 11814 -FULL SIZE

211059  
211060  
211061



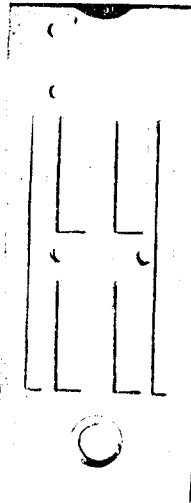
236423



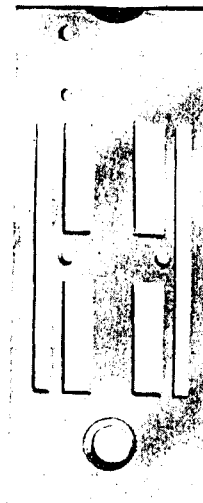
212474



211062  
211063  
211064



211065  
211066  
211067



212169



PLATE 11823 - FULL SIZE

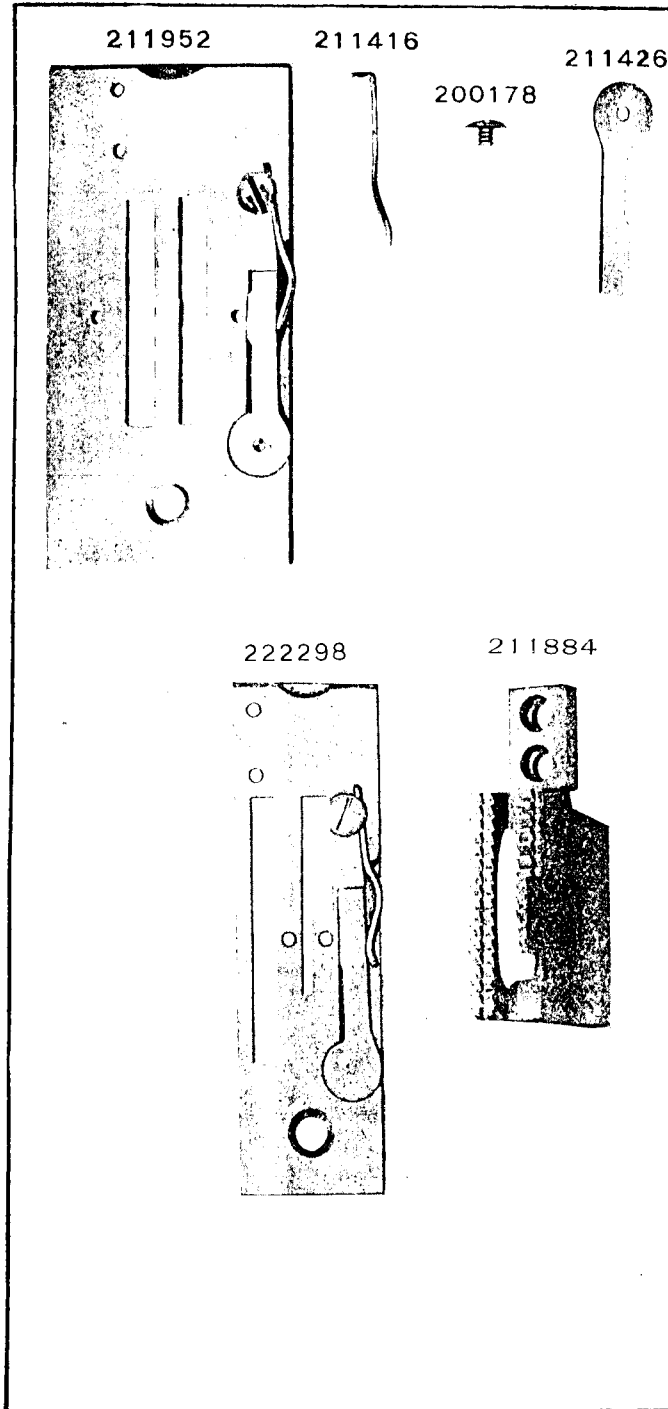


PLATE 11839 - FULL SIZE

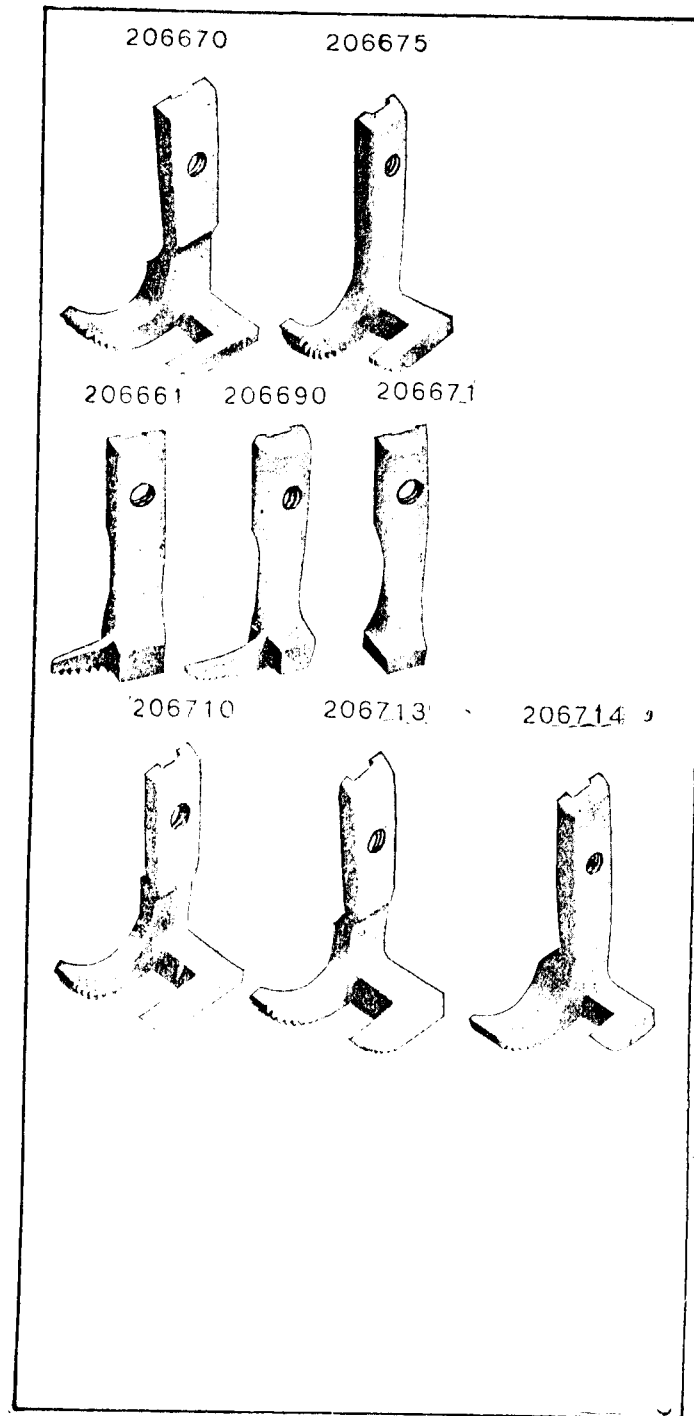


PLATE 11857 -FULL SIZE

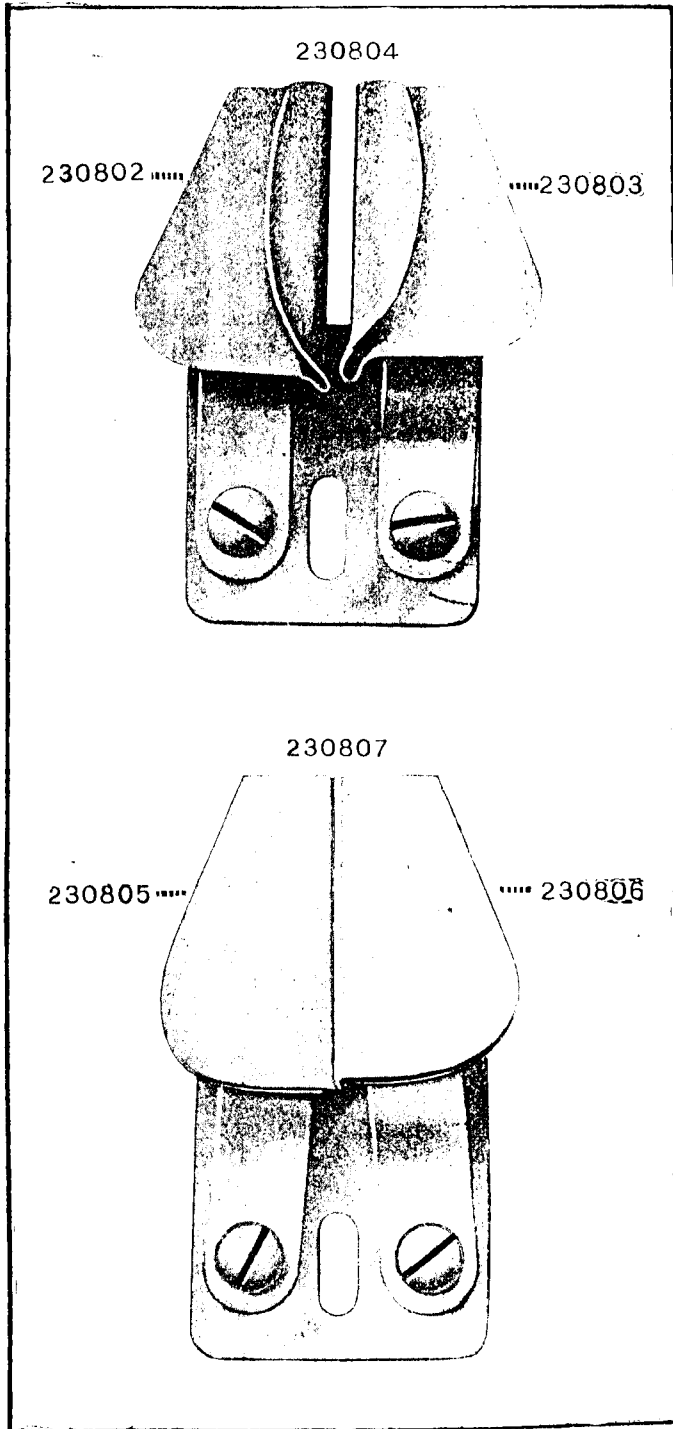


PLATE 11868 -FULL SIZE

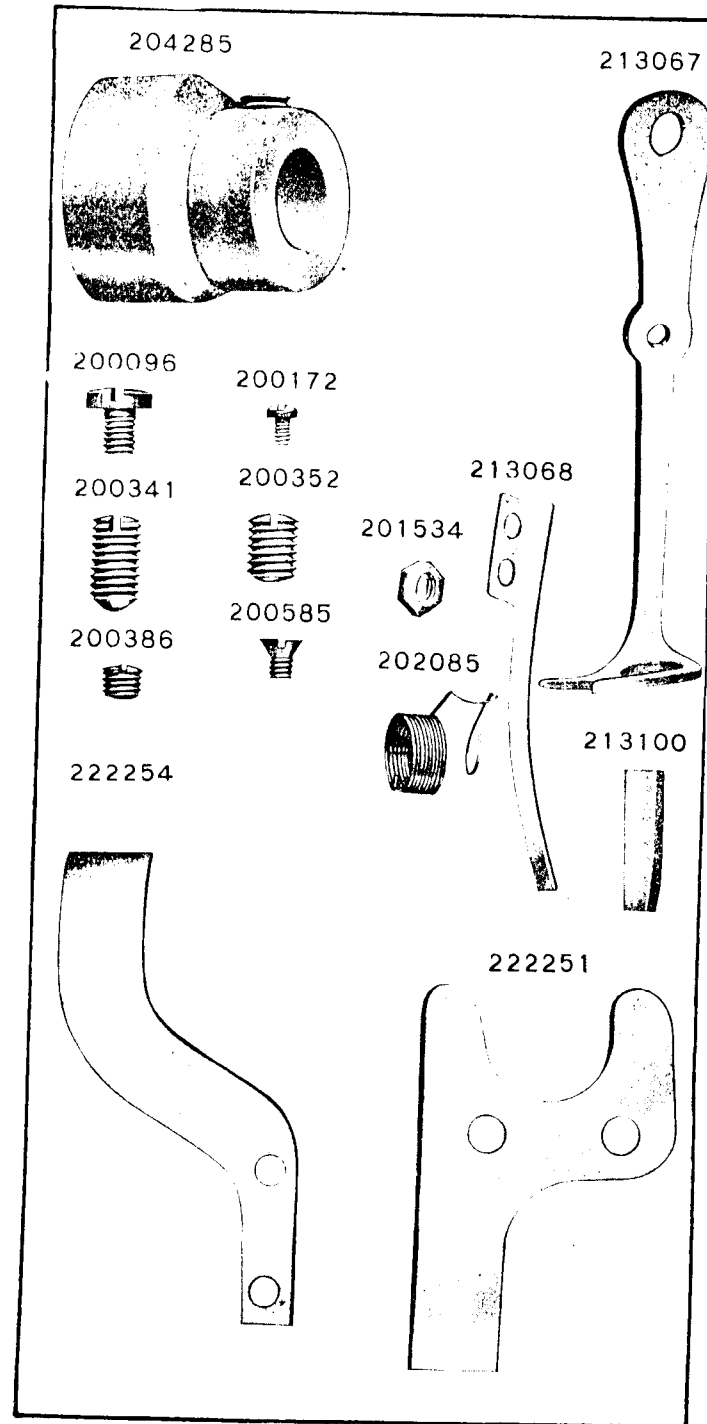
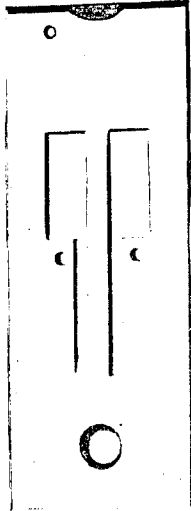


PLATE 12092—FULL SIZE

211666  
211667  
211668



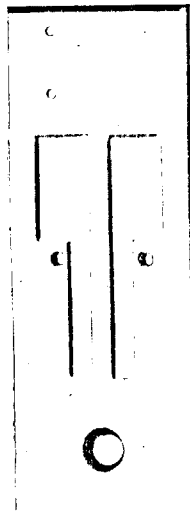
211669



211670



211671  
211672  
211673



211674

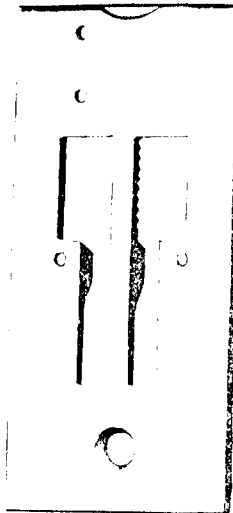


211675



PLATE 12093—FULL SIZE

211676  
211677  
211678



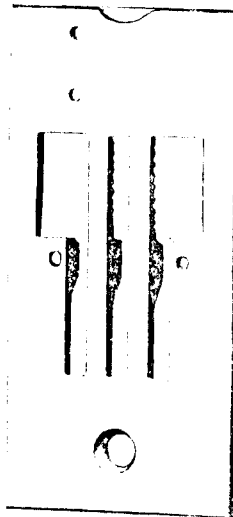
211679



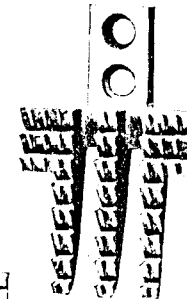
211680



211681  
211682  
211683



211684



211685

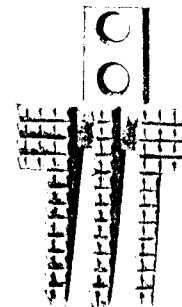
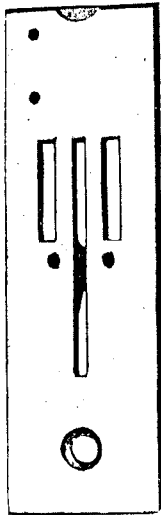


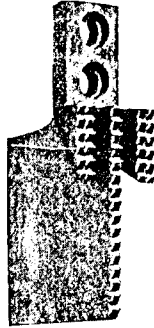


PLATE 12099—FULL SIZE

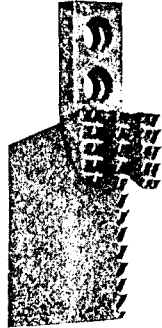
211715  
211716



211717



211718



211721



211722



211719  
211720

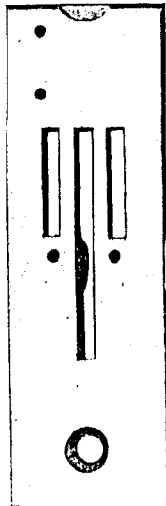
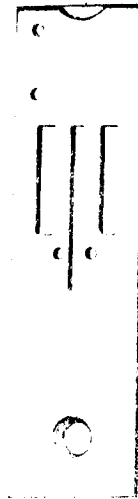
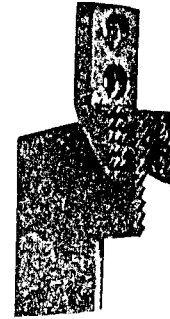


PLATE 12100—FULL SIZE

211723  
211724



211725



211726  
211727



211728



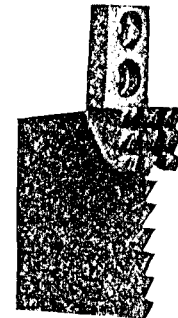
211018  
211731



211732



211729

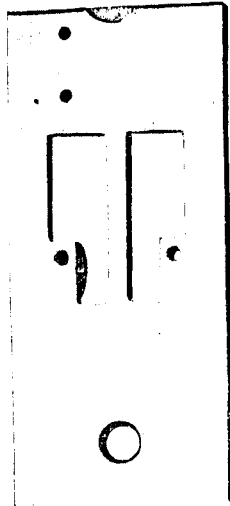


211733



PLATE 12104—FULL SIZE

211763  
211764



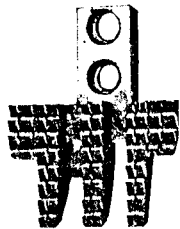
211765



211766



211769



211770



211767  
211768

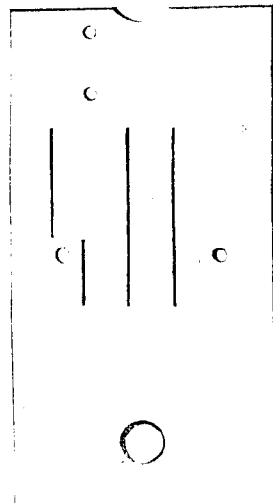
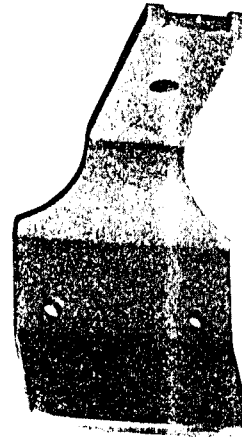
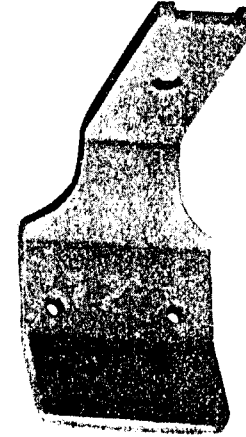


PLATE 12164—FULL SIZE

229107



229106



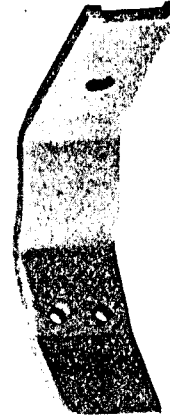
229105



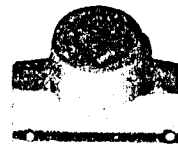
229104



229102



203705



203703



PLATE 12305—FULL SIZE

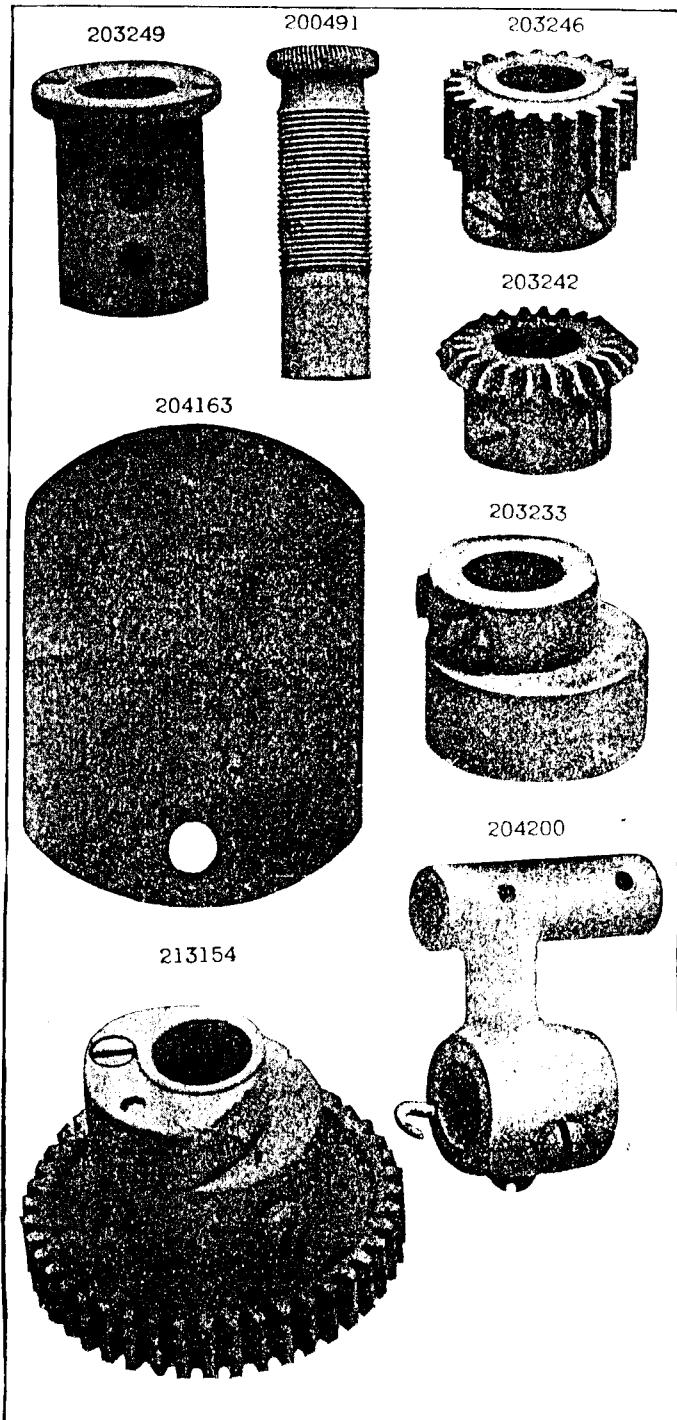


PLATE 12306—FULL SIZE

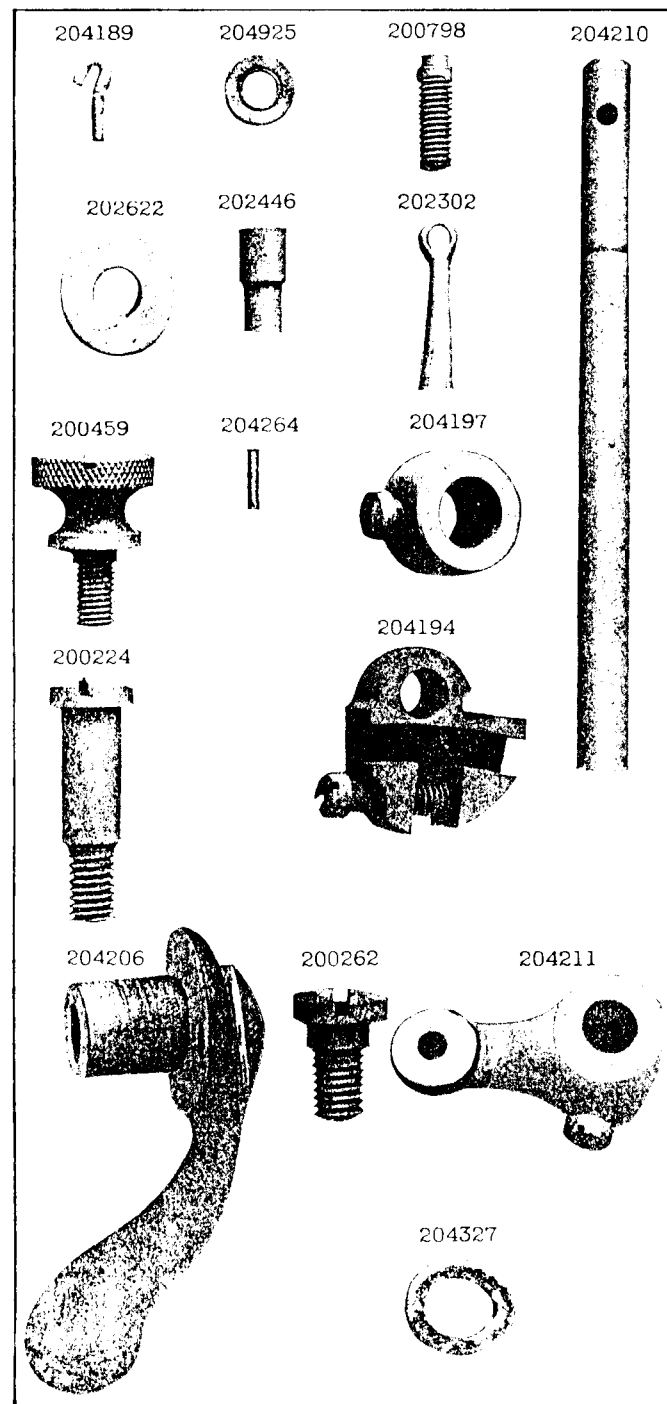


PLATE 12307—FULL SIZE

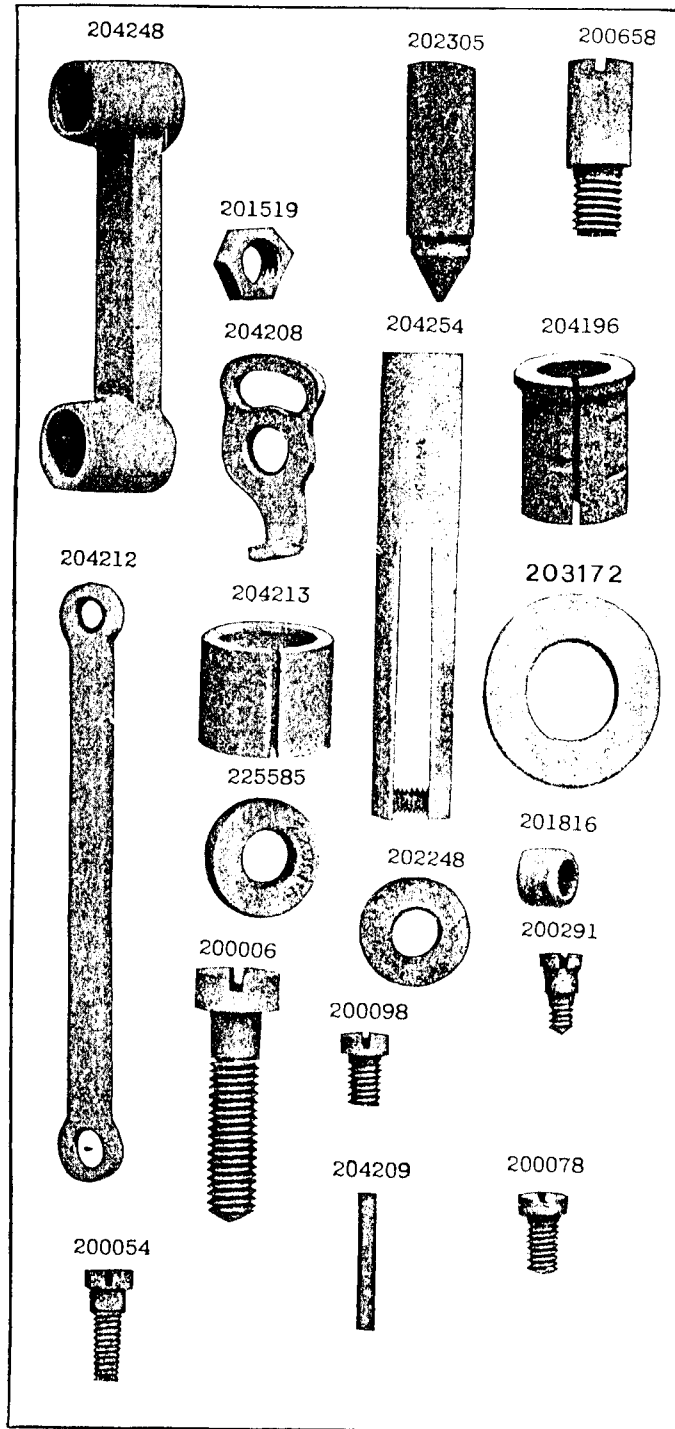


PLATE 12308—FULL SIZE

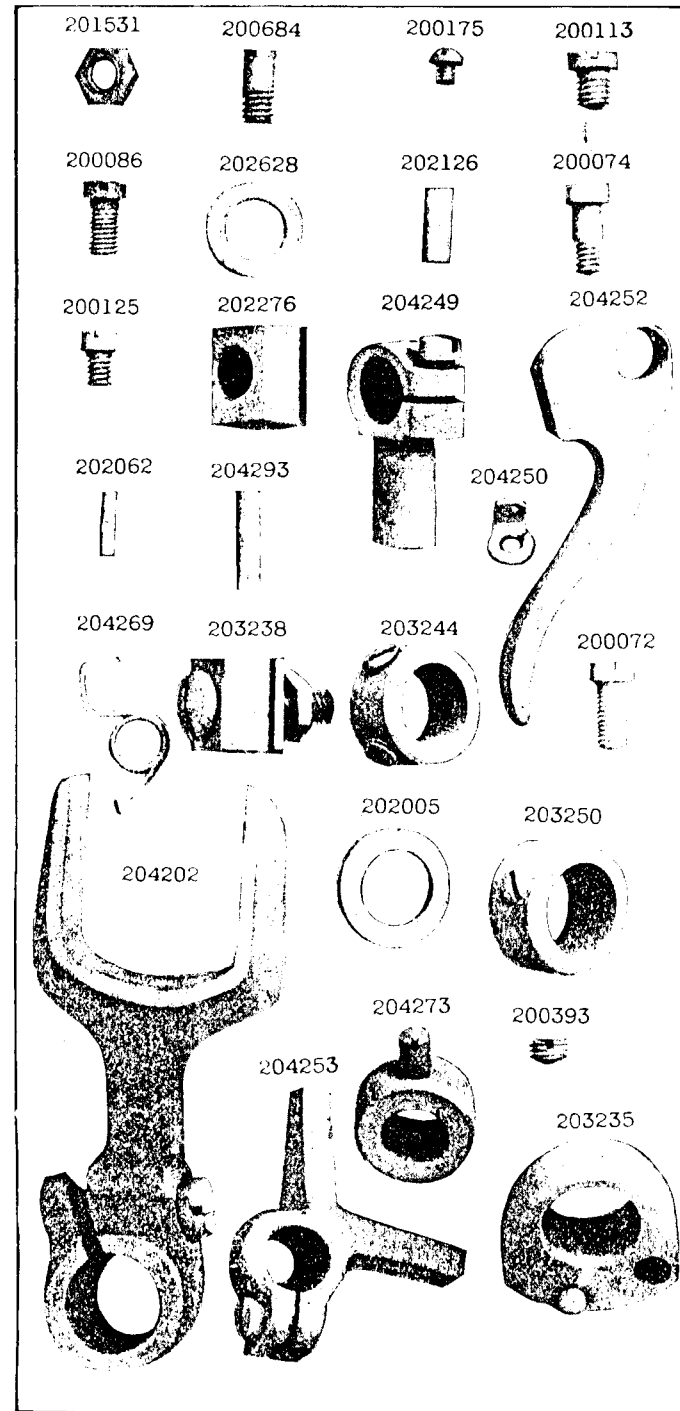


PLATE 12309 - FULL SIZE

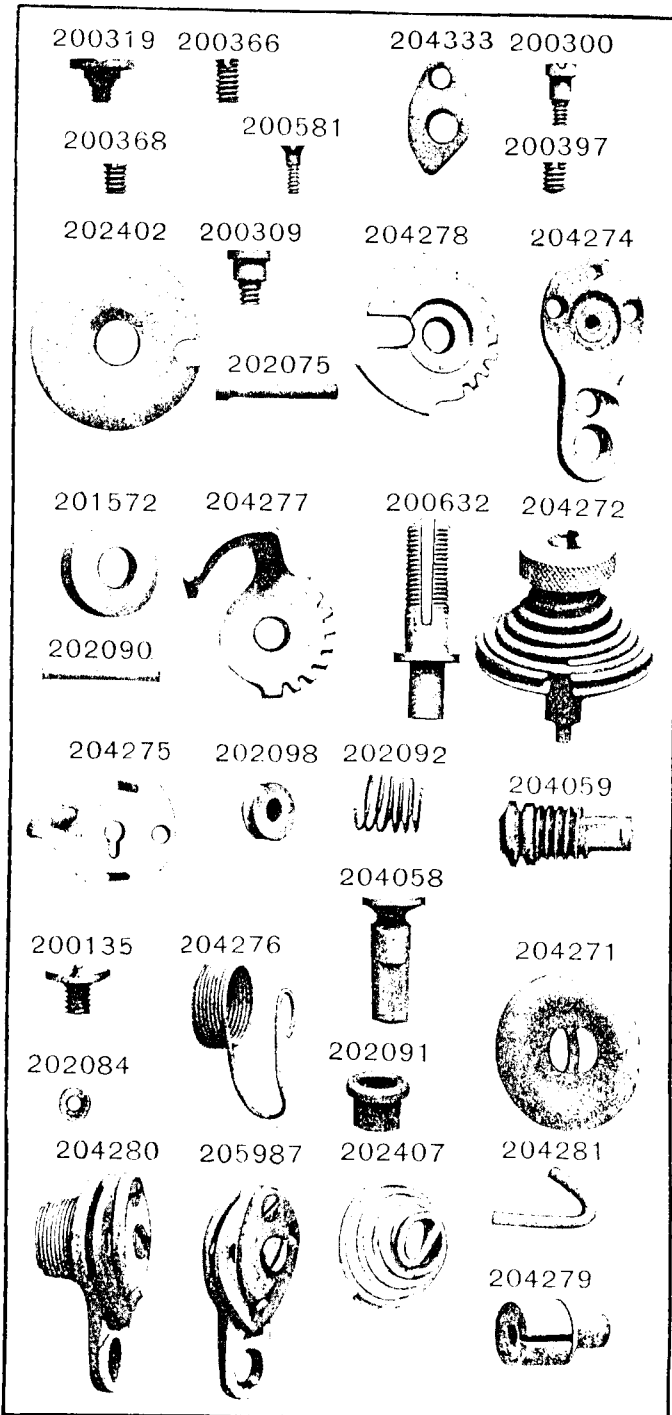


PLATE 12311 - FULL SIZE

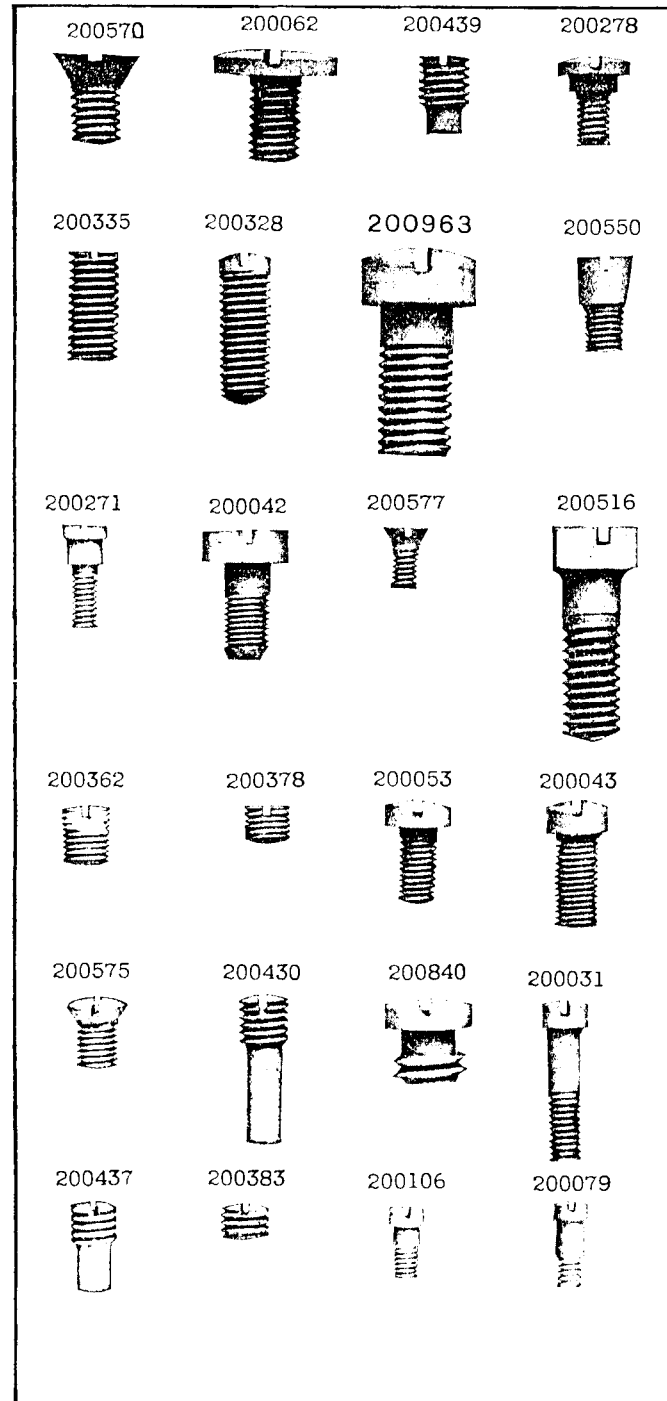


PLATE 12312 - FULL SIZE

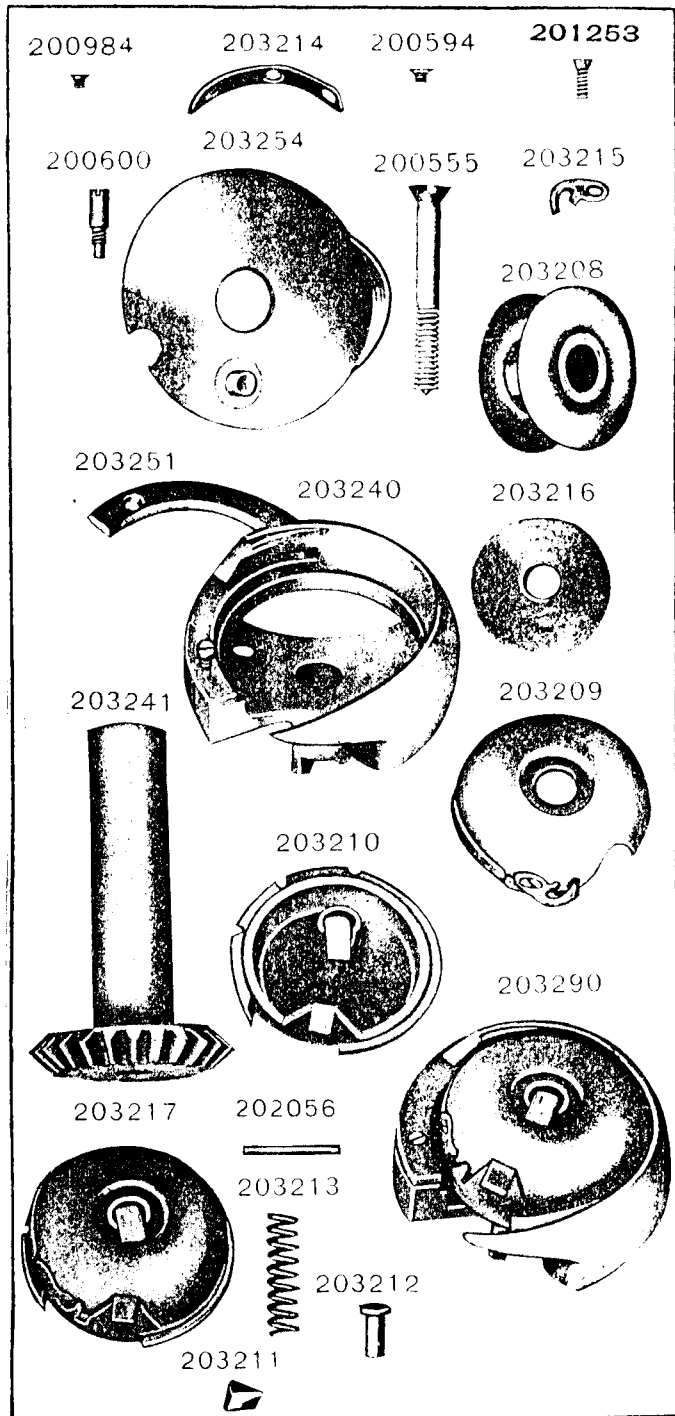


PLATE 12319 - FULL SIZE

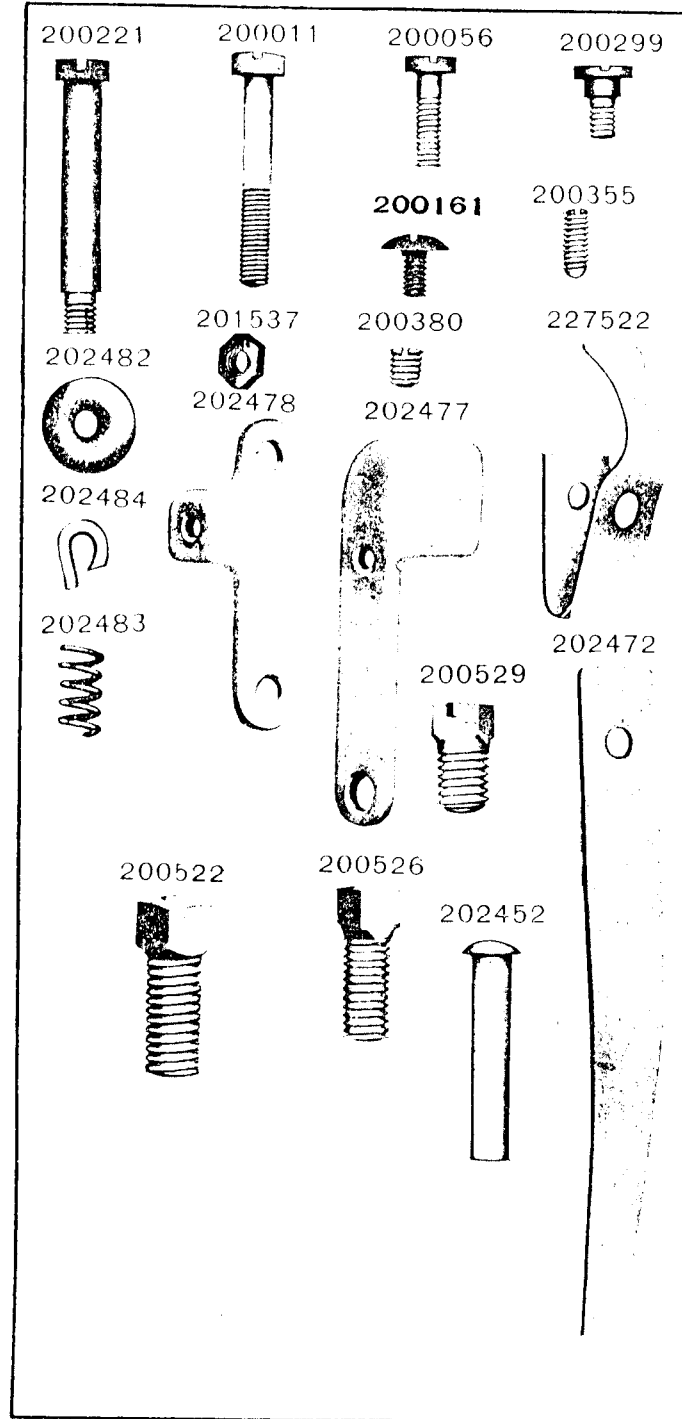


PLATE 12320—ONE-HALF SIZE

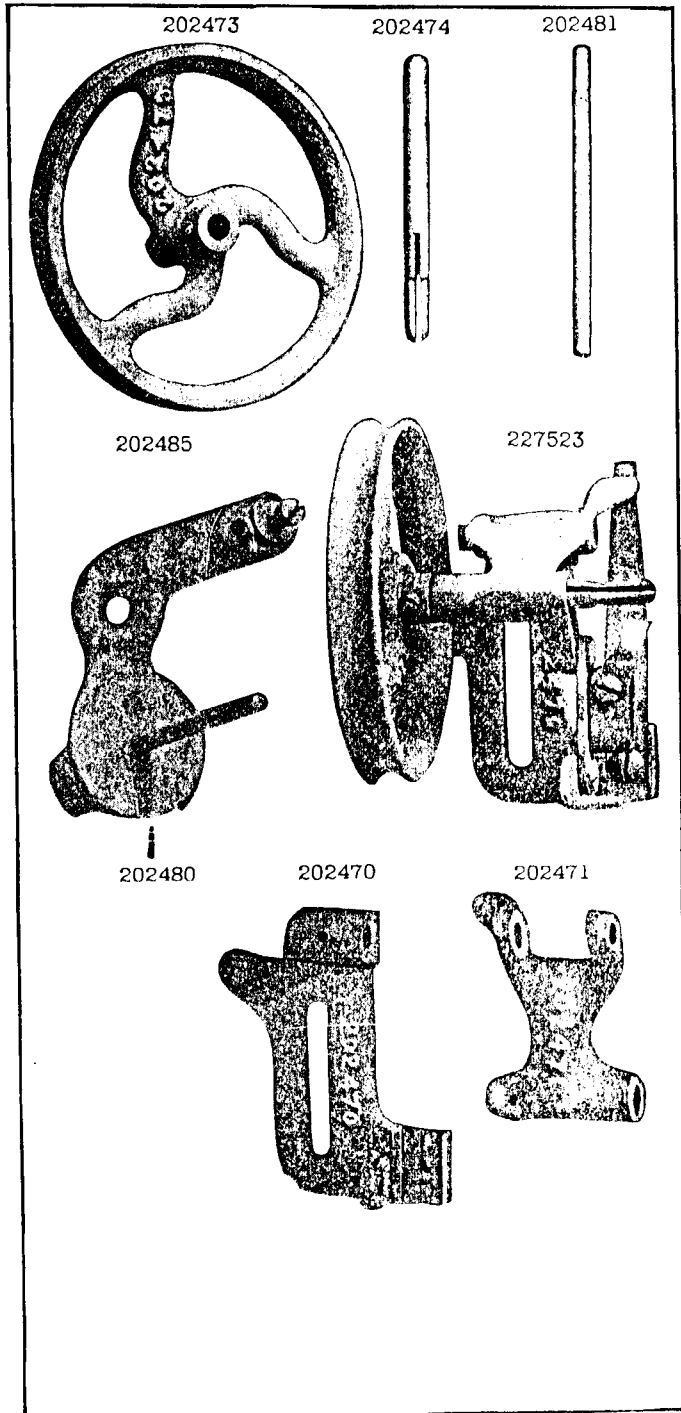


PLATE 12332—FULL SIZE

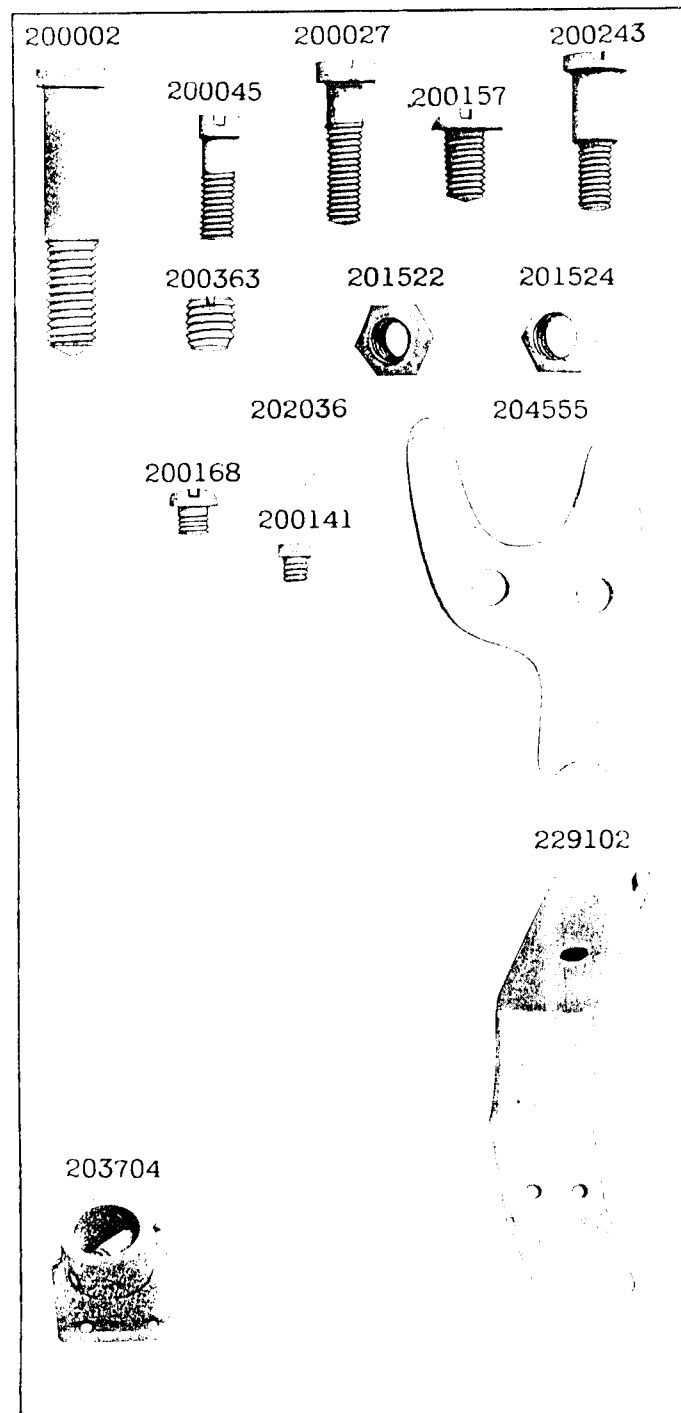


PLATE 12333—ONE-FOURTH SIZE

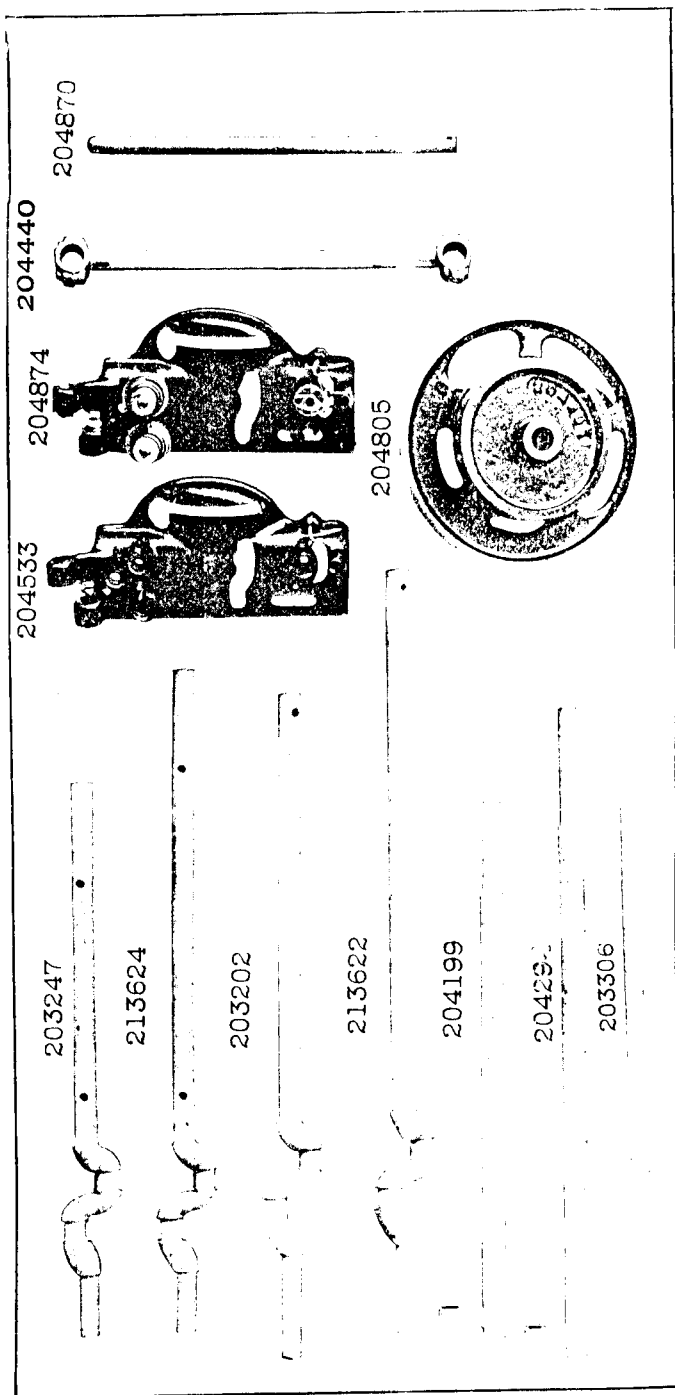


PLATE 12334—ONE-HALF SIZE

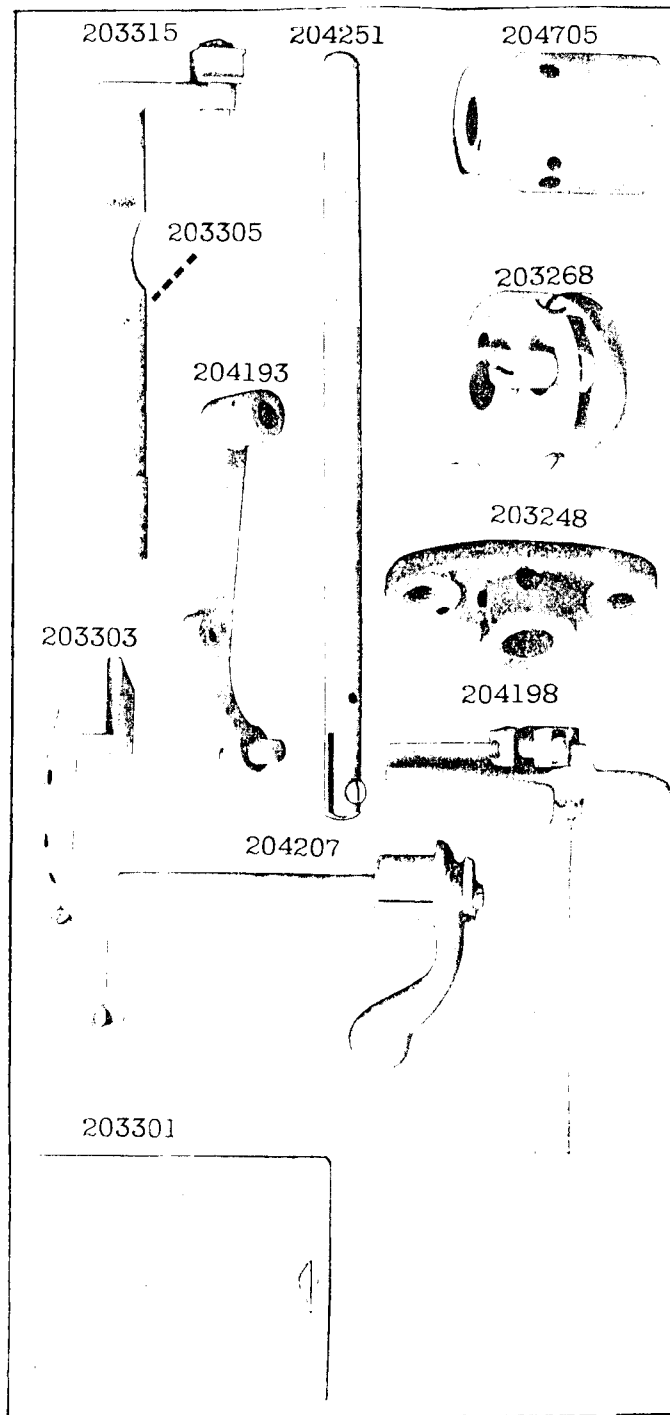
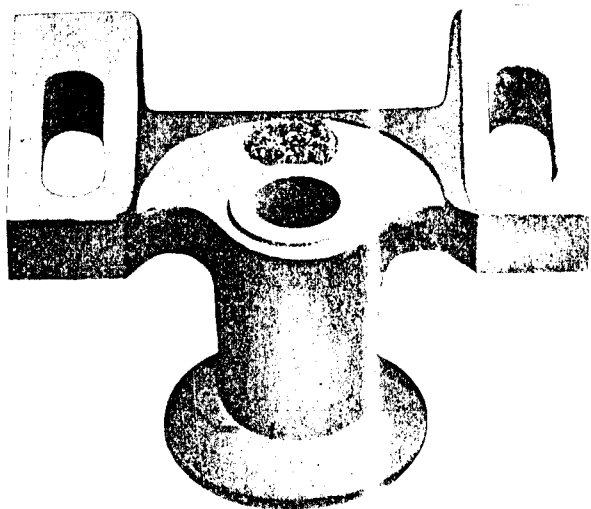




PLATE 12335—FULL SIZE

203307



203308

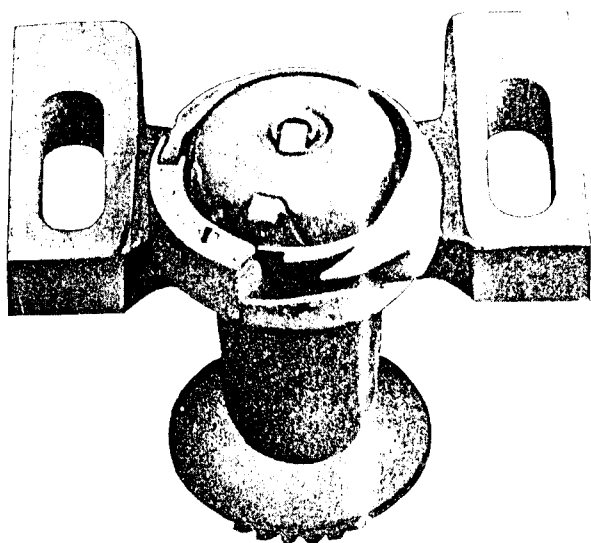


PLATE 12345—ONE-HALF SIZE

41400



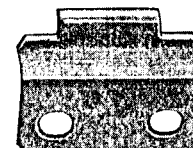
225497



225498

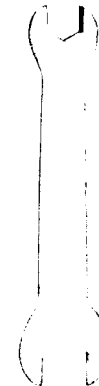


202258



36578

225554



36579

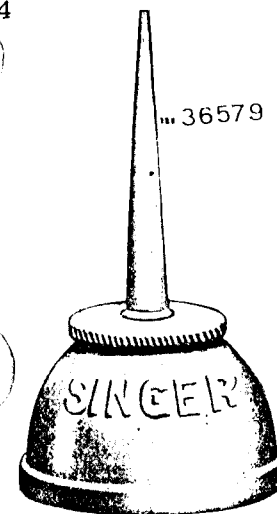


PLATE 12376—FULL SIZE

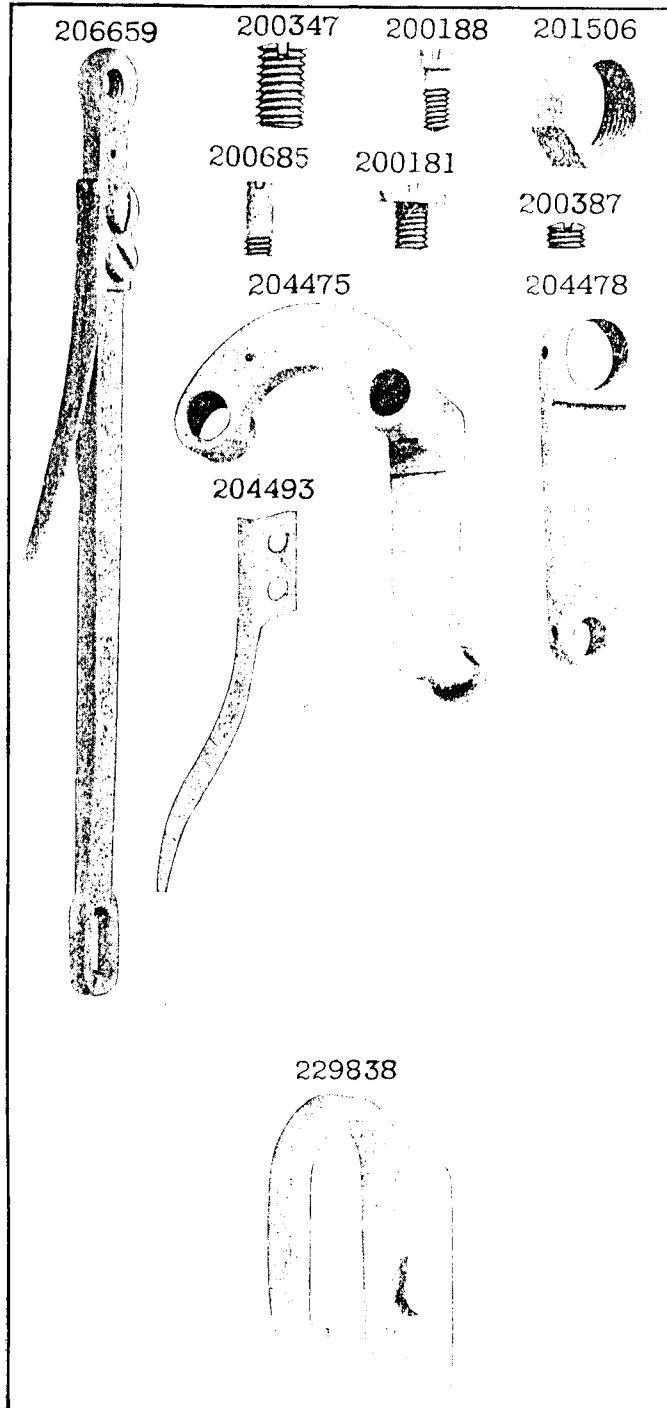


PLATE 12386—FULL SIZE

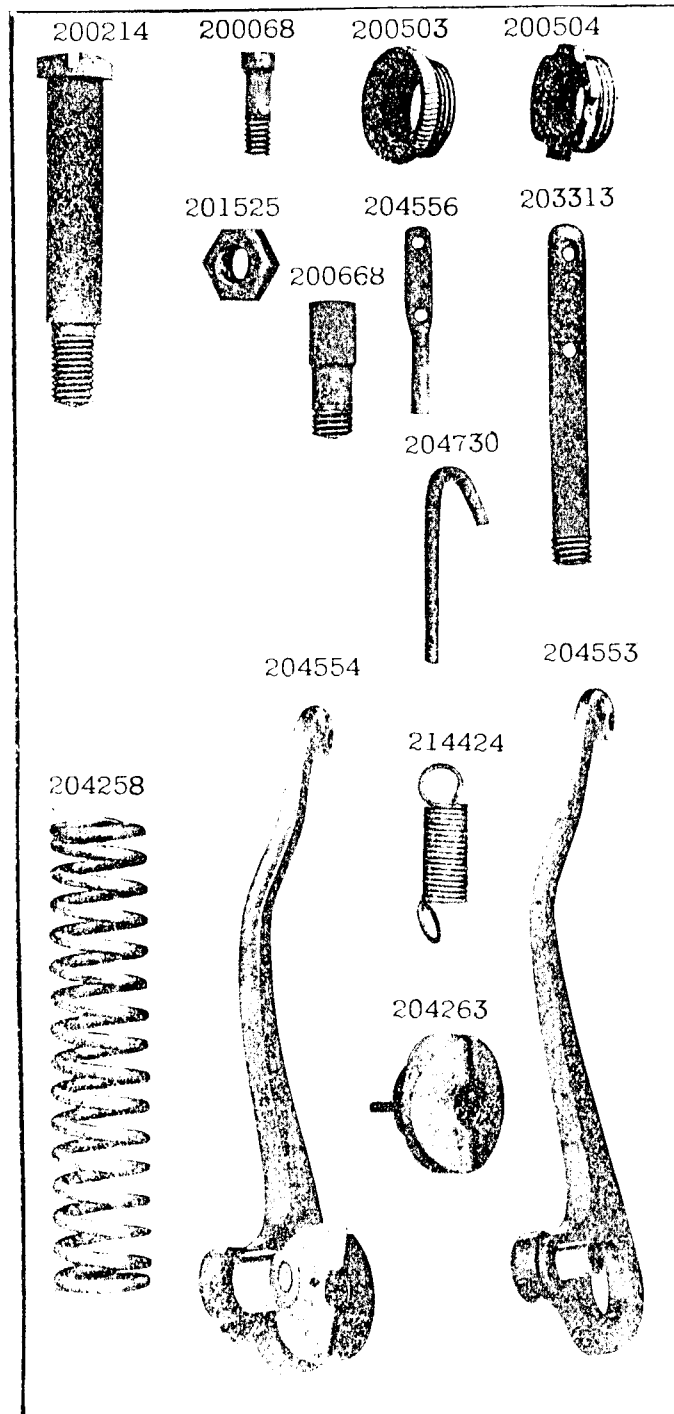


PLATE 13041—FULL SIZE

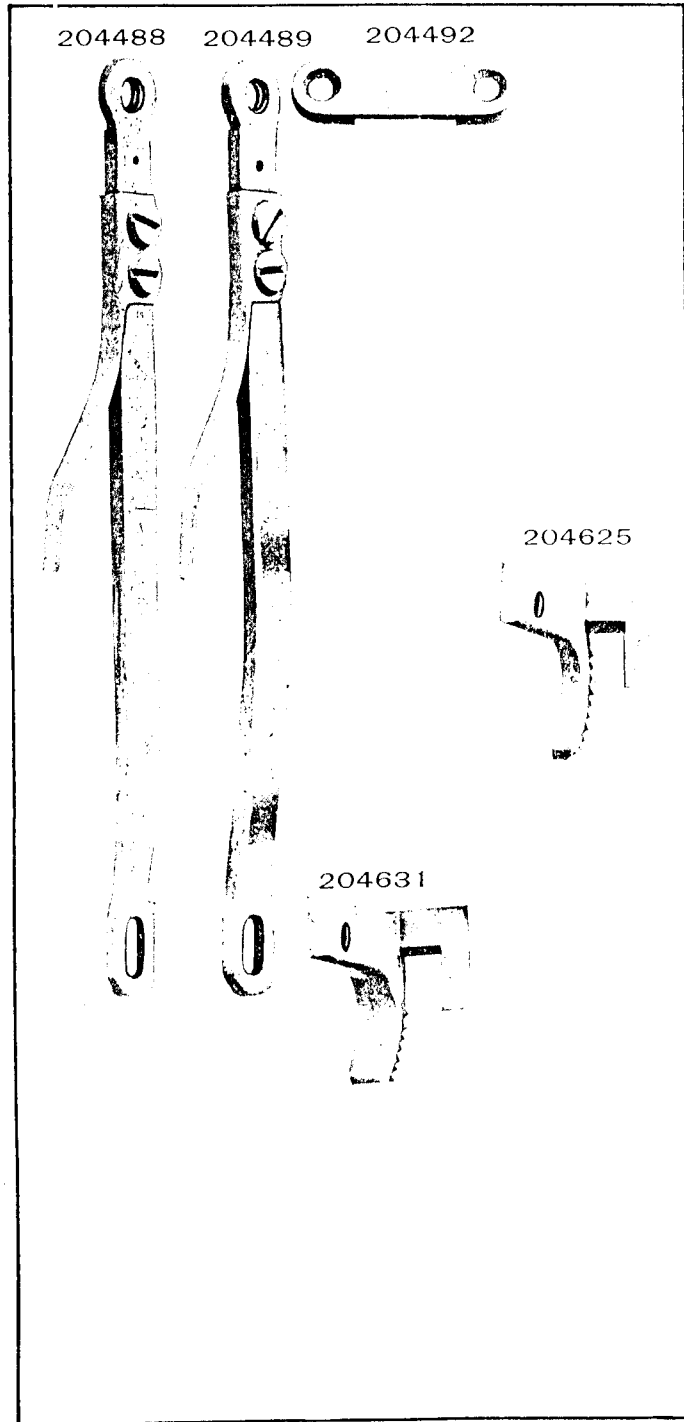


PLATE 13084—FULL SIZE

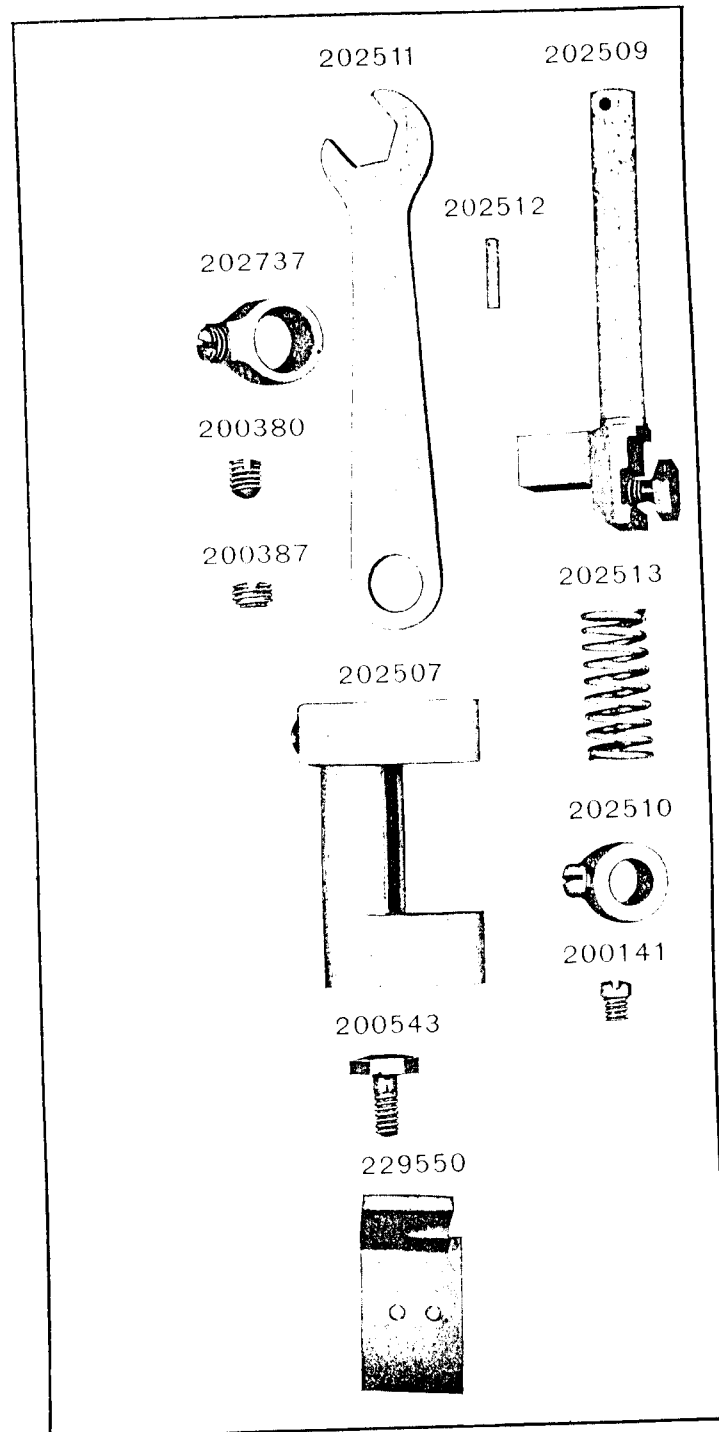


PLATE 13135--FULL SIZE

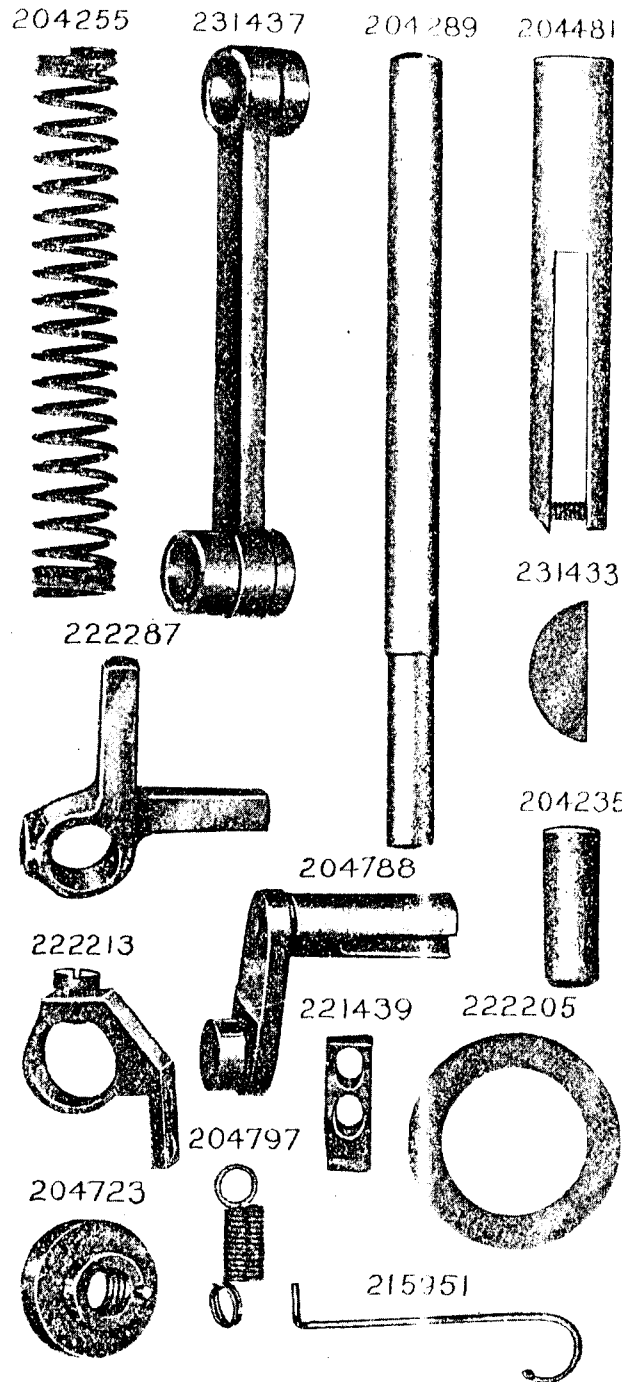


PLATE 13136--FULL SIZE

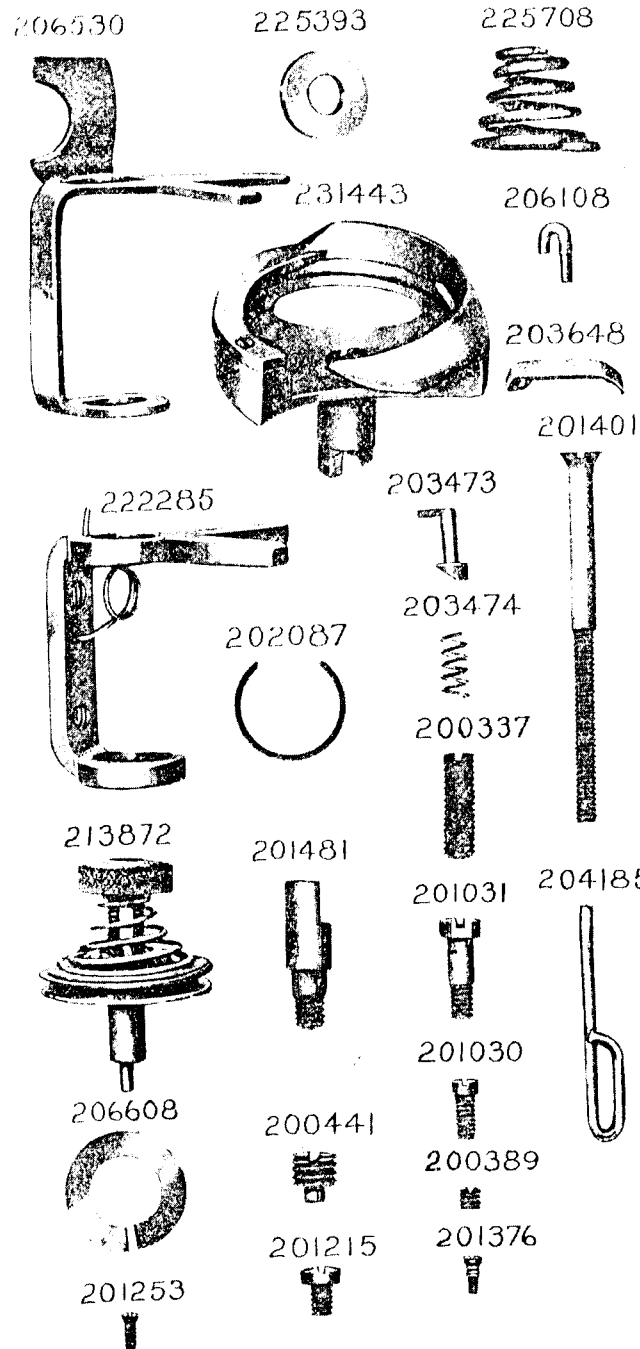
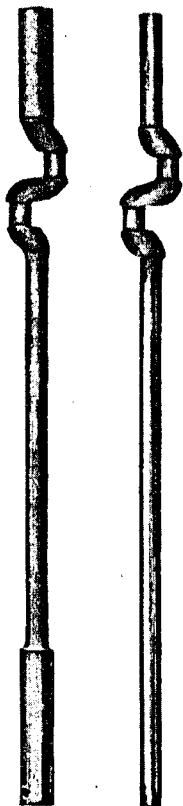


PLATE 13137—ONE-FOURTH SIZE

231431 213010



222210



204706



231432

222209



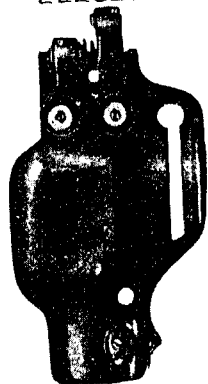
204447



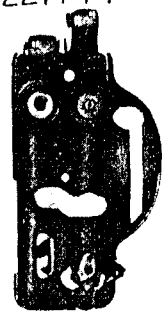
227310



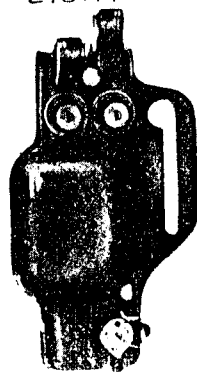
222321



221444



213111

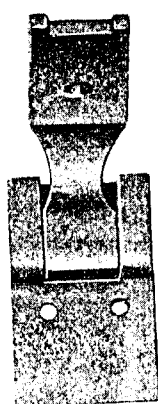


207849

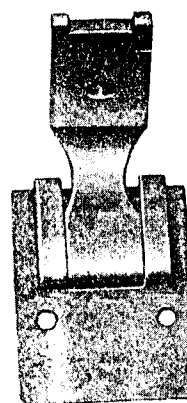


PLATE 13138—FULL SIZE

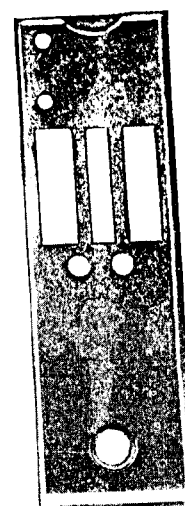
229098



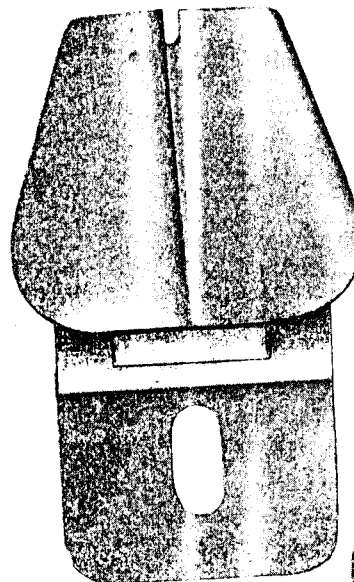
229100



231438



230808



213759



201018



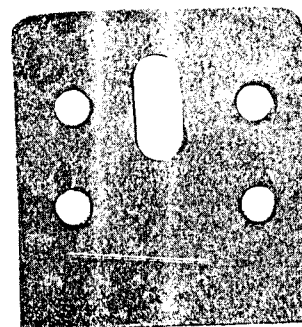
208



200170



230260



230795



201696

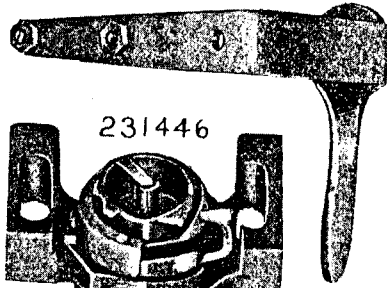


PLATE 13139—ONE-HALF SIZE

231397



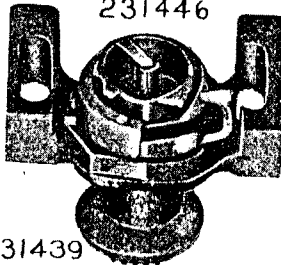
215950



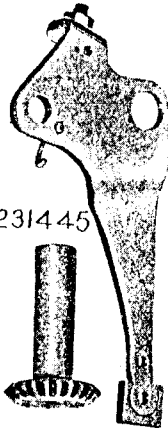
213422



231446



215953



231439



202566



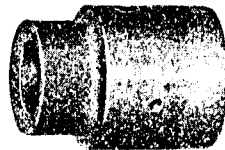
213810



231445



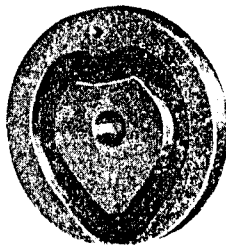
222216



207846



213073



213015

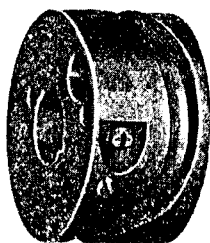
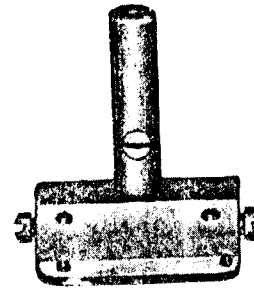


PLATE 13140—FULL SIZE

231385



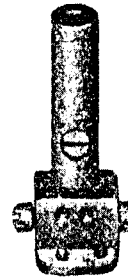
231401



229662



231383



231400



222319

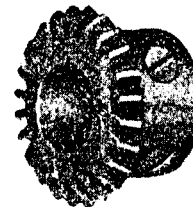
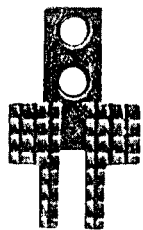


PLATE 13141—FULL SIZE

211010



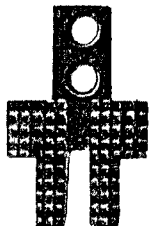
211761



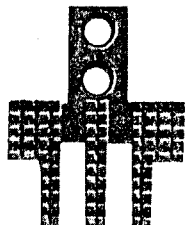
211762



211933



211934



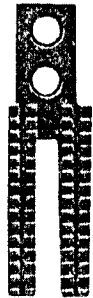
211995



211652



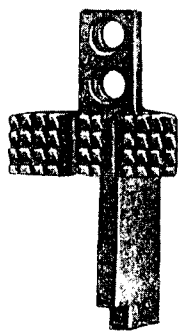
211809



222235



231448



211654



211754

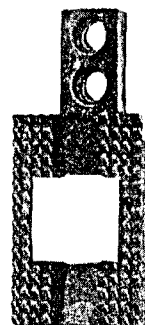


PLATE 13142—FULL SIZE

211904



212836



211644



211298



211646



211642



211648



211884



PLATE 13143—FULL SIZE

236411



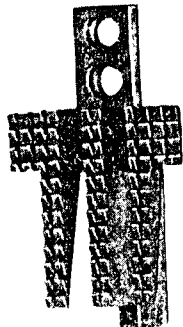
211246



211805



231516



211784



213894



236423

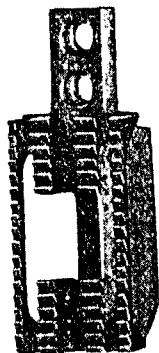
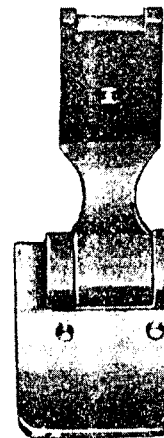


PLATE 13144—FULL SIZE

222237



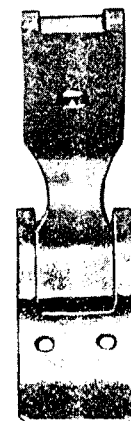
229123



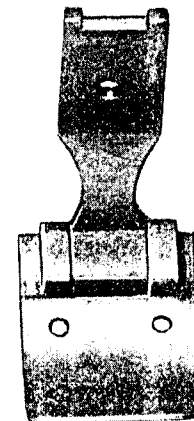
229124



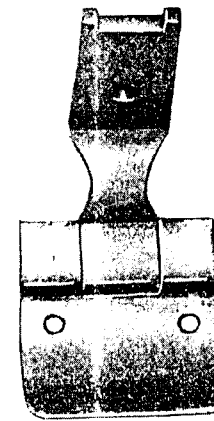
229096



229139



229141



222292

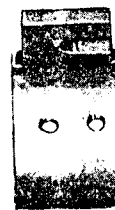
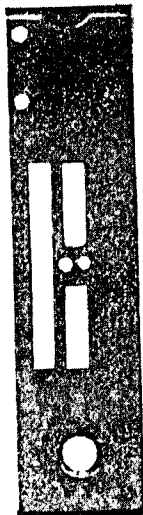


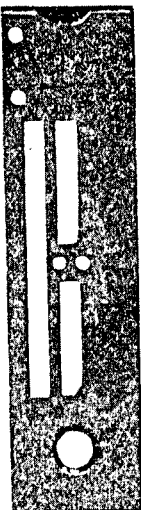


PLATE 13146—FULL SIZE

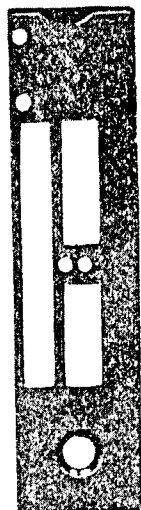
211641



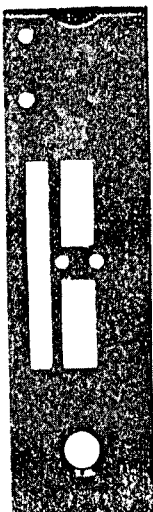
211643



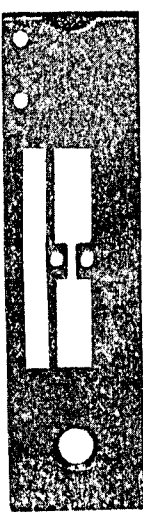
211645



211647



211653



211782

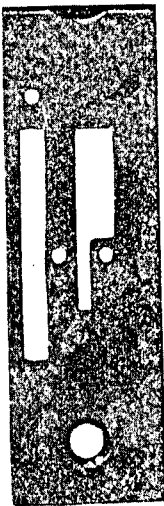
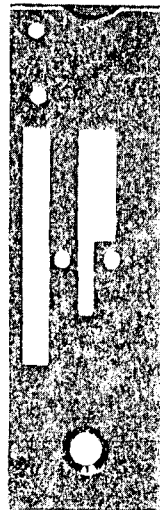
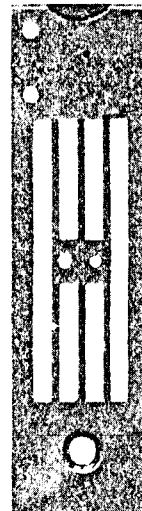


PLATE 13147—FULL SIZE

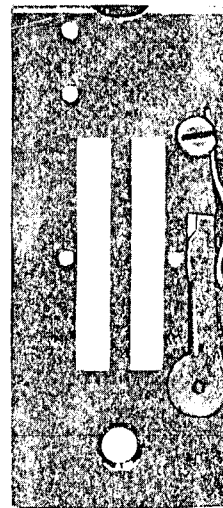
211783



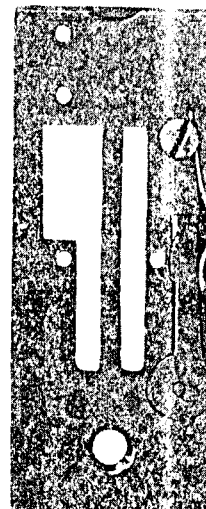
211879



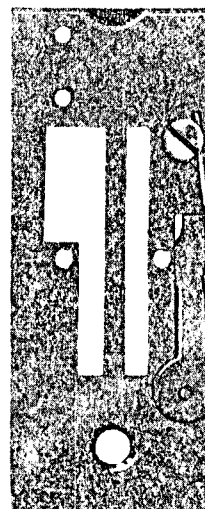
212050



222238



222239



222298

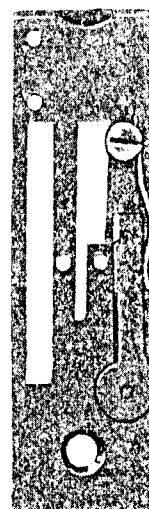
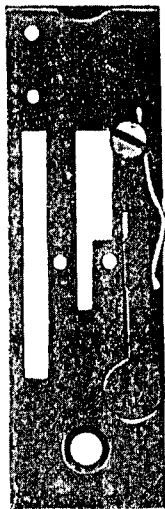
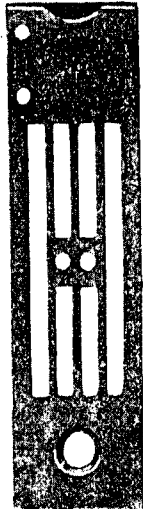


PLATE 13148—FULL SIZE

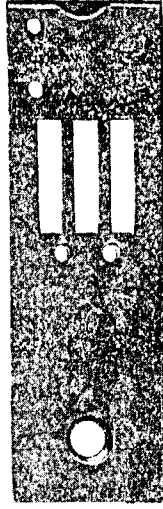
222334



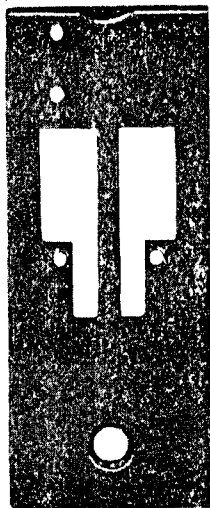
211191



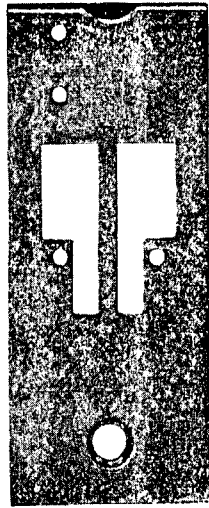
211748



211759



211760



211859

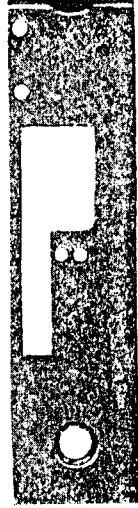
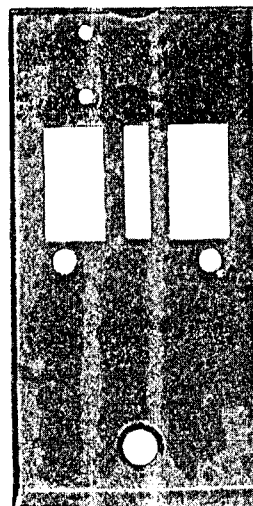
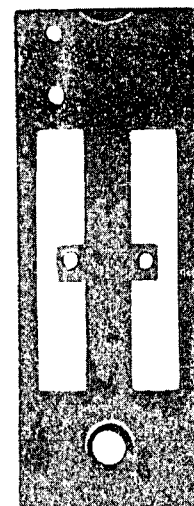


PLATE 13149—FULL SIZE

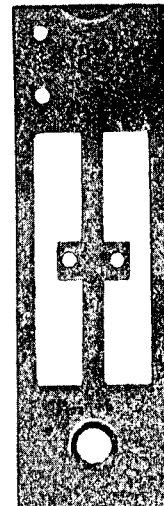
231449



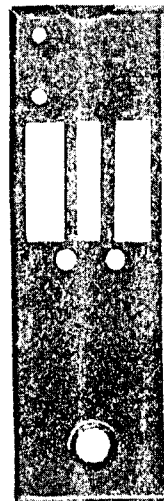
211771



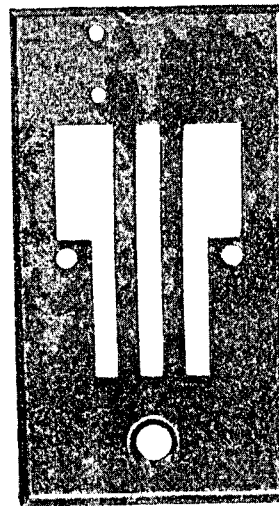
213893



222212



212242



212091



PLATE 13150—FULL SIZE

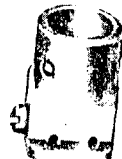
203697



203701



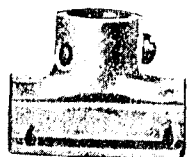
203714



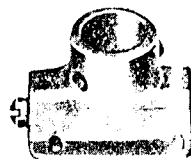
213896



203705



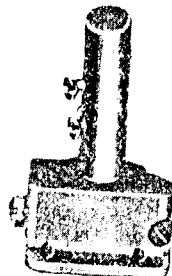
213897



213918



229665



222206

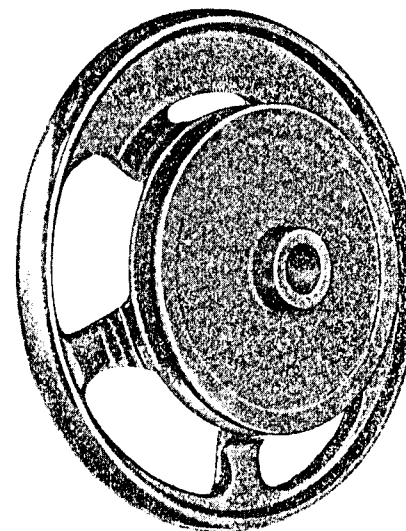


204635



PLATE 13329—ONE-HALF SIZE

204805



213925

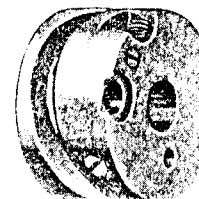
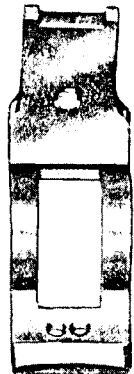


PLATE 14004—FULL SIZE

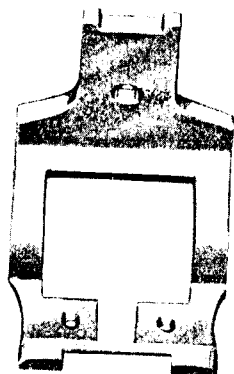
229641



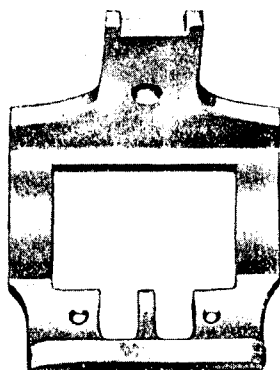
229642



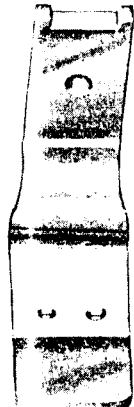
229667



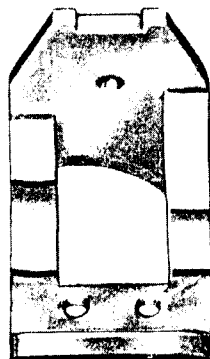
229654



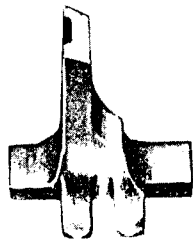
229103



222211



229653



229643



PLATE 14005—FULL SIZE

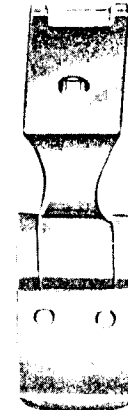
206669



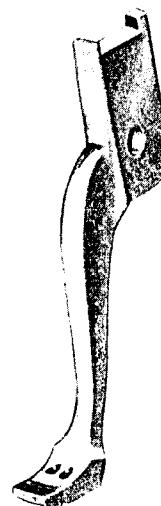
229624



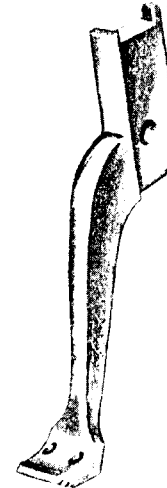
229133



206708  
206709



206711  
206712



229134

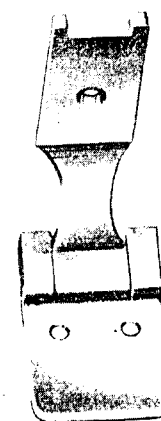


PLATE 14067—FULL SIZE

229646



229647



229650



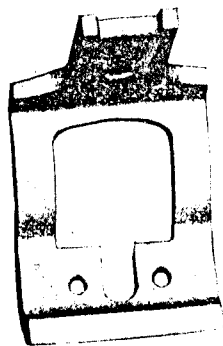
229651



229649



229652



229653



222305

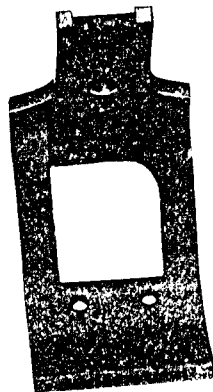


PLATE 14083—ONE-SIXTH SIZE

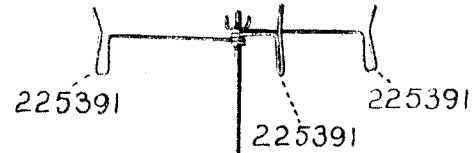
225377



60913



225397



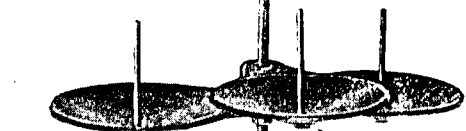
225391

225391

225391

225392

225388



225395

225389

202490

