

SINGER
253-201

LIST
OF
PARTS



SINGER

MACHINE No. 253-201

THE SINGER MANUFACTURING COMPANY

INSTRUCTIONS FOR OILING

Before starting the machine, fill the oil reservoir in the base to the HIGH MARK with "TYPE A" or "TYPE C" OIL, sold by Singer Sewing Machine Company, as instructed in Form 20482.

"TYPE C" OIL is to be used, when an oil is desired which will produce a minimum of stain on fabrics, even after a long period of storage.

The reservoir holds approximately 1½ pints.

When in operation, the oil level in the reservoir should be inspected at least twice a month or as often as is necessary to keep it from going below the LOW MARK in the reservoir. Refill to HIGH MARK with "TYPE A" or "TYPE C" OIL.

I N D E X

	Page
Accessories	17
Edge Folders on Shank	17
Face Plate Thread Lubricator	17
Fittings	18
Foot Lifter Parts	25
Hemmer on Shank	17
Knee Lifter Parts	25
Lap Seam Fellers	26
Machine No. 253-201	7
Numerical List of Parts	29
Tension Releaser	27
Thread Unwinder	27

INSTRUCTIONS FOR ORDERING

In ordering from this list, use ONLY the part NUMBER in the FIRST column.

The number stamped on a Sewing Machine Part is in every case the number of the single part only.

Every combination of parts sent out as such has its specific number, which, although not stamped on the parts, must be used when ordering the combination.

Each number always indicates the SAME PART in whatever list it appears, or for whatever machine.

The letters after some of the numbers indicate the style of finish only, as follows:

- A—Hardened, Polished, Nickel Plated and Buffed
- A.A—Buffed and Chromium Plated
- A.B—Hardened, Polished, Buffed and Chromium Plated
- A.C—Brown Baking Enamel Finish
- A.D—Gray Baking Enamel Finish
- A.E—Hardened, Bright Rumbled and Nickel Plated
- A.F—Hardened, Bright Rumbled, Nickel Plated, Bright Rumbled and Chromium Plated
- A.G—Alumilite, Plain
- A.H—Alumilite, Dyed
- A.J—Polished, Nickel Plated and Chromium Plated
- A.K—Hardened, Polished, Nickel Plated and Chromium Plated
- A.L—Heat Treated for Toughness
 - B—Polished, Nickel Plated and Buffed
 - C—Hardened Only
- C.R—Hardened and Merlized
 - D—Polished Only
 - E—Soft, Not Polished
 - F—Hardened and Polished
- F.J—Hardened, Polished and Nickel Plated
- G—Bright Rumbled and Nickel Plated
- H—Blued
- J—Nickel Plated Only
- K—Hardened and Nickel Plated
- L—Brass Plated
- M—Oxidized
- N—Japanned, Dull
- P—Japanned, Bright
- P.P—Wrinkle Finish
 - R—Merlized
 - S—Cadmium Plated
 - T—Copper Plated
- T.A—Hardened, Polished, Copper and Nickel Plated and Buffed
- T.B—Copper and Nickel Plated and Polished
- T.J—Copper and Nickel Plated Only
- T.K—Hardened, Copper and Nickel Plated
- T.L—Copper and Brass Plated
- T.M—Copper Plated and Oxidized

INSTRUCTIONS FOR ORDERING—Continued

- U—Zinc Plated
- V—Silver Plated
- W—Polished and Nickel Plated
- X—Black Oxide, for Iron and Steel
- X.C—Hardened and Black Oxide, for Iron or Steel
- Y—Black Nickel Plated Only
- Z—Chromium Plated
- Z.A—Hardened, Polished, Nickel Plated, Buffed and Chromium Plated
- Z.B—Polished, Nickel Plated, Buffed and Chromium Plated
- Z.C—Hardened and Chromium Plated
- Z.D—Polished and Chromium Plated
- Z.G—Bright Rumbled, Nickel Plated, Bright Rumbled and Chromium Plated
- Z.J—Nickel and Chromium Plated
- Z.T—Copper and Chromium Plated

These letters MUST BE USED when they appear in the list; and AFTER the number as in the list.

In this series:

1 to 1500, 50001 to 51500 and 140001 to 142000 are Screw Numbers

1501 to 1800 and 51501 to 51800 are Nut Numbers

1801 to 2000 and 51801 to 52000 are Roller Numbers

2001 to 50000 and 52001 to 140000 and 142001 to 190000 are Sewing Machine Parts, 190001 and upward are numbers of Electrical Parts.

The figures in the second column refer only to the plates, illustrating the parts, and are NOT TO BE USED in ordering.

Parts marked with an asterisk (*) are furnished only when repairs are made at factory.

When ordering parts which differ as to Gauge (the distance between seams), the Gauge, as well as the Number, must be given on order.

LIST OF PARTS COMPLETE
FOR

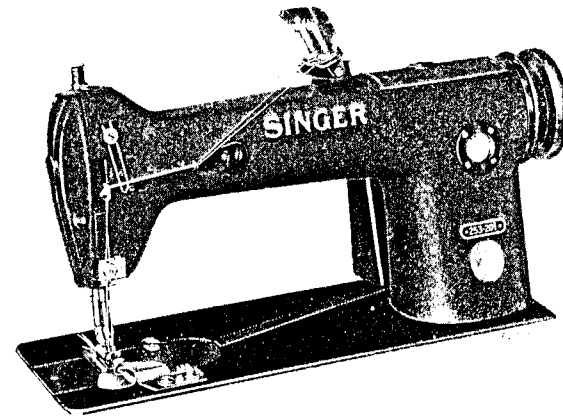

MACHINE No. 253-201

FOR SEWING MEDIUM WEIGHT FABRICS. TWO NEEDLES, TWO LOOPERS. DROP FEED. TWO-THREAD CHAIN STITCH. ARM AT 11° ANGLE WITH BED. NEEDLE BAR STROKE 1-3/16 INCHES. GAUGES 3/32 INCH TO 1/2 INCH, IN STEPS OF 1/32 INCH. LENGTH OF STITCHES 6 TO 22 TO THE INCH. SPEED 5500 R.P.M. DEPENDING ON MATERIAL USED AND OPERATIONS PERFORMED.

SINGER Needles should be used
in SINGER Machines
These Needles and their Containers
are marked with the
Company's Trade Mark "SIMANCO.**" 1

Needles in Containers marked
"FOR SINGER MACHINES"
are NOT SINGER made needles. 2

No.	Plate	Name
*146501		Arm with Trade Mark and two Trade Mark Rivets
		NOTE: Due to the accuracy required for gear alignment, Arm cannot be supplied separately and can only be sent out as a unit, Arm and Bed assembled.
16532	25037	Arm Dowel Pin (2)
146552	25037	Arm Screw (front) (2)
146551	25037	Arm Screw Stud (back) (2)
146651	25036	Arm Shaft (horizontal) with Needle Bar Crank
146670		Arm Shaft (horizontal) 146651 with 146581
143008	25036	Arm Shaft (horizontal) Bushing (center)
140296AL	25036	Arm Shaft (horizontal) Bushing (center) Set Screw
146789	25036	Arm Shaft (horizontal) Flanged Bushing (back)
140296AL	25036	Arm Shaft (horizontal) Flanged Bushing (back) Set Screw
146790	25036	Arm Shaft (horizontal) Flanged Bushing (back) Oil Sump Tube with Holder
207E	25036	Arm Shaft (horizontal) Flanged Bushing (back) Oil Sump Tube Holder Screw
146672	25036	Arm Shaft (horizontal) Flanged Bushing (front)
140331AL	25036	Arm Shaft (horizontal) Flanged Bushing (front) Set Screw
144D	25036	Arm Shaft (horizontal) Screw (back)
140359E	25036	Arm Shaft (horizontal) Screw Plug (front)

No.	Plate	Name
143236	25036	Arm Shaft (horizontal) Screw Plug (front) Washer (fiber)
146661	25036	Arm Shaft (upright)
1259AL	25036	Arm Shaft (upright) Bevel Gear (lower) Set Screw (2)
1259AL	25036	Arm Shaft (upright) Bevel Gear (upper) Set Screw (2)
146505	25036	Arm Shaft (upright) Bushing (lower)
140298AL	25036	Arm Shaft (upright) Bushing (lower) Set Screw
147111	25036	Arm Shaft (upright) Bushing (upper)
140298AL	25036	Arm Shaft (upright) Bushing (upper) Set Screw
146829	25038	Arm Top Cover
146830		Arm Top Cover 146829 with 140676X (for Agents only)
		NOTE: No. 146830 is used to prevent tampering with the stitch set.
146506	25039	Arm Top Cover
146507		Arm Top Cover with Stitch Regulator Plunger complete, Nos. 64519, 146506, 146509, 146510 and 146511
146508	25039	Arm Top Cover Gasket (cork)
51369R	25039	Arm Top Cover Screw (4)
146509	25039	Arm Top Cover Stitch Regulator Plunger
146510	25039	Arm Top Cover Stitch Regulator Plunger Cap
140676X	25038	Arm Top Cover Stitch Regulator Plunger Hole Plug Screw
64519	25039	Arm Top Cover Stitch Regulator Plunger Spring
146511	25039	Arm Top Cover Stitch Regulator Plunger Stop Ring
*146513		Bed with two each 126150 and 140734E
		NOTE: Due to the accuracy required for gear alignment, Bed cannot be supplied separately and can only be sent out as a unit, Arm and Bed assembled.
143024	25036	Bed Hole Plug
146514	25037	Bed Leg (back)
965E	25037	Bed Leg (back) Screw (2)
146877	25037	Bed Leg (front, long)
146516	25040	Bed Rotary Shaft
146650		Bed Rotary Shaft 146516 with 146558
1259AL	25040	Bed Rotary Shaft Bevel Gear Set Screw (2)
146518	25040	Bed Rotary Shaft Bushing (back)
50554AL	25040	Bed Rotary Shaft Bushing (back) Set Screw
146519	25040	Bed Rotary Shaft Bushing (front)
50554AL	25040	Bed Rotary Shaft Bushing (front) Set Screw
146520	25040	Bed Rotary Shaft Bushing (intermediate)
448AL	25040	Bed Rotary Shaft Bushing (intermediate) Set Screw
64342	25040	Bed Rotary Shaft Collar with 454AL
454AL	25040	Bed Rotary Shaft Collar Set Screw
146521	25041	Bed Slide (left)
4307	25041	Bed Slide (left) Spring
725X	25041	Bed Slide (left) Spring Screw (2)
146522	25041	Bed Slide (left) complete, Nos. 4307, 146521 and two 725X
146006	25042	Bed Slide (right, button type) for 146007
146523	25058	Bed Slide (right, button type) for 146526
146834	25055	Bed Slide (right, button type) for 146835
146848	25054	Bed Slide (right, button type) for 146846
146849	25067	Bed Slide (right, button type) for 146847
146061	25042	Bed Slide (right, latch type) for 146062
146687		Bed Slide (right, latch type) for 146692
146722		Bed Slide (right, latch type) for 146723
146820		Bed Slide (right, latch type) for 146821
146827		Bed Slide (right, latch type) for 146828
146007	25042	Bed Slide (right, button type) complete for Throat Plates with no off-set, Nos. 1423X, 146006, 146524, 146525 and two 240C
146526	25056	Bed Slide (right, button type) complete for Throat Plates with 3/64 in. off set, Nos. 1423X, 146523, 146524, 146525 and two 240C
146835	25061	Bed Slide (right, button type) complete for Throat Plates with 3/32 in. off-set, Nos. 1423X, 146524, 146525, 146834 and two 240C

No.	Plate	Name
146846	25054	Bed Slide (right, button type) complete for Throat Plates with 9/64 in. off-set, Nos. 1423X, 146524, 146525, 146848 and two 240C
146847	25067	Bed Slide (right, button type) complete for Throat Plates with 3/16 in. off-set, Nos. 1423X, 146524, 146525, 146849 and two 240C
146062	25042	Bed Slide (right, latch type) complete for Throat Plates with no off-set, Nos. 146061, 146688, 146689, 146690, 146691 and four 1470X
146692	25057	Bed Slide (right, latch type) complete for Throat Plates with 3/64 in. off-set, Nos. 146687, 146688, 146689, 146690, 146691 and four 1470X
146828		Bed Slide (right, latch type) complete for Throat Plates with 3/32 in. off-set, Nos. 146688, 146689, 146690, 146691, 146827 and four 1470X
146723		Bed Slide (right, latch type) complete for Throat Plates with 9/64 in. off-set, Nos. 146688, 146689, 146690, 146691, 146722 and four 1470X
146821		Bed Slide (right, latch type) complete for Throat Plates with 3/16 in. off-set, Nos. 146688, 146689, 146690, 146691, 146820 and four 1470X
146525	25054	Bed Slide (right) Knob
146688	25042	Bed Slide (right) Latch
146689	25042	Bed Slide (right) Latch Guide
1470X	25042	Bed Slide (right) Latch Guide Screw (2)
146690	25042	Bed Slide (right) Latch Spring
146691	25042	Bed Slide (right) Spring
146524	25042	Bed Slide (right) Spring
1423X	25042	Bed Slide (right) Spring Screw
1470X	25042	Bed Slide (right) Spring Screw (2)
240C	25042	Bed Slide (right) Spring Stop Screw (2)
146652		Combination of Feed and Stitch Regulator Parts, Nos. 143087, 143134, 143293, 146537, 146545, 146775 and 146852
143293		Dummy Shaft for 146652
146528	25041	Face Plate
146529	25041	Face Plate Gasket
140061J	25041	Face Plate Screw (lower) (3)
140050J	25041	Face Plate Screw (upper)
146530	25043	Feed Bar with 1607X and 140695X
893C	25043	Feed Bar Screw Center (left)
152C	25043	Feed Bar Screw Center (left) Clamping Screw
313C	25043	Feed Bar Screw Center (right)
56813		Feed Bar Screw Center (right) 313C with 1519J
1519J	25043	Feed Bar Screw Center (right) Nut
143031	25043	Feed Bar Screw Center Oil Wick
143032	25043	Feed Bar Screw Center Oil Wick Holder
143033	25043	Feed Bar Screw Center Oil Wick Holder 143032 with 143031
228E	25043	Feed Bar Screw Center Oil Wick Holder Screw (2)
131032	25057	Feed Dog, 17 teeth (16 teeth to the inch) for lap seam felling, plain sewing and French seaming, for 3/32 in. -1/8 in., 5/32 in. -3/16 in. and 7/32 in. -1/4 in. gauges, for 146763 and 146803
146854	25056	NOTE: When ordering No. 131032, state gauge required. Feed Dog with row of teeth between needles, 17 Teeth (14 teeth to the inch) for piecing and goring, for 1/8 in. and 5/32 in. gauges, for 146855
146856	25055	NOTE: When ordering No. 146854, state gauge required. Feed Dog with row of teeth between needles, 17 teeth (14 teeth to the inch) for sleeving and straight run lap seam Felling, for 3/16 in., 7/32 in. -1/4 in., 9/32 in. -5/16 in. and 11/32 in. -3/8 in. gauges, for 146860
		NOTE: When ordering No. 146856, state gauge required.

No.	Plate	Name
146823	25054	Feed Dog, 16 teeth (14 teeth to the inch) for French seaming for 7/16 in. and 1/2 in. gauges, for 146826
		NOTE: When ordering No. 146823, state gauge required.
157J	25054	Feed Dog Screw
140695X	25043	Feed Dog Stop Screw
1607X	25043	Feed Dog Stop Screw Nut
147125	25036	Feed Eccentric
146852		Feed Eccentric 147125 with Feed Eccentric Body
1036AL	25036	Feed Eccentric Body Set Screw (3)
140566AL	25036	Feed Eccentric Stop Screw (6 stitch)
		NOTE: No. 140566 is regularly furnished with this Machine.
140256AL	25036	Feed Eccentric Stop Screw (7 stitch)
140568AL	25036	Feed Eccentric Stop Screw (8 stitch)
140258AL	25036	Feed Eccentric Stop Screw (14 stitch)
140333AL	25036	Feed Lifting Eccentric and Arm Shaft (horizontal) Bevel Gear Position Screw
1259AL	25036	Feed Lifting Eccentric and Arm Shaft (horizontal) Bevel Gear Set Screw (2)
146534	25043	Feed Lifting Rock Shaft
146536		Feed Lifting Rock Shaft 146534 with 146541 (for Agents only)
143039	25043	Feed Lifting Rock Shaft Cap
223E	25043	Feed Lifting Rock Shaft Cap Screw (2)
146537	25036	Feed Lifting Rock Shaft Connecting Rod
140230C	25036	Feed Lifting Rock Shaft Connecting Rod Hinge Screw
1518J	25036	Feed Lifting Rock Shaft Connecting Rod Hinge Screw Nut
146538		Feed Lifting Rock Shaft Crank with 50579J and 146540 (for Agents only)
157J	25043	Feed Lifting Rock Shaft Crank Clamping Screw
52267	25043	Feed Lifting Rock Shaft Crank Slide Block with Stud
143042	25043	Feed Lifting Rock Shaft Crank Slide Block Oil Wick
146539	25043	Feed Lifting Rock Shaft Crank Slide Block Oil Wick Holder
146540		Feed Lifting Rock Shaft Crank Slide Block Oil Wick Holder 146539 with 143042
50579J	25043	Feed Lifting Rock Shaft Crank Slide Block Oil Wick Holder Screw
50191C	25043	Feed Lifting Rock Shaft Screw Center (left)
52097		Feed Lifting Rock Shaft Screw Center (left) 50191C with 1513J
140488C	25043	Feed Lifting Rock Shaft Screw Center (right)
146662		Feed Lifting Rock Shaft Screw Center (right) 140488C with 1513J
146541	25043	Feed Lifting Rock Shaft Screw Center Front Oil Wick
1513J	25043	Feed Lifting Rock Shaft Screw Center Nut (2)
146542	25043	Feed Rock Shaft with 152C
146543		Feed Rock Shaft complete, Nos. 143050 and 146542
146544		Feed Rock Shaft 146543 with 146546 (for Agents only)
143048	25043	Feed Rock Shaft Cap
223E	25043	Feed Rock Shaft Cap Screw (2)
146545	25036	Feed Rock Shaft Connecting Rod
140230C	25036	Feed Rock Shaft Connecting Rod Hinge Screw
1518J	25036	Feed Rock Shaft Connecting Rod Hinge Screw Nut
143050	25043	Feed Rock Shaft Crank with 157R
157R	25043	Feed Rock Shaft Crank Clamping Screw
50191C	25043	Feed Rock Shaft Screw Center (left)
52097		Feed Rock Shaft Screw Center (left) 50191C with 1513J
1513J	25043	Feed Rock Shaft Screw Center (left) Nut
140278C	25043	Feed Rock Shaft Screw Center (right)
143138		Feed Rock Shaft Screw Center (right) 140278C with 1513J
1513J	25043	Feed Rock Shaft Screw Center (right) Nut
146546	25043	Feed Rock Shaft Screw Center Front Oil Wick
143052	25043	Feed Rock Shaft Screw Center Front Oil Wick Holder

No.	Plate	Name
146547	25043	Feed Rock Shaft Screw Center Front Oil Wick Holder 143052 with 146541 and 146546
197E	25043	Feed Rock Shaft Screw Center Front Oil Wick Holder Screw
146548	25044	Looper (back) closed eye
		NOTE: When ordering No. 146548, state gauge required.
1253AL	25044	Looper (back) Set Screw
146549	25044	Looper (front) closed eye
		NOTE: When ordering No. 146549, state gauge required.
1253AL	25044	Looper (front) Set Screw
146550	25040	Looper Avoiding Eccentric with two 1259AL
146553	25040	Looper Avoiding Eccentric Connection (forked) with two 896AL
896AL	25040	Looper Avoiding Eccentric Connection Clamping Screw (2)
1259AL	25040	Looper Avoiding Eccentric Set Screw (2)
146554	25040	Looper Avoiding Eccentric Slide Block
146556	25040	Looper Ball Crank
146987	25044	Looper Ball Crank Arm with 51320AL
146923	25044	Looper Ball Crank Arm 146897 with 1520J, 128551 and 146919
51320AL	25044	Looper Ball Crank Arm Clamping Screw
132790	25040	Looper Ball Crank Connection Ball Sleeve (two pieces)
164232	25040	Looper Ball Crank Connection Ball Sleeve Guide
146557	25040	Looper Ball Crank Connection Nos. two each 896AL, 51715AL, 131927 and 131928
146558		Looper Ball Crank Connection 146557 with 132790, 146556 and 164232
896AL	25040	Looper Ball Crank Connection Cap (lower) Screw (2)
131927	25040	Looper Ball Crank Connection Cap (upper) Screw Stud (2)
51715AL	25040	Looper Ball Crank Connection Cap (upper) Screw Stud (2)
131928	25040	Looper Ball Crank Connection Cap (upper) Screw Stud Nut Lock Washer (2)
146559	25040	Looper Ball Crank Hinge Pin
448AL	25040	Looper Ball Crank Hinge Pin Set Screw (2)
146948	25044	Looper Ball Crank Pitman Ball Screw Stud (right)
1520J	25044	Looper Ball Crank Pitman Ball Screw Stud (right) Nut
128551	25044	Looper Ball Crank Pitman Ball Screw Stud (right) Nut Locking Plate
175E	25044	Looper Ball Crank Pitman End Bearing (left) Cap Screw (2)
1664J	25044	Looper Ball Crank Pitman End Bearing (left) Nut
175E	25044	Looper Ball Crank Pitman End Bearing (right) Cap Screw (2)
146919		Looper Ball Crank Pitman Head (right) with 146948
146936	25044	Looper Ball Crank Pitman Rod
146937	25044	Looper Ball Crank Pitman Rod 146936 with 51769C
146938	25044	Looper Ball Crank Pitman Rod with Throw-out Device complete, Nos. 29043, 50169J, 146732, 146733, 146754, 146904, 146937 and two 51159J
51769C	25044	Looper Ball Crank Pitman Rod Nut
146565	25044	Looper Holder with 896AL and two 1253AL
146739	25044	Looper Holder 146565 with 1664J and 146567
146567	25044	Looper Holder Bushing (eccentric) with 146647
146647	25044	Looper Holder Bushing Pin
896AL	25044	Looper Holder Clamping Screw
146568	25040	Looper Holder Hinge Pin
146569	25040	Looper Holder Rock Shaft with 140439E
*146570		Looper Holder Rock Shaft Bracket
		NOTE: Due to the accuracy required for Looper Rock Shaft alignment, Looper Holder Rock Shaft Bracket cannot be supplied separately and can only be sent out as a unit, Arm, Bed and Looper Holder Rock Shaft Bracket assembled.
143126		Looper Rolder Rock Shaft Bracket Oil Pipe Clamping Sleeve Adaptor
231E		Looper Holder Rock Shaft Bracket Oil Plug Screw

No.	Plate	Name
140734E	25037	Looper Holder Rock Shaft Bracket Screw (2)
126150	Looper Holder Rock Shaft Bracket Screw Washer (2)
146571	25040	Looper Holder Rock Shaft Bushing (back)
448AL	25040	Looper Holder Rock Shaft Bushing (back) Set Screw
146572	25040	Looper Holder Rock Shaft Bushing (front)
448AL	25040	Looper Holder Rock Shaft Bushing (front) Set Screw
140439E	25040	Looper Holder Rock Shaft Oil Plug Screw
146732	25044	Looper Throw-out Releaser
146733	25044	Looper Throw-out Releaser Cap
51159J	25044	Looper Throw-out Releaser Cap Screw (2)
146754	25044	Looper Throw-out Sleeve
146904	25044	Looper Throw-out Spring
50169J	25044	Looper Throw-out Spring Screw
29043	25044	Looper Throw-out Spring Screw Washer
146924	Looper Throw-out Device and Pitman Rod complete, Nos. 1520J, 128551, 146919 and 146938 (for Agents only)
146512	25038	Machine Pulley (disc, power) "V" belt groove (outside diameter of belt groove 2.9 in.) with two 51283AL
51283AL	25038	Machine Pulley Set Screw (2)
146573	25045	Needle Bar (hollow)
146574	Needle Bar complete, Nos. 146573 and 146587 NOTE: When ordering No. 146574, state gauge required.
146575	25045	Needle Bar Bushing (lower)
1133E	25045	Needle Bar Bushing (lower) Set Screw
146576	25045	Needle Bar Bushing (upper)
1133E	25045	Needle Bar Bushing (upper) Set Screw
140440J	25045	Needle Bar Bushing (upper) Oil Plug Screw
146804	25045	Needle Bar Bushing (lower and upper) Oil Wick
146805	25045	Needle Bar Bushing (lower and upper) Oil Wick complete, Nos. 146703, 146804 and two 146580
146703	25045	Needle Bar Bushing (lower and upper) Oil Wick Clamp and Retainer
146580	25045	Needle Bar Bushing (lower and upper) Oil Wick Clip (2)
146724	25045	Needle Bar Connecting Link
146581	Needle Bar Connecting Link 146724 with 146582 and 146725
146582	25036	Needle Bar Connecting Link Hinge Stud
140552AL	25036	Needle Bar Connecting Link Hinge Stud Clamping Screw
1036AL	25036	Needle Bar Connecting Link Hinge Stud Position Set Screw
146725	25045	Needle Bar Connecting Stud with 175E
175E	25045	Needle Bar Connecting Stud Clamping Screw
139110	25045	Needle Bar Connecting Stud Oil Pad (wick)
139111	25045	Needle Bar Connecting Stud Slide Block
140542AL	25036	Needle Bar Crank Position Screw
146665	25047	Needle Bar Thread Retainer (lower)
146666	25047	Needle Bar Thread Retainer (upper)
50163XC	25047	Needle Bar Thread Retainer Screw (2)
54865	25047	Needle Bar Thread Retainer Screw Washer (2)
146585	25047	Needle Bar Thread Retainer Bracket
146586	25047	Needle Bar Thread Retainer Bracket complete, Nos. 10107, 140546C, 146585, 146665, 146666 and two each 42483, 50163XC and 54865
402J	25047	Needle Bar Thread Retainer Bracket Screw
42483	25047	Needle Bar Thread Retainer Disc (2)
140546C	25047	Needle Bar Thread Retainer Screw
10107	25047	Needle Bar Thread Retainer Spring
146587	25045	Needle Clamp with two 1498F NOTE: When ordering No. 146587, state gauge required.
146588	25042	Needle Guard, for 3/32 in. to 5/32 in. gauges NOTE: When ordering No. 146588, state gauge required.
146644	25042	Needle Guard, for 3/16 in. to 9/32 in. gauges NOTE: When ordering No. 146644, state gauge required.

No.	Plate	Name
146645	25042	Needle Guard, for 5/16 in. to 3/8 in. gauges NOTE: When ordering No. 146645, state gauge required.
146845	25042	Needle Guard, for 7/16 in. and 1/2 in. gauges NOTE: When ordering No. 146845, state gauge required.
146742	25042	Needle Guard Holder
146743	25042	Needle Guard Holder Bracket
190J	25042	Needle Guard Holder Bracket Screw
190J	25042	Needle Guard Holder Screw
190J	25042	Needle Guard Screw
1498F	25045	Needle Set Screw (2)
146591	25046	Oil Flow Body
143061	25046	Oil Flow Body Gasket (2)
143062	25046	Oil Flow Window
143063	25046	Oil Flow Window Cap
50257J	25046	Oil Flow Window Cap Screw (4)
143370	25046	Oil Lead
51369E	25046	Oil Lead Screw
146593	25046	Oil Pipe, for 146597
146594	25010	Oil Pipe with two each 143124 and 143125 for oiling Bed Rotary Shaft Intermediate Bearing
146595	25010	Oil Pipe with two each 143124 and 143125 for oiling Looper Rock Shaft Hinge Pin
146596	25010	Oil Pipe with two each 143124 and 143125 for oiling Thread (under) Take-up Shaft Front Bearing
143065	25046	Oil Pipe Clamping Sleeve for 146597
143066	25046	Oil Pipe Clamping Sleeve Nut for 146597
146597	25046	Oil Pipe complete, from Oil Pump to Arm Shaft (horizontal) Center Bearing, Nos. 143065, 143066 and 146593 (for Agents only)
143124	25010	Oil Pipe Clamping Sleeve (6)
143125	25010	Oil Pipe Clamping Sleeve Nut (6)
143126	25046	Oil Pipe Clamping Sleeve Adaptor for 146660 (3)
143126	25046	Oil Pipe Clamping Sleeve Adaptor (fastened to Bed) (2)
146659	25046	Oil Pump (centrifugal) Body
146660	25046	Oil Pump (centrifugal) Body 146659 with three 143126
143071	25046	Oil Pump (centrifugal) Body Position Pin (2)
157E	25046	Oil Pump (centrifugal) Body Screw (3)
146600	25046	Oil Pump (centrifugal) Cover
143073	25046	Oil Pump (centrifugal) Impeller
50123E	25036	Oil Pump (centrifugal) Impeller Locking Screw
146657	25046	Oil Pump (centrifugal) Screen
146658	25046	Oil Pump (centrifugal) Screen Frame
189E	25046	Oil Pump (centrifugal) Screen Frame Screw (3)
146744	25037	Oil Removing Wick (head end)
146745	25037	Oil Removing Wick (head end) Holder Body
146746	25037	Oil Removing Wick (head end) Holder Body 146745 with 146698 and 146744 (for Agents only)
140553E	25037	Oil Removing Wick (head end) Holder Body Hinge Screw
146700	25037	Oil Removing Wick (head end) Holder Body Stop and Spring Clip
228E	25037	Oil Removing Wick (head end) Holder Body Stop and Spring Clip Screw
146698	25037	Oil Removing Wick (head end) Holder Body Spring
146696	25037	Oil Removing Wick (head end) Hinge Plate and Cover
146697	25037	Oil Removing Wick (head end) Hinge Plate and Cover Gasket
1364X	25037	Oil Removing Wick (head end) Hinge Plate and Cover Screw (3)
146747	25037	Oil Removing Wick (head end) Holder Body complete, Nos. 228E, 140553E, 146696, 146698, 146700, 146744 and 146745
146604	25040	Oil Wick for oiling Looper Ball Crank Pitman End Bearing (left)

No.	Plate	Name
146605	25040	Oil Wick Holder
193E	25040	Oil Wick Holder Tube Bracket Screw
146606	25040	Oil Wick Position Bracket with 140239AL
140239AL	25040	Oil Wick Position Bracket Screw
139462	25045	Presser Bar
146751	25045	Presser Bar Bushing (lower)
1133E	25045	Presser Bar Bushing (lower) Set Screw
146694	25045	Presser Bar Guide Bracket with 1057AL
1057AL	25045	Presser Bar Guide Bracket Clamping Screw
146676	25049	Presser Bar Lifting Bracket Lifter
807X	25049	Presser Bar Lifting Bracket Lifter Hinge Screw
146608	25049	Presser Bar Lifting Lever
146609	25049	Presser Bar Lifting Lever Extension
161X	25049	Presser Bar Lifting Lever Extension Screw (2)
802X	25049	Presser Bar Lifting Lever Hinge Screw
146610	25049	Presser Bar Lifting Lever Spring
146611	25045	Presser Bar Spring
146612	25045	Presser Bar Spring Guide Pin
146752	25045	Presser Bar Stop with 190J
190J	25045	Presser Bar Stop Clamping Screw
146729	25058	Presser Foot Plate
26276	25058	Presser Foot Plate Hinge Pin
146712	25058	Presser Foot Shank
146713	25058	Presser Foot (hinged) complete for Lap Seam Felling, for 3/32 in. to 1/2 in. gauges, Nos. 26276, 146712 and 146729
		NOTE: When ordering No. 146713, state gauge required.
146837	25056	Presser Foot Plate
26276	25056	Presser Foot Plate Hinge Pin
910AL	25056	Presser Foot Plate Hinge Pin Set Screw
1695J	25056	Presser Foot Plate Hinge Pin Set Screw Nut
146838	25056	Presser Foot Shank with 910AL and 1695J
146839	25056	Presser Foot (hinged) complete for Piecing or Goring, for 1/8 in. and 5/32 in. gauges, Nos. 26276, 146837 and 146838
		NOTE: When ordering No. 146839, state gauge required.
146761	25057	Presser Foot Plate
26276	25057	Presser Foot Plate Hinge Pin
146712	25057	Presser Foot Shank
146762	25057	Presser Foot (hinged) complete for plain sewing and French seaming, for 3/32 in. to 3/8 in. gauges Nos. 26276, 146712 and 146761
		NOTE: When ordering No. 146762, state gauge required.
146862	25055	Presser Foot Plate
146851	25055	Presser Foot Plate Connection
26276	25055	Presser Foot Plate Connection Hinge Pin
37160	25055	Presser Foot Plate Connection Spring
26276	25055	Presser Foot Plate Hinge Pin
146850	25055	Presser Foot Shank
146858	25055	Presser Foot Yielding Heel
26276	25055	Presser Foot Yielding Heel Hinge Pin
146859	25055	Presser Foot (triple hinged) complete for sleeving and straight run lap seam felling for 3/32 in. to 3/8 in. gauges, Nos. 37160, 146850, 146851, 146858, 146862 and three 26276
		NOTE: When ordering No. 146859, state gauge required.
146824	25054	Presser Foot Plate
26276	25054	Presser Foot Plate Hinge Pin
910AL	25054	Presser Foot Plate Hinge Pin Set Screw
1695J	25054	Presser Foot Plate Hinge Pin Set Screw Nut
146838	25054	Presser Foot Shank with 910AL and 1695J
146825	25054	Presser Foot (hinged) complete for French seaming for 7/16 in. and 1/2 in. gauges, Nos. 26276, 146824 and 146838
		NOTE: When ordering No. 146825, state gauge required.

No.	Plate	Name
190J	25045	Presser Foot Screw
140441W	25045	Pressure Regulating Thumb Screw
51614W	25045	Pressure Regulating Thumb Screw Nut
146616	25069	Set of Mated Gears for Lower Shaft consisting of Arm Shaft (upright) Bevel Gear (lower) and Bead Rotary Shaft Bevel Gear
146775	25069	Set of Mated Gears for Upper Shaft consisting of Arm Shaft (upright) Bevel Gear (upper) and Feed Lifting Eccentric and Arm Shaft (horizontal) Bevel Gear
146617	25050	Slack Thread Controller
54242	25050	Slack Thread Controller Clamp
176J	25050	Slack Thread Controller Clamp Screw
140239J	25050	Slack Thread Controller Position Screw
143085	25036	Stitch Regulator
143134	25036	Stitch Regulator 143085 with 140549E, 143086 and 143378
143086	25036	Stitch Regulator Locking Slide
143087	25036	Stitch Regulator Locking Slide Ratchet Wheel
143088	25036	Stitch Regulator Locking Slide Ratchet Wheel Pin
143378	25036	Stitch Regulator Locking Slide Spring
140549E	25036	Stitch Regulator Locking Slide Spring Screw
2102	25048	Tension (looper thread) Disc (4)
51570C	25048	Tension (looper thread) Regulating Thumb Nut (2)
140442C	25048	Tension (looper thread) Screw Stud (2)
146618	25048	Tension (looper thread) Screw Stud 140442C with 51570C (2)
131740	25048	Tension (looper thread) Spring (2)
59537	25048	Tension (looper thread) Spring Bushing (large) (2)
59538	25048	Tension (looper thread) Spring Bushing (small) (2)
146619	25048	Tension (looper thread) Thread Guard
131696	25048	Tension (looper thread) Thread Guide (2)
54070	25049	Tension (needle thread) Bracket
140443J	25049	Tension (needle thread) Bracket Screw
2102	25049	Tension (needle thread) Disc (4)
51570C	25049	Tension (needle thread) Regulating Thumb Nut (2)
32572	25049	Tension (needle thread) Releasing Disc (2)
54988	25049	Tension (needle thread) Releasing Pin (2)
54071	25049	Tension (needle thread) Releasing Shaft
54872	25049	Tension (needle thread) Releasing Shaft Crank with 624AL
146620	25049	Tension (needle thread) Releasing Shaft Crank Connecting Link
110C	25049	Tension (needle thread) Releasing Shaft Crank Connecting Link Hinge Screw (2)
624AL	25049	Tension (needle thread) Releasing Shaft Crank Set Screw
316C	25049	Tension (needle thread) Releasing Shaft Stop Screw
1547J	25049	Tension (needle thread) Releasing Shaft Stop Screw Nut
50326C	25049	Tension (needle thread) Screw Stud (2)
59539	25049	Tension (needle thread) Screw Stud 50326C with 51570C (2)
131741	25049	Tension (needle thread) Spring (2)
59537	25049	Tension (needle thread) Spring Bushing (large) (2)
59538	25049	Tension (needle thread) Spring Bushing (small) (2)
131696	25049	Tension (needle thread) Thread Guide (2)
146795	25048	Thread (looper) Uncurler (2)
146621	25040	Thread (looper) Take-up with 465AL
1029J	25040	Thread (looper) Take-up Screw
465AL	25040	Thread (looper) Take-up Set Screw
146622	25040	Thread (looper) Take-up Screw Washer (fiber)
146623	25047	Thread (looper) Take-up Stripper
146624	25047	Thread (looper) Take-up Stripper Holder with 906AL
146625	25047	Thread (looper) Take-up Stripper Plate
146603	25047	Thread (looper) Take-up Stripper Plate 146625 with 237J, 139148, 146623, 146624, 146626, 146628 and two 190J

No.	Plate	Name
237J	25047	Thread (looper) Take-up Stripper Plate Screw
146626	25047	Thread (looper) Take-up Stripper Plate Support Plate (2)
	NOTE:	One No. 146626 is screwed onto Machine Bed.
190X	25047	Thread (looper) Take-up Stripper Plate Support Plate Screw (4)
906AL	25047	Thread (looper) Take-up Stripper Srt Screw
139148	25047	Thread (looper) Take-up Stripper Staple
190J	25047	Thread (looper) Take-up Stripper Staple Screw (2)
146627	25047	Thread (looper) Take-up Thread Guide (left)
237J	25047	Thread (looper) Take-up Thread Guide (left) Screw
146628	25047	Thread (looper) Take-up Thread Guide (right)
237J	25047	Thread (looper) Take-up Thread Guide (right) Screw
146631	25048	Thread (looper) Thread Tube
1628X	25048	Thread (looper) Thread Tube Screw Stud Nut
146671	25048	Thread (looper) Thread Tube Screw Stud Nut Washer
146632	25048	Thread (looper) Thread Tube Thread Guide
50027J	25048	Thread (looper) Thread Tube Thread Guide Screw
139158	25050	Thread (looper) Thread Guide (left)
229J	25050	Thread (looper) Thread Guide (left) Screw (2)
139158	25050	Thread (looper) Thread Guide (right)
229J	25050	Thread (looper) Thread Guide (right) Screw (2)
146629	25050	Thread (needle) Thread Guide Bracket
140443J	25050	Thread (needle) Thread Guide Bracket Screw
146630	25050	Thread (needle) Thread Guide Bracket Support
217J	25050	Thread (needle) Thread Guide Bracket Support (lower) Screw
237J	25050	Thread (needle) Thread Guide Bracket Support (upper) Screw
146633	25050	Thread (needle) Eyelet (side of arm)
176J	25050	Thread (needle) Eyelet (side of arm) Position Screw
7071	25050	Thread (needle) Eyelet (side of arm) Position Screw Washer
724J	25050	Thread (needle) Eyelet (side of arm) Screw
146634	25045	Thread (needle) Take-up with 51460E
51460E	25045	Thread (needle) Take-up Clamping Screw
54095	25045	Thread (needle) Take-up Plate
68164	25045	Thread (needle) Take-up Spring
1449J	25045	Thread (needle) Take-up Spring Screw
146635	25045	Thread (needle) Take-up complete, Nos. 1449J, 54095, 68164 and 146634
146763	25058	Throat Plate for Lap Seam Felling for 3/32 in. to 1/4 in. gauges for 131032
	NOTE:	When ordering No. 146763, state gauge required.
146803	25057	Throat Plate for plain sewing and French seaming for 3/32 in. to 3/8 in. gauges for 131032
	NOTE:	When ordering No. 146803, state gauge required.
146855	25056	Throat Plate for Piecing or Goring, for 1/8 in. and 5/32 in. gauges, for 146854
	NOTE:	When ordering No. 146855, state gauge required.
146860	25055	Throat Plate for sleeving and straight run lap seam felling for 3/16 in., 7/32 in., 1/4 in., 9/32 in., 5/16 in. and 11/32 in. 3/8 in. gauges, for 146856
	NOTE:	When ordering No. 146860, state gauge required.
146826	25054	Throat Plate for French seaming for 7/16 in. and 1/2 in. gauges, for 146823
	NOTE:	When ordering No. 146826, state gauge required.
691F	25054	Throat Plate Screw (2)

ACCESSORIES

No.	Plate	Name
146637	25015	Machine Base and Oil Reservoir
146638	25015	Machine Base and Oil Reservoir 146637 with 146639, 146693, 146695 and two 146640 (for Agents only)
146639	25015	Machine Base and Oil Reservoir Gasket (felt)
146693	25015	Machine Base and Oil Reservoir Oil Return Wick
146695	25015	Machine Base and Oil Reservoir Oil Return Wick Position Pad (felt)
143308	25016	Machine Cushion (felt) (4)
12361	25016	Machine Hinge Connection (2)
146640	25015	Machine Pad (felt) (2)
41400	25016	Machine Rest Pin (wood)
120344	25016	Oiler with 120345
120345	25016	Oiler Spout
121741	25016	One Quart Can of Light Grade Stainless Oil
120440	25016	Screw Driver
121108	25016	Screw Driver
120341	25016	Tweezers (curved)
8908	25016	Wrench
23535	25016	Wrench
42850	25016	Wrench
146057	25016	Wrench (socket) for 140552
150855	25016	Wrench (socket)

EDGE FOLDERS ON SHANK

No.	Plate	Name
161084	25054	Edge Guide with Adjustable Edge Folder on Shank, for 1/4 in. to 1/2 in. needle gauge
	NOTE:	When ordering No. 161084, state needle gauge required.
161092	25063	Edge Folder with Adjustable Edge Guide on Shank for 3/16 in. to 1/2 in. needle gauge
	NOTE:	When ordering No. 161092, state needle gauge required.

HEMMER ON SHANK

No.	Plate	Name
161090	25065	Hemmer on Shank (turn down) for 5/16 in. to 5/8 in. hem in steps of 1/16 in. for hemming overall pockets
	NOTE:	When ordering No. 161090, state size of hem and furnish sample material or furnish finished sample and sample material.

FACE PLATE THREAD LUBRICATOR

No.	Plate	Name
241755	25051	Thread Lubricator Oil Pad (felt)
146806	25051	Thread Lubricator Oil Pad Holder
146807		Thread Lubricator Oil Pad Holder 146806 with 62827, 240439 and 241755
240439	25051	Thread Lubricator Oil Pad Retainer
17822	25051	Thread Lubricator Oil Reservoir Rivet
8068	25051	Thread Lubricator Oil Reservoir Rivet Washer (inside)
124371	25051	Thread Lubricator Oil Reservoir Rivet Washer (outside)
62827	25051	Thread Lubricator Oil Wick
146808		Thread Lubricator complete, Nos. 8068, 17822, 124371 and 146807
146809	25051	Thread Lubricator 146808 with 7071, 21202, 50222J, 140224J and 146810
146810	25051	Thread Lubricator Adaptor
140224J	25051	Thread Lubricator Adaptor Screw
7071	25051	Thread Lubricator Adaptor Screw Washer
50222J	25051	Thread Lubricator Screw
21202	25051	Thread Lubricator Screw Washer

FITTINGS

FOR LAP SEAM FELLING, FOR 3/32 IN. TO 3/8 IN. GAUGES

No.	Plate	Name
146523	25059	Bed Slide (right)
146525	25059	Bed Slide (right) Knob
146524	25042	Bed Slide (right) Spring
1423X	25042	Bed Slide (right) Spring Screw
240C	25042	Bed Slide (right) Spring Stop Screw (2)
146526	25059	Bed Slide (right, button-type) complete for Throat Plates with 3/64 in. off-set, Nos. 1423X, 146523, 146524, 146525 and two 240C
146531	25059	Feed Dog, 15 teeth (14 teeth to the inch) for 146636
		NOTE: When ordering No. 146531, state gauge required.
160587	25059	Lap Seam Feller (adjustable) on Shank, for light, medium, medium over light, medium heavy over medium and medium heavy over heavyweight material
		NOTE: When ordering No. 160587, needle gauge of Machine and weight of material must be stated.
160619	25059	Lap Seam Feller (adjustable) on Shank for light, medium and medium heavy over medium weight material
		NOTE: When ordering No. 160619, needle gauge of Machine and weight of material must be stated.
160622	25059	Lap Seam Feller on Shank with Yielding (lower) scroll for medium heavy and heavy weight material
		NOTE: When ordering No. 160622, needle gauge of Machine and weight of material must be stated.
121449	25059	Lap Seam Feller Clamping Plate
1423J	25059	Lap Seam Feller Clamping Plate Screw (2)
139135	25059	Presser Foot Plate
26276	25059	Presser Foot Plate Hinge Pin
146850	25059	Presser Foot Shank
139134	25059	Presser Foot Yielding Heel
146851	25059	Presser Foot Yielding Heel Connection
26276	25059	Presser Foot Yielding Heel Connection Hinge Pin
37160	25059	Presser Foot Yielding Heel Connection Spring
26276	25059	Presser Foot Yielding Heel Hinge Pin
146615	25059	Presser Foot (triple hinged) complete for 3/32 in. to 5/16 in. gauges, Nos. 37160, 139134, 139135, 146850, 146851 and three 26276
		NOTE: When ordering No. 146615, state gauge required.
139490	25059	Presser Foot Plate
26276	25059	Presser Foot Plate Hinge Pin
146850	25059	Presser Foot Shank
139489	25059	Presser Foot Yielding Heel
146851	25059	Presser Foot Yielding Heel Connection
26276	25059	Presser Foot Yielding Heel Connection Hinge Pin
37160	25059	Presser Foot Yielding Heel Connection Spring
26276	25059	Presser Foot Yielding Heel Hinge Pin
146753	25059	Presser Foot (triple hinged) complete for 11/32 in. and 3/8 in. gauges, Nos. 37160, 139489, 139490, 146850, 146851 and three 26276
		NOTE: When ordering No. 146753, state gauge required.
146636	25059	Throat Plate for 3/32 in. to 3/8 in. gauges for 146531
		NOTE: When ordering No. 146636, state gauge required.

FITTINGS

FOR LAP SEAM FELLING, FOR 3/32 IN. TO 3/8 IN. GAUGES

No.	Plate	Name
146523	25060	Bed Slide (right)
146525	25060	Bed Slide (right) Knob
146524	25042	Bed Slide (right) Spring
1423X	25042	Bed Slide (right) Spring Screw
240C	25042	Bed Slide (right) Spring Stop Screw (2)
146526	25060	Bed Slide (right, button-type) complete for Throat Plates with 3/64 in. off-set, Nos. 1423X, 146523, 146524, 146525 and two 240C
146772	25060	Feed Dog, 15 teeth (14 teeth to the inch) for 146773
		NOTE: When ordering No. 146772, state gauge required.
160587	25060	Lap Seam Feller (adjustable) on Shank for light, medium, medium over light, medium heavy over medium and medium heavy over heavyweight material
		NOTE: When ordering No. 160587, needle gauge of Machine and weight of material must be stated.
160619	25060	Lap Seam Feller (adjustable) on Shank for light, medium and medium heavy over medium weight material
		NOTE: When ordering No. 160619, needle gauge of Machine and weight of material must be stated.
160622	25060	Lap Seam Feller on Shank with Yielding (lower) scroll for medium heavy and heavy weight material
		NOTE: When ordering No. 160622, needle gauge of Machine and weight of material must be stated.
121449	25060	Lap Seam Feller Clamping Plate
1423J	25060	Lap Seam Feller Clamping Plate Screw (2)
139135	25060	Presser Foot Plate
26276	25060	Presser Foot Plate Hinge Pin
146850	25060	Presser Foot Shank
139134	25060	Presser Foot Yielding Heel
146851	25060	Presser Foot Yielding Heel Connection
26276	25060	Presser Foot Yielding Heel Connection Hinge Pin
37160	25060	Presser Foot Yielding Heel Connection Spring
26276	25060	Presser Foot Yielding Heel Hinge Pin
146615	25060	Presser Foot (triple hinged) complete for 3/32 in. to 5/16 in. gauges, Nos. 37160, 139134, 139135, 146850, 146851 and three 26276
		NOTE: When ordering 146615, state gauge required.
139490	25060	Presser Foot Plate
26276	25060	Presser Foot Plate Hinge Pin
146850	25060	Presser Foot Shank
139489	25060	Presser Foot Yielding Heel
146851	25060	Presser Foot Yielding Heel Connection
26276	25060	Presser Foot Yielding Heel Connection Hinge Pin
37160	25060	Presser Foot Yielding Heel Connection Spring
26276	25060	Presser Foot Yielding Heel Hinge Pin
146753	25060	Presser Foot (triple hinged) complete for 11/32 in. and 3/8 in. gauges, Nos. 37160, 139489, 139490, 146850, 146851 and three 26276
		NOTE: When ordering No. 146753, state gauge required.
146773	25060	Throat Plate for 3/32 in.-1/8 in., 5/32 in.-3/16 in., 7/32 in.-1/4 in., 9/32 in.-5/16 in. and 11/32 in.-3/8 in. gauges for 146772
		NOTE: When ordering No. 146773, state gauge required.

FITTINGS

FOR LAP SEAM FELLING LIGHT TO HEAVYWEIGHT MATERIALS FOR SLEEVING, PIECING AND GENERAL WORK, FOR 5/32 IN. TO 3/8 IN. GAUGES

No.	Plate	Name
146834	25061	Bed Slide (right)
146525	25061	Bed Slide (right) Knob
146524	25042	Bed Slide (right) Spring
1423X	25042	Bed Slide (right) Spring Screw
240C	25042	Bed Slide (right) Spring Stop Screw (2)
146835	25061	Bed Slide (right, button-type) complete for Throat Plates with 3/32 in. off-set, Nos. 1423X, 146524, 146525, 146834 and two 240C
146836	25061	Feed Dog with row of teeth between needles, 17 teeth (14 teeth to the inch) for 146840
		NOTE: When ordering No. 146836, state gauge required.
161091	25061	Lap Seam Feller (adjustable) on Shank with Yielding lower scroll, for light to heavy weight materials
		NOTE: When ordering No. 161091, needle gauge of Machine and weight of material must be stated.
121449	25061	Lap Seam Feller Clamping Plate
1423J	25061	Lap Seam Feller Clamping Plate Screw (2)
146837	25061	Presser Foot Plate
26276	25061	Presser Foot Plate Hinge Pin
910AL	25061	Presser Foot Plate Hinge Pin Set Screw
1695J	25061	Presser Foot Plate Hinge Pin Set Screw Nut
146838	25061	Presser Foot Shank with 910AL and 1695J
146839	25061	Presser Foot (hinged) complete, Nos. 26276, 146837 and 146838
		NOTE: When ordering No. 146839, state gauge required.
146840	25061	Throat Plate for 5/32 in. to 3/8 in. gauges, for 146836
		NOTE: When ordering No. 146840, state gauge required.

FITTINGS

FOR PIECING UNDERWEAR, FOR 5/32 IN. TO 3/8 IN. GAUGES

No.	Plate	Name
146523	25062	Bed Slide (right)
146525	25062	Bed Slide (right) Knob
146524	25042	Bed Slide (right) Spring
1423X	25042	Bed Slide (right) Spring Screw
240C	25042	Bed Slide (right) Spring Stop Screw
146526	25062	Bed Slide (right, button-type) complete for Throat Plates with 3/64 in. off-set, Nos. 1423X, 146523, 146524, 146525 and two 240C
146836	25062	Feed Dog with row of teeth between needles, 17 teeth (14 teeth to the inch) for 146840
		NOTE: When ordering No. 146836, state gauge required.
160944	25062	Lap Seam Feller (adjustable) on Shank for light to heavy weight material
		NOTE: When ordering No. 160944, needle gauge of Machine and weight of material must be specified.
161093	25062	Lap Seam Feller on Shank for light and medium weight material
		NOTE: When ordering No. 161093, needle gauge of Machine and weight of material must be stated.
121449	25062	Lap Seam Feller Clamping Plate
1423J	25062	Lap Seam Feller Clamping Plate Screw (2)
146837	25062	Presser Foot Plate
26276	25062	Presser Foot Plate Hinge Pin

FITTINGS

No.	Plate	Name
910AL	25062	Presser Foot Plate Hinge Pin Set Screw
1695J	25062	Presser Foot Plate Hinge Pin Set Screw Nut
146838	25062	Presser Foot Shank with 910AL and 1695J
146839	25062	Presser Foot (hinged) complete, Nos. 26276, 146837 and 146838
		NOTE: When ordering No. 146839, state gauge required.
146840	25062	Throat Plate for 5/32 in. to 3/8 in. gauges for 146836
		NOTE: When ordering No. 146840, state gauge required.

FITTINGS

FOR FIRST OPERATION FOR IMITATION SINGLE NEEDLE SLEEVING, FOR 5/32 IN. AND 3/16 IN. GAUGES

No.	Plate	Name
146848	25063	Bed Slide (right)
146525	25063	Bed Slide (right) Knob
146524	25042	Bed Slide (right) Spring
1423X	25042	Bed Slide (right) Spring Screw
240C	25042	Bed Slide (right) Spring Stop Screw (2)
146846	25063	Bed Slide (right, button-type) complete for Throat Plates with 9/64 in. off-set, Nos. 1423X, 146524, 146525, 146848 and two 240C
146711	25063	Feed Dog with row of teeth between needles, 14 teeth (14 teeth to the inch) for 5/32 in. to 3/8 in. gauges for 146714
		NOTE: When ordering No. 146711, state gauge required.
161092	25063	Edge Folder with Adjustable Edge Guide on Shank for 3/16 in. to 1/2 in. gauges
		NOTE: When ordering No. 161092, state gauge required.
160588	25063	Edge Folder Clamping Plate
1174J	25063	Edge Folder Clamping Plate Screw (2)
146761	25063	Presser Foot Plate
26276	25063	Presser Foot Plate Hinge Pin
146712	25063	Presser Foot Shank
146762	25063	Presser Foot (hinged) complete, Nos. 26276, 146712 and 146761
		NOTE: When ordering No. 146762, state gauge required.
146714	25063	Throat Plate for 5/32 in. to 3/8 in. gauges for 146711
		NOTE: When ordering No. 146714, state gauge required.

FITTINGS

FOR FRENCH LAP SEAM FELLING FOR 3/8 IN. TO 1/2 IN. GAUGES

No.	Plate	Name
146523	25064	Bed Slide (right)
146525	25064	Bed Slide (right) Knob
146524	25042	Bed Slide (right) Spring
1423X	25042	Bed Slide (right) Spring Screw
240C	25042	Bed Slide (right) Spring Stop Screw (2)
146526	25064	Bed Slide (right button-type) complete for Throat Plates with 3/64 in. off-set, Nos. 1423X, 146523, 146524, 146525 and 240C
161084	25064	Edge Guide with Adjustable Edge Folder on Shank for 1/4 in. to 1/2 in. needle gauge
		NOTE: When ordering No. 161084, state needle gauge required.
121449	25064	Edge Guide with Adjustable Edge Folder on Shank Clamping Plate
1423J	25064	Edge Guide with Adjustable Edge Folder on Shank Clamping Plate Screw (2)

FITTINGS

No.	Plate	Name
146841	25064	Feed Dog, 17 teeth (16 teeth to the inch) for 146844.
		NOTE: When ordering No. 146841, state gauge required.
146842	25064	Presser Foot Plate
26276	25064	Presser Foot Plate Hinge Pin
910AL	25064	Presser Foot Plate Hinge Pin Set Screw
1695J	25064	Presser Foot Plate Hinge Pin Set Screw Nut
146838	25064	Presser Foot Shank with 910AL and 1695J
146843	25064	Presser Foot (hinged) complete, Nos. 26276, 146838 and 146842
		NOTE: When ordering No. 146843, state gauge required.
146844	25064	Throat Plate for 3/8 in. to 1/2 in. gauges for 146841
		NOTE: When ordering No. 146844, state gauge required.

FITTINGS

FOR HEMMING OVERALL POCKETS FOR 3/16 IN. TO 3/8 IN. GAUGES

No.	Plate	Name
146834	25065	Bed Slide (right)
146525	25065	Bed Slide (right) Knob
146524	25042	Bed Slide (right) Spring
1423X	25042	Bed Slide (right) Spring Screw
240C	25042	Bed Slide (right) Spring Stop Screw (2)
146835	25065	Bed Slide (right, button-type) complete for Throat Plates with 3/32 in. off-set, Nos. 1423X, 146524, 146525, 146834 and two 240C
146715	25065	Feed Dog with row of teeth between needles, 13 teeth (10 teeth to the inch) for 146718
		NOTE: When ordering No. 146715, state gauge required.
161090	25065	Hemmer on Shank (turn down) for 5/16 in. to 5/8 in. hem in steps of 1/16 in.
		NOTE: When ordering No. 161090, state size of hem and furnish sample material or furnish finished sample and sample material.
121449	25065	Hemmer on Shank (turn down) Clamping Plate
1423J	25065	Hemmer on Shank (turn down) Clamping Plate Screw (2)
161085	25065	Presser Foot Plate
26276	25065	Presser Foot Plate Hinge Pin
910AL	25065	Presser Foot Plate Hinge Pin Set Screw
1695J	25065	Presser Foot Plate Hinge Pin Set Screw Nut
146838	25065	Presser Foot Shank with 910AL and 1695J
161086	25065	Presser Foot (hinged) complete for inserting labels and hemming overall pockets, Nos. 26276, 146838 and 161085
		NOTE: When ordering No. 161086, state gauge required.
161087	25065	Presser Foot Plate
26276	25065	Presser Foot Plate Hinge Pin
906AL	25065	Presser Foot Plate Hinge Pin Set Screw
1695J	25065	Presser Foot Plate Hinge Pin Set Screw Nut
161088	25065	Presser Foot Shank with 906AL and 1695J
161089	25065	Presser Foot (hinged) complete for sewing overall material, Nos. 26276, 161087 and 161088
		NOTE: When ordering No. 161089, state gauge required.
146718	25065	Throat Plate for 3/16 in. to 3/8 in. gauges for 146715
		NOTE: When ordering No. 146718, state gauge required.

FITTINGS

FOR PLAIN SEWING, FOR 3/32 IN. TO 3/8 IN. GAUGES

No.	Plate	Name
146523	25066	Bed Slide (right)
146525	25066	Bed Slide (right) Knob
146524	25042	Bed Slide (right) Spring
1423X	25042	Bed Slide (right) Spring Screw
240C	25042	Bed Slide (right) Spring Stop Screw (2)
146526	25066	Bed Slide (right, button-type) complete for Throat Plates with 3/64 in. off-set, Nos. 1423X, 146523, 146524, 146525 and two 240C
146802	25066	Feed Dog, 17 teeth (16 teeth to the inch) for 3/32 in. and 1/8 in. gauges, for 146803
		NOTE: When ordering No. 146802, state gauge required.
146711	25066	Feed Dog with row of teeth between needles, 14 teeth (14 teeth to the inch) for 5/32 in. to 3/8 in. gauges, for 146778
		NOTE: When ordering No. 146711, state gauge required.
146761	25066	Presser Foot Plate
26276	25066	Presser Foot Plate Hinge Pin
146712	25066	Presser Foot Shank
146762	25066	Presser Foot (hinged) complete for 3/32 in. to 3/8 in. gauges, Nos. 26276, 146712 and 146761
		NOTE: When ordering No. 146762, state gauge required.
146803	25066	Throat Plate for 3/32 in. and 3/8 in. gauges, for 146802
		NOTE: When ordering No. 146803, state gauge required.
146778	25066	Throat Plate for 5/32 in. to 3/8 in. gauges, for 146711
		NOTE: When ordering No. 146778, state gauge required.

FITTINGS

FOR LAP SEAM FELLING FOR REGULAR WORK, FOR 13/32 IN. TO 1/2 IN. GAUGES

No.	Plate	Name
146849	25067	Bed Slide (right)
146525	25067	Bed Slide (right) Knob
146524	25042	Bed Slide (right) Spring
1423X	25042	Bed Slide (right) Spring Screw
240C	25042	Bed Slide (right) Spring Stop Screw (2)
146847	25042	Bed Slide (right, button-type) complete for Throat Plates with 3/16 in. off-set, Nos. 1423X, 146524, 146525, 146849 and two 240C
161100	25067	Feed Dog with row of teeth between needles, 17 teeth (14 teeth to the inch) for 161101
		NOTE: When ordering No. 161100, state gauge required.
161091	25067	Lap Seam Feller (adjustable) on Shank with Yielding lower scroll, for light to heavy weight materials
		NOTE: When ordering No. 161091, needle gauge of Machine and weight of material must be specified.
121449	25067	Lap Seam Feller Clamping Plate
1423J	25067	Lap Seam Feller Clamping Plate Screw (2)
161098	25067	Presser Foot Plate
26276	25067	Presser Foot Plate Hinge Pin
146850	25067	Presser Foot Shank
139134	25067	Presser Foot Yielding Heel
146851	25067	Presser Foot Yielding Heel Connection
26276	25067	Presser Foot Yielding Heel Connection Hinge Pin
37160	25067	Presser Foot Yielding Heel Connection Spring
26276	25067	Presser Foot Yielding Heel Hinge Pin
161099	25067	Presser Foot (triple hinged) complete, Nos. 37160, 139134, 146850, 146851, 161098 and three 26276
		NOTE: When ordering No. 161099, state gauge required.
161101	25067	Throat Plate for 11/32 in. to 1/2 in. gauges for 161100
		NOTE: When ordering No. 161101, state gauge required.

FITTINGS

FOR LAP SEAM FELLING FOR HEAVY WORK,
FOR 13/32 IN. AND 1/2 IN. GAUGES

No.	Plate	Name
146849	25068	Bed Slide (right).....
146525	25068	Bed Slide (right) Knob
146524	25042	Bed Slide (right) Spring
1423X	25042	Bed Slide (right) Spring Screw
240C	25042	Bed Slide (right) Spring Stop Screw (2)
146847	25068	Bed Slide (right, button-type) complete for Throat Plates with 3/16 in. off-set, Nos. 1423X, 146524, 146525, 146849 and two 240C
161100	25068	Feed Dog with row of teeth between needles, 17 teeth (14 teeth to the inch) for 161101
		NOTE: When ordering No. 161100, state gauge required.
161091	25068	Lap Seam Feller (adjustable) on Shank with Yielding lower scroll, for light to heavy weight materials
		NOTE: When ordering No. 161091, needle gauge of Machine and weight of material must be stated.
121449	25068	Lap Seam Feller Clamping Plate
1423J	25068	Lap Seam Feller Clamping Plate Screw (2)
161095	25068	Presser Foot Plate
26276	25068	Presser Foot Plate Hinge Pin
146850	25068	Presser Foot Shank
161096	25068	Presser Foot Yielding Heel
146851	25068	Presser Foot Yielding Heel Connection
26276	25068	Presser Foot Yielding Heel Connection Hinge Pin
37160	25068	Presser Foot Yielding Heel Connection Spring
26276	25068	Presser Foot Yielding Heel Hinge Pin
161097	25068	Presser Foot (triple hinged) complete, Nos. 37160, 146850, 146851, 161095, 161096 and three 26276
		NOTE: When ordering No. 161097, state gauge required.
161101	25068	Throat Plate for 11/32 in. to 1/2 in. gauges for 161100
		NOTE: When ordering No. 161101, state gauge required.

FOOT LIFTER PARTS

No.	Plate	Name
6439		Chain, 36 in. to 45 in., with 56864 and 56865
		NOTE: When ordering No. 6439, state length required.
4879	25030	Chain Connecting Link
56864		Chain Hook (large)
56865		Chain Hook (small)
126249	25030	Treadle
4882	25030	Treadle Shaft
126250	25030	Treadle Shaft Spring
150451	25030	Treadle Shaft Stand
150452	25030	Treadle complete, Nos. 4879, 4882, 126249, 126250, 150451 and two wood screws 1 in. No. 16 F.H.

KNEE LIFTER PARTS

No.	Plate	Name
146764	25030	Chain, 10-1/4 in., with 46865 and 56865
56865	25030	Chain Hook
46865	25030	Chain Link
146765	25030	Rock Shaft
146766	25030	Rock Shaft Hanger with two wood screws 1 in., No. 16 F.H. (2)
143283	25030	Rock Shaft Knee Arm
143285		Rock Shaft Knee Arm complete, Nos. 2767, 143283 and 143284
143284	25030	Rock Shaft Knee Arm Hub with 356C and 140351AL
140351AL	25030	Rock Shaft Knee Arm Hub Clamping Screw
356C	25030	Rock Shaft Knee Arm Hub Set Screw
2767	25030	Rock Shaft Knee Arm Plate with 356C
356C	25030	Rock Shaft Knee Arm Plate Screw
6337	25030	Rock Shaft Lifting Bracket with two 356C
7125	25030	Rock Shaft Lifting Bracket Hook
356C	25030	Rock Shaft Lifting Bracket Hook Set Screw
356C	25030	Rock Shaft Lifting Bracket Set Screw
146768	25030	Rock Shaft Spring
1115X	25030	Rock Shaft Spring Screw
146769	25030	Rock Shaft Stop Dog (back) with 140351AL
146770	25030	Rock Shaft Stop Dog (front) with 140351AL
140351AL	25030	Rock Shaft Stop Dog Clamping Screw (2)
146771	25030	Rock Shaft complete, Nos. 1115X, 6337, 7125, 143285, 146765, 146768, 146769, 146770 and two 146766
146779	25030	Knee Lifter complete, Nos. 146764 and 146771

LAP SEAM FELLERS

No.	Plate	Name
160587	25059	Lap Seam Feller (adjustable) on Shank for light, medium, medium over light, medium heavy over medium and medium heavy over heavy weight material
		NOTE: When ordering No. 160587, needle gauge of Machine and weight of material must be stated.
160619	25059	Lap Seam Feller (adjustable) on Shank for light, medium, and medium heavy over medium weight material
		NOTE: When ordering No. 160619, needle gauge of Machine and weight of material must be stated.
160622	25059	Lap Seam Feller on Shank with Yielding (lower) scroll for medium heavy and heavy weight material
		NOTE: When ordering No. 160622, needle gauge of Machine and weight of material must be stated.
160944	25056	Lap Seam Feller (adjustable) on Shank for light to heavy weight material
		NOTE: When ordering No. 160944, needle gauge of Machine and weight of material must be stated.
160945	25055	Lap Seam Feller (adjustable) on Shank for light to heavy weight material
		NOTE: When ordering No. 160945, needle gauge of Machine and weight of material must be stated.
160946	25058	Lap Seam Feller (adjustable) on Shank for light to heavy weight material
		NOTE: When ordering No. 160946, needle gauge of Machine and weight of material must be stated.
161091	25067	Lap Seam Feller (adjustable) on Shank with Yielding (lower) scroll, for light to heavy weight materials
		NOTE: When ordering No. 161091, needle gauge of Machine and weight of material must be stated.
161093	25062	Lap Seam Feller on Shank for light and medium weight material
		NOTE: When ordering No. 161093, needle gauge of Machine and weight of material must be stated.
121449	25055	Lap Seam Feller Clamping Plate
1423J	25055	Lap Seam Feller Clamping Plate Screw (2)

TENSION RELEASER

No.	Plate	Name
146791	25052	Presser Bar Lifting Lever
146792	25052	Tension (looper thread) Releaser (2)
146801		Tension (looper thread) Releaser Nos. 110C, 146620, 146794, 146796, 146797 and two each 72C, 207J, 146792 and 146795
	110C	25052 Tension (looper thread) Releaser Connecting Link Hinge Screw
	207J	25052 Tension (looper thread) Releaser Screw (2)
146794	25052	Tension (looper thread) Releaser Slide
72C	25052	Tension (looper thread) Releaser Slide Hinge Screw (2)
146620	25052	Tension (needle thread) Releasing Shaft Crank Connecting Link
	110C	25052 Tension (needle thread) Releasing Shaft Crank Connecting Link Hinge Screw
68261	25052	Tension (needle thread) Releasing Spring
146795	25052	Thread (looper) Uncurler (2)
146796	25052	Thread (looper) Uncurler Plate (back)
146797	25052	Thread (looper) Uncurler Plate (front)
146799	25052	Tension (looper thread) Releaser complete, Nos. 110C, 68261, 146791 and 146801

THREAD UNWINDER

FOR FOUR SPOOLS

No.	Plate	Name
151032	25018	Base with 138R and three wood screws 1 in. No. 12 F.H.
225257	25018	Spool Rest with 201018C (2)
151033	25018	Spool Rest Bracket
151034	25018	Spool Rest Bracket Rod
138R	25018	Spool Rest Bracket Rod Set Screw
51276R		Spool Rest Bracket Screw
150203	25018	Spool Rest Cushion (felt) (4)
201018C	25018	Spool Rest Set Screw (2)
151035	25018	Thread Guide (4)
1521R	25018	Thread Guide Nut (8)
9525	25018	Thread Guide Nut Washer (8)
151037	25018	Thread Unwinder complete, for four spools, Nos. 51276R, 151032, 151033, 151034, two 225257, four each 150203, 151035 and eight each 1521R and 9525

SINGER Needles should be used
in SINGER Machines
These Needles and their Containers
are marked with the
Company's Trade Mark "SIMANCO.**" 1

Needles in Containers marked
"FOR SINGER MACHINES"
are NOT SINGER made needles. 2

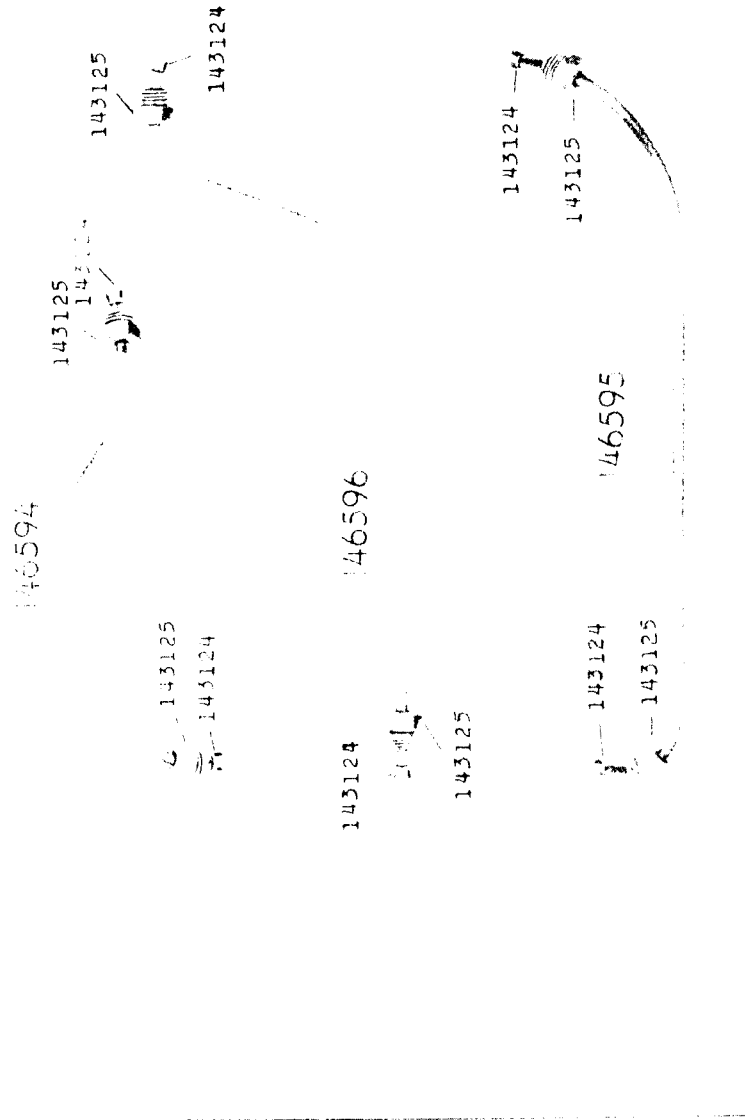

25015 - 1/3

25016 - 1/3

14638

146637

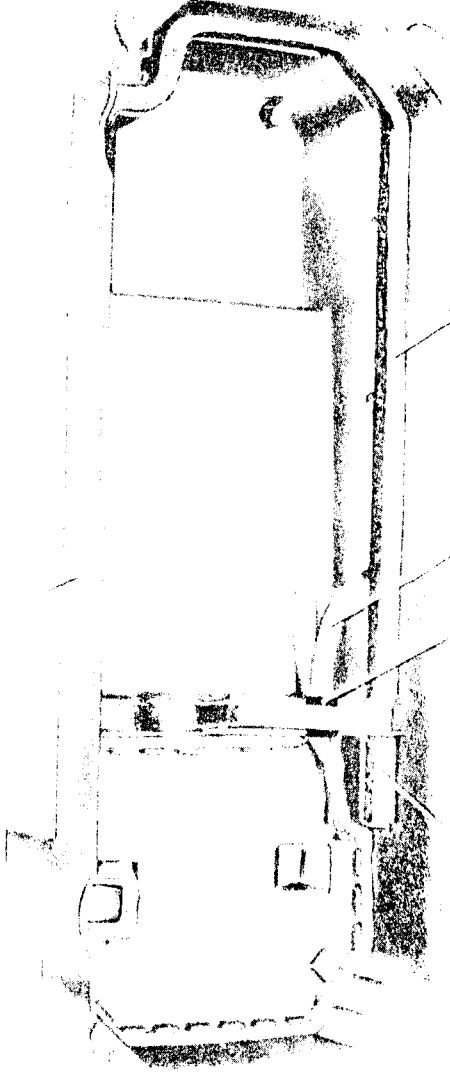

146640

145695

146693

146639

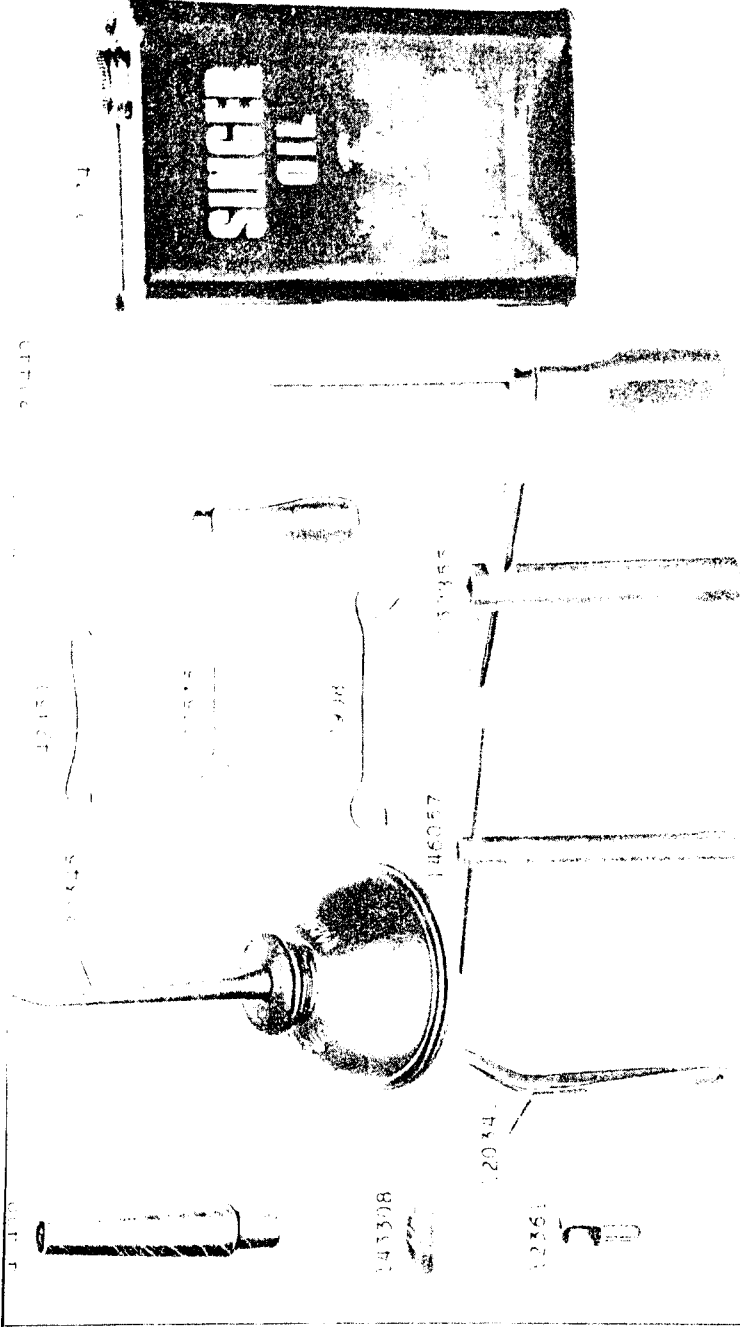

25018 - 1/6

25030 - 1/4

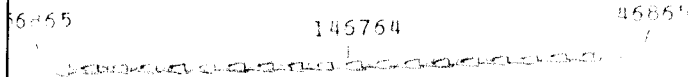
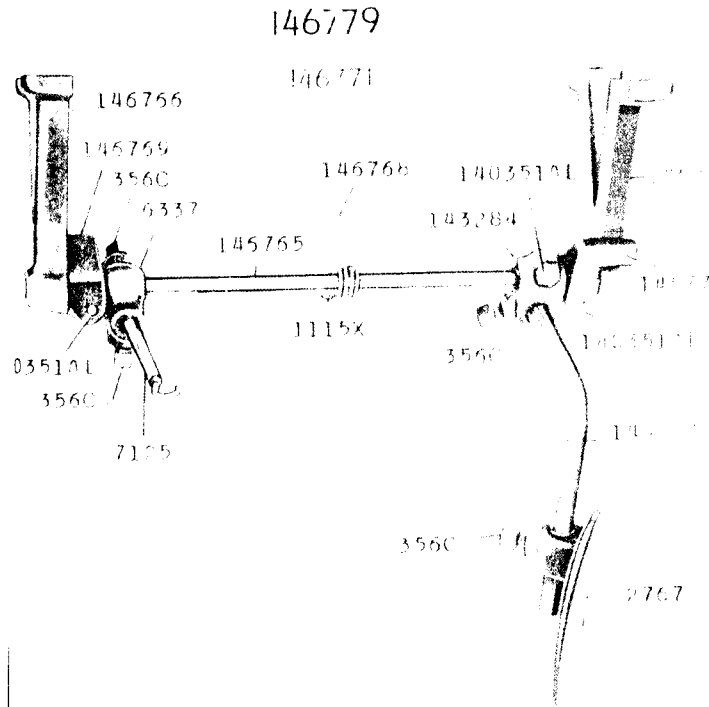
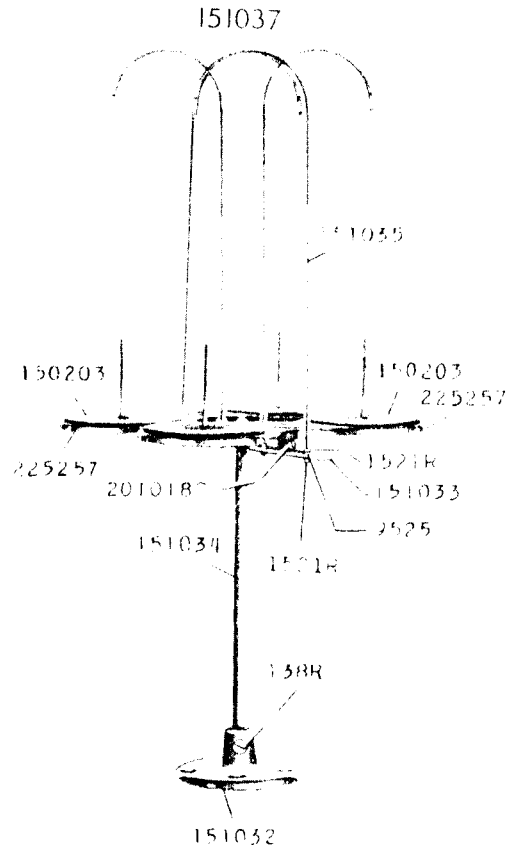
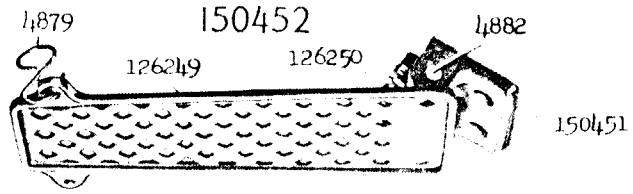

25036-1/3

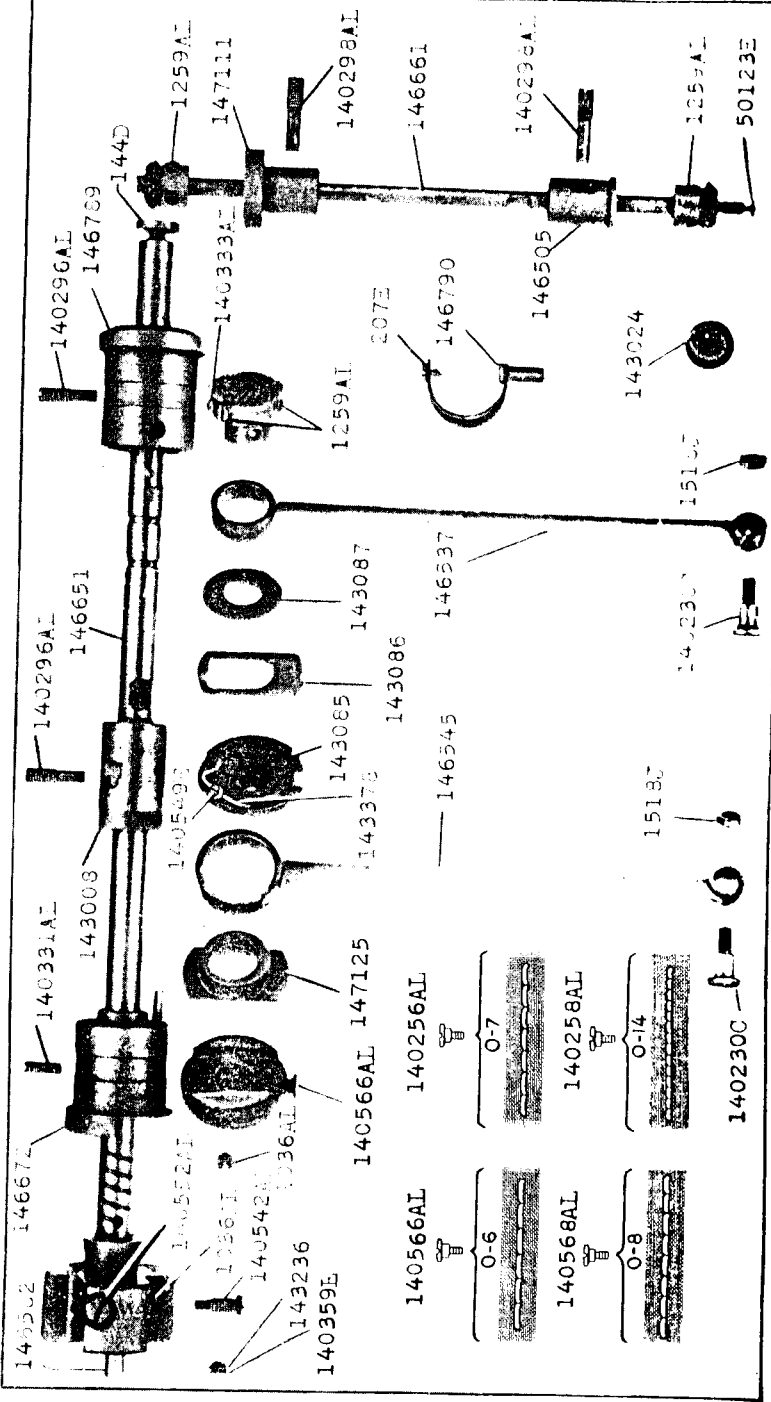

25037-1/2

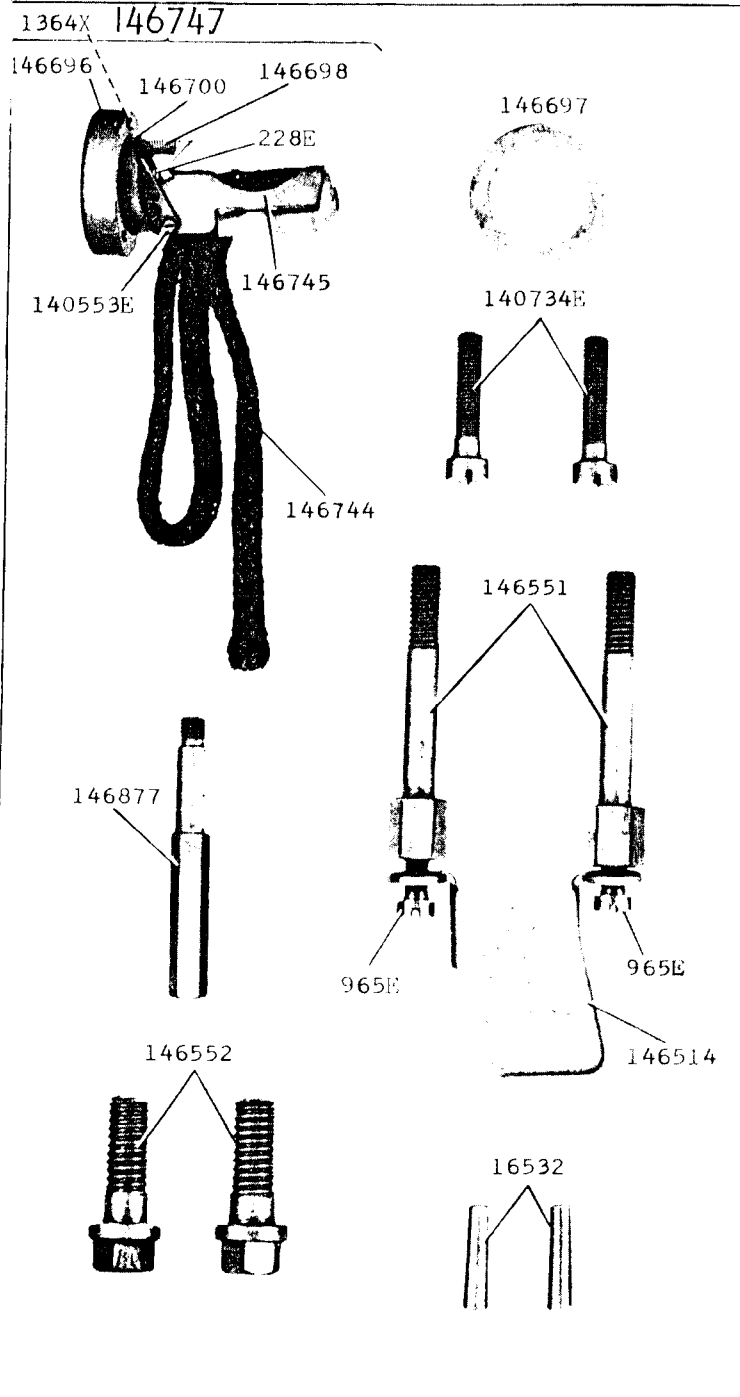

25038-1/2

146512

51283AL

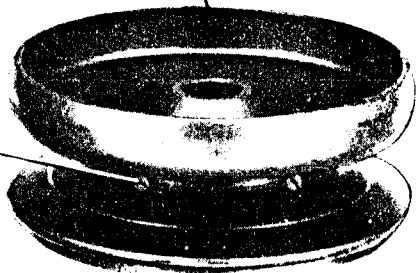

146829

51369R

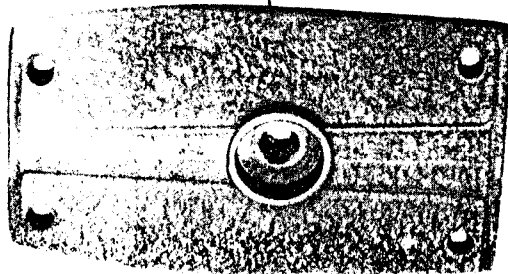

51369R



140676X

25039-1/2

146506

51369R

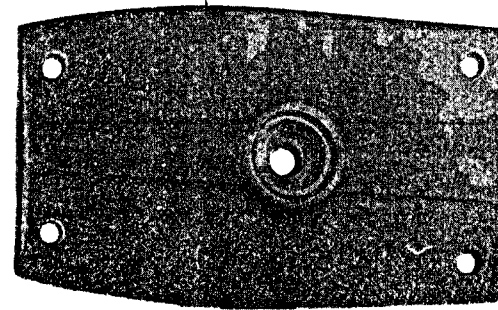

51369R

146508

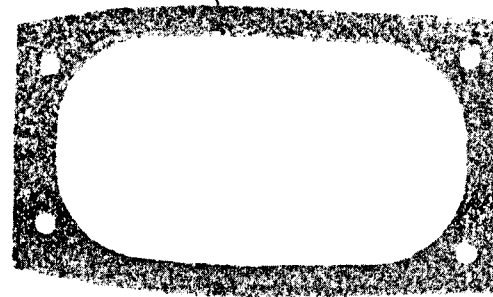

146509

64519



146510

146511

25040-1/3

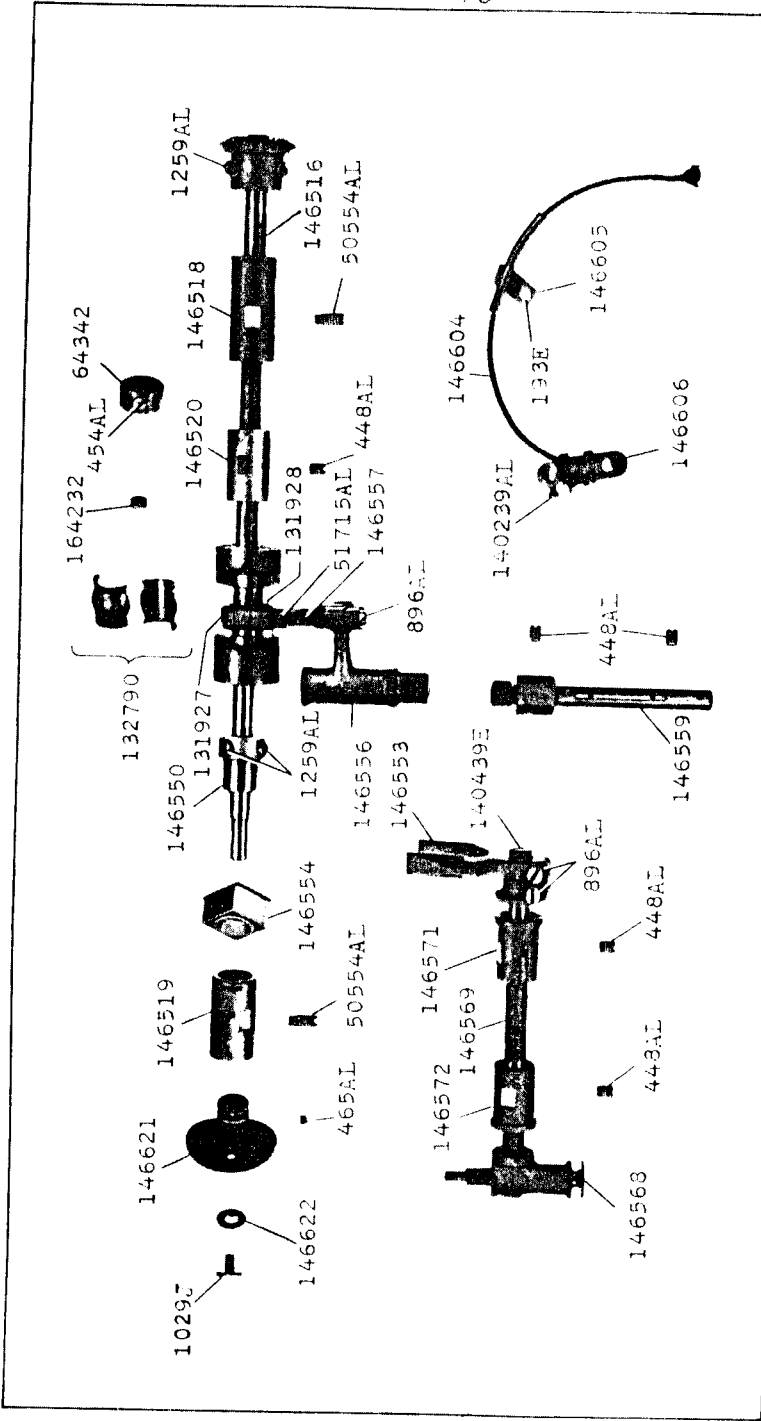

25041-1/2

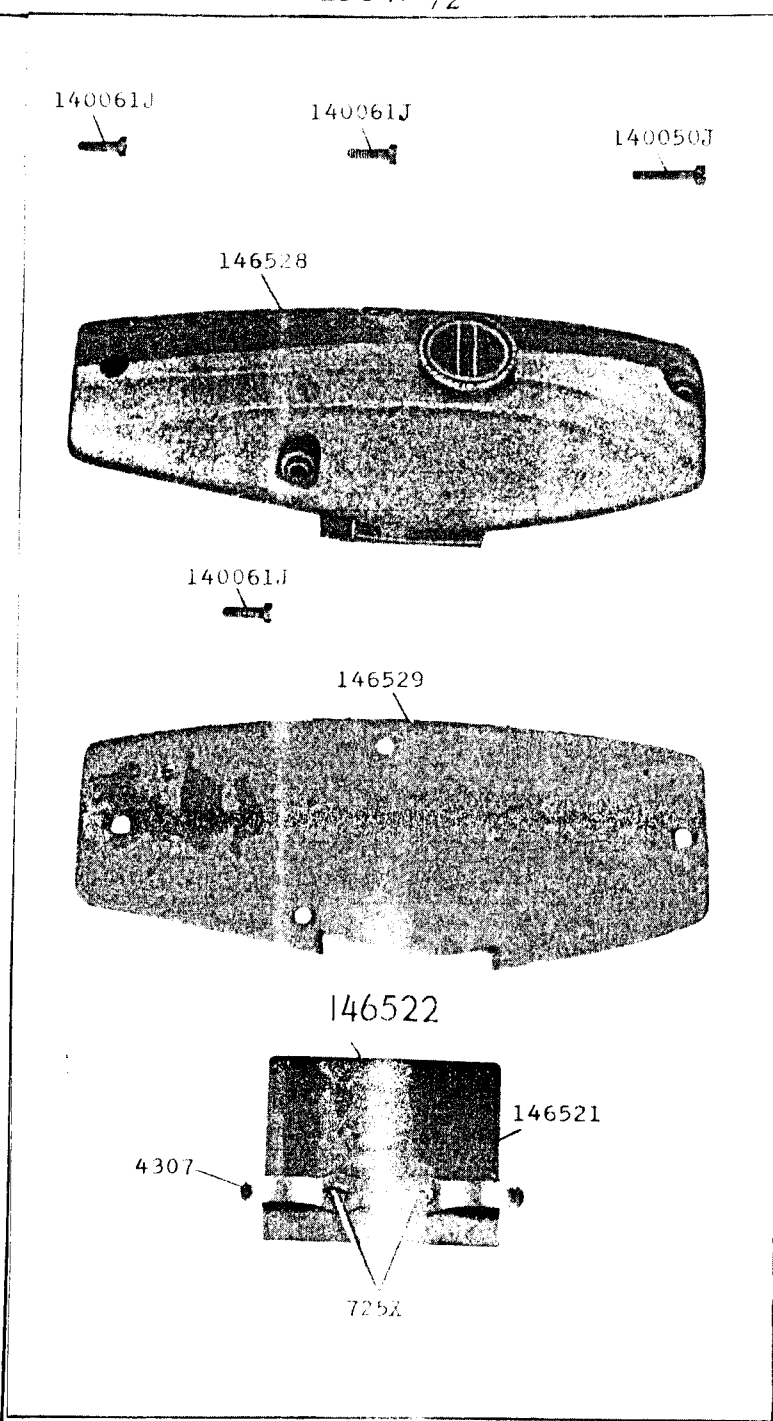

25042-1/2

25043-1/3

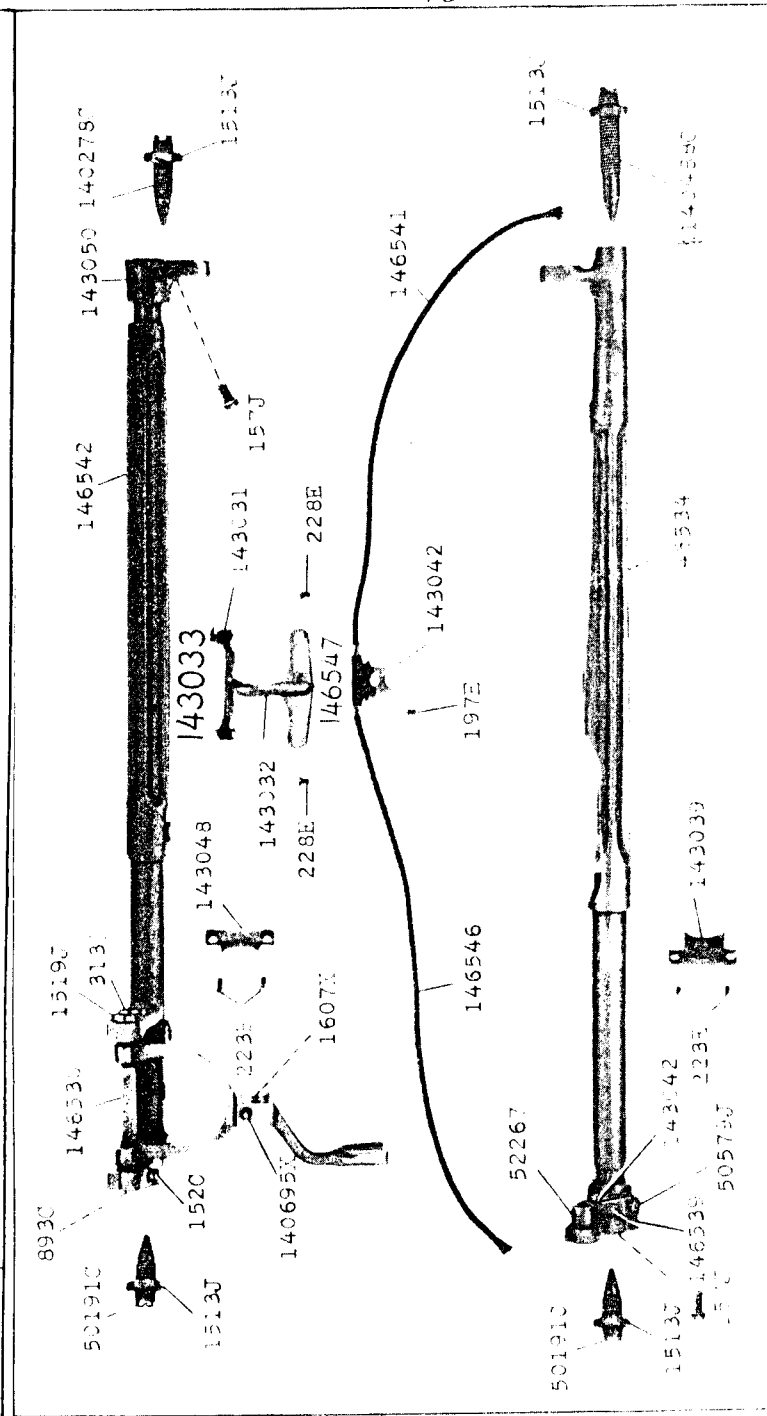
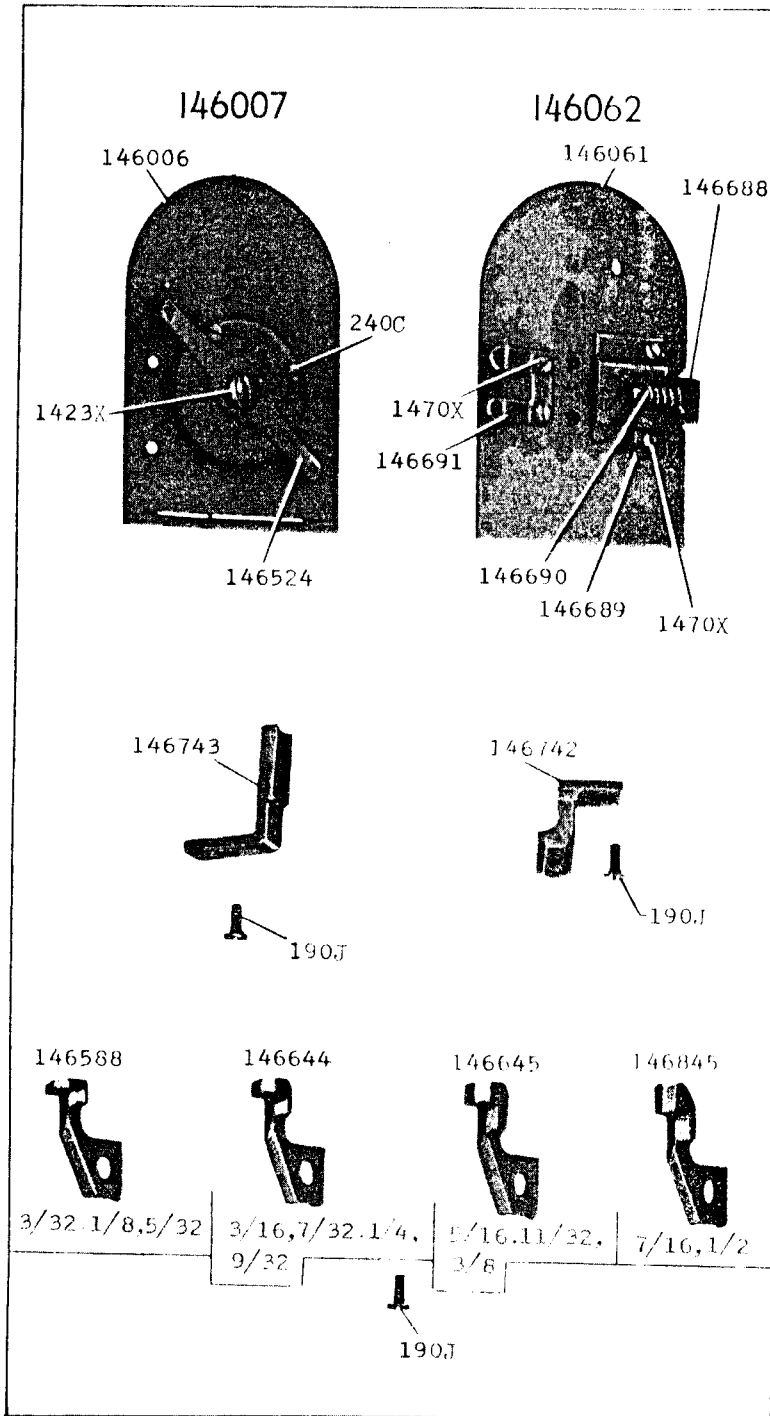

25044-1/2

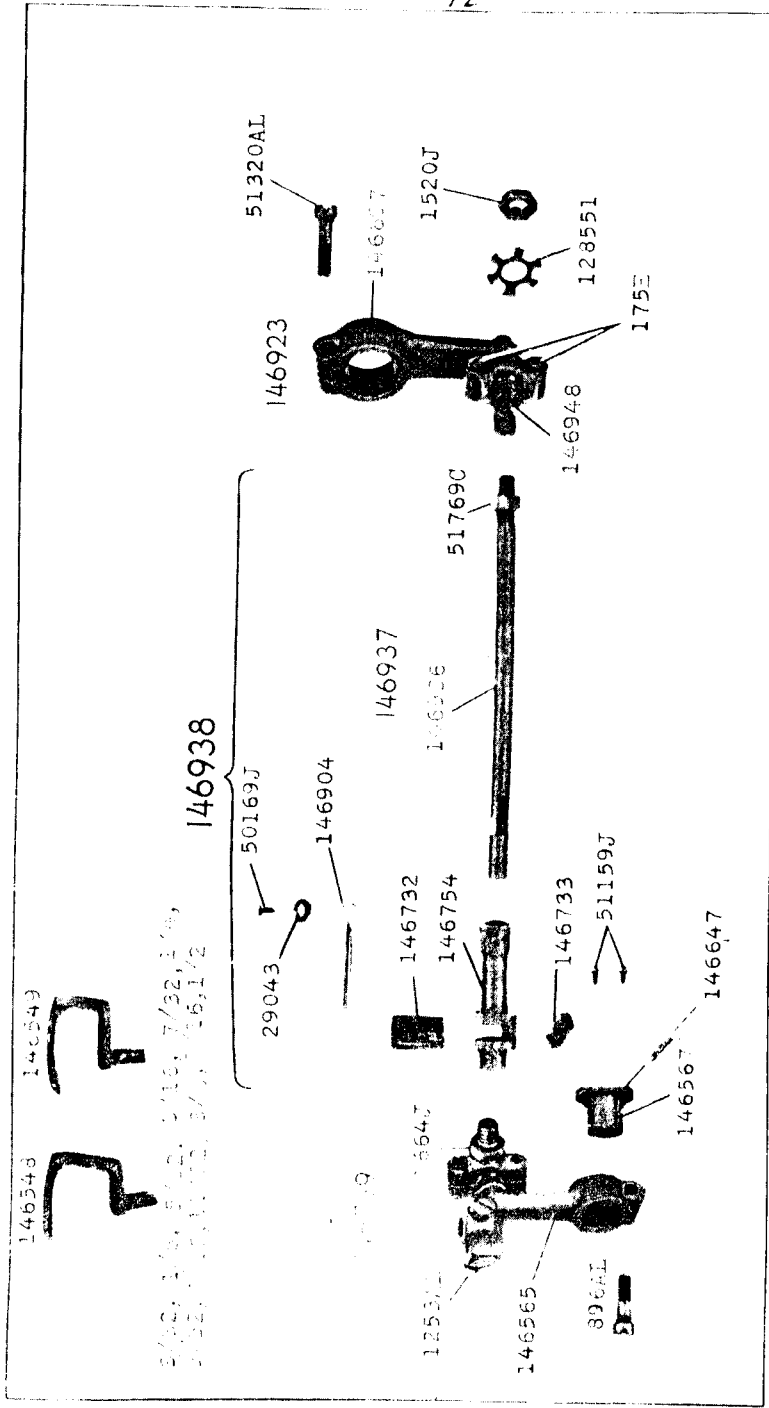

25045-1/2

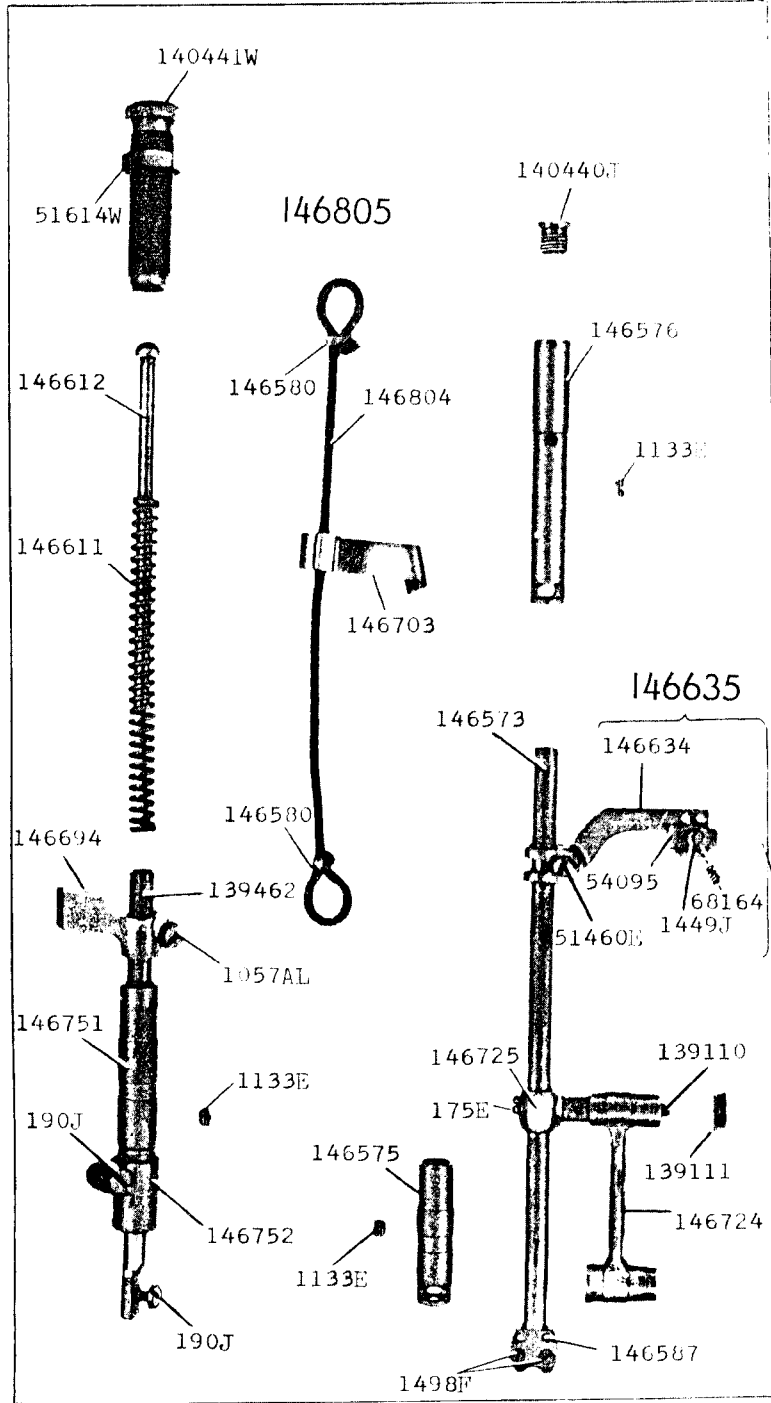

25046-1/2

146597

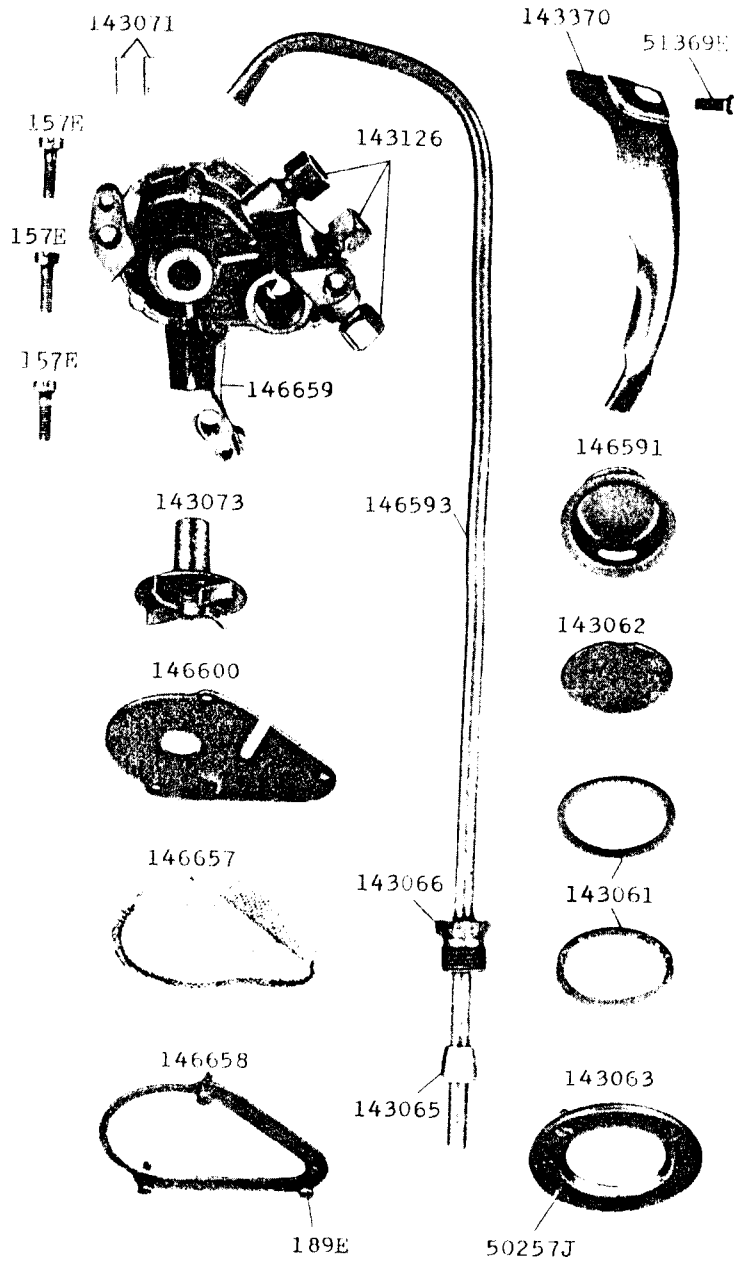

25047-2/3

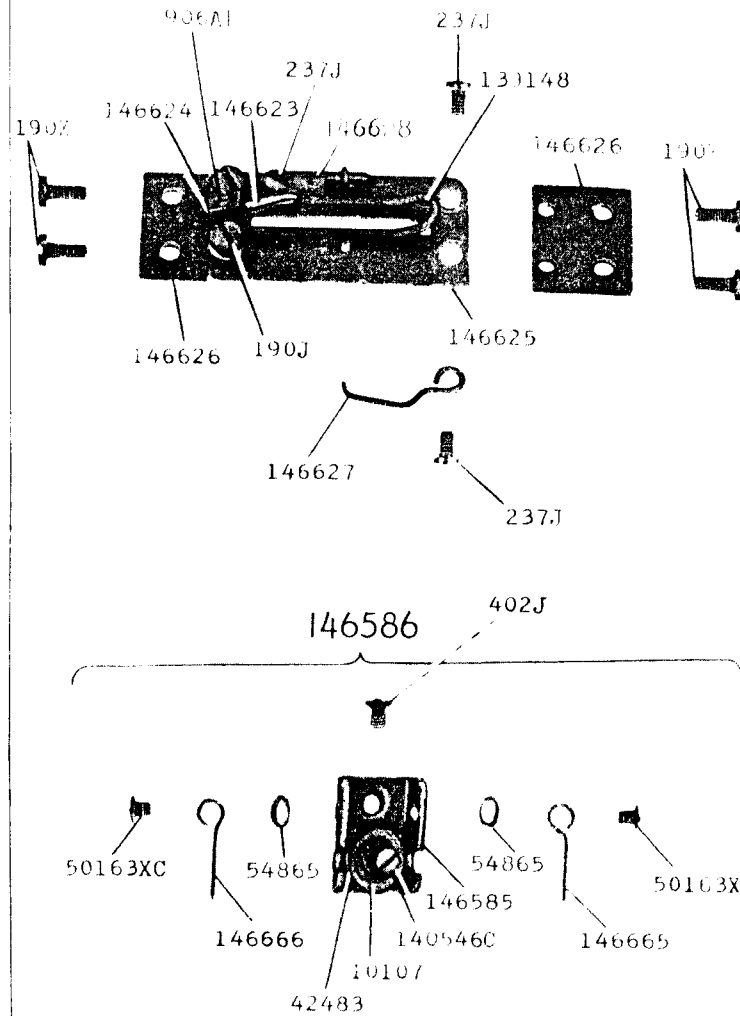

25048-1/2

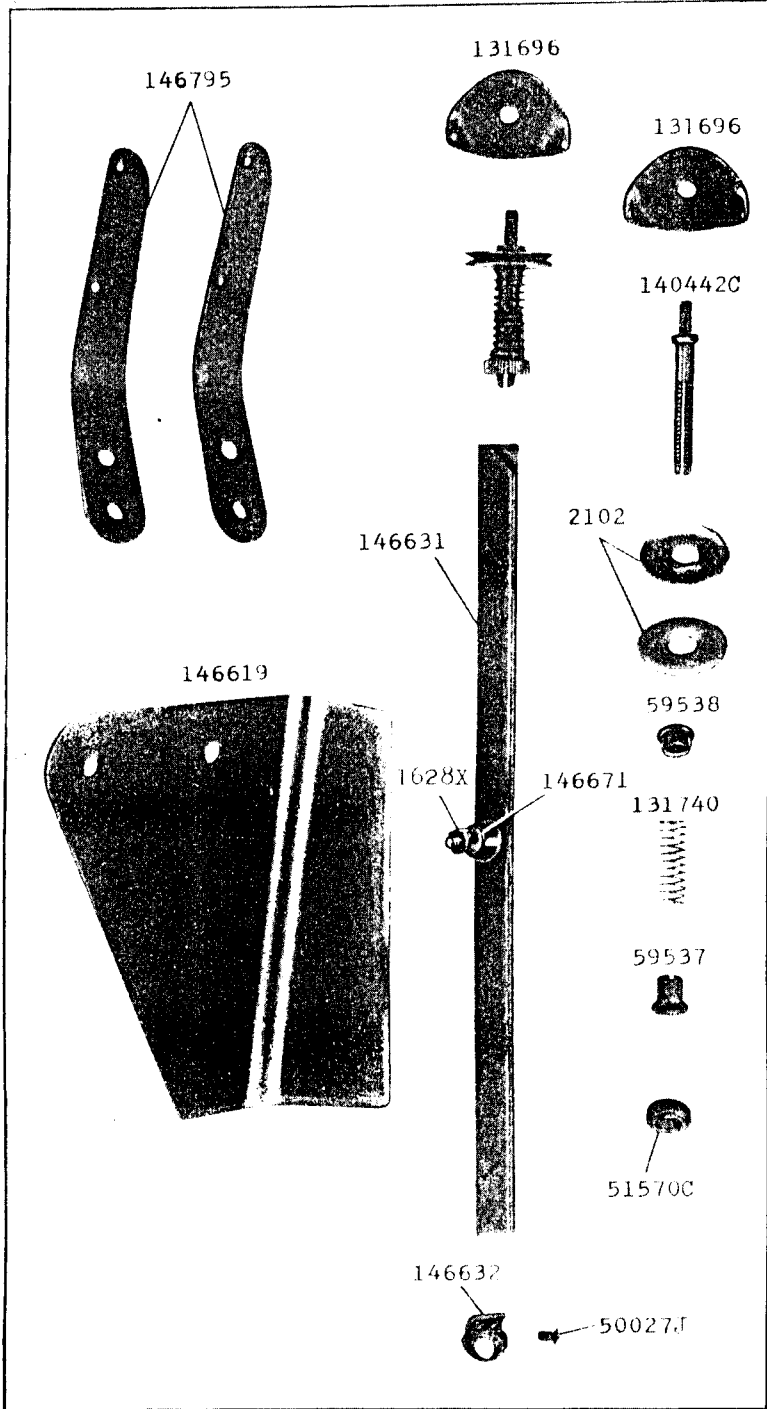

25049-1/2

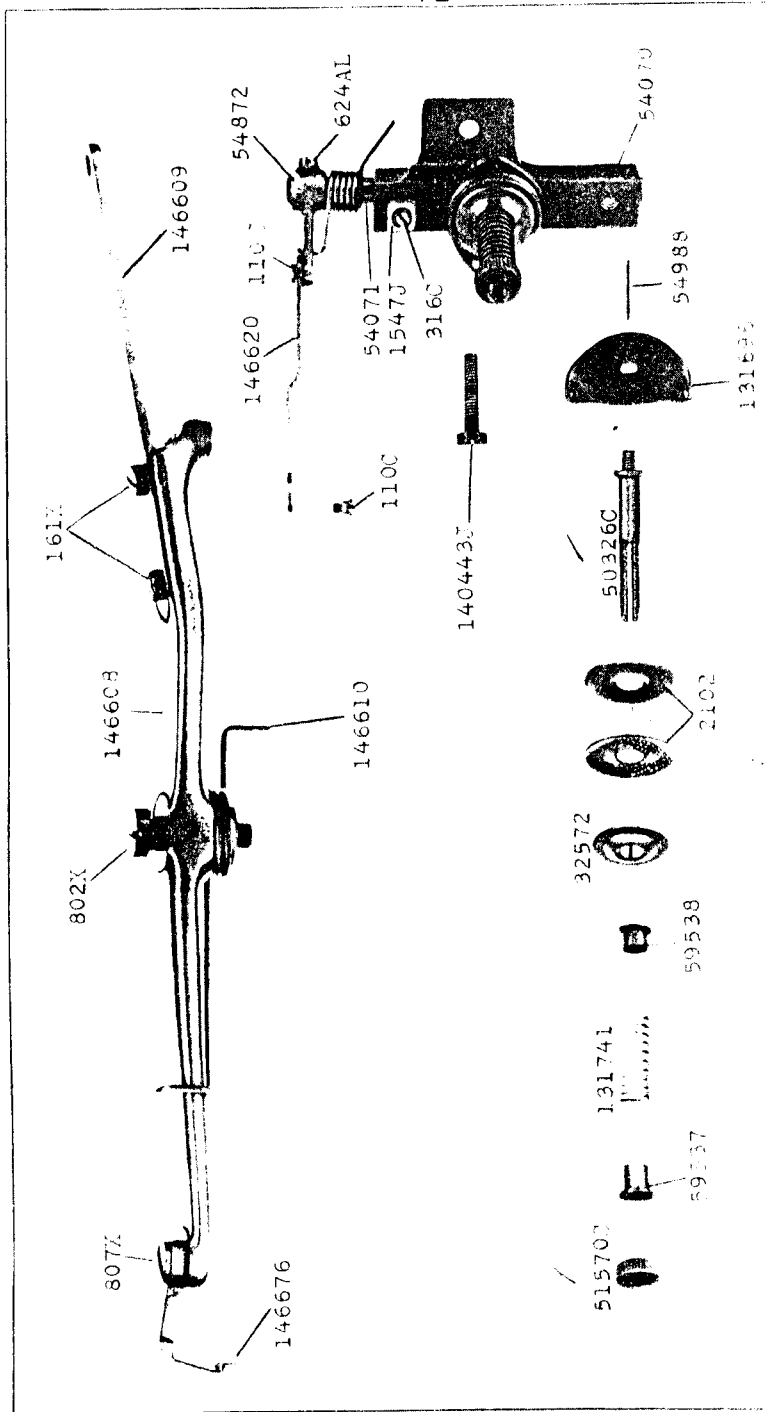

25050-1/2

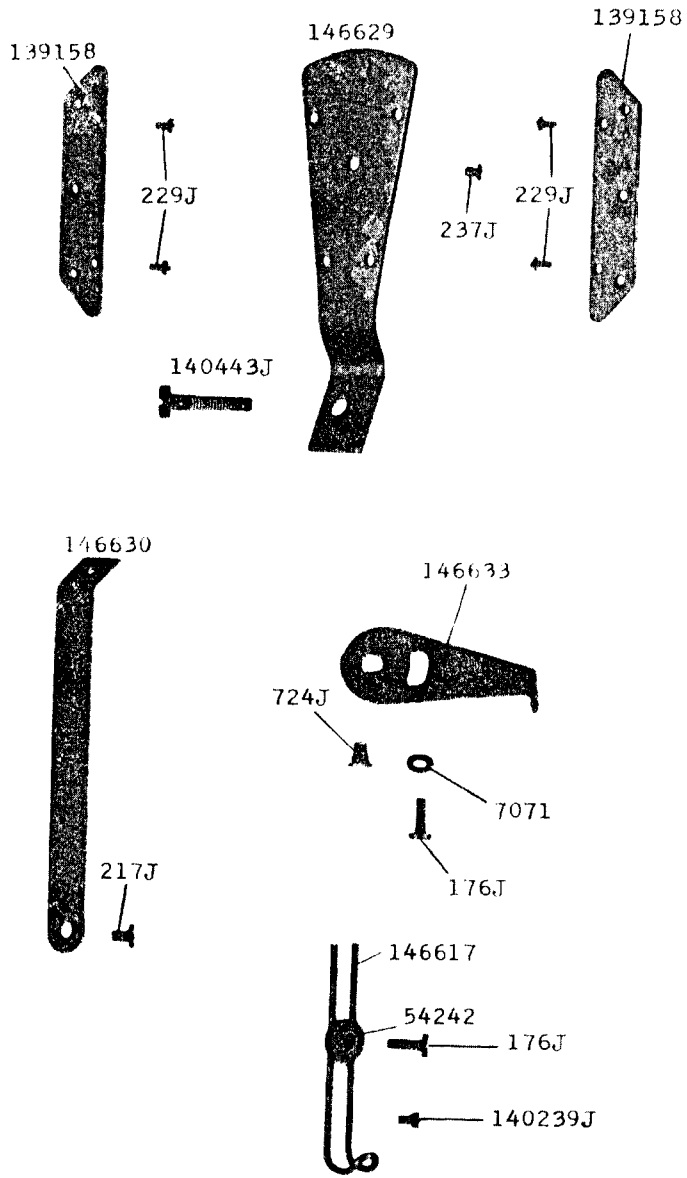

25051-1/2

146809

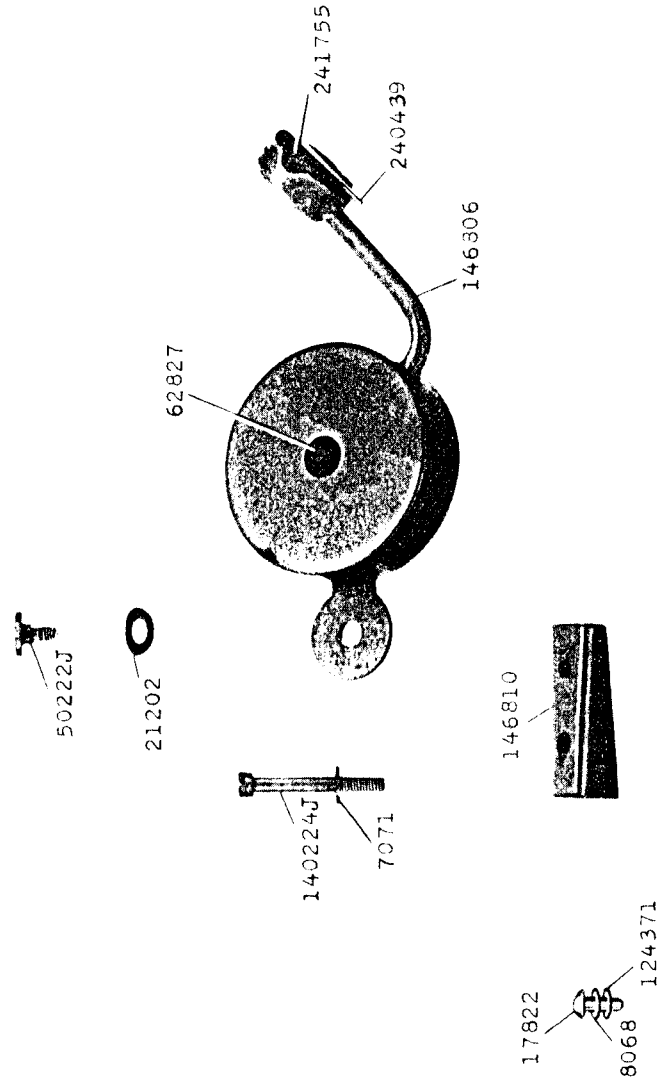

25052-1/2

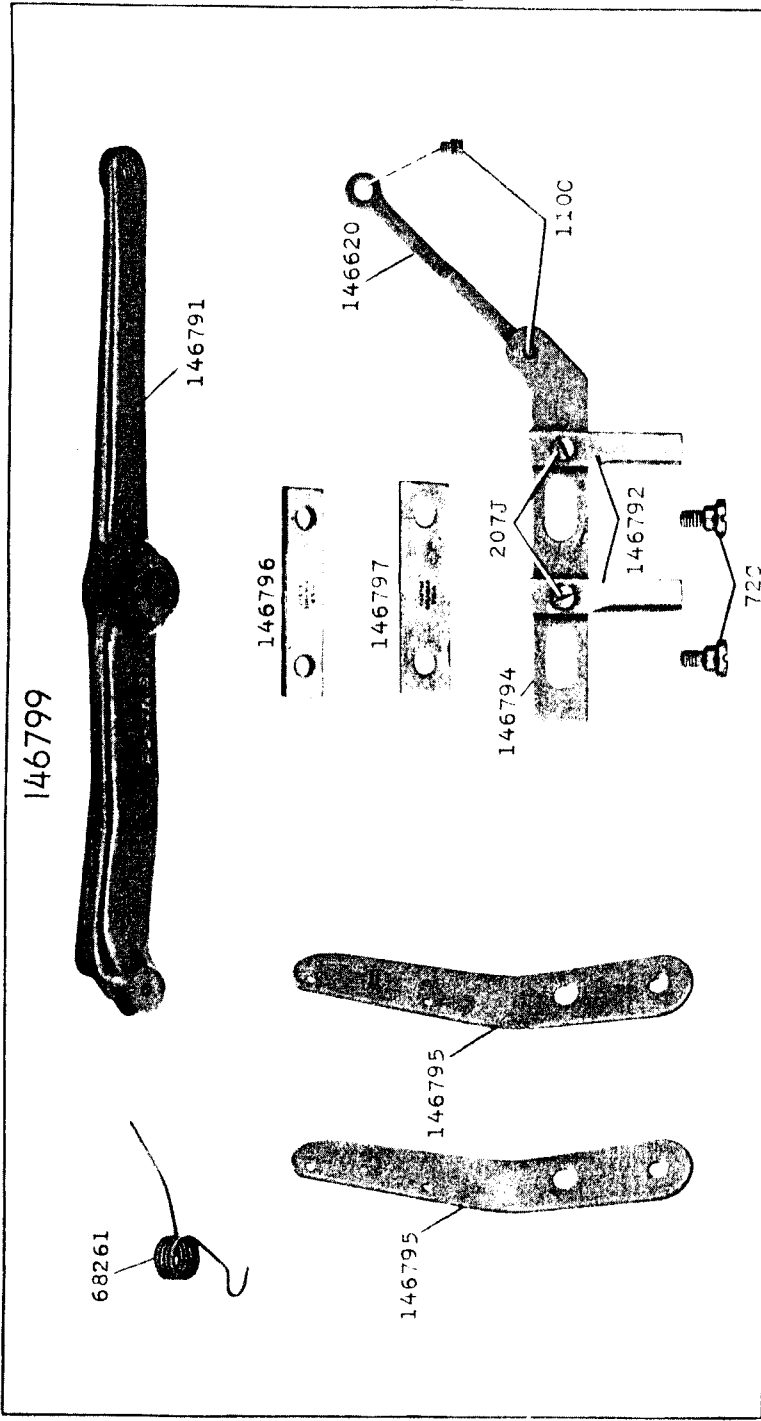

25053-1/2

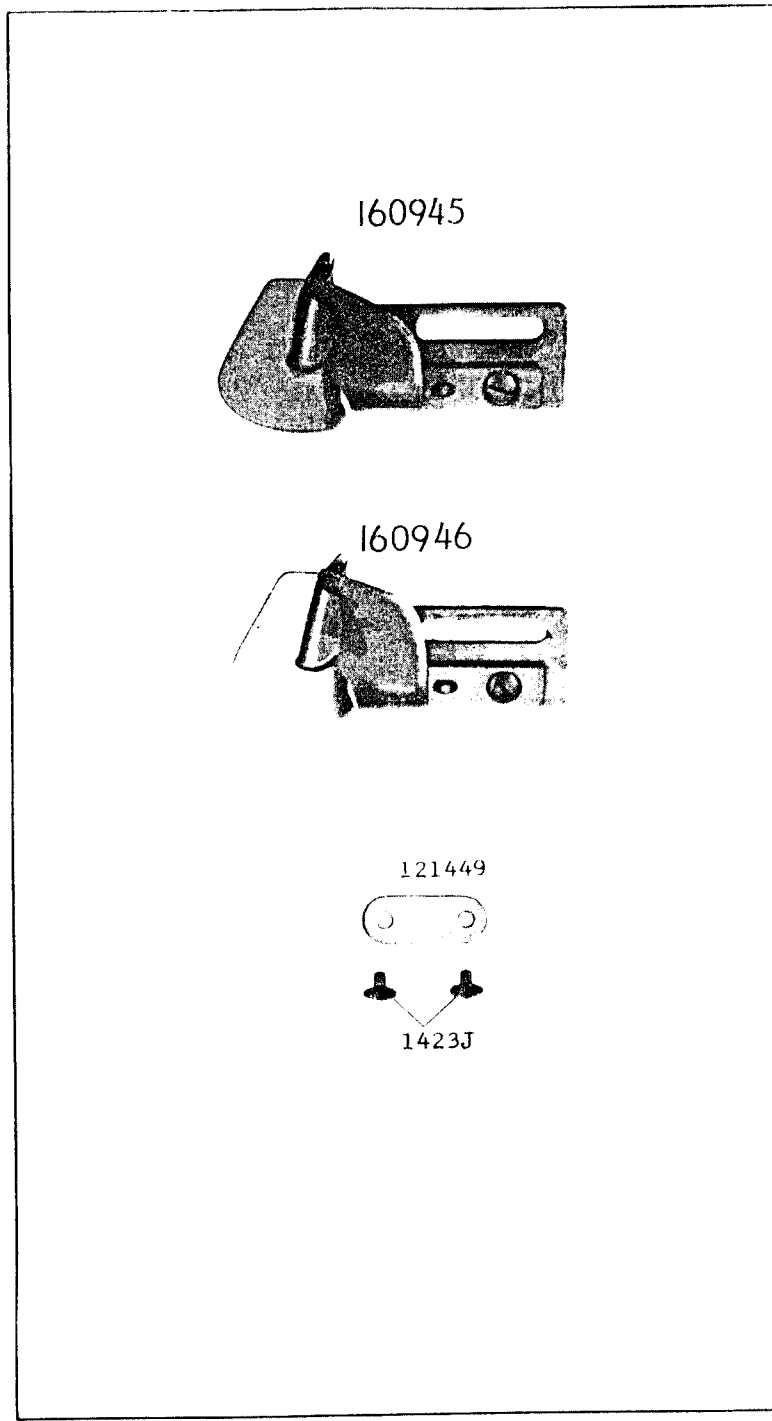

25054-1/2

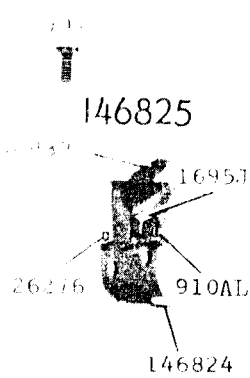
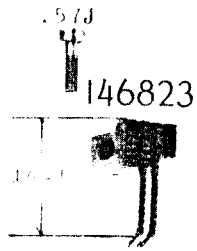

146846

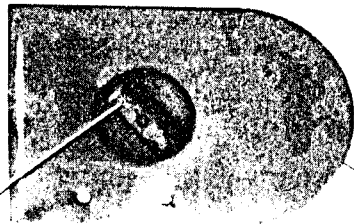

146525

161084

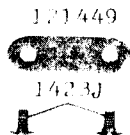
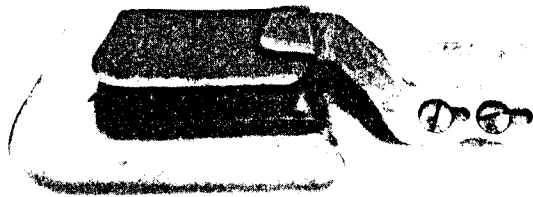

7/16, 1/2

25055-1/2

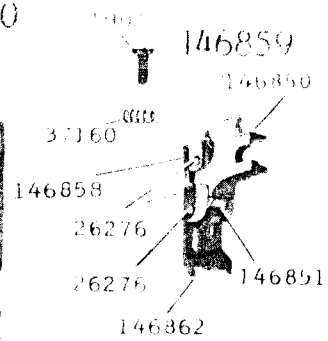
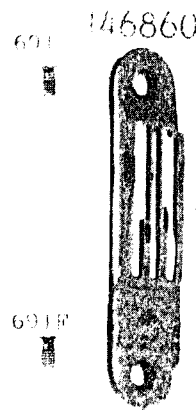
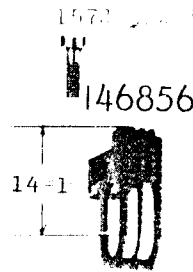

146835



146525

146834

160945

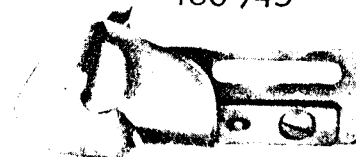

140258A1



121449



1423J

3/16, 7/32-1/4, 9/32-5/16, 11/32-3/8

25056-1/2

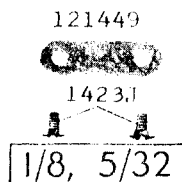
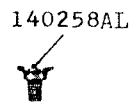
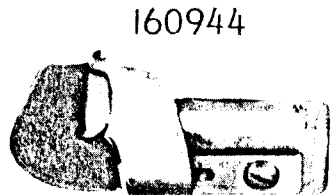
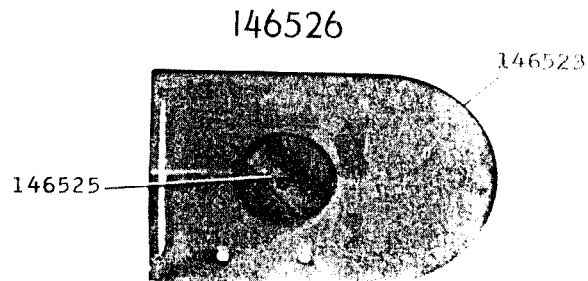
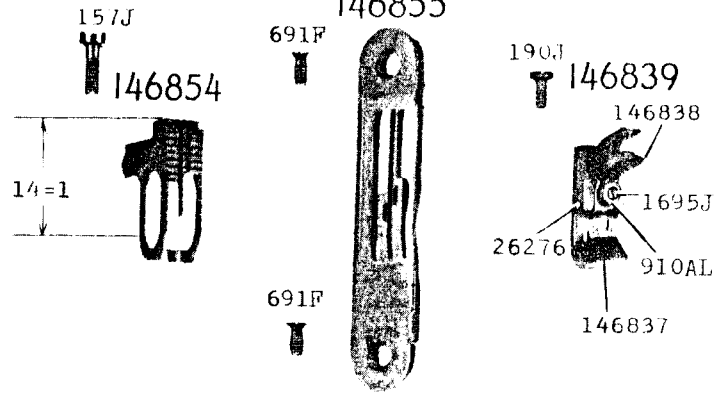

25057-1/2

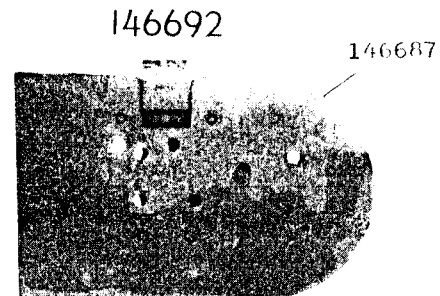
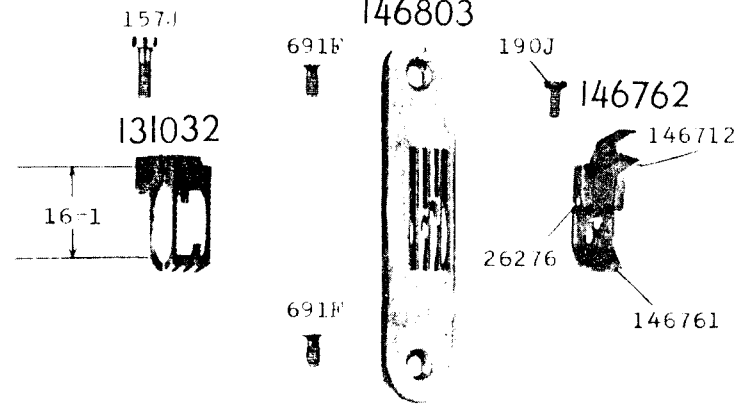

3/32, 1/8, 5/32, 3/16, 7/32, 1/4

25058-1/2

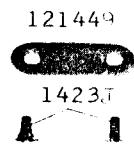
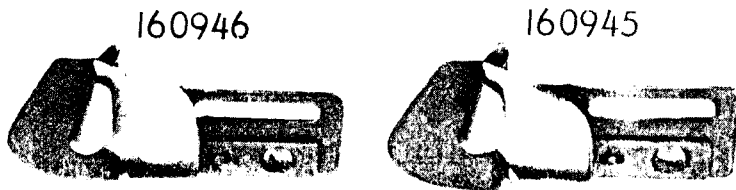
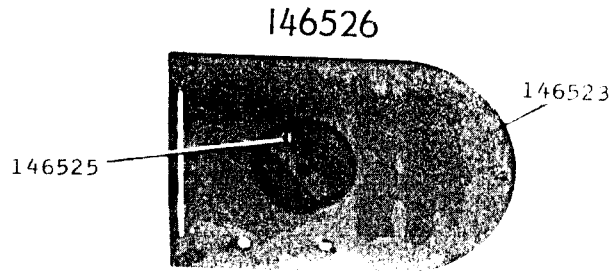
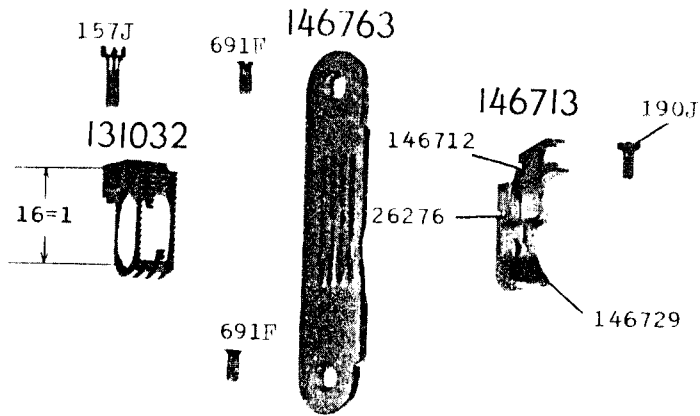

3/32, 1/8, 5/32, 3/16, 7/32, 1/4

25059-1/2

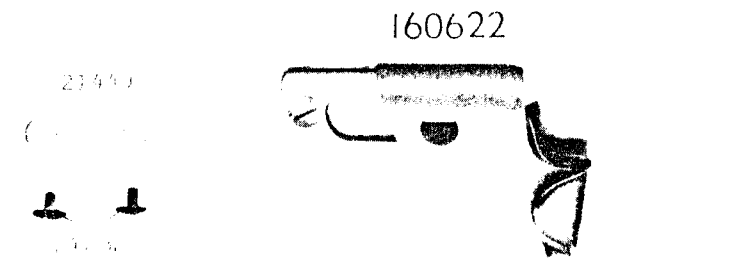
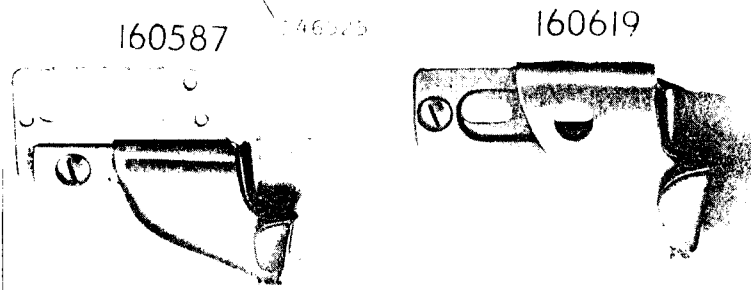
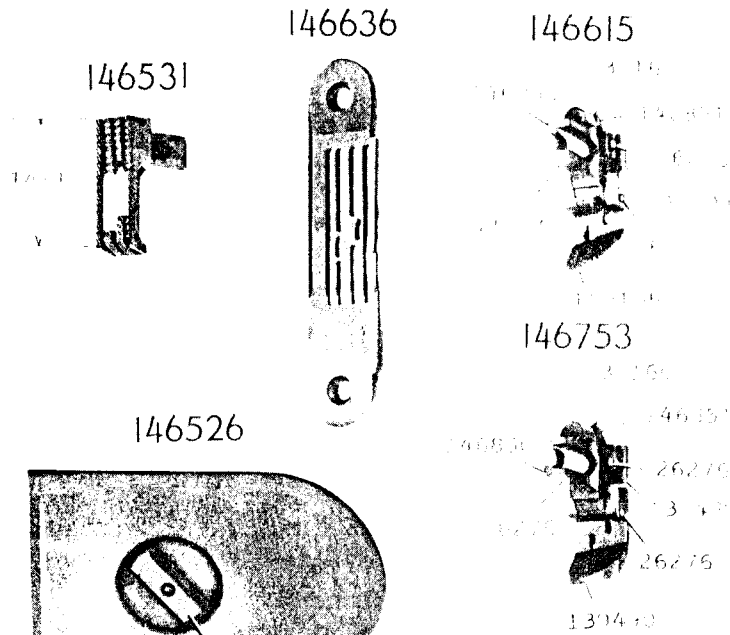

3/32, 1/8, 5/32, 3/16, 7/32, 1/4, 9/32, 5/16, 11/32, 3/8

25060-1/2

25061-1/2

146772



14=1

146773



146615

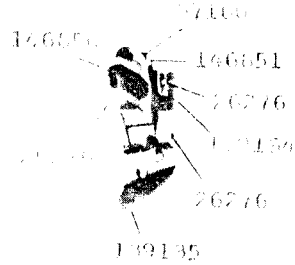

146753

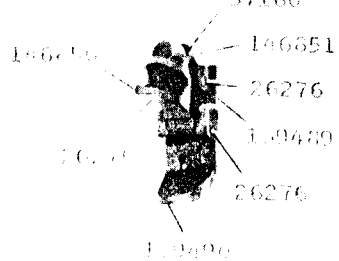

146526

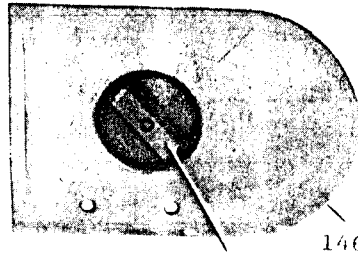

146523

160587

146525

160619

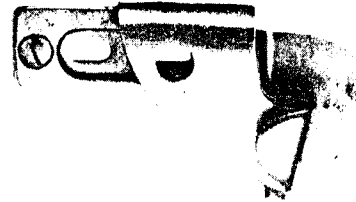
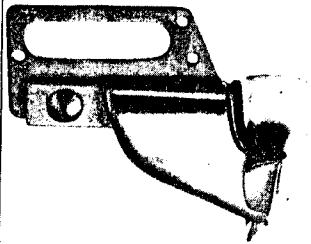

160622



121449



1423 J



146840



146839

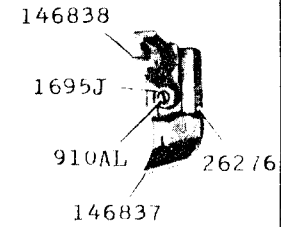

146836

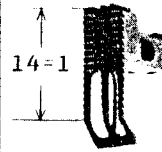

14=1

146835

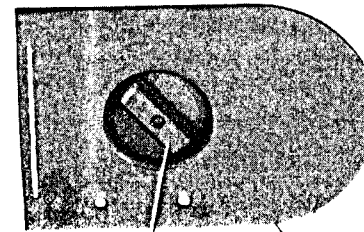

146834

146525

161091

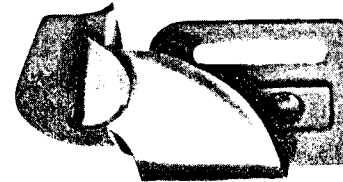

121449



1423J



1423J

3/32, 1/8, 5/32, 3/16, 7/32, 1/4, 9/32, 5/16, 11/32, 3/8

5/32, 3/16, 7/32, 1/4, 9/32, 5/16, 11/32, 3/8

25062-1/2

146836

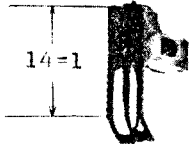

14=1

146840



146839

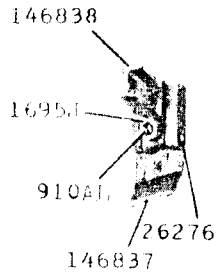

146526

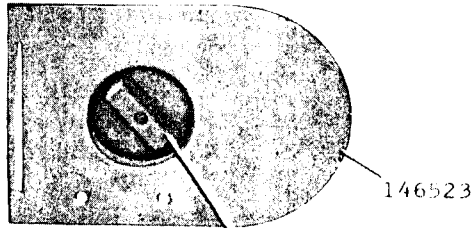

146523

160944

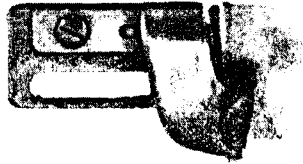

2

146525

161093



121449



14231

14231

5/32, 3/16, 7/32, 1/4, 9/32, 5/16, 11/32, 3/8

25063-1/2

146711

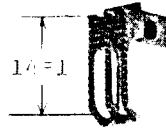

14=1

146714



146762

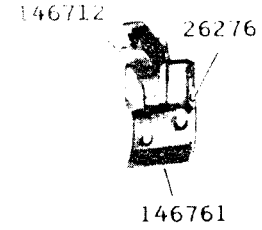

146846

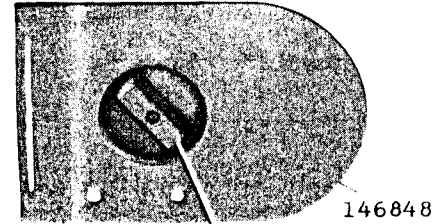

146848

146525

161092

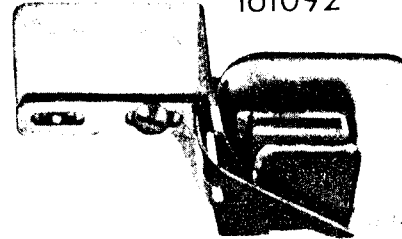

1174J

160588

1174J



5/32, 3/16

25064-1/2

25065-1/2

146844

146718

161086

146841

146715

146843

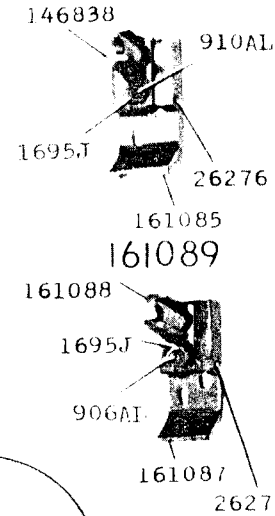
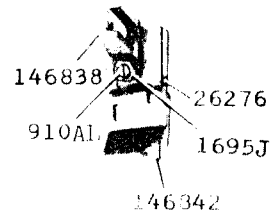
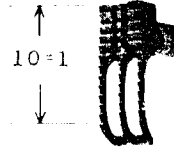
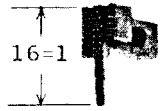

146526

146835

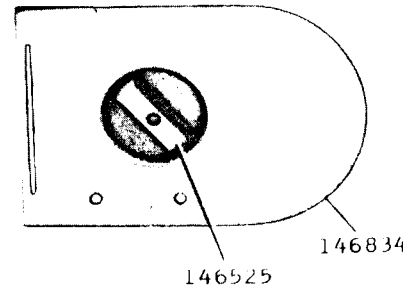
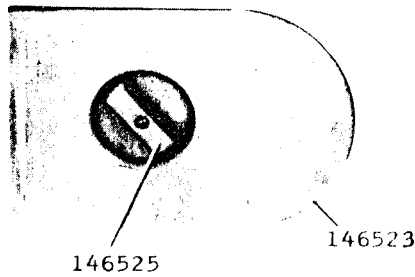

161084

161090

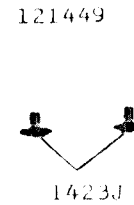
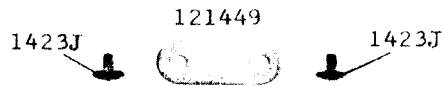
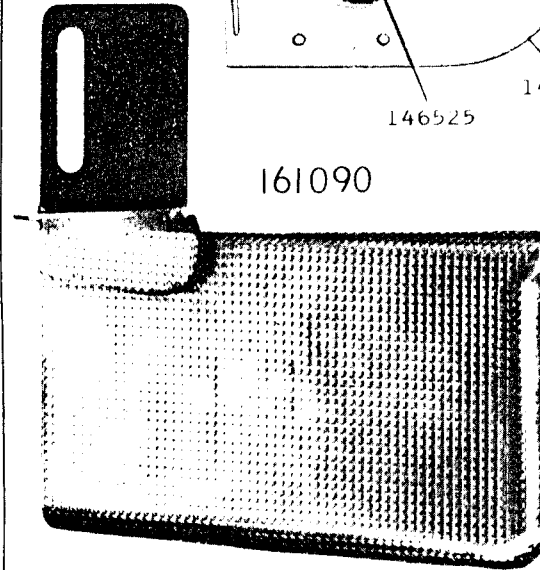
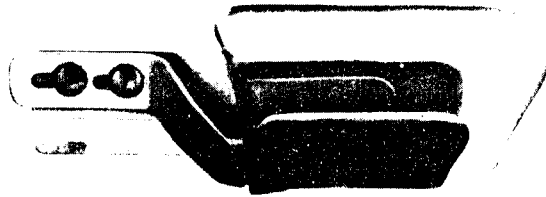

3/8, 13/32, 7/16, 15/32, 1/2

3/16, 7/32, 1/4, 9/32, 5/16, 11/32, 3/8

25066-1/2

146711

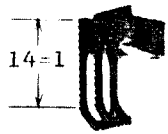

146778



146762

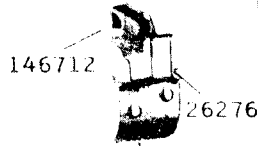

146803



146761

146802



146526

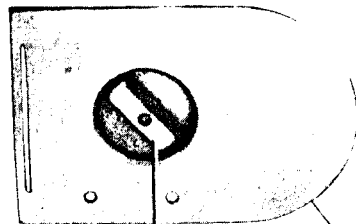

146523

3/32, 1/8, 5/32, 3/16, 7/32, 1/4, 9/32, 11/32, 3/8

25067-1/2

161100

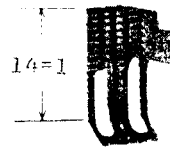

161101



161099

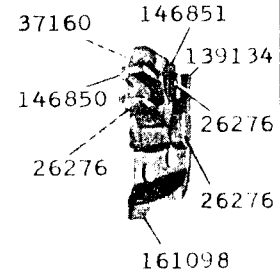

146847

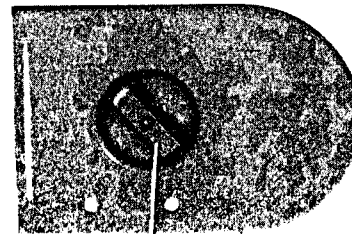

161091



121449



13/32, 7/16, 15/32, 1/2

25068-1/2

1270
1110

161100

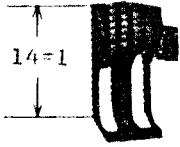

161101



161097

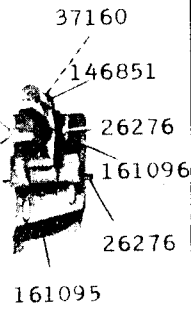

146847

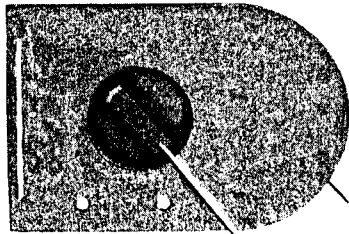

146849

161091



146525

1423J



121449



1423J



11/32, 1/2

25069-2/3

146775

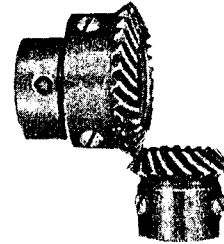

146616

