

1426

Unterklassen-Ausstattung  
Subclass parts  
Composition des sous-classes  
Composición de las subclases

Innovation made by **PFAFF**

## Erläuterungen Explanations

## Légende Explicaciones

Die Liste enthält nur Nähwerkzeuge sowie unterklassenabhängige Teile. Beim Umbau in eine andere Unterklasse bzw. Ausführung können auch noch Maschinenteile erforderlich sein. Geben Sie also bei Bestellungen die genaue Bezeichnung der vorhandenen bzw. der gewünschten Ausführung an.

The list contains only gauge parts and subclass-dependent parts. For a conversion into another subclass or version machine parts may be required as well. Please state the exact classification of the existing or required version on your order.

La liste comprend uniquement des organes de couture et des pièces dépendant des sous-classes. En cas de transformation en une autre sous-classe ou une autre version, il se peut que d'autres pièces de machine soient nécessaires. C'est pourquoi nous vous prions d'indiquer, à la commande, la désignation exacte de la version existante ou souhaitée.

La lista contiene solamente órganos de costura y piezas dependientes de la subclase. En el caso de transformación en otra subclase o en otro tipo, es posible que sean necesarias piezas de la máquina. Al hacer los pedidos, indíquese la denominación exacta del tipo existente o del deseado.

- 3/1** Gesichert mit Loctite.  
Secured with Loctite.  
Bloqué par Loctite.  
Asegurado con Loctite.
- 4** Ausführungsart bei Bestellung angeben.  
Model to be stated on order.  
Préciser le modèle à la commande.  
Indíquese el tipo en los pedidos.
- 5** Nähmuster bzw. Material einsenden.  
Submit sewing sample or material.  
Joindre échantillons de couture ou matières.  
Enviense muestras de costura.
- 10** Nadelabstand  
Needle gauge  
Ecartement des aiguilles  
Distancia entre agujas
- 10/1** Je nach Nadelabstand ändert sich die Form (z.B. beim Stoffschieber die Anzahl der Zahnreihen).  
Certain design features change according to the needle gauge (e.g. the number of tooth rows on the feed dog).  
La forme est fonction de l'écartement des aiguilles (par ex. le nombre des rangées de dents de la griffe).  
La forma varia de acuerdo con la distancia entre agujas (p.e. el número de hileras de dientes en el transportador).
- 10/2** Nadelabstand bei Bestellung angeben.  
Needle gauge to be stated on order.  
Ecartement des aiguilles; à préciser à la commande.  
Indíquese en los pedidos la distancia entre agujas.

**Unterklassen-Übersicht**  
**Table of subclasses**

**Table des sous-classes**  
**Tabla de subclasses**

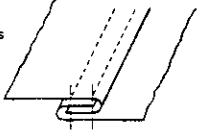
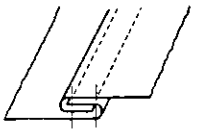
Unterklasse Subclass Sous-classe Subclase	-6/01 (-900/..)	-6/07 (-900/..)	-57/01 (-900/..)	-58/01 (-900/..)
Arbeitsgang Operation Opération Operación	Für allgemeine Näharbeiten. Standardform des Teilesatzes. For ordinary sewing operations. Standard parts set. Travaux d'utilité courante. Jeu de pièces standard. Para trabajos de costura en general. Juego de piezas estándar.	Für Nähte mit Übergängen (Klettteilersatz). For seams involving cross seams (climbing parts set). Couture de matières à surépais- seurs (pied grim pant). Para costuras con desniveles (juego de piezas trepador).		
Ausführung Model Version Tipo de máquina	BN: CN	BN: CN	BN: CN	BN: CN
Nadelabstand in mm Needle gauge in mm Ecartement des aiguilles en mm Distancia entre agujas en mm	2,4 - 34,0	2,4 - 24,0	4,8 - 20,0	4,8 - 20,0
Nadelhalter $\frac{10}{2}$ Needle holder Pince-aiguille Portaagujas	91-176 068-93 $\frac{10}{1}$ = 2,4 - 4,4 mm 91-172 590-93 $\frac{10}{1}$ = 4,8 - 7,6 mm 91-172 840-93 $\frac{10}{1}$ = 8,0 - 34,0 mm	91-176 068-93 $\frac{10}{1}$ = 2,4 - 4,4 mm 91-172 590-93 $\frac{10}{1}$ = 4,8 - 7,6 mm 91-172 840-93 $\frac{10}{1}$ = 8,0 - 24,0 mm	91-172 590-93 $\frac{10}{1}$ = 4,8 - 7,6 mm 91-172 840-93 $\frac{10}{1}$ = 8,0 - 20,0 mm	91-172 590-93 $\frac{10}{1}$ = 4,8 - 7,6 mm 91-172 840-93 $\frac{10}{1}$ = 8,0 - 20,0 mm
Stoffschieber $\frac{4}{1}$ $\frac{10}{1}$ $\frac{10}{2}$ Feed dog Griffe Transportador inferior	91-059 647-04	91-059 647-04	91-059 647-04	91-059 647-04
Stichplatte $\frac{4}{1}$ $\frac{10}{1}$ $\frac{10}{2}$ Needle plate Plaque à aiguille Placa de aguja	91-150 155-04	91-150 155-04	91-150 155-04	91-150 155-04
Stoffdrückerfuß $\frac{4}{1}$ $\frac{10}{2}$ Presser foot Pied presseur Pie prensatelas	91-049 801-93	91-049 772-93	91-049 801-93	91-049 801-93
Stoffschiebefuß $\frac{4}{1}$ $\frac{10}{2}$ Vibrating presser Pied entraîneur Transportador superior	91-049 385-93	91-049 385-93	91-049 385-93	91-049 385-93
Apparat $\frac{3}{1}$ $\frac{10}{2}$ Attachment Appareil Aparato			91-040 317-93 $\frac{10}{1}$ = 4,8 - 10,0 mm 91-042 068-24 $\frac{10}{1}$ = 11,2 - 20,0 mm	91-040 316-93 $\frac{10}{1}$ = 4,8 - 10,0 mm 91-040 814-24 $\frac{10}{1}$ = 11,2 - 20,0 mm
Fingerschutz $\frac{10}{2}$ Finger guard Protège-doigts Salvadedos	91-155 422-91 $\frac{10}{1}$ = 2,4 - 4,4 mm 91-057 707-91 $\frac{10}{1}$ = 4,8 - 15,2 mm 91-057 710-91 $\frac{10}{1}$ = 16,0 - 30,0 mm 91-057 712-91 $\frac{10}{1}$ = 32,0 - 34,0 mm	91-155 422-91 $\frac{10}{1}$ = 2,4 - 4,4 mm 91-057 707-91 $\frac{10}{1}$ = 4,8 - 15,2 mm 91-057 710-91 $\frac{10}{1}$ = 16,0 - 24,0 mm	91-057 707-91 $\frac{10}{1}$ = 4,8 - 15,2 mm 91-057 710-91 $\frac{10}{1}$ = 16,0 - 20,0 mm	91-057 707-91 $\frac{10}{1}$ = 4,8 - 15,2 mm 91-057 710-91 $\frac{10}{1}$ = 16,0 - 20,0 mm

**Unterklassen-Übersicht**  
**Table of subclasses**

**Table des sous-classes**  
**Tabla de subclasses**

Unterklasse Subclass Sous-classe Subclase	-68/97 (-900/..)	-68/99 (-900/..)	-147/02 (-900/..)
Arbeitsgang Operation Opération Operación			
Ausführung Model Version Tipo de máquina	BN, CN	BN, CN	BN, CN
Nadelabstand in mm Needle gauge in mm Ecartement des aiguilles en mm Distancia entre agujas en mm	16,0 - 24,0	16,0 - 24,0	4,0 - 20,0
Nadelhalter <u>10/2</u> Needle holder Pince-aiguille Portaagujas	91-172 840-93	91-172 840-93	91-176 068-93 <u>10</u> = 4,0 - 4,4 mm 91-172 590-93 <u>10</u> = 4,8 - 7,6 mm 91-172 840-93 <u>10</u> = 8,0 - 20,0 mm
Stoffschieber <u>4</u> <u>10/1</u> <u>10/2</u> Feed dog Griffe Transportador inferior	91-059 647-04	91-059 647-04	91-059 647-04
Stichplatte <u>4</u> <u>10/1</u> <u>10/2</u> Needle plate Plaque à aiguille Placa de aguja	91-150 155-04	91-150 155-04	91-150 155-04
Stoffdrückertuß <u>4</u> <u>10/2</u> Presser foot Pied presseur Pie prensatelas	91-049 829-93	91-049 829-93	91-049 801-93
Stoffschiebelfuß <u>3</u> <u>10/2</u> Vibrating presser Pied entraîneur Transportador superior	91-049 436-93	91-049 436-93	91-049 385-93
Apparat <u>5</u> <u>10/2</u> Attachment Appareil Aparato	99-117 944-23	99-116 630-23	91-053 679-25
Träger Bracket Support Soporte			91-753 936-90
Fingerschutz <u>10/2</u> Finger guard Protège-doigts Salvadedos			91-155 429-91 <u>10</u> = 4,0 - 6,4 mm 91-057 707-91 <u>10</u> = 6,8 - 15,2 mm 91-057 710-91 <u>10</u> = 16,0 - 20,0 mm

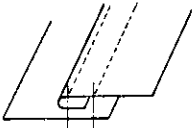
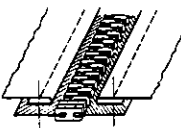
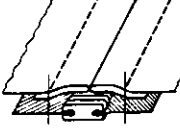
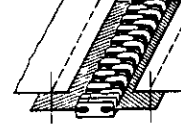

**Unterklassen-Übersicht**  
**Table of subclasses**

**Table des sous-classes**  
**Tabla de subclasses**

Unterklasse Subclass Sous-classe Subclase	-148/02 (-900/..)	-230/01 (-900/..)	-230/21 (-900/..)	-237/01 (-900/..)
Arbeitsgang Operation Operation Operacion				
Ausführung Model Version Tipo de máquina	BN: CN	BN: CN	BN: CN	BN: CN
Nadelabstand in mm Needle gauge in mm Ecartement des aiguilles en mm Distancia entre agujas en mm	4,0 - 20,0	8,0 - 20,0	8,0 - 20,0	8,0 - 20,0
Nadelhalter <u>10/2</u> Needle holder Pince-aiguille Portaagujas	91-176 068-93 <u>10</u> = 4,0 - 4,4 mm 91-172 590-93 <u>10</u> = 4,8 - 7,6 mm 91-172 840-93 <u>10</u> = 8,0 - 20,0 mm	91-172 840-93	91-172 840-93	91-172 840-93
Stoffschieber <u>4</u> <u>10/1</u> <u>10/2</u> Feed dog Griffe Transportador inferior	91-059 647-04	91-059 304-04	91-059 304-04	91-059 304-04
Stichplatte <u>4</u> <u>10/1</u> <u>10/2</u> Needle plate Plaque à aiguille Placa de aguja	91-150 155-04	91-150 187-04	91-150 187-04	91-150 187-04
Stoffdrückfuß <u>4</u> <u>10/2</u> Presser foot Pied presseur Pie prensateelas	91-049 801-93	91-049 775-93	91-049 775-93	91-049 775-93
Stoffschiebefuß <u>4</u> <u>10/2</u> Vibrating presser Pied entraîneur Transportador superior	91-049 385-93	91-049 387-93	91-049 387-93	91-049 387-93
Apparat <u>5</u> <u>10/2</u> Attachment Appareil Aparato	91-042 589-23	91-156 264-73	91-156 268-73	91-156 277-71/995
Träger Bracket Support Soporte	91-753 936-90			
Fingerschutz <u>10/2</u> Finger guard Protège-doigts Salvadedos	91-155 429-91 <u>10</u> = 4,0 - 6,4 mm 91-057 707-91 <u>10</u> = 6,8 - 15,2 mm 91-057 710-91 <u>10</u> = 16,0 - 20,0 mm			

**Nähwerkzeuge**  
**Gauge parts**

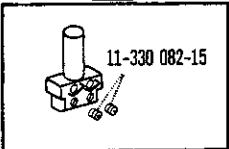
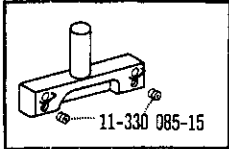
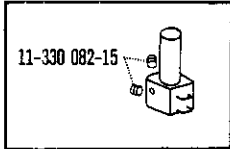
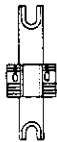
**Organes de couture**  
**Organos de costura**

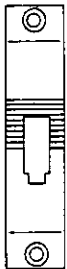
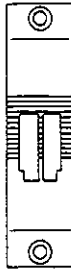
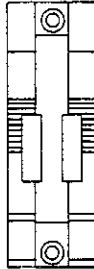
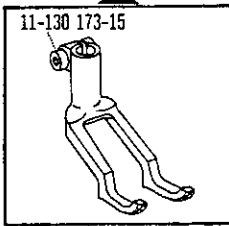
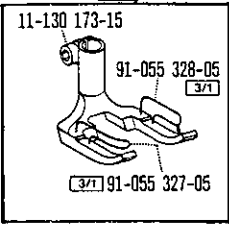
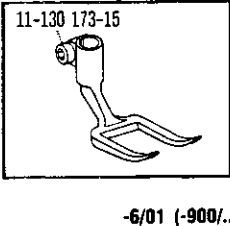
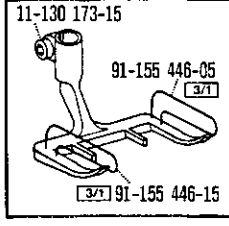
<p>91-172 590-93 <span style="border: 1px solid black; padding: 0 2px;">10/2</span></p>  <p>11-330 082-15</p> <p><span style="border: 1px solid black; padding: 0 2px;">10</span> = 4,8 - 7,6 mm</p> <p>-6/01 (-900/..) -6/07 (-900/..) -57/01 (-900/..) -58/01 (-900/..) -147/02 (-900/..) -148/02 (-900/..)</p>	<p>91-172 840-93 <span style="border: 1px solid black; padding: 0 2px;">10/2</span></p>  <p>11-330 085-15</p> <p><span style="border: 1px solid black; padding: 0 2px;">10</span> = 8,0 - 34,0 mm</p> <p>-68/99 (-900/..) -6/01 (-900/..) -6/07 (-900/..) -57/01 (-900/..) -58/01 (-900/..) -68/97 (-900/..) -147/02 (-900/..) -148/02 (-900/..) -230/01 (-900/..) -230/21 (-900/..) -237/01 (-900/..)</p>	<p>91-176 068-93 <span style="border: 1px solid black; padding: 0 2px;">10/2</span></p>  <p>11-330 082-15</p> <p><span style="border: 1px solid black; padding: 0 2px;">10</span> = 2,4 - 4,4 mm</p> <p>-6/01 (-900/..) -6/07 (-900/..) -147/02 (-900/..) -148/02 (-900/..)</p>	
<p>91-059 304-04 <span style="border: 1px solid black; padding: 0 2px;">4</span> <span style="border: 1px solid black; padding: 0 2px;">10/2</span></p>  <p>-230/01 (-900/..) -230/21 (-900/..) -237/01 (-900/..)</p>	<p>91-059 647-04 <span style="border: 1px solid black; padding: 0 2px;">4</span> <span style="border: 1px solid black; padding: 0 2px;">10/2</span></p>  <p><span style="border: 1px solid black; padding: 0 2px;">10</span> = 2,4 - 4,0 mm</p> <p>-6/01 (-900/..) -6/07 (-900/..) -147/02 (-900/..) -148/02 (-900/..)</p>	<p>91-059 647-04 <span style="border: 1px solid black; padding: 0 2px;">4</span> <span style="border: 1px solid black; padding: 0 2px;">10/1</span> <span style="border: 1px solid black; padding: 0 2px;">10/2</span></p>  <p><span style="border: 1px solid black; padding: 0 2px;">10</span> = 4,8 - 34,0 mm</p> <p>-6/01 (-900/..) -6/07 (-900/..) -57/01 (-900/..) -58/01 (-900/..) -68/97 (-900/..) -68/99 (-900/..) -147/02 (-900/..) -148/02 (-900/..)</p>	
<p>91-150 155-04 <span style="border: 1px solid black; padding: 0 2px;">4</span> <span style="border: 1px solid black; padding: 0 2px;">10/2</span></p>  <p><span style="border: 1px solid black; padding: 0 2px;">10</span> = 2,4 - 4,0 mm</p> <p>-6/01 (-900/..) -6/07 (-900/..) -147/02 (-900/..) -148/02 (-900/..)</p>	<p>91-150 155-04 <span style="border: 1px solid black; padding: 0 2px;">4</span> <span style="border: 1px solid black; padding: 0 2px;">10/1</span> <span style="border: 1px solid black; padding: 0 2px;">10/2</span></p>  <p><span style="border: 1px solid black; padding: 0 2px;">10</span> = 4,8 - 34,0 mm</p> <p>-6/01 (-900/..) -6/07 (-900/..) -57/01 (-900/..) -58/01 (-900/..) -68/97 (-900/..) -68/99 (-900/..) -147/02 (-900/..) -148/02 (-900/..)</p>	<p>91-150 187-04 <span style="border: 1px solid black; padding: 0 2px;">4</span> <span style="border: 1px solid black; padding: 0 2px;">10/2</span></p>  <p>-230/01 (-900/..) -230/21 (-900/..) -237/01 (-900/..)</p>	
<p>91-049 772-93 <span style="border: 1px solid black; padding: 0 2px;">4</span> <span style="border: 1px solid black; padding: 0 2px;">10/2</span></p>  <p>11-130 173-15</p> <p>-6/07 (-900/..)</p>	<p>91-049 775-93 <span style="border: 1px solid black; padding: 0 2px;">4</span> <span style="border: 1px solid black; padding: 0 2px;">10/2</span></p>  <p>11-130 173-15</p> <p>91-055 328-05 <span style="border: 1px solid black; padding: 0 2px;">3/1</span></p> <p><span style="border: 1px solid black; padding: 0 2px;">3/1</span> 91-055 327-05</p> <p>-230/01 (-900/..) -230/21 (-900/..) -237/01 (-900/..)</p>	<p>91-049 801-93 <span style="border: 1px solid black; padding: 0 2px;">4</span> <span style="border: 1px solid black; padding: 0 2px;">10/2</span></p>  <p>11-130 173-15</p> <p>-6/01 (-900/..) -57/01 (-900/..) -58/01 (-900/..) -147/02 (-900/..) -148/02 (-900/..)</p>	<p>91-049 829-93 <span style="border: 1px solid black; padding: 0 2px;">4</span> <span style="border: 1px solid black; padding: 0 2px;">10/2</span></p>  <p>11-130 173-15</p> <p>91-155 446-05 <span style="border: 1px solid black; padding: 0 2px;">3/1</span></p> <p><span style="border: 1px solid black; padding: 0 2px;">3/1</span> 91-155 446-15</p> <p>-68/97 (-900/..) -68/99 (-900/..)</p>

Nähwerkzeuge  
Gauge parts

Organes de couture  
Organos de costura

91-049 385-93 [4] [10/2]

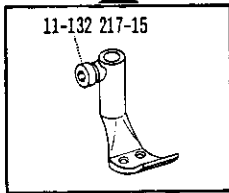

11-132 217-15  
-6/01 (-900/..)  
-6/07 (-900/..)  
-57/01 (-900/..)  
-58/01 (-900/..)  
-147/02 (-900/..)  
-148/02 (-900/..)

91-049 387-93 [4] [10/2]

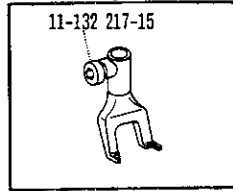

11-132 217-15  
-230/01 (-900/..)  
-230/21 (-900/..)  
-237/01 (-900/..)

91-049 436-93 [4] [10/2]

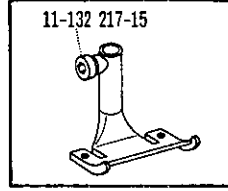

11-132 217-15  
-68/97 (-900/..)  
-68/99 (-900/..)

91-700 799-15 [5] [10/2]

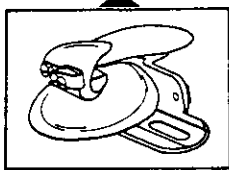

91-040 316-93 [5] [10/2]

[10] = 4,8 - 10,0 mm

-58/01 (-900/..)

91-700 799-15 [5] [10/2]

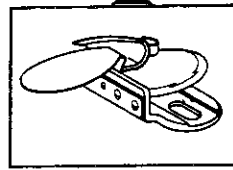

91-040 317-93 [5] [10/2]

[10] = 4,8 - 10,0 mm

-57/01 (-900/..)

91-700 799-15 [5] [10/2]

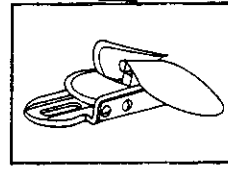

91-040 814-24 [5] [10/2]

[10] = 11,2 - 20,0 mm

-58/01 (-900/..)

91-700 799-15 [5] [10/2]

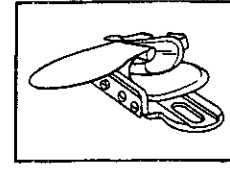

91-042 066-24 [5] [10/2]

[10] = 11,2 - 20,0 mm

-57/01 (-900/..)

91-042 589-23 [5] [10/2]

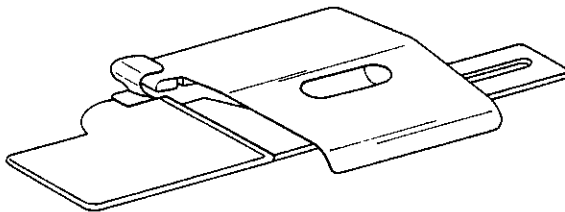

-148/02 (-900/..)

91-053 679-25 [5] [10/2]

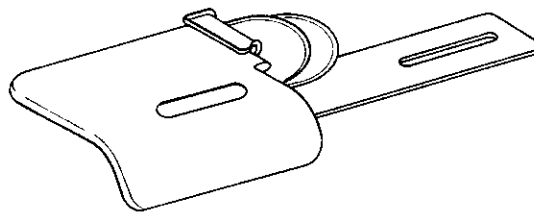

-147/02 (-900/..)

91-156 264-73 [5] [10/2]

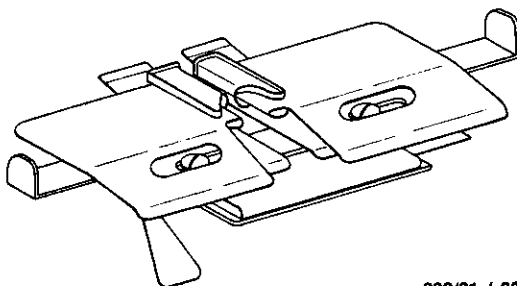

-230/01 (-900/..)

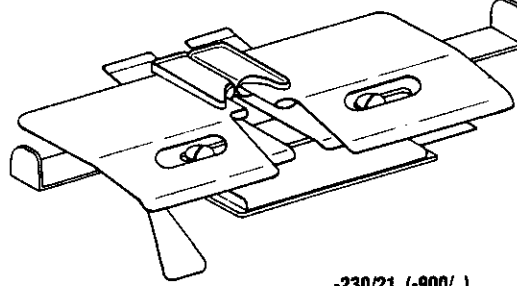

91-156 268-73 [5] [10/2]



-230/21 (-900/..)

**Nähwerkzeuge**  
**Gauge parts**

**Organes de couture**  
**Organos de costura**

91-156 277-71/995  

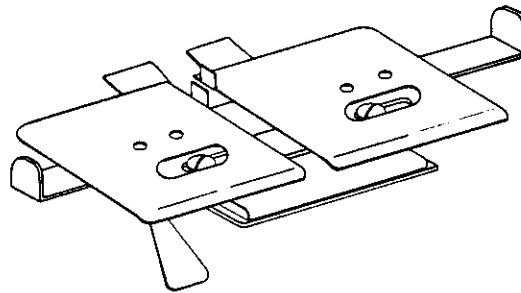

-237/01 (-900/..)

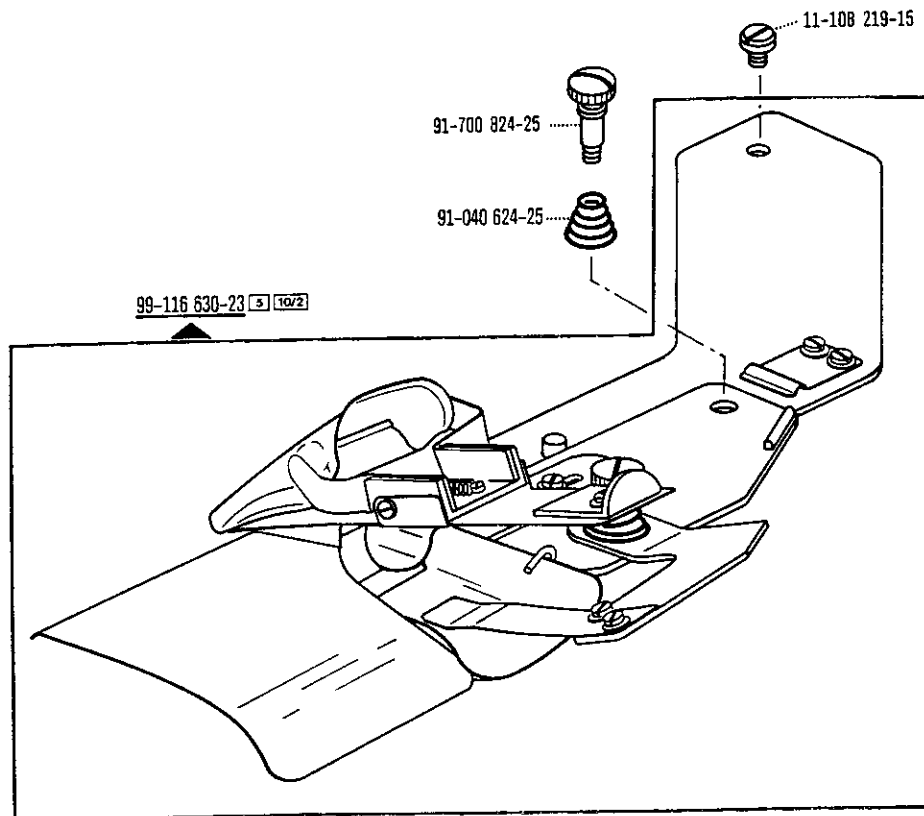

-63/99 (-900/..)



Nähwerkzeuge  
Gauge parts

Organes de couture  
Organos de costura

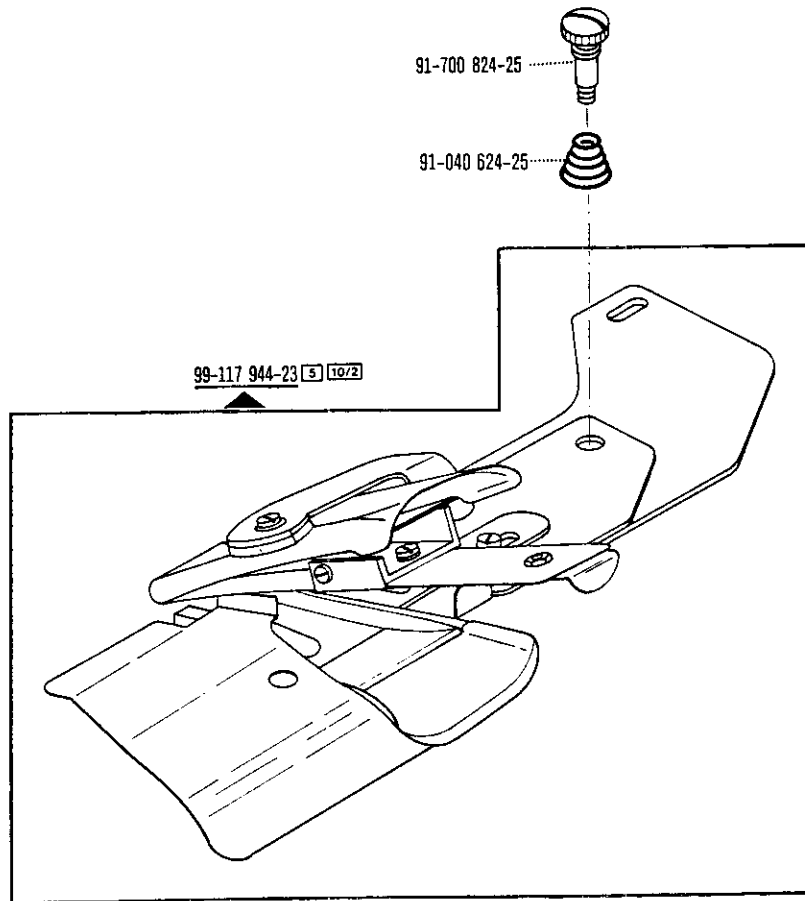

-68/97 (-900/..)

Nähwerkzeuge  
Gauge parts

Organes de couture  
Organos de costura

91-753 936-90

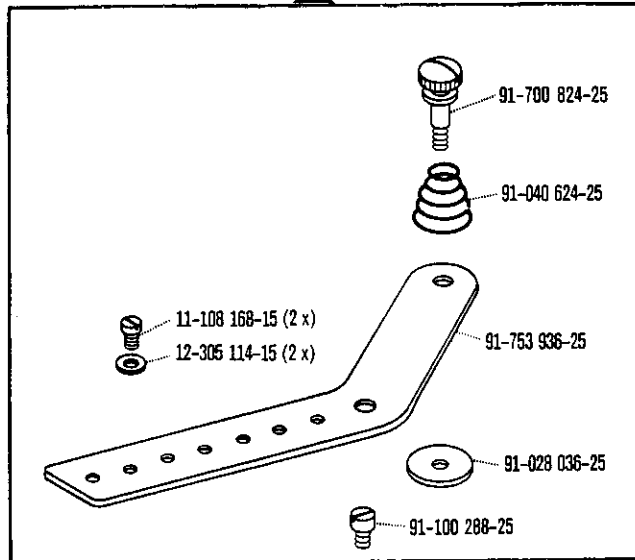

-147/02 (-900/..)  
-148/02 (-900/..)

11-130 173-15 (2 x)

91-057 707-91 (10/2)

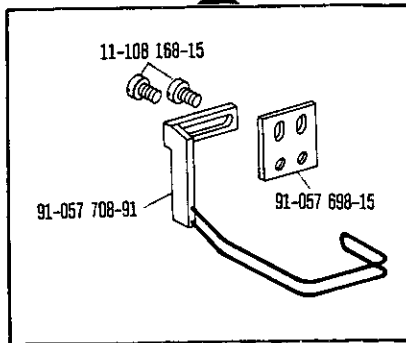

10 = 4,8 - 15,2 mm

-6/01 (-900/..)  
-6/07 (-900/..)  
-57/01 (-900/..)  
-58/01 (-900/..)  
-147/02 (-900/..)  
-148/02 (-900/..)

11-130 173-15 (2 x)

91-057 710-91 (10/2)

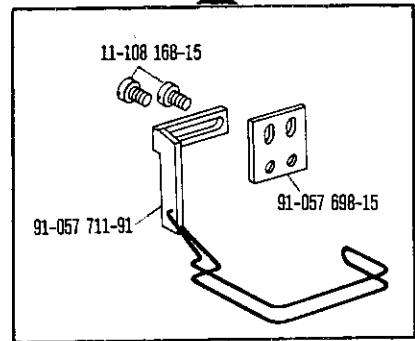

10 = 16,0 - 30,0 mm

-6/01 (-900/..)  
-6/07 (-900/..)  
-57/01 (-900/..)  
-58/01 (-900/..)  
-147/02 (-900/..)  
-148/02 (-900/..)

Nähwerkzeuge  
Gauge parts

Organes de couture  
Organos de costura

11-130 173-15 (2 x)



91-057 712-91 (10/2)

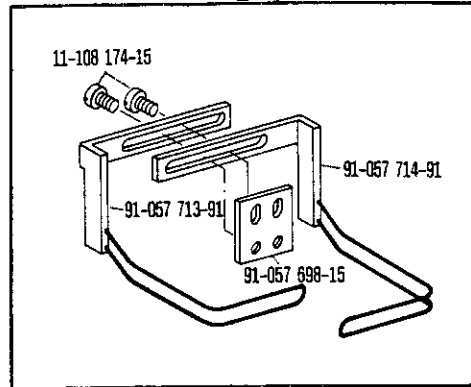

□ = 32,0 - 34,0 mm

11-130 173-15 (2 x)



91-155 422-91 (10/2)

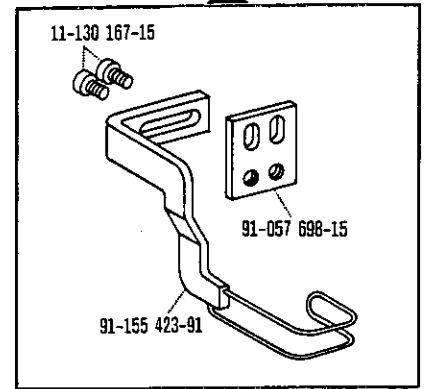

□ = 2,4 - 4,4 mm

-6/01 (-900/..)

-6/01 (-  
-6/07 (-

11-130 173-15 (2 x)



91-155 429-91 (10/2)

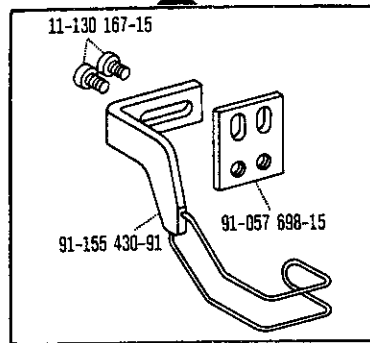

□ = 4,0 - 6,4 mm

-147/02 (-900/..)

-148/02 (-900/..)

# PFAFF

## 1246

**Unterklassen-Ausstattung**

Subclass parts

Composition des sous-classes

Composición de las subclases

# 16.03

## Unterklassen-Ubersicht Table of subclasses Table de sous-classes Tabla de subclases

PFAFF 1246-706/07

Unterklasse Subclass Sous-classe Subclase	-6/01 ▲	-6/01 ▲	-6/01 ▲	-6/01-900/.. ▲
Arbeitsgang Operation Opération Operación	Für allgemeine Näharbeiten. Standardform des Teilesatzes. For ordinary sewing operations. Standard part set. Travaux d'utilité courante. Jeu de pièces standard. Para trabajos de costura en general. Juego de piezas estándar.	Für allgemeine Näharbeiten. Standardform des Teilesatzes. For ordinary sewing operations. Standard part set. Travaux d'utilité courante. Jeu de pièces standard. Para trabajos de costura en general. Juego de piezas estándar.	Für allgemeine Näharbeiten. Standardform des Teilesatzes. For ordinary sewing operations. Standard part set. Travaux d'utilité courante. Jeu de pièces standard. Para trabajos de costura en general. Juego de piezas estándar.	Für allgemeine Näharbeiten. Standardform des Teilesatzes. For ordinary sewing operations. Standard part set. Travaux d'utilité courante. Jeu de pièces standard. Para trabajos de costura en general. Juego de piezas estándar.
Ausführung Model Version Tipo de máquina	BN	CN	CN8	BN
Nadelabstand in mm Needle gauge in mm Ecartement des aiguilles en mm Distancia entre agujas en mm	2,4 - 50,0	3,2 - 50,0	3,2 - 50,0	3,2 - 32,0
Nadelstange <sup>10/2</sup> Needle bar Barre à aiguille Barra de aguja	91-710 749-93 <sup>10</sup> = 2,4 - 34,0 mm 91-710 750-93 <sup>10</sup> = 36,0 - 50,0 mm	91-710 749-93 <sup>10</sup> = 3,2 - 34,0 mm 91-710 750-93 <sup>10</sup> = 36,0 - 50,0 mm	91-710 749-93 <sup>10</sup> = 3,2 - 34,0 mm 91-710 750-93 <sup>10</sup> = 36,0 - 50,0 mm	91-710 749-93
Stoffdrückerfuß <sup>4</sup> <sup>10/2</sup> Presser foot Pied presseur Pie prensatelas	91-040 429-04	91-040 429-04	91-049 668-04	91-040 429-04
Stoffschiebefuß <sup>4</sup> <sup>10/2</sup> Vibrating presser Pied entraîneur Transportador superior	91-049 267-93	91-049 267-93	91-049 267-93	91-049 267-93
Stichplatte <sup>4</sup> <sup>10/1</sup> <sup>10/2</sup> Needle plate Plaque à aiguille Placa de aguja	91-040 434-04	91-040 434-04	91-158 601-04	91-058 945-04
Stoffschieber <sup>4</sup> <sup>10/1</sup> Feed dog Griffe Transportador inferior	91-040 433-04 <sup>10</sup> = 2,4 - 34,0 mm 91-047 275-93 <sup>10</sup> = 38,0 - 50,0 mm	91-040 433-04 <sup>10</sup> = 3,2 - 36,0 mm 91-047 275-93 <sup>10</sup> = 38,0 - 50,0 mm	91-040 433-04 <sup>10</sup> = 3,2 - 36,0 mm 91-047 275-93 <sup>10</sup> = 38,0 - 50,0 mm	91-040 433-04
Fingerschutz Finger guard Protège-doigts Salvadedos	91-057 721-91 <sup>10</sup> = 2,4 - 4,4 mm 91-057 722-91 <sup>10</sup> = 4,8 - 15,2 mm 91-057 723-91 <sup>10</sup> = 16,0 - 30,0 mm 91-057 724-91 <sup>10</sup> = 32,0 - 50,0 mm	91-057 721-91 <sup>10</sup> = 3,2 - 4,4 mm 91-057 722-91 <sup>10</sup> = 4,8 - 15,2 mm 91-057 723-91 <sup>10</sup> = 16,0 - 30,0 mm 91-057 724-91 <sup>10</sup> = 32,0 - 50,0 mm	91-057 721-91 <sup>10</sup> = 3,2 - 4,4 mm 91-057 722-91 <sup>10</sup> = 4,8 - 15,2 mm 91-057 723-91 <sup>10</sup> = 16,0 - 30,0 mm 91-057 724-91 <sup>10</sup> = 32,0 - 50,0 mm	91-057 721-91 <sup>10</sup> = 3,2 - 4,4 mm 91-057 722-91 <sup>10</sup> = 4,8 - 15,2 mm 91-057 723-91 <sup>10</sup> = 16,0 - 30,0 mm 91-057 724-91 <sup>10</sup> = 32,0 mm
Apparat <sup>5</sup> Attachment Appareil Aparato				
Schieber, links <sup>10/2</sup> Slide, left Glissière, gauche Corredera, izquierda	91-018 889-24	91-018 889-24	91-018 889-24	91-018 889-24
Schieber, rechts <sup>10/2</sup> Slide, right Glissière, droite Corredera, derecha	91-010 061-24	91-010 061-24	91-010 061-24	91-018 888-24
Träger Bracket Support Soporte				
Bandführung Tape guide Guide-ruban Guicintas				
<p>▲ Nähwerkzeuge für Maschinen mit und ohne Hüpftransport. Part set for machines with and without four-motion drop feed. Organes de couture pour machines avec et sans griffe santillante. Organos de couture para máquinas con y sin transporte a cuatro tiempos.</p>				

Unterklassen-Übersicht



Table of subclasses

Table de sous-classes

Tabla de subclases

PFAFF 1246-706/07

16.03





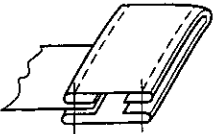
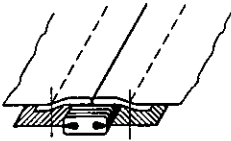
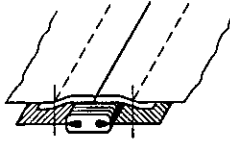

Unterklasse Subclass Sous-classe Subclase	-6/01-900/.. ▲	-6/01-900/.. ▲	-63/03 ▲	-63/03-900/.. ▲
Arbeitsgang Operation Opération Operación	Für allgemeine Näharbeiten. Standardform des Teilesatzes. For ordinary sewing operations. Standard part set. Travaux d'utilité courante. Jeu de pièces standard. Para trabajos de costura en general. Juego de piezas estándar.	Für allgemeine Näharbeiten. Standardform des Teilesatzes. For ordinary sewing operations. Standard part set. Travaux d'utilité courante. Jeu de pièces standard. Para trabajos de costura en general. Juego de piezas estándar.		
Ausführung Model Version Tipo de máquina	CN	CN8	CN	CN
Nadelabstand in mm Needle gauge in mm Ecartement des aiguilles en mm Distancia entre agujas en mm	3,2 - 32,0	3,2 - 32,0	3,2 - 20,0	3,2 - 20,0
Nadelstange <sup>10/2</sup> Needle bar Barre à aiguille Barra de aguja	91-710 749-93	91-710 749-93	91-710 749-93	91-710 749-93
Stoffdrückerfuß <sup>4</sup> <sup>10/2</sup> Presser foot Pied presseur Pie prensatelas	91-040 429-04	91-049 668-04	91-049 509-04	91-049 509-04
Stoffschiebefuß <sup>4</sup> <sup>10/2</sup> Vibrating presser Pied entraîneur Transportador superior	91-049 267-93	91-049 267-93	91-049 017-93	91-049 017-93
Stichplatte <sup>4</sup> <sup>10/1</sup> <sup>10/2</sup> Needle plate Plaque à aiguille Placa de aguja	91-058 943-04	91-158 602-04	91-040 434-04	91-058 943-04
Stoffschieber <sup>4</sup> <sup>10/1</sup> Feed dog Griffe Transportador inferior	91-047 934-04	91-047 934-04	91-047 934-04	91-047 934-04
Fingerschutz Finger guard Protège-doigts Salvadedos	91-057 721-91 <sup>10</sup> = 3,2 - 4,4 mm 91-057 722-91 <sup>10</sup> = 4,8 - 15,2 mm 91-057 723-91 <sup>10</sup> = 16,0 - 30,0 mm 91-057 724-91 <sup>10</sup> = 32,0 mm	91-057 741-91 <sup>10</sup> = 3,2 - 4,4 mm 91-057 806-91 <sup>10</sup> = 4,8 - 15,2 mm 91-057 809-91 <sup>10</sup> = 16,0 - 30,0 mm 91-057 812-91 <sup>10</sup> = 32,0 mm		
Apparat <sup>5</sup> Attachment Appareil Aparato			91-042 369-21	91-042 369-21
Schieber, links <sup>10/2</sup> Slide, left Glissière, gauche Corredera, izquierda	91-018 889-24	91-018 889-24	91-018 889-24	91-018 889-24
Schieber, rechts <sup>10/2</sup> Slide, right Glissière, droite Corredera, derecha	91-018 888-24	91-018 888-24	91-010 061-24	91-018 888-24
Träger Bracket Support Soporte			91-041 644-91	91-041 644-91
Bandführung Tape guide Guide-ruban Guiacintas			91-044 419-25	91-044 419-25
<p>▲ Nähwerkzeuge für Maschinen mit und ohne Hüpftransport. Part set for machines with and without four-motion drop feed. Organes de couture pour machines avec et sans griffe sautillante. Organos de couture para máquinas con y sin transporte a cuatro tiempos.</p>				

# 16.03

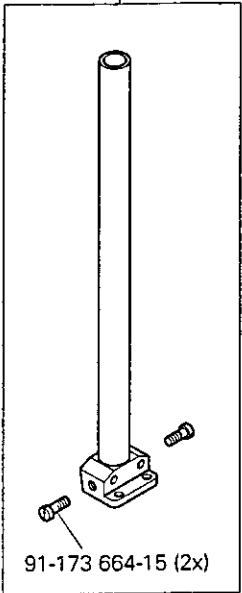
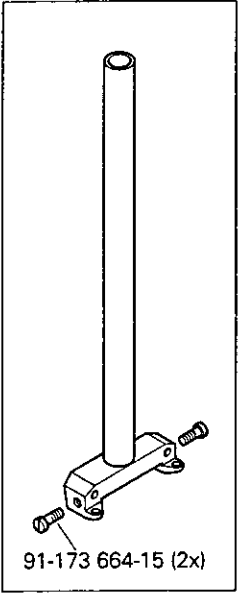
## Unterklassen-Ubersicht Table of subclasses Table de sous-classes Tabla de subclases

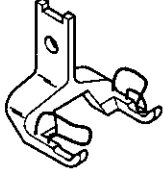
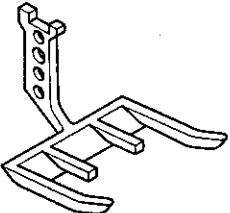
PFAFF 1246-706/07

Unterklasse Subclass Sous-classe Subclase	-68/99 ▲	-230/21 ▲	-230/21-900/.. ▲
Arbeitsgang Operation Opération Operación			
Ausführung Model Version Tipo de máquina	BN	CN	CN
Nadelabstand in mm Needle gauge in mm Écartement des aiguilles en mm Distancia entre agujas en mm	30,0 - 40,0	8,0 - 30,0	8,0 - 30,0
Nadelstange <sup>10/2</sup> Needle bar Barre à aiguille Barra de aguja	91-710 749-93 <sup>10</sup> = 30,0 - 34,0 mm 91-710 750-93 <sup>10</sup> = 36,0 - 40,0 mm	91-710 749-93	91-710 749-93
Stoffdrückerfuß <sup>4</sup> <sup>10/2</sup> Presser foot Pied presseur Pie prensatelas	91-049 708-04	91-049 503-03 <sup>5</sup>	91-049 503-03 <sup>5</sup>
Stoffschiebefuß <sup>4</sup> <sup>10/2</sup> Vibrating presser Pied entraîneur Transportador superior	91-049 276-93	91-049 144-93 <sup>5</sup>	91-049 144-93 <sup>5</sup>
Stichplatte <sup>4</sup> <sup>10/1</sup> <sup>10/2</sup> Needle plate Plaque à aiguille Placa de aguja	91-040 434-04	91-040 434-04	91-058 943-04
Stoffschieber <sup>4</sup> <sup>10/1</sup> Feed dog Griffe Transportador inferior	91-040 433-04 <sup>10</sup> = 30,0 - 36,0 mm 91-047 275-93 <sup>10</sup> = 38,0 - 40,0 mm	91-040 433-04	91-047 934-04
Fingerschutz Finger guard Protège-doigts Salvadedos	91-057 723-91 <sup>10</sup> = 30,0 mm 91-057 724-91 <sup>10</sup> = 32,0 - 40,0 mm		
Apparat <sup>5</sup> Attachment Appareil Aparato	99-116 630-23	91-053 537-24	91-053 537-24
Schieber, links <sup>10/2</sup> Slide, left Glissière, gauche Corredera, izquierda	91-018 889-24	91-018 889-24	91-018 889-24
Schieber, rechts <sup>10/2</sup> Slide, right Glissière, droite Corredera, derecha	91-010 061-24	91-010 061-24	91-018 888-24
Träger Bracket Support Soporte			
Bandführung Tape guide Guide-ruban Guiacintas			
<p>▲ Nähwerkzeuge für Maschinen mit und ohne Hüpftransport. Part set for machines with and without four-motion drop feed. Organes de couture pour machines avec et sans griffe sautillante. Organos de couture para máquinas con y sin transporte a cuatro tiempos.</p>			

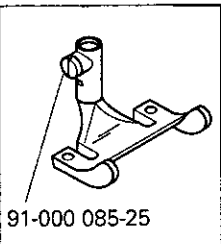
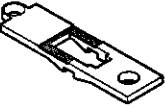
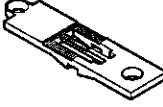
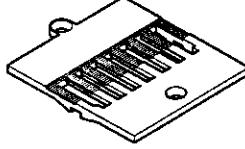
<p>91-710 749-93 <span style="border: 1px solid black; padding: 0 2px;">4</span> <span style="border: 1px solid black; padding: 0 2px;">10/2</span></p>  <p>91-173 664-15 (2x)</p> <p>-6/01 (-900/..)                  -63/03 (-900/..)                  -68/99                  -230/21 (-900/..)</p>	<p>91-710 750-93 <span style="border: 1px solid black; padding: 0 2px;">4</span> <span style="border: 1px solid black; padding: 0 2px;">10/2</span></p>  <p>91-173 664-15 (2x)</p> <p>-6/01                  -68/99</p>	<p>91-040 429-04 <span style="border: 1px solid black; padding: 0 2px;">4</span> <span style="border: 1px solid black; padding: 0 2px;">10/2</span></p>  <p>-6/01 (-900/..) BN; CN</p>	<p>91-049 503-03 <span style="border: 1px solid black; padding: 0 2px;">4</span> <span style="border: 1px solid black; padding: 0 2px;">10/2</span></p>  <p>-230/21 (-900/..)</p>
<p>91-049 708-04 <span style="border: 1px solid black; padding: 0 2px;">4</span> <span style="border: 1px solid black; padding: 0 2px;">10/2</span></p>  <p>-68/99</p>	<p>91-049 017-93 <span style="border: 1px solid black; padding: 0 2px;">4</span> <span style="border: 1px solid black; padding: 0 2px;">10/2</span></p>  <p>91-000 085-25</p> <p>-63/03 (-900/..)</p>	<p>91-049 144-93 <span style="border: 1px solid black; padding: 0 2px;">4</span> <span style="border: 1px solid black; padding: 0 2px;">10/2</span></p>  <p>91-000 085-25</p> <p>-230/21 (-900/..)</p>	<p>91-049 267-93 <span style="border: 1px solid black; padding: 0 2px;">4</span> <span style="border: 1px solid black; padding: 0 2px;">10/2</span></p>  <p>91-000 085-25</p> <p>-6/01 (-900/..)</p>
<p>91-049 276-93 <span style="border: 1px solid black; padding: 0 2px;">4</span> <span style="border: 1px solid black; padding: 0 2px;">10/2</span></p>  <p>91-000 085-25</p> <p>-68/99</p>	<p>91-040 434-04 <span style="border: 1px solid black; padding: 0 2px;">4</span> <span style="border: 1px solid black; padding: 0 2px;">10/2</span></p> <p><span style="border: 1px solid black; padding: 0 2px;">10</span> = B 2,4 - 4,0 mm                  C 3,2 - 6,4 mm</p>  <p>-6/01 BN; CN                  -63/03 CN</p>	<p>91-040 434-04 <span style="border: 1px solid black; padding: 0 2px;">4</span> <span style="border: 1px solid black; padding: 0 2px;">10/1</span> <span style="border: 1px solid black; padding: 0 2px;">10/2</span></p> <p><span style="border: 1px solid black; padding: 0 2px;">10</span> = B 4,8 mm &gt;                  C 7,2 mm &gt;</p>  <p>-6/01 BN; CN                  -63/03 CN                  -68/99 BN                  -230/21 CN</p>	<p>91-040 434-04 <span style="border: 1px solid black; padding: 0 2px;">4</span> <span style="border: 1px solid black; padding: 0 2px;">10/1</span> <span style="border: 1px solid black; padding: 0 2px;">10/2</span></p> <p><span style="border: 1px solid black; padding: 0 2px;">10</span> = 38,0 - 50,0 mm</p>  <p>-6/01 BN; CN                  -63/03 CN                  -68/99 BN</p>



# 16.04

Nähwerkzeuge  
 Gauge parts  
 Organes de couture  
 Organos de costura PFAFF 1246-706/07

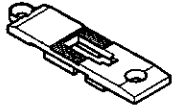
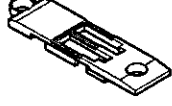
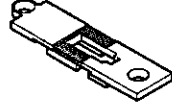
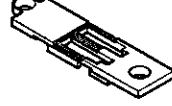
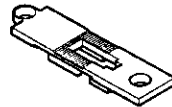
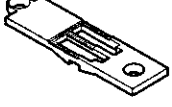
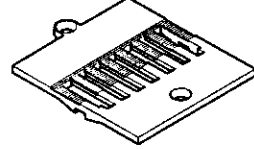
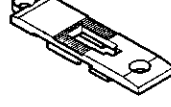
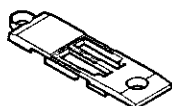
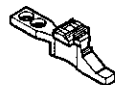
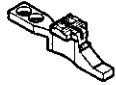
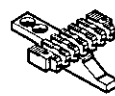
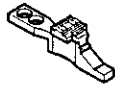
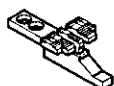
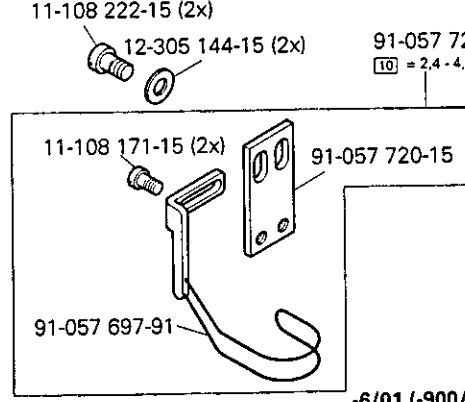
<p>91-058 943-04 <span style="border: 1px solid black; padding: 0 2px;">4</span> <span style="border: 1px solid black; padding: 0 2px;">10/2</span>  <span style="border: 1px solid black; padding: 0 2px;">10</span> = C 3.2 - 6,4 mm</p>  <p>-6/01-900/.. CN          -63/03-900/.. CN</p>	<p>91-058 943-04 <span style="border: 1px solid black; padding: 0 2px;">4</span> <span style="border: 1px solid black; padding: 0 2px;">10/1</span> <span style="border: 1px solid black; padding: 0 2px;">10/2</span>  <span style="border: 1px solid black; padding: 0 2px;">10</span> = C 7,2 mm &gt;</p>  <p>-6/01-900/.. CN          -63/03-900/.. CN          -230/21-900/.. CN</p>	<p>91-058 945-04 <span style="border: 1px solid black; padding: 0 2px;">4</span> <span style="border: 1px solid black; padding: 0 2px;">10/2</span>  <span style="border: 1px solid black; padding: 0 2px;">10</span> = B 3.2 - 4,0 mm</p>  <p>-6/01-900/.. BN</p>	<p>91-058 945-04 <span style="border: 1px solid black; padding: 0 2px;">4</span> <span style="border: 1px solid black; padding: 0 2px;">10/1</span> <span style="border: 1px solid black; padding: 0 2px;">10/2</span>  <span style="border: 1px solid black; padding: 0 2px;">10</span> = B 4,8 mm &gt;</p>  <p>-6/01-900/.. BN</p>
<p>91-158 601-04 <span style="border: 1px solid black; padding: 0 2px;">4</span> <span style="border: 1px solid black; padding: 0 2px;">10/2</span>  <span style="border: 1px solid black; padding: 0 2px;">10</span> = C 3.2 - 6,4 mm</p>  <p>-6/01 CN 8</p>	<p>91-158 601-04 <span style="border: 1px solid black; padding: 0 2px;">4</span> <span style="border: 1px solid black; padding: 0 2px;">10/1</span> <span style="border: 1px solid black; padding: 0 2px;">10/2</span>  <span style="border: 1px solid black; padding: 0 2px;">10</span> = C 7,2 mm &gt;</p>  <p>-6/01 CN 8</p>	<p>91-158 601-04 <span style="border: 1px solid black; padding: 0 2px;">4</span> <span style="border: 1px solid black; padding: 0 2px;">10/1</span> <span style="border: 1px solid black; padding: 0 2px;">10/2</span>  <span style="border: 1px solid black; padding: 0 2px;">10</span> = B 38,0 - 50,0 mm</p>  <p>-6/01 CN 8</p>	<p>91-158 602-04 <span style="border: 1px solid black; padding: 0 2px;">4</span> <span style="border: 1px solid black; padding: 0 2px;">10/2</span>  <span style="border: 1px solid black; padding: 0 2px;">10</span> = C 3.2 - 6,4 mm</p>  <p>-6/01-900/.. CN 8</p>
<p>91-158 602-04 <span style="border: 1px solid black; padding: 0 2px;">4</span> <span style="border: 1px solid black; padding: 0 2px;">10/1</span> <span style="border: 1px solid black; padding: 0 2px;">10/2</span>  <span style="border: 1px solid black; padding: 0 2px;">10</span> = C 7,2 mm &gt;</p>  <p>-6/01-900/.. CN 8</p>	<p>91-040 433-04 <span style="border: 1px solid black; padding: 0 2px;">4</span> <span style="border: 1px solid black; padding: 0 2px;">10/2</span>  <span style="border: 1px solid black; padding: 0 2px;">10</span> = B 2,4 - 4,0 mm          C 3,2 - 6,4 mm</p>  <p>-6/01 BN; CN; CN 8          -6/01-900/.. BN          -63/03 CN</p>	<p>91-040 433-04 <span style="border: 1px solid black; padding: 0 2px;">4</span> <span style="border: 1px solid black; padding: 0 2px;">10/1</span> <span style="border: 1px solid black; padding: 0 2px;">10/2</span>  <span style="border: 1px solid black; padding: 0 2px;">10</span> = B 4,8 mm          C 7,2 mm</p>  <p>-6/01 BN; CN; CN 8          -6/01-900/.. BN          -63/03 CN          -68/99 BN</p>	<p>91-047 275-93 <span style="border: 1px solid black; padding: 0 2px;">4</span> <span style="border: 1px solid black; padding: 0 2px;">10/1</span> <span style="border: 1px solid black; padding: 0 2px;">10/2</span></p>  <p>-6/01 BN; CN; CN 8          -68/99 BN</p>
<p>91-047 934-04 <span style="border: 1px solid black; padding: 0 2px;">4</span> <span style="border: 1px solid black; padding: 0 2px;">10/2</span>  <span style="border: 1px solid black; padding: 0 2px;">10</span> = C 3.2 - 6,4 mm</p>  <p>-6/01-900/.. CN; CN 8          -63/03-900/.. CN</p>	<p>91-047 934-04 <span style="border: 1px solid black; padding: 0 2px;">4</span> <span style="border: 1px solid black; padding: 0 2px;">10/1</span> <span style="border: 1px solid black; padding: 0 2px;">10/2</span>  <span style="border: 1px solid black; padding: 0 2px;">10</span> = C 7,2 mm &gt;</p>  <p>-6/01-900/.. CN; CN 8          -63/03-900/.. CN          -230/21-900/.. CN</p>	 <p>11-108 222-15 (2x)          12-305 144-15 (2x)          91-057 721-91  <span style="border: 1px solid black; padding: 0 2px;">10</span> = 2,4 - 4,4 mm          11-108 171-15 (2x)          91-057 720-15          91-057 697-91          -6/01 (-900/..) BN; CN</p>	

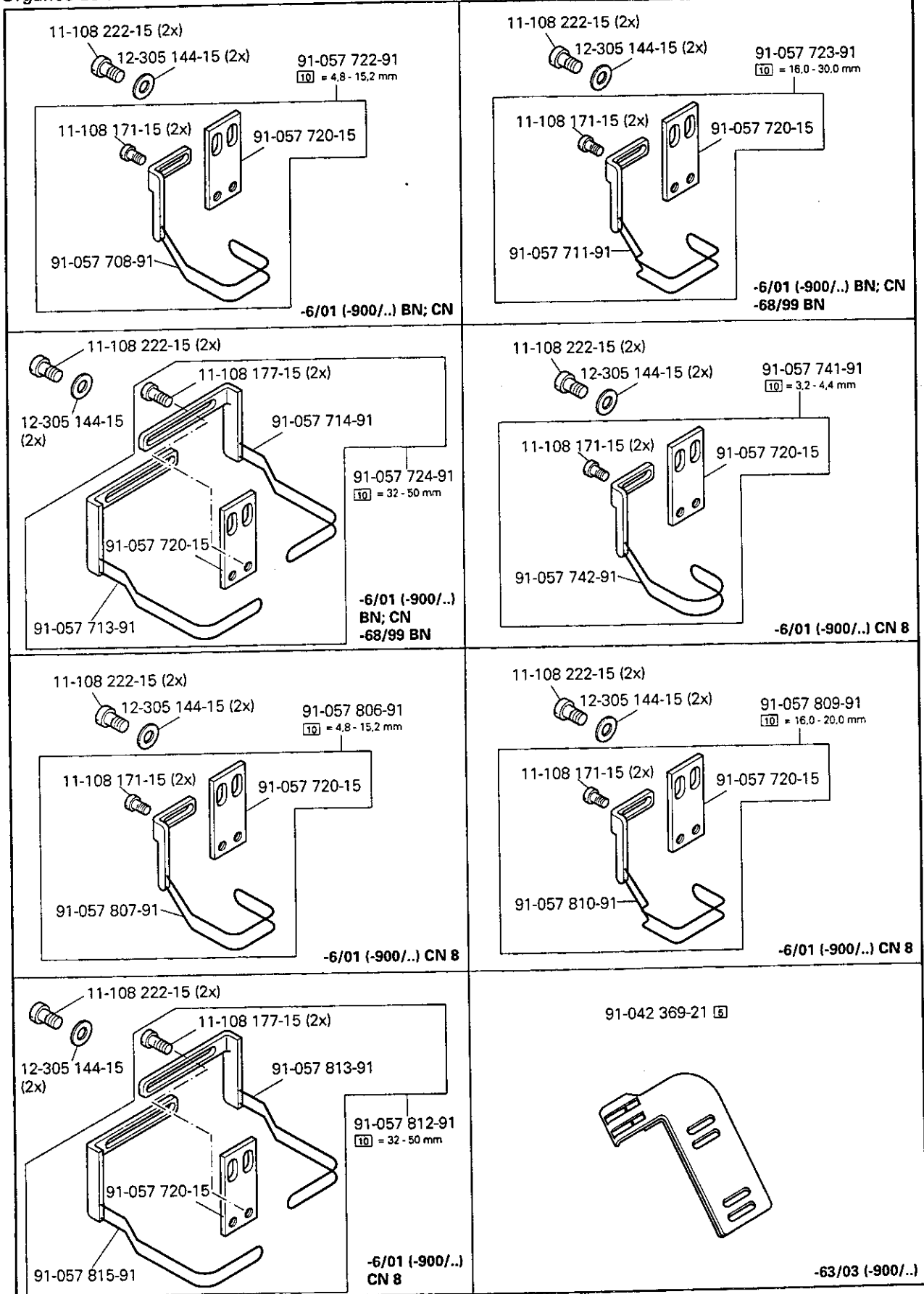

# 16.04

Nähwerkzeuge  
Gauge parts  
Organes de couture  
Organos de costura PFAFF 1246-706/07

91-053 537-24 

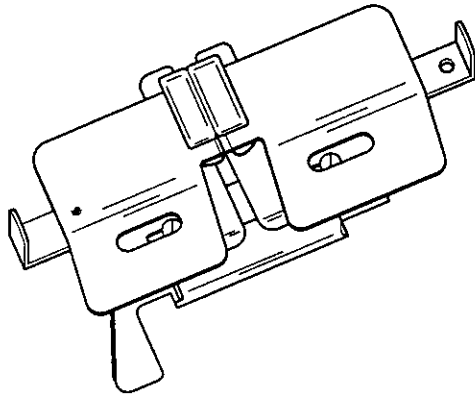

-230/21 (-900/..)

91-000 521-25 

91-000 824-25 

91-040 624-25 

99-166 630-23 

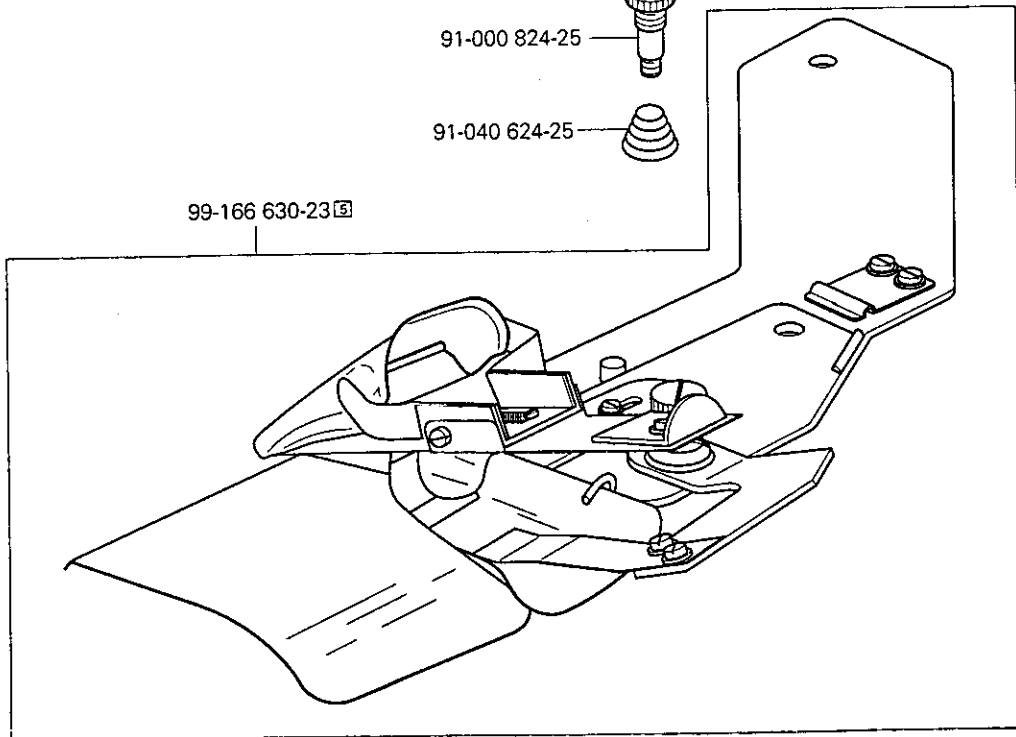

-68/99

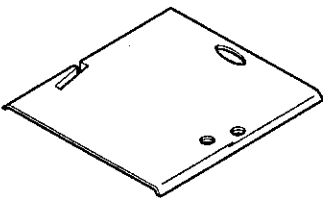
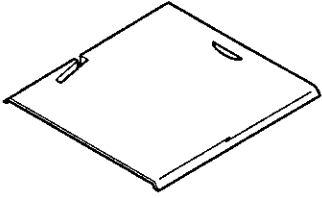
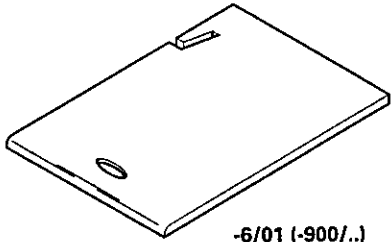
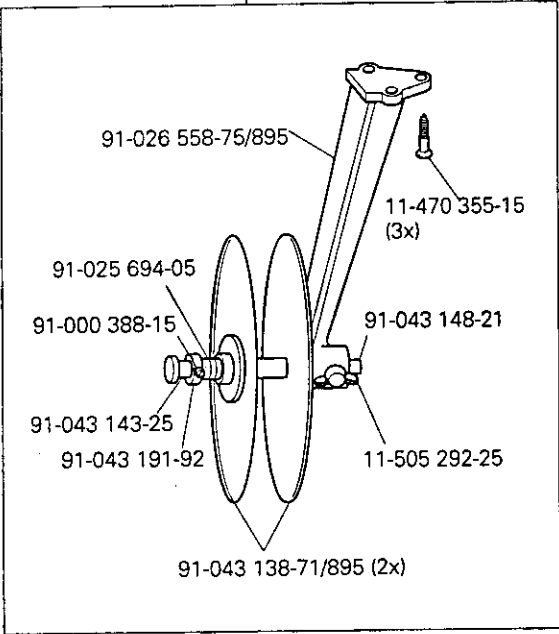
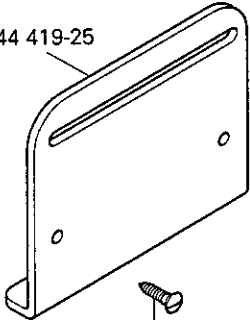
<p>91-010 061-24 <span style="border: 1px solid black; padding: 0 2px;">102</span></p>  <p style="text-align: right;">-6/01 -63/03 -68/99 -230/21</p>	<p>91-018 888-24 <span style="border: 1px solid black; padding: 0 2px;">102</span></p>  <p style="text-align: right;">-6/01-900/.. -63/03-900/.. -230/21-900/..</p>	<p>91-018 889-24 <span style="border: 1px solid black; padding: 0 2px;">102</span></p>  <p style="text-align: right;">-6/01 (-900/.. -63/03 (-900/.. -68/99 -230/21 (-900/..)</p>
<p>91-041 644-70/895</p>  <p style="text-align: right;">-63/03 (-900/..)</p>		<p>91-044 419-25</p>  <p style="text-align: right;">-63/03 (-900/..)</p>
<p>91-026 558-75/895</p> <p>11-470 355-15 (3x)</p> <p>91-025 694-05</p> <p>91-000 388-15</p> <p>91-043 143-25</p> <p>91-043 191-92</p> <p>91-043 148-21</p> <p>11-505 292-25</p> <p>91-043 138-71/895 (2x)</p>		<p>11-470 109-25 (2x)</p>