

FORM 18010
MAY, 1924
PRINTED IN U. S. A.

LIST OF PARTS



MACHINE No. 112-3

THE SINGER MANUFACTURING COMPANY

COPYRIGHT, U. S. A., 1922, 1923 AND 1924,
BY THE SINGER MANUFACTURING CO.
ALL RIGHTS RESERVED FOR ALL COUNTRIES

INDEX

	PAGE
ACCESSORIES	15
FOOT LIFTER PARTS	15
IRON BASE	14
KNEE LIFTER PARTS	15
MACHINE NO. 112-3	7
NUMERICAL LIST OF PARTS	19
OBSOLETE PARTS	17
TABLE SUPPORT PARTS	16
THREAD UNWINDER	17

INSTRUCTIONS FOR ORDERING

In ordering from this list, use **ONLY** the **PART** number in the **FIRST** column.

The number stamped on a Sewing Machine part is in every case the number of the single part only.

Every combination of parts sent out as such has its specific number, which, although not stamped on the parts, must be used when ordering the combination.

Each number always indicates the **SAME PART** in whatever list it appears, or for whatever machine.

The letters after some of the numbers indicate the style of finish only, as follows:

- A. Hardened, Polished and Plated.
- B. Polished and Plated.
- C. Hardened only.
- D. Polished only.
- E. Soft, not Polished.
- F. Hardened and Polished.
- G.
- H. Blued.
- J. Plated only.
- K. Hardened and Plated.
- L. Brass or Gilt.
- M. Oxidized.
- P. Japanned.
- R. Parkerized.
- T. Copper-plated.

These letters **MUST BE USED** *when* they appear in the list, and **AFTER** the number *as* in the list.

In this series:

- 1 to 1500 and 50001 to 51500 are Screw Numbers.
- 1501 to 1800 are Nut Numbers.
- 1801 to 2000 are Roller Numbers.
- 2001 to 50000 and 52001 and upward are numbers of Machine Parts.

The figures in the second column refer only to the plates, illustrating the parts, and are **NOT TO BE USED** in ordering.

Parts marked with an asterisk (*) are furnished only when repairs are made at factory.

LIST OF PARTS COMPLETE FOR

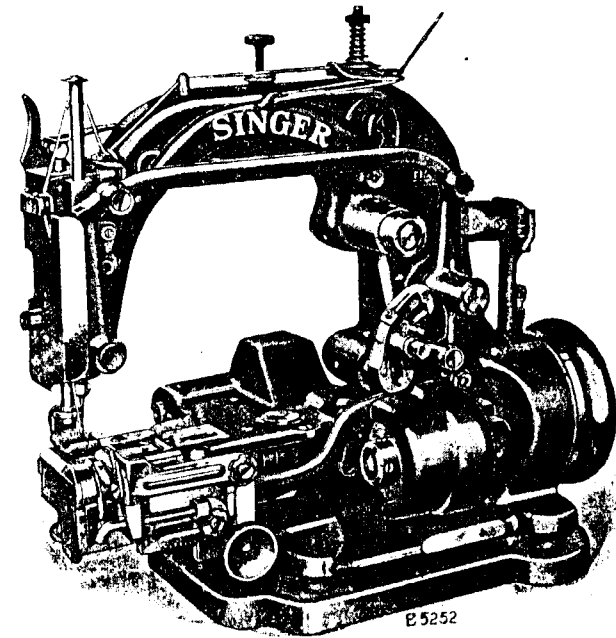

MACHINE No. 112-3

FOR ABUTTING AND STITCHING RIBBON, STRAW BRAID WITH FINISHED EDGE AND PYROXYLIN BRAID USED IN MANUFACTURE OF HATS. OVERSEAMING ZIGZAG SINGLE THREAD CHAIN STITCH. THE NEEDLE VIBRATES UP TO $\frac{3}{16}$ IN. LENGTH OF STITCH FROM $\frac{1}{24}$ TO $\frac{1}{8}$ IN. DROP FEED. FEED DOGS AND PRESSER FEET FOR DIFFERENT VARIETIES OF BRAID. ADJUSTABLE GUIDE FOR DIFFERENT WIDTHS OF BRAID. TIPPER. BRAID DIVIDING FINGER HINGED, TO THROW OUT WHILE MAKING THE BUTTON OF THE HAT. COMPOUND TENSION, SELF-SETTING NEEDLE. FLAT COMBINATION BASE AND DRIP PAN IN PLACE OF ADJUSTABLE BASE.

NO.	PLATE	NAME
*64882	—	Arm, upper and lower (solid)
34461	8511	“ End Cover and Belt Guard
207d	8507	“ “ “ “ “ “ Screw

NO.	PLATE	NAME
64802	8511	Arm Rotary Shaft.....
64803	8512	" " " Bushing (front).....
1036c	8507	" " " " " Set Screw.....
64804	8511	Arm Rotary Shaft Flanged Bushing (back) with 64805.....
64805	8519	Arm Rotary Shaft Flanged Bushing (back) Oil Pad (braided cotton).....
1036c	8507	Arm Rotary Shaft Flanged Bushing (back) Set Screw.....
64806	8512	Arm Rotary Shaft Gear with two 200F..
200F	8512	" " " " Set Screw.....
64807	8511	Balance Wheel and Needle Bar Lever Eccentric with 430c and 1285c.....
1285c	8507	Balance Wheel and Needle Bar Lever Eccentric Position Screw.....
430c	8507	Balance Wheel and Needle Bar Lever Eccentric Set Screw.....
64903	8511	Face Plate.....
330E	8507	" " Screw.....
64931	8511	Feed Bar.....
64810	8512	" " Connecting Link.....
50683c	8512	" " " " Hinge Screw
1655E	8512	" " " " " " "
		Nut.....
64883	8522	Feed Bar Cover.....
176F	8507	" " " Screw.....
64812	8512	" " Hinge Stud.....
452c	8507	" " " " Set Screw.....
64926	8512	" Connecting Rod with 1012E, 42009 and two 1057E.....
1012E	8512	Feed Connecting Rod Adjusting Screw...
*42009	-----	" " " Cap.....
1057E	8512	" " " " Screw.....
64904	8513	" Dog (fine).....
64928	8513	" " (medium).....
64936	8513	" " (coarse).....
64939	8513	" " Carrier.....
64940	-----	" " " 64939 with 995c.....
19020	8512	" " " Friction Spring.....
22441	8512	" " " " Washer
995c	8512	" " " Regulating Thumb Screw.....
996c	8512	Feed Dog Carrier Screw.....
997c	8512	" " Screw.....
64927	8512	" Eccentric with two 452c.....
452c	8507	" " Set Screw.....

NO.	PLATE	NAME
64814	8512	Feed Lifting Eccentric with 452c and 462c.....
64815	8512	Feed Lifting Eccentric Connection with 171E and 59019.....
171E	8512	Feed Lifting Eccentric Connection Ad- justing Screw.....
59019	8512	Feed Lifting Eccentric Connection Gib...
50562c	8512	" " " " Hinge Screw.....
1520E	8512	Feed Lifting Eccentric Connection Hinge Screw Nut.....
452c	8507	Feed Lifting Eccentric Position Screw...
462c	8512	" " " Set Screw.....
64816	8511	" " Rock Shaft.....
64817	8512	" " " " Bushing.....
1036c	8507	" " " " " Set Screw
64818	8514	" " " " Crank (back) with 157E.....
157E	8514	Feed Lifting Rock Shaft Crank (back) Clamping Screw.....
64819	8514	Feed Lifting Rock Shaft Crank (front) with 157E, 1655E and 50683c.....
157E	8514	Feed Lifting Rock Shaft Crank (front) Clamping Screw.....
1027c	8514	Feed Regulating Screw Stud.....
1627c	8514	" " " " Nut.....
42290	8514	" " " " Washer....
64820	8511	" Rocking Frame with four 452c....
59211	8511	" " " Hinge Pin.....
64821	8514	" " " " " Bushing
1036c	8507	" " " " " " "
		Set Screw.....
452c	8507	Feed Rocking Frame Hinge Pin Set Screw
64822	8514	Looper with 34418.....
64905	8514	" Gate.....
1240c	8514	" " Hinge Screw.....
64932	8519	" " Latch Spring.....
337J	8514	" " " " Screw.....
64906	8514	" " Spring.....
111J	8514	" " " Screw.....
64825	8514	" Shaft with 462c.....
64826	8514	" " Carrier.....
64827	8514	" " " Bushing.....
846c	8514	" " " " Set Screw .
64828	8504	" " " Pitman.....
1132F	8507	" " " " Hinge Screw
		(left).....

NO.	PLATE	NAME
50562c	8512	Looper Shaft Carrier Pitman Hinge Screw (right).....
1520e	8512	Looper Shaft Carrier Pitman Hinge Screw (right) Nut.....
64829	8514	Looper Shaft Coupling with two 462c....
462c	8512	“ “ “ Set Screw.....
462c	8512	“ Set Screw.....
34418	8514	“ Washer.....
64885	8515	Needle Bar (hollow) with 50165f and 64850.....
64831	8515	Needle Bar Connecting Bracket with 1056f and 50203e.....
50203e	8515	Needle Bar Connecting Bracket Clamping Screw.....
42055	8515	Needle Bar Connecting Link.....
40217	8515	“ “ “ “ Hinge Pin.....
1056f	8515	“ “ “ “ “ “ “ “ Set Screw.....
64832	8504	Needle Bar Frame.....
64833	8504	“ “ “ “ Cam and Gear.....
64834	8504	“ “ “ “ “ “ “ Cover.....
176d	8507	“ “ “ “ “ “ “ “ Screw.....
64835	8504	Needle Bar Frame Cam and Gear Stud (eccentric).....
64836	8515	Needle Bar Frame Cam and Gear Stud Collar with two 1259c.....
1259c	8515	Needle Bar Frame Cam and Gear Stud Collar Set Screw.....
1036c	8507	Needle Bar Frame Cam and Gear Stud Set Screw.....
64837	8504	Needle Bar Frame Driving Lever.....
64838	8515	“ “ “ “ “ “ “ Connecting Link with 1012d and 59019..
1012d	8512	Needle Bar Frame Driving Lever Connecting Link Adjusting Screw.....
59019	8512	Needle Bar Frame Driving Lever Connecting Link Gib.....
50562c	8512	Needle Bar Frame Driving Lever Connecting Link Hinge Screw.....
1520e	8512	Needle Bar Frame Driving Lever Connecting Link Hinge Screw Nut.....
64839	8515	Needle Bar Frame Driving Lever Hinge Stud.....
1036c	8507	Needle Bar Frame Driving Lever Hinge Stud Set Screw.....
64942	8521	Needle Bar Frame Guide with 50090d....

NO.	PLATE	NAME
176f	8507	Needle Bar Frame Guide Screw.....
37583	8515	“ “ “ Hinge Stud.....
1036c	8507	“ “ “ “ “ Set Screw.....
64841	8504	“ “ “ Pitman.....
50562c	8512	“ “ “ “ Hinge Screw.....
1520e	8512	“ “ “ “ “ “ “ Nut.....
64842	8511	Needle Bar Frame Regulator with two 1120c.....
64945	8518	Needle Bar Frame Regulator Hinge Stud.....
64946	8521	“ “ “ “ “ “ “ Bushing.....
1259c	8515	Needle Bar Frame Regulator Hinge Stud Bushing Set Screw.....
51865	8515	Needle Bar Frame Regulator Roller and Screw Stud.....
64844	8515	Needle Bar Frame Regulator Stop.....
220d	8515	“ “ “ “ “ “ “ Screw.....
7806	8515	“ “ “ “ “ “ “ Washer.....
1120c	8507	Needle Bar Frame Regulator Set Screw..
1374c	8515	“ “ “ Regulating Screw Stud.....
1680c	8515	“ “ “ “ “ “ “ Nut.....
42290	8514	Needle Bar Frame Regulating Screw Stud Washer.....
64845	8522	Needle Bar Lever with 1056f and two 1036c.....
42074	8515	Needle Bar Lever Ball Stud.....
1036c	8507	“ “ “ “ “ “ Set Screw... ..
64846	8504	“ “ “ “ Connecting Rod with 42059, 64847, 64848 and four 896e....
*64847	---	Needle Bar Lever Connecting Rod Cap (lower).....
896e	8507	Needle Bar Lever Connecting Rod Cap (lower) Screw.....
*42059	---	Needle Bar Lever Connecting Rod Cap (upper).....
896e	8507	Needle Bar Lever Connecting Rod Cap (upper) Screw.....
42077	8516	Needle Bar Lever Connecting Rod Guide.....
171f	8512	“ “ “ “ “ “ “ Screw.....
64848	8512	Needle Bar Lever Connecting Rod Oil Cup.....
64849	8504	Needle Bar Lever Hinge Stud.....

NO.	PLATE	NAME
64836	8515	Needle Bar Lever Hinge Stud Collar with two 1259c.....
1259c	8515	Needle Bar Lever Hinge Stud Collar Set Screw.....
1036c	8507	Needle Bar Lever Hinge Stud Set Screw..
64850	8515	" " Washer.....
50165F	8515	" " " Screw.....
1728c	8515	" Clamping Nut.....
64937	8516	Plait Guide (lower).....
32237	8516	" " (upper).....
32238	8516	" " " Holder with 54705...
32262	8519	" " " Friction Washer....
89J	8516	" " " Hinge Screw.....
32239	8516	" " " Lock Stud.....
32240	8516	" " " " " Spring
50117E	8516	" " " " " " Screw.....
208E	8507	Plait Guide (upper) Screw.....
54705	8516	" " " Steady Pin.....
64938	---	Plait Guide complete, Nos. 89J, 208E, 32237 to 32240, 32262, 50117E and 64937
64888	8516	Plait Guide Block.....
1485J	8516	" " " Screw.....
64907	8516	" " Braid Retaining Finger.....
64929	8516	" " " " " Cushion Spring.....
101J	8516	Plait Guide Braid Retaining Finger Screw.....
64908	8516	Plait Guide Braid Retaining Finger Spring.....
19020	8512	Plait Guide Friction Washer.....
19055	8516	" " Regulating Pinion.....
1004F	8516	" " " " " Screw....
1005F	8516	" " " Screw.....
64892	---	" " (stationary) Nos. 32244 and 64893.....
64893	8516	Plait Guide (stationary) Bracket with 735c.....
32244	8516	Plait Guide (stationary) Rod.....
735c	8516	" " " " " Set Screw..
32170	8517	Presser Bar.....
64909	8517	" " Guide Bracket with 1454F, 1700J, 50203F and 50364c.....
50203F	8515	Presser Bar Guide Bracket Adjusting Screw.....
1454F	8517	Presser Bar Guide Bracket Clamping Screw.....

NO.	PLATE	NAME
42007	8517	Presser Bar Guide Bracket Guide.....
457C	8517	" " " " " Set Screw
32171	8517	" " Lifter.....
32235	8517	" " " Hinge Stud.....
452c	8507	" " " " " Set Screw..
51807	8517	" " Roller and Screw Stud.....
64853	8504	" " Spring (flat).....
54722	8517	" " " Pin.....
32175	8517	" " " Stud.....
64910	8517	" " Tipper.....
50364c	8517	" " " Adjusting Screw....
1700J	8517	" " " " " Nut..
64911	8517	" " " Hinge Stud.....
691D	8517	" " " " " Screw....
64912	8517	" " " Retaining Spring....
50470D	8517	" " " " " Screw
704D	8517	" Foot Adjusting Screw.....
32210	8517	" " " " " Washer....
64913	8513	" " Plate.....
32212	8513	" " Shank.....
64914	---	Presser Foot (adjustable) complete, Nos. 704D, 32210, 32212 and 64913.....
704D	8517	Presser Foot Adjusting Screw.....
32210	8517	" " " " " Washer....
64924	8513	" " Plate.....
32212	8513	" " Shank.....
64925	---	Presser Foot (adjustable) complete, for narrow braid, Nos. 704D, 32210, 32212 and 64924.....
50161c	8517	Presser Foot Screw.....
19047	8517	" " " Washer.....
50132D	8507	Pressure Regulating Thumb Screw.....
1543D	8507	" " " " " Lock Nut.....
2102	8517	Tension Disc.....
64933	8517	" Regulating Plate and Thread Eyelet.....
1560c	8518	Tension Regulating Thumb Nut.....
64934	8517	" Regulator.....
64935	8517	" " Friction Spring.....
50261c	8518	" Screw Stud.....
54738	8518	" Spring.....
19068	8518	Thread Controller Bracket.....
330b	8507	" " " Screw.....
64941	8518	" " Guide Plate with 19070
19070	8518	" " " " Stud.....
64856	8504	" " Releasing Rod.....

NO.	PLATE	NAME
59042	851S	Thread Controller Spring.....
22430	851S	“ Eyelet (top of arm).....
64943	852I	“ Eyelet.....
50090b	851S	“ “ Set Screw.....
64915	8513	Throat Plate (back) with 39272, for 64904, 64928 and 64936.....
1319F	8507	Throat Plate (back) Screw.....
64916	8513	“ “ (front) with two 39272, for 64904, 64928 and 64936.....
64917	—	Throat Plate (front) 64916 with 240J, 64922 and 64923.....
64918	—	Throat Plate (front) 64917 with 111J, 1240c, 64905 and 64906.....
997D	8512	Throat Plate (front) Screw.....
64919	8513	“ “ Needle Hole Strip.....
64899	851S	“ “ “ “ “ Guide ...
64920	851S	“ “ “ “ “ “ 64899 with 64921 and two 8505.....
64921	851S	Throat Plate Needle Hole Strip Guide Extension.....
8505	851S	Throat Plate Needle Hole Strip Guide Extension Rivet.....
1094F	851S	Throat Plate Needle Hole Strip Guide Screw.....
193F	851S	Throat Plate Needle Hole Strip Screw...
64922	851S	“ “ Braid Dividing Finger (.015 in. thick).....
64944	—	Throat Plate Braid Dividing Finger (.025 in. thick).....
64923	851S	Throat Plate Braid Dividing Finger Hinge Spring.....
240J	851S	Throat Plate Braid Dividing Finger Hinge Spring Screw.....
39272	851S	Throat Plate Position Pin.....

IRON BASE

NO.	PLATE	NAME
64902	8522	Machine Base with three wood screws 1½ in. No. 12 and four each 935E and 4208S.....
4208S	851S	Machine Cushion (felt).....
935E	8507	“ “ Screw.....

ACCESSORIES

NO.	PLATE	NAME
1408E	8519	Machine Thumb Screw.....
14063	8519	“ “ “ Spring.....
9842	8507	“ “ “ Washer.....
120344	8520	Oiler (copper-plated) with 120345.....
120345	8520	“ Spout, 5 in. long.....
26151	8520	Screw Driver (large).....
26485	8520	“ “ (small).....
8908	8520	Wrench for 1520.....
19079	8520	“ “ 1728.....

FOOT LIFTER PARTS

NO.	PLATE	NAME
6439	—	Chain, 36 in. to 45 in., with 56864 and 56865.....

NOTE: When ordering No. 6439 give length required.

4879	8521	Chain Connecting Link.....
56864	8518	“ Hook (large).....
56865	8507	“ “ (small).....
64865	8504	Lifting Lever.....
788D	8507	“ “ Hinge Screw.....
64930	8521	“ “ Link.....
1250c	8507	“ “ “ Guide Screw.....
1184D	8507	“ “ “ Hinge Screw.....
19081	8507	“ “ Spring.....
59051	8522	Treadle.....
7585	8521	“ Shaft.....
14210	8522	“ Stand.....
59052	8522	Treadle complete, Nos. 4879, 7585, 14210, 59051 and four wood screws 1¼ in. No. 12.....
64947	—	Foot Lifter complete, Nos. 788D, 1184D, 1250c, 6439, 19081, 59052, 64865 and 64930.....

KNEE LIFTER PARTS

NO.	PLATE	NAME
59055	—	Chain, length 18 in., with two 56865.....
56865	8507	“ Hook.....
64865	8504	Lifting Lever.....
788D	8507	“ “ Hinge Screw.....

KNEE LIFTER PARTS

NO.	PLATE	NAME
64930	8521	Lifting Lever Link.....
1250c	8507	“ “ “ Guide Screw.....
1184d	8507	“ “ “ Hinge Screw.....
19081	8507	“ “ Spring.....
7124	8522	Rock Shaft.....
2764	8522	“ “ Hanger (back) with two wood screws 1 in. No. 10.....
16128	8522	Rock Shaft Hanger (front) with two wood screws 1 in. No. 10.....
16646	8522	Rock Shaft Knee Arm.....
16647	—	Rock Shaft Knee Arm complete, Nos. 2766, 2767 and 16646.....
2766	8522	Rock Shaft Knee Arm Hub with 356c... 356c 8507 “ “ “ “ “ Set Screw... 2767 8522 “ “ “ Plate with 356c..... 356c 8507 “ “ “ “ Set Screw.....
6337	8522	“ “ Lifting Bracket with two 356c
6338	8522	“ “ “ “ Hook.....
356c	8507	“ “ “ “ “ Set Screw
356c	8507	“ “ “ “ “ Set Screw....
32134	8522	Rock Shaft Spring.....
2770	8522	“ “ “ Adjusting Dog with 356c.....
356c	8507	Rock Shaft Spring Adjusting Dog Set Screw.....
2770	8522	Rock Shaft Stop Dog with 356c.....
356c	8507	“ “ “ “ “ Set Screw.....
32135	8522	Rock Shaft complete, Nos. 2764, 6337, 6338, 7124, 16128, 16647, 32134 and three 2770.....
64948	—	Knee Lifter complete, Nos. 788d, 1184d, 1250c, 19081, 32135, 59055, 64865 and 64930.....

TABLE SUPPORT PARTS

NO.	PLATE	NAME
41044	8510	Base with three wood screws 1¼ in. No. 14.....
41045	8510	Top with two wood screws 1¼ in. No. 14
41046	8510	Tube.....
1726p	8519	“ Lock Nut.....
41047	—	Table Support Tube complete, Nos. 1726p and 41044 to 41046.....

THREAD UNWINDER

FOR ONE SPOOL

NO.	PLATE	NAME
225389	8523	Spool Rest with 201018c.....
225388	8523	“ “ Rod.....
200383c	8518	“ “ “ Set Screw.....
201018c	8518	“ “ “ Set Screw.....
202490	8523	“ Stand with 200383c.....
60913	8523	“ Weight with 60914.....
60914	—	“ “ Centre Pin.....
225391	8523	Thread Guide.....
201696j	8518	“ “ Lock Nut.....
225392	8523	“ “ Rod with 208E and 225393
208E	8507	“ “ “ Screw.....
225393	8518	“ “ “ Washer.....
225394	8523	Thread Unwinder complete, Nos. 60913, 201696j, 202490, 225388, 225389, 225391, 225392 and three wood screws 7/8 in. No. 13.....
27739	7234	Thread Cone (wood) for large cones.....
225390	7234	“ “ Holder, for inverted cones..

NOTE: Nos. 27739 and 225390 are used with,
but not included in, 225394.

OBSOLETE PARTS

NO.	PLATE	NAME
64840	8515	Needle Bar Frame Guide.....
64839	8515	“ “ “ Regulator Hinge Stud
64843	8515	“ “ “ “ “ “
		Bushing.....
1984	8519	Needle Bar Frame Regulator Roller and Screw Stud.....
64868	8519	Tension Thread Guide.....
32115	8519	Thread Controller Guide Plate with 19070
64857	8519	“ Guard.....
152E	8519	“ “ Screw.....
7071	8519	“ “ “ Washer.....

NUMERICAL LIST OF PARTS

FOR

MACHINE No. 112-3

27739



225390

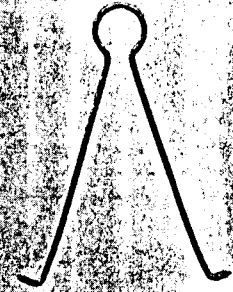

PLATE 8504—ONE-HALF SIZE

64865 64853 64837 64846 64841

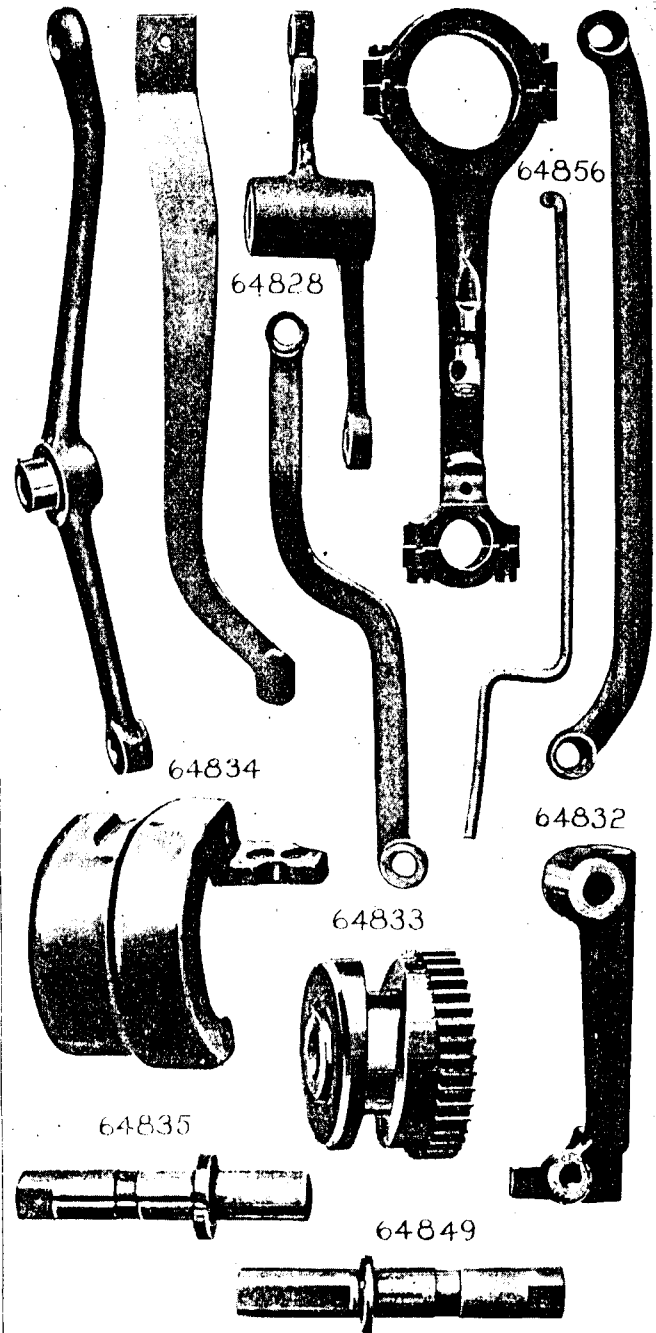

PLATE 8507—FULL SIZE

42088 9842 19081

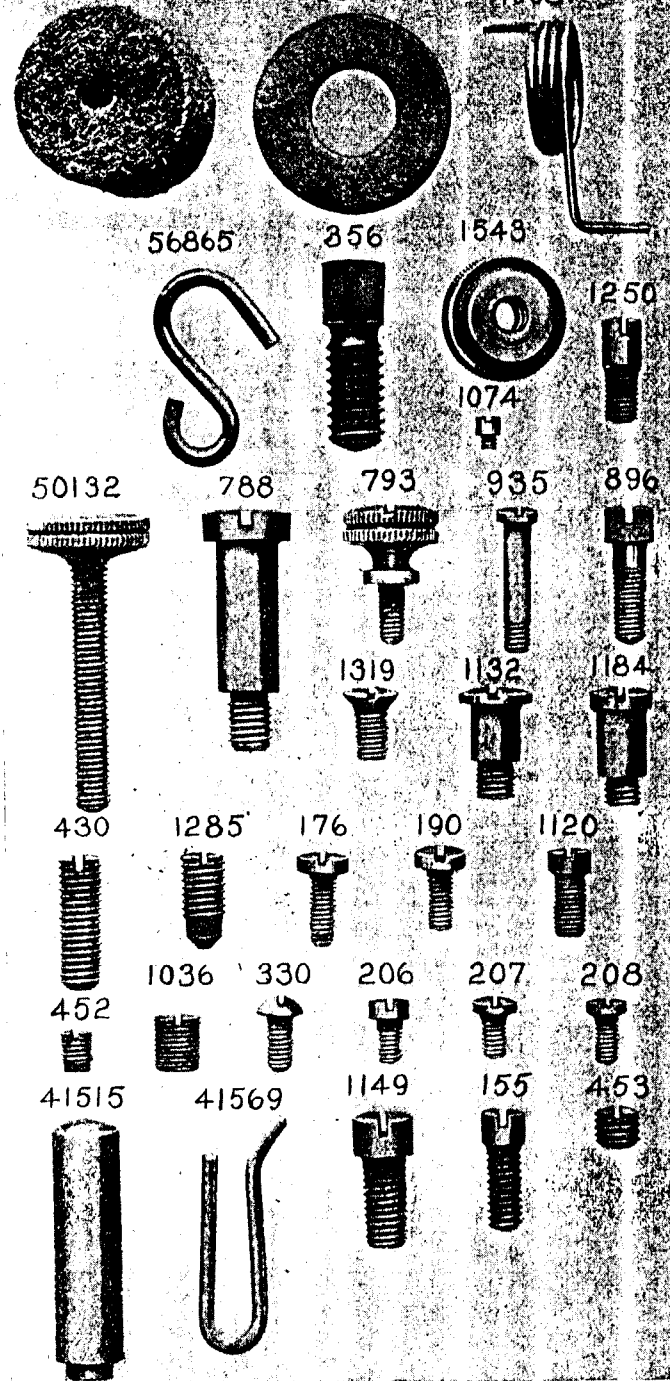
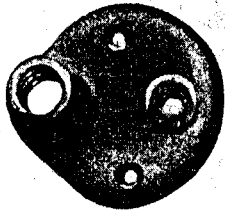

PLATE 8510—ONE-FOURTH SIZE

41046



41045



41044

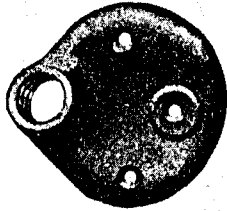

59052

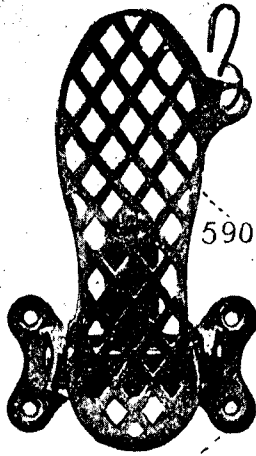

59051

14210

PLATE 8511—ONE-HALF SIZE

64802



64816



59211



34461



64931

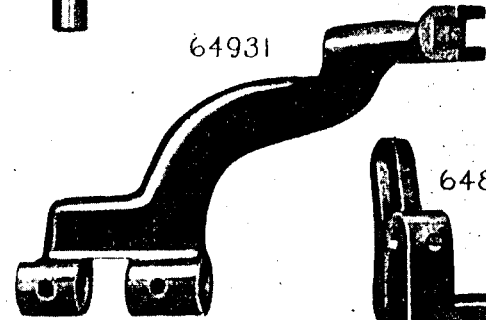

64807

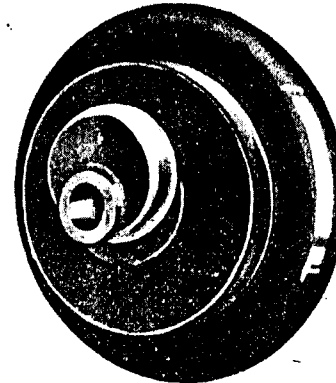

64842

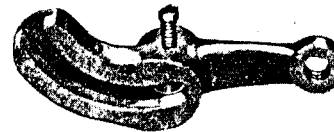

64820

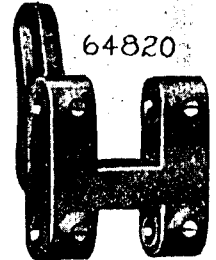

64903

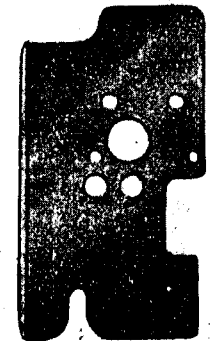

64804

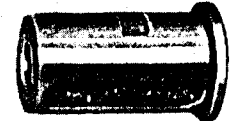

PLATE 8512—FULL SIZE

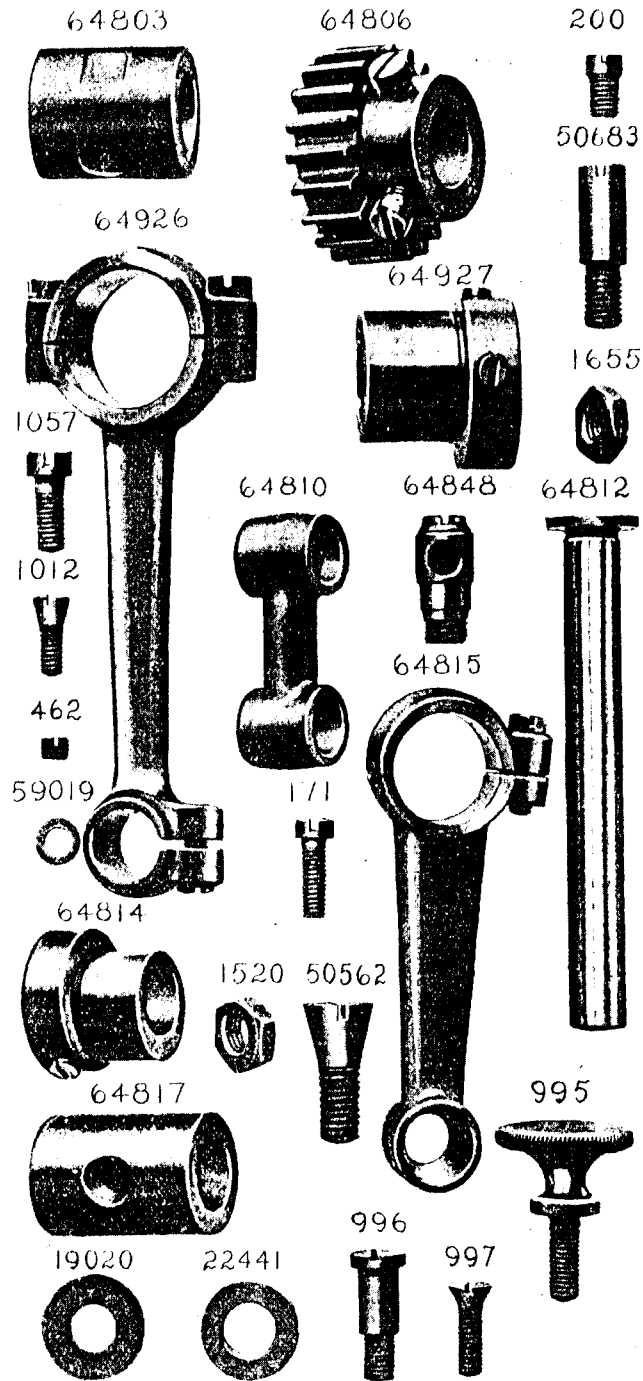

PLATE 8513—FULL SIZE

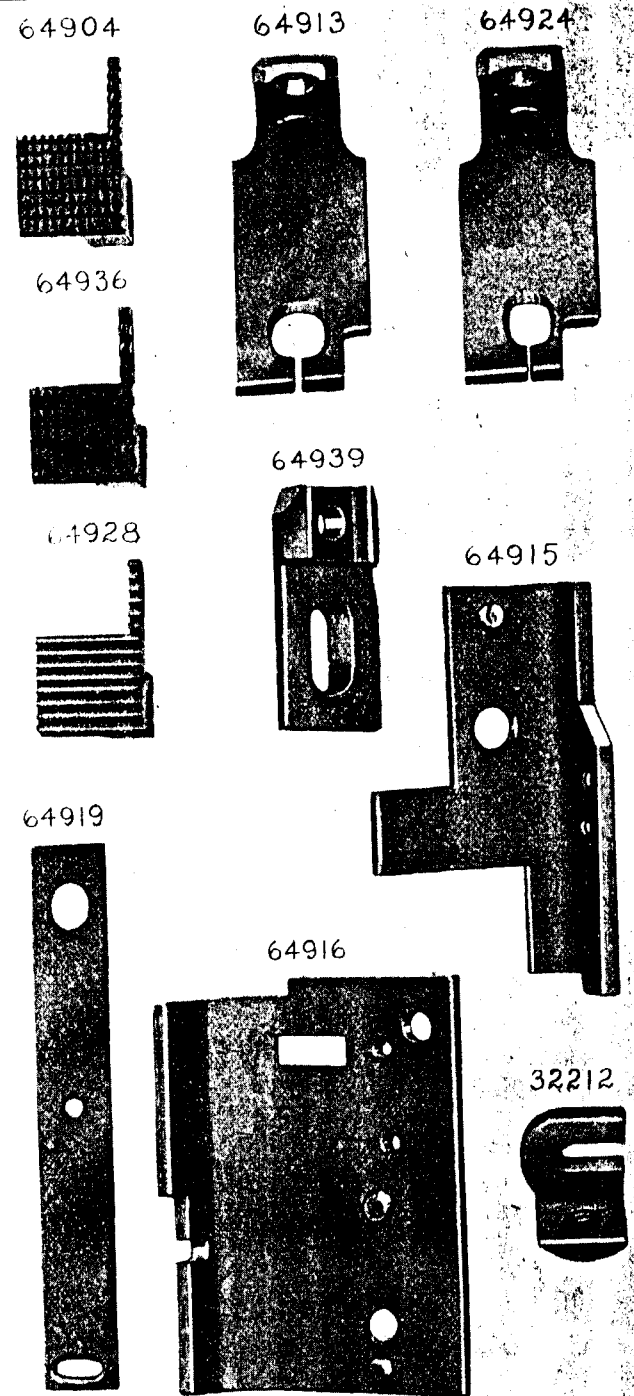

PLATE 8514—FULL SIZE

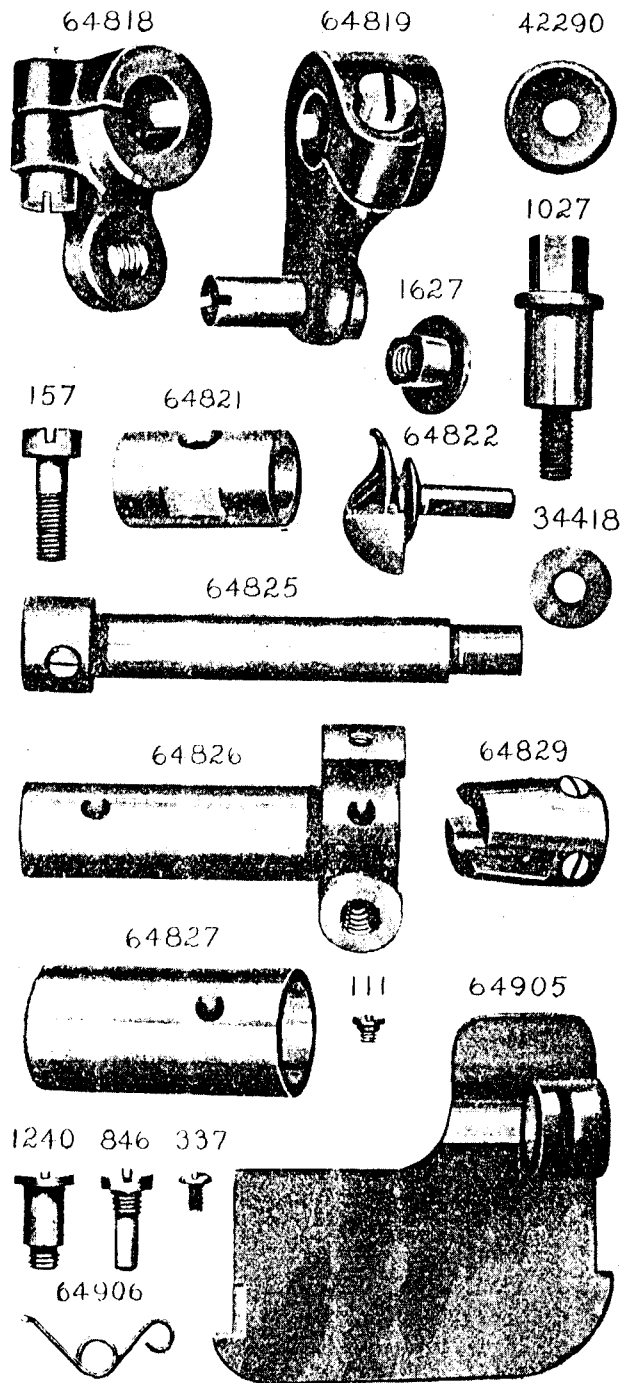

PLATE 8515—FULL SIZE

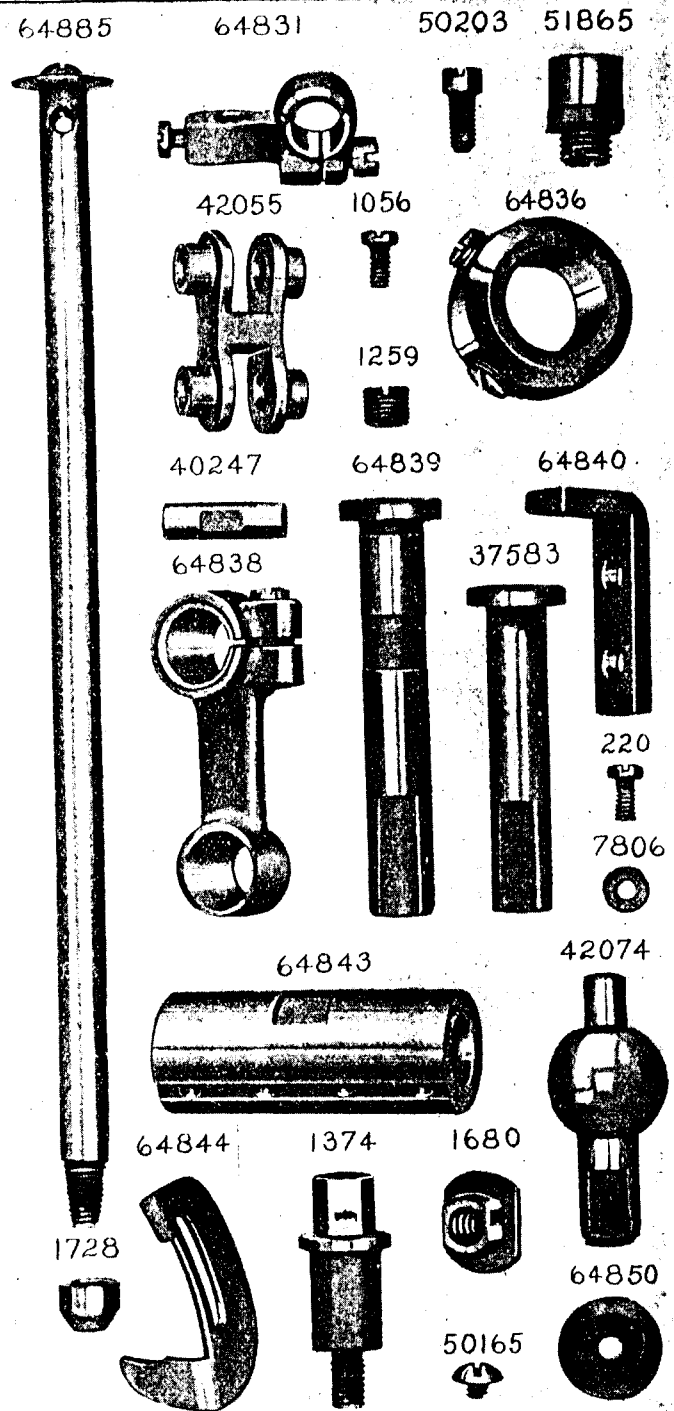

PLATE 8516-FULL SIZE

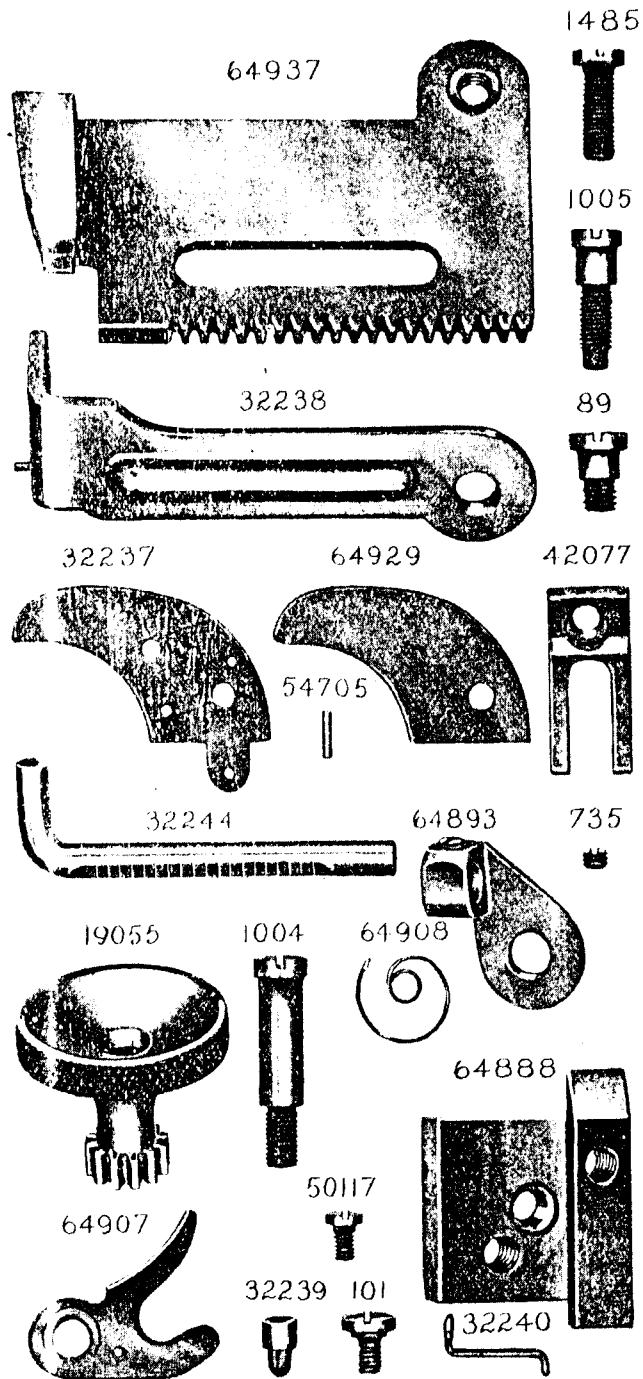

PLATE 8517-FULL SIZE

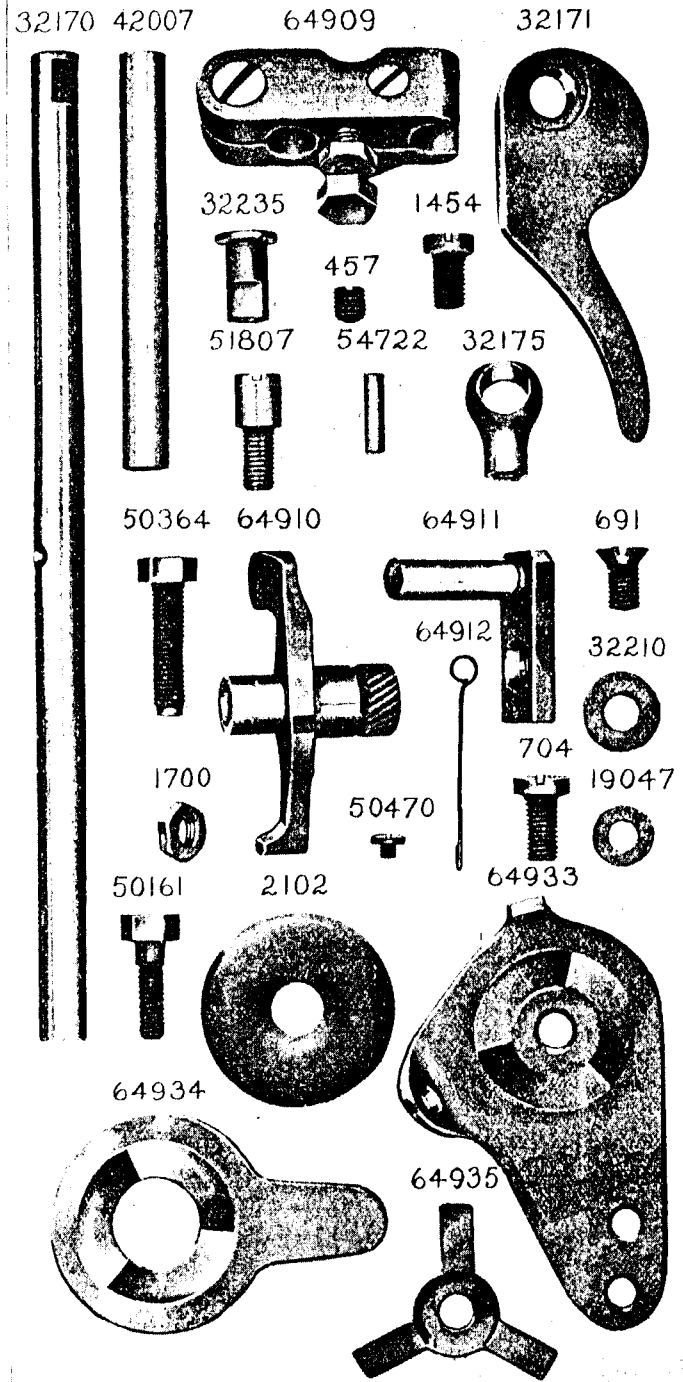

PLATE 8518—FULL SIZE

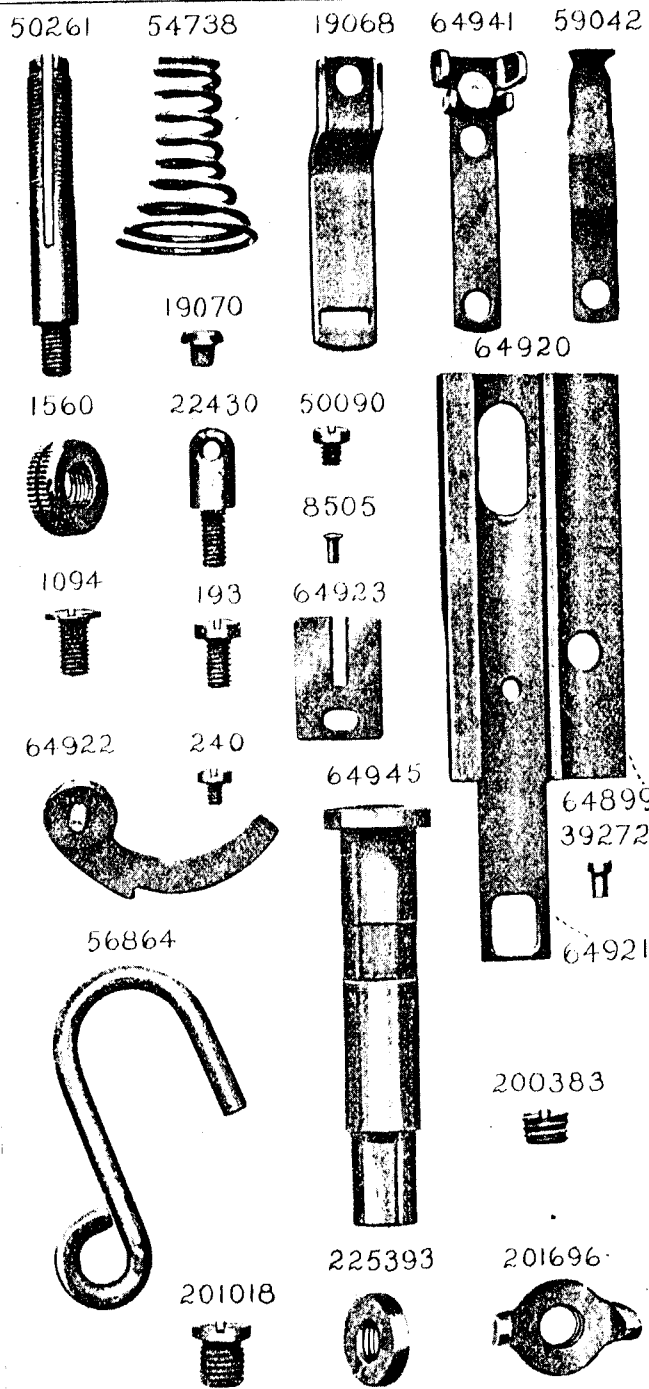

PLATE 8519—FULL SIZE

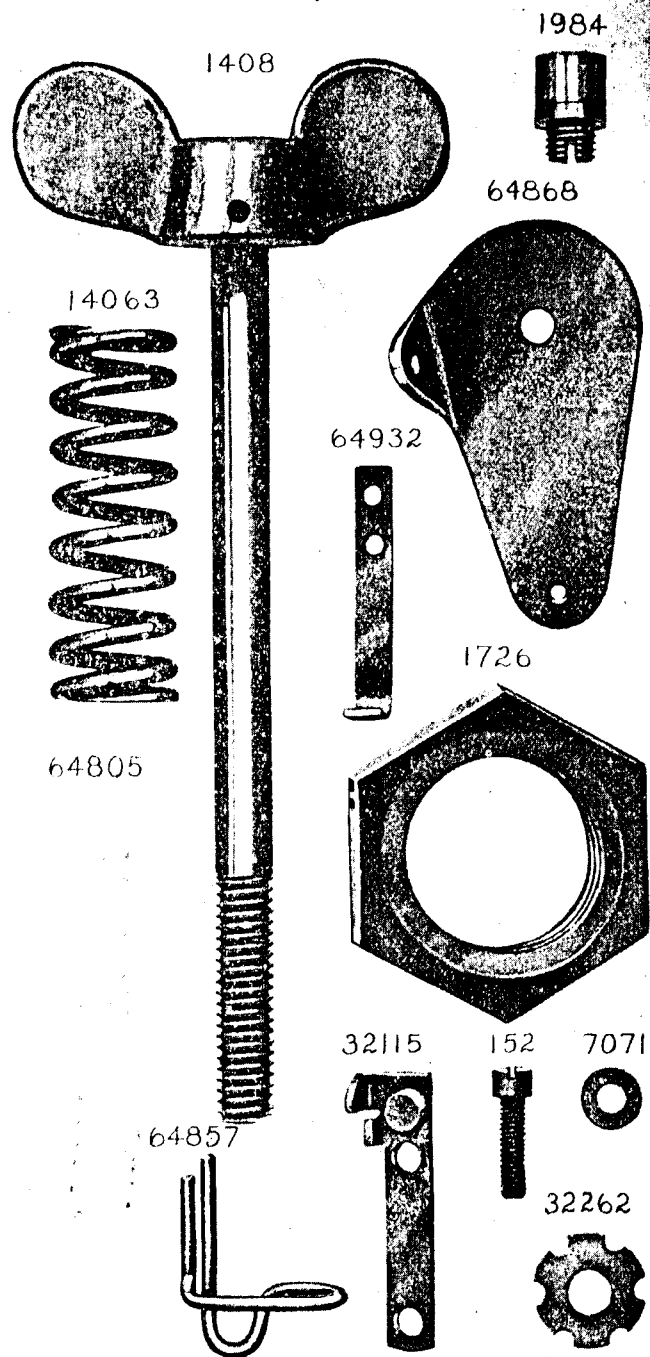
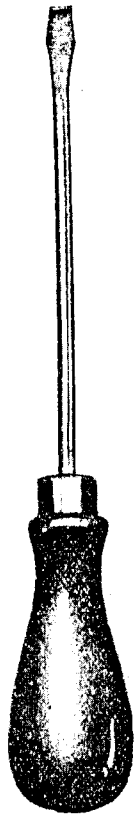

PLATE 8520—ONE-HALF SIZE

26151



8908



120344

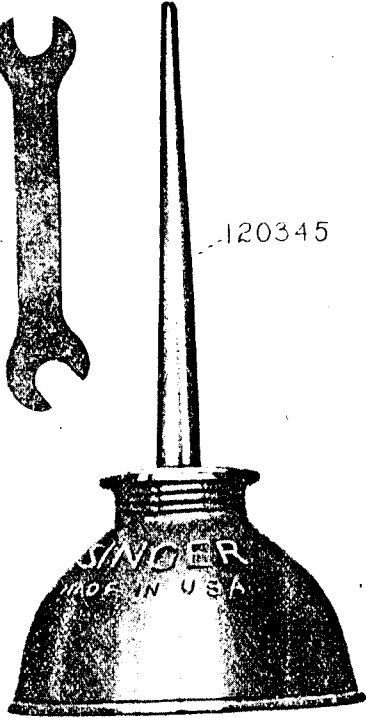

120345

26485



19079

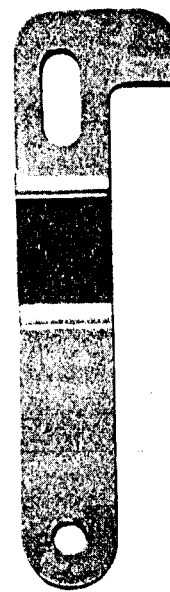

PLATE 8521—FULL SIZE

7585



64930



64946



64942



64943



4879



PLATE 8522—ONE-FOURTH SIZE

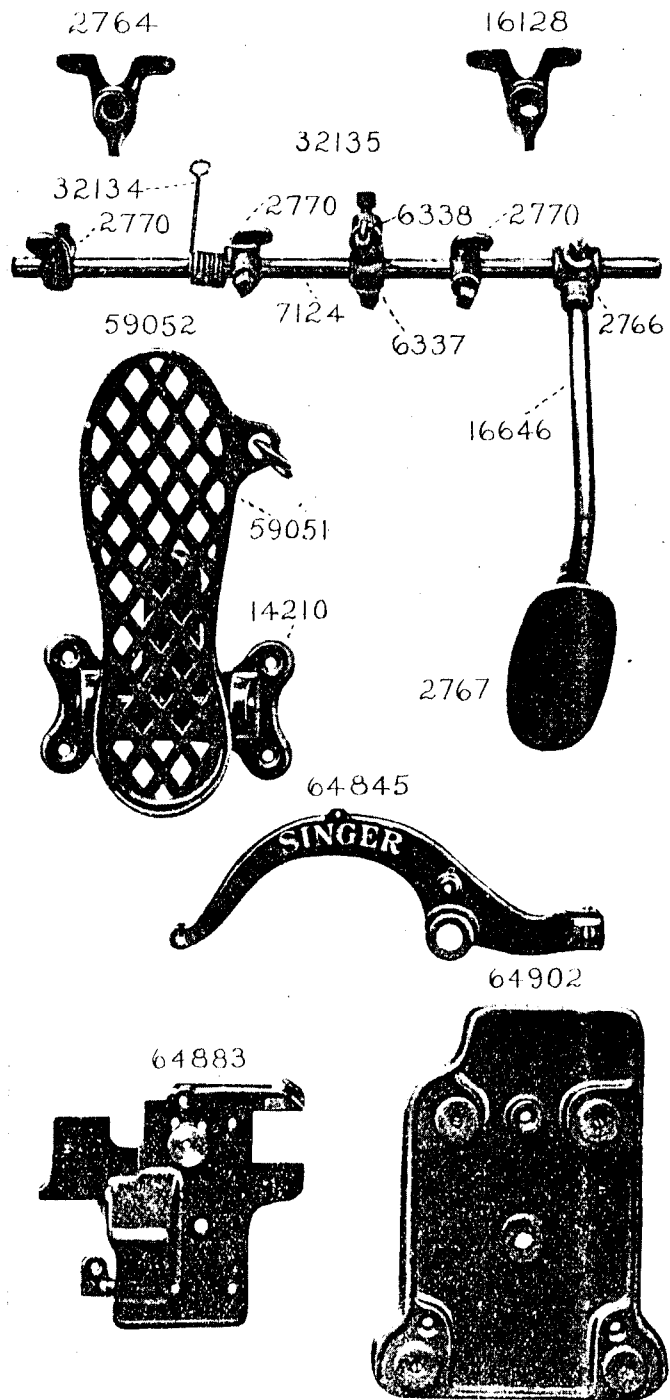

PLATE 8523—ONE-SIXTH SIZE

