

SINGER
206K10,K11,K18,K19

ILLUSTRATED LIST OF PARTS

FOR

Class 206K Machines

(Nos. 206K10, 206K11, 206K18 and 206K19)



**A Trade Mark of
THE SINGER MANUFACTURING COMPANY

32665



15282

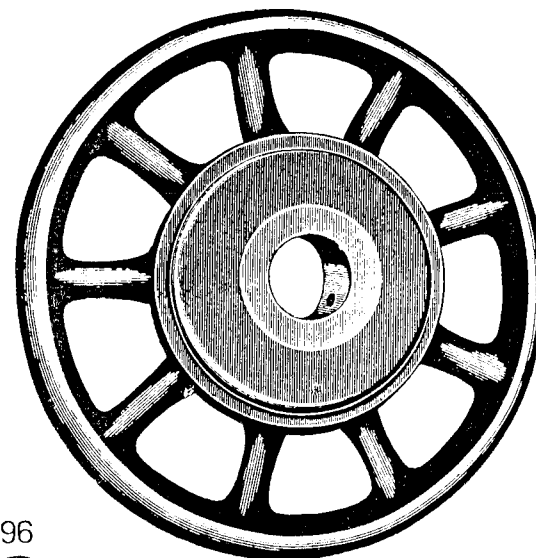

5596

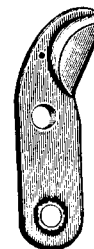

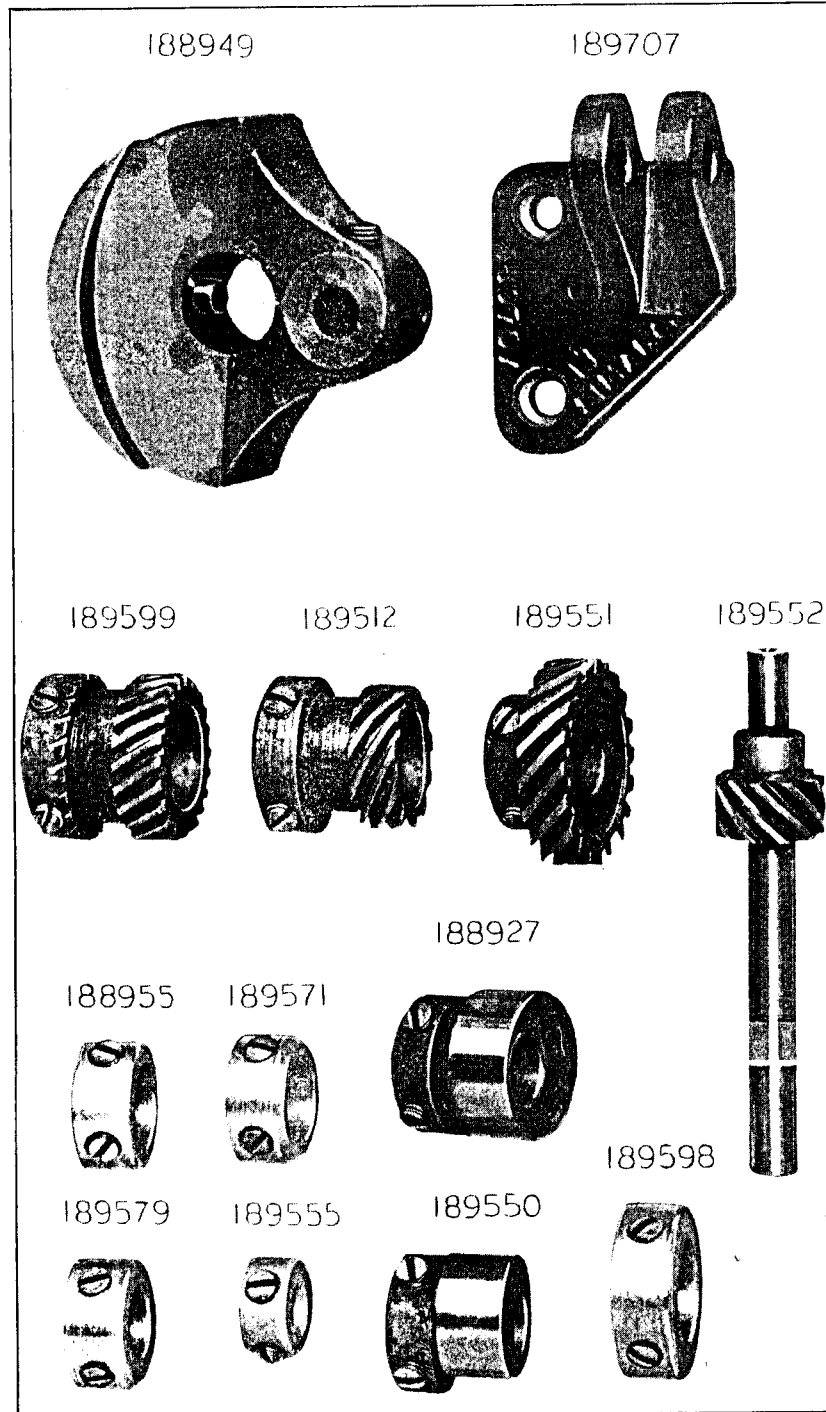
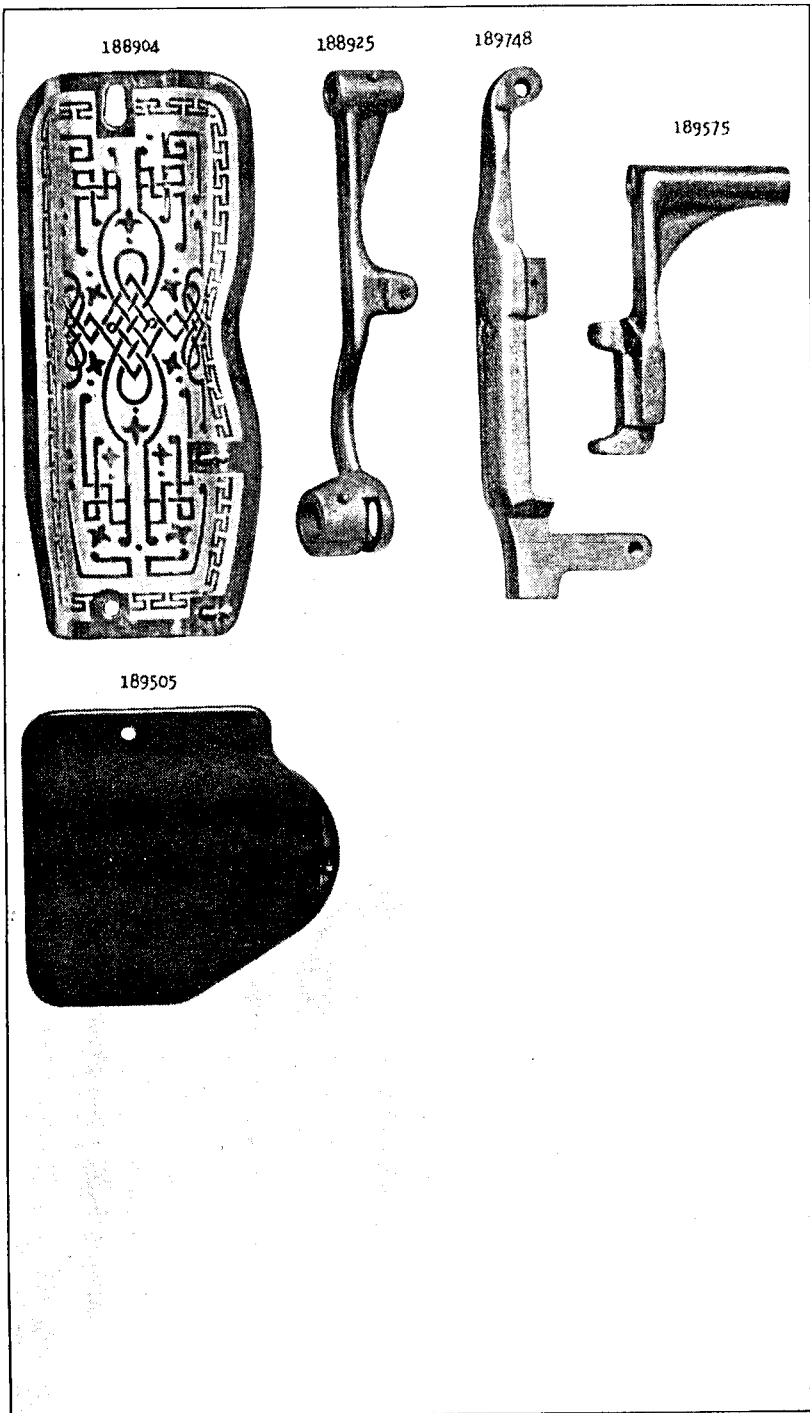

188958

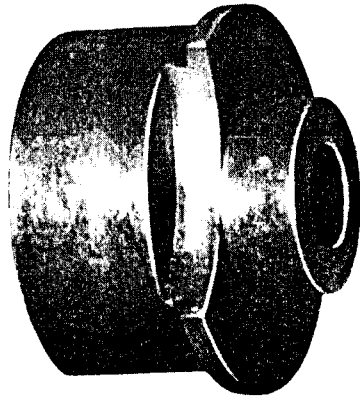

188452

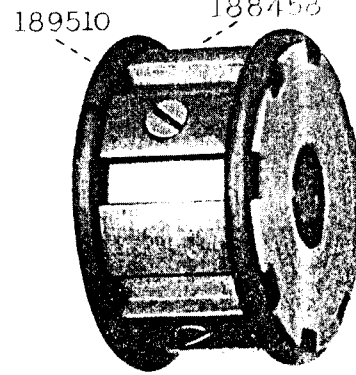

188457

189556



189507

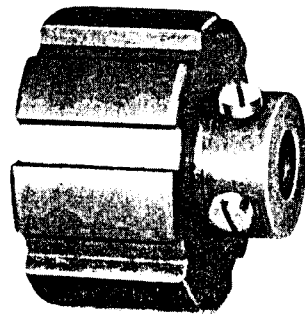

189557

SS 641

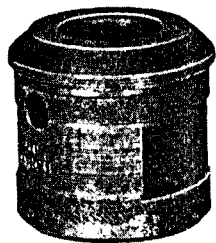

188956

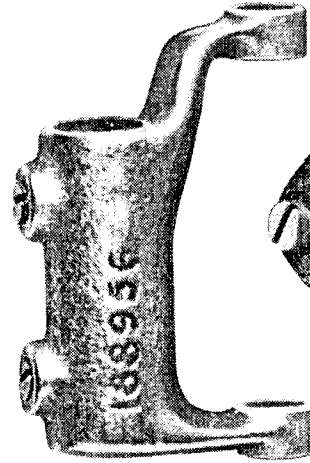

189572

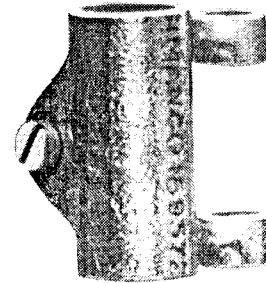

189590

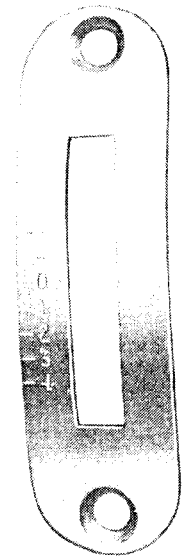

189712

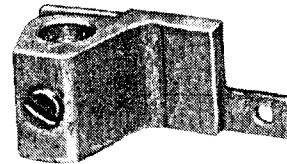

66564



189588

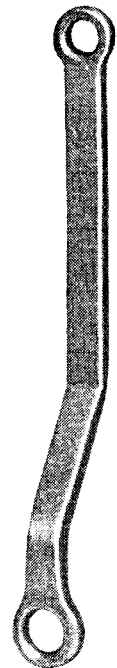

188952



189595

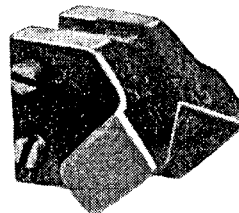

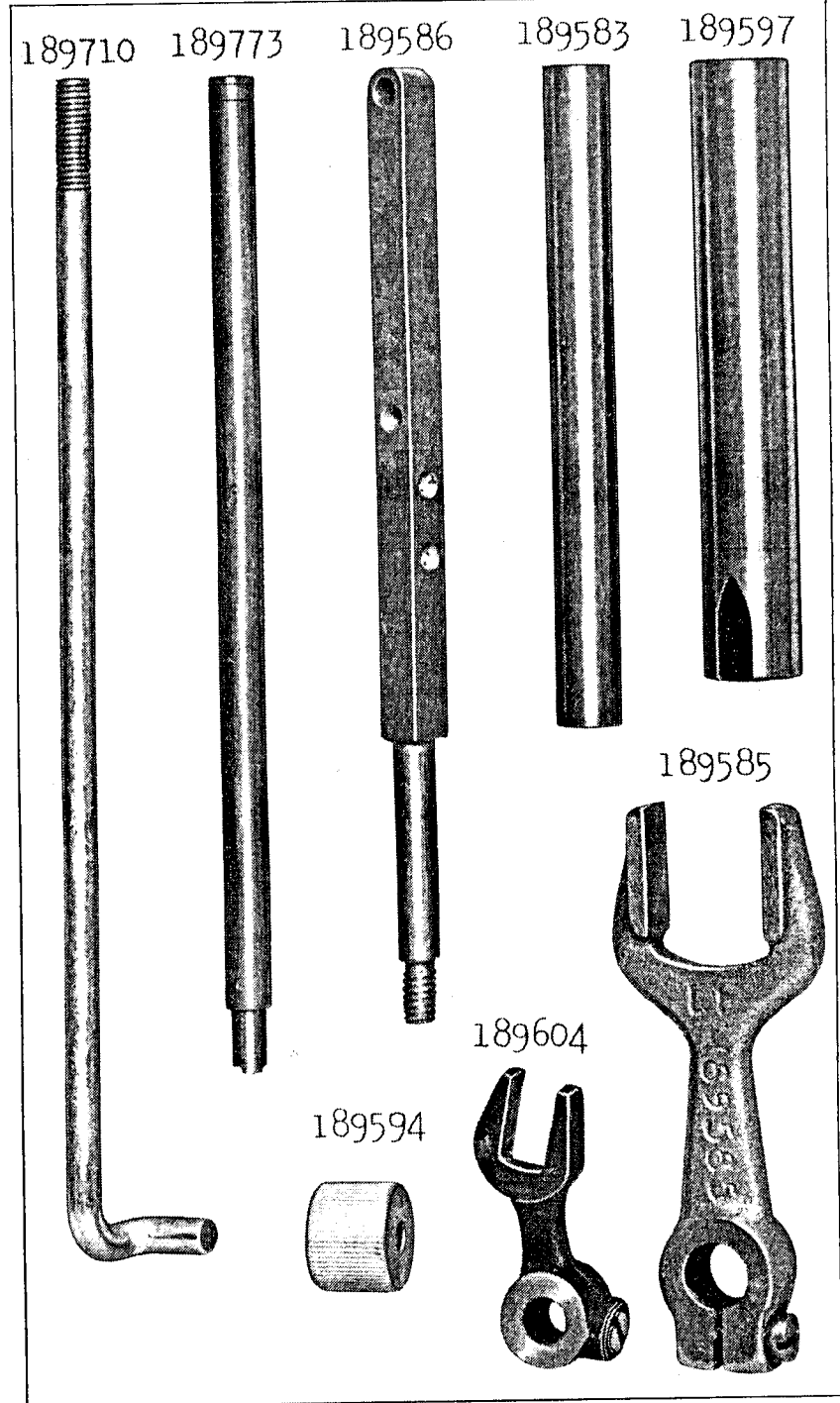
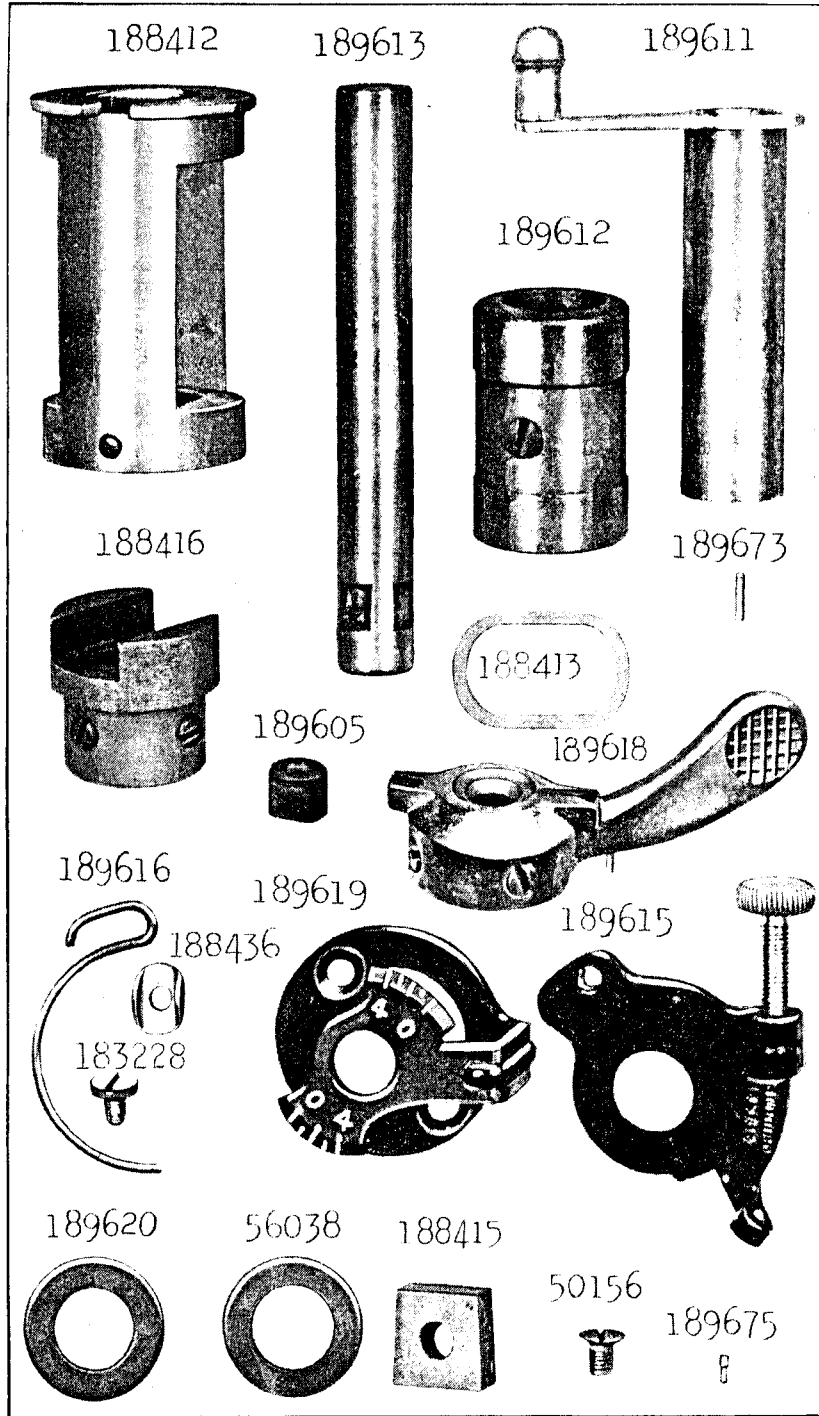

189577



189578



189547



189554



188926



189553



188455

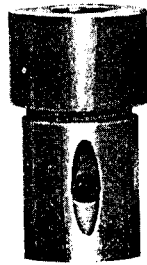

188440

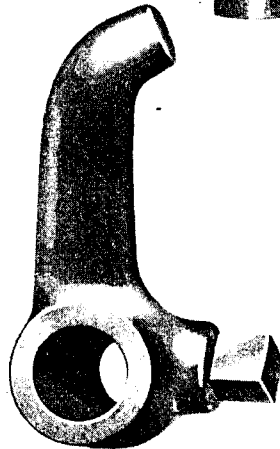

188957



189672



188997



142013

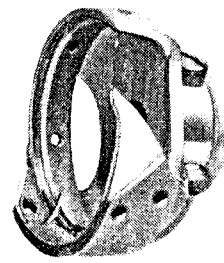

188944

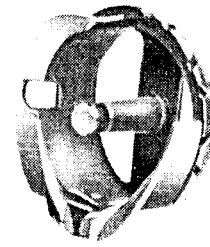

52237

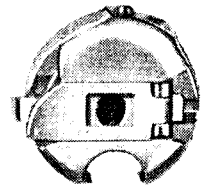

188418



40392



40394



448



183192



40274



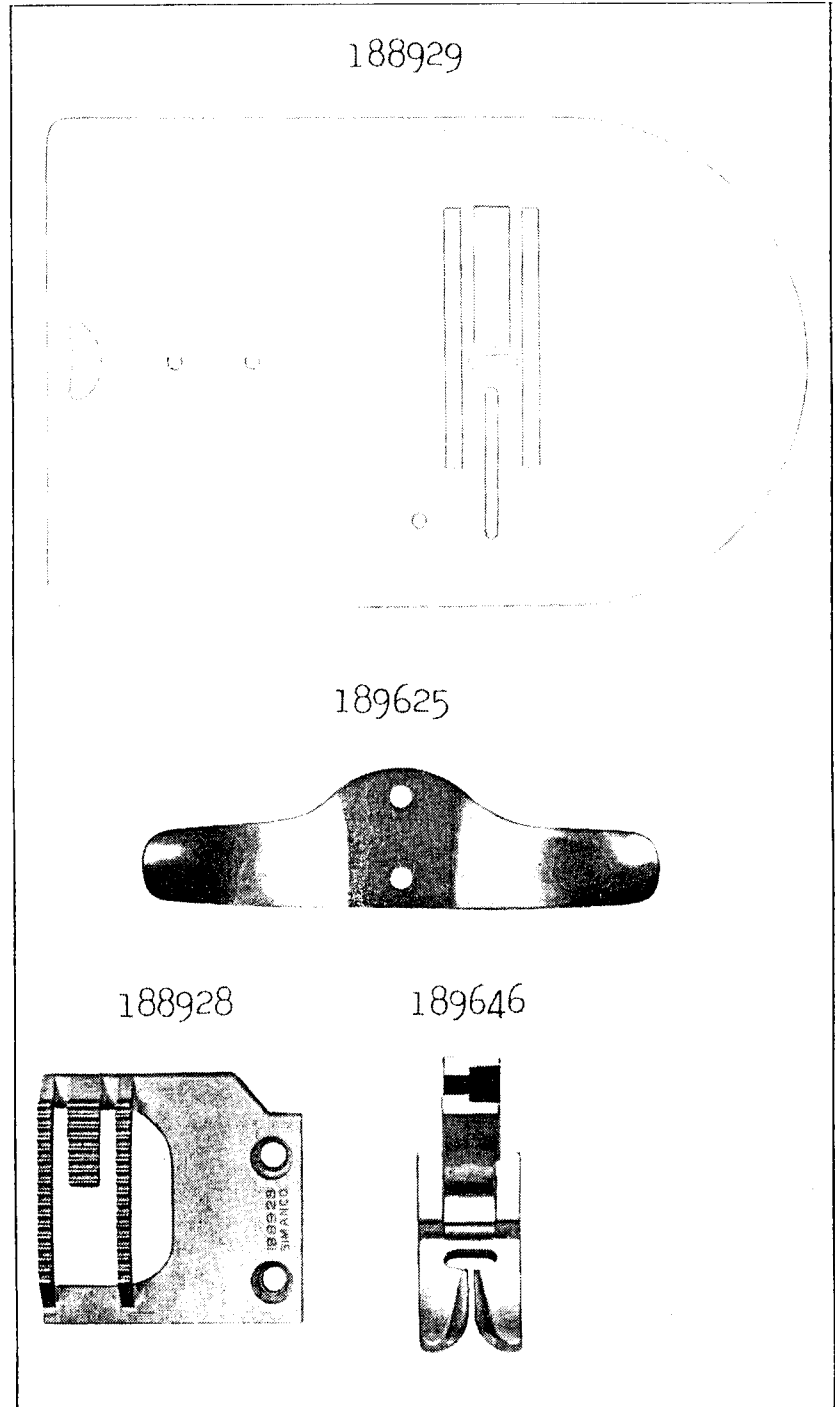
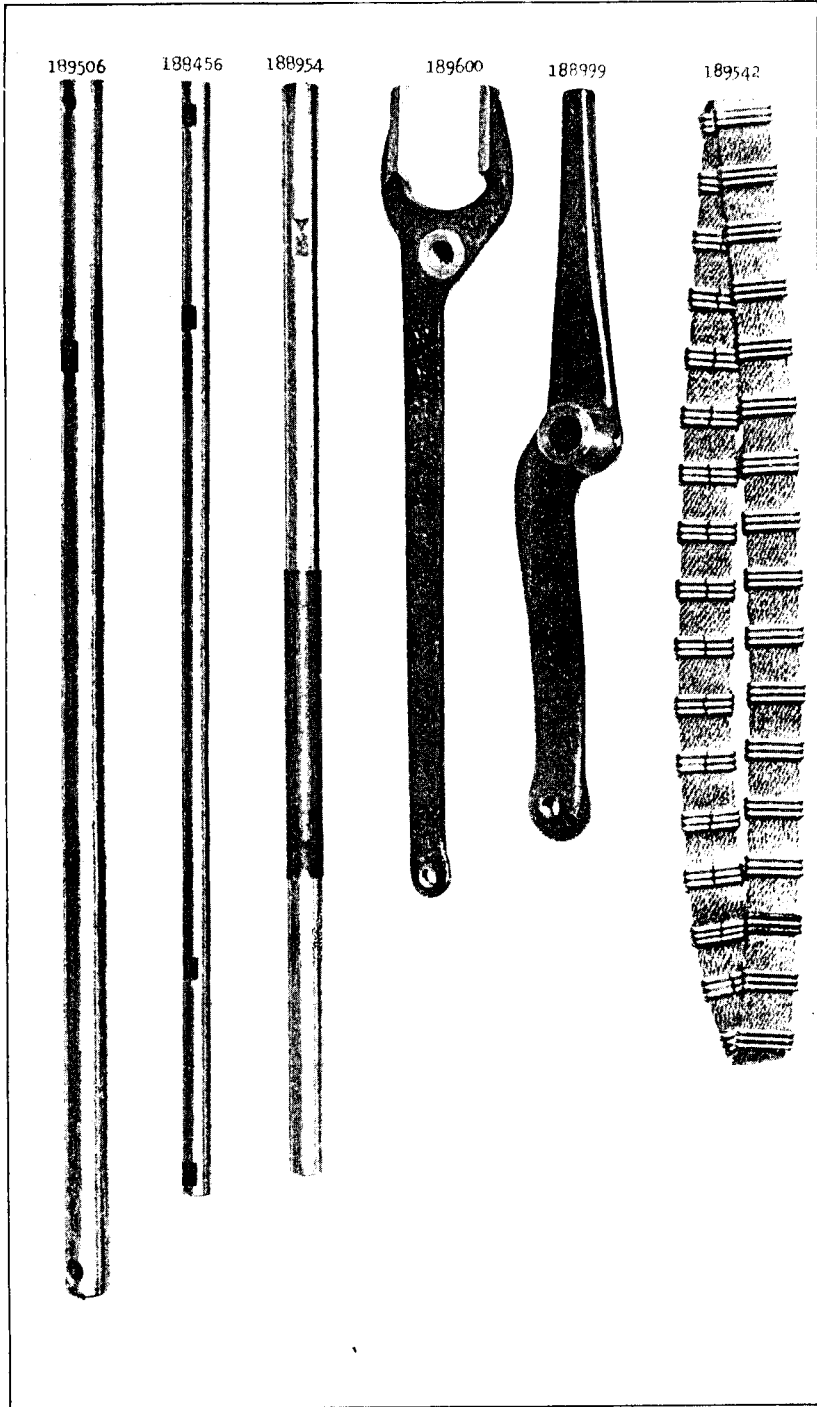

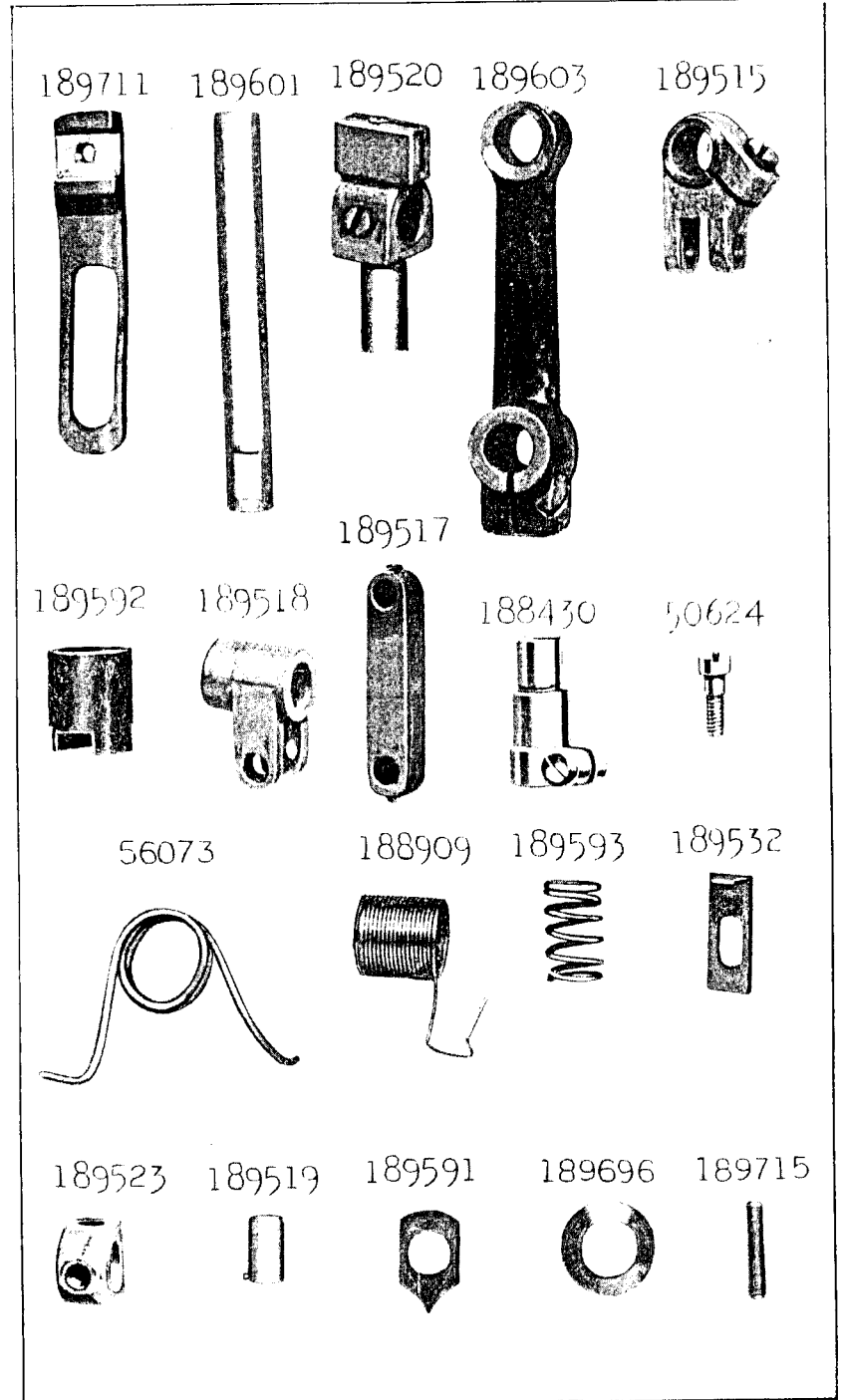
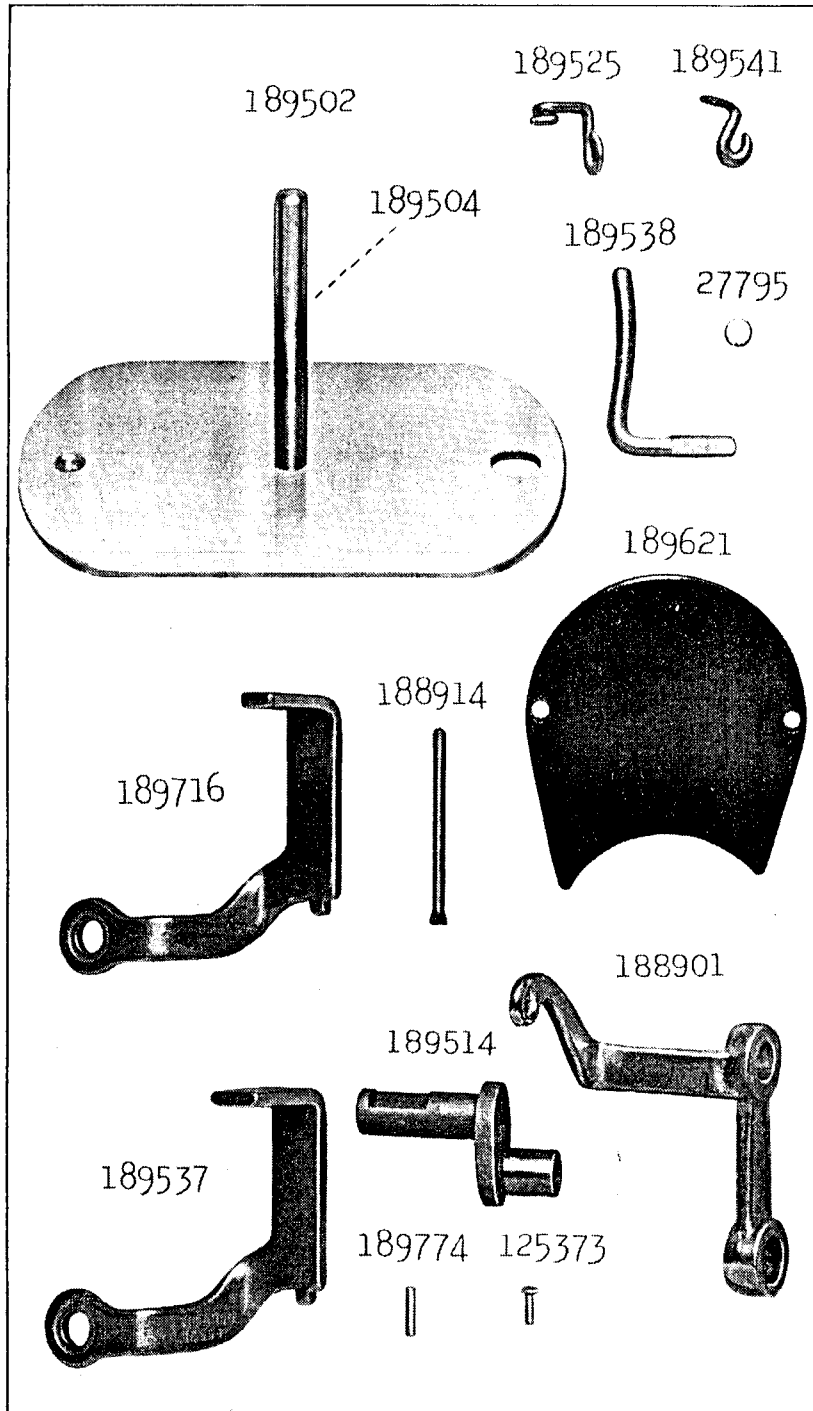

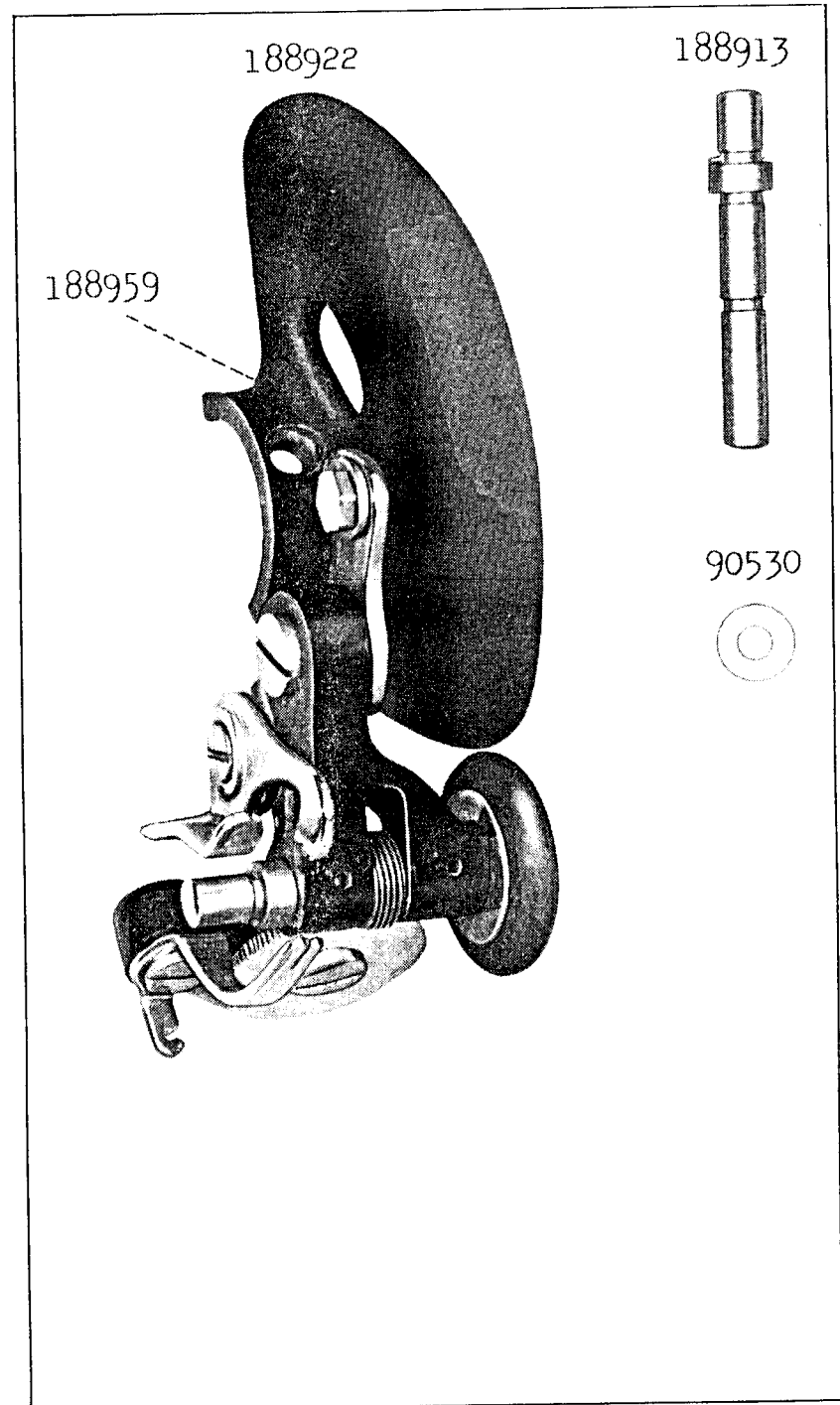
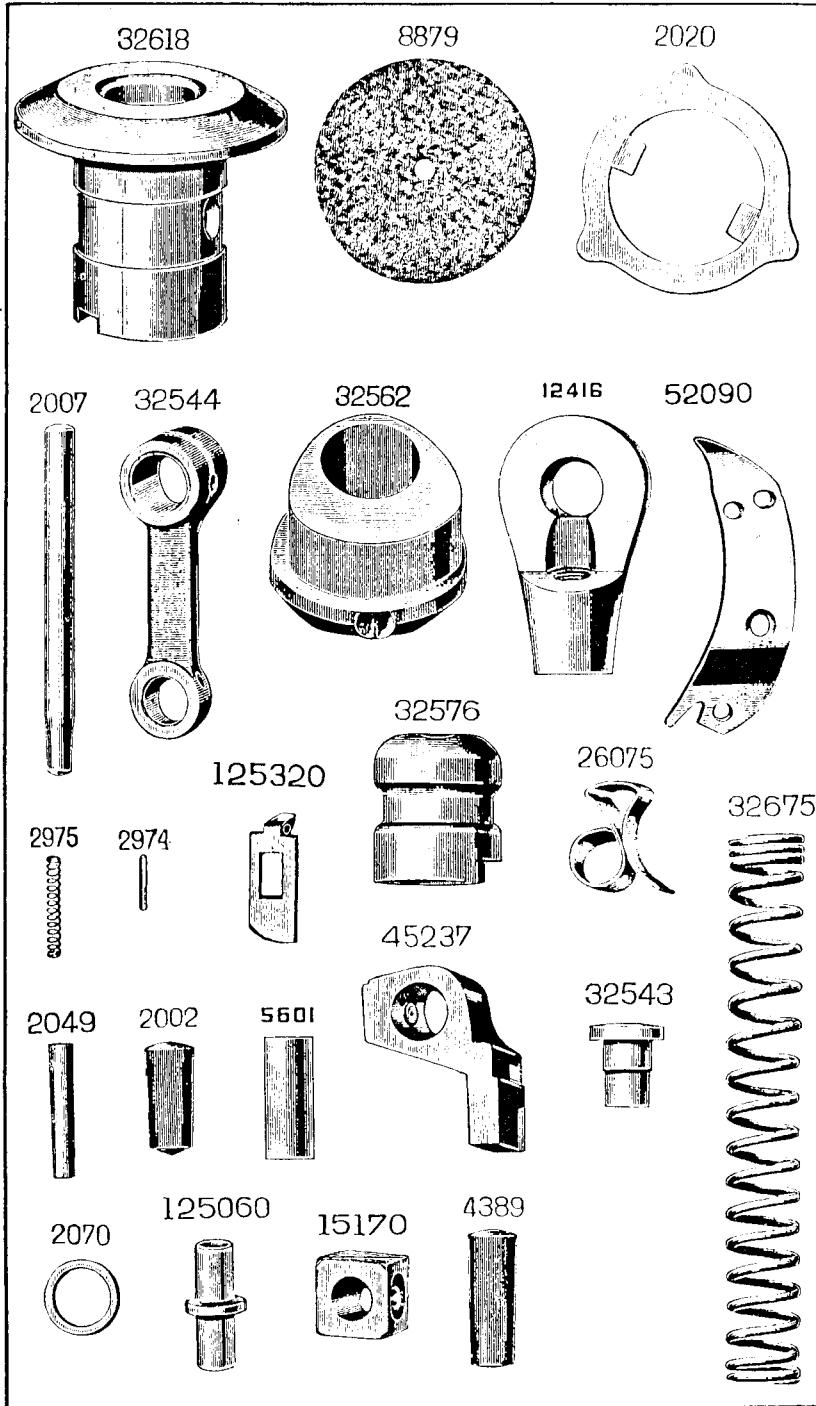

189649 189647 189650 189653 189654

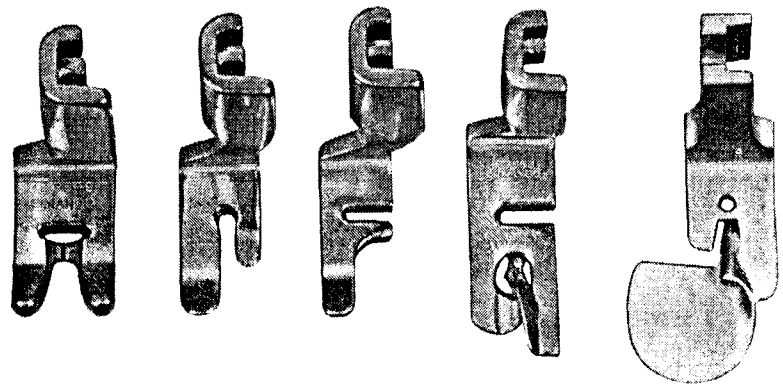

189720 86616 189648

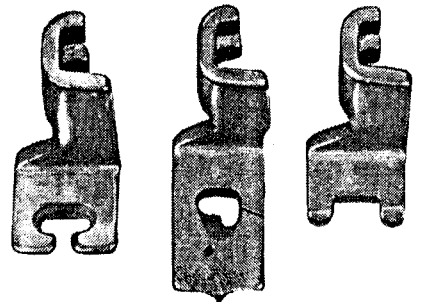

86613

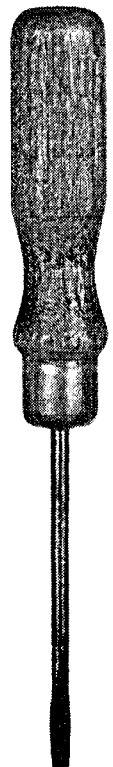

188938



189693

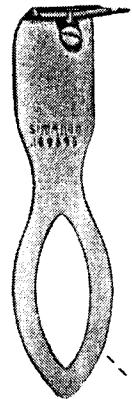

55623

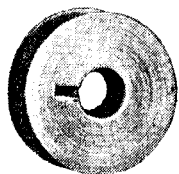

189698



50315



189794



121094

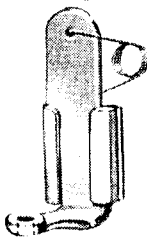

189697

96418

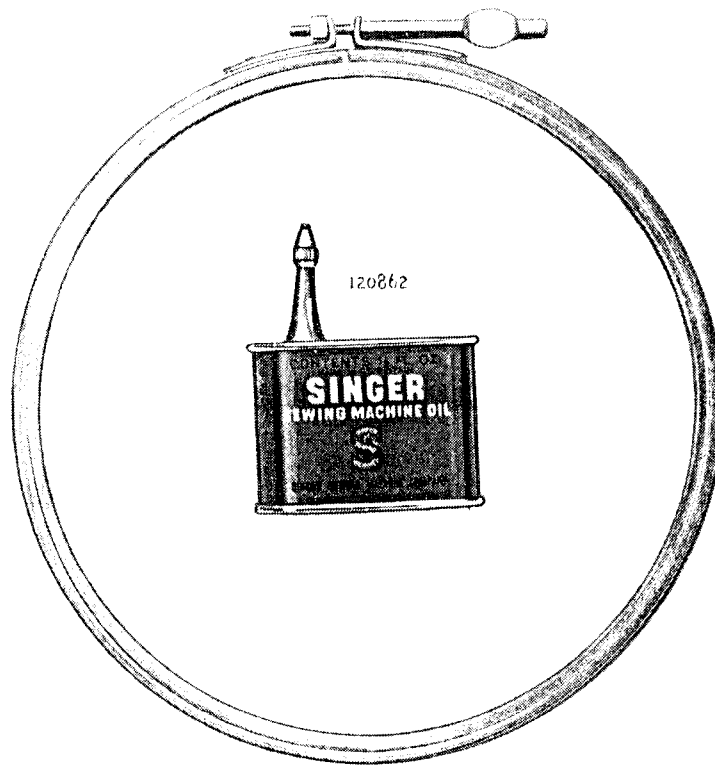

120862

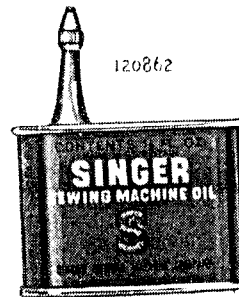

234484

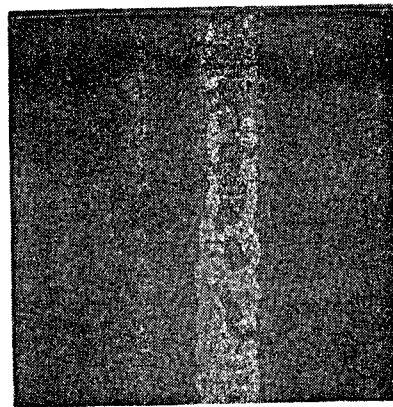

189151

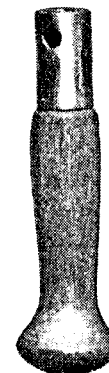

189152



188932

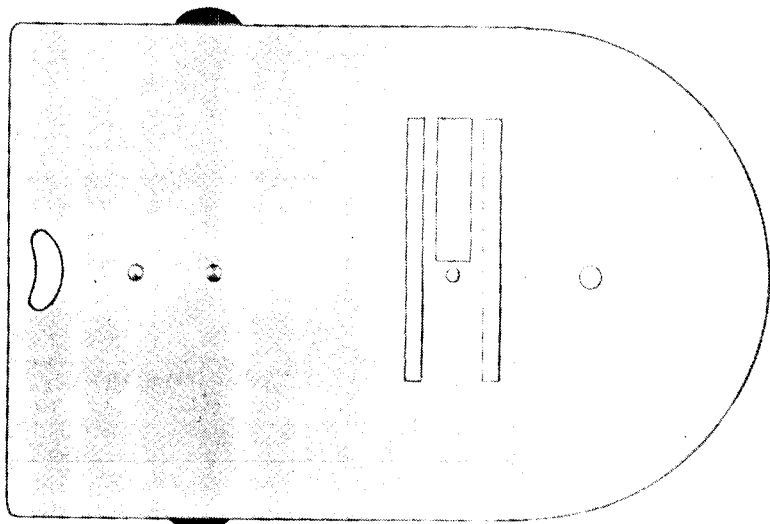

189723

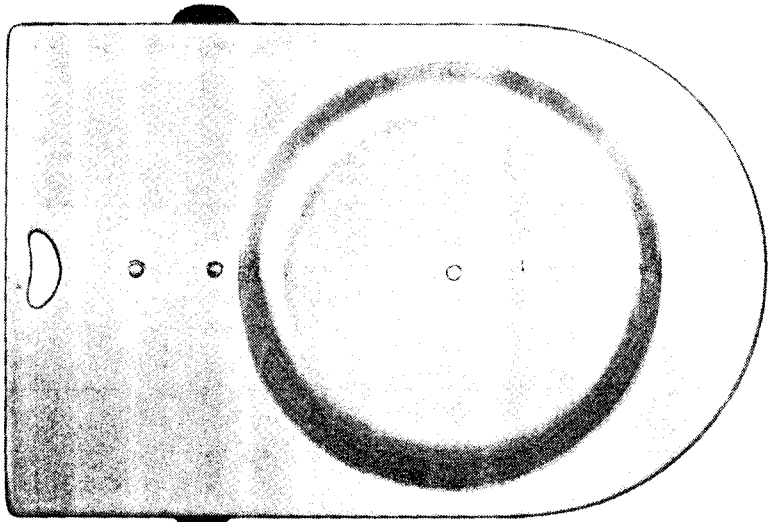

188918

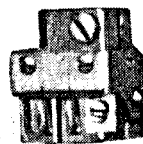

189798



189751



189752

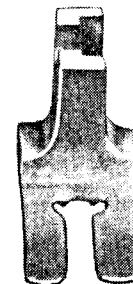

189795



189796



189797



189799

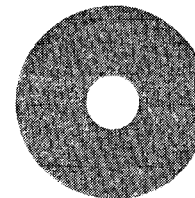

183024



189692



189651



189704



189700



189701



183097



1368 183114



109



189702



234463

234467

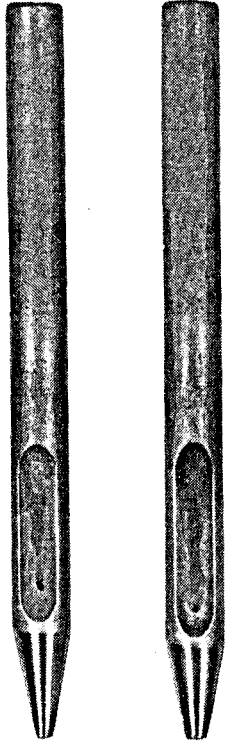

189658

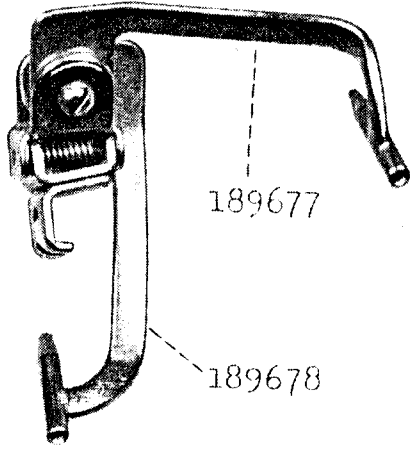

189677

189678

189663

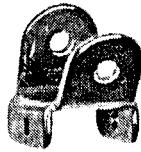

189667



189664

189665

183023

189666

1607



189632

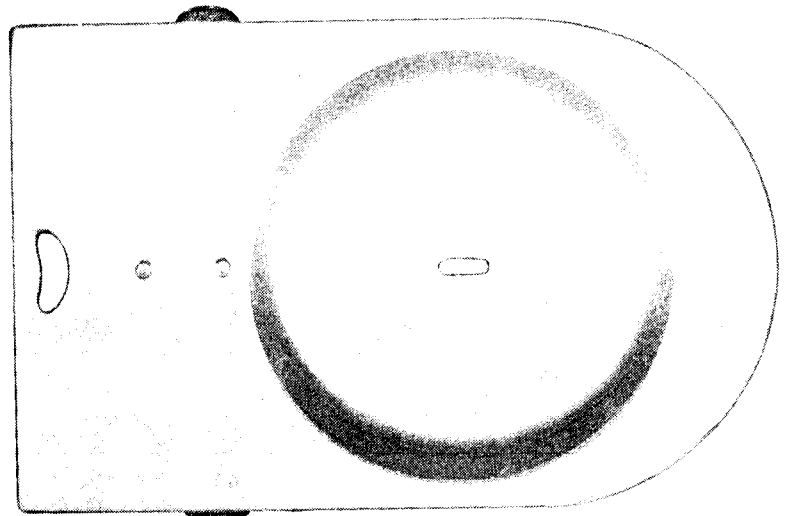

189637

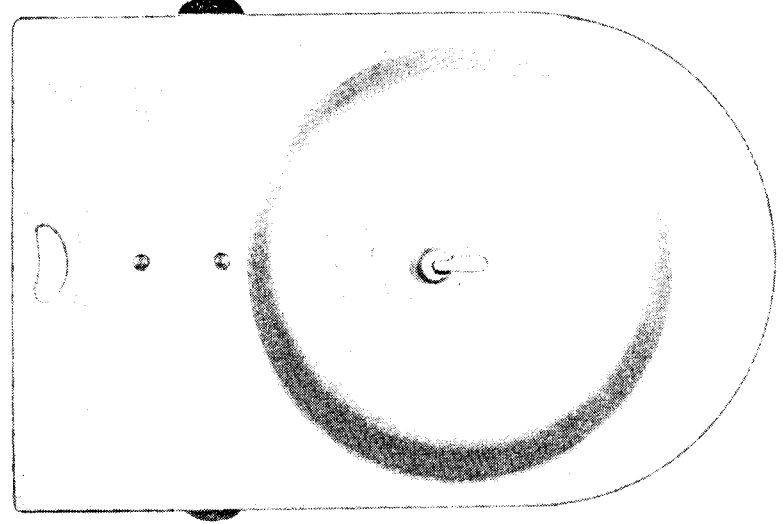

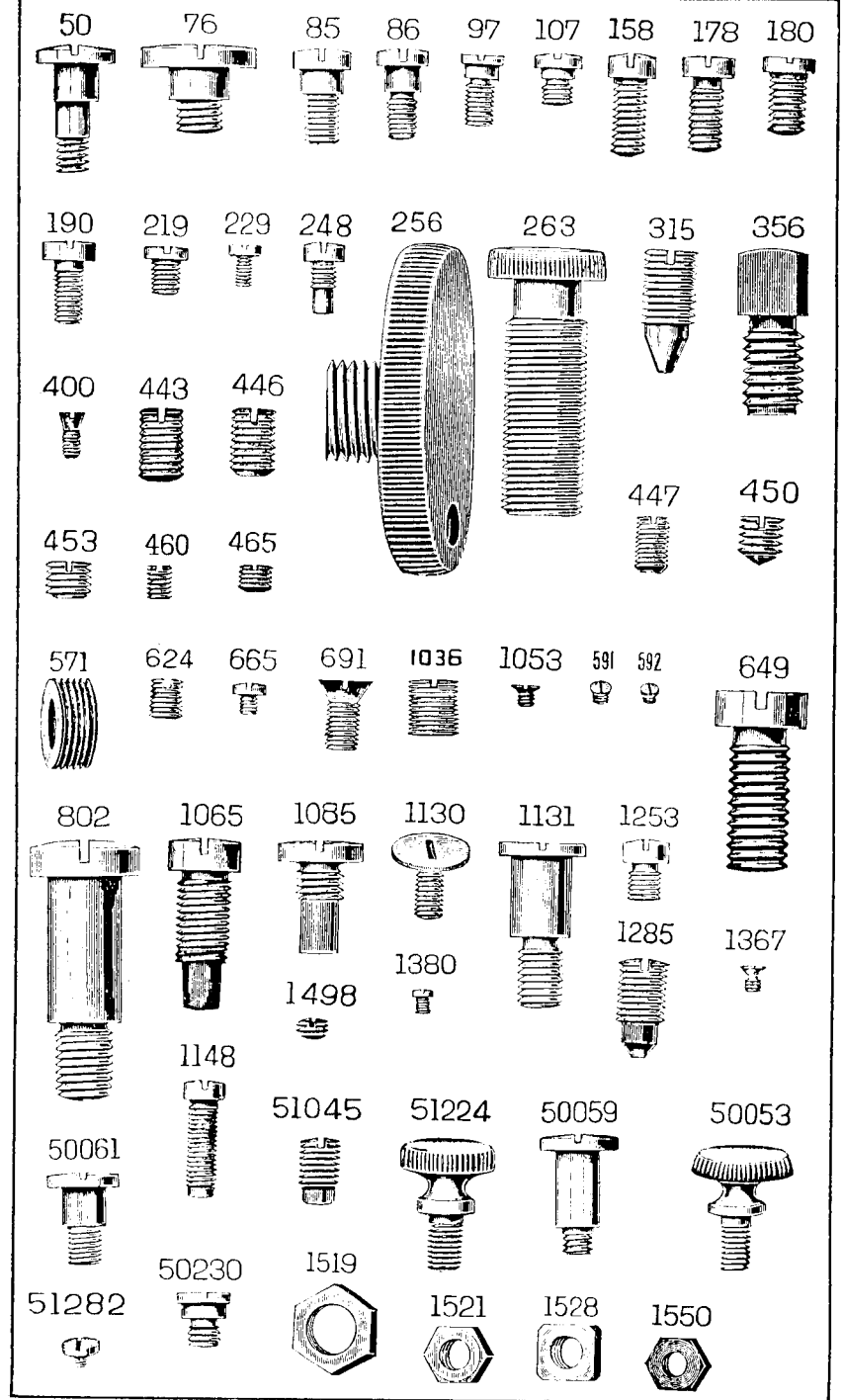
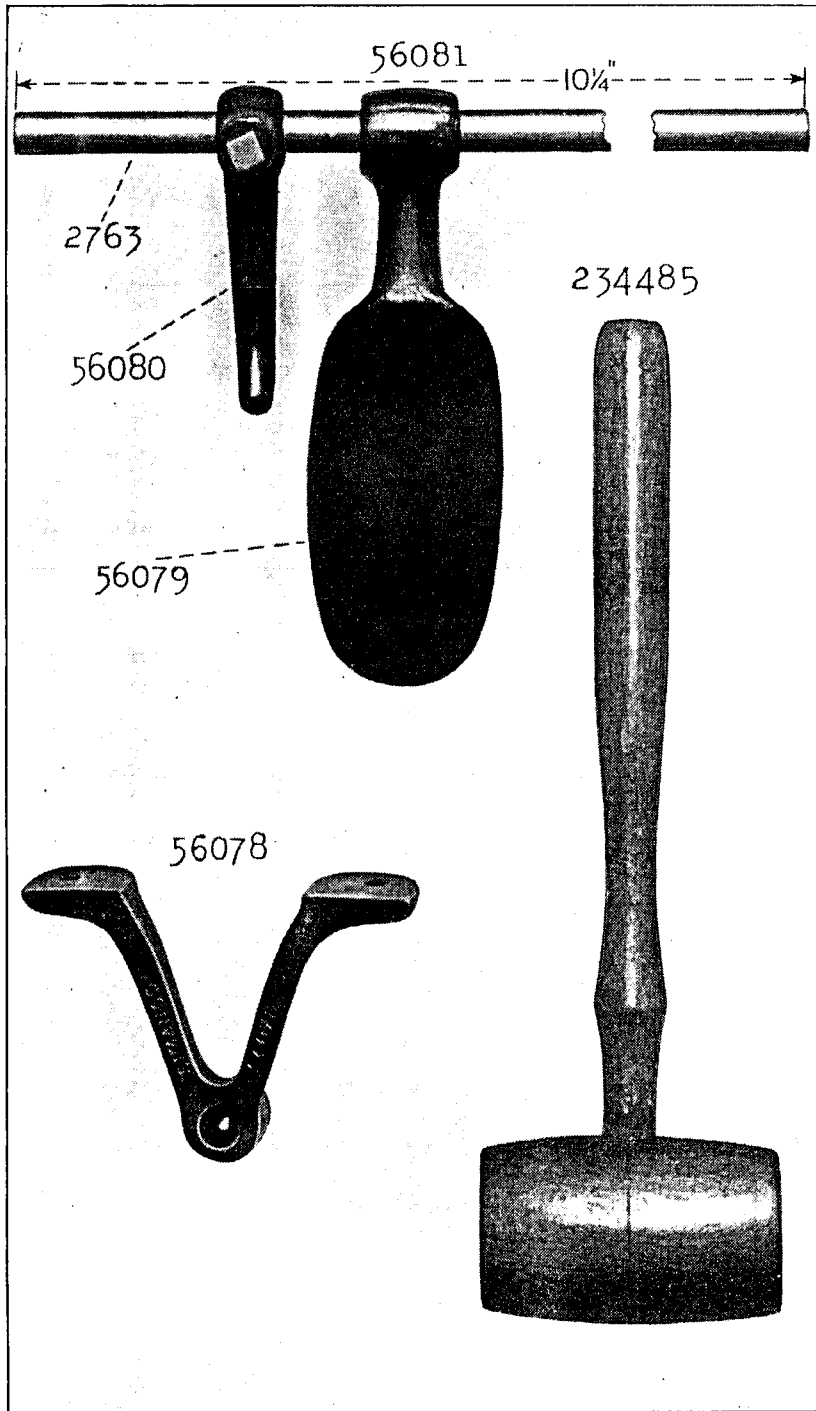

463 889 1329 50117 183010 183011 183012



183013 183014 183015 183016 183017 183018

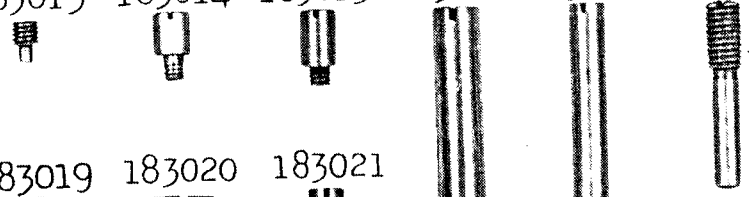

183019 183020 183021



183022

183025 183026 183027



183037 183038 183148

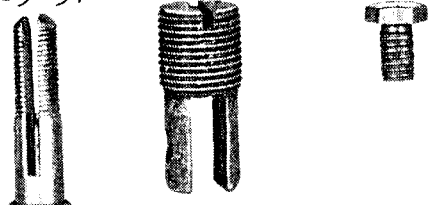

183028



189589



1637



105002

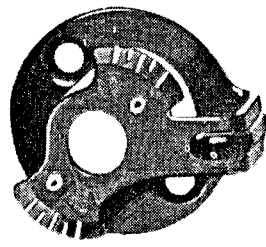

105001

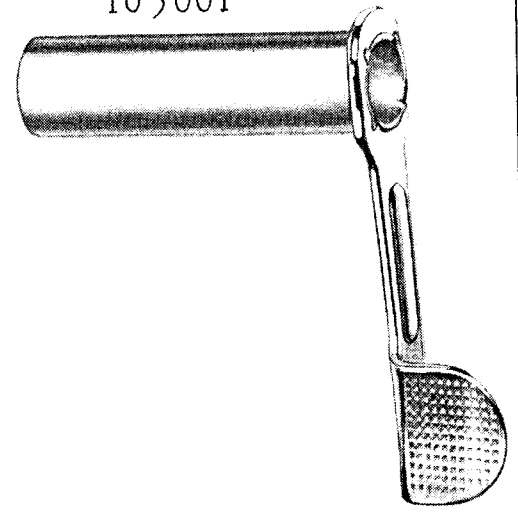

ILLUSTRATED LIST OF PARTS

FOR

CLASS 206K MACHINES

(Nos. 206K10, 206K11, 206K18 and 206K19)

CONTENTS

	Page
Parts complete for Nos. 206K18 and 206K19 Machines	37
" Special to Nos. 206K10 and 206K11 Machines	44
Attachments	47
Bobbin Winder	52
Knee Lifter	44
Numerical List of Parts	55
Obsolete Parts	53

INSTRUCTIONS FOR ORDERING

In ordering from this List, the prefix and affix letters with the part number **MUST BE** quoted exactly as they are shown in the first column.

A number always indicates the same part in whatever List it may appear, or for whatever machine.

The affix letters (where shown) indicate the style of finish, as follows:—

- A. Hardened, Polished, Nickel Plated and Buffed.
- A.A. Buffed and Chromium Plated.
- A.B. Hardened, Polished, Buffed and Chromium Plated.
- A.C. Brown Baking Enamel Finish.
- A.D. Grey Baking Enamel Finish.
- A.E. Hardened, Bright Rumbled and Nickel Plated.
- A.F. Hardened, Bright Rumbled and Nickel Plated, Bright Rumbled and Chromium Plated.
- A.J. Polished, Nickel Plated and Chromium Plated.
- A.K. Hardened, Polished, Nickel Plated and Chromium Plated.
- A.L. Heat Treated for Toughness.
- B. Polished, Nickel Plated and Buffed.
- C. Hardened only.
- C.R. Hardened and Merlized.
- D. Polished only.
- E. Soft, not Polished.
- F. Hardened and Polished.
- F.J. Hardened, Polished and Nickel Plated.
- G. Bright Rumbled and Nickel Plated.
- H. Blued.
- J. Nickel Plated only.
- K. Hardened and Nickel Plated.
- L. Brass Plated.
- M. Oxidized.
- N. Japanned, Dull.
- P. Japanned, Bright.
- P.P. Wrinkle Finish.
- R. Merlized.
- S. Cadmium Plated.
- T. Copper Plated.
- T.A. Hardened, Polished, Copper and Nickel Plated and Buffed.
- T.B. Copper and Nickel Plated and Polished.
- T.J. Copper and Nickel Plated only.
- T.K. Hardened, Copper and Nickel Plated.
- T.L. Copper and Brass Plated.
- T.M. Copper Plated and Oxidized.
- U. Zinc Plated.
- V. Silver Plated.
- W. Polished and Nickel Plated.
- X. Black Oxide for Iron and Steel.
- X.C. Hardened and Black Oxide for Iron and Steel.
- Y. Black Nickel Plated only.
- Z. Chromium Plated.
- Z.A. Hardened, Polished, Nickel Plated, Buffed and Chromium Plated.
- Z.B. Polished, Nickel Plated, Buffed and Chromium Plated.
- Z.C. Hardened and Chromium Plated.
- Z.D. Polished and Chromium Plated.
- Z.G. Bright Rumbled, Nickel Plated, Bright Rumbled and Chromium Plated.
- Z.J. Nickel and Chromium Plated.
- Z.T. Copper and Chromium Plated.

Parts marked with an asterisk (*) are furnished only when the repairs are made at Factory.

PARTS COMPLETE

FOR

Nos. 206K18 and 206K19 MACHINES

Reverse Feed. For Zig-zag and Straight Line Stitching.
Needle threaded from the front.

No.	Plate				
*†188905	---	Arm	with 15404, 189672 and two 15405
649c	2200	"	Binding Screw (3)
189621	2186	"	Cover (front)
1329c	2201	"	" (") Screw (2)
2002	2188	"	Dowel Pin (2)
*4389	2188	"	" " (for repairs only)
189506	2184	"	Shaft
189507	2178	"	" Bushing (front)
443c	2200	"	" " (") Set Screw
188958	2178	"	" " (back)
1285c	2200	"	" " (") Set Screw
189542	2184	"	" Connection Belt (To be ordered from Bridgeport)
188458	2178	"	" " " " Pulley
448c	2183	"	" " " " " Set Screw
189510	2178	"	" " " " " Spring Ring
188452	2178	"	" " " " " complete, Nos. 188458, two each 448c and 189510
189512	2177	"	" " Spiral Gear with two 183026c
183026c	2201	"	" " " " Set Screw
189505	2176	"	" Side Cover (back)
51224zb	2200	"	" " " (") Thumb Screw
2007z	2188	"	" Spool Pin
8879	2188	"	" " " Washer (cloth)
189502	2186	"	" Top Cover with 189504
183010h	2201	"	" " " Hinge Screw
189696	2187	"	" " " " " Spring Washer
189504	2186	"	" " " Spool Pin
15282zb	2175	Balance Wheel,	2 1/4" pulley, for 206K18 Machine
56136	---	"	" " 2 1/2" " " 206K19 "
*†105003	---	Bed
256zb	2200	Clamp Stop Motion Clamp Screw
248za	2200	"	" " " " Stop Screw
2020	2188	"	" " " " Washer
32618	2188	"	" " " " Flanged Bushing
1148c	2200	"	" " " " " Set Screw

†NOTE.—Due to the accuracy required in setting Arm to Bed, these parts cannot be supplied separately and can only be sent out as a unit, Arm and Bed assembled.

No.	Plate						
188903	—	Face Plate
188904	2176	" "	188903 with two 189541
107zb	2200	" "	Screw
105004	—	" "	Thread Guard
189541	2186	" "	" " 105004 with 125373
125373	2186	" "	" " Rivet
51224zb	2200	" "	Thumb Screw
189575	2176	Feed Bar
315c	2200	" "	Screw Centre
15445	—	" "	" " 315c with 1519e (2)
1519e	2200	" "	" " Nut
188956	2179	" "	Supporting Bracket with two 889c
889c	2201	" "	" " Set Screw
188928	2185	" "	Dog for 188930
50117c	2201	" "	Screw (2)
188927	2177	" "	Eccentric with two 183026c
183026c	2201	" "	Set Screw
189577	2182	Feed Forked Connection
189705	—	" "	" 189577 with 2049 and 189578
189706	—	" "	" complete, Nos. 1550zj, 1637j, 183016c, 183017c, 188925, 188926, 189572 and 189705
2049	2188	" "	Connection Pin
189578	2182	" "	" Shaft
189579	2177	" "	" " Adjusting Collar with two 465al
465al	2200	" "	" " " Set Screw
189550	2177	Feed Lifting Eccentric	with two 183026c
189585	2181	" "	" Fork with 158e
158e	2200	" "	" " Clamping Screw
183026c	2201	" "	" " Set Screw
189583	2181	" "	Rock Shaft
189579	2177	" "	" " Adjusting Collar with two 465al
465al	2200	" "	" " " Set Screw
188952	2179	" "	" " Crank with 158e and 125330
158e	2200	" "	" " Clamping Screw
15170	2188	" "	" " Slide Block
125060	2188	" "	" " " Stud
125330	—	" "	" " " 15170 with 125060
189588	2179	Feed Regulator Connecting Rod
86c	2200	" "	" " Screw
189589c	2201	" "	" " Stud
460c	2200	" "	" " " Set Screw
189591	2187	" "	Index
189590	2179	" "	Indicator Plate
691za	2200	" "	" " Screw (2)

No.	Plate						
189586	2181	Feed Regulator Lever
183018c	2201	" "	" Hinge Screw
189594	2181	" "	" Thumb Nut
189593	2187	" "	" " Spring
189592	2187	" "	" " " Bushing
189595	2179	" "	Stop Block with two 447c
447c	2200	" "	" " Set Screw
183019zb	2201	" "	" Screw
188954	2184	Feed Rock Shaft
188955	2177	" "	" Adjusting Collar (left) with two 465al
465al	2200	" "	" " " (") Set Screw
189571	2177	" "	" " " (right) with two 465al
465al	2200	" "	" " " (") Set Screw
188925	2176	" "	" Connecting Link with 460c
188926	2182	" "	" " Slide Block
183017c	2201	" "	" " " Slide Bar
1550zj	2200	" "	" " " " Nut
189572	2179	" "	" Crank with 158e
158e	2200	" "	" Clamping Screw
183016c	2201	" "	" Hinge Screw
1637j	2201	" "	" " " Nut
51045c	2200	Machine Hinge Set Screw (2)
189773	2181	Needle Bar with 189774
189517	2187	" "	" Connecting Link with two 183027c
189518	2187	" "	" " Hinge Block (lower)
189515	2187	" "	" " " (upper) with 183011e
183011e	2201	" "	" " " (") Adjusting Screw
1130e	2200	" "	" " " (") Cap Screw
189519	2187	" "	" " Pin
183027c	2201	" "	" Set Screw
189520	2187	" "	" Stud with 400c and 465al
400c	2200	" "	" Adjusting Screw
183012c	2201	" "	" Cap Screw
465al	2200	" "	" Set Screw
189695	—	" "	Connection, Nos. 189515, 189517, 189518 and two 189519
189533	—	" "	" complete, Nos. 1130e, 183012c, 189514, 189520 and 189695
188949	2177	" "	" Crank with 1036c and 1065c
1065c	2200	" "	" Position Screw
189532	2187	" "	" Height Indicator
665zb	2200	" "	" " Screw
189748	2176	" "	Holder
189776	—	" "	" 189748, with 665zb and 189532
183038c	2201	" "	" Supporting Bracket

No.	Plate	
624c	2200	Needle Bar Holder Supporting Bracket Set Screw
27795	2186	" " " " " " " Washer
183015c	2201	" " " " " " " Hinge Screw
189777	—	" " " " complete, Nos. 183015c, 183038c, 189773 and 189776
189774	2186	" " Pin
189523	2187	Needle Clamp
1498c	2200	" " Set Screw
189525	2186	" " Thread Guide
183014zb	2201	" " " " Screw
189694	—	" " 189523 with 1498c and 183013za
189527	—	Needle Clamp , complete, Nos. 183014zb, 189525 and 189694
188430	2187	Needle Holder (single) with 50624d
50624d	2187	" " Clamping Screw
189781	—	Needle Holder (single), complete, Nos. 188430 and 189527
183013za	2201	Needle Set Screw
189618	2180	Needle Vibrator Amplitude Regulating Lever with 189673 and two 624c
189620	2180	" " " " " " Distance Washer
189616	2180	" " " " " " Friction Spring
183228zb	2180	" " " " " " " Spring Screw
188436	2180	" " " " " " Friction Spring Screw Washer
183192c	2183	" " " " " " Lever Stop Screw
105002	—	" " " " " " Scale
50156c	2180	" " " " " " Screw
189613	2180	" " " " " " Shaft
32562	2188	" " " " " " Cam with 1285c
189599	2177	" " " " " " Shaft Spiral Gear with two 183026c
183026c	2201	" " " " " " Set Screw
1285c	2200	" " " " " " Set Screw
189600	2184	" " " " " " Fork Connection
183020c	2201	" " " " " " Hinge Screw
188417	—	" " " " " " Rock Shaft Lever
188415	2180	" " " " " " Sliding Block
1085e	2200	" " " " " " Screw
189597	2181	" " " " " " Driving Shaft
189598	2177	" " " " " " Adjusting Collar with two 183026c
183026c	2201	" " " " " " " " Set Screw
189603	2187	" " " " " " Lever (back) with 180c
180c	2200	" " " " " (") Clamping Screw

No.	Plate	
189605	2180	Needle Vibrator Lever Slide Bushing
183021c	2201	" " " " " " Screw
183025zb	2201	" " " " " " Regulating Screw
188416	2180	" " " " " " Slide with two 624c
624c	2200	" " " " " " Set Screw
189674	—	" " " " " " Device, complete, Nos. 691za, 56038, 105001, 105002, 188412, 188416, 189612, 189613, 189617, 189618, 189620 and two 50156c
188412	2180	" " " " " " Zero Position Control Bearing Sleeve with two 460c
183026c	2201	" " " " " " " " " Set Screw
460c	2200	" " " " " " " " " Stop Screw
188413	2180	" " " " " " " " " Thrust Washer
189612	2180	" " " " " " " " " Eccentric with 453c
453c	2200	" " " " " " " " " Set Screw
105001	—	" " " " " " " " " Lever
56038	2180	" " " " " " " " " Friction Washer
189673	2180	" " " " " " " " " Position Pin
691za	2200	" " " " " " " " " Screw
624c	2200	" " " " " " " " " Set Screw
189615	2180	" " " " " " " " " Plate with 183025zb, 183192c and 189675
189617	—	" " " " " " " " " 189615 with 183228zb, 188436 and 189616
189675	2180	" " " " " " " " " Control Plate Pin
32665	2175	Presser Bar
45237	2188	" " " " " " Guide Bracket with 453c
453c	2200	" " " " " " " " Set Screw
66564	2179	" " " " " " Lifter
85c	2200	" " " " " " Screw
32675	2188	" " " " " " Spring
2070	2188	" " " " " " Washer
189645	—	Presser Foot Hinge Pin
189644	—	" " " " " " Shank
189643	—	" " " " " " Sole
189646	2185	Presser Foot (hinged), for Zig-zag Stitching, complete, Nos. 189643 to 189645
183022zb	2201	" " " " " " Thumb Screw
263zj	2200	Pressure Regulating Thumb Screw

No.	Plate	
142013	2183	Rotating Hook with three 1253c ...
188419	—	" " 142013 with 188418 and four 1053c ...
188422	—	" " 188419 with 40274 and three 1367d ...
188420	—	" " 188422 with 188944 ...
188421	—	" " 188420 with 52237 ...
55623	2192	" " Bobbin ...
52235	—	" " " Case ...
52236	—	" " " " 52235 with 591f, 1380d and 40394 ...
52237	2183	" " " " 52236 with 592e, 2975 and 40393 ...
40393	—	" " " " Hinge, complete, Nos. 2974, 40392 and 125320 ...
188944	2183	" " " " Holder ...
188957	2182	" " " " " Position Bracket ...
190zb	2200	" " " " " " " Screw ...
40392	2183	" " " " " Latch ...
125320	2188	" " " " " Lever ...
2974	2188	" " " " " " Fulcrum Pin ...
2975	2188	" " " " " Spring ...
592e	2200	" " " " " Stop Screw ...
591f	2200	" " " " " Tension Regulating Screw ...
40394	2183	" " " " " Spring ...
1380d	2200	" " " " " " Screw ...
188456	2184	" " " " Driving Shaft ...
189672	2182	" " " " " Bearing (back) Oil Tube ...
188455	2182	" " " " " Bushing (back) ...
448c	2183	" " " " " (") Set Screw ...
189547	2182	" " " " " (front) ...
448c	2183	" " " " " (") Set Screw ...
188457	2178	" " " " " Connection Belt Pulley with two SS641c ...
SS641c	2178	" " " " " " Belt Pulley Set Screw ...
189551	2177	" " " " " Spiral Gear with two 183026c ...
189556	2178	" " " " " " Case with 450al ...
189557	2178	" " " " " " " Cover ...
219j	2200	" " " " " " " " Screw (2) ...
450al	2200	" " " " " " " Set Screw ...
183026c	2201	" " " " " " " Set Screw ...
1253c	2200	" " " " " Screw ...
40274	2183	" " " " " Section ...
1367d	2200	" " " " " Screw ...
189552	2177	" " " " " Shaft ...
189555	2177	" " " " " Adjusting Collar with two 1253c ...
1253c	2200	" " " " " " Set Screw ...
189553	2182	" " " " " Shaft Bushing (back) ...
453c	2200	" " " " " (") Set Screw ...

No.	Plate	
189554	2182	Rotating Hook Shaft Bushing (front) ...
448c	2183	" " " " (") Set Screw ...
188418	2183	" " " Thread Guard ...
1053c	2200	" " " " Screw ...
189538	2186	Slack Thread Regulator ...
465al	2200	" " " " Set Screw ...
2102	2190	Tension Disc ...
125310	2190	" Indicator ...
125311	2190	" " Flange ...
51608zw	2190	" Regulating Thumb Nut ...
125312	2190	" Releasing Disc ...
189537	2186	" " Lever ...
97j	2200	" " " Hinge Screw ...
12329	2190	" " " Spring ...
188914	2186	" " Pin ...
183037zw	2201	" Screw Stud ...
125314	2190	" Spring ...
188911	—	Tension (graduated), complete, Nos. 32576zb, 51608zw, 125310 to 125312, 125314, 183037zw, 188909, 188914 and two 2102 ...
26075	2188	Thread Cutter and Holder ...
188997zb	2182	Thread Guard (front of arm) ...
189514	2186	Thread Take-up Crank for 189533 ...
1036c	2200	" " " Position Screw for 188949 ...
*188901	2186	Thread Take-up Lever ...
*32544	2188	" " " Link ...
1131c	2200	" " " " Hinge Screw ...
*32543	2188	" " " " Stud ...
188902	—	" " " 188901, with 32543 and 32544 ...
188907	—	Thread Take-up Lever , complete, Nos. 1131c, 188902 and 189533 ...
188909	2187	" " Spring ...
32576zb	2188	" " " Regulator ...
453c	2200	" " " " Set Screw ...
188929	2185	Throat Plate (with oblong needle hole) ...
188930	—	" " (" " " ") 188929 with 189625 and two 51282zj, for Zig-zag Seams ...
189625	2185	" " Spring ...
51282zj	2200	" " " Screw ...
189657	—	Drip Pan with four nails $\frac{5}{8}$ " ...
*15404	—	Trade Mark ...
15405	—	" " Rivet ...

Attachments

ATTACHMENT SET

No.	Plate	
25527	2191	Cloth Guide
50053b	2200	" " Thumb Screw
189722	—	Darning Plate (round hole)
180625	2185	" " Spring
51282zj	2200	" " " Screw
189723	2194	Darning Plate, for Embroidery and Darning, complete, Nos. 189625, 189722 and two 51282zj
96418	2193	Embroidery Hoop (round) 7" diam. × 7 ^m / _m high
36835	2191	Felling Foot
120842	2191	Hemmer (foot) $\frac{5}{8}$ " hem
206 × 13	—	Needles (three each sizes 11 and 14)
189697	2192	Needle Threader Handle
189698	2192	" " Hook
36805	—	" " " Ring
50315j	2192	" " " Screw
189693	2192	Needle Threader, complete, Nos. 36805, 50315j, 189697 and three 189698, for threading from front to back
120862	2193	Tin of Oil (1 $\frac{1}{2}$ oz.)
189647	2192	Presser Foot, for straight stitching
189650	2192	Presser Foot, for narrow zig-zag seams and braiding
55623	2192	Rotating Hook Bobbin
25537	2191	Screw Driver (machine)
86613	2192	" " (bobbin case)
188931	—	Throat Plate
188932	2194	" " 188931 with 189625 and two 51282zj, for straight seams
80107	2191	Wrench
86609	—	Attachment Set , complete, Nos. 25527, 25537, 36835, 50053b, 80107, 86613, 96418, 120842, 120862, 188932, 189647, 189650, 189693, 189723, three each needles 206 × 13 sizes 11 and 14, and five 55623

ATTACHMENTS

No.	Plate						
189152	2193	Buttonhole Knife, $\frac{1}{2}$ "
189151	2193	" " Handle
234484	2193	" " Plate (fibre)
189682	—	Hemmer Folder, for 189654
120840	—	" " " 189653
189681	—	" Foot, for 189654
189654	2192	" " 189681 with 189682, for Rolled Seams
189653	2192	" " with 120840 and 120841, for Shell Seams
120841	—	" Tongue for 189653
189720	2192	Presser Foot, for Appliqué and Round Ornamental Seams
86616	2192	" " " Buttonhole Work for 86617
189648	2192	" " " Button Sewing
189649	2192	" " " Wide Ornamental and Zig-zag Seams
86617	—	Attachment Set , complete, Nos. 86616, 189151, 189152, 189648, 189649, 189653, 189654, 189720 and 234484, for Buttons, Buttonholes and Ornamental Stitching for 86610
86610	—	Attachment Set , complete, Nos. 86609 and 86617

NOTE.— Attachment Set No. 86610 is supplied with machine. The attachments on the following pages will be furnished at an extra charge when specified on orders.

ATTACHMENTS

EMBROIDERY SET

No	Plate						
*189669	—	Double Cord Guide Adjustable Arm (lower)
189678	2196	" " " " " (") 189669 with 189671
*189671	—	" " " " " (") Thread Guide Tube
*189668	—	" " " " " (upper)
189677	2196	" " " " " (") 189668 with 189670
*189670	—	" " " " " (") Thread Guide Tube
*189663	2196	" " " " " Frame
183023j	2196	" " " " " Hinge Screw
189666	2196	" " " " " " " Friction Washer
1607j	2196	" " " " " " " Nut
189665	2196	" " " " " Hinge Pin
189664	2196	" " " " " Spring
188912	—	" " " " " Holder, Nos. 189663 to 189665 and 189667
*189679	—	" " " " " Shank
*189680	—	" " " " " Hinge Bracket
189667	2196	" " " " " 189679 with 189680
189658	2196	Double Cord Guide, complete, Nos. 188912, 189677, 189678, two each 1607j, 183023j and 189666, for Madeira and Richelieu Work
189631	—	Embroidery Plate
189625	2185	" " " Spring
51282zj	2200	" " " Screw
189632	2197	Embroidery Plate, complete, Nos. 189625, 189631 and two 51282zj
234463	2196	Punch, for .055" holes
234467	2196	" " $\frac{3}{32}$ " " "
234485	2199	" Mallet
189634	—	Throat Plate ($\frac{3}{16}$ " spur)
189637	2197	" " ($\frac{3}{16}$ " spur), 189634 with 189625 and two 51282zj, for Madeira Eyelet Work
189639	—	" " ($\frac{1}{8}$ " spur)
189642	—	" " ($\frac{1}{8}$ " spur), 189639 with 189625 and two 51282zj, for Madeira Eyelet Work
189662	—	Embroidery Set , complete, Nos. 189632, 189637, 189642, 189658, 234463, 234467 and 234485

CORDING FOOT

No.	Plate	
189692	2195	Cording Foot, for narrow raised zig-zag seams and overedging of light material

DARNING FOOT

No.	Plate	
121094	2192	Darning Foot (spring) for use with Darning Plate 189723 ...

FEED RESTRICTING ATTACHMENT

No.	Plate	
189700	2195	Feed Restricting Attachment Carrier
189701	2195	" " " Stirrup
189702	2195	" " " " Friction Washer
109zb	2195	" " " " Screw
183024zb	2195	" " " " Stop Screw
189699	—	Feed Restricting Attachment , complete, Nos. 109zb, 183024zb and 189700 to 189702

PRESSER FEET

No.	Plate	
189651	2195	Presser Foot, for Curved Ornamental and Zig-zag Seams ...
189704	2195	" " " Buttonholes $\frac{1}{8}$ " wide
189645	—	Presser Foot Hinge Pin
188960	—	" " Plate
189644	—	" " Shank
188961	—	Presser Foot (hinged), complete, Nos. 188960, 189644 and 189645 for silk

THROAT PLATES

No.	Plate	
188933	—	Throat Plate (narrow needle hole)
189625	2185	" " Spring
51282zj	2200	" " " Screw
188934	—	Throat Plate 188933 with 189625 and two 51282zj

TRAVERSE FOR JOINING BUTTING EDGES

No.	Plate	
188938	2192	Traverse
189794	2192	" Clamp
665zj	2200	" " Screw

NOTE.—The Clamp and Screw are supplied with Welting Attachment No. 189800 and if the customer already has the latter a second clamp and screw will not be required.

WELTING ATTACHMENT

No.	Plate	
*188923	—	Needle Holder (left)
*188924	—	" " (right)
183179f	—	" " Adjusting Screw
*188431	—	" " Body with 50624d
50624d	2187	" " Clamping Screw
*188404	—	" " Guide Plate
1368zk	2195	" " " " Screw
183114c	2195	" " Screw
182518e	—	Needle Holder Stop Nut
183180f	—	" " " Screw
188405	—	Two-Needle Holder, Nos. 182518e, 183179f, 183180f, 188923 and 188924
188406	—	Two-Needle Holder, complete, Nos. 188404, 188405, 188431, two each 1368zk and 183114c
189798	2195	Welt Foot, for very narrow welts
189751	2195	" " " narrow welts
189752	2195	" " " broad welts
189795	2195	" Traverse, for narrow welts
189796	2195	" " " broad welts
189794	2192	" " Clamp
665zj	2200	" " " Screw
189797	2195	" Tube, for strip welts
189799	2195	Tension Middle Disc
189800	—	Welting Attachment , complete, Nos. 665zj, 188406, 189751, 189752 and 189794 to 189799

NUMERICAL LIST OF PARTS

No.	Plate	
50zb	2200	Bobbin Winder Worm Wheel and Thread Guide Cam Screw Stud for 188922 ...
76zj	2200	Knee Lifter Lifting Lever Connecting Rod Joint Hinge Screw for 188442 and 189714
85e	2200	Presser Bar Lifter Screw ...
86c	2200	Feed Regulator Connecting Rod Screw ...
97j	2200	Tension Releasing Lever Hinge Screw ...
107zb	2200	Face Plate Screw ...
109zb	2195	Feed Restricting Attachment Stirrup Screw for 189699 ...
158e	2200	Feed Lifting Eccentric Fork Clamping Screw for 189585 ...
158e	2200	Feed Lifting Rock Shaft Crank Clamping Screw for 188952 ...
158e	2200	Feed Rock Shaft Crank Clamping Screw for 189572 ...
178e	2200	Knee Lifter Bell Crank Bracket Screw for 188442 and 189714 ...
180c	2200	Needle Vibrator Lever (back) Clamping Screw for 189603 ...
180zb	2200	Bobbin Winder Bracket Screw for 188922 ...
190zb	2200	Rotating Hook Bobbin Case Holder Position Bracket Screw ...
219j	2200	Rotating Hook Driving Shaft Spiral Gear Case Cover Screw ...
229c	2200	Presser Bar Lifting and Releasing Lever Bracket Link Screw for 189713 ...
248za	2200	Clamp Stop Motion Clamp Stop Screw ...
256zb	2200	Clamp Stop Motion Clamp Screw ...
263zj	2200	Pressure Regulating Thumb Screw ...
315c	2200	Feed Bar Screw Centre for 15445 ...
356c	2200	Knee Lifter Rock Shaft Knee Arm Set Screw for 56079 ...
356c	2200	Knee Lifter Rock Shaft Lifting Arm Set Screw for 56080 and 188440 ...
400c	2200	Needle Bar Connecting Stud Adjusting Screw for 189520 ...
400c	2200	Presser Bar Lifting and Releasing Lever Bracket Adjusting Screw for 206K10 and 206K11 Machine (Obsolete)
443c	2200	Arm Shaft Bushing (front) Set Screw ...
447c	2200	Feed Regulator Stop Block Set Screw for 189595 ...

No.	Plate	
448c	2183	Arm Shaft Connection Belt Pulley Set Screw for 188452
448c	2183	Rotating Hook Driving Shaft Bushing (back) Set Screw
448c	2183	Rotating Hook Driving Shaft Bushing (front) Set Screw
448c	2183	Rotating Hook Shaft Bushing (front) Set Screw
450al	2200	Rotating Hook Driving Shaft Spiral Gear Case Set Screw for 189556
453c	2200	Needle Vibrator Zero Position Control Eccentric Set Screw for 189612
453c	2200	Presser Bar Guide Bracket Set Screw for 45237
453c	2200	Presser Bar Lifting and Releasing Lever Bracket Set Screw for 189712
453c	2200	Rotating Hook Shaft Bushing (back) Set Screw
453c	2200	Thread Take-up Spring Regulator Set Screw
460c	2200	Feed Regulator Connecting Rod Stud Set Screw for 188925
460c	2200	Needle Vibrator Zero Position Control Bearing Sleeve Stop Screw for 188412
465al	2200	Feed Forked Connection Shaft Adjusting Collar Set Screw for 189579
465al	2200	Feed Lifting Rock Shaft Adjusting Collar Set Screw for 189579
465al	2200	Feed Rock Shaft Adjusting Collar (right) Set Screw for 189571
465al	2200	Feed Rock Shaft Adjusting Collar (left) Set Screw for 188955
465al	2200	Needle Bar Connecting Stud Set Screw for 189520
465al	2200	Slack Thread Regulator Set Screw
571c	2200	Bobbin Winder Spindle Worm for 188922
591f	2200	Rotating Hook Bobbin Case Tension Regulating Screw for 52236
592e	2200	Rotating Hook Bobbin Case Latch Stop Screw for 52237
624c	2200	Needle Bar Holder Supporting Bracket Set Screw
624c	2200	Needle Vibrator Regulating Slide Set Screw for 188416
624c	2200	Needle Vibrator Zero Position Control Lever Set Screw for 189618
SS641c	2178	Rotating Hook Driving Shaft Connection Belt Pulley Set Screw for 188457

No.	Plate	
649c	2200	Arm Binding Screw
665zb	2200	Needle Bar Height Indicator Screw for 189776
665zj	2200	Welt Traverse Clamp Screw for 189800
691za	2200	Feed Regulator Indicator Plate Screw
691za	2200	Needle Vibrator Zero Position Control Lever Screw for 189674
802zj	2200	Knee Lifter Lifting Lever Hinge Screw for 188442 and 189714
889c	2201	Feed Bar Supporting Bracket Set Screw for 188956
889c	2201	Needle Vibrator Lever (front) Set Screw for 189604 (Obsolete)
1036c	2200	Thread Take-up Crank Position Screw for 188949
1053c	2200	Rotating Hook Thread Guard Screw for 188419
1065c	2200	Needle Bar Crank Position Screw for 188949
1085c	2200	Needle Vibrator Fork Connection Sliding Block Screw
1130e	2200	Needle Bar Connecting Link Hinge Block (upper) Cap Screw for 189533
1131c	2200	Thread Take-up Lever Link Hinge Screw for 188907
1148c	2200	Clamp Stop Motion Flanged Bushing Set Screw
1253c	2200	Rotating Hook Screw for 52121 and 142013
1253c	2200	Rotating Hook Shaft Adjusting Collar Set Screw for 189555
1285c	2200	Arm Shaft Bushing (back) Set Screw
1285c	2200	Needle Vibrator Cam Set Screw for 32562
1329c	2201	Arm Cover (front) Screw
1367d	2200	Rotating Hook Section Screw for 188422
1368zk	2195	Needle Holder Guide Plate Screw for 188406 and 188918
1380d	2200	Rotating Hook Bobbin Case Tension Spring Screw for 52236
1498c	2200	Needle Clamp Set Screw for 189694
1519e	2200	Feed Bar Screw Centre Nut for 15445
1521zj	2200	Knee Lifter Lifting Lever Connecting Rod Lock Nut for 188442 and 189714
1528zj	2200	Bobbin Winder Worm Wheel and Thread Guide Cam Screw Stud Nut for 188922
1550zj	2200	Feed Rock Shaft Connecting Link Slide Block Slide Bar Nut for 189706
1607j	2196	Double Cord Guide Adjustable Arm Hinge Screw Nut for 189658

No.	Plate	
1637j	2201	Feed Rock Shaft Crank Hinge Screw Nut for 189706
2002	2188	Arm Dowel Pin
2007z	2188	Arm Spool Pin
2020	2188	Clamp Stop Motion Clamp Washer
2049	2188	Feed Forked Connection Pin for 189705
2070	2188	Presser Bar Spring Washer
2102	2190	Tension Disc for 188911
2749	2190	Bobbin Winder Worm Wheel and Thread Guide Cam Friction Washer for 188922
2763	2199	Knee Lifter Rock Shaft for 56081 and 188441
2974	2188	Rotating Hook Bobbin Case Latch Lever Fulcrum Pin for 40393
2975	2188	Rotating Hook Bobbin Case Latch Spring for 52237
*4389	2188	Arm Dowel Pin (for repairs only)
5596	2175	Knee Lifter Bell Crank for 189708
5601	2188	Knee Lifter Bell Crank Hinge Pin for 189708
8879	2188	Arm Spool Pin Washer (cloth)
12329	2190	Tension Releasing Lever Spring
12416	2188	Knee Lifter Lifting Lever Connecting Rod Joint for 188442 and 189714
15072	2190	Bobbin Winder Bobbin Position Pin for 188913
15170	2188	Feed Lifting Rock Shaft Crank Slide Block for 125330
15282zb	2175	Balance Wheel, 2½" pulley, for 206K10 and 206K18 Machines
15286	2190	Bobbin Winder Frame Spring for 188922
15287	2190	Bobbin Winder Friction Ring (rubber) for 188922
15288zb	2190	Bobbin Winder Pulley for 188922
15291	2190	Bobbin Winder Stop Latch Spring for 188922
15366	2190	Bobbin Winder Thread Guide Spring for 188922
15376zj	2190	Bobbin Winder Adjusting Arm for 188922
*15404	—	Trade Mark for 188905 and 188906
15405	—	Trade Mark Rivet for 188905 and 188906
15413	2190	Bobbin Winder Frame for 188922
15416zb	2190	Bobbin Winder Worm Wheel and Thread Guide Cam for 188922
15445	—	Feed Bar Screw Centre 315c with 1519e
25527	2191	Cloth Guide for 86609
25537	2191	Screw Driver (machine) for 86609
26075	2188	Thread Cutter and Holder
27795	2186	Needle Bar Holder Supporting Bracket Set Screw Washer

No.	Plate	
*32543	2188	Thread Take-up Lever Link Hinge Stud for 188902
*32544	2188	Thread Take-up Lever Link for 188902
32562	2188	Needle Vibrator Cam with 1285c
32576zb	2188	Thread Take-up Spring Regulator for 188911
32618	2188	Clamp Stop Motion Flanged Bushing
32625zj	2190	Bobbin Winder Stop Latch for 188922
32628zj	2190	Bobbin Winder Thread Guide for 188922
32665	2175	Presser Bar
32675	2188	Presser Bar Spring
36805	—	Needle Threader Hook Ring for 189693
36835	2191	Felling Foot for 86609
40274	2183	Rotating Hook Section for 188422
40392	2183	Rotating Hook Bobbin Case Latch for 40393
40393	—	Rotating Hook Bobbin Case Hinge, complete, Nos. 2974, 40392 and 125320 for 52237
40394	2183	Rotating Hook Bobbin Case Tension Spring for 52236
45237	2188	Presser Bar Guide Bracket with 453c
50053b	2200	Cloth Guide Thumb Screw for 86609
50059zb	2200	Bobbin Winder Frame Hinge Screw for 188922
50061zb	2200	Bobbin Winder Thread Guide Hinge Screw for 188922
50117c	2201	Feed Dog Screw
50156c	2180	Needle Vibrator Amplitude Regulating Scale Screw for 189674
50230zb	2200	Bobbin Winder Stop Latch Hinge Screw for 188922
50315j	2192	Needle Threader Hook Screw for 189693
50624d	2187	Needle Holder Clamping Screw for 188430 and 188431
51045c	2200	Machine Hinge Set Screw
51224zb	2200	Arm Side Cover (back) Thumb Screw
51224zb	2200	Face Plate Thumb Screw
51282zj	2200	Darning Plate Spring Screw for 189723
51282zj	2200	Embroidery Plate Spring Screw for 189632
51282zj	2200	Throat Plate Spring Screw for 188930, 188932, 188934, 189637 and 189642
51608zw	2190	Tension Regulating Thumb Nut for 188911
52090	2188	Rotating Hook Thread Guard (Obsolete)
52121	—	Rotating Hook with three 1253c (Obsolete)
52235	—	Rotating Hook Bobbin Case for 52236
52236	—	Rotating Hook Bobbin Case 52235 with 591f, 1380d and 40394 for 52237

No.	Plate	
52237	2183	Rotating Hook Bobbin Case 52236 with 592e, 2975 and 40393 for 188421 ...
55623	2192	Rotating Hook Bobbin for 86609 ...
56038	2180	Needle Vibrator Zero Position Control Lever Friction Washer for 189674 ...
56073	2187	Knee Lifter Bell Crank Spring for 189708 ...
56078	2199	Knee Lifter Rock Shaft Hanger with two wood screws 1" No. 10, for 56081 and 188441 ...
56079	2199	Knee Lifter Rock Shaft Knee Arm with 356c, for 56081 and 188441 ...
56080	2199	Knee Lifter Rock Shaft Lifting Arm with 356c, for 56081 ...
56081	2199	Knee Lifter Rock Shaft, complete, Nos. 2763, 56079, 56080 and two 56078, for 189714 ...
56136	—	Balance Wheel, 2½" pulley, for 206K11 and 206K19 Machines ...
66564	2179	Presser Bar Lifter ...
80107	2191	Wrench for 86609 ...
86609	—	Attachment Set, complete, Nos. 25527, 25537, 36835, 50053b, 80107, 86613, 96418, 120842, 120862, 188932, 189647, 189650, 189693, 189723, three each needles 206x13 sizes 11 and 14, and five 55623, for 86610 ...
86610	—	Attachment Set, complete, Nos. 86609 and 86617 ...
86613	2192	Screw Driver (bobbin case) for 86609 ...
86616	2192	Presser Foot for Buttonhole Work, for 86617 ...
86617	—	Attachment Set, complete, Nos. 86616, 189151, 189152, 189648, 189649, 189653, 189654, 189720 and 234484, for Buttons, Buttonholes and Ornamental Stitching, for 86610 ...
90530	2189	Bobbin Winder Adjusting Arm Screw Washer for 188922 ...
96418	2193	Embroidery Hoop (round) 7" diam. x 7 ^m / ₁₆ " high, for 86609 ...
105001	—	Needle Vibrator Zero Position Control Lever for 189674 ...
105002	—	Needle Vibrator Amplitude Regulating Scale for 189674 ...
*105003	—	Bed for 206K18 and 206K19 Machines ...
105004	—	Face Plate Thread Guard for 189541 ...

NOTE.—Due to the accuracy required in setting Arm to Bed, these parts cannot be supplied separately and can only be sent out as a unit, Arm and Bed assembled.

No.	Plate	
120840	—	Hemmer Folder for 189653 ...
120841	—	Hemmer Tongue for 189653 ...
120842	2191	Hemmer (foot) $\frac{5}{16}$ " hem, for 86609 ...
120862	2193	Tin of Oil (1½ oz.) for 86609 ...
121094	2192	Darning Foot (spring) for use with Darning Plate 189723 ...
125060	2188	Feed Lifting Rock Shaft Crank Slide Block Stud for 125330 ...
125310	2190	Tension Indicator for 188911 ...
125311	2190	Tension Indicator Flange for 188911 ...
125312	2190	Tension Releasing Disc for 188911 ...
125314	2190	Tension Spring for 188911 ...
125320	2188	Rotating Hook Bobbin Case Latch Lever for 40393 ...
125330	—	Feed Lifting Rock Shaft Crank Slide Block 15170 with 125060 for 188952 ...
125373	2186	Face Plate Thread Guard Rivet for 189541 ...
142013	2183	Rotating Hook with three 1253c for 188419 ...

No.	Plate	
182518e	—	Needle Holder Stop Nut for 188405 ...
183010h	2201	Arm Top Cover Hinge Screw ...
183011e	2201	Needle Bar Connecting Link Hinge Block (upper) Adjusting Screw for 189515 ...
183012c	2201	Needle Bar Connecting Stud Cap Screw for 189533 ...
183013za	2201	Needle Set Screw for 189694 ...
183014zb	2201	Needle Clamp Thread Guide Screw for 189527
183015c	2201	Needle Bar Holder Supporting Bracket Hinge Screw for 189777 ...
183016c	2201	Feed Rock Shaft Crank Hinge Screw for 189706 ...
183017c	2201	Feed Rock Shaft Connecting Link Slide Block Slide Bar for 189706 ...
183018c	2201	Feed Regulator Lever Hinge Screw ...
183019zb	2201	Feed Regulator Stop Screw ...
183020c	2201	Needle Vibrator Fork Connection Hinge Screw ...
183021c	2201	Needle Vibrator Lever Slide Bushing Screw
183022zb	2201	Presser Foot Thumb Screw ...
183023j	2196	Double Cord Guide Adjustable Arm Hinge Screw for 189658 ...
183024zb	2195	Feed Restricting Attachment Stop Screw for 189699 ...
183025zb	2201	Needle Vibrator Regulating Screw for 189615
183026c	2201	Arm Shaft Spiral Gear Set Screw for 189512
183026c	2201	Feed Eccentric Set Screw for 188927 ...
183026c	2201	Feed Lifting Eccentric Set Screw for 189550
183026c	2201	Needle Vibrator Cam Shaft Spiral Gear Set Screw for 189599 ...
183026c	2201	Needle Vibrator Fork Driving Shaft Adjusting Collar Set Screw for 189598 ...
183026c	2201	Needle Vibrator Zero Position Control Bearing Sleeve Set Screw ...
183026c	2201	Rotating Hook Driving Shaft Spiral Gear Set Screw for 189551 ...
183027c	2201	Needle Bar Connecting Link Set Screw for 189517 ...
183028d	2201	Needle Holder Clamping Screw for 188915 (Obsolete)
183037zw	2201	Tension Screw Stud for 188911 ...
183038c	2201	Needle Bar Holder Supporting Bracket for 189777 ...
183097c	2195	Needle Holder Adjusting Screw for 188918 (Obsolete)
183114c	2195	Needle Holder Screw for 188406 and 188918

No.	Plate	
183148zb	2201	Bobbin Winder Adjusting Arm Screw for 188922 ...
183179f	—	Needle Holder Adjusting Screw for 188405 ...
183180f	—	Needle Holder Stop Screw for 188405 ...
183192c	2183	Needle Vibrator Amplitude Regulating Lever Stop Screw for 189615 ...
183228zb	2180	Needle Vibrator Amplitude Regulating Lever Friction Spring Screw for 189617 ...
*188404	—	Needle Holder Guide Plate for 188406 ...
188405	—	Two-Needle Holder, Nos. 182518e, 183179f, 183180f, 188923 and 188924 for 188406 ...
188406	—	Two-Needle Holder, complete, Nos. 188404, 188405, 188431, two each 1368zk and 183114c for 189800 ...
188412	2180	Needle Vibrator Zero Position Control Bearing Sleeve with two 460c for 189674
188413	2180	Needle Vibrator Zero Position Control Bearing Sleeve Thrust Washer ...
188415	2180	Needle Vibrator Fork Connection Sliding Block ...
188416	2180	Needle Vibrator Regulating Slide with two 624c, for 189674 ...
188417	—	Needle Vibrator Fork Connection Rock Shaft Lever ...
188418	2183	Rotating Hook Thread Guard for 188419 ...
188419	—	Rotating Hook 142013 with 188418 and four 1053c, for 188422 ...
188420	—	Rotating Hook 188422 with 188944, for 188421 ...
188421	—	Rotating Hook 188420 with 52237 ...
188422	—	Rotating Hook 188419 with 40274 and three 1367d, for 188420 ...
188430	2187	Needle Holder (single), with 50624d, for 189781 ...
*188431	—	Needle Holder Body with 50624d, for 188406
188436	2180	Needle Vibrator Amplitude Regulating Lever Friction Spring Screw Washer for 189617
188440	2182	Knee Lifter Rock Shaft Lifting Arm, with 356c, for 188441 ...
188441	—	Knee Lifter Rock Shaft, complete, Nos. 2763, 56079, 188440 and two 56078, for 188442
188442	—	Knee Lifter, complete, Nos. 76zj, 802zj, 1521zj, 12416, 188441, 188999, 189708, 189710 and two 178e, for 206K10 and 206K11 Machines when used on $\frac{3}{8}$ " tables
188452	2178	Arm Shaft Connection Belt Pulley, complete, Nos. 188458, two each 448c and 189510

No.	Plate	
188455	2182	Rotating Hook Driving Shaft Bushing (back)
188456	2184	Rotating Hook Driving Shaft
188457	2178	Rotating Hook Driving Shaft Connection Belt Pulley with two SS641c
188458	2178	Arm Shaft Connection Belt Pulley for 188452
*188901	2186	Thread Take-up Lever for 188902
188902	—	Thread Take-up Lever 188901 with 32543 and 32544, for 188907
188903	—	Face Plate for 188904
188904	2176	Face Plate 188903 with two 189541
*188905	—	Arm with 15404, 189672 and two 15405, for 206K18 and 206K19 Machines
*188906	—	Arm with 15404, 189672 and two 15405, for 206K10 and 206K11 Machines
<i>NOTE.—Due to the accuracy required in setting Arm to Bed, these parts cannot be supplied separately and can only be sent out as a unit, Arm and Bed assembled.</i>		
188907	—	Thread Take-up Lever, complete, Nos. 1131c, 188902 and 189533
188909	2187	Thread Take-up Spring for 188911
188911	—	Tension (graduated), complete, Nos. 32576zb, 51608zw, 125310 to 125312, 125314, 183037zw, 188909, 188914 and two 2102
188912	—	Double Cord Guide Holder, Nos. 189663 to 189665 and 189667 for 189658
188913	2189	Bobbin Winder Spindle with 15072, for 188922
188914	2186	Tension Releasing Pin for 188911
188915	—	Needle Holder Body with 183028d, for 188918 (Obsolete)
188916	—	Needle Holder Guide Plate for 188918 (Obsolete)
188918	2195	Needle Holder (double), complete, Nos. 183097c, 188915, 188916, 188923, 188924, two 183114c and four 1368zk (Obsolete)
188922	2189	Bobbin Winder (automatic), complete, Nos. 50zb, 180zb, 571c, 1528zj, 2749, 15286 to 15288zb, 15291, 15366, 15376zj, 15413, 15416zb, 32625zj, 32628zj, 50059zb, 50061zb, 50230zb, 90530, 183148zb, 188913 and 188959
*188923	—	Needle Holder (left) for 188405 and 188918
*188924	—	Needle Holder (right) for 188405 and 188918
188925	2176	Feed Rock Shaft Connecting Link with 460c, for 189706
188926	2182	Feed Rock Shaft Connecting Link Slide Block for 189706
188927	2177	Feed Eccentric with two 183026c

No.	Plate	
188928	2185	Feed Dog for 188930
188929	2185	Throat Plate (with oblong needle hole) for 188930
188930	—	Throat Plate (with oblong needle hole) 188929 with 189625 and two 51282zj, for zig-zag seams
188931	—	Throat Plate for 188932
188932	2194	Throat Plate 188931 with 189625 and two 51282zj, for straight seams, for 86609
188933	—	Throat Plate (narrow needle hole) for 188934
188934	—	Throat Plate 188933 with 189625 and two 51282zj
188938	2192	Traverse for joining butting edges
188944	2183	Rotating Hook Bobbin Case Holder for 188420
188949	2177	Needle Bar Crank with 1036c and 1065c
*188951	—	Bed, for 206K10 and 206K11 Machines
<i>NOTE.—Due to the accuracy required in setting Arm to Bed, these parts cannot be supplied separately and can only be sent out as a unit, Arm and Bed assembled.</i>		
188952	2179	Feed Lifting Rock Shaft Crank with 158c and 125330
188954	2184	Feed Rock Shaft
188955	2177	Feed Rock Shaft Adjusting Collar (left) with two 465al
188956	2179	Feed Bar Supporting Bracket with two 889c
188957	2182	Rotating Hook Bobbin Case Holder Position Bracket
188958	2178	Arm Shaft Bushing (back)
188959	2189	Bobbin Winder Bracket (belt cover) for 188922
188960	—	Presser Foot Plate for 188961
188961	—	Presser Foot (hinged) for silk, complete, Nos. 188960, 189644 and 189645
188997zb	2182	Thread Guard (front of arm)
188999	2184	Knee Lifter Lifting Lever for 188442 and 189714
189151	2193	Buttonhole Knife Handle for 86617
189152	2193	Buttonhole Knife $\frac{1}{2}$ " for 86617
189502	2186	Arm Top Cover with 189504
189504	2186	Arm Top Cover Spool Pin for 189502
189505	2176	Arm Side Cover (back)
189506	2184	Arm Shaft
189507	2178	Arm Shaft Bushing (front)
189510	2178	Arm Shaft Connection Belt Pulley Spring Ring for 188452
189512	2177	Arm Shaft Spiral Gear with two 183026c
189514	2186	Thread Take-up Crank for 189533

No.	Plate	
189515	2187	Needle Bar Connecting Link Hinge Block (upper) with 183011e, for 189695 ...
189517	2187	Needle Bar Connecting Link with two 183027c, for 189695 ...
189518	2187	Needle Bar Connecting Link Hinge Block (lower) for 189695 ...
189519	2187	Needle Bar Connecting Link Hinge Pin for 189695 ...
189520	2187	Needle Bar Connecting Stud with 400c and 465a1, for 189533 ...
189523	2187	Needle Clamp for 189694 ...
189525	2186	Needle Clamp Thread Guide for 189527 ...
189527	—	Needle Clamp, complete, Nos. 183014zb, 189525 and 189694, for 189781 ...
189532	2187	Needle Bar Height Indicator for 189776 ...
189533	—	Needle Bar Connection, complete, Nos. 1130e, 183012c, 189514, 189520 and 189695, for 188907 ...
189537	2186	Tension Releasing Lever for 206K18 and 206K19 Machines ...
189538	2186	Slack Thread Regulator ...
189541	2186	Face Plate Thread Guard 105004 with 125373, for 188904 ...
189542	2184	Arm Shaft Connection Belt (<i>order from Bridgeport</i>) ...
189547	2182	Rotating Hook Driving Shaft Bushing (front) ...
189550	2177	Feed Lifting Eccentric with two 183026c ...
189551	2177	Rotating Hook Driving Shaft Spiral Gear with two 183026c ...
189552	2177	Rotating Hook Shaft ...
189553	2182	Rotating Hook Shaft Bushing (back) ...
189554	2182	Rotating Hook Shaft Bushing (front) ...
189555	2177	Rotating Hook Shaft Adjusting Collar with two 1253c ...
189556	2178	Rotating Hook Driving Shaft Spiral Gear Case with 450a1 ...
189557	2178	Rotating Hook Driving Shaft Spiral Gear Case Cover ...
189571	2177	Feed Rock Shaft Adjusting Collar (right) with two 465a1 ...
189572	2179	Feed Rock Shaft Crank with 158c, for 189706 ...
189575	2176	Feed Bar ...
189577	2182	Feed Forked Connection for 189705 ...
189578	2182	Feed Forked Connection Shaft for 189705 ...
189579	2177	Feed Forked Connection Shaft Adjusting Collar with two 465a1 ...

No.	Plate	
189579	2177	Feed Lifting Rock Shaft Adjusting Collar with two 465a1 ...
189583	2181	Feed Lifting Rock Shaft ...
189585	2181	Feed Lifting Eccentric Fork with 158c ...
189586	2181	Feed Regulator Lever ...
189588	2179	Feed Regulator Connecting Rod ...
189589c	2201	Feed Regulator Connecting Rod Stud ...
189590	2179	Feed Regulator Indicator Plate ...
189591	2187	Feed Regulator Index ...
189592	2187	Feed Regulator Lever Thumb Nut Spring Bushing ...
189593	2187	Feed Regulator Lever Thumb Nut Spring ...
189594	2181	Feed Regulator Lever Thumb Nut ...
189595	2179	Feed Regulator Stop Block with two 447c ...
189597	2181	Needle Vibrator Fork Driving Shaft ...
189598	2177	Needle Vibrator Fork Driving Shaft Adjusting Collar with two 183026c ...
189599	2177	Needle Vibrator Cam Shaft Spiral Gear with two 183026c ...
189600	2184	Needle Vibrator Fork Connection ...
189601	2187	Needle Vibrator Fork Connection Rock Shaft ... (Obsolete)
189603	2187	Needle Vibrator Lever (back) with 180c ...
189604	2181	Needle Vibrator Lever (front) with 889c (Obsolete)
189605	2180	Needle Vibrator Lever Slide Bushing ...
*189608	—	Needle Vibrator Zero Position Control Bushing for 189611 ... (Obsolete)
*189609	—	Needle Vibrator Zero Position Control Lever for 189611 ... (Obsolete)
*189610	—	Needle Vibrator Zero Position Control Lever Handle for 189611 ... (Obsolete)
189611	2180	Needle Vibrator Zero Position Control Bushing 189608 with 189609 and 189610 (Obsolete)
189612	2180	Needle Vibrator Zero Position Control Eccentric with 453c, for 189674 ...
189613	2180	Needle Vibrator Amplitude Regulating Shaft for 189674 ...
189615	2180	Needle Vibrator Zero Position Control Plate with 183025zb, 183192c and 189675, for 189617 ...
189616	2180	Needle Vibrator Amplitude Regulating Lever Friction Spring for 189617 ...
189617	—	Needle Vibrator Zero Position Control Plate 189615 with 183228zb, 188436 and 189616, for 189674 ...

No.	Plate	
189618	2180	Needle Vibrator Amplitude Regulating Lever with 189673 and two 624c, for 189674 ...
189619	2180	Needle Vibrator Amplitude Regulating Scale (Obsolete)
189620	2180	Needle Vibrator Amplitude Regulating Lever Distance Washer for 189674 ...
189621	2186	Arm Cover (front) ...
189625	2185	Darning Plate Spring for 189723 ...
189625	2185	Embroidery Plate Spring for 189632 ...
189625	2185	Throat Plate Spring for 188930, 188932, 188934, 189637 and 189642 ...
189631	—	Embroidery Plate for 189632 ...
189632	2197	Embroidery Plate, complete, Nos. 189625, 189631 and two 51282zj, for 189662, for Embroidery and Darning ...
189634	—	Throat Plate ($\frac{3}{16}$ " spur), for 189637 ...
189637	2197	Throat Plate ($\frac{3}{16}$ " spur), 189634 with 189625 and two 51282zj for 189662, for Madeira Eyelet Work ...
189639	—	Throat Plate ($\frac{1}{4}$ " spur) for 189642 ...
189642	—	Throat Plate ($\frac{1}{4}$ " spur), 189639 with 189625 and two 51282zj for 189662, for Madeira Eyelet Work ...
189643	—	Presser Foot Sole for 189646 ...
189644	—	Presser Foot Shank for 188961 and 189646 ...
189645	—	Presser Foot Hinge Pin for 188961 and 189646
189646	2185	Presser Foot (hinged), complete, Nos. 189643 to 189645, for Zig-zag Stitching ...
189647	2192	Presser Foot for Straight Stitching, for 86609
189648	2192	Presser Foot for Button Sewing, for 86617
189649	2192	Presser Foot for Wide Ornamental and Zig-zag Seams, for 86617 ...
189650	2192	Presser Foot for Narrow Zig-zag Seams and Braiding, for 86609 ...
189651	2195	Presser Foot for Curved Ornamental and Zig-zag Seams ...
189653	2192	Hemmer Foot with 120810 and 120841 for Shell Seams, for 86617 ...
189654	2192	Hemmer Foot 189681 with 189682 for Rolled Seams, for 86617 ...
189657	—	Drip Pan with four nails $\frac{3}{8}$ ", for 206K18 and 206K19 Machines ...
189658	2196	Double Cord Guide, complete, Nos. 188912, 189677, 189678, two each 1607j, 183023j and 189666 for Madeira and Richelieu Work, for 189662 ...

No.	Plate	
189662	—	Embroidery Set, complete, Nos. 189632, 189637, 189642, 189658, 234463, 234467 and 234485 ...
*189663	2196	Double Cord Guide Adjustable Arm Frame for 188912 ...
189664	2196	Double Cord Guide Hinge Spring for 188912
189665	2196	Double Cord Guide Hinge Pin for 188912 ...
189666	2196	Double Cord Guide Adjustable Arm Hinge Screw Friction Washer for 189658 ...
189667	2196	Double Cord Guide Shank 189679 with 189680, for 188912 ...
*189668	—	Double Cord Guide Adjustable Arm (upper) for 189677 ...
*189669	—	Double Cord Guide Adjustable Arm (lower) for 189678 ...
*189670	—	Double Cord Guide Adjustable Arm (upper) Thread Guide Tube for 189677 ...
*189671	—	Double Cord Guide Adjustable Arm (lower) Thread Guide Tube for 189678 ...
189672	2182	Rotating Hook Driving Shaft Bearing (back) Oil Tube for 188905 and 188906 ...
189673	2180	Needle Vibrator Zero Position Control Lever Position Pin for 189618 ...
189674	—	Needle Vibrator Regulating Device, complete, Nos. 691za, 56038, 105001, 105002, 188412, 188416, 189612, 189613, 189617, 189618, 189620 and two 50156c ...
189675	2180	Needle Vibrator Zero Position Control Plate Pin for 189615 ...
189677	2196	Double Cord Guide Adjustable Arm (upper) 189668 with 189670, for 189658 ...
189678	2196	Double Cord Guide Adjustable Arm (lower) 189669 with 189671, for 189658 ...
*189679	—	Double Cord Guide Shank for 189667 ...
*189680	—	Double Cord Guide Shank Hinge Bracket for 189667 ...
189681	—	Hemmer Foot for 189654 ...
189682	—	Hemmer Folder for 189654 ...
189692	2195	Cording Foot for Narrow Raised Zig-zag Seams and Overedging of Light Material
189693	2192	Needle Threader, complete, Nos. 36805, 50315j, 189697 and three 189698 for threading from front to back, for 86609 ...
189694	—	Needle Clamp 189523 with 1498c and 183013za, for 189527 ...
189695	—	Needle Bar Connection, Nos. 189515, 189517, 189518 and two 189519 for 189533 ...

No.	Plate	
189696	2187	Arm Top Cover Hinge Screw Spring Washer
189697	2192	Needle Threader Handle for 189693 ...
189698	2192	Needle Threader Hook for 189693 ...
189699	—	Feed Restricting Attachment, complete, Nos. 109zb, 183024zb and 189700 to 189702 ...
189700	2195	Feed Restricting Attachment Carrier for 189699 ...
189701	2195	Feed Restricting Attachment Stirrup for 189699 ...
189702	2195	Feed Restricting Attachment Stirrup Friction Washer for 189699 ...
189704	2195	Presser Foot for Buttonholes $\frac{1}{4}$ " wide ...
189705	—	Feed Forked Connection 189577 with 2049 and 189578, for 189706 ...
189706	—	Feed Forked Connection, complete, Nos. 1550zj, 1637j, 183016c, 183017c, 188925, 188926, 189572 and 189705 ...
189707	2177	Knee Lifter Bell Crank Bracket for 189708 ...
189708	—	Knee Lifter Bell Crank 5596 with 5601, 56073 and 189707, for 188442 and 189714 ...
189710	2181	Knee Lifter Lifting Lever Connecting Rod for 188442 and 189714 ...
189711	2187	Presser Bar Lifting and Releasing Lever Bracket Link for 189713 ...
189712	2179	Presser Bar Lifting and Releasing Lever Bracket with 453c and 189715, for 189713 ...
189713	—	Presser Bar Lifting and Releasing Lever Bracket 189712 with 229c and 189711, for 206K10 and 206K11 Machines ...
189714	—	Knee Lifter, complete, Nos. 76zj, 802zj, 1521zj, 12416, 56081, 188999, 189708, 189710 and two 178e, for 206K10 and 206K11 Machines when used on $1\frac{1}{4}$ " Tables ...
189715	2187	Presser Bar Lifting and Releasing Lever Bracket Pin for 189712 ...
189716	2186	Tension Releasing Lever for 206K10 and 206K11 Machines ...
189719	—	Drip Pan with four nails $\frac{3}{8}$ ", for 206K10 and 206K11 Machines ...
189720	2192	Presser Foot, for Appliqué and Round Ornamental Scams, for 86617 ...
189722	—	Darning Plate (round hole) for 189723 ...
189723	2194	Darning Plate, complete, Nos. 189625, 189722 and two 51282zj for Embroidery and Darning, for 86609 ...
189748	2176	Needle Bar Holder for 189776 ...
189751	2195	Welt Foot for narrow welts, for 189800 ...

No.	Plate	
189752	2195	Welt Foot for broad welts, for 189800 ...
189773	2181	Needle Bar with 189774 for 189777 ...
189774	2186	Needle Bar Pin for 189773 ...
189776	—	Needle Bar Holder 189748 with 665zb and 189532 for 189777 ...
189777	—	Needle Bar Holder, complete, Nos. 183015c, 183038c, 189773 and 189776 ...
189781	—	Needle Holder (single), complete, Nos. 188430 and 189527 ...
189794	2192	Welt Traverse Clamp for 189800 ...
189795	2195	Welt Traverse for narrow welts, for 189800 ...
189796	2195	Welt Traverse for broad welts, for 189800 ...
189797	2195	Welt Tube for strip welts, for 189800 ...
189798	2195	Welt Foot for very narrow welts, for 189800 ...
189799	2195	Tension Middle Disc for 189800 ...
189800	—	Welting Attachment, complete, Nos. 665zj, 188406, 189751, 189752 and 189794 to 189799 ...

NUMERICAL LIST OF PARTS

No.	Plate		
234463	2196	Punch, for .055" holes, for 189662	...
234467	2196	Punch, for $\frac{3}{32}$ " holes, for 189662
234484	2193	Buttonhole Knife Plate (fibre) for 86617	...
234485	2199	Punch Mallet for 189662...