

SINGER
26W107

LIST OF PARTS



MACHINE No. 26w107

THE SINGER MANUFACTURING COMPANY

INDEX

	Page
Accessories	16
Bobbin Winder	16
Machine No.26w107	5
Miscellaneous Parts	19
Numerical List of Parts	21
Presser Folders	19
Starting Treadle	17
Thread Unwinder	17
Throat Plates	18

INSTRUCTIONS FOR ORDERING

In ordering from this list, use ONLY the PART number in the FIRST column.

The number stamped on a Sewing Machine Part is the number of the Single Part only, except when the part includes Set Screws, Clamping Screws, Studs and Rollers Spun on, Small Wires riveted, or Parts soldered together, etc., which it is necessary to furnish in combination.

Every combination of parts sent out has its specific number which, although not stamped on Parts (except in above case), must be used when ordering the combination.

Each number always indicates the SAME PART in whatever list it appears, or for whatever Machine.

The letters after some of the numbers indicate the style of finish only, as follows:

- A. Hardened, Polished, Nickel Plated and Buffed.
- B. Polished, Nickel Plated and Buffed
- C. Hardened only.
- D. Polished only.
- E. Soft, not polished.
- F. Hardened and Polished.
- H. Blued.
- J. Nickel Plated only.
- R. Merlized.
- X. Black Oxide.
- XC. Hardened and Black Oxide.
- Y. Blade Nickel only.

These letters MUST BE USED when they appear in the list and AFTER the number, as in the list.

In this series

200001 to 201500 and 350001 to 351500 are Screw Numbers.
 201501 to 201800 and 351501 to 351800 are Nut Numbers.
 201801 to 202000 and 351801 to 352000 are Roller Numbers.
 202001 to 350000 are Numbers of Machine Parts.

The figures in the second column refer only to the plate in which the illustration of the part is shown and are TO BE USED in ordering.

Two or more numbers over a cut indicate that the difference between such parts is not visible in an illustration.

Parts marked with an asterisk (*) are furnished when repairs are made at the factory.

LIST OF PARTS COMPLETE FOR

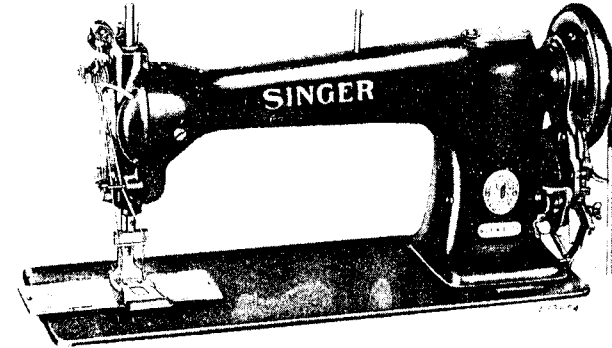

MACHINE No. 26w107

DROP FEED. VERTICAL HOOK. LOCK STITCH.
 COUNTING STOP MOTION.
 For Stitching Labels on Shirts, Underwear,
 Rugs, Blankets, etc.
 In Gauges from 3/8 to 2 inches.

No.	Plate	Name
*221265	-----	Arm
204163	13051	" Cap
200278H	13051	" " Screw
202248	13051	" " " Washer
204235	13051	" Position Pin (2)
200963E	13051	" Screw (3)
202005	13051	" " Washer (3)
221266	13051	" Shaft
204736	13051	" " Rushing (back)
200383C	13051	" " " " Set Screw
221268	13051	" " " (front)
200338C	13051	" " " " Set Screw
204440	13051	" " Connection with four 200054E (2)

No.	Plate	Name
200054E	13051	Arm Shaft Connection Screw
207833	13051	Balance Wheel (belt groove 2-3/4 in. diam.)
200776D	13051	Balance Wheel Adjusting Screw
207834	13051	Balance Wheel complete, Nos. 204741, 207833, 207843, 223002, 235396, three each 200233C, 204744 and four 200567H
*215756	-----	Bed with 200840E, 202299, 203376, 204438, 213124 two each 200362C and 200516E
202258	13051	Bed Hinge Connection (2)
200570E	13051	" " Screw (4)
203329	13052	" Slide (back)
203301	13052	" " (front), for gauges from 3/8 to 1 inch
213750B	13052	Bed Slide (front), for gauges from 1-1/32 to 2 inches
203208	13057	Bobbin
203210	13057	" Case Base with 202056, 203211 to 203213 and 203216
203211	13057	Bobbin Case Base Latch
*202056	-----	" " " " Pin
203212	13057	" " " " Plunger
203213	13057	" " " " Spring
203209	13057	" " Cap with 200984C, 203214, 203215 and two 200594C
203214	13057	Bobbin Case Tension Spring
200984C	13057	" " " " Regulating Screw
200594C	13057	" " " " Screw
203215	13057	" " Thread Guide
200594C	13057	" " " " Screw
203216	13057	" " Washer (cloth)
203217	13057	Bobbin Case complete, Nos. 203209 and 203210
206037	13059	Count Regulating Index Lever (20 to 60), with two 204190
350058E	13059	Count Regulating Index Lever Slide
203357	13059	" " " " " Washer
201528F	13059	" " " " " Nut
206039	13059	Counting Wheel
206040	13059	" " 206039 with 200162D and 206057 to 206059
206041	13059	Counting Wheel Driving Clutch
206042	13059	" " " " Spring
204190	13059	" " " " Hook
206043	13059	" " " Eccentric with 202090
206044	13059	Counting Wheel Driving Eccentric 206043 with 206046
221267	13059	Counting Wheel Driving Eccentric Pitman with 204923

No.	Plate	Name
204923	13059	Counting Wheel Driving Eccentric Pitman Bearing
202090	13059	Counting Wheel Driving Eccentric Position Pin
200013E	13059	Counting Wheel Driving Eccentric Screw Stud
206046	13059	Counting Wheel Driving Eccentric Washer
206047	13059	" " Retaining Clutch with 204189
206048	13059	Counting Wheel Retaining Clutch Position Pin
204443	13059	Counting Wheel Retaining Clutch Spring
204189	13059	" " " " " Hook
204321	13059	" " " " " Pin
200211E	13059	" " Screw Stud
200335C	13059	" " " " Set Screw
206050	13059	Counting Wheel complete, Nos. 206037, 206040, two each 206041 and 206042
206051	13055	Emergency Stop
206098	13055	" " Driving Pin
206052	13055	" " Handle with 206098
206053	13055	" " Spring
200158B	13055	" " " Stop Screw
228043	13055	" " " " Washer
204533	13061	Face Plate with 200366H, 204730, two each 200368H, 202090, 204281 and three 200397H
200053C	13061	Face Plate Screw
204730	13061	" " Thread Guide
200397H	13061	" " " " Set Screw
204874	13061	Face Plate complete, Nos. 200135E, 200319C, 200577XC, 204277 to 204280, 204533, 204555, two each 200309E, 204059 and 204272
203303	13053	Feed Bar with 204189
203309	13053	" " 203303 with 200214E, 201525E and 204200
200214E	13053	Feed Bar Hinge Screw
201525E	13053	" " " " Nut
214424	13053	" " Spring
204189	13053	" " Hook
211669	13063	" Dog, for 211666
211674	13063	" " " 211671
211679	13063	" " " 211676
211685	13064	" " " 211681
236440	13064	" " " 211686
211693	13064	" " " 211690
211910	13065	" " " 211909
211698	13066	" " " 211695
236452	13065	" " " 211699

PARTS FOR MACHINE No. 26w107

No.	Plate	Name
211707	13065	Feed Dog, for 211704
211712	13066	" " " 211709
200106E	13063	" " Screw (2)
203233	13054	" Driving Cam with 200382C and 200437C
204192	13053	" " " Fork Lever
204197	13053	" " " " " Collar with 200113F
200113F	13053	Feed Driving Cam Fork Lever Collar Set Screw
213688	13053	Feed Driving Cam Fork Lever Connection with 200668C, 201525E and 204189
204194	13053	Feed Driving Cam Fork Lever Connection Clamp with 200031F
200031F	13053	Feed Driving Cam Fork Lever Connection Clamp Pinch Screw
200668C	13053	Feed Driving Cam Fork Lever Connection Clamp Screw Stud
201525E	13053	Feed Driving Cam Fork Lever Connection Clamp Screw Stud Nut
200002E	13053	Feed Driving Cam Fork Lever Connection Hinge Screw
201522E	13053	Feed Driving Cam Fork Lever Connection Hinge Screw Nut
206053	13053	Feed Driving Cam Fork Lever Connection Spring
204189	13053	Feed Driving Cam Fork Lever Connection Spring Hook
202090	13053	Feed Driving Cam Fork Lever Connection Spring Pin
204968	13053	Feed Driving Cam Fork Lever Sleeve (split)
200043C	13053	Feed Driving Cam Fork Lever Sleeve Set Screw
201524E	13053	Feed Driving Cam Fork Lever Sleeve Set Screw Nut
204198	13053	Feed Driving Cam Fork Lever complete, Nos. 204192 and 204194
200437C	13054	Feed Driving Cam Position Screw
200382C	13054	" " " Set Screw
204294	13053	" " Rock Shaft
204439	13053	" " " " 204294 with 200002E 201522E and 213688
202305	13053	Feed Driving Rock Shaft Center (2)
200043C	13053	" " " " " Set Screw (2)
204200	13053	Feed Driving Rock Shaft Crank with 204189 (on left side) and two 200383C
200383C	13053	Feed Driving Rock Shaft Crank Set Screw
203235	13054	" Lifting Cam with 202126

PARTS FOR MACHINE No. 26w107

No.	Plate	Name
204202	13053	Feed Lifting Cam Fork with 200027E
200027E	13053	" " " " Pinch Screw
202126	13054	" " " Position Pin
200045E	13054	" " " Screw
203305	13053	" " Rock Shaft
203315	13053	" " " " 203305 with 203238
202305	13053	" " " " Center (2)
200043C	13053	" " " " Set Screw (2)
202276	13053	" " " " Slide Block
203238	13053	" " " " " 202276 with 200243E and 201531E
200243E	13053	Feed Lifting Rock Shaft Slide Block Hinge Screw
201531E	13053	Feed Lifting Rock Shaft Slide Block Hinge Screw Nut
206055	13055	Feed Regulating Lever
206056	13055	" " " 206055 with 200365C 200457D, 201525E, 201583C and 201804
206057	13059	Feed Regulating Lever Barring Cam (in- side adjustable)
206058	13059	Feed Regulating Lever Barring Cam (out- side adjustable)
201804	13055	Feed Regulating Lever Barring Cam Roller and Stud
201525E	13055	Feed Regulating Lever Barring Cam Roller and Stud Nut
206059	13059	Feed Regulating Lever Barring Cam Stud
200162D	13059	" " " " " " " Screw
200457D	13055	Feed Regulating Lever Position Thumb Screw
201583C	13055	Feed Regulating Lever Position Thumb Screw Wing Nut
221269	13055	Feed Regulating Lever Shaft
204211	13055	" " " " " Crank with 200098F
204212	13055	Feed Regulating Lever Shaft Crank Link
200271E	13055	" " " " " " Hinge Screw (lower)
200291E	13055	Feed Regulating Lever Shaft Crank Link Hinge Screw (upper)
200098F	13055	Feed Regulating Lever Shaft Crank Set Screw
200365C	13055	Feed Regulating Lever Shaft Set Screw
204378	13055	" " " " Sleeve
200362C	13055	" " " " Set Screw
202622	13055	" " " " Washer
221270	13055	Feed Regulating Lever complete, Nos. 202622, 204378, 206056 and 221269
*203239	-----	Hook (sewing)

No.	Plate	Name
203240	13057	Hook 203239 with 201253F, 201376F and 203251
203290	13057	Hook and Bobbin Case complete, Nos. 203217 and 203240
203241	13056	Hook Bevel Gear Socket, 24 teeth
213630	13054	" " " Oil Guard (left) (back)
213367	13054	Hook Bevel Gear Socket Oil Guard (left) (front)
213633	13054	Hook Bevel Gear Socket Oil Guard (right) (back)
213368	13054	Hook Bevel Gear Socket Oil Guard (right) (front)
200099H	13054	Hook Bevel Gear Socket Oil Guard Screw (4)
200555H	13056	Hook Bevel Gear Socket Screw
203242	13054	" " Pinion, 24 teeth, with two 200383C (2)
200383C	13054	Hook Bevel Pinion Set Screw
213136	13054	" Counter Shaft
203244	13054	" " " Collar with two 200393C
200393C	13054	" " " Set Screw
203245	13054	" " " Driving Gear, 44 teeth, with 200362C and 200439C
213154	13054	Hook Counter Shaft Driving Gear 203245 with 200045E and 203235
200439C	13054	Hook Counter Shaft Driving Gear Position Screw
200362C	13054	Hook Counter Shaft Driving Gear Set Screw
203246	13054	Hook Counter Shaft Gear, 22 teeth, with two 200383C
200383C	13054	Hook Counter Shaft Gear Set Screw
202299	13054	" " " Oil Packing (wick)
200840E	13054	" " " " " Stop Screw
221271	13054	Hook Driving Shaft
*204438	13054	" " " Bearing
202299	13054	" " " Oil Packing (wick)
202126	13054	Hook Driving Shaft Bearing Position Pin
200516E	13054	" " " Screw
213124	13054	" " " Bushing (eccentric)
202299	13054	" " " Oil Packing (wick)
200362C	13054	Hook Driving Shaft Bushing Set Screw
213141	13054	" " " Collar with two 200393C
200393C	13054	Hook Driving Shaft Collar Set Screw
203251	13057	" Gib

No.	Plate	Name
201376F	13057	Hook Gib Hinge Screw
201253F	13057	" " Screw
203542	13056	" Saddle (left), with 200840E and two 202299
203541	13056	Hook Saddle (right), with 202299
202299	13056	" " Oil Packing (wick)
200006E	13056	" " Screw (4)
225585	13056	" " Washer (4)
203254	13056	" Washer
203544	13056	Hook Saddle (left) complete, Nos. 200555H, 203241, 203254, 203290 and 203542
203543	13056	Hook Saddle (right) complete, Nos. 200555H 203241, 203254, 203290 and 203541
203545	13056	Hook Saddle Combination (left and right) complete, Nos. 203543 and 203544
207843	13051	Machine Driving Friction (leather)
204741	13051	" " " Clamp
204742	13055	" " " " Operating Washer
204743	13055	Machine Driving Friction Clamp Operating Washer Incline Lever
200233C	13051	Machine Driving Friction Clamp Screw
204744	13051	" " " Spring
235396	13051	" " " Position Plate
200567H	13051	" " " " Screw
207836	13055	" Incline Lever
207890	13051	" " " Bearing with 200383C and 204736
200565E	13051	Machine Incline Lever Bearing Screw (3)
201072D	13055	" " " Screw
202622	13055	" " " Washer
206070	13059	" Starting Lever with 204189
206063	13052	" " " Position Collar with two 200380C
200380C	13052	Machine Starting Lever Position Collar Set Screw
201822	13055	Machine Starting Lever Roller
200991F	13055	" " " " Screw Stud
201525E	13055	" " " " " Nut
225837	13055	" " " " " Washer
206064	13059	Machine Starting Lever Spring
204189	13059	" " " " Hook
204321	13059	" " " " Pin
206065	13052	" " " Starting Rod with 202302
206199	13052	Machine Starting Lever Starting Rod 206065 with two 206063
206063	13052	Machine Starting Lever Starting Rod Collar with two 200380C

No.	Plate	Name
200380C	13052	Machine Starting Lever Starting Rod Collar Set Screw
202302	13052	Machine Starting Lever Starting Rod Cotter Pin
223002	13051	Machine Stop Cam with 200328C, 200335C, 200370C, 204747 and 206427
204747	13051	Machine Stop Cam Friction Ring (leather)
206427	13051	" " " " " Position Pin
200328C	13051	Machine Stop Cam Position Screw
200370C	13051	" " " " " Check Screw
200335C	13051	Machine Stop Cam Set Screw
204748	13055	" " " " Slide
200249F	13055	" " " " Hinge Screw
201525E	13055	" " " " " Nut
206066	13055	" " " " Lever with 202108
206067	13055	" " " " " 206066 with 200158B, 200249F, 200991F, 201822, 204748, 206051 to 206053, 225837, 228043 and two 201525E
200258D	13055	Machine Stop Cam Slide Lever Hinge Screw
201522E	13055	" " " " " " Nut
202108	13055	Machine Stop Cam Slide Position Pin
231390	13058	Needle Bar (hollow)
204248	13058	" " Connecting Link
200658C	13058	" " " " Hinge Screw Stud
201519E	13058	Needle Bar Connecting Link Hinge Screw Stud Nut
204249	13058	Needle Bar Connecting Stud with 200072C and 202277
202277	13058	Needle Bar Connecting Stud Oil Packing (wick)
200072C	13058	Needle Bar Connecting Stud Pinch Screw
204327	13058	" " Packing Washer (felt) (2)
200504E	13058	" " Screw Bushing (lower)
200503B	13058	" " " " (upper)
231383	13058	" Holder, in gauges from 3/8 to 1/2 in., in steps of 1/32 in., with 201030F and two 200141F
231385	13058	Needle Holder, in gauges from 17/32 to 3/4 in., in steps of 1/32 in., with 201030F and two 200141F
231386	13058	Needle Holder, in gauges from 25/32 to 2 in., in steps of 1/32 in., with 201030F and two 200141F
201030F	13058	Needle Holder Screw
200141F	13058	" Set Screw
204251	13060	Presser Bar (hollow) with 200074F

No.	Plate	Name
204252	13060	Presser Bar Lifter
200550C	13060	" " " Hinge Screw
204253	13060	" " Lifting Bracket with 200086C
200086C	13060	" " " " Pinch Screw
203460	13060	" " " " Position Guide
200362C	13060	" " " " " " " Set Screw
204327	13060	Presser Bar Packing Washer (felt)
200504E	13060	" " Screw Bushing (lower)
204255	13060	" " Spring
200491B	13060	" " Thumb Screw (pressure regulating)
230133	13062	Presser Folder, 46 needle hole, in gauges from 3/8 to 1-1/4 in., in steps of 1/32 in., folds both edges of label
231232	13062	Presser Folder, 46 needle hole, in gauges from 1-9/32 to 2 in., in steps of 1/32 in., folds both edges of label
206387	13052	Presser Foot Lifting and Starting Rod Lever
200224H	13052	Presser Foot Lifting and Starting Rod Lever Hinge Screw
206388	13052	Presser Foot Lifting Lever Bracket
200563H	13052	" " " " " " Screw (2)
227476	13052	Presser Foot Lifting Lever Connection Rod with 202302
206389	13052	Presser Foot Lifting Lever Connection Rod 227476 with 203058
202302	13052	Presser Foot Lifting Lever Connection Rod Cotter Pin
203058	13052	Presser Foot Lifting Lever Connection Rod Coupling with 200530C
200530C	13052	Presser Foot Lifting Lever Connection Rod Coupling Set Screw
200074F	13060	Presser Foot Screw
212920	13058	Take-up Cam with 200335C and 200430C
203268	13058	" " 212920 with 200383C, 200658C and 201519E
200430C	13058	Take-up Cam Position Screw
200383C	13058	" " " " Check Screw
200335C	13058	" " Set Screw
204553	13058	" Lever
206601	13058	" " 204553 with 204263
204263	13058	" " Bearing with 204264
204264	13058	" " " Position Pin
200042F	13058	" " " Screw
201816	13058	" " Roller

No.	Plate	Name
204554	13058	Take-up Lever complete, Nos. 200042F, 201816 and 206601
244048	13061	Tension Disc
202090	13061	" " Position Pin
204555	13061	" Release Lever
200309E	13061	" " " Screw
202075	13061	" " Plunger
208489	13060	" " Slide
206608	13060	" " " Spring
202407	13061	" Spring
200632B	13061	" Stud
200397H	13061	" " Set Screw
201572B	13061	" Thumb Nut
204271	13061	" Washer
204272	13061	Tension complete, Nos. 200632B, 201572B, 202075, 202407, 204271 and two 244048
204273	13060	Thread Controller Adjusting Collar with 200684H (for Presser Bar)
200684H	13060	Thread Controller Adjusting Collar Screw
204274	13061	" " Plate
200577XC	13061	" " " Screw
202098	13061	" " Roller
204275	13061	" " " Guard
202084	13061	" " " Washer
200300C	13061	" " " Screw
204276	13061	" " Spring
204333	13061	" " Guard
200581H	13061	" " " Screw
204277	13061	" " " Stop
204278	13061	" " " Driving Gear
200319C	13061	" " " " " Hinge Screw
200135E	13061	Thread Controller Spring Stop Screw
204279	13061	" " " Stud with 204925
200366H	13061	" " " " Set Screw
204925	13061	" " " " Washer
205987	13061	Thread Controller complete, Nos. 200300C, 200581H, 202084, 202098, 204274, 204275 and 204333
204280	13061	Thread Controller and Spring complete, Nos. 204276 and 205987
203313	13051	Thread Guide
204556	13051	" " "
204281	13061	" Retainer Guide Wire
202091	13061	" " Sleeve
202092	13061	" " Spring
204058	13061	" " Stud
200368H	13061	" " " Set Screw
204059	13061	Thread Retainer complete, Nos. 202091, 202092 and 204058

No.	Plate	Name
211666	13063	Throat Plate, 50 needle hole, for needle sizes 14 and 15, in gauges 3/8, 13/32, 7/16, 15/32 and 1/2 in., for 211669
211671	13063	Throat Plate, 50 needle hole, for needle sizes 14 and 15, in gauges 17/32, 9/16 19/32 and 5/8 in., for 211674
211676	13063	Throat Plate, 50 needle hole, for needle sizes 14 and 15, in gauges 21/32 and 11/16 in., for 211679
211681	13064	Throat Plate, 50 needle hole, for needle sizes 14 and 15, in gauges from 23/32 to 7/8 in., in steps of 1/32 in., for 211685
211686	13064	Throat Plate, 50 needle hole, for needle sizes 14 and 15, in gauges from 29/32 to 1-1/8 in., in steps of 1/32 in., for 236440
211690	13064	Throat Plate, 50 needle hole, for needle sizes 14 and 15, in gauges 1-5/32 and 1-3/16 in., for 211693
211909	13065	Throat Plate, 50 needle hole, for needle sizes 14 and 15, in 1-7/32 in. gauge, for 211910
211695	13066	Throat Plate, 50 needle hole, for needle sizes 14 and 15, in gauges 1-1/4, 1-9/32 and 1-5/16 in., for 211698
211699	13065	Throat Plate, 50 needle hole, for needle sizes 14 and 15, in gauges from 1-3/8 to 1-5/8 in., in steps of 1/32 in., for 236452
211704	13065	Throat Plate, 50 needle hole, for needle sizes 14 and 15, in gauges from 1-21/32 to 1-13/16 in., in steps of 1/32 in., for 211707
211709	13066	Throat Plate, 50 needle hole, for needle sizes 14 and 15, in gauges 1-7/8, 1-29/32, 1-15/16, 1-31/32 and 2 in., for 211712
200161D	13063	Throat Plate Clamp Screw
203376	13063	" " Position Pin
200577XC	13063	" " Screw

ACCESSORIES

No.	Plate	Name
200157B	13052	Attachment Screw
203208	13057	Bobbin (10)
*225482	-----	" Case Screw Driver Blade
*225483	-----	" " " " Handle
225497	13067	Bobbin Case Screw Driver complete, Nos. 225482 and 225483
128 x 3	13058	Needles, six each, sizes 12 and 14
228213	13068	Drip Pan (long) with four 1 in. wire nails
41400	13067	Machine Rest Pin (wood)
120342	13067	Oiler (copper plated) with 120343
120343	13067	" Spout, 3-1/2 in. long
*225484	-----	Screw Driver Blade
*225485	-----	" " Handle
225498	13067	Screw Driver complete (7-1/4 in. long) Nos. 225484 and 225485
225554	13067	Wrench (steel)

BOBBIN WINDER

(SWINGING AUTOMATIC, RIGHT HAND)

225453	17619	Frame with 202277 and 225438
225454	17619	" Hinge Pin
202277	17619	" Oil Packing (wick)
225438	17619	" " Well Cap
225455	17619	" Spring
225456	17619	" " Plunger
202473	17619	Pulley with 200380C
200380C	17619	" Set Screw
225381	17619	Spindle
225444	17619	Stop Latch
200056E	17619	" " Screw
225458	17619	" " Thumb Lever
225459	17619	" " " " Hinge Stud
225459	17619	" " " " Joint Stud
202478	17619	" " Trip Lever
200299H	17619	" " " " Hinge Screw
225461	17619	Tension Bracket with 201499B
200082D	17619	" " Screw
228026	17619	" " " Washer
2102	17619	" Disc
202407	17619	" Spring
201499B	17619	" Stud
201572B	17619	" " Thumb Nut
225462	17619	Bobbin Winder Tension Bracket complete, Nos. 201572B, 202407, 225461 and two 2102

No.	Plate	Name
225433	17619	Bobbin Winder and Tension Bracket Base
225382	17619	Universal Bobbin Winder complete, Nos. 200056E, 200082D, 200299H, 202473, 202478 225301, 225433, 225444, 225453 to 225456 225458, 225462, 228026, two each 225459 and wood screws 3/4 in., No. 12, R.H.B.

STARTING TREADLE

126036	13068	Treadle
126037	13068	" 126036 with 2718R, 50581R and 126038
126038	13068	" Extension
50581R	13068	" " Screw
2718R	13068	" " " Washer
204696	13068	" Lifting Spring
204697	13068	" " " Hook (bench)
227956	13068	" Pitman Rod (lower)
204698	13068	" " " (upper) with 202302
204126	13068	" " " Clamp with two 200530C
200530C	13068	" " " " Set Screw
202302	13068	" " " Cotter Pin
206386	13068	" Stand (left or right) with two wood screws 1 in., No. 12
228189	13068	Treadle complete, Nos. 126037 and two 206386
227957	13068	Treadle Pitman complete, Nos. 204696 to 204698, 227956 and two 204126
228190	13068	Starting Treadle and Pitman complete, Nos. 227957 and 228189

THREAD UNWINDER

(FOR THREE SPOOLS)

225259	16257	Spool Rest (for one spool) with 201018C
225257	16257	" " (for two spools) with 201018C
150203	16257	" " Cushion (felt)
225388	16257	" " Rod
200383C	16257	" " " Set Screw
201018C	16257	" " Set Screw
202490	16257	" Stand with 200383C

ACCESSORIES

No.	Plate	Name
225391	16257	Thread Guide
201696J	16257	" " Lock Nut
225326	16257	" " Position Cup
225324	16257	" " Rod with 208E and 225322
208E	16257	" " " Screw
225322	16257	" " " Washer
259143	16257	Thread Unwinder (for three spools) complete, Nos. 201696J, 202490, 225257, 225259, 225324, 225326, 225388, three each 150203, 225391 and wood screws 7/8 in. No. 12

THROAT PLATES

211666	13063	Throat Plate, 50 needle hole, for needle sizes 14 and 15, in gauges 3/8, 13/32, 7/16, 15/32 and 1/2 in., for 211669
211671	13063	Throat Plate, 50 needle hole, for needle sizes 14 and 15, in gauges from 1/2 to 5/8 in., in steps of 1/32 in., for 211674
211676	13063	Throat Plate, 50 needle hole, for needle sizes 14 and 15, in gauges 19/32, 5/8, 21/32 and 11/16 in., for 211679
211681	13064	Throat Plate, 50 needle hole, for needle sizes 14 and 15, in gauges from 23/32 to 7/8 in., in steps of 1/32 in., for 211685
211686	13064	Throat Plate, 50 needle hole, for needle sizes 14 and 15, in gauges from 13/16 to 1-1/8 in., in steps of 1/32 in., for 236440
211690	13064	Throat Plate, 50 needle hole, for needle sizes 14 and 15, in gauges from 1 to 1-3/16 in., in steps of 1/32 in., for 211693
211909	13065	Throat Plate, 50 needle hole, for needle sizes 14 and 15, in gauges from 1-1/16 to 1-1/4 in., in steps of 1/32 in., for 211910
211695	13066	Throat Plate, 50 needle hole, for needle sizes 14 and 15, in gauges 1-1/4, 1-9/32 and 1-5/16 in., for 211698
211699	13065	Throat Plate, 50 needle hole, for needle sizes 14 and 15, in gauges from 1-3/8 to 1-5/8 in., in steps of 1/32 in., for 236452

THROAT PLATES

No.	Plate	Name
211704	13065	Throat Plate, 50 needle hole, for needle sizes 14 and 15, in gauges from 1-9/16 to 1-13/16 in., in steps of 1/32 in., for 211707
211709	13066	Throat Plate, 50 needle hole, for needle sizes 14 and 15, in gauges from 1-7/8 to 2 in., in steps of 1/32 in., for 211712

PRESSER FOLDERS

230133	13062	Presser Folder, 46 needle hole, in gauges from 3/8 to 2 in., in steps of 1/32 in., folds both edges of label
231232	13062	Presser Folder, 46 needle hole, in gauges from 1-9/32 to 2 in., in steps of 1/32 in., folds both edges of label

MISCELLANEOUS PARTS

USED IN CONJUNCTION WITH THREAD UNWINDER

60913	16257	Spool Weight with 60914
60914	16257	" " Center Pin
225377	16257	" Wire, for small spools
27739	16257	Thread Cone (wood)
225390	16257	" " Holder

Genuine Singer Needles should be used
in Singer Machines.
These Needles and their Containers
are marked with the
Company's Trade Mark "SIMANCO." 1

Needles in Containers marked
"For Singer Machines"
are not Singer made needles. 2

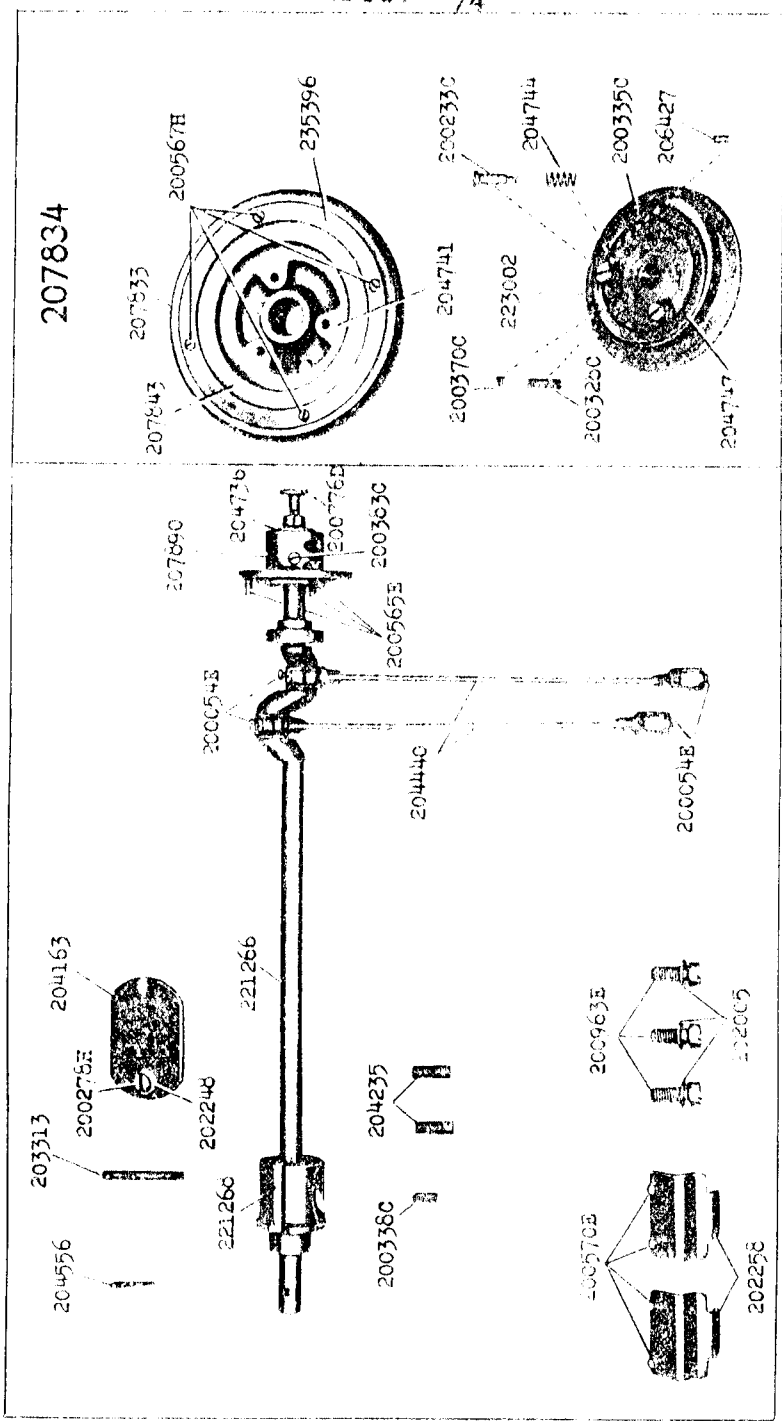

207834

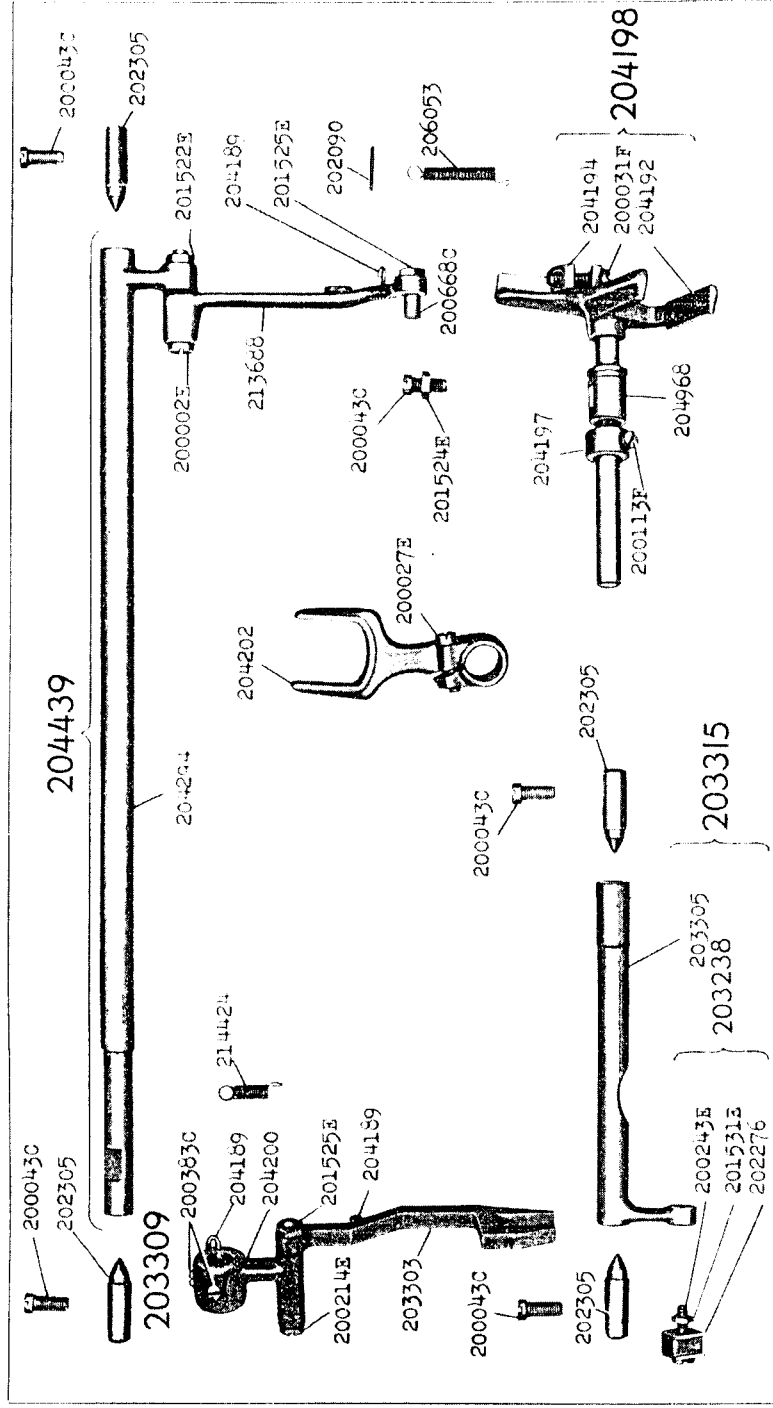
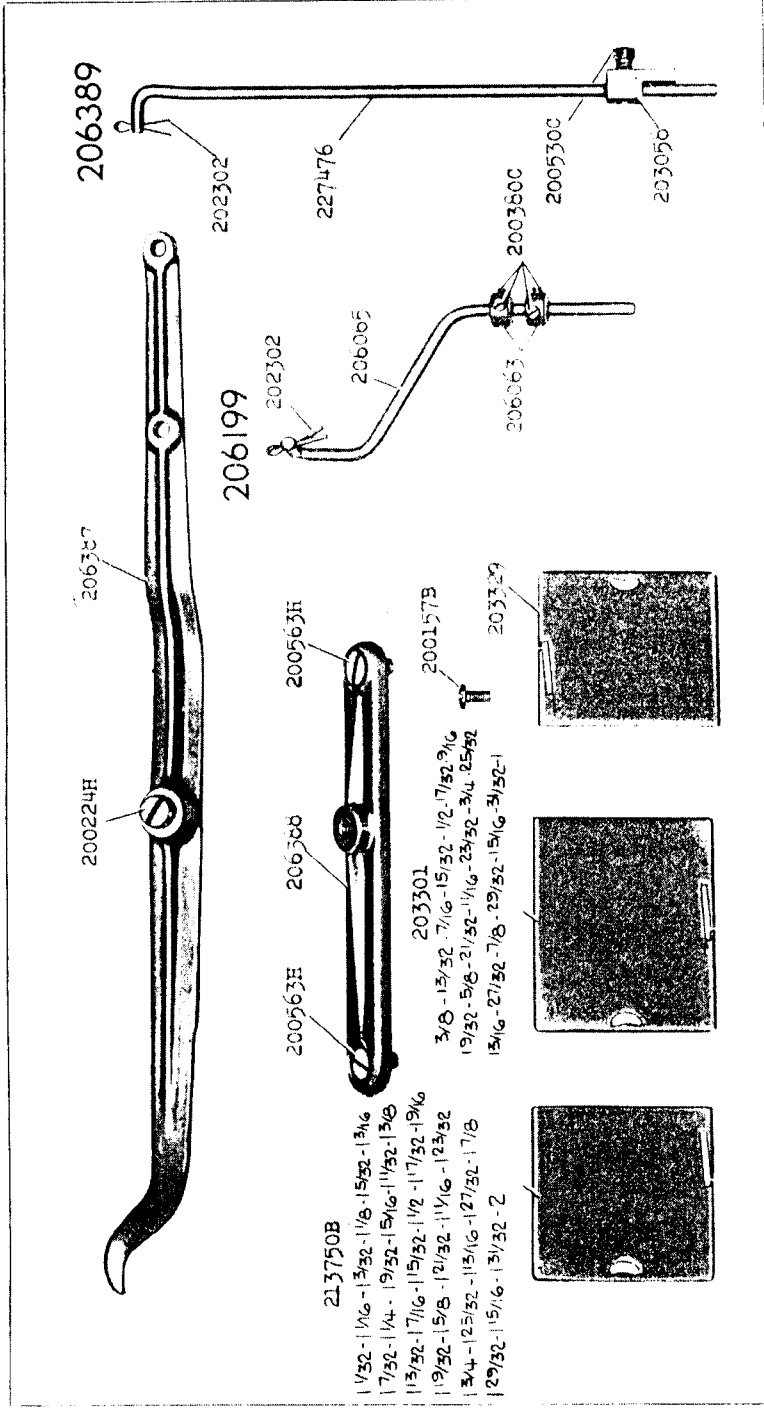

203545

203544



203542

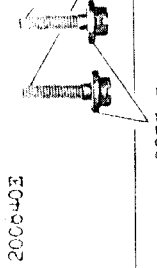
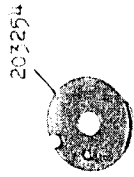
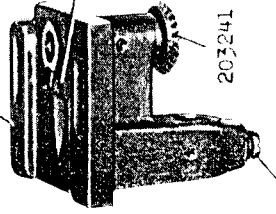

203543

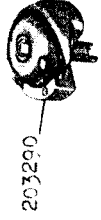

203541

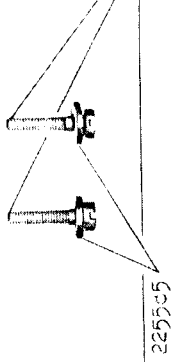
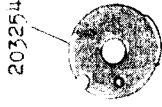
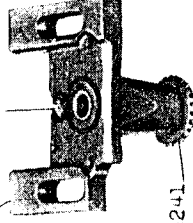

203290

203217

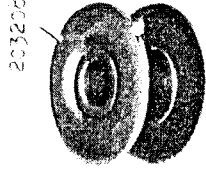
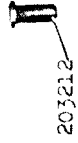
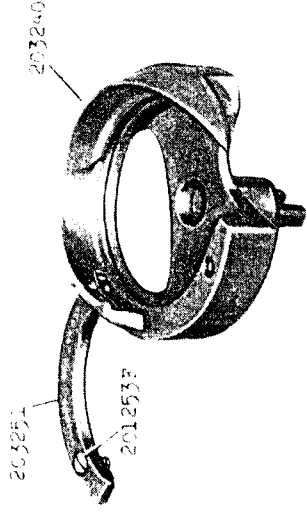
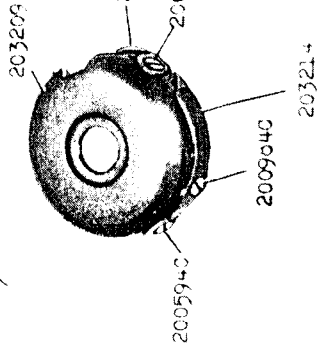

13058 - 1/2

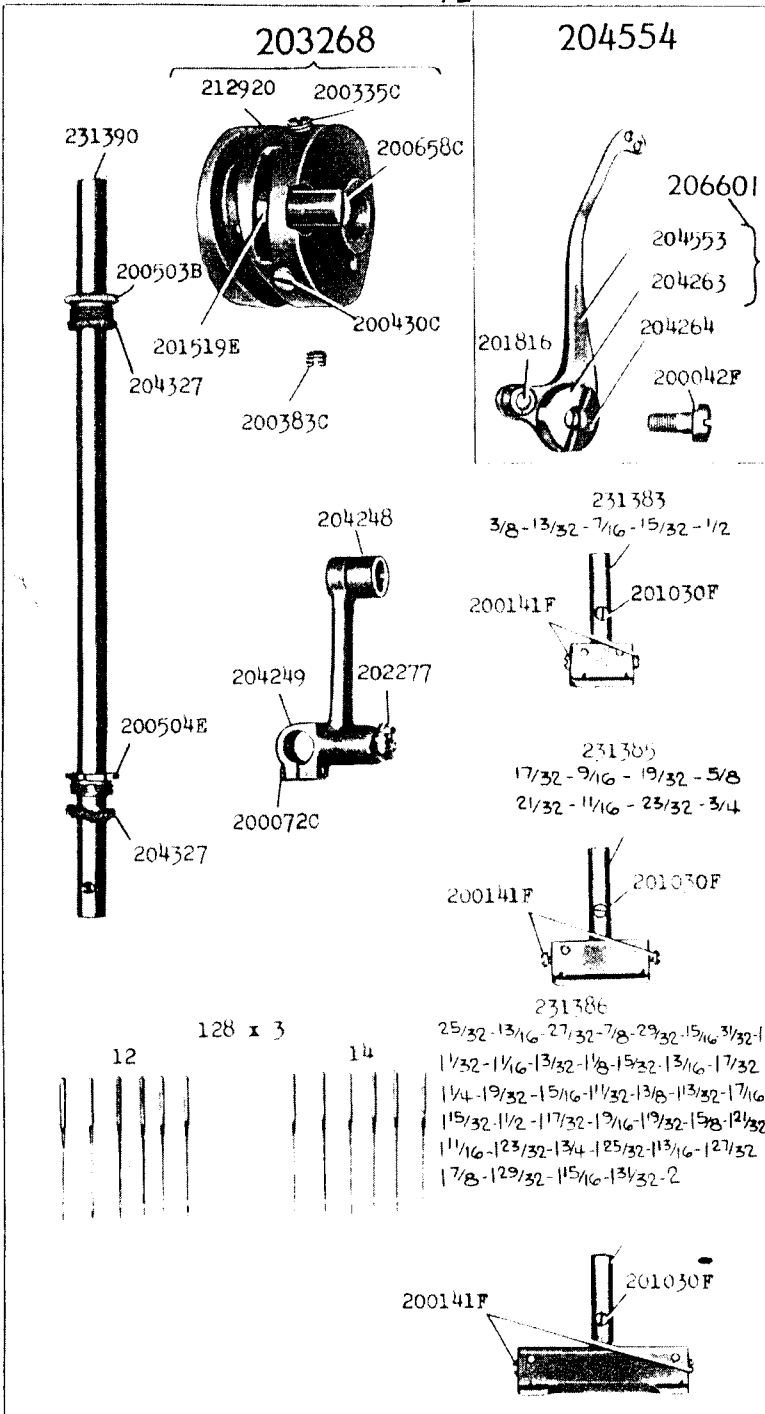

13059 - 3/8

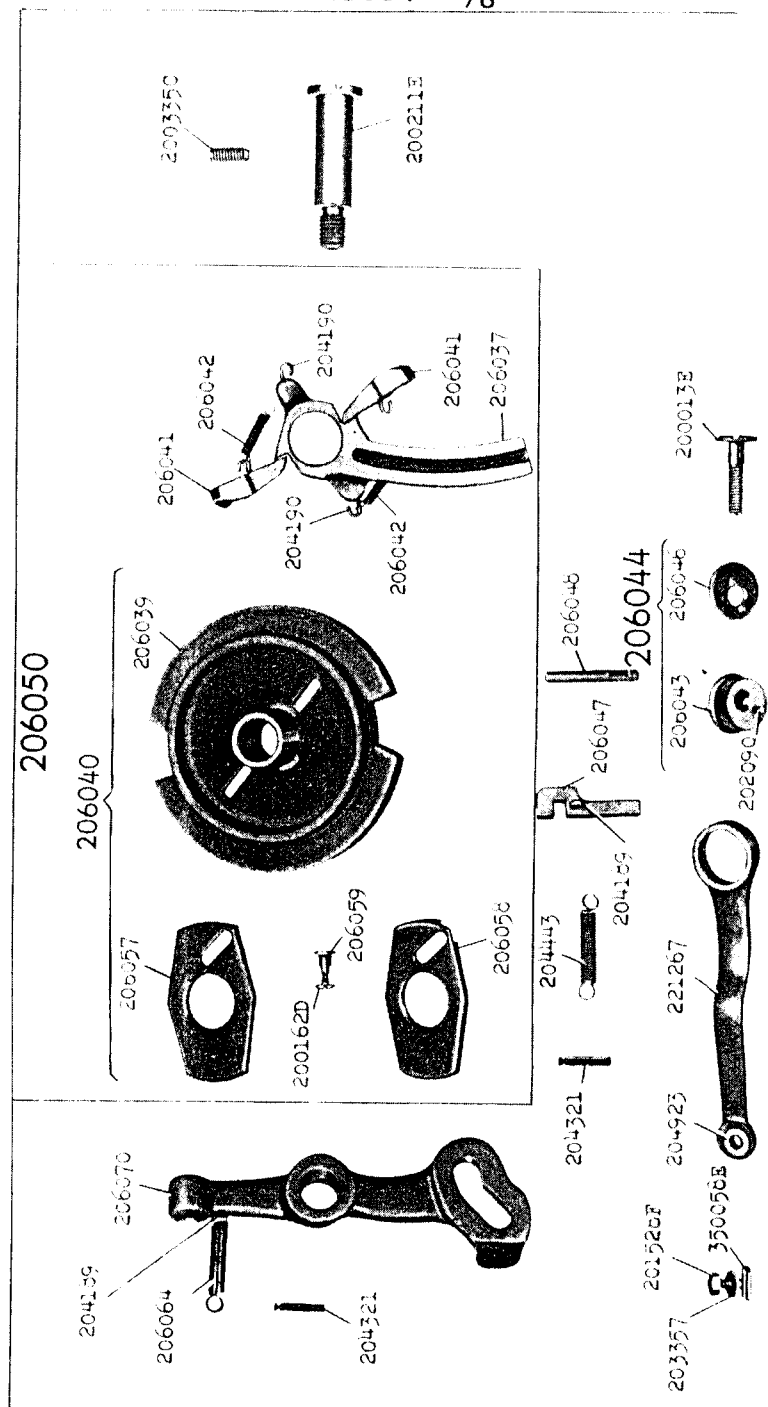

13060 - 1/2

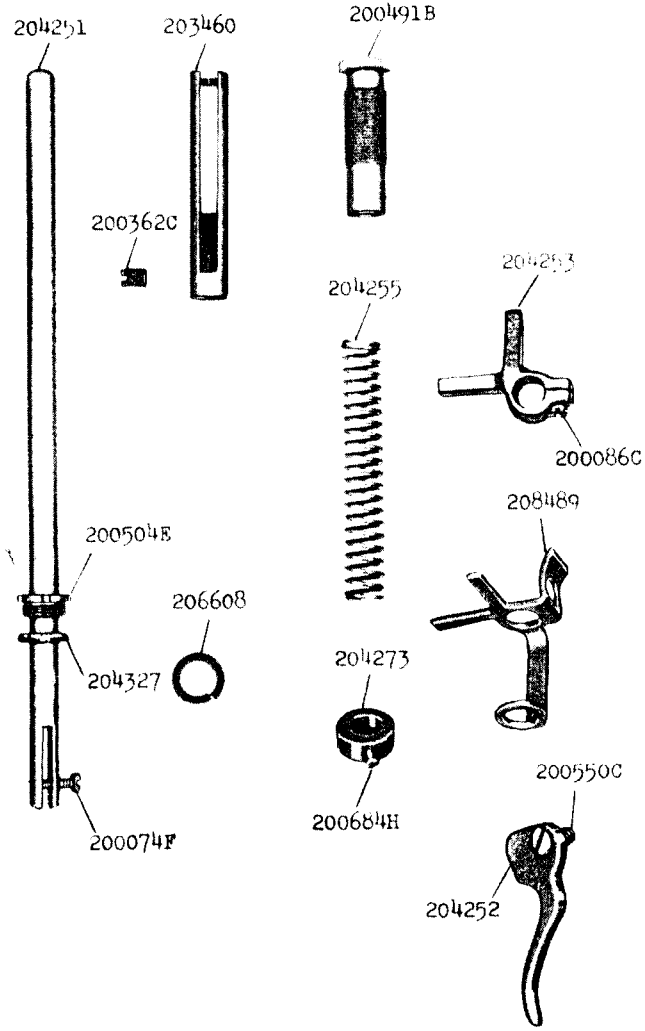

13061 - 1/2

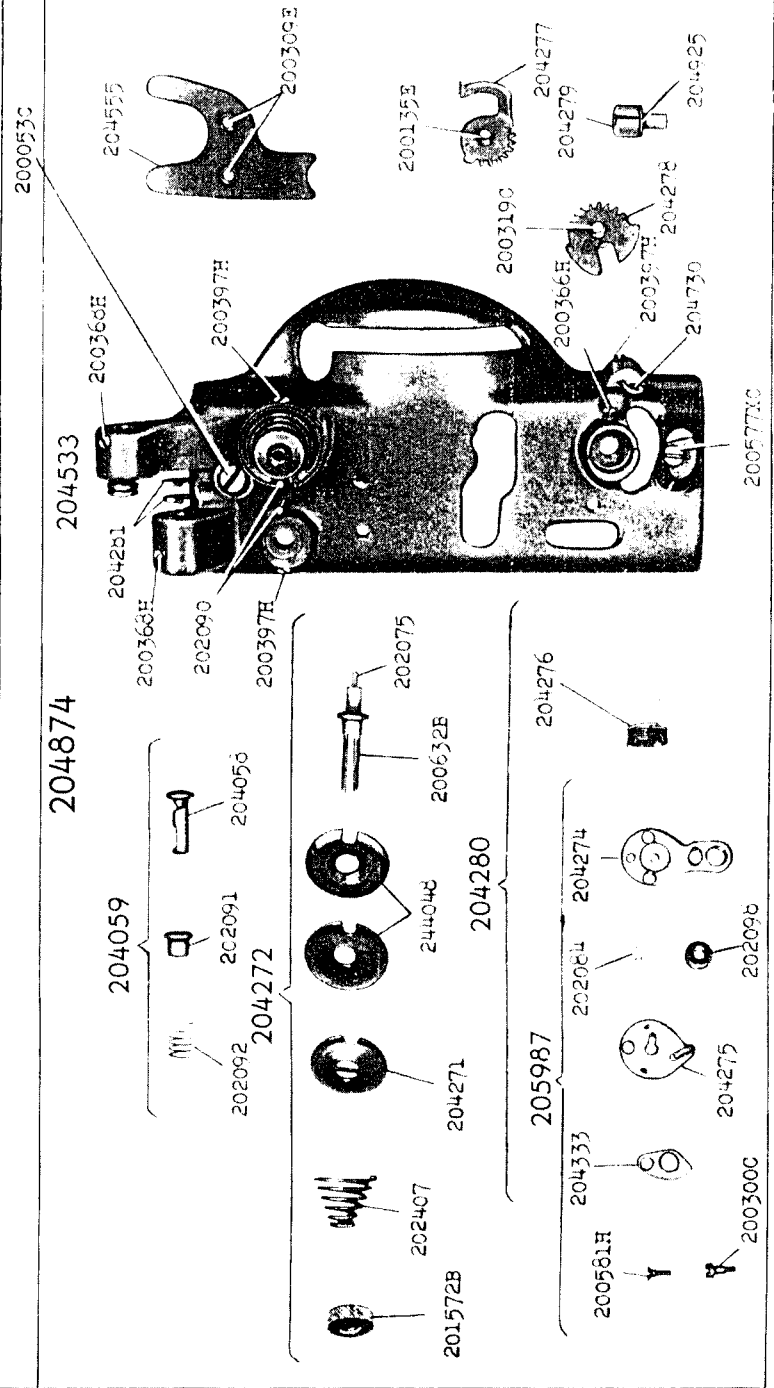

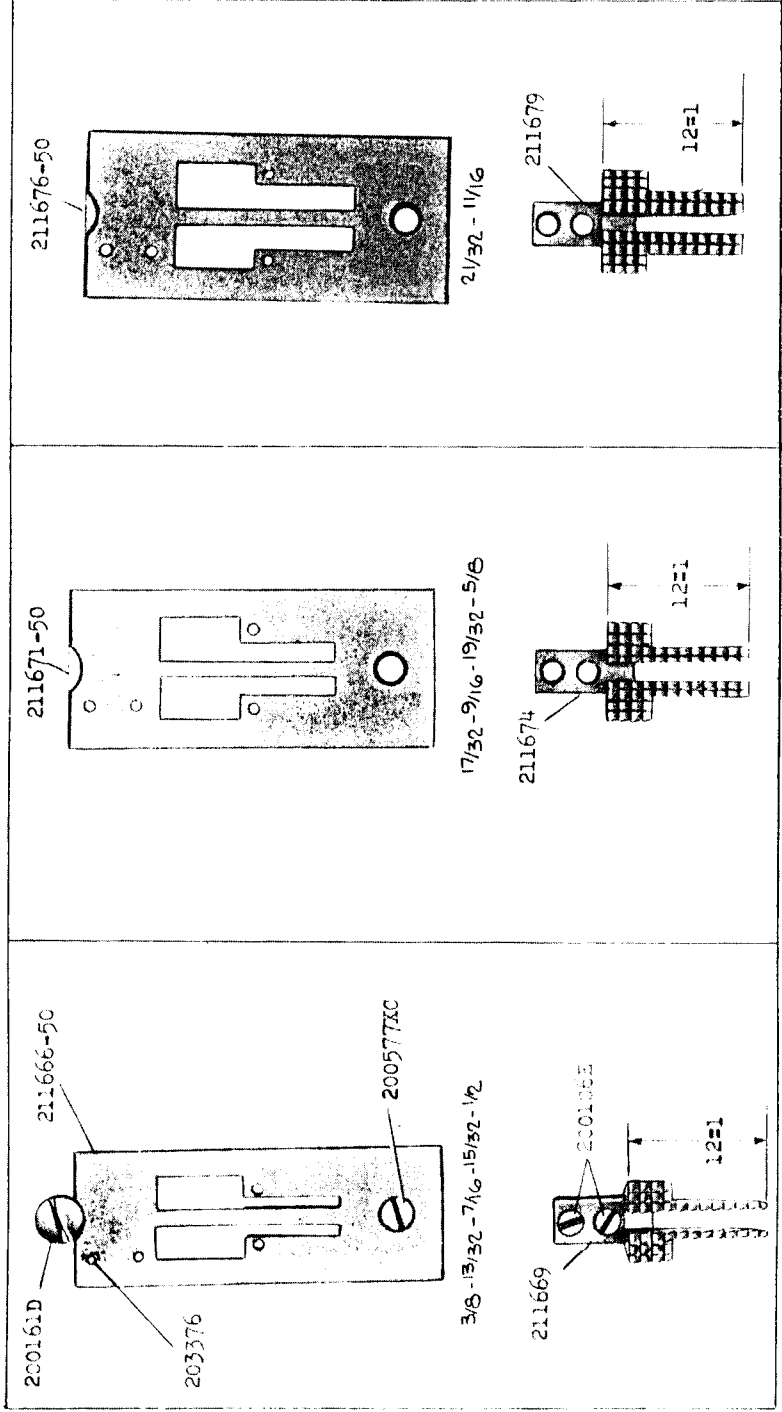
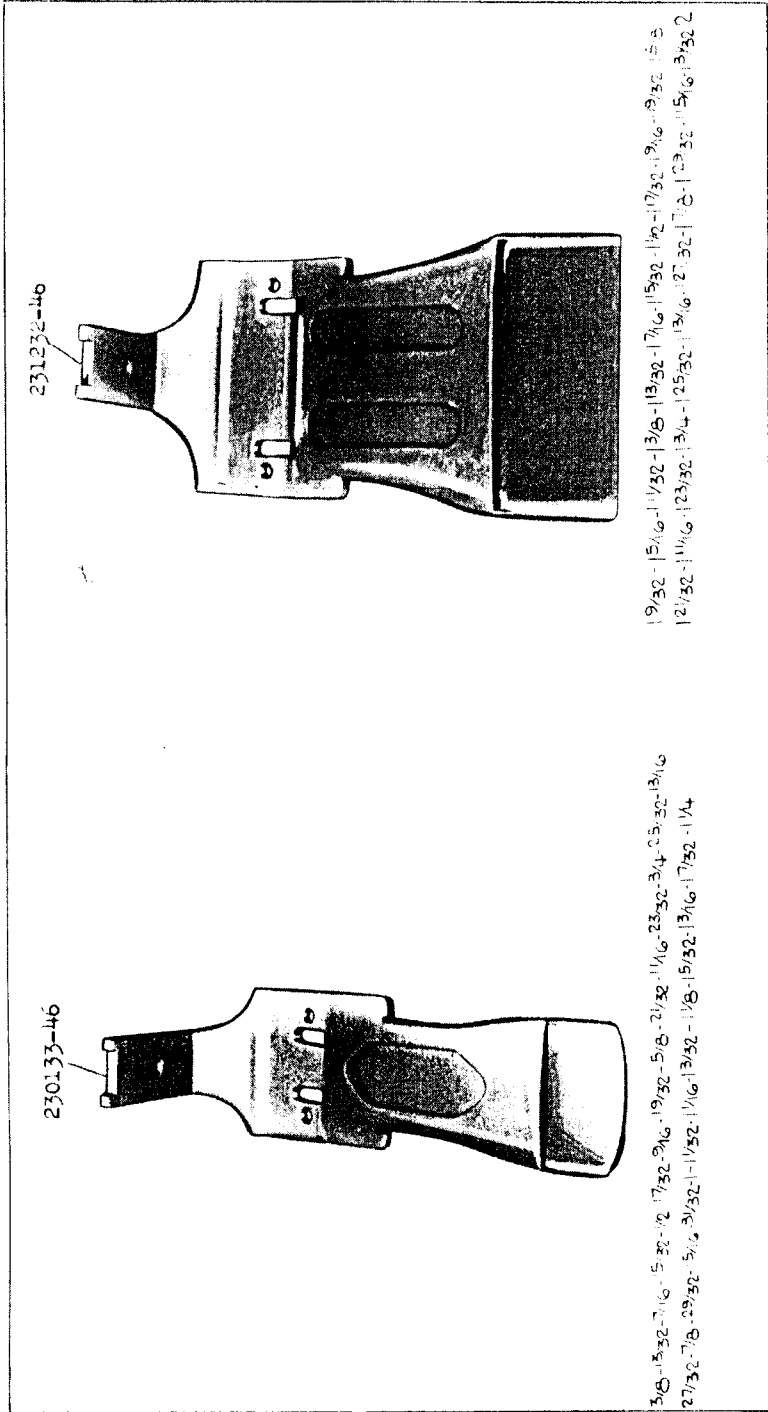

13064 - 3/4

211681-50

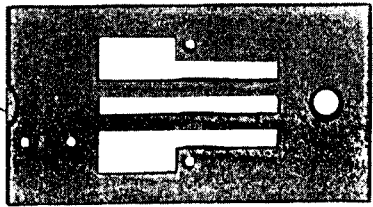

23/32 - 3/4 - 25/32 - 13/16 - 27/32 - 7/8

211685

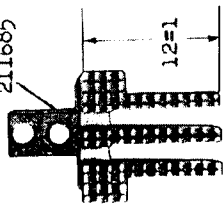

211686-50

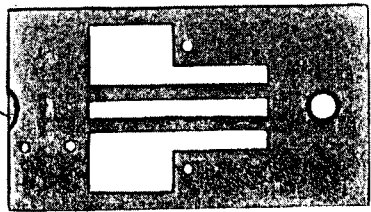

29/32 - 15/16 - 31/32 - 11/16 - 13/32 - 11/8

236440

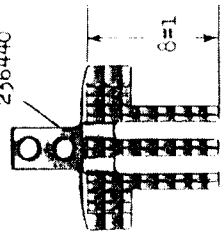

211690-50

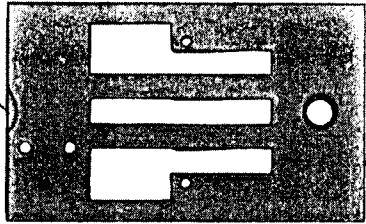

15/32 - 13/16

211693

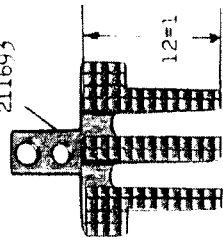

13065 - 3/4

211704-50

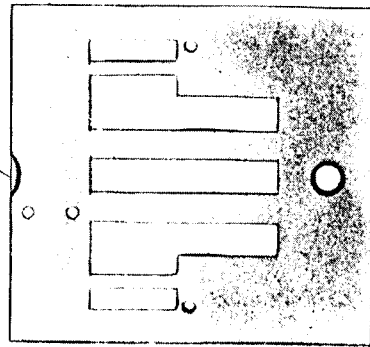

12/32 - 11/16 - 123/32 - 13/4 - 125/32 - 13/16

211707

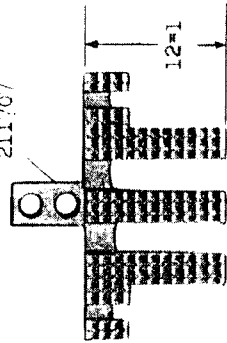

211909-50

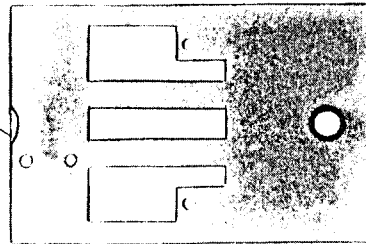

17/32

211910

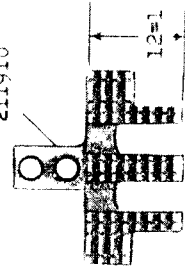

211699-50

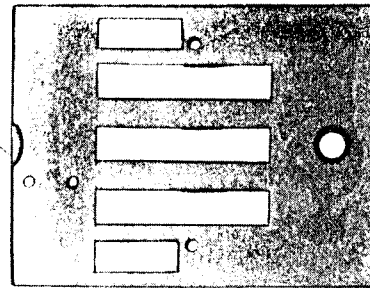

13/8 - 13/32 - 7/16 - 15/32 - 1/2 - 17/32
19/16 - 19/32 - 15/8

236452

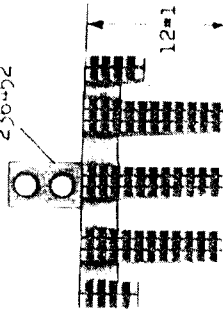

13066 - 3/4

211709-50

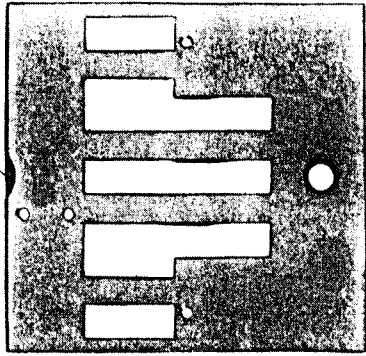

17/8 - 19/32 - 15/16 - 3/32 - 2

211712

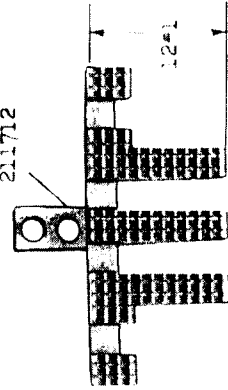

211695-50

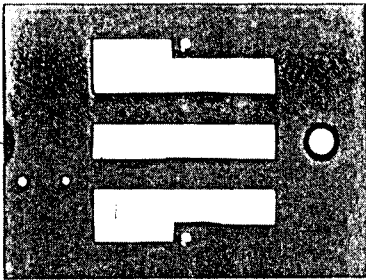

1/4 - 19/32 - 15/16

211698

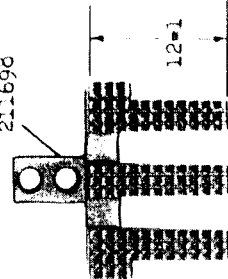

13067 - 1/2

120342

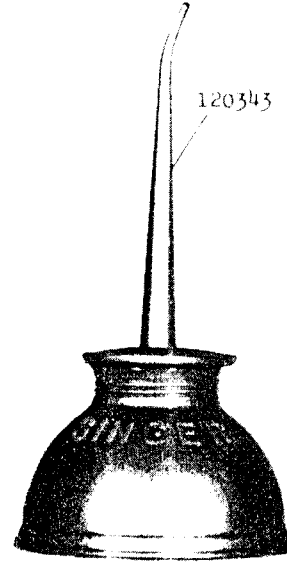

225498



225497



41400



225554



13068 - 1/6

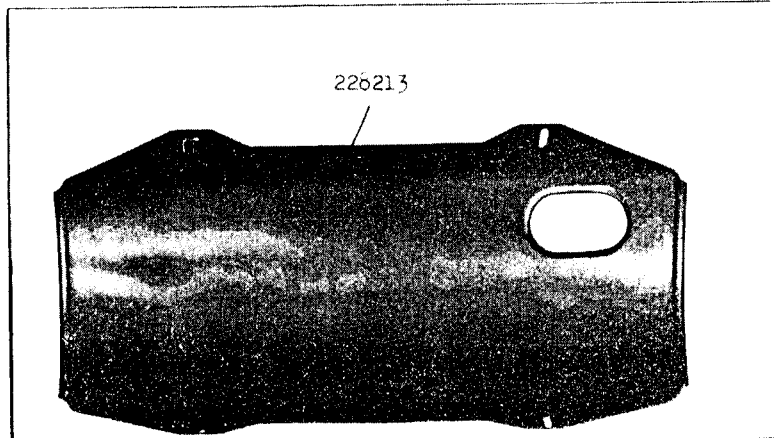

228190

227957

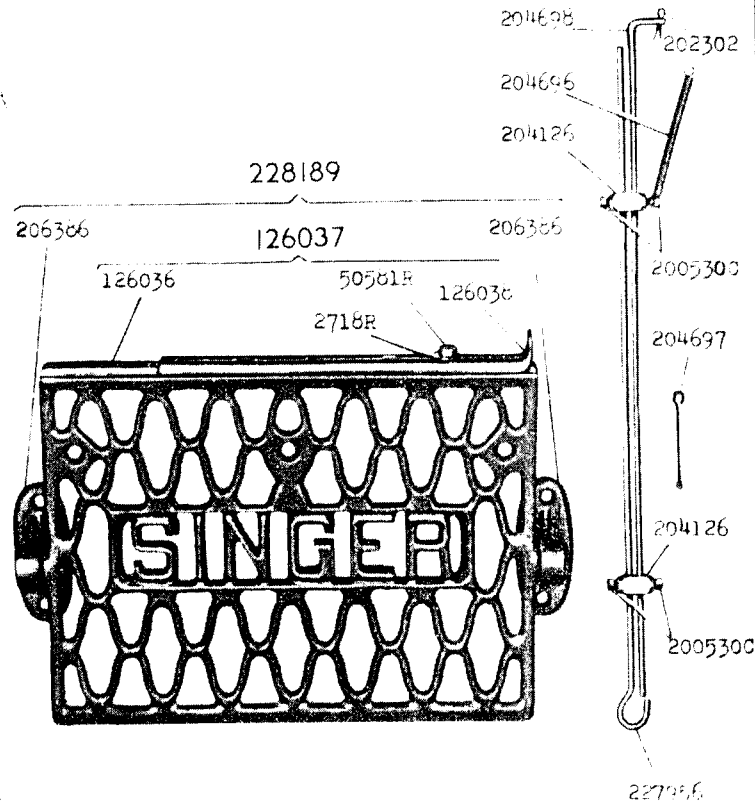

16257 - 1/6

259143

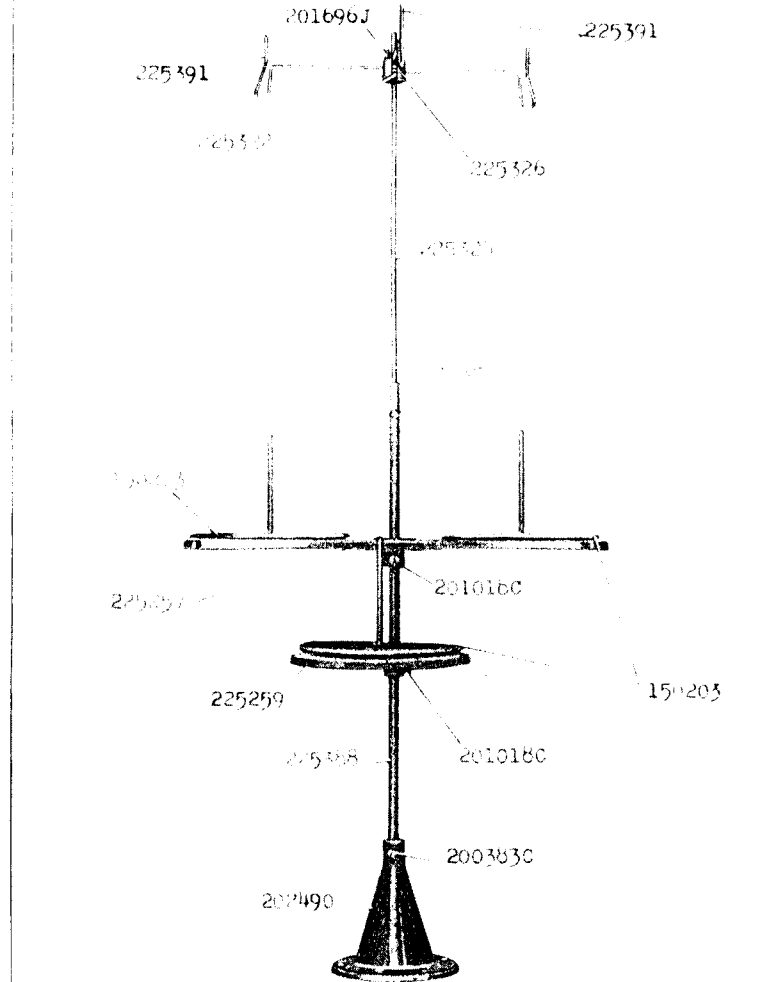

27739

225377

60913

225390



60914

17619 - 1/3

225382

225462

