

# PFAFF

## 1491E

Unterklassen-Ausstattung

Subclass parts

Composition des sous-classes

Composición de las subclases

**Unterklassen-Übersicht**  
**Table of subclasses**  
**Table des sous-classes**  
**Tabla de subclases**

PFAFF 1491E





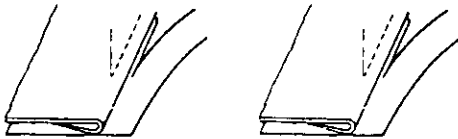





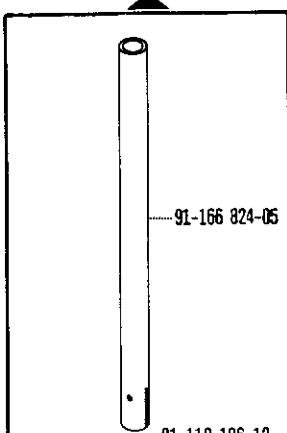
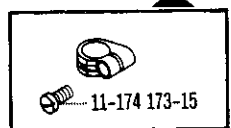
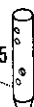





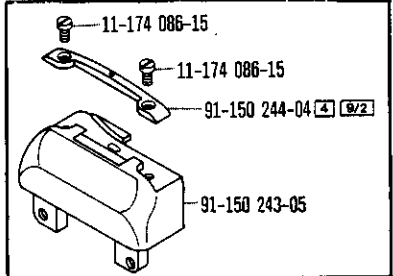

Unterklasse Subclass Sous-classe Subclase	-755/13-725/04-900/53	-755/13-725/04-900/53	-755/13-725/04-900/53	-755/13-726/05-900/53
Arbeitsgang Operation Opération Operación				
Ausführung Model Version Tipo de máquina	AN 5	BN 5	B/CN 5	AN 5
Schneidabstand in mm Trimming margin in mm Distance de coupe en mm Margen de corte en mm	0,8 – 2,5	1,2 – 2,5	1,5 – 2,5	0,8 – 2,5
Nadelstange Needle bar Barre à aiguille Barra de aguja	91-175 110-91	91-175 110-91	91-175 110-91	91-175 110-91
Rollfuß <sup>[4]</sup> Roller presser Pied à roulette Pie rodante	91-164 303-13 <sup>[70/1]</sup>	91-164 303-13 <sup>[70/1]</sup>	91-164 303-13 <sup>[70/1]</sup>	91-164 303-13 <sup>[70/1]</sup>
Stichplatte <sup>[4]</sup> Needle plate Plaque à aiguille Placa de aguja	91-150 249-93 <sup>[9/2]</sup>	91-150 242-93 <sup>[9/2]</sup>	91-150 245-93 <sup>[9/2]</sup>	91-150 249-93 <sup>[9/2]</sup>
Stoffschieber <sup>[4]</sup> Feed dog Griffe Transportador inferior	91-119 544-05	91-119 546-05	91-119 546-05	91-119 544-05
Lineal Edge guide Guide-bord Guia recta	91-164 142-91 91-156 114-05	91-164 142-91 91-156 114-05	91-164 142-91 91-156 114-05	91-164 100-91
Fingerschutz Finger guard Protege-doigts Salvadedos				
Messer <sup>[18/2]</sup> Knife Couteau Cuchilla	91-011 165-04 [18] = 2,7; 3,0; 3,5 mm	91-011 165-04 [18] = 2,7; 3,0; 3,5 mm	91-011 165-04 [18] = 2,7; 3,0; 3,5 mm	91-011 324-04 [18] = 2,7; 3,0; 3,5 mm

siehe Erläuterungen Register 0  
 see explanations in section 0  
 voir légende registre 0  
 ver explicaciones del registro 0

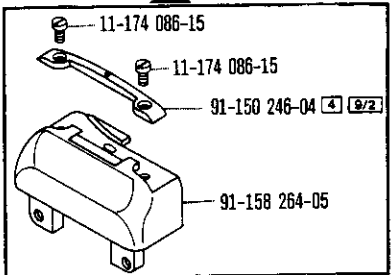
Unterklasse Subclass Sous-classe Subclase	-755/13-726/05-900/53	-755/13-726/05-900/53	-755/13-900/53	-755/13-900/53
Arbeitsgang Operation Opération Operación			<p>Zum Herstellen von Zier- und Befestigungsnähten. Schebbradtransport und angetriebener Rollfuß. For sewing fancy seams and assembly seams. Wheel lead and driven roller presser. Pour exécuter les coutures d'ornementation et de fixation. Avec entrainement par rove et pied à roulette entraînée. Para ejecutar costuras de adorno y fijación. Transportador inferior de rueda y pie rodante accionado.</p>	<p>Zum Herstellen von Zier- und Befestigungsnähten. Schebbradtransport und angetriebener Rollfuß. For sewing fancy seams and assembly seams. Wheel lead and driven roller presser. Pour exécuter les coutures d'ornementation et de fixation. Avec entrainement par rove et pied à roulette entraînée. Para ejecutar costuras de adorno y fijación. Transportador inferior de rueda y pie rodante accionado.</p>
Ausführung Model Version Tipo de máquina	BN 5	B/CN 5	AN 5	BN 5; B/CN 5
Schneidabstand in mm Trimming margin in mm Distance de coupe en mm Margen de corte en mm	1,2 - 2,5	1,5 - 2,5		
Nadelstange Needle bar Barre à aiguille Barra de aguja	91-175 110-91	91-175 110-91	91-175 110-91	91-175 110-91
Rollfuß <sup>4</sup> Roller presser Pied à roulette Pie rodante	91-164 303-13 <sup>70/1</sup>	91-164 303-13 <sup>70/1</sup>	91-164 303-13 <sup>70/1</sup>	91-164 303-13 <sup>70/1</sup>
Stichplatte <sup>4</sup> Needle plate Plaque à aiguille Placa de aguja	91-150 242-93 <sup>9/2</sup>	91-150 245-93 <sup>9/2</sup>	91-150 524-93	91-150 524-93
Stoffschieber <sup>4</sup> Feed dog Griffe Transportador inferior	91-119 546-05	91-119 546-05	91-119 544-05	91-119 546-05
Lineal Edge guide Guide-bord Guia recta	91-164 100-91	91-164 100-91		
Fingerschutz Finger guard Protège-doigts Salvadedos			91-164 291-25	91-164 291-25
Messer <sup>18/2</sup> Knife Couteau Cuchilla	91-011 324-04 <sup>18</sup> = 2,7; 3,0; 3,5 mm	91-011 324-04 <sup>18</sup> = 2,7; 3,0; 3,5 mm		

siehe Erläuterungen Register 0  
 see explanations in section 0  
 voir légende registre 0  
 ver explicaciones del registro 0

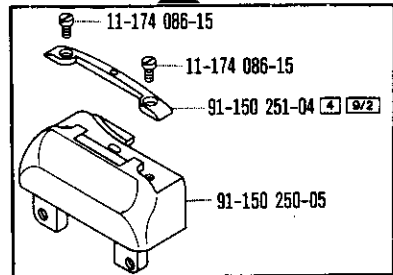
Nähwerkzeuge  
 Gauge parts  
 Organes de couture  
 Organos de costura PFAFF 1491E

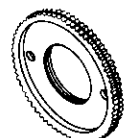
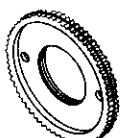
<p>91-175 110-91</p>  <p>91-166 824-05</p> <p>91-118 196-12</p>  <p>11-174 173-15</p>  <p>11-108 093-15</p>  <p>91-175 097-05</p>  <p>91-173 664-15</p>  <p>91-175 099-05</p> <p>-755/13-725/04-900/53          -755/13-726/05-900/53          -755/13-900/53</p>	<p>91-164 303-13  </p>  <p>-755/13-725/04-900/53          -755/13-726/05-900/53          -755/13-900/53</p>	
<p>91-150 242-93  </p>  <p>11-174 086-15</p> <p>11-174 086-15</p> <p>91-150 244-04  </p> <p>91-150 243-05</p> <p>-755/13-725/04-900/53          -755/13-726/05-900/53</p>		<p>-755/13-725/04-900/53          -755/13-726/05-900/53</p>
<p>91-150 245-93  </p>  <p>11-174 086-15</p> <p>11-174 086-15</p> <p>91-150 246-04  </p> <p>91-158 264-05</p> <p>-755/13-725/04-900/53          -755/13-726/05-900/53</p>	<p>91-150 249-93  </p>  <p>11-174 086-15</p> <p>11-174 086-15</p> <p>91-150 251-04  </p> <p>91-150 250-05</p> <p>-755/13-725/04-900/53          -755/13-726/05-900/53</p>	<p>91-119 544-05</p>  <p>-755/13-725/04-900/53          -755/13-726/05-900/53          -755/13-900/53</p> <p>91-119 546-05</p>  <p>-755/13-725/04-900/53          -755/13-726/05-900/53          -755/13-900/53</p>

 siehe Erläuterungen Register 0  
 see explanations in section 0  
 voir légende registre 0  
 ver explicaciones del registro 0

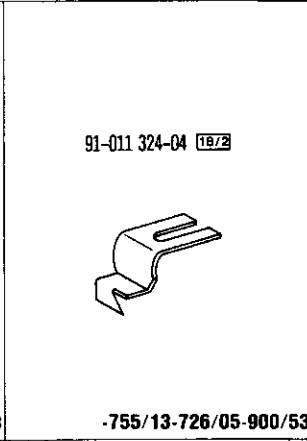
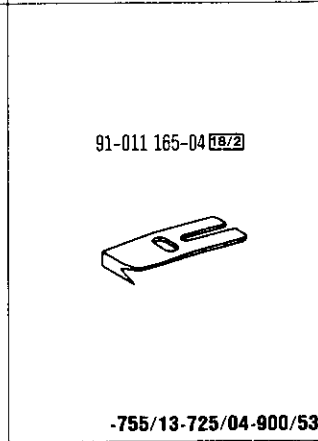
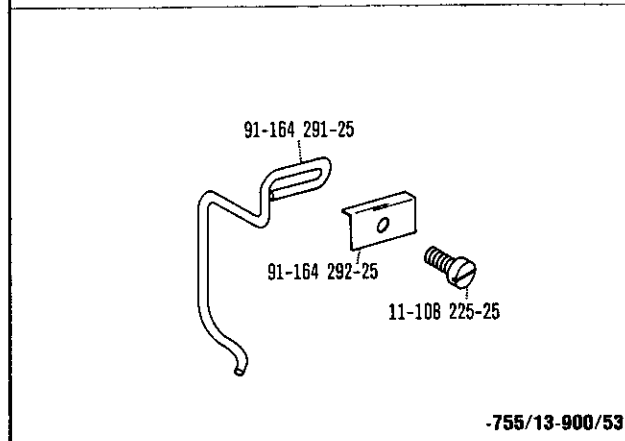
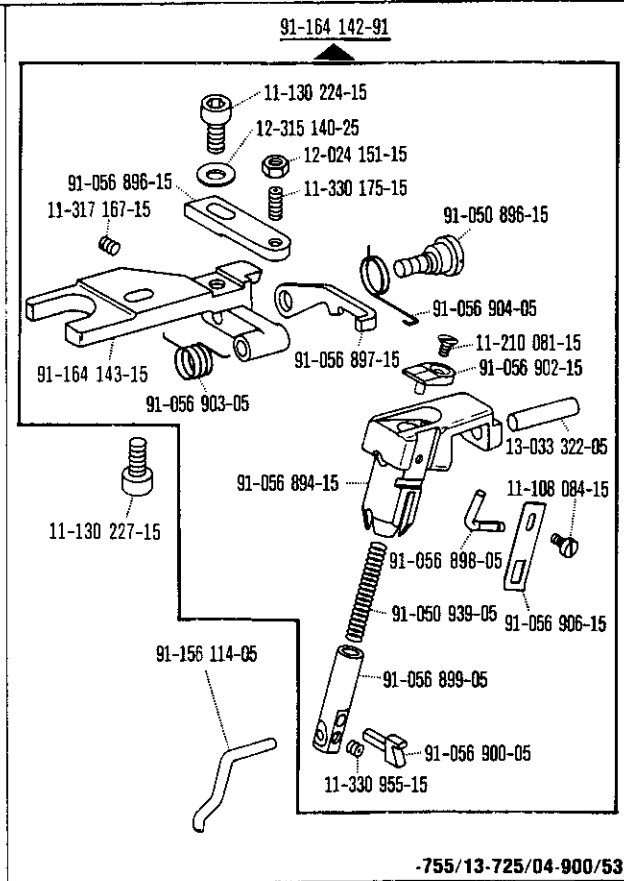
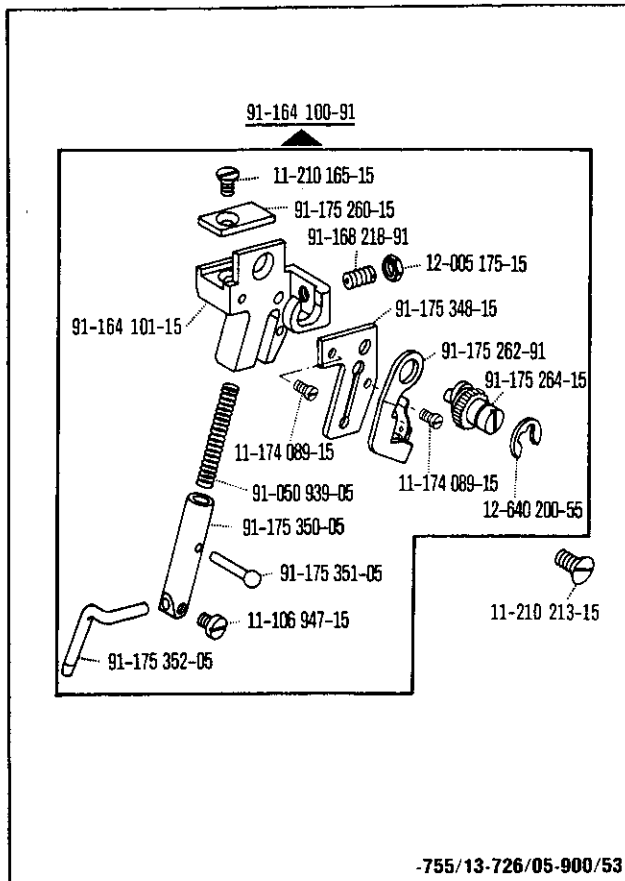

☐ siehe Erläuterungen Register O  
 see explanations in section O  
 voir légende registre O  
 ver explicaciones del registro O

**PFAFF**