

FINEST QUALITY

*Union Special*<sup>®</sup>  
LEWIS<sup>®</sup> • COLUMBIA<sup>®</sup>

INDUSTRIAL  
SEWING  
MACHINES

CLASS  
51200

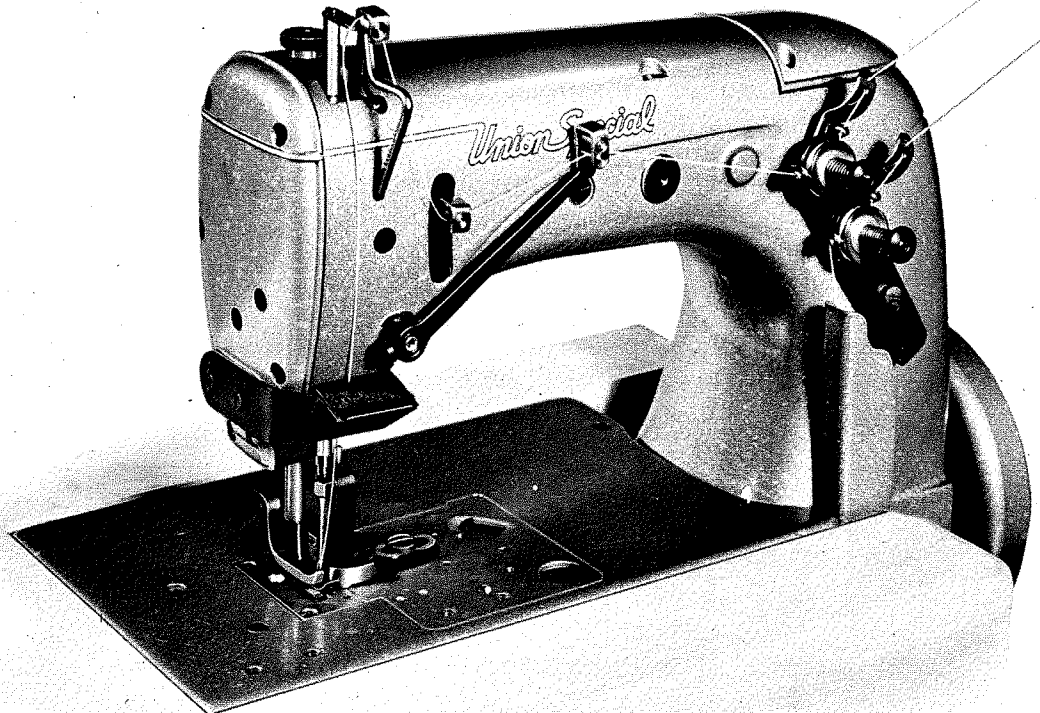

CATALOG  
NO.  
T106 M

LIST OF PARTS FOR STYLES  
51200 BA      51200 BY

**UNION SPECIAL CORPORATION**

**CHICAGO**

Price \$1.00

Catalog No. T106 M  
(Supplement to Catalog No. 104 L)

LIST OF PARTS

CLASS 51200

Styles

51200 BA

51200 BY

First Edition

Copyright 1961

By

Union Special Corporation  
Rights Reserved in All Countries

**UNION SPECIAL CORPORATION**

INDUSTRIAL SEWING MACHINES

**CHICAGO**

Printed in U.S.A.

August, 1976

## IDENTIFICATION OF MACHINES

Each UNION SPECIAL machine is identified by a Style number which is stamped into the name plate.

Machines similar in construction are grouped by a Class number, which contains no letters. Example: "51200". Letters suffixed to a Class number indicates the standard Style of a machine. Example: "51200 BA". Letter "Z" is reserved as a suffix to the standard Style identification to specify machine is of "Special" construction. Example: "51200 BAZ".

## APPLICATION OF CATALOG

This catalog is a supplement to Catalog No. 104 L, and should be used in conjunction therewith. Only parts found on Styles 51200 BA and 51200 BY, but not on Style 51200 BM, are illustrated.

This catalog applies specifically to the standard Styles of machines as listed herein, and can also be applied with discretion, to some Special machines of Class 51200. References to direction, such as right, left, front, back, etc., are taken from the operator's position while seated at the machine. Operating direction of handwheel is toward the operator.

## STYLES OF MACHINES

High Speed Streamlined Flat Bed, Medium Throw, Top Feed, One Needle, Light Weight Presser Bar and Needle Bar Driving Mechanism, Needle Bearing Needle Bar Drive, Single Reservoir Enclosed Automatic Lubricating System and Filter Type Oil Return Pump, Oil Pump Base Plate, Lateral Looper Travel.

51200 BA For attaching soles to uppers of felt slippers and similar operations on medium to medium heavy weight materials. Seam specification 401-SSa-1. Stitch range 7 to 16 per inch.

51200 BY For closing shoes and for similar operations on medium to medium heavy weight materials.

## NEEDLES

Each UNION SPECIAL needle has both a type number and a size number. The type number denotes the kind of a shank, point, length, groove, finish and other details. The size number, stamped on the needle shank, denotes the largest diameter of the blade measured in thousandths of an inch midway between the shank and the eye. Collectively, the type number and size number is the complete symbol.

To have needle orders promptly and accurately filled, forward a sample needle, the empty package, or description on label. A complete order would read as follows: "1000 Needles, Type 506 GS, Size 100/040".

| <u>Type No.</u> | <u>Description and Sizes</u>                                                                                                                         |
|-----------------|------------------------------------------------------------------------------------------------------------------------------------------------------|
| 506 GS          | Round shank, rocked point, extra short, double groove, struck groove, ball eye, chromium plated - sizes 080/032, 090/036, 100/040, 110/044, 125/049. |

Standard needle for Styles 51200 BA and 51200 BY is Type 506 GS in sizes 100/040 and 090/036 respectively.

## NEEDLES (Continued)

Selection of the proper needle size should be determined by size of thread used. Thread should pass freely through the needle eye in order to produce a good stitch formation.

For best results, use only genuine UNION SPECIAL needles in the operation of these machines. They are packaged under our brand name, *Union Special*, which is backed by a reputation for producing highest quality needles for more than three-quarters of a century.

## IDENTIFYING PARTS

Where construction permits, each UNION SPECIAL part is stamped with its catalog number. A part too small for its complete catalog stamping is identified by a letter symbol which distinguishes it from another part similar in appearance.

Each part number represents the same part regardless of catalog in which it appears.

**IMPORTANT! ON ALL ORDERS, PLEASE INCLUDE PART NAME AND STYLE OF MACHINE FOR WHICH PART IS ORDERED.**

## TERMS

Prices are strictly net cash and are subject to change without notice. All shipments are forwarded f. o. b. shipping point. Parcel Post shipments are insured unless otherwise directed. A charge is made to cover postage and insurance.

## OILING

The oil has been drained from the machine before shipping, and the reservoir must be filled before beginning to operate. Use a straight mineral oil with a Saybolt viscosity of 90 to 125 seconds at 100° Fahrenheit.

Oil is filled at the spring cap in the top cover and the level is checked at the sight gauge on the front of the machine. The oil level should be maintained between the red lines on the gauge. The capacity of the oil reservoir is 12 ounces.

The machine is automatically lubricated and no oiling, other than keeping the main reservoir filled, is necessary.

A daily check before the morning start should be made and oil added if required. Oil which has gone through the machine is filtered and pumped back into the main reservoir, making too frequent oilings unnecessary. Excessive oil in the main reservoir may be drained at the plug screw in the main frame directly under the handwheel.

The following is a numerical list of the parts in this machine. Quantities, part numbers, and descriptions are given. Following the parts list are photographs of some of the major parts.

| Amt. | Part No.    | Description                                                        | Amt. | Part No.     | Description                                       | Amt. | Part No. | Description                                                                   |
|------|-------------|--------------------------------------------------------------------|------|--------------|---------------------------------------------------|------|----------|-------------------------------------------------------------------------------|
| 1    | 8           | Feed Rocker Shaft                                                  | 2    | 531          | Screw for 51493 BQ                                | 1    | 22562 A  | Screw for 51254 J                                                             |
| 3    | 18          | Nut for 39241,<br>55241 N, 55244 G                                 | 2    | 531          | Screw for 51251 T                                 | 1    | 22564    | Screw for 51054                                                               |
| 3    | PI18        | Pin for 666-82                                                     | 1    | 538          | Screw for 51134 X                                 | 3    | 22569 B  | Screw for 52891 B                                                             |
| 1    | 20          | Washer for 51236 G                                                 | 1    | 643-127 Blk. | Gasket for 51493 AG                               | 3    | 22569 B  | Screw for 51493 AG                                                            |
| 1    | 24 S        | Edge Guide (25TB,<br>21657E) on<br>51200 BY, (25 S)<br>on 51200 BA | 1    | 660-136      | Feed Crank Link<br>Oil Tube (258 A)               | 5    | 22569 B  | Screw for 51782 A                                                             |
| 1    | 25 B        | Screw for 27 V                                                     | 1    | 660-169      | Needle Bearing for<br>51236 E                     | 2    | 22569 B  | Screw for 21396 BP                                                            |
| 1    | 25 B        | Screw for 51251 B                                                  | 1    | 660-202      | "O" Ring for pulley                               | 16   | 22571 A  | Plug Screw                                                                    |
| 3    | 25 S        | Screw for 24 S,<br>51282 AJ on<br>51200 BA                         | 1    | 660-207      | Oil Seal Ring for<br>foot lifter lever<br>bushing | 1    | 22571 B  | Plug Screw for<br>oiler hole                                                  |
| 1    | 25 TB       | Screw for 24 S on<br>51200 BY                                      | 2    | 660-212      | Oil Seal Ring for<br>51150, 51250 E               | 1    | 22580 D  | Screw for 51223 A                                                             |
| 1    | 27 V        | Retainer for throat<br>plate                                       | 2    | 666-65       | Oil Wick for 51244A                               | 2    | 22585 A  | Screw for 53782 B                                                             |
| 1    | 28          | Screw for 51258 F                                                  | 3    | 666-82       | Felt for 51145                                    | 1    | 22585 B  | Screw for 51225<br>(51225 W)                                                  |
| 1    | 28 B        | Retainer Adjusting<br>Screw                                        | 2    | 666-111      | Oil Wick for 8                                    | 1    | 22586 R  | Screw for 660-212                                                             |
| 1    | 43          | Looper Avoid<br>Eccentric, .062 inch<br>throw (22894 D)            | 2    | 666-114      | Oil Wick for right<br>main shaft bearing          | 1    | 22596    | Screw for 21657 Y                                                             |
| 1    | 43 C        | Feed Lift Eccentric,<br>.080 inch throw<br>(22894 D)               | 2    | 666-118      | Oil Wick for left<br>main shaft bearing           | 1    | 22598 C  | Screw for 21657-3                                                             |
| 2    | 50-216 Blk. | Pin for 51257 P                                                    | 2    | 666-138      | Felt for 51134 V                                  | 1    | 22729    | Screw for 51243 C                                                             |
| 1    | 50-648 Blk. | Lucite Oil Gauge                                                   | 2    | 666-149      | Lubricating Felt<br>for 51054                     | 2    | 22729 C  | Screw for 51241 C                                                             |
| 1    | 50-789 Blk. | Oil Cap Hinge Pin<br>for 52882 AD                                  | 2    | 666-179      | Wedge Pin for<br>666-111                          | 1    | 22733 B  | Screw for 52882 L                                                             |
| 2    | 50-806 Blk. | Pin for 51216 G                                                    | 1    | 666-260      | Wick for 51134 V                                  | 1    | 22738 C  | Screw for 53783 A                                                             |
| 3    | 52 A        | Thread Eyelet (98A)                                                | 2    | 719          | Screw for 51150,<br>51250 E                       | 3    | 22760 A  | Screw for 51281 AC                                                            |
| 1    | 54          | Needle Lever Link                                                  | 1    | 1740         | Pin for 51208 Y,<br>51208 AA                      | 2    | 22768    | Screw for 51236 B                                                             |
| 1    | 56          | Clamp Nut for<br>51217 C                                           | 1    | 2605 A       | Feed Dog (22528)                                  | 2    | 22768    | Screw for 51258 B,<br>51244 B                                                 |
| 1    | 73          | Screw for looper                                                   | 1    | 2624 A       | Throat Plate for<br>51200 BY (87)                 | 1    | 22772 A  | Screw for 51251 S                                                             |
| 1    | 73 A        | Screw for 51210 Y                                                  | 1    | 2624 M       | Throat Plate for<br>51200 BA (87)                 | 1    | 22798 A  | Screw for 51204                                                               |
| 2    | 77          | Screw for 51236 A                                                  | 2    | 6042 A       | Washer for 51135P                                 | 1    | 22799 R  | Hinge Pin for<br>51220 AA                                                     |
| 2    | 77          | Screw for 51054,<br>51204 A                                        | 1    | 12538        | Washer for 51134X,<br>52894 AM                    | 1    | 22801    | Screw for 51225                                                               |
| 1    | 77          | Screw for upper<br>link pin                                        | 1    | 12982        | Nut for 51741 C                                   | 1    | 22829    | Screw for 52458                                                               |
| 3    | 80          | Screw for 51201 H                                                  | 3    | 14649        | Lock Nut for 81                                   | 1    | 22829    | Lock Nut Screw<br>for 51745                                                   |
| *3   | 80          | Screw for 51280 L                                                  | 1    | 15465 F      | Collar for 8 (88)                                 | 1    | 22834    | Screw for 51134 X                                                             |
| 1    | 81          | Screw for 51242 Y                                                  | 1    | B21375 AH    | Looper Rocker Cone<br>for 29192                   | 2    | 22839 C  | Screw for cloth plate                                                         |
| 1    | 82          | Stitch Regulating<br>Screw for 51236 G                             | 1    | 21396 BP     | Belt Guard (93)                                   | 1    | 22840 C  | Screw for adjusting<br>upper feed (41071 G)                                   |
| 2    | 87          | Screw for throat pl.                                               | 1    | 21657-3      | Needle Thread<br>Lubricating Cup<br>(22569 C)     | 1    | 22845 B  | Screw for 51281 AC                                                            |
| 2    | 87 U        | Screw for<br>51281 AD-227                                          | 1    | 21657 E      | Tension Release<br>Separator                      | 9    | 22848    | Screw for 52882 L                                                             |
| 2    | J87 J       | Screw for 51204 C                                                  | 1    | 21657 E      | Washer for 25 TB                                  | 1    | 22852 A  | Screw for 51242 Y                                                             |
| 1    | J87 J       | Screw for 51258 C                                                  | 1    | 21657 W      | Washer for 51257 P                                | 1    | 22863    | Screw for 51134 X                                                             |
| 6    | 88          | Screw for 14649                                                    | 1    | 21657 X      | Tension Release<br>Lever Shaft                    | 1    | 22883 A  | Plug Screw                                                                    |
| 1    | 90          | Screw for 51134 V                                                  | 1    | 21657 Y      | Tension Release<br>Lever Shaft Bushing            | 1    | 22889 A  | Plug Screw                                                                    |
| 2    | 90          | Screw for 52882 AA                                                 | 1    | 21657 Y      | Tension Release<br>Lever Connection<br>(22596)    | 2    | 22889 A  | Plug Screw                                                                    |
| 5    | 90          | Screw for 52882 Y,<br>52894 AB                                     | 1    | 22513        | Screw for 35731 A                                 | 1    | 22889 C  | Plug Screw                                                                    |
| 2    | 93          | Screw for<br>B21375 AH                                             | 4    | 22524        | Screw for 53782 B                                 | 4    | 22889 D  | Plug Screw                                                                    |
| 1    | 94          | Screw for 51251 N                                                  | 7    | 22528        | Screw for 51257 P                                 | 3    | 22894 C  | Eccentric Set Screw                                                           |
| 2    | 95          | Screw for 51147                                                    | 1    | 22528        | Screw for 2605 A,<br>51226 A                      | 3    | 22894 D  | Spot Screw for 43,<br>43 C, 51142 D                                           |
| 1    | 95          | Screw for 51270 B                                                  | 2    | 22537        | Screw for 51321 H                                 | 1    | 22894 D  | Eccentric Spot Screw<br>for 29105 Z                                           |
| 1    | HA95        | Spring Tension<br>Screw for 51134 L                                | 1    | 22537        | Screw for 51321 H                                 | 2    | 22894 G  | Set Screw for<br>52921 B                                                      |
| 1    | 96          | Screw for 51223 A                                                  | 1    | 22537 H      | Plug Screw                                        | 1    | 22894 H  | Screw for 51242 W                                                             |
| 1    | 96          | Screw for 51244                                                    | 3    | 22541 B      | Screw for 52882 AD                                | 2    | 22894 J  | Screw for 51247                                                               |
| 1    | 98          | Screw for 51244                                                    | 4    | 22548        | Screw for 52282 AE                                | 2    | 22894 W  | Screw for 15465 F                                                             |
| 2    | 98          | Screw for 51135 R                                                  | 1    | 22557 B      | Screw for 53783 L                                 | 1    | 29066 R  | Needle Lever                                                                  |
| 3    | 98 A        | Screw for 52 A                                                     | 2    | 22559 A      | Bearing Cap Screw,<br>lower, for 29105 Z          | 1    | 29105 Z  | Connecting Rod<br>Assembly (22559 G)                                          |
| 1    | 98 A        | Screw for 51291 A                                                  | 2    | 22559 B      | Bearing Cap Screw,<br>upper, for 29105 Z          | 1    | 29105 Z  | Looper Drive<br>Eccentric Assembly<br>(22559 A, 22559 B,<br>22894 C, 22894 D) |
| 1    | 98 A        | Screw for 52458                                                    | 2    | 22559 G      | Screw for 51216 K                                 | 1    | 29192 L  | Looper Rocker<br>Assembly                                                     |
| 4    | 109         | Tension Disc                                                       | 1    | 22560 B      | Screw for 51134 X                                 | 1    | 29348 Y  | Needle Lever Assem.                                                           |
| 1    | 258         | Nut for 51134 X                                                    | 2    | 22560 B      | Screw for 51493 BP                                | 1    | 29476 AR | Feed Lift Eccentric,<br>complete, .080 inch<br>throw                          |
| 1    | 258 A       | Nut for 660-136                                                    | 2    | 22560 B      | Screw for 52894 AK                                | 1    | 29476 BJ | Looper Avoid<br>Eccentric, complete,<br>.062 inch throw                       |
| 1    | 258 A       | Lock Nut for 51745                                                 | 1    | 22562 A      | Screw for presser<br>foot                         | 1    | 29476 DM | Top Feed Lift<br>Eccentric, complete,<br>.140 inch throw                      |
| 1    | 258 A       | Nut for 52894 AM                                                   | 1    | 22562 A      | Screw for presser<br>foot                         | 2    | 29476 FF | Crankshaft Assem.                                                             |
| 1    | 269         | Nut for 39241,<br>51236 G                                          | 2    | 22562 A      | Screw for presser<br>foot                         | 2    | 35178 D  | Spring for 666-65                                                             |
| 1    | 402         | Screw for 21657 Y                                                  | 1    | 22562 A      | Screw for presser<br>foot                         | 2    | 35178 D  | Spring for 666-114                                                            |
| 1    | 402         | Screw for 53783 A                                                  | 1    | 22562 A      | Screw for presser<br>foot                         | 2    | 35731 A  | Presser Bar<br>Connection Guide<br>Plate (22513)                              |

\* For new Style No. 51280 L, use counterbore screw No. 22839.

| Amt. | Part No. | Description                                                | Amt. | Part No. | Description                              | Amt. | Part No.     | Description                                              |
|------|----------|------------------------------------------------------------|------|----------|------------------------------------------|------|--------------|----------------------------------------------------------|
| 1    | 39582 L  | Oil Cap for 52882 AD                                       | 1    | 51236 E  | Feed Crank Link Assembly                 | 1    | 51281 AC     | Cloth Plate Cover Spring (22760 A, 22845 B, 35772 H)     |
| 1    | 41071 G  | Nut for 22840 C                                            | 1    | 51236 F  | Ferrule for 51236 D                      | 1    | 51281 AD-227 | Cloth Plate Cover (87 U)                                 |
| 2    | 41394 A  | Gasket for 22733 B                                         | 1    | 51236 G  | Feed Crank Stud (20, 82, 269)            | 1    | 51282 Z      | Gasket for 51782 A                                       |
| 1    | 43266    | Nut for 51292 G                                            | 1    | 51242 L  | Looper Drive Lever                       | 1    | 51282 AE     | Needle Lever Bearing Oiler (90)                          |
| 2    | 51054    | Link Pin for 29348 P                                       | 2    | 51242 M  | Looper Drive Lever Washer                | 1    | 51282 AJ     | Hinged Oil Shield for 51200 BA (25 S)                    |
| 1    | 51054    | Feed Crank Pin (77)                                        | 1    | 51242 M  | Washer for 52841 G                       | 1    | 51282 AK     | Spring for 51282 AJ                                      |
| 1    | 51113    | Looper Rocker for 29192 L                                  | 1    | 51242 P  | Looper Drive Lever Shaft                 | 1    | 51283 H      | Presser Foot Lifter and Tension Disc Release Lever (402) |
| 1    | 51134 L  | Upper Feed Bar (HA95)                                      | 1    | 51242 R  | Looper Drive Lever Shaft Bushing, middle | 1    | 51290 T      | Main Shaft Bushing, middle                               |
| 1    | 51134 M  | Upper Feed Bar Arm                                         | 1    | 51242 S  | Looper Drive Lever Shaft Bushing, rear   | 1    | 51291 A      | Looper Thread Guard (98 A)                               |
| 1    | 51134 N  | Tension Spring for 51134 L                                 | 1    | 51242 W  | Looper Drive Lever (22894 H)             | 2    | 51292 A      | Tension Post Ferrule                                     |
| 1    | 51134 S  | Feed Bar Shaft (666-130, 22586)                            | 1    | 51242 Y  | Looper Drive Lever Rocker (81, 22852 A)  | 2    | 51292 B      | Ferrule                                                  |
| 1    | 51134 T  | Felt for 51134 S                                           | 1    | 51242 Z  | Looper Drive Lever Shaft Bushing, front  | 2    | 51292 C      | Tension Nut                                              |
| 1    | 51134 V  | Taper Pin (90)                                             | 1    | 51243 C  | Ball Stud Fork (22729)                   | 2    | 51292 D      | Tens. Thred Eyelet                                       |
| 1    | 51134 X  | Feed Bar (77, 22834)                                       | 1    | 51244    | Looper Rocker Frame (96, 98)             | 1    | 51292 F-1    | Looper Thread Tension Spring                             |
| 1    | 51135 N  | Feed Rocker (92, 127)                                      | 1    | 51244 A  | Looper Rocker Rock Shaft                 | 1    | 51292 F-14   | Ndl. Thd. Tens. Spr. Tension Post (43266)                |
| 1    | 51135 P  | Feed Rocker Arm                                            | 1    | 51244 B  | Looper Rocker Shaft Arm (22768)          | 2    | 51292 G      | Feed Lift Eccentric Oil Tube                             |
| 1    | 51135 R  | Feed Rocker Shaft Collar and Lubricating Felt Support (98) | 1    | 51244 L  | Thrust Washer for 51244 A                | 1    | 51293 U      | Pulley for 51200 BY (22537)                              |
| 1    | 51142 D  | Upper Feed Lift Eccentric (22894D)                         | 1    | 51244 N  | Looper Rocker Shaft Clamp Collar         | 1    | 51321 H      | Gasket for 53782 B                                       |
| 3    | 51145    | Feed Lift and Looper Avoid Eccentric Link                  | 1    | 51246    | Looper Rocker Stud Nut                   | 2    | 51382 A      | Lead-in Thread Eyelet                                    |
| 1    | 51147    | Main Shaft Collar (95)                                     | 1    | 51247    | Main Shaft Counterweight (22894 J)       | 1    | 51491 C      | Pump Driving Shaft                                       |
| 1    | 51150    | Needle Lever Shaft Stop Collar (719)                       | 1    | 51250 A  | Needle Lever Bushing                     | 2    | 51493 D      | Pump Driving Shaft Gear                                  |
| 1    | 51193 W  | Oil Tube for looper avoid and upper feed lift eccentric    | 1    | 51250 D  | Washer for 22586 R                       | 1    | 51493 E      | Pump Driving Shaft                                       |
| 1    | 51193 X  | Upper Feed Lift Pin Oil Tube                               | 1    | 51250 E  | Needle Lever Stud                        | 1    | 51493 BP     | Pump Driving Gear (531)                                  |
| 1    | 51201 H  | Cloth Plate (80, 22839 C)                                  | 1    | 51250 F  | Gasket for 22586 R                       | 1    | 51493 BQ     | Pump Driven Gear (531)                                   |
| 1    | 51204    | Cast-off Wire (22798 A)                                    | 1    | 51251 B  | Thread Controller Eyelet (25 B)          | 1    | 51493 AG     | Oil Pump Housing (22569 B)                               |
| 1    | 51204 A  | Cast-off Support (77)                                      | 1    | 51251 N  | Thread Controller Lever (25 CC)          | 1    | 51493 AH     | Housing Cover (22569 B)                                  |
| 1    | 51204 B  | Looper Thread Retaining Finger                             | 1    | 51251 P  | Thread Controller Arm                    | 1    | 51493 BK     | Lint Filter Screen                                       |
| 1    | 51204 C  | Finger Holder (J87 J)                                      | 1    | 51251 R  | Thread Controller Bushing                | 1    | 51722        | Main Shaft                                               |
| 1    | 51208 Y  | Looper for 51200 BY (73, 1740)                             | 1    | 51251 S  | Thread Controller Block (22772 A)        | 1    | 51741 C      | Looper Connecting Rod Ball Joint, right (12538)          |
| 1    | 51208 AA | Looper for 51200 BA (73, 1740)                             | 1    | 51251 T  | Presser Bar Lifter and Guide (531)       | 1    | 51745        | Looper Rocker Cone Stud for 29192                        |
| 1    | 51210 Y  | Looper Guard (73 A)                                        | 1    | 51254 C  | Needle Bar Bushing, upper                | 1    | 51782 A      | Head Cover (22542, 22569 B)                              |
| 2    | 51216 G  | Needle Lever Connecting Rod                                | 1    | 51254 D  | Needle Bar Bushing, lower                | 1    | 52458        | Eyelet Support Bracket (98 A, 22829)                     |
| 1    | 51216 J  | Needle Lever Connecting Rod Bearing, lower                 | 1    | 51254 J  | Needle Bar Connection (22562 A)          | 1    | 52841 G      | Locking Stud for 51242 Y (52841 J)                       |
| 28   | 51216 M  | Needle Bearing Roller                                      | 1    | 51256 C  | Presser Bar Spring                       | 1    | 52841 J      | Nut for 52841 G                                          |
| 1    | 51216 N  | Washer for 51215 J                                         | 1    | 51257 K  | Presser Bar                              | 1    | 52882 L      | Oil Reservoir Back Cover (22733 B, 22848)                |
| 1    | 51216 N  | Washer for 55244 G                                         | 1    | 51257 P  | Cast-off Support Plate (21657 E, 22528)  | 1    | 52882 M      | Gasket for 52882 L                                       |
| 1    | 51216 P  | Nut for 51215 J                                            | 1    | 51257 AA | Presser Bar Bushing                      | 1    | 52882 P      | Gasket for 52882 AD                                      |
| 1    | 51217 C  | Needle Bar (56)                                            | 1    | 51258 B  | Needle Bar Rolling Thread Guide (22768)  | 1    | 52882 U      | Gasket for 52882 AE                                      |
| 1    | 51220 Y  | Presser Foot for 51200 BY (22562 A)                        | 1    | 51258 C  | Needle Lever Rolling Thread Guide (28)   | 1    | 52882 W      | Gasket for 51782 A                                       |
| 1    | 51220 AA | Presser Foot for 51200 BA (22562 A)                        | 1    | 51258 F  | Take-up Wire (95)                        | 1    | 52882 Y      | Baffle Plate (90)                                        |
| 1    | 51223 A  | Take-up (96, 22580D)                                       | 1    | 51270 B  | Dowel Pin for 51280 L                    | 1    | 52882 AA     | Oil Drip Plate for 52882 AD (90)                         |
| 1    | 51225    | Needle Guard (22585 B, 22801)                              | 1    | 51280 J  | Throat Plate Support (22839)             | 1    | 52882 AC     | Spring for 52882 AD                                      |
| 1    | 51225 W  | Washer for 22585 B                                         | 1    | 51280 L  | Throat Plate Support (22839)             | 1    | 52882 AD     | Chamber Cover (22541 B)                                  |
| 1    | 51226 A  | Upper Feed Dog (22528)                                     | 1    | 51280 L  | Throat Plate Support (22839)             | 1    | 52882 AE     | Crank Chamber Cover (22548)                              |
| 1    | 51230    | Shank for 51220 AA                                         | 1    | 51270 B  | Dowel Pin for 51280 L                    | 1    | 52883 R      | Foot Lifter Lever Bushing                                |
| 1    | 51230 AA | Bottom for 51220 AA                                        | 1    | 51280 J  | Dowel Pin for 51280 L                    | 1    | 52883 S      | Presser Foot Lifter Lever Bell Crank Spring              |
| 3    | 51236 A  | Link Pin for 51145                                         | 1    | 51280 L  | Throat Plate Support (22839)             | 1    |              |                                                          |
| 1    | 51236 B  | Feed Crank Stud Cap (22768)                                | 2    |          |                                          |      |              |                                                          |
| 1    | 51236 D  | Feed Crank Link for 51236 E                                | 1    |          |                                          |      |              |                                                          |

| Amt. | Part No. | Description                                              | Amt. | Part No. | Description                                    | Amt. | Part No. | Description                                 |
|------|----------|----------------------------------------------------------|------|----------|------------------------------------------------|------|----------|---------------------------------------------|
| 2    | 52890 C  | Main Shaft Bushing, left and inner right                 | 1    | 52944 T  | Looper Rock Shaft Bushing, left                | 2    | 55235 D  | Stud for 51135 P                            |
|      |          |                                                          | 1    | 52944 U  | Looper Rock Shaft Bushing, right               | 2    | 55235 E  | Nut for 51135 P                             |
| 1    | 52891 B  | Crankshaft Bushing Housing, includes bushing             | 1    | 52978 G  | Pin for 51282 AJ                               | 1    | 55241 N  | Looper Connection Rod Ball Joint, left (18) |
| 1    | 52892    | Tension Post Support (22598 C)                           | 1    | 53782 B  | Oil Reservoir Top Cover (22524, 22585 A)       | 1    | 55244 G  | Looper Shaft Collar Stud (18, 51216 N)      |
| 3    | 52894 AB | Oil Tube Holder for 51193 W, 51193 X, 51293 U (90)       | 1    | 53783 A  | Lifter Lever Link (402, 22758 C)               | 1    | 56315    | Needle Lever                                |
| 1    | 52894 AK | Oil Tube for looper rocker and left ball joint (22560 B) | 1    | 53783 L  | Presser Foot Lifter Lever Bell Crank (22557 B) | 1    | 56334 L  | Feed Dog Holder for 51134 X                 |
| 1    | 52894 AM | Oil Tube for right ball joint (258 A, 6042 A)            | 1    | 53783 M  | Presser Foot Lifter Lever Connecting Rod       | 1    | 56356    | Presser Spring Regulator                    |
| 1    | 52921 B  | Pulley, for 51200 BA (22894 G)                           | 1    | 53783 N  | Presser Foot Lifter Lever, internal (22537)    | 1    | 56390 E  | Bearing Housing Gasket                      |
| 2    | 52936    | Feed Rocker Shaft Bushing                                | 1    | 54244 L  | Thrust Washer for 51244 A                      | 2    | 80557    | Spacing Washer for 21657-3, 52892           |
|      |          |                                                          |      |          |                                                | 2    | 92127    | Screw for 51135 N                           |

NOTE: Numbers in parentheses following parts description indicate the screws, nuts, etc., used to attach or hold these parts.

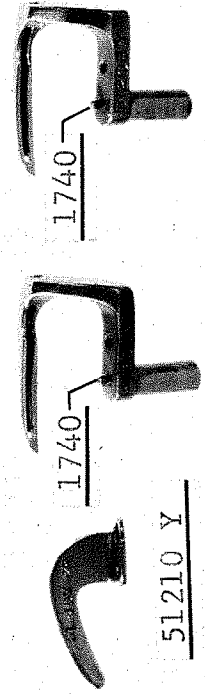
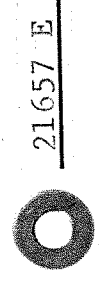
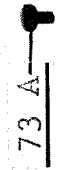
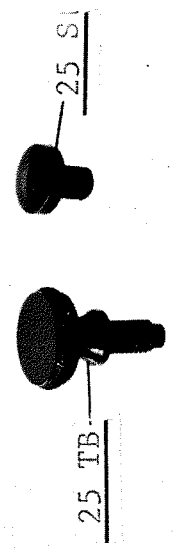
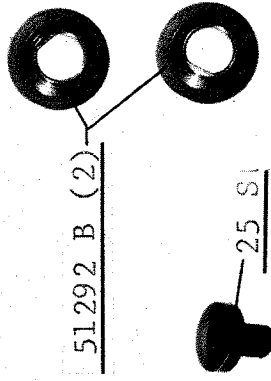
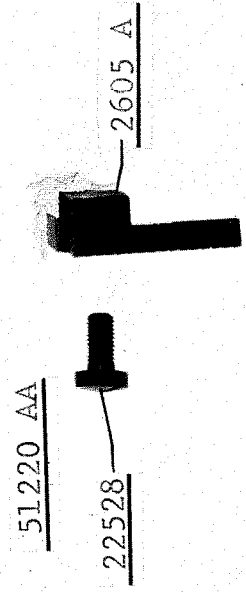
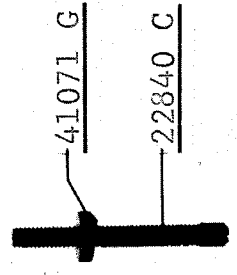
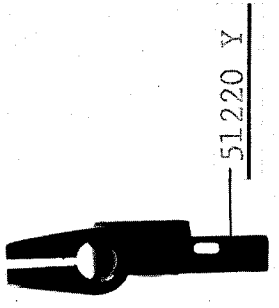
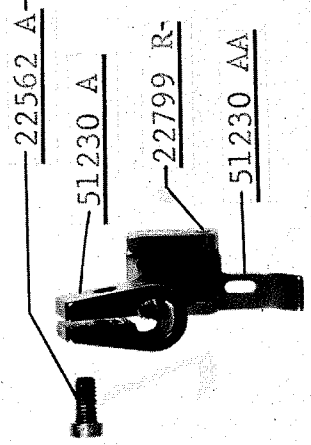
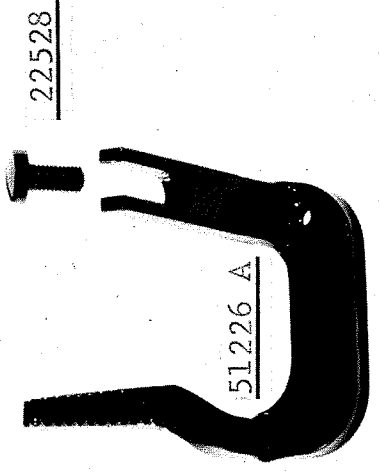
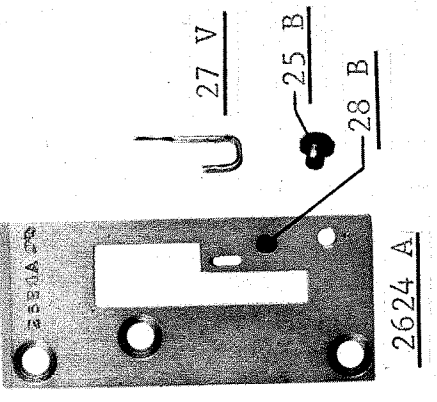
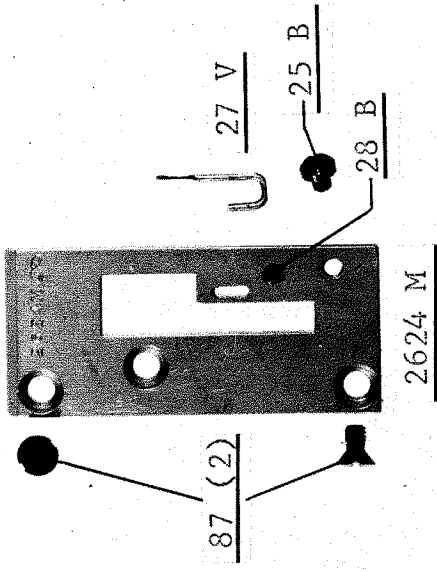





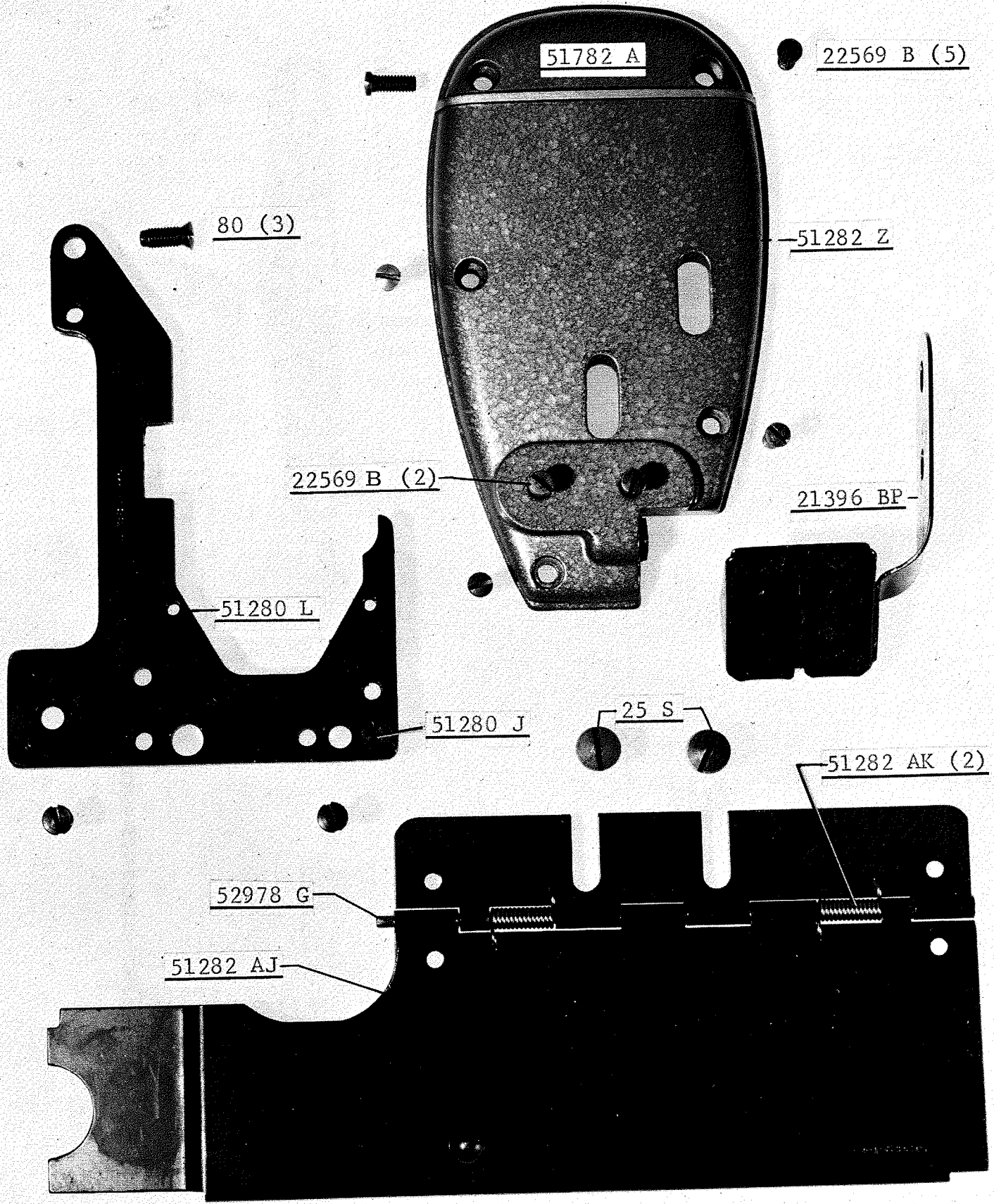

51782 A

22569 B (5)

80 (3)

51282 Z

22569 B (2)

21396 BP-

51280 L

51280 J

25 S

51282 AK (2)

52978 G

51282 AJ

51201 H

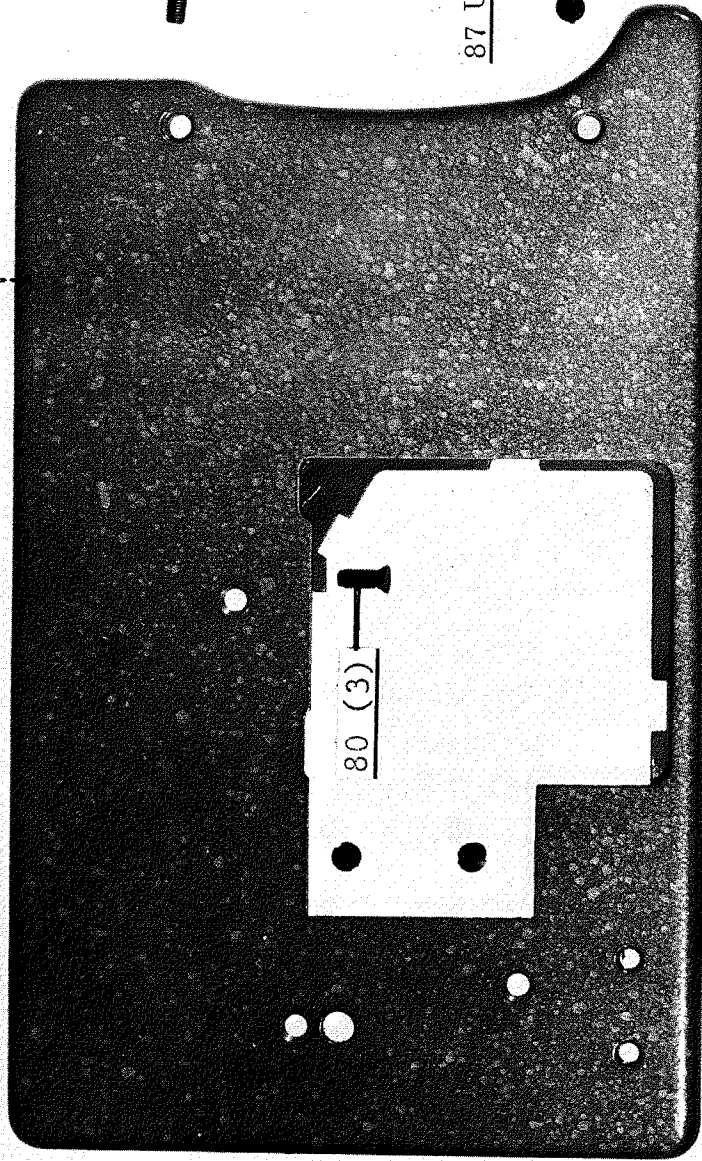

80 (3)

22839 C (2)

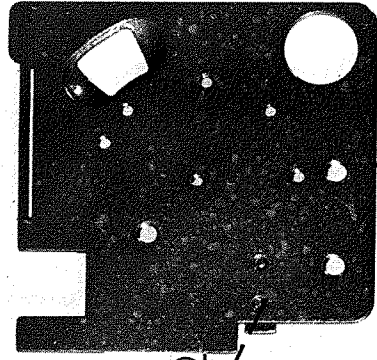

87 U (2)

51281 AD-227

22894 G

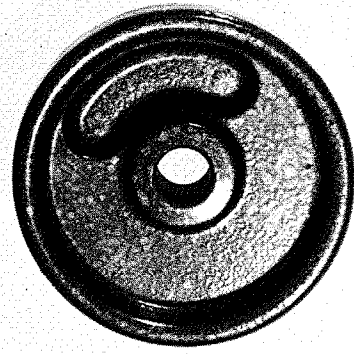

22894 G

52921 B  
For  
Style 51200 BA



660-202

22537

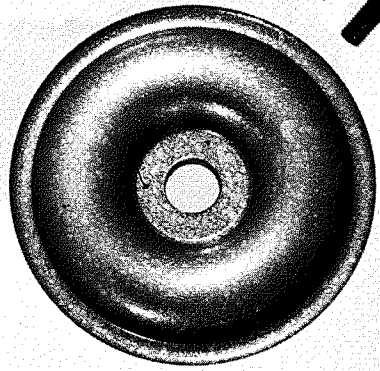

22537

51321 H  
For  
Style 51200 BY

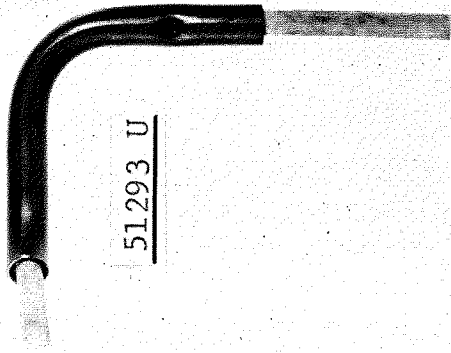

51293 U



51193 W

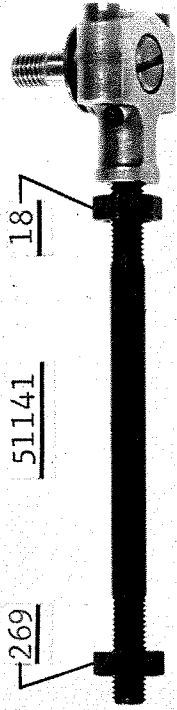

51141

269

18

51741 C

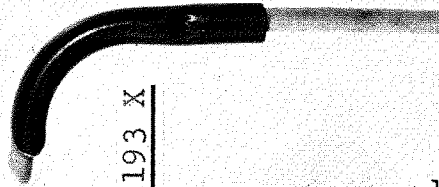

51193 X

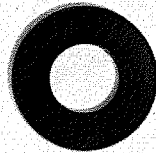

54244 L



51223 A

22580 D

96

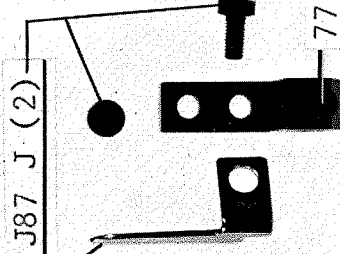

J87 J (2)

51204 B

51204

22798 A

51204 A

51204 C

77

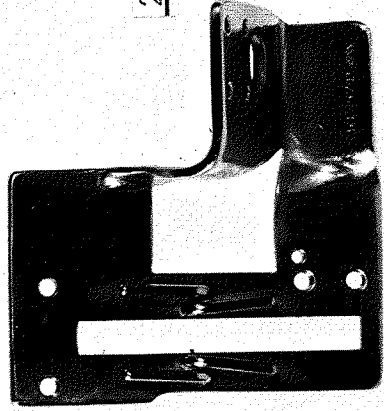

51257 P

21657 E

22528

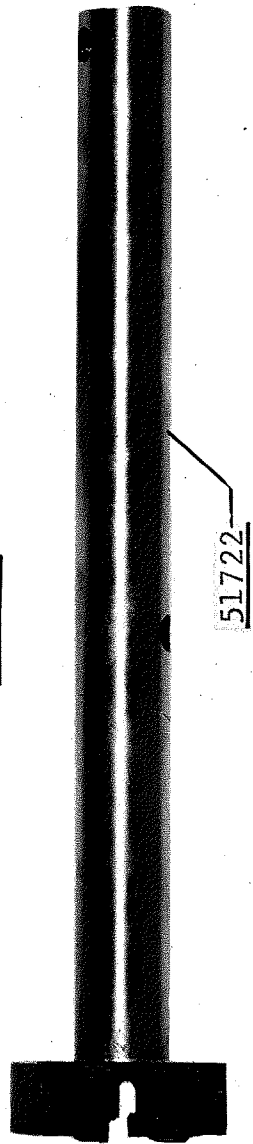
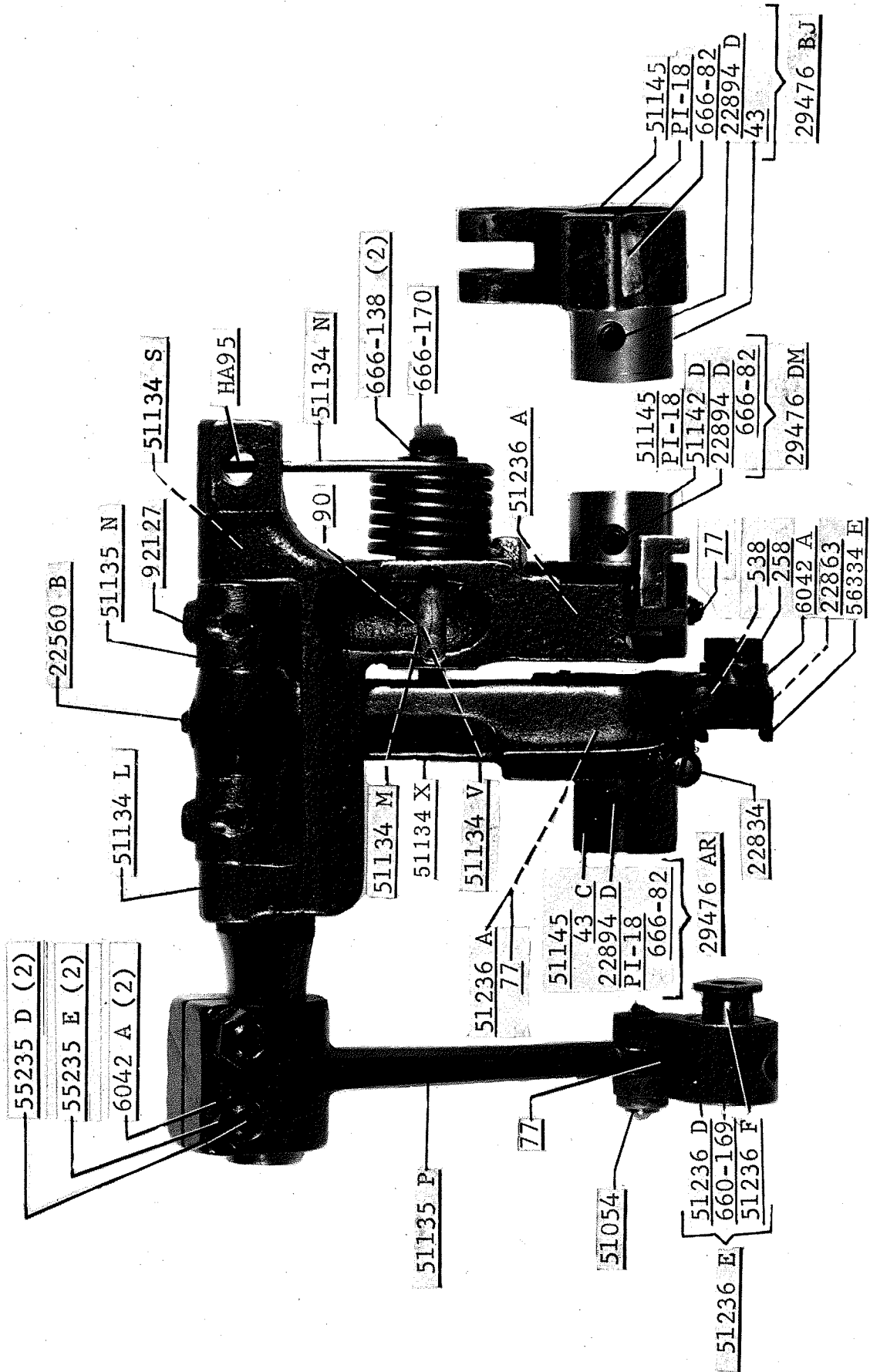





Helpful, authoritative information on the most efficient types of equipment for making virtually any machine sewed article is available from Union Special's Sales Promotion Department. Among the many interesting, illustrated bulletins that are available without obligation are the following:

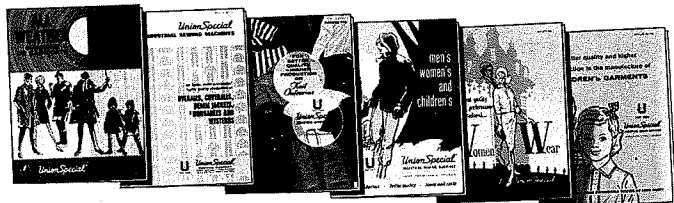

- No. 240, "Men's, Women's, Children's Footwear"
- No. 249, "Rainwear"
- No. 250, "Men's Dress Shirts"
- No. 251, "Service Shirts and Pants"
- No. 252, "Men's Shorts and Pajamas"
- No. 253, "Overalls, Coveralls, and Dungarees"
- No. 254, "Men's Knit Underwear"
- No. 256, "Knit Outerwear"
- No. 259, "Men's Sports Shirts"
- No. 260, "Work Gloves"
- No. 262, "Cotton, Burlap, Jute, and Multiwall Paper Bags"
- No. 263, "Men's Clothing"
- No. 264, "Men's Women's, Children's Jackets"
- No. 265, "Women's Wear"
- No. 266, "Women's Wear And High Fashion"
- No. 267, "Corsets, Girdles, Brassieres"
- No. 268, "Children's Wear"
- No. 269, "Mattresses, Slip Covers, Furniture Upholstery"
- No. 271, "Awnings, Canopies, Tents, Tarps"
- No. 273, "Curtains & Drapes"
- No. 610, "Klipp-it"
- No. 710, "MCS ForMation Unit"
- No. 730, "MCS Automatic Dual Underfront Shirt Hemmer"
- No. 740, "MCS Automatic Rib-Knit Cuff Machine"
- No. 750, "Fusing Presses"
- No. 1100, "Lewis Blindstitch, Chainstitch, Lockstitch, Machines"
- No. 1105, "Button Sewers—Ticket Tackers"
- "Columbia Blindstitch, Saddle Stitch, and Tie Closing Machines"
- No. 1500, "Alteration Department Machines"



**UNION SPECIAL  
CORPORATION**

**HERE ARE HELPFUL  
BULLETINS and CATALOGS  
TO HELP YOU SOLVE  
SEWING PROBLEMS**

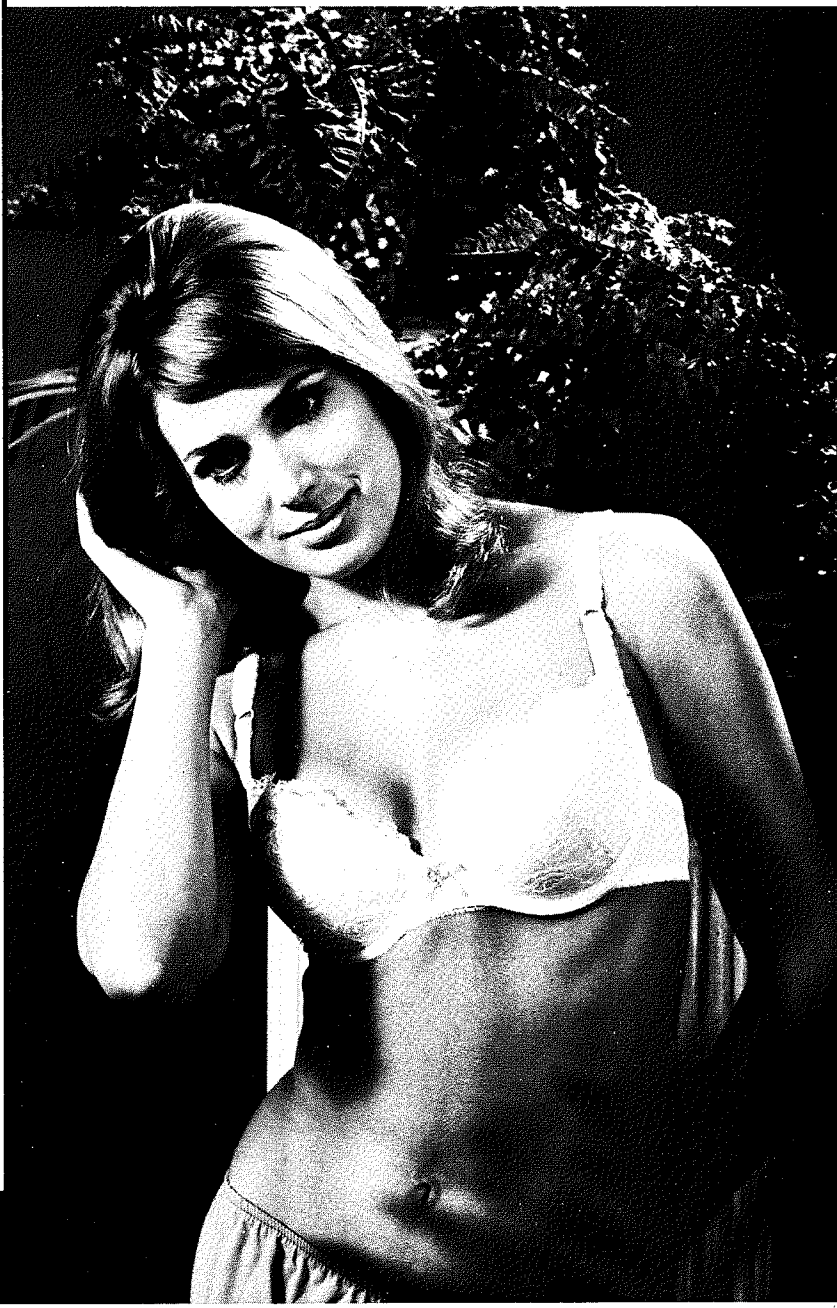



*Union Special*<sup>®</sup>  
INDUSTRIAL SEWING MACHINES

UNION SPECIAL maintains sales and service facilities throughout the world. These offices will aid you in the selection of the right sewing equipment for your particular operation. Union Special representatives and service men are factory trained and are able to serve your needs promptly and efficiently. Whatever your location, there is a Union Special Representative to serve you. Check with him today.

**ATLANTA, GA.**

**BOSTON, MASS.**

**CHICAGO, ILL.**

**DALLAS, TEXAS**

**LOS ANGELES, CAL.**

**NEW YORK, N. Y.**

**PHILADELPHIA, PA.**

**MONTREAL, CANADA**

**TORONTO, CANADA**

**BRUSSELS, BELGIUM**

**LEICESTER, ENGLAND**

**LONDON, ENGLAND**

**PARIS, FRANCE**

**STUTT GART, GERMANY**

Representatives and distributors in all important industrial cities throughout the world.

**UNION SPECIAL CORPORATION**