

Singer 52-56

Singer 52-76

Form 8485—Revised
November, 1930
PRINTED IN U. S. A.

LIST
OF
PARTS



MACHINES
Nos. 52-56 and 52-76

THE SINGER MANUFACTURING COMPANY

COPYRIGHT, U. S. A.
1918, 1922, 1923 AND 1930
BY THE SINGER MANUFACTURING COMPANY
ALL RIGHTS RESERVED FOR ALL COUNTRIES

INDEX

	PAGE
ACCESSORIES.....	17
CORDER.....	17
FEED ROLLS.....	21
FOOT LIFTER PARTS.....	19
IRON BASE.....	16
KNEE LIFTER PARTS.....	20
MACHINE No. 52-56.....	7
" " 52-76.....	16
NUMERICAL LIST OF PARTS.....	23
OBSOLETE PARTS.....	22
PRESSER FEET.....	18
TAPE HOLDERS.....	18
THREAD UNWINDER.....	21

INSTRUCTIONS FOR ORDERING

In ordering from this list, use **ONLY** the part NUMBER in the **FIRST** column.

The number stamped on a Sewing Machine part is in every case the number of the single part only.

Every combination of parts sent out as such has its specific number, which, although not stamped on the parts, must be used when ordering the combination.

Each number always indicates the **SAME PART** in whatever list it appears, or for whatever machine.

The letters after some of the numbers indicate the style of finish only, as follows:

- A—Hardened, Polished, Nickel Plated and Buffed
- B—Polished, Nickel Plated and Buffed
- C—Hardened Only
- D—Polished Only
- E—Soft, Not Polished
- F—Hardened and Polished
- H—Blued
- J—Nickel Plated Only
- K—Hardened and Nickel Plated
- L—Brass Plated
- M—Oxidized
- N—Japanned, Dull
- P—Japanned, Bright
- R—Merlized
- T—Copper Plated
- T. A.—Hardened, Polished, Copper and Nickel Plated and Buffed
- T. B.—Copper and Nickel Plated and Polished
- T. J.—Copper and Nickel Plated Only
- T. K.—Hardened, Copper and Nickel Plated
- T. M.—Copper Plated and Oxidized
- T. L.—Copper and Brass Plated
- U—Zinc Plated
- V—Silver Plated
- W—Polished and Nickel Plated
- Z—Chromium Plated
- Z. B.—Polished, Nickel Plated, Buffed and Chromium Plated
- Z. J.—Nickel and Chromium Plated

These letters **MUST BE USED** when they appear in the list; and **AFTER** the number as in the list.

In this series:

- 1 to 1500 and 50001 to 51500 are Screw Numbers
- 1501 to 1800 and 51501 to 51800 are Nut Numbers
- 1801 to 2000 and 51801 to 52000 are Roller Numbers
- 2001 to 50000 and 52001 and upward are numbers of Machine Parts

The figures in the second column refer only to the plates, illustrating the parts, and are **NOT TO BE USED** in ordering.

Parts marked with an asterisk (*) are furnished only when repairs are made at factory.

When ordering parts which differ as to **Gauge** (the distance between seams) the Gauge, as well as the **Number must be given** on order.

LIST OF PARTS COMPLETE FOR MACHINE No. 52-56

SIX NEEDLES, SIX HOOKS

NO.	PLATE	NAME
*13945	—	Arm.....
*13946	—	" 13945 with 453c and 15486.....
4389	7445	" Dowel Pin.....
54897	7442	" Oil Cup.....
13862	7442	" " Tube with 29599, for oiling 13799 and 13804.....
13831	7442	Arm Oil Tube (left) with 49092, for oiling 13811.....
13832	7442	Arm Oil Tube (right) with 49092, for oiling 13813.....
13833	—	Arm Oil Tube Bracket.....
13834	7442	" " " " 13833 with 13831 and 13832.....
898D	7450	Arm Oil Tube Bracket Screw.....
29599	7442	" " " Packing (felt) for 13862,per 100
49092	7442	Arm Oil Tube Packing (felt) for 13831 and 13832.....
880E	7450	Arm Screw (left).....
138E	7450	" " (right).....
13928	7458	" Shaft.....
13794	7440	" " Flanged Bushing (back).....
56006	7442	" " " " " Oil Pad (braided cotton).....
446c	2831	Arm Shaft Flanged Bushing (back) Set Screw.....
13795	7440	Arm Shaft Flanged Bushing (front).....
56006	7442	" " " " " Oil Pad (braided cotton).....
443c	7450	Arm Shaft Flanged Bushing (front) Set Screw.....
144D	7450	Arm Shaft Screw.....
15196	7441	" Side Cover.....
286D	7450	" " " Thumb Screw.....
13796	7441	Balance Wheel, 2 $\frac{1}{16}$ in. pulley, with two 448c.....
13797	7441	Balance Wheel Oil Cover.....
210D	7450	" " " " Screw.....
448c	7450	" " Set Screw.....

NO.	PLATE	NAME
*13798	—	Bed.....
13799	7441	Crank Connecting Rod with 13800 and two 145E.....
*13800	—	Crank Connecting Rod Cap.....
145E	7450	" " " " Screw.....
375c	7450	" " " " Hinge Screw.....
1518E	7450	" " " " " " Nut
13849	7441	Face Plate.....
190D	7442	" " Screw.....
13802	7443	Feed Bar.....
315c	2642	" " Screw Centre.....
1519E	7450	" " " " Nut.....
2039	7444	" Connecting Link.....
378c	7444	" " " " Hinge Screw (long)
380c	7444	" " " " " " (short)
1520E	7444	" " " " " " Nut..
48123	5411	" Dog.....
48124	5412	" ".....
48125	5413	" ".....
48126	5414	" ".....
48127	5415	" ".....
48128	5416	" ".....
48122	5410	" " for gathering.....
48129	7502	Feed Dog leaving out the second needle from the right hand side and the first and third needles from the left hand side
48130	7503	Feed Dog.....
48131	7504	" ".....
48132	7610	" " for gathering and braiding.....
48133	7612	" ".....
48134	8700	" ".....
48135	8701	" ".....
48136	8722	" ".....
48137	8723	" ".....
48138	5413	" ".....
48139	8738	" ".....
48140	8739	" ".....
191c	7450	" " Screw.....
13803	7444	" and Feed Lifting Eccentric with 448c
448c	7450	" " " " " " Set Screw
13804	7444	" " " " " " Sleeve....
13805	7440	" Forked Connection.....
378c	7444	" " " " Hinge Screw....
1520E	7444	" " " " " " Nut
13806	7440	" Lifting Rock Shaft.....
13807	—	Feed Lifting Rock Shaft complete, Nos. 2509 and 13806.....

NO.	PLATE	NAME
13808	7440	Feed Lifting Rock Shaft Connecting Rod with 43977 and two 145E.....
*43977	—	Feed Lifting Rock Shaft Connecting Rod Cap.....
145E	7450	Feed Lifting Rock Shaft Connecting Rod Cap Screw.....
375c	7450	Feed Lifting Rock Shaft Connecting Rod Hinge Screw.....
1518E	7450	Feed Lifting Rock Shaft Connecting Rod Hinge Screw Nut.....
2509	7444	Feed Lifting Rock Shaft Crank with 157J and 1813.....
157J	7444	Feed Lifting Rock Shaft Crank Clamping Screw.....
1813	7444	Feed Lifting Rock Shaft Crank Roller and Stud.....
307c	7450	Feed Lifting Rock Shaft Screw Centre...
1513J	2642	" " " " " " Nut
2164	7444	" Regulator.....
74E	7444	" " Hinge Screw.....
747D	7444	" " Thumb Screw.....
21350	7444	" " " " Stop.....
2047	7440	" Rock Shaft.....
2046	—	Feed Rock Shaft complete, Nos. 2047 and 2048.....
2048	7444	Feed Rock Shaft Crank with 465c.....
2049	7444	" " " " Pin.....
465c	7444	" " " " Set Screw.....
307c	7450	" " " " Screw Centre.....
1513J	2642	" " " " " " Nut.....
13647	7463	Looper.....
13628	7463	" Carrier with two 211c and six 853c
211c	7463	" " Set Screw.....
13516	7445	" " Shaft.....
13836	7445	" " " Bushing.....
448c	7450	" " " " Set Screw..
217F	7450	" " " " Set Screw.....
13811	7441	" Driving Shaft with 217F.....
13812	7445	" " " " Crank with two 1253c.....
1253c	7445	Looper Driving Shaft Crank Set Screw...
13813	7445	" " " " Link.....
13814	7445	" " " " Hinge Pin....
1454c	7463	" " " " " " Set Screw.....
853c	7450	Looper Set Screw.....
13881	7441	Needle Bar (hollow).....

NO.	PLATE	NAME
*13582	7444	Needle Bar Connecting Link with 794E..
13933	—	“ “ “ “ 13582 with 13896.....
794E	7444	Needle Bar Connecting Link Adjusting Screw.....
881c	7444	Needle Bar Connecting Link Hinge Screw
13896	7444	“ “ “ Stud with 1904 and two 175E.....
175E	7444	Needle Bar Connecting Stud Clamping Screw.....
1904	7444	Needle Bar Connecting Stud Roller (roller only).....
13816	7440	Needle Bar Crank with 435c and 1293c..
1293c	7450	“ “ “ Position Screw.....
435c	2831	“ “ “ Set Screw.....
13596	7465	“ Clamp with six 620F or 50014F, for $\frac{1}{8}$ in. to $\frac{1}{4}$ in. gauge.....
13892	7465	Needle Clamp with six 50014F, for $\frac{1}{16}$ in. gauge and above.....
2273	7445	Needle Clamp Pin.....
620F	7445	“ Set Screw for 13596.....
50014F	7445	“ “ “ for $\frac{3}{8}$ in. gauge and above.....
13818	7445	Oscillating Rock Shaft with 1454c.....
13819	7445	“ “ “ Hinge Pin.....
13820	7445	“ “ “ “ “ Bushing
448c	7450	“ “ “ “ “ Set Screw
2058	7441	Presser Bar.....
52016	7445	“ “ Lifter.....
15486	7463	“ “ “ Hinge Stud.....
453c	2831	“ “ “ “ “ Set Screw..
2953	7445	“ “ Lifting Bracket with 453c...
453c	2831	“ “ “ “ “ Set Screw...
32675	7463	“ “ Spring.....
2070	7445	“ “ “ Washer.....
30359	7546	“ Foot for braiding.....
31185	7546	Presser Foot for braiding leaving out the first and third needles from the right hand side and the second needle from the left hand side.....
31191	7547	Presser Foot for braiding, with four narrow slots for braid, using the first and second needles from the right hand side and the first and second needles from the left hand side, and with a wide slot for braid, using the third needle from the right hand side and the third needle from the left hand side.....

NO.	PLATE	NAME
31192	4666	Presser Foot for braiding, with five narrow slots for braid and with tube for braid for the first needle from the right hand side.....
30365	3040	Presser Foot for cording, for covering three cords with three strips.....
31196	7549	Presser Foot for cording, with three cord tubes and guide for upper strip, leaving out the first and second needles from the right hand side.....
31195	4678	Presser Foot for cording, with four cord tubes and guide for upper strip, leaving out the first needle from the right hand side.....
31177	3045	Presser Foot for cording, with five cord tubes and guides for upper strip.....
31175	3043	Presser Foot for gathering.....
30358	7543	“ “ “ general work.....
47288	7543	“ “ “ rims of soft hats.....
47290	5455	Presser Foot for strip cording, with guides for upper and under strips and four cord tubes, leaving out the first needle from the left hand side.....
31180	7549	Presser Foot for strip cording, with guides for upper and under strips and four cord tubes, leaving out the first needle from the right hand side.....
30357	4656	Presser Foot for strip cording, with guides for upper and under strips and five cord tubes.....
47293	7551	Presser Foot (double hinged) for general work.....
31199	5432	Presser Foot (double hinged, strip folding) for folding three strips.....
31174	3042	Presser Foot (front hinged) for general work.....
47294	7550	Presser Foot (hinged) with keel.....
31193	4667	“ “ (hinged, adjustable) for gath- ering, for 48122.....
47291	5456	Presser Foot (hinged, adjustable) for gath- ering, leaving out the first needle from the left hand side.....
31190	4646	Presser Foot (side hinged) for general work
31183	3099	“ “ (double strip folding) leaving out the third needle from the right hand side.....

NO.	PLATE	NAME
30364	3039	Presser Foot (strip folding).....
31200	5448	Presser Foot (strip folding) for cloth work, leaving out the first needle from the right hand side.....
31176	3044	Presser Foot (strip folding) for three strips
47292	5463	Presser Foot (strip folding) leaving out the first needle from the left hand side.....
31186	3126	Presser Foot (strip folding) leaving out the first needle from the right hand side...
30361	4678	Presser Foot (strip folding) leaving out the first and second needles from the right hand side and the second and third needles from the left hand side.....
31184	7548	Presser Foot (strip folding) strip to be stitched by the second and third needles from the right hand side and the first, second and third needles from the left hand side, the first needle from the right hand side for plain stitching.....
31189	4645	Presser Foot (strip folding) with three cord tubes, for cording between the second and third needles from the right hand side, the second and third needles from the left hand side, the third needle from the right hand side and the third needle from the left hand side.....
31179	7545	Presser Foot (strip folding) with four cord tubes, for inserting four cords in folded strip, leaving a space on both edges of strip between the edge of strip and the first cord from each side of strip, leaving out the first needle from the right hand side.....
47289	5454	Presser Foot (strip folding) with four cord tubes, leaving out the first needle from the left hand side.....
31194	7552	Presser Foot (strip folding) with four cord tubes, leaving out the first needle from the right hand side.....
31171	3041	Presser Foot (strip folding) with five cord tubes.....
31178	3045	Presser Foot (strip folding) with seven cord tubes.....

NO.	PLATE	NAME
31172	3041	Presser Foot (strip folding) with three cord tubes, for cording between the first and second needles from the right hand side, the first and second needles from the left hand side, the third needle from the right hand side and the third needle from the left hand side.....
30356	7552	Presser Foot (strip folding and cording) for covering three cords with three folded strips.....
30360	7550	Presser Foot (tube).....
31182	3099	" " " " for two strips.....
31198	5420	" " " " " " leaving out the second and third needles from the right hand side.....
30362	3043	Presser Foot (tube) for three strips.....
30363	4689	" " " " " " a n d under strips.....
31197	4668	Presser Foot (tube) for three strips of tape, for stitching tape on left hand edge, leaving out the first and third needles from the right hand side and the second needle from the left hand side.....
31173	3042	Presser Foot (tube) with four cord tubes, for cording between the first, second and third needles from the right hand side and the first, second and third needles from the left hand side.....
47295	7554	Presser Foot with three narrow slots, for braiding, leaving out the second needle from the right hand side and the first and third needles from the left hand side
47296	7554	Presser Foot with three slots for tape....
47297	7572	Presser Foot for stitching two braids on outside needles (outside needles equidistant from centre of needle bar).....
47298	7577	Presser Foot with upper and lower strip folder and three cord tubes, for inserting cord between four centre needles.....
47299	7546	Presser Foot for braiding, leaving out the first needle from the right hand side and the first and second needles from the left hand side.....
47300	7551	Presser Foot (side hinged) with three slots for braiding.....
47301	7553	Presser Foot (hinged) with three slots for tape.....

NO.	PLATE	NAME
47302	7543	Presser Foot with two slots for braid and two slots for tape, leaving out the two centre needles.....
47303	7544	Presser Foot with two slots for tape, leaving out the third needle from the left hand side and the second needle from the right hand side.....
47304	7544	Presser Foot with two slots for tape and three slots for braid.....
47305	7546	Presser Foot (tube) for three upper and three lower strips.....
47306	7547	Presser Foot with four slots for braid, leaving out the first needle from the right hand side.....
47307	7547	Presser Foot with one slot for braid and one slot for tape, leaving out the first and third needles from the right hand side.....
47308	7584	Presser Foot with two slots for braid and two slots for tape.....
47309	7584	Presser Foot (side hinged) with six slots for tape.....
47310	7552	Presser Foot (tube) for three strips of tape
47311	7550	" " for braiding, leaving out the first, third and fifth needles.....
47312	7572	Presser Foot with three slots for narrow tape and three slots for wide tape.....
	190D 7442	Presser Foot Screw.....
	263E 7450	Pressure Regulating Thumb Screw.....
13893	7466	Tension Bracket with twelve 13589.....
13894	—	Tension Bracket complete, Nos. 13893, six each 637F, 1547D, 1560C, 13710 and twelve 2921.....
	898F 7450	Tension Bracket Screw.....
	2269 7463	" " Steady Pin.....
	2921 7442	" Disc.....
13589	7442	" " Steady Pin.....
	1560C 7442	" Regulating Thumb Nut.....
	637F 7442	" Screw Stud.....
	1547D 7442	" " Nut.....
	13710 7442	" Spring.....
	13589 7442	" Thread Guide Pin.....
13839	—	Thread Guide (back of arm) six holes....
13840	7462	" " " " " 13839 with 13862.....
13895	7465	Tension Guide (side of arm) six holes....
	219D 7450	" " " " " Screw.....

NO.	PLATE	NAME
13842	—	Tension Guide (top of arm) six holes.....
13843	7463	" " " " " 13842 with 13862.....
50062J	7450	Thread Guide (top of arm) Screw.....
13929	7463	" Controller Post.....
	190D 7442	" " " Screw.....
13845	7442	" " Spring.....
	233D 7442	" " " Screw.....
13930	7463	" " Thread Guide.....
13931	—	Thread Controller complete, Nos. 233D, 13845 and 13929.....
13940	7463	Thread Take-up Plate.....
	883B 7445	" " " Screw.....
48142	5410	Throat Plate for 48122.....
48143	5411	" " " 48123.....
48144	5412	" " " 48124.....
48145	5413	" " " 48125 and 48138.....
48146	5414	" " " 48126.....
48147	5415	" " " 48127.....
48148	5416	" " " 48128, for under strip...
48149	7502	" " " 48129.....
48150	7503	" " " 48130.....
48151	7504	" " " 48131, for under strip...
48152	7610	" " " 48132, for gathering and under braiding.....
48153	7609	Throat Plate for 48122, leaving out the third needle from the right hand side and the third needle from the left hand side.....
48154	7612	Throat Plate for 48133.....
48155	8700	" " " 48134.....
48156	8701	" " " 48135.....
48157	8722	" " " 48136.....
48158	8723	" " " 48137.....
48159	8738	" " (No. 53 drill needle hole) for 48139.....
48160	8739	Throat Plate for 48140.....
	691F 7450	" " Screw.....
13635	1514	Drip Pan with four 1 in. wire nails.....

MACHINE No. 52-76

SIX NEEDLES, SIX HOOKS. MAKES SIX TUCKS

This Machine is the same as 52-56 with Tuck Folding Attachment and the following exceptions:

NO.	PLATE	NAME
13835	7458	Face Plate (lower).....
13801	7458	“ “ (upper).....
190D	7442	“ “ Screw.....
48512	5417	Feed Dog.....
48513	5418	“ “.....
48514	5419	“ “.....
48515	7480	“ “.....
48516	7481	“ “.....
48517	7613	“ “.....
48518	8744	“ “ (16 teeth to the inch).....
48519	8745	“ “ 11 teeth (16 teeth to the inch).....
48520	8746	“ “ 11 teeth (16 teeth to the inch).....
48527	7553	Presser Foot (hinged).....
48547	5417	Throat Plate (thin stock) for 48512.....
48548	5418	“ “ “ “ “ 48513.....
48549	5419	“ “ “ “ “ 48514.....
48550	7480	“ “ “ “ “ 48515.....
48551	7481	“ “ “ “ “ 48516.....
48552	7613	“ “ “ “ “ 48517.....
48553	8744	“ “ “ “ “ 48518.....
48554	8745	“ “ “ “ “ 48519.....
48555	8746	“ “ “ “ “ 48520.....

NOTE: Tuck Folding Attachments can be furnished for machines in use, but machines must be returned to the factory to be fitted. When parts are required for repairs the sample must accompany the order.

IRON BASE

NO.	PLATE	NAME
11118	7446	Bed Frame Cushion (leather).....
7263	7446	“ “ Hinge Connection (long)....
14098	7446	“ “ “ “ (short)....
14008	7446	“ “ “ “ Pin.....
970D	7446	“ “ Thumb Screw.....
13697	1511	“ “ with 970D, 2978, 7263, 14098, two 14008 and four each 11118 and wood screws 1¼ in. No. 12.....
2978	1514	Drip Pan.....

ACCESSORIES

NO.	PLATE	NAME
12361	7446	Machine Hinge Connection.....
44139	7446	“ “ Plate.....
44140	—	Machine Hinge complete, Nos. 12361, 44139 and merlized wood screw 1¼ in. No. 14.....
12405	7446	Machine Rest (felt).....
41400	7447	“ “ Pin (wood) 3½ in. long....
36569	7447	Oiler with 36571.....
36570	—	“ 36569, filled with oil.....
36571	7447	“ Spout, 1½ in. long, with 36807....
36807	7446	“ “ Washer (leather).....
26026	7447	Screw Driver (large).....
26485	7447	“ “ (small).....
120341	7458	Tweezers (curved).....
8909	7447	Wrench for 1513 and 1518.....
8908	7447	“ “ 1519 and 1520.....
4822	7447	“ “ 1521 and 1547.....

CORDER

FOR MACHINE No. 52-56

NO.	PLATE	NAME
28551	7464	Arm with Tip and Cord Guides.....
175D	7444	“ Adjusting Screw.....
28554	7464	“ Bracket.....
25790	7449	“ Hinge Pin.....
28556	7464	Arm and Bracket complete, Nos. 175D, 25790, 28551 and 28554.....
26212	7543	Presser Foot.....
28563	—	Corder complete, Nos. 135D, 26212 and 28556.....
135D	7450	Corder Screw.....
26354	1512	Cord Guide Eyelet.....
26355	1512	“ “ Plate.....
26356	1512	Cord Guide (table) complete, Nos. 26355 and seven 26354.....
26358	1512	Cord Tension Pin.....
26357	1512	“ “ Plate.....
26359	1512	Cord Tension (bed) complete, Nos. 26357 and ten 26358.....

PRESSER FEET

FOR MACHINE No. 52-56

NO.	PLATE	NAME
28573	7544	Presser Foot, for group cording.....
28574	7544	" " " space cording.....

TAPE HOLDERS

TAPE HOLDER (5 inch Diam.)

FOR UNDER THE BENCH

NO.	PLATE	NAME
36795	—	Body.....
36796	—	Cover.....
55D	7449	" Hinge Screw.....
28994	2116	Tape Holder complete, Nos. 55D, 36795, 36796 and two wood screws 1¼ in. No. 10.....

TAPE HOLDER (Straight) 8 in. Disc.

NO.	PLATE	NAME
26061	989	Bracket Wire with Disc.....
26062	989	Disc (adjustable) with 286D and 35925...
35925	7449	" Hub.....
286D	7450	" " Thumb Screw.....
26325	7448	Foot with 736D and three wood screws 1 in. No. 12.....
736D	7449	Foot Thumb Screw.....
26063	989	Tape Holder complete, Nos. 26061 and 26062.....
26065	—	Tape Holder with Foot complete, Nos. 26063 and 26325.....
284D	7449	Tape Holder Thumb Screw.....

TAPE HOLDER (Offset) 10 in. Disc.

NO.	PLATE	NAME
26066	989	Bracket Wire.....
26067	—	Bracket Wire complete, Nos. 26066, 26068 and 26072.....
26068	989	Disc.....
26069	989	" Hub.....
26070	7446	" " Rivet.....
26071	—	Disc complete, Nos. 26068, 26069 and three 26070.....

TAPE HOLDERS

NO.	PLATE	NAME
26064	7448	Foot with 736D and three wood screws 1 in. No. 12.....
736D	7449	Foot Thumb Screw.....
26072	989	Tape Guide.....
26073	7449	Tension Adjusting Collar with 286D.....
286D	7450	" " " Thumb Screw...
13211	7446	" " " Spring.....
26074	989	Tape Holder complete, Nos. 13211, 26067, 26071 and 26073.....
26343	—	Tape Holder with Foot complete, Nos. 26064 and 26074.....

FOOT LIFTER PARTS

NO.	PLATE	NAME
5596	7448	Bell Crank.....
56848	—	" " 5596 with 5599 and 5601.....
5599	7448	" " Bracket.....
178E	7450	" " " Screw.....
5601	7446	" " Hinge Pin.....
5735	7446	" " Spring.....
5598	7448	Bell Crank complete, Nos. 5735 and 56848
5670	—	Chain, length 26 in. to 35 in., with 56864 and 56865.....

NOTE: When ordering No. 5670, give
length required

56864	7463	Chain Hook (large).....
56865	7463	" " (small).....
4879	7448	" Connecting Link for 4885.....
13587	7448	Lifting Lever.....
13588	7448	" " Connecting Rod.....
12416	7446	" " " " Joint.....
76D	7446	" " " " " Hinge Screw.....
1521E	7446	Lifting Lever Connecting Rod Lock Nut..
802D	7450	" " Hinge Screw.....
2763	1516	Rock Shaft.....
12242	1516	" " Hanger with two wood screws 1 in. No. 10.....
6337	1516	Rock Shaft Lifting Bracket with two 356c
12243	1516	" " " " Hook for 4880
7125	1516	" " " " " for 4880
356C	7450	" " " " " SetScrew
356C	7450	" " " " " Set Screw....
2770	1516	" " Stop Dog with 356c.....
356C	7450	" " " " " Set Screw.....

FOOT LIFTER PARTS

NO.	PLATE	NAME
4880	1516	Rock Shaft complete, Nos. 2763, 2770, 7125, 12243 and two each 6337 and 12242.....
4881	1516	Treadle.....
4882	7448	" Shaft.....
4883	7448	" Spring.....
4884	1516	" Stand.....
4885	1516	Treadle complete, Nos. 4879, 4881 to 4884 and two wood screws 1 in. No. 16.....
13725	—	Foot Lifter complete, Nos. 76d, 802d, 1521E, 4880, 4885, 5598, 5670, 12416, 13587, 13588 and two 178E.....

KNEE LIFTER PARTS

NO.	PLATE	NAME
5596	7448	Bell Crank.....
56848	—	" " 5596 with 5599 and 5601.....
5599	7448	" " Bracket.....
178E	7450	" " " Screw.....
5601	7446	" " Hinge Pin.....
5735	7446	" " Spring.....
5598	7448	Bell Crank complete, Nos. 5735 and 56848
13587	7448	Lifting Lever.....
13588	7448	" " Connecting Rod.....
12416	7446	" " " " Joint.....
76D	7446	" " " " Hinge Screw.....
1521E	7446	Lifting Lever Connecting Rod Lock Nut..
802D	7450	" " Hinge Screw.....
2763	1511	Rock Shaft.....
12242	1511	" " Hanger with two wood screws 1 in. No. 10.....
2765	1511	Rock Shaft Knee Arm.....
2766	1511	" " " " Hub with 356c....
356c	7450	" " " " " Set Screw....
2768	—	Rock Shaft Knee Arm complete, Nos. 2765 to 2767.....
2767	1511	Rock Shaft Knee Plate with 356c.....
356c	7450	" " " " Set Screw.....
6337	1511	" " Lifting Bracket with two 356c
2778	1511	" " " " Hook.....
356c	7450	" " " " " Set Screw
356c	7450	" " " " " Set Screw....
2770	1511	" " Stop Dog with 356c.....
356c	7450	" " " " Set Screw.....

KNEE LIFTER PARTS

NO.	PLATE	NAME
2777	1511	Rock Shaft complete, Nos. 2763, 2768, 2770, 2778, 6337 and two 12242.....
17039	—	Knee Lifter complete, Nos. 76d, 802d, 1521E, 2777, 5598, 12416, 13587, 13588 and two 178E.....

THREAD UNWINDER

FOR THREE SPOOLS

NO.	PLATE	NAME
225389	7165	Spool Rest with 201018c, for one spool...
225395	7165	" " " 201018c, for two spools..
225388	7165	" " Rod.....
200383c	7463	" " " Set Screw.....
201018c	7463	" " Set Screw.....
202490	7165	" Stand with 200383c.....
225391	7165	Thread Guide.....
201696J	7463	" " Lock Nut.....
225392	7165	" " Rod with 208E and 225393
208E	7450	" " " Screw.....
225393	7463	" " " Washer.....
225397	7165	Thread Unwinder complete, Nos. 201696J, 202490, 225388, 225389, 225392, 225395, three each 225391 and wood screws 7/8 in. No. 12.....
27739	7234	Thread Cone (wood) for large cones....
225390	7234	" " Holder, for inverted cones

NOTE: Nos. 27739 and 225390 are used with, but not included in 225397

FEED ROLLS

NO.	PLATE	NAME
27971	2830	Feed Roll (lower) with two 446c.....
446c	2831	" " " Set Screw.....
27972	2829	" " " Shaft.....
11411	2831	" " " Collar with 453c
453c	2831	" " " " Set Screw
27973	2830	" " " Support.....
27974	2830	" " (upper).....
27975	2831	" " " Bar.....
6533	2831	" " " Collar with 460c..
460c	2831	" " " " Set Screw..
27976	2831	" " " Guide Bracket with 454c.....

NO.	PLATE	NAME
454c	2831	Feed Roll (upper) Bar Guide Bracket Set Screw.....
9532	2831	Feed Roll (upper) Bar Lifter with 9533.....
81D	2831	" " " " " Hinge Screw.....
9533	2831	" " " " " Stop Pin.....
2065	2831	" " " " " Spring.....
27977	2830	" " " " " Bracket with 453c and 910c.....
910c	2831	Feed Roll (upper) Bracket Set Screw.....
2932	2830	" " " " " Shaft.....
453c	2831	" " " " " Set Screw.....
27978	2829	" " " " " Frame.....
27979	2829	" " " " " Pulley (grooved) 9 $\frac{1}{8}$ in. diam., with 435c.....
435c	2831	Feed Roll Pulley (grooved) Set Screw.....
27980	—	Feed Rolls complete, Nos. 81D, 2065, 2932, 6533, 9532, 11411, 27971 to 27979 and six wood screws 1 $\frac{1}{4}$ in. No. 12.....

OBSOLETE PARTS

NO.	PLATE	NAME
13793	7440	Arm Shaft.....
13809	7445	Looper.....
13891	7465	" " " " " Carrier with two 237F and six 853c.....
237F	7450	" " " " " Set Screw for 13891.....
1253c	7445	" " " " " Driving Shaft Link Hinge Pin Set Screw for 13818.....
640c	7450	Needle Bar Connecting Stud Clamping Screw.....
1058c	7445	Presser Bar Lifter Hinge Screw.....
1520E	7444	" " " " " Nut.....
914F	7442	Tension Bracket Screw.....
13844	7442	Thread Controller Post for 13847.....
13846	7442	" " " " " Thread Guide.....
13847	—	Thread Controller complete, Nos. 233D, 13844 and 13845.....

NUMERICAL LIST OF PARTS

NO.	PLATE	NAME
55D	7449	Tape Holder Cover Hinge Screw for 28994.....
74E	7444	Feed Regulator Hinge Screw.....
76D	7446	Lifting Lever Connecting Rod Joint Hinge Screw for 13725 and 17039.....
81D	2831	Feed Roll (upper) Bar Lifter Hinge Screw for 27980.....
135D	7450	Corder Screw for 28553.....
138E	7450	Arm Screw (right).....
144D	7450	" " " " " Shaft Screw.....
145E	7450	Crank Connecting Rod Cap Screw for 13799.....
145E	7450	Feed Lifting Rock Shaft Connecting Rod Cap Screw for 13808.....
157J	7444	Feed Lifting Rock Shaft Crank Clamping Screw for 2509.....
175D	7444	Corder Arm Adjusting Screw for 28556.....
175E	7444	Needle Bar Connecting Stud Clamping Screw for 13896.....
178E	7450	Bell Crank Bracket Screw for 13725 and 17039.....
190D	7442	Face Plate Screw for 52-56 Machine.....
190D	7442	" " " " " (upper) Screw for 52-76 Machine.....
190D	7442	Presser Foot Screw.....
190D	7442	Thread Controller Post Screw.....
191c	7450	Feed Dog Screw.....
208E	7450	Thread Unwinder Thread Guide Rod Screw for 225392.....
210D	7450	Balance Wheel Oil Cover Screw.....
211c	7463	Looper Carrier Set Screw for 13268.....
217F	7450	" " " " " Shaft Set Screw for 13811.....
219D	7450	Thread Guide (side of arm) Screw.....
233D	7442	" " " " " Controller Spring Screw for 13847 and 13931.....
237F	7450	Looper Carrier Set Screw for 13891, obsolete.....
263E	7450	Pressure Regulating Thumb Screw.....
284D	7449	Tape Holder Thumb Screw for 26065.....
286D	7450	Arm Side Cover Thumb Screw.....
286D	7450	Tape Holder Disc Hub Thumb Screw for 26062.....
286D	7450	Tape Holder Tension Adjusting Collar Thumb Screw for 26073.....

NO. PLATE	NAME
307c 7450	Feed Lifting Rock Shaft Screw Centre...
307c 7450	" Rock Shaft Screw Centre.....
315c 2642	" Bar Screw Centre.....
356c 7450	Rock Shaft Knee Arm Hub Set Screw for 2766.....
356c 7450	Rock Shaft Knee Plate Set Screw for 2767
356c 7450	" " Lifting Bracket Hook Set Screw for 6337.....
356c 7450	Rock Shaft Lifting Bracket Set Screw for 6337.....
356c 7450	Rock Shaft Stop Dog Set Screw for 2770..
375c 7450	Crank Connecting Rod Hinge Screw.....
375c 7450	Feed Lifting Rock Shaft Connecting Rod Hinge Screw.....
378c 7444	Feed Connecting Link Hinge Screw (long)
378c 7444	" Forked Connection Hinge Screw....
380c 7444	" Connecting Link Hinge Screw (short)
435c 2831	" Roll Pulley (grooved) Set Screw for 27979.....
435c 2831	Needle Bar Crank Set Screw for 13816....
443c 7450	Arm Shaft Flanged Bushing (front) Set Screw.....
446c 2831	Arm Shaft Flanged Bushing (back) Set Screw.....
446c 2831	Feed Roll (lower) Set Screw for 27971....
448c 7450	Balance Wheel Set Screw for 13796.....
448c 7450	Feed and Feed Lifting Eccentric Set Screw for 13803.....
448c 7450	Looper Carrier Shaft Bushing Set Screw..
448c 7450	Oscillating Rock Shaft Hinge Pin Set Screw
453c 2831	Feed Roll (lower) Shaft Collar Set Screw for 11411.....
453c 2831	Feed Roll (upper) Shaft Set Screw for 27977.....
453c 2831	Presser Bar Lifter Hinge Stud Set Screw for 13946.....
453c 2831	Presser Bar Lifting Bracket Set Screw for 2953.....
464c 2831	Feed Roll (upper) Bar Guide Bracket Set Screw for 27976.....
460c 2831	Feed Roll (upper) Bar Collar Set Screw for 6533.....
465c 7444	Feed Rock Shaft Crank Set Screw for 2048
620F 7445	Needle Set Screw for 13596.....
637F 7442	Tension Screw Stud for 13894.....
640c 7450	Needle Bar Connecting Stud Clamping Screw, obsolete.....

NO. PLATE	NAME
691F 7450	Throat Plate Screw.....
736D 7449	Tape Holder Foot Thumb Screw for 26064 and 26325.....
747D 7444	Feed Regulator Thumb Screw.....
794E 7444	Needle Bar Connecting Link Adjusting Screw for 13582.....
802D 7450	Lifting Lever Hinge Screw for 13725 and 17039.....
853c 7450	Looper Set Screw for 13628 and 13891...
880E 7450	Arm Screw (left).....
881c 7444	Needle Bar Connecting Link Hinge Screw
883B 7445	Thread Take-up Plate Screw.....
898D 7450	Arm Oil Tube Bracket Screw.....
898F 7450	Tension Bracket Screw.....
910c 2831	Feed Roll (upper) Bracket Set Screw for 27977.....
914F 7442	Tension Bracket Screw, obsolete.....
970D 7446	Bed Frame Thumb Screw for 13697.....
1058c 7445	Presser Bar Lifter Hinge Screw, obsolete
1253c 7445	Looper Driving Shaft Crank Set Screw for 13812, obsolete.....
1253c 7445	Looper Driving Shaft Link Hinge Pin Set Screw for 13818.....
1293c 7450	Needle Bar Crank Position Screw for 13816
1454c 7463	Looper Driving Shaft Link Hinge Pin Set Screw for 13818.....
1513J 2642	Feed Lifting Rock Shaft Screw Centre Nut
1513J 2642	" Rock Shaft Screw Centre Nut.....
1518E 7450	Crank Connecting Rod Hinge Screw Nut
1518E 7450	Feed Lifting Rock Shaft Connecting Rod Hinge Screw Nut.....
1519E 7450	Feed Bar Screw Centre Nut.....
1520E 7444	" Connecting Link Hinge Screw Nut..
1520E 7444	" Forked Connection Hinge Screw Nut
1520E 7444	Presser Bar Lifter Hinge Screw Nut, obsolete.....
1521E 7446	Lifting Lever Connecting Rod Lock Nut for 13725 and 17039.....
1547D 7442	Tension Screw Stud Nut for 13894.....
1560c 7442	" Regulating Thumb Nut for 13894
1813 7444	Feed Lifting Rock Shaft Crank Roller and Stud for 2509.....
1904 7444	Needle Bar Connecting Stud Roller (roller only) for 13815 and 13896.....
2039 7444	Feed Connecting Link.....
2046 —	Feed Rock Shaft complete, Nos. 2047 and 2048.....

NUMERICAL LIST OF PARTS

NO.	PLATE	NAME
2047	7440	Feed Rock Shaft for 2046.....
2048	7444	" " " Crank with 465c, for 2046.....
2049	7444	Feed Rock Shaft Crank Pin.....
2058	7441	Presser Bar.....
2065	2831	Feed Roll (upper) Bar Spring for 27980..
2070	7445	Presser Bar Spring Washer.....
2164	7444	Feed Regulator.....
2269	7463	Tension Bracket Steady Pin.....
2273	7445	Needle Clamp Pin.....
2509	7444	Feed Lifting Rock Shaft Crank with 157j and 1813, for 13807.....
2763	1511	Rock Shaft for 2777 and 4880.....
		Nos. 2765 to 2767 FOR 2768
2765	1511	Rock Shaft Knee Arm.....
2766	1511	" " " Hub with 356c....
2767	1511	" " " Plate with 356c.....
2768	—	Rock Shaft Knee Arm complete for 2777, Nos. 2765 to 2767.....
2770	1511	Rock Shaft Stop Dog with 356c, for 2777 and 4880.....
2777	1511	Rock Shaft complete for 17039, Nos. 2763, 2768, 2770, 2778, 6337 and two 12242..
2778	1511	Rock Shaft Lifting Bracket Hook for 2777
2921	7442	Tension Disc for 13894.....
2932	2830	Feed Roll (upper) Shaft for 27980.....
2953	7445	Presser Bar Lifting Bracket with 453c...
2978	1514	Drip Pan for 13697.....
4389	7445	Arm Dowel Pin.....
4822	7447	Wrench for 1521 and 1547 (Accessories)..
4879	7448	Chain Connecting Link for 4885.....
4880	1516	Rock Shaft complete for 13725, Nos. 2763, 2770, 7125, 12243 and two each 6337 and 12242.....
		Nos. 4881 to 4884 FOR 4885
4881	1516	Treadle.....
4882	7448	" Shaft.....
4883	7448	" Spring.....
4884	1516	" Stand.....
4885	1516	Treadle complete for 13725, Nos. 4879, 4881 to 4884 and two wood screws 1 in. No. 16.....
5596	7448	Bell Crank for 56848.....
5598	7448	Bell Crank complete for 13725 and 17039, Nos. 5735 and 56848.....

NUMERICAL LIST OF PARTS

NO.	PLATE	NAME
5599	7448	Bell Crank Bracket for 56848.....
5601	7446	" " Hinge Pin for 56848.....
5670	—	Chain, length 26 in. to 35 in., with 56864 and 56865, for 13725.....
5735	7446	Bell Crank Spring for 5598.....
6337	1516	Rock Shaft Lifting Bracket with two 356c, for 2777 and 4880.....
6533	2831	Feed Roll (upper) Bar Collar with 460c, for 27980.....
7125	1516	Rock Shaft Lifting Bracket Hook for 4880
7263	7446	Bed Frame Hinge Connection (long) for 13697.....
8908	7447	Wrench for 1519 and 1520 (Accessories)..
8909	7447	" " 1513 and 1518 (Accessories)..
9532	2831	Feed Roll (upper) Bar Lifter with 9533, for 27980.....
9533	2831	Feed Roll (upper) Bar Lifter Stop Pin for 9532.....
11118	7446	Bed Frame Cushion (leather) for 13697..
11411	2831	Feed Roll (lower) Shaft Collar with 453c, for 27980.....
12242	1511	Rock Shaft Hanger with two wood screws 1 in. No. 10, for 2777 and 4880.....
12243	1516	Rock Shaft Lifting Bracket Hook for 4880
12361	7446	Machine Hinge Connection for 44140....
12405	7446	" Rest, felt (Accessories).....
12416	7446	Lifting Lever Connecting Rod Joint for 13725 and 17039.....
13211	7446	Tape Holder Tension Adjusting Spring for 26074.....
13516	7445	Looper Carrier Shaft.....
13581	7441	Needle Bar (hollow).....
*13582	7444	" " Connecting Link with 794e, for 13933.....
13587	7448	Lifting Lever for 13725 and 17039.....
13588	7448	" " Connecting Rod for 13725 and 17039.....
13589	7442	Tension Disc Steady Pin for 13893.....
13589	7442	" Thread Guide Pin for 13893.....
13594	7445	Thread Take-up Plate.....
13596	7465	Needle Clamp with six 620F or 50014F, for 1/8 in. to 1/4 in. gauge.....
13617	7463	Looper.....
13628	7463	" Carrier with two 211c and six 853c
13635	1514	Drip Pan with four 1 in. wire nails.....

NO.	PLATE	NAME
13697	1511	Bed Frame with 970D, 2978, 7263, 14098, two 14008 and four each 11118 and wood screws 1¼ in. No. 12.....
13710	7442	Tension Spring for 13894.....
13725	—	Foot Lifter complete, Nos. 76D, 802D, 1521E, 4880, 4885, 5598, 5670, 12416, 13587, 13588 and two 178E.....
*13789	—	Arm.....
13790 to 13792		Nos. cancelled.
13793	7440	Arm Shaft, obsolete.....
13794	7440	" " Flanged Bushing (back).....
13795	7440	" " " " (front).....
13796	7441	Balance Wheel, 2⅜ in. pulley, with two 448c.....
13797	7441	Balance Wheel Oil Cover.....
*13798	—	Bed.....
13799	7441	Crank Connecting Rod with 13800 and two 145E.....
*13800	—	Crank Connecting Rod Cap for 13799....
13801	7458	Face Plate (upper) for 52-76 Machine....
13802	7443	Feed Bar.....
13803	7444	" and Feed Lifting Eccentric with 448c
13804	7444	" " " " Sleeve....
13805	7440	" Forked Connection.....
13806	7440	" Lifting Rock Shaft for 13807.....
13807	—	Feed Lifting Rock Shaft complete, Nos. 2509 and 13806.....
13808	7440	Feed Lifting Rock Shaft Connecting Rod with 43977 and two 145E.....
13809	7445	Looper, obsolete.....
13811	7441	" Driving Shaft with 217F.....
13812	7445	" " " Crank with two 1253c.....
13813	7445	Looper Driving Shaft Link.....
13814	7445	" " " " Hinge Pin....
13816	7440	Needle Bar Crank with 435c and 1293c..
13818	7445	Oscillating Rock Shaft with 1454c.....
13819	7445	" " " " Hinge Pin.....
13820	7445	" " " " Bushing
13821 to 13830		Nos. cancelled.
		Nos. 13831 to 13833 FOR 13834
13831	7442	Arm Oil Tube (left) with 49092, for oiling 13811.....
13832	7442	Arm Oil Tube (right) with 49092, for oiling 13813.....

NO.	PLATE	NAME
13833	—	Arm Oil Tube Bracket.....
13834	7442	" " " " 13833 with 13831 and 13832.....
13835	7458	Face Plate (lower) for 52-76 Machine....
13836	7445	Looper Carrier Shaft Bushing.....
13839	—	Thread Guide (back of arm) six holes, for 13840.....
13840	7462	Thread Guide (back of arm) 13839 with 13862.....
13842	—	Thread Guide (top of arm) six holes, for 13843.....
13843	7463	Thread Guide (top of arm) 13842 with 13862.....
13844	7442	Thread Controller Post for 13847, obsolete
13845	7442	" " Spring for 13847.....
13846	7442	" " Thread Guide, obsolete
13847	—	Thread Controller complete, Nos. 233D, 13844 and 13845, obsolete.....
13849	7441	Face Plate for 52-56 Machine.....
13862	7442	Arm Oil Tube with 29599, for oiling 13799 and 13804, for 13840 and 13843.....
13891	7465	Looper Carrier with two 237F and six 853c, obsolete.....
13892	7465	Needle Clamp with six 50014F, for ⅜ in. gauge and above.....
13893	7466	Tension Bracket with twelve 13589, for 13894.....
13894	—	Tension Bracket complete, Nos. 13893, six each 637F, 1547D, 1560C, 13710 and twelve 2921.....
13895	7465	Thread Guide (side of arm) six holes.....
13896	7444	Needle Bar Connecting Stud with 1904 and two 175E, for 13933.....
13928	7458	Arm Shaft.....
13929	7463	Thread Controller Post for 13931.....
13930	7463	" " Thread Guide.....
13931	—	Thread Controller complete, Nos. 233D, 13845 and 13929.....
13940	7463	Thread Take-up Plate.....
*13945	—	Arm for 13946.....
*13946	—	" 13945 with 453c and 15486.....
14008	7446	Bed Frame Hinge Connecting Pin for 13697.....
14008	7446	Bed Frame Hinge Connection (short) for 13697.....
15196	7441	Arm Side Cover.....
15486	7463	Presser Bar Lifter Hinge Stud for 13946..

NUMERICAL LIST OF PARTS

NO.	PLATE	NAME
17039	—	Knee Lifter complete, Nos. 76d, 802d, 1521E, 2777, 5598, 12416, 13587, 13588 and two 178E.....
21350	7444	Feed Regulator Thumb Screw Stop.....
25790	7449	Corder Arm Hinge Pin for 28556.....
26026	7447	Screw Driver, large (Accessories).....
26061	989	Tape Holder Bracket Wire with Disc, for 26063.....
26062	989	Tape Holder Disc (adjustable) with 286d and 35925, for 26063.....
26063	989	Tape Holder (straight) 8 in. disc, complete, for 26065, Nos. 26061 and 26062.....
26064	7448	Tape Holder Foot with 736d and three wood screws 1 in. No. 12, for 26343....
26065	—	Tape Holder with Foot complete, Nos. 26063 and 26325.....
26066	989	Tape Holder Bracket Wire for 26067.....
26067	—	Tape Holder Bracket Wire complete for 26074, Nos. 26066, 26068 and 26072....
26068	989	Tape Holder Disc for 26067 and 26071....
26069	989	" " " " Hub for 26071.....
26070	7446	" " " " Rivet for 26071,per 100
26071	—	Tape Holder Disc complete for 26074, Nos. 26068, 26069 and three 26070....
26072	989	Tape Holder Tape Guide for 26067.....
26073	7449	" " Tension Adjusting Collar with 286d, for 26074.....
26074	989	Tape Holder (offset) 10 in. disc, complete, for 26343, Nos. 13211, 26067, 26071 and 26073.....
26212	7543	Presser Foot for 28563.....
26325	7448	Tape Holder Foot with 736d and three wood screws 1 in. No. 12, for 26065....
26343	—	Tape Holder with Foot complete, Nos. 26064 and 26074.....
26354	1512	Corder Cord Guide Eyelet for 26356.....
26355	1512	" " " Plate for 26356.....
26356	1512	Corder Cord Guide (table) complete for 52-56 Machine, Nos. 26355 and seven 26354.....
26357	1512	Corder Cord Tension Plate for 26359....
26358	1512	" " " Pin for 26359.....
26359	1512	Corder Cord Tension (bed) complete for 52-56 Machine, Nos. 26357 and ten 26358.....
26485	7447	Screw Driver, small (Accessories).....

NUMERICAL LIST OF PARTS

NO.	PLATE	NAME
27739	7234	Thread Unwinder Thread Cone (wood) for large cones, for 225397.....
Nos. 27971 to 27979 for 27980		
27971	2830	Feed Roll (lower) with two 446c.....
27972	2829	" " " Shaft.....
27973	2830	" " " " Support.....
27974	2830	" " (upper).....
27975	2831	" " " Bar.....
27976	2831	" " " " Guide Bracket with 454c.....
27977	2830	Feed Roll (upper) Bracket with 453c and 910c.....
27978	2829	Feed Roll Frame.....
27979	2829	" " Pulley (grooved) 9 $\frac{1}{8}$ in. diam., with 435c.....
27980	—	Feed Rolls complete, Nos. 81d, 2065, 2932, 6533, 9532, 11411, 27971 to 27979 and six wood screws 1 $\frac{1}{4}$ in. No. 12.....
28551	7464	Corder Arm with Tip and Cord Guides for 28556.....
28554	7464	Corder Arm Bracket for 28556.....
28556	7464	Corder Arm and Bracket complete for 28563, Nos. 175d, 25790, 28551 and 28554.....
28563	—	Corder complete for 52-56 Machine, Nos. 135d, 26212 and 28556.....
28573	7544	Presser Foot, for group cording, for 52-56 Machine.....
28574	7544	Presser Foot, for space cording, for 52-56 Machine.....
28994	2116	Tape Holder (5 in. diam.) complete, for under the bench, Nos. 55d, 36795, 36796 and two wood screws 1 $\frac{1}{4}$ in. No. 10....
29599	7442	Arm Oil Tube Packing (felt) for 13862,per 100
Nos. 30356 to 30365 for 52-56 MACHINE		
30356	7552	Presser Foot (strip folding and cording) for covering three cords with three folded strips.....
30357	4656	Presser Foot, for strip cording, with guides for upper and under strips and five cord tubes.....
30358	7543	Presser Foot, for general work.....
30359	7546	" " " braiding.....
30360	7550	" " (tube).....

NO.	PLATE	NAME
30361	4678	Presser Foot (strip folding) leaving out the first and second needles from the right hand side and the second and third needles from the left hand side.....
30362	3043	Presser Foot (tube) for three strips.....
30363	4689	" " " " " " " and under strip.....
30364	3039	Presser Foot (strip folding).....
30365	3040	" " for cording, for covering three cords with three strips.....

Nos. 31171 TO 31180 FOR 52-56 MACHINE

31171	3041	Presser Foot (strip folding) with five cord tubes.....
31172	3041	Presser Foot (strip folding) with three cord tubes, for cording between the first and second needles from the right hand side, the first and second needles from the left hand side, the third needle from the right hand side and the third needle from the left hand side.....
31173	3042	Presser Foot (tube) with four cord tubes, for cording between the first, second and third needles from the right hand side and the first, second and third needles from the left hand side.....
31174	3042	Presser Foot (front hinged) for general work
31175	3043	" " for gathering.....
31176	3044	" " (strip folding) for three strips
31177	3045	" " for cording, with five cord tubes and guides for upper strip.....
31178	3045	Presser Foot (strip folding) with seven cord tubes.....
31179	7545	Presser Foot (strip folding) with four cord tubes, for inserting four cords in folded strip, leaving a space on both edges of strip between the edge of strip and the first cord from each side of strip, leaving out the first needle from the right hand side.....
31180	7549	Presser Foot for strip cording, with guides for upper and under strips and four cord tubes, leaving out the first needle from the right hand side.....

Nos. 31182 TO 31186 FOR 52-56 MACHINE

31182	3099	Presser Foot (tube) for two strips.....
-------	------	---

NO.	PLATE	NAME
31183	3099	Presser Foot (double strip folding) leaving out the third needle from the right hand side.....
31184	7548	Presser Foot (strip folding) strip to be stitched by the second and third needles from the right hand side and the first, second and third needles from the left hand side, the first needle from the right hand side for plain stitching.....
31185	7546	Presser Foot for braiding, leaving out the first and third needles from the right hand side and the second needle from the left hand side.....
31186	3126	Presser Foot (strip folding) leaving out the first needle from the right hand side

Nos. 31189 TO 31200 FOR 52-56 MACHINE

31189	4645	Presser Foot (strip folding) with three cord tubes, for cording between the second and third needles from the right hand side, the second and third needles from the left hand side, the third needle from the right hand side and the third needle from the left hand side.....
31190	4646	Presser Foot (side hinged) for general work
31191	7547	Presser Foot for braiding, with four narrow slots for braid, using the first and second needles from the right hand side and the first and second needles from the left hand side, and with a wide slot for braid, using the third needle from the right hand side and the third needle from the left hand side.....
31192	4666	Presser Foot for braiding, with five narrow slots for braid, and with tube for braid for the first needle from the right hand side.....
31193	4667	Presser Foot (hinged, adjustable) for gathering, for 48122.....
31194	7552	Presser Foot (strip folding) with four cord tubes, leaving out the first needle from the right hand side.....
31195	4678	Presser Foot for cording, with four cord tubes and guide for upper strip, leaving out the first needle from the right hand side.....

NO.	PLATE	NAME
31196	7549	Presser Foot for cording, with three cord tubes and guide for upper strip, leaving out the first and second needles from the right hand side.....
31197	4668	Presser Foot (tube) for three strips of tape, for stitching tape on the left hand edge, leaving out the first and third needles from the right hand side and the second needle from the left hand side.....
31198	5420	Presser Foot (tube) for two strips, leaving out the second and third needles from the right hand side.....
31199	5432	Presser Foot (double hinged, strip folding) for folding three strips.....
31200	5448	Presser Foot (strip folding) for cloth work, leaving out the first needle from the right hand side.....
32675	7463	Presser Bar Spring.....
35925	7449	Tape Holder Disc Hub for 26062.....
36569	7447	Oiler with 36571, for 36570.....
36570	—	" 36569, filled with oil (Accessories)...
36571	7447	" Spout, 1¼ in. long, with 36807, for 36569.....
36795	—	Tape Holder Body for 28994.....
36796	—	" " Cover for 28994.....
36807	7446	Oiler Spout Washer (leather) for 36571...
41400	7447	Machine Rest Pin (wood) 3½ in. long (Accessories).....
*43977	—	Feed Lifting Rock Shaft Connecting Rod Cap for 13808.....
44139	7446	Machine Hinge Plate for 44140.....
44140	—	Machine Hinge complete, Nos. 12361, 44139 and merlized wood screw 1¼ in. No. 14 (Accessories).....
Nos. 47288 TO 47312 FOR 52-56 MACHINE		
47288	7543	Presser Foot, for rims of soft hats.....
47289	5454	Presser Foot (strip folding) with four cord tubes, leaving out the first needle from the left hand side.....
47290	5455	Presser Foot for strip cording, with guides for upper and under strips and four cord tubes, leaving out the first needle from the left hand side.....
47291	5456	Presser Foot (hinged, adjustable) for gathering, leaving out the first needle from the left hand side.....

NO.	PLATE	NAME
47292	5463	Presser Foot (strip folding) leaving out the first needle from the left hand side.....
47293	7551	Presser Foot (double hinged) for general work.....
47294	7550	Presser Foot (hinged) with keel.....
47295	7554	Presser Foot with three narrow slots, for braiding, leaving out the second needle from the right hand side and the first and third needles from the left hand side.....
47296	7554	Presser Foot with three slots for tape....
47297	7572	Presser Foot for stitching two braids on outside needles (outside needles, equidistant from centre of needle bar).....
47298	7577	Presser Foot with upper and lower strip folder and three cord tubes, for inserting cord between four centre needles...
47299	7546	Presser Foot for braiding, leaving out the first needle from the right hand side and the first and second needles from the left hand side.....
47300	7551	Presser Foot (side hinged) with three slots for braiding.....
47301	7553	Presser Foot (hinged) with three slots for tape.....
47302	7543	Presser Foot with two slots for braid and two slots for tape, leaving out the two centre needles.....
47303	7544	Presser Foot with two slots for tape, leaving out the third needle from the left hand side and the second needle from the right hand side.....
47304	7544	Presser Foot with two slots for tape and three slots for braid.....
47305	7546	Presser Foot (tube) for three upper and three lower strips.....
47306	7547	Presser Foot with four slots for braid leaving out the first needle from the right hand side.....
47307	7547	Presser Foot with one slot for braid and one slot for tape, leaving out the first and third needles from the right hand side.....
47308	7584	Presser Foot with two slots for braid and two slots for tape.....
47309	7584	Presser Foot (side hinged) with six slots for tape.....

NUMERICAL LIST OF PARTS

NO.	PLATE	NAME
47310	7552	Presser Foot (tube) for three strips of tape
47311	7550	" " for braiding, leaving out the first, third and fifth needles.....
47312	7572	Presser Foot with three slots for narrow tape and three slots for wide tape.....

Nos. 48122 TO 48140 FOR 52-56 MACHINE

48122	5410	Feed Dog, for gathering.....
48123	5411	" "
48124	5412	" "
48125	5413	" "
48126	5414	" "
48127	5415	" "
48128	5416	" "
48129	7502	Feed Dog leaving out the second needle from the right hand side and the first and third needles from the left hand side
48130	7503	Feed Dog.....
48131	7504	" "
48132	7610	" " for gathering and under braiding
48133	7612	" "
48134	8700	" "
48135	8701	" "
48136	8722	" "
48137	8723	" "
48138	5413	" "
48139	8738	" "
48140	8739	" "
48142	5410	Throat Plate for 48122.....
48143	5411	" " " 48123.....
48144	5412	" " " 48124.....
48145	5413	" " " 48125 and 48138.....
48146	5414	" " " 48126.....
48147	5415	" " " 48127.....
48148	5416	" " " 48128, for under strip...
48149	7502	" " " 48129.....
48150	7503	" " " 48130.....
48151	7504	" " " 48131, for under strip...
48152	7610	" " " 48132, for gathering and under braiding.....
48153	7609	Throat Plate for 48122, leaving out the third needle from the right hand side and the third needle from the left hand side.....
48154	7612	Throat Plate for 48133.....
48155	8700	" " " 48134.....
48156	8701	" " " 48135.....

NUMERICAL LIST OF PARTS

NO.	PLATE	NAME
48157	8722	Throat Plate for 48136.....
48158	8723	" " " 48137.....
48159	8738	" " (No. 53 drill needle hole) for 48139.....
48160	8739	Throat Plate for 48140.....

Nos. 48512 TO 48520 FOR 52-76 MACHINE

48512	5417	Feed Dog.....
48513	5418	" "
48514	5419	" "
48515	7480	" "
48516	7481	" "
48517	7613	" "
48518	8744	" " (16 teeth to the inch).....
48519	8745	" " 11 teeth (16 teeth to the inch)
48520	8746	" " 11 teeth (16 teeth to the inch)
48527	7553	Presser Foot (hinged) for 52-76 Machine
48547	5417	Throat Plate (thin stock) for 48512.....
48548	5418	" " " " " 48513.....
48549	5419	" " " " " 48514.....
48550	7480	" " " " " 48515.....
48551	7481	" " " " " 48516.....
48552	7613	" " " " " 48517.....
48553	8744	" " " " " 48518.....
48554	8745	" " " " " 48519.....
48555	8746	" " " " " 48520.....
49092	7442	Arm Oil Tube Packing (felt) for 13831 and 13832.....
50014F	7445	Needle Set Screw, for $\frac{3}{4}$ in. gauge and above, for 13596 and 13892.....
50062J	7450	Thread Guide (top of arm) Screw.....
52016	7445	Presser Bar Lifter.....
54897	7442	Arm Oil Cup.....
56006	7442	" Shaft Flanged Bushing (back) Oil Pad (braided cotton).....
56006	7442	Arm Shaft Flanged Bushing (front) Oil Pad (braided cotton).....
56848	—	Bell Crank 5596 with 5599 and 5601, for 5598.....
56864	7463	Chain Hook (large) for 5670.....
56865	7463	" " (small) for 5670.....
120341	7458	Tweezers (curved) Accessories.....
200383c	7463	Thread Unwinder Spool Rest Rod Set Screw for 202490.....
201018c	7463	Thread Unwinder Spool Rest Set Screw for 225389 and 225395.....

NUMERICAL LIST OF PARTS

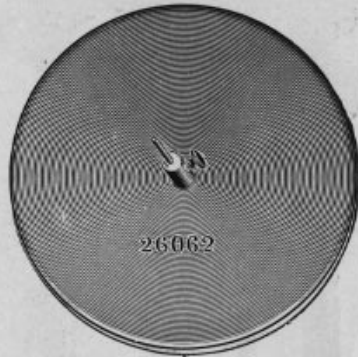
NO.	PLATE	NAME
201696J	7463	Thread Unwinder Thread Guide Lock Nut for 225397.....
202490	7165	Thread Unwinder Spool Stand with 200383c, for 225397.....
Nos. 225388 TO 225392 FOR 225397		
225388	7165	Thread Unwinder Spool Rest Rod.....
225389	7165	" " " " with 201018c, for one spool.....
225390	7234	Thread Unwinder Thread Cone Holder, for inverted cones.....
225391	7165	Thread Unwinder Thread Guide.....
225392	7165	" " " " Rod with 208E and 225393.....
225393	7463	Thread Unwinder Thread Guide Rod Washer for 225392.....
225395	7165	Thread Unwinder Spool Rest with 201018c, for 225397.....
225397	7165	Thread Unwinder complete, for three spools, Nos. 201696J, 202490, 225388, 225389, 225392, 225395, three each 225391 and wood screws $\frac{1}{8}$ in. No. 12..

Genuine Singer Needles and their Containers are marked with the Company's Trade Mark "SIMANCO." 1

Needles in Containers marked "For Singer Machines" are not Singer made needles. 2

PLATE 989—ONE-FOURTH SIZE

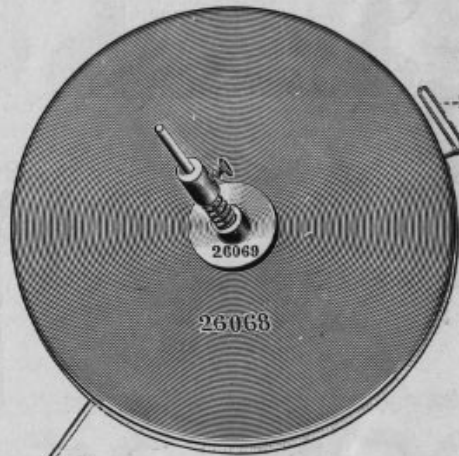
26063



26062

---26061

26074



---26072

26068

26068

---26066

PLATE 1511—ONE-FOURTH SIZE

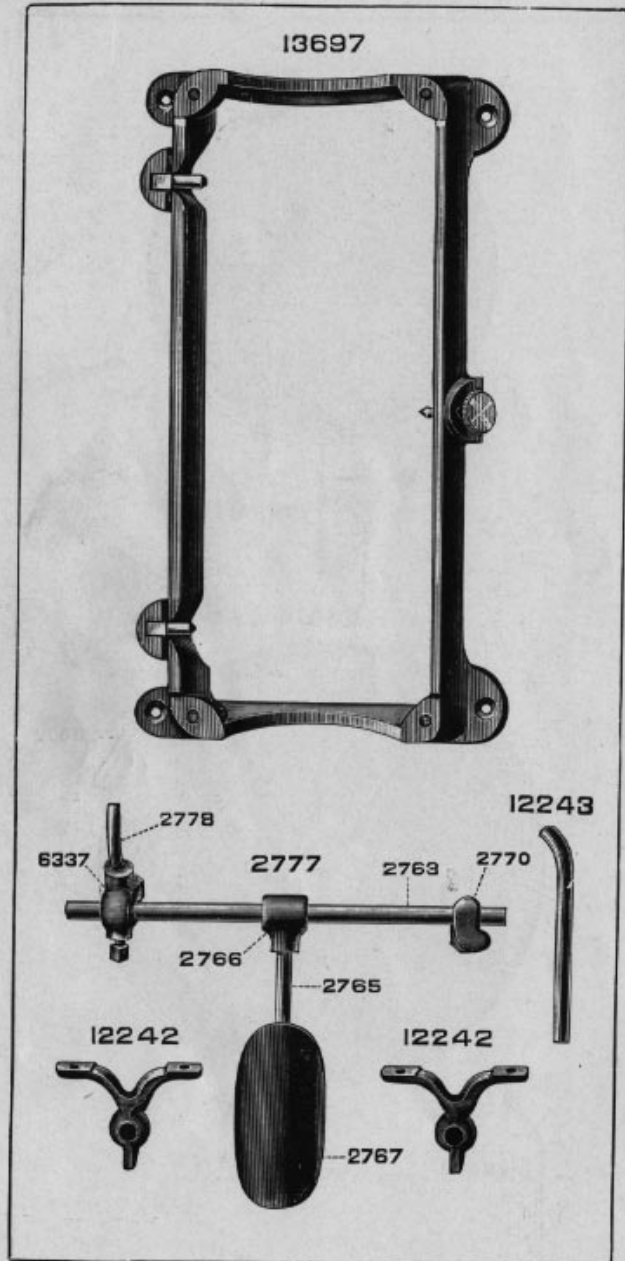


PLATE 1514—ONE-FOURTH SIZE

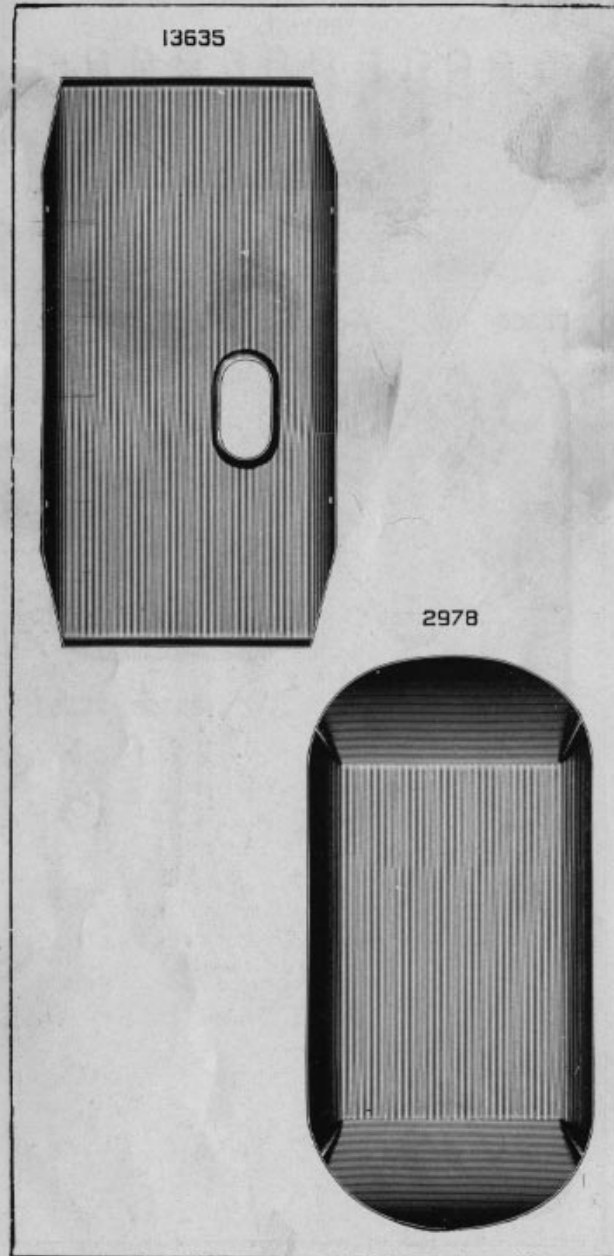


PLATE 1512—FULL SIZE

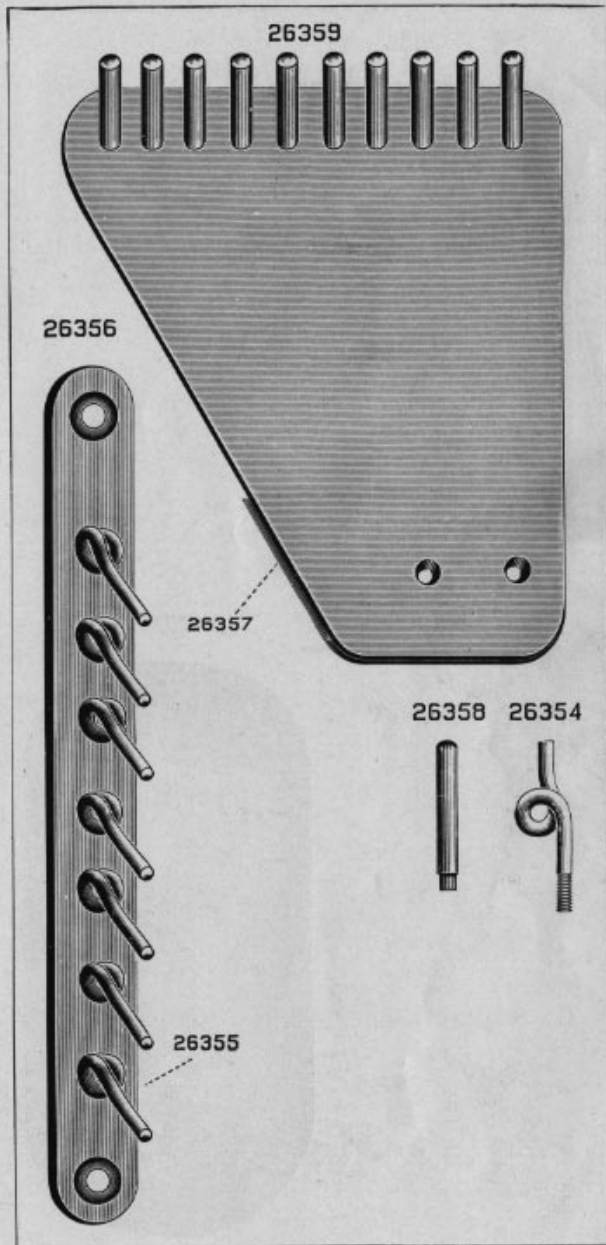


PLATE 1516—ONE-FOURTH SIZE

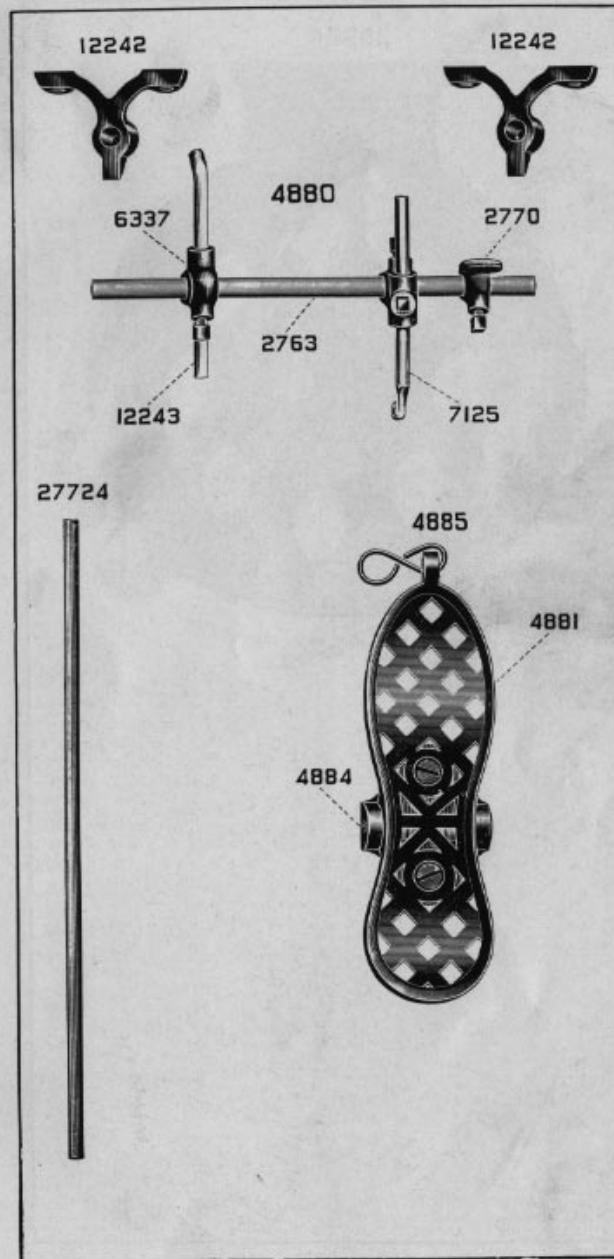


PLATE 2116—ONE-HALF SIZE

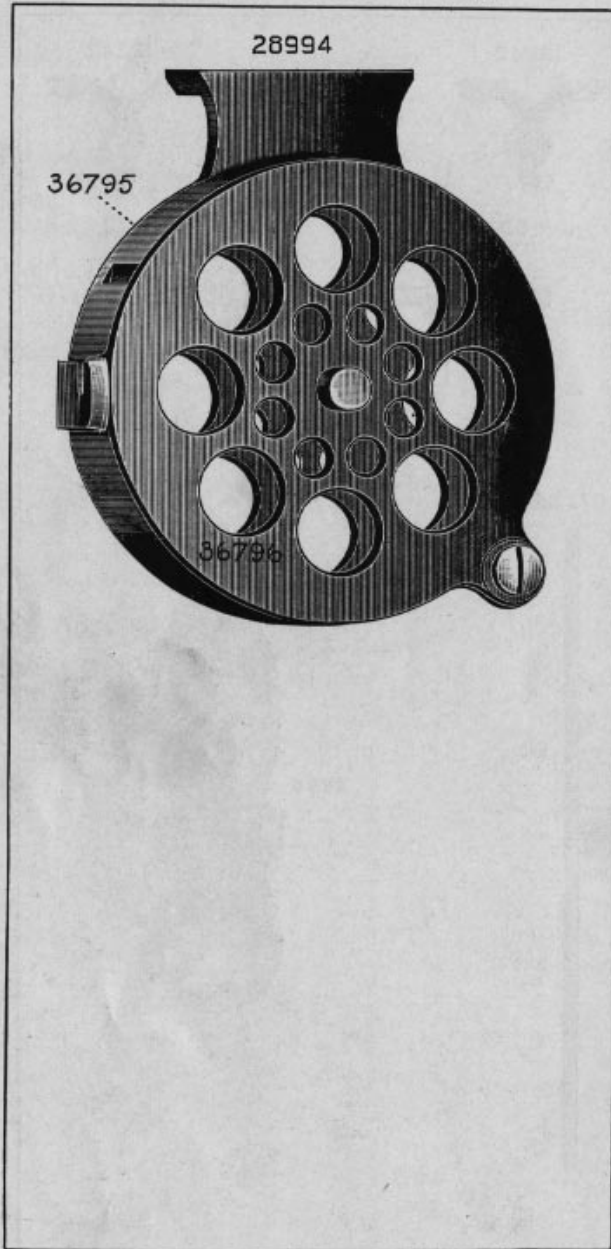


PLATE 2642—FULL SIZE

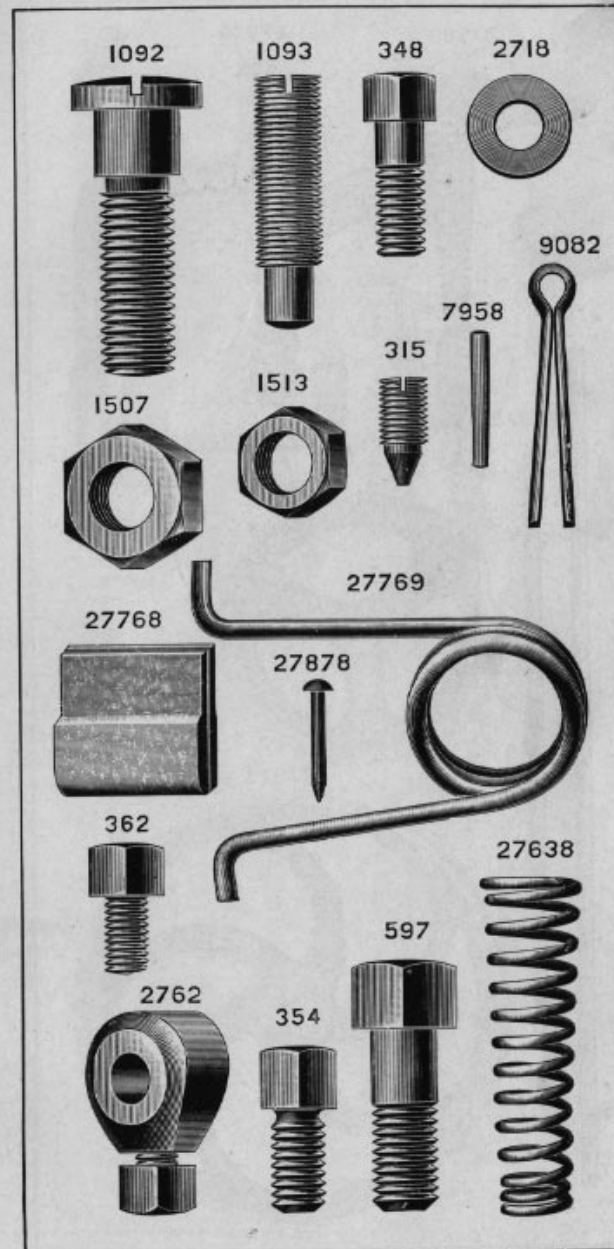


PLATE 2829—ONE-FOURTH SIZE

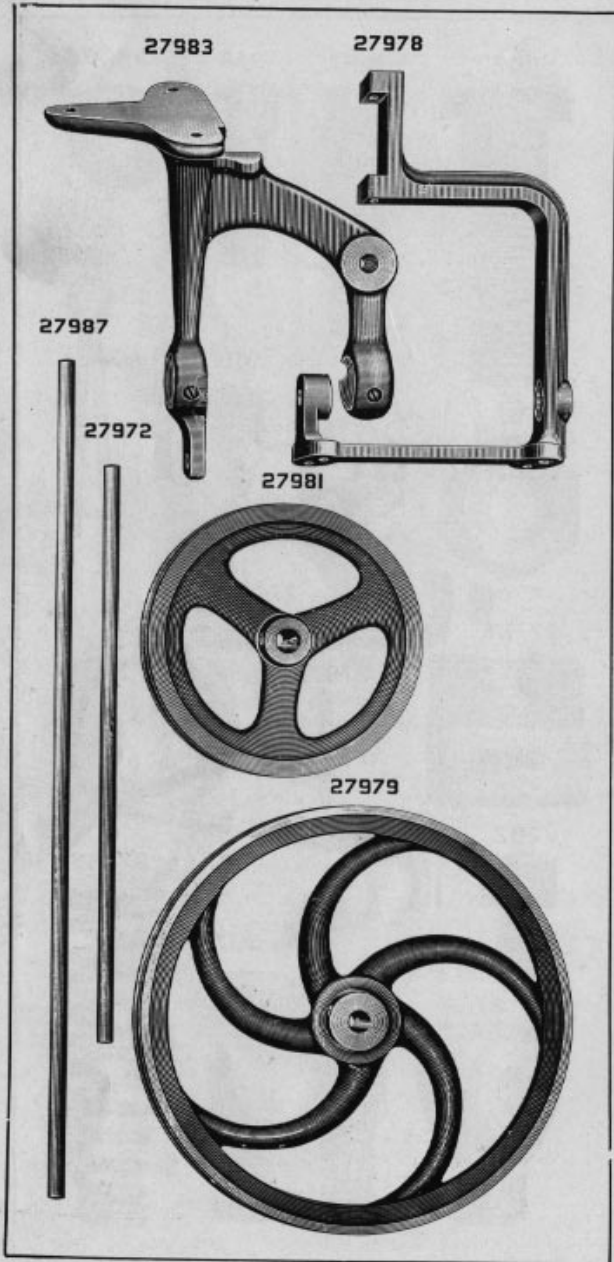


PLATE 2830—ONE-HALF SIZE

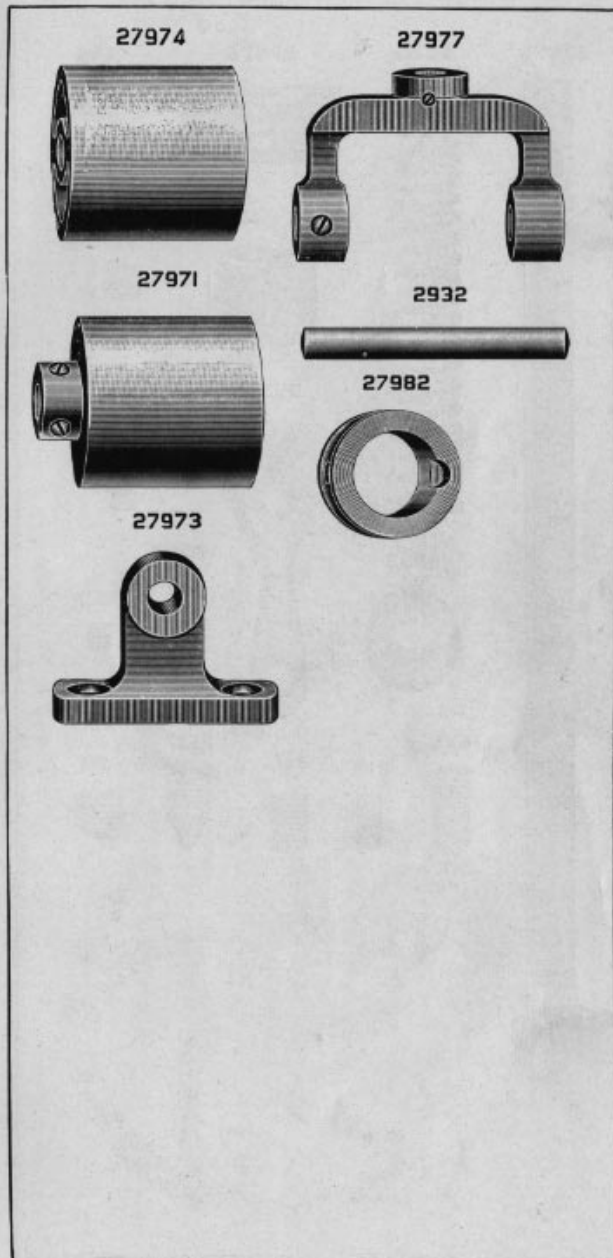


PLATE 2831—FULL SIZE

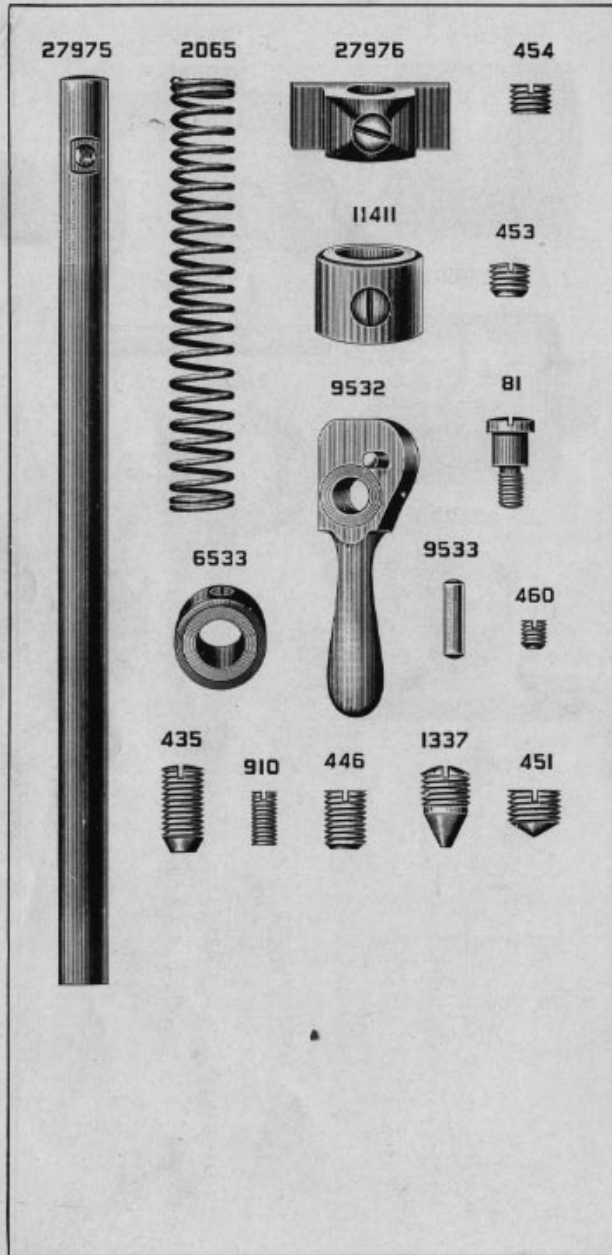


PLATE 3039—FULL SIZE

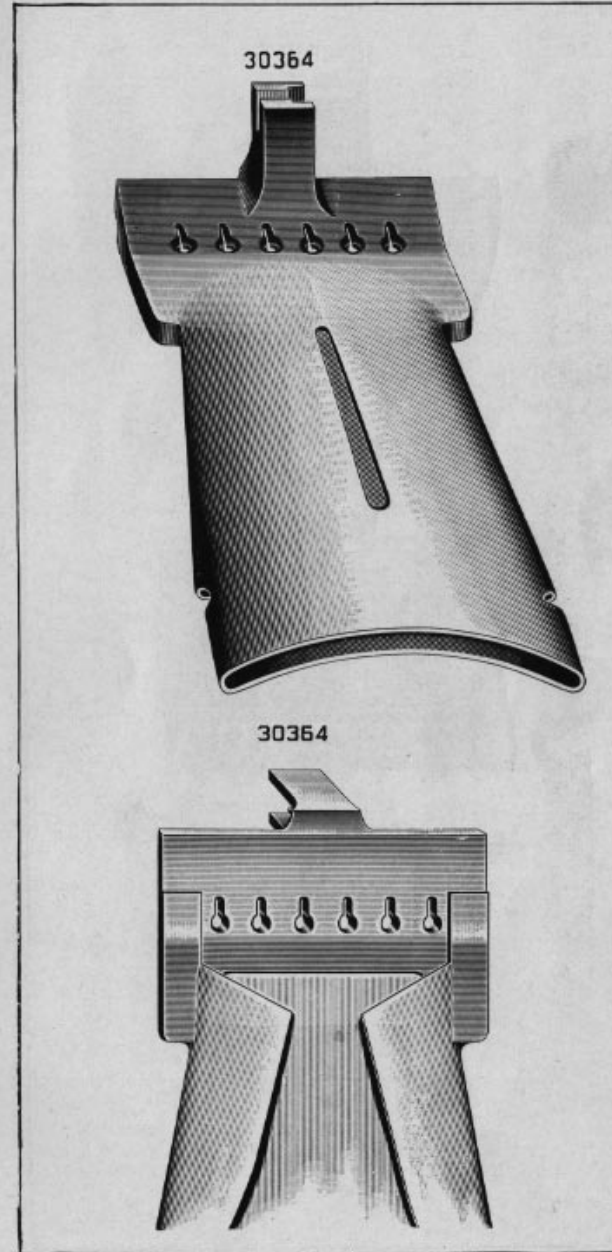


PLATE 3040—FULL SIZE

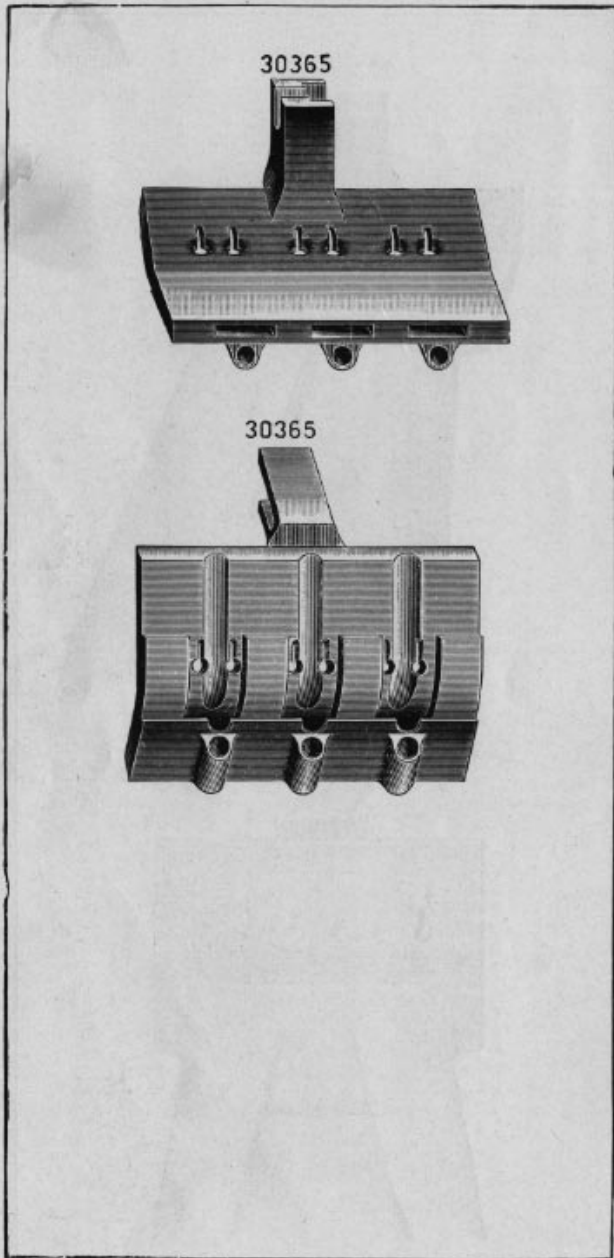


PLATE 3041—FULL SIZE

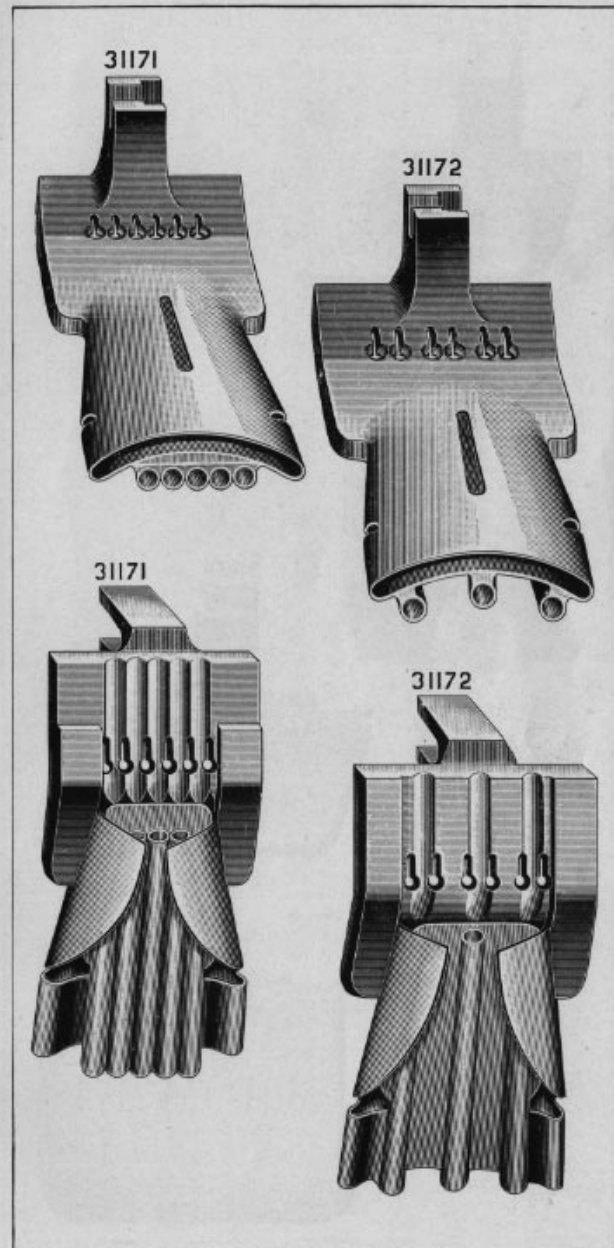


PLATE 3042—FULL SIZE

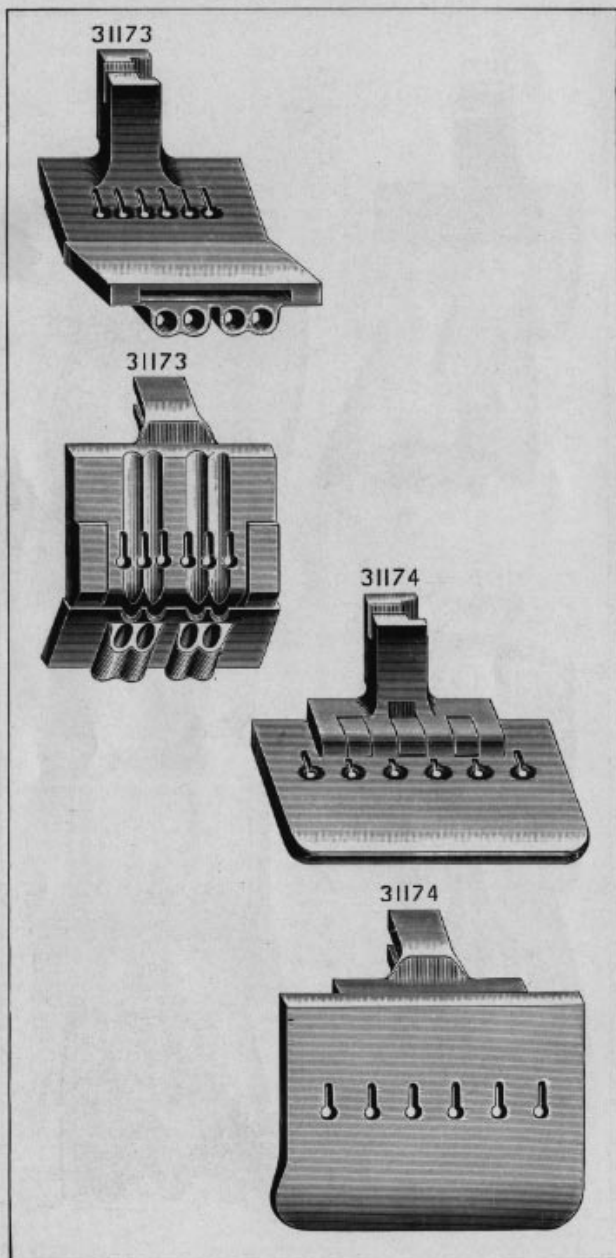


PLATE 3043—FULL SIZE

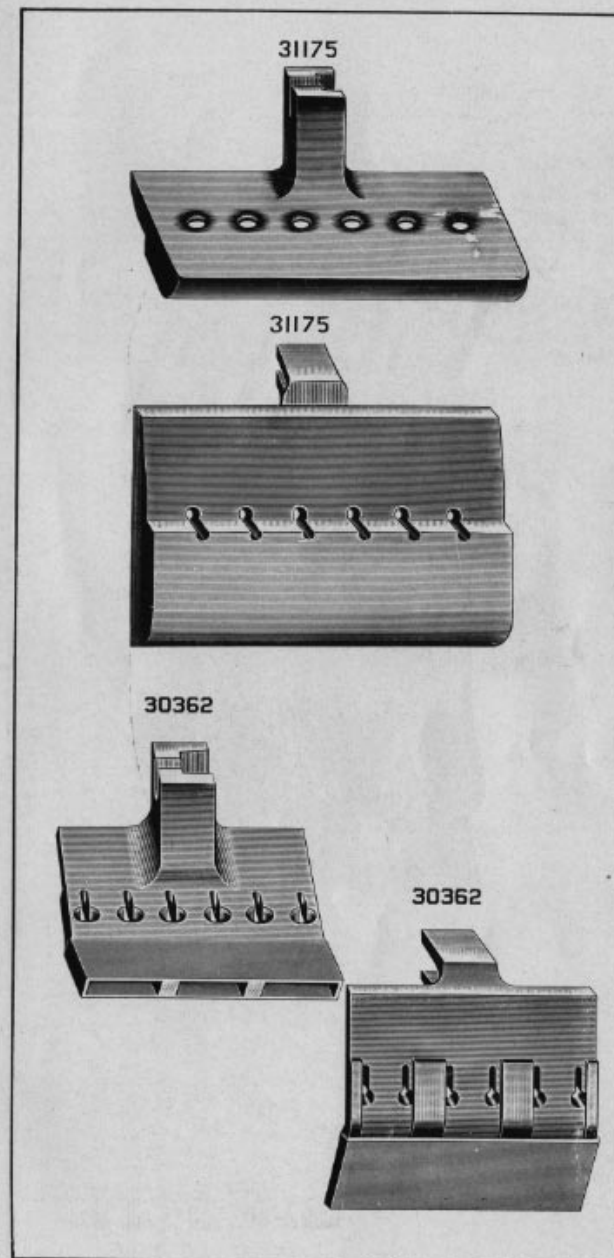


PLATE 3044—FULL SIZE

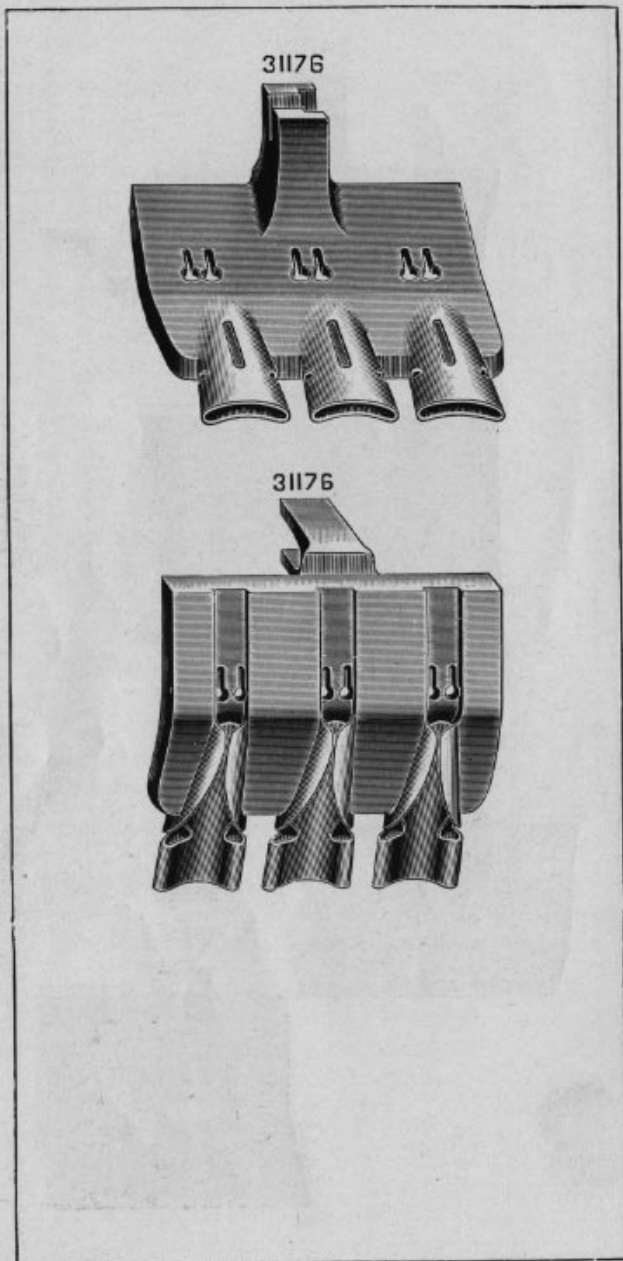


PLATE 3045—FULL SIZE

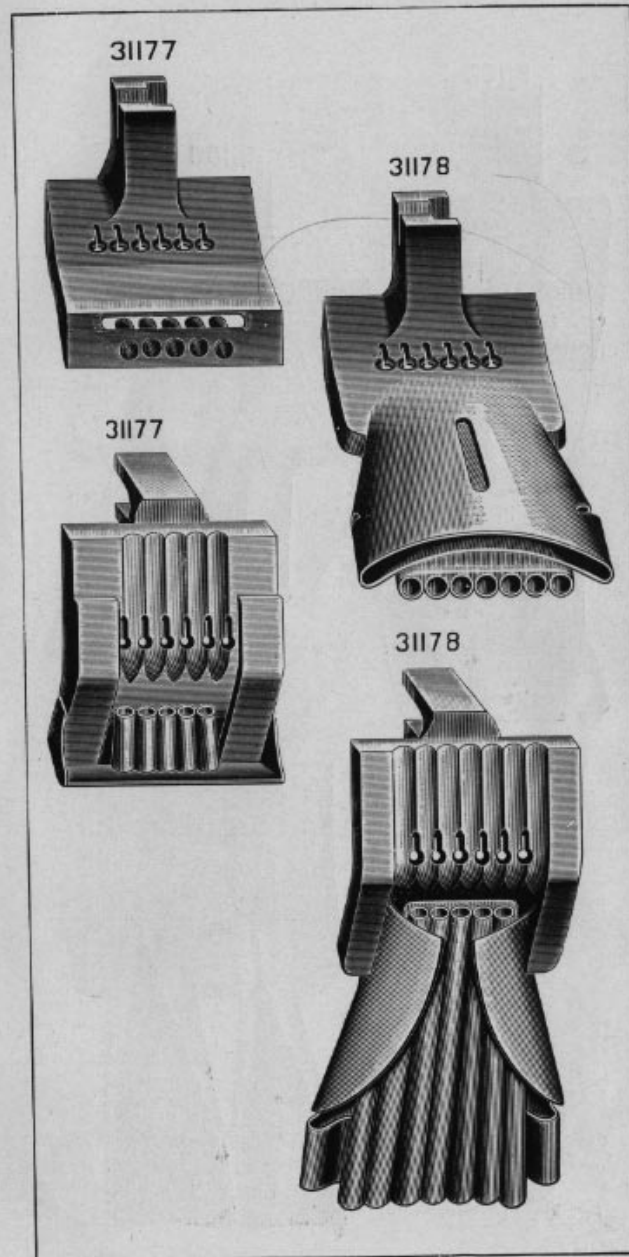


PLATE 3099—FULL SIZE

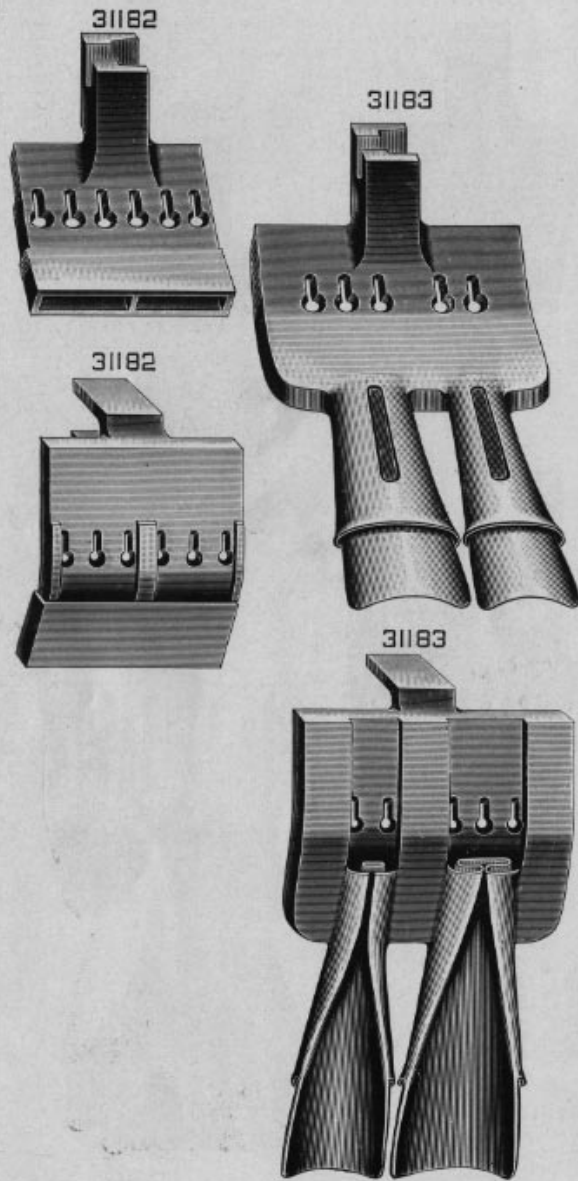


PLATE 3126—FULL SIZE

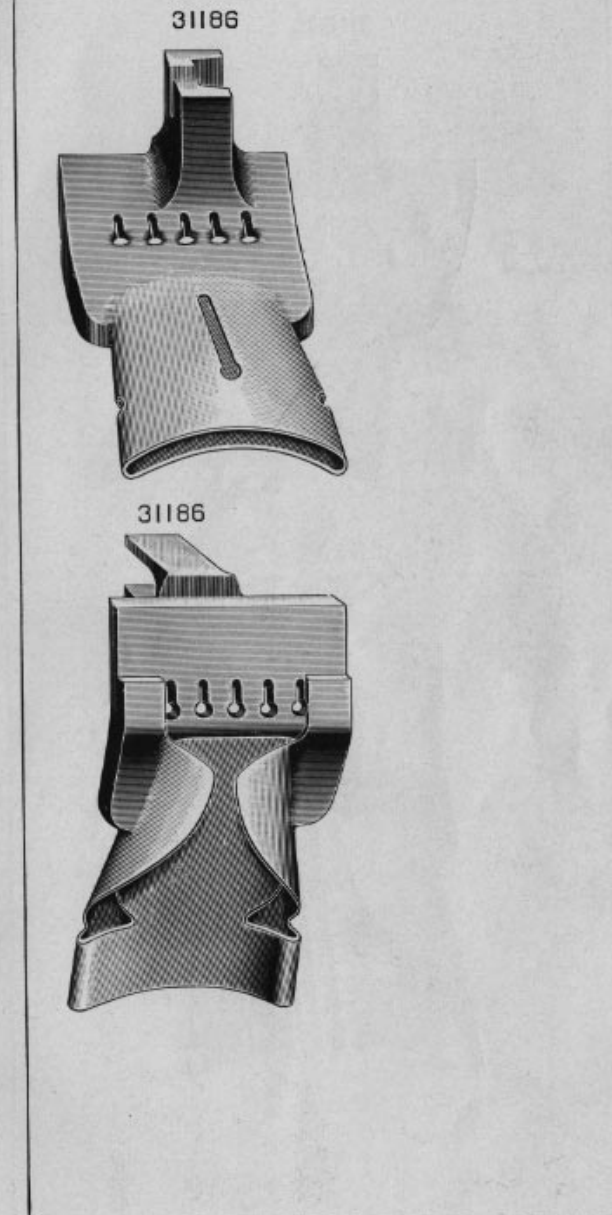
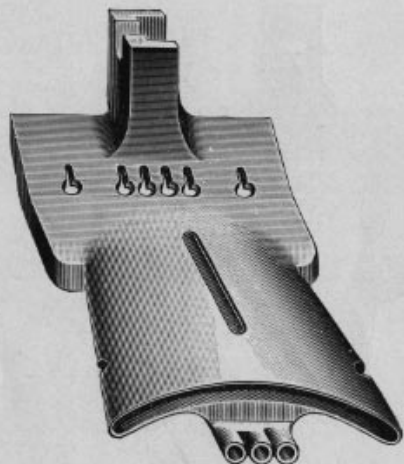


PLATE 4645—FULL SIZE

31189



31189

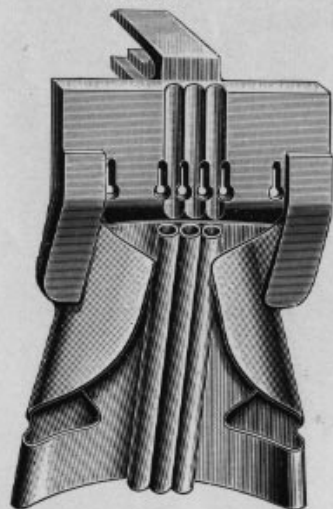
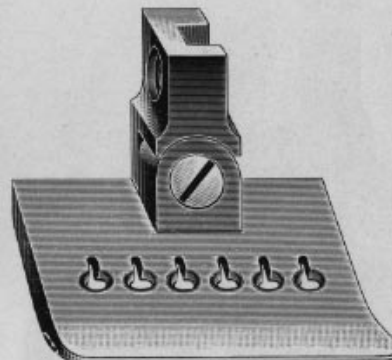


PLATE 4646—FULL SIZE

31190



31190

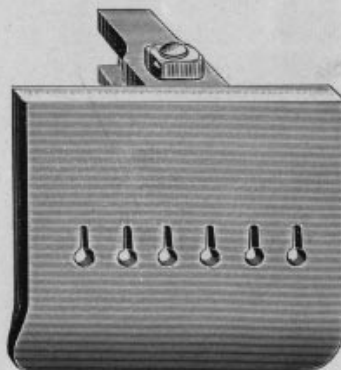
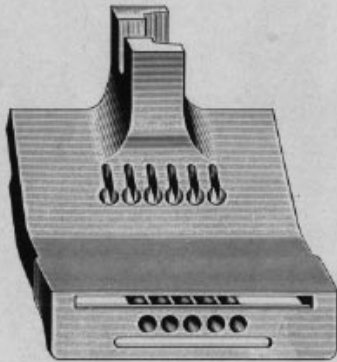


PLATE 4656—FULL SIZE

30357



30357

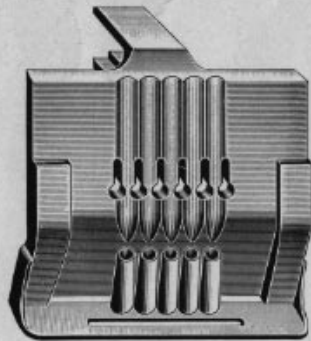
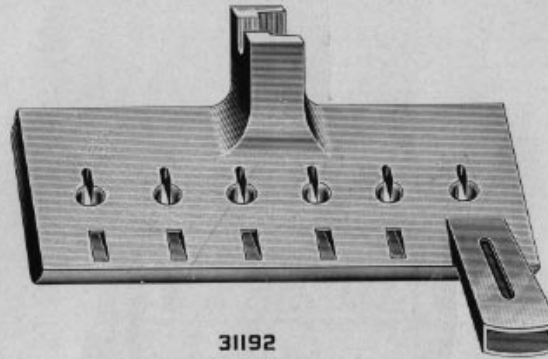


PLATE 4666—FULL SIZE

31192



31192

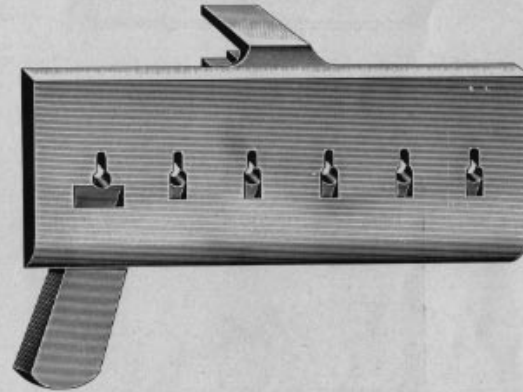


PLATE 4667—FULL SIZE

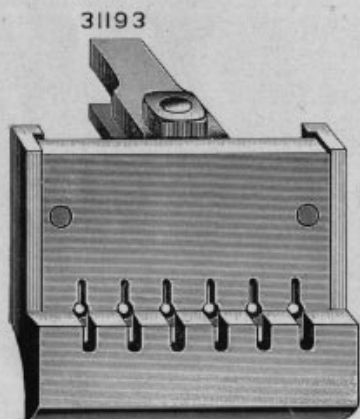
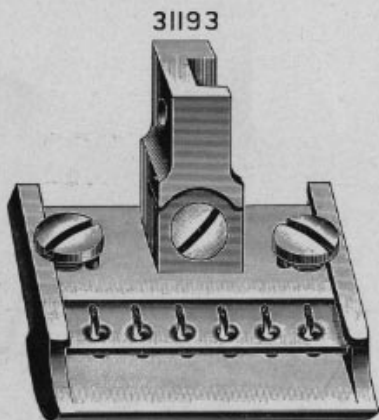


PLATE 4668—FULL SIZE

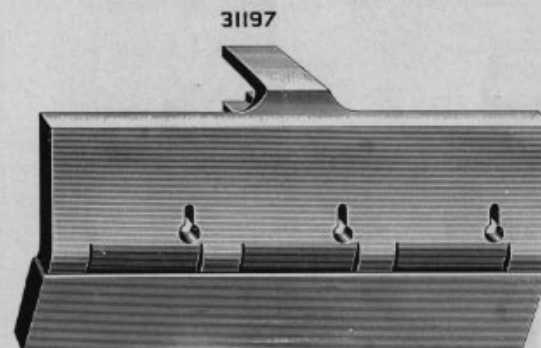
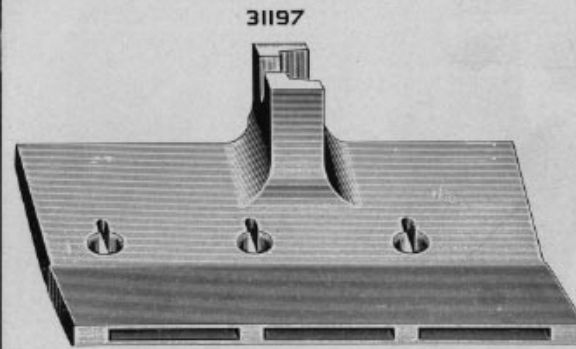
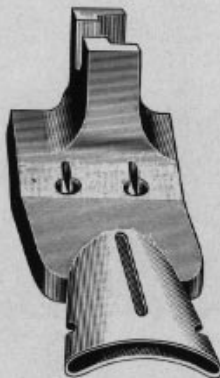
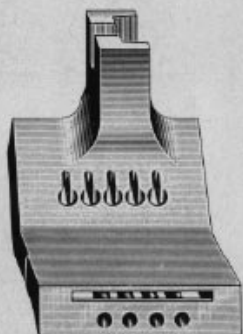


PLATE 4678—FULL SIZE

30361



31195



30361



31195

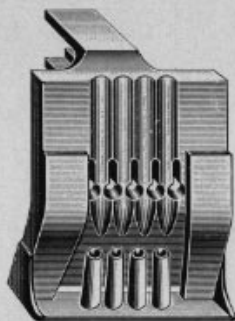
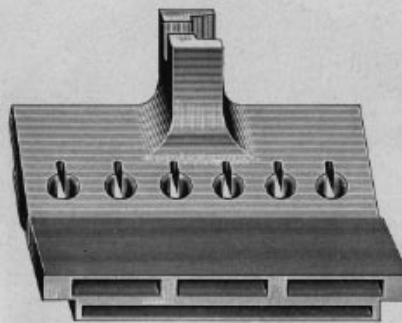


PLATE 4689—FULL SIZE

30363



30363

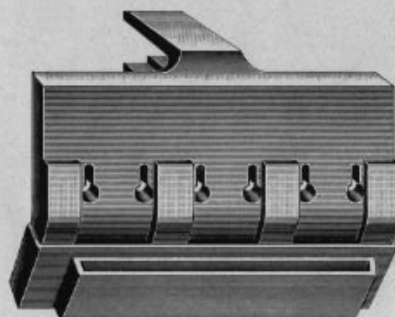
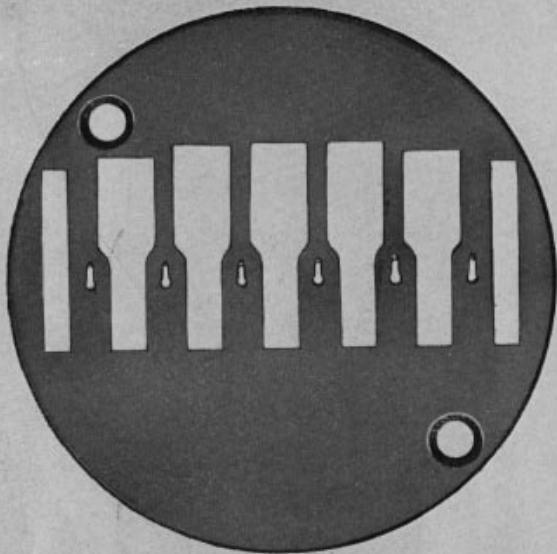


PLATE 5410—FULL SIZE

48142



48122

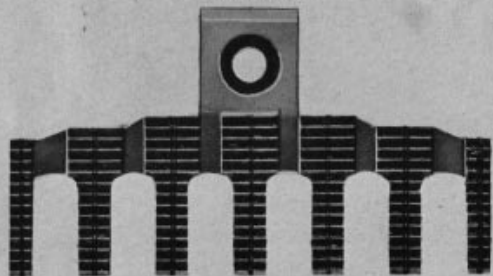
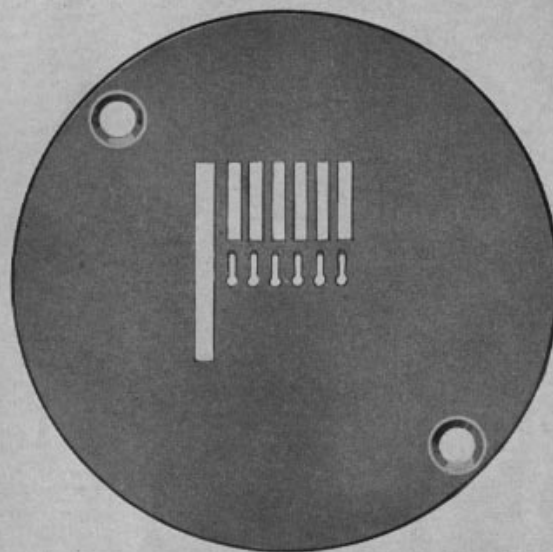


PLATE 5411—FULL SIZE

48143



48123

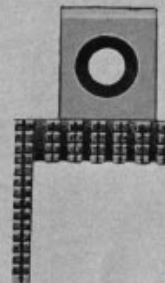
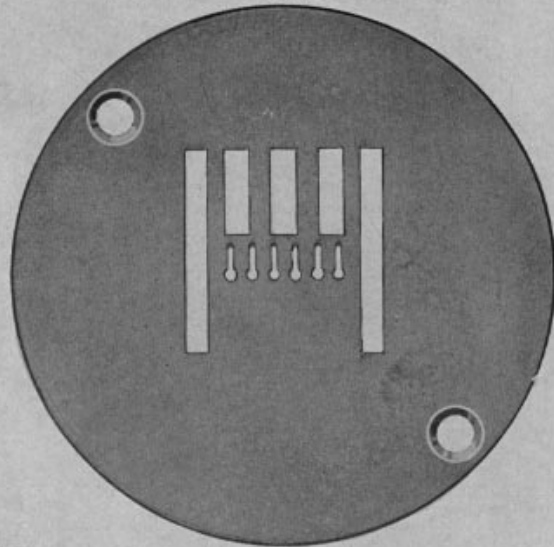


PLATE 5412—FULL SIZE

48144



48124

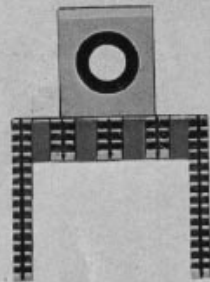
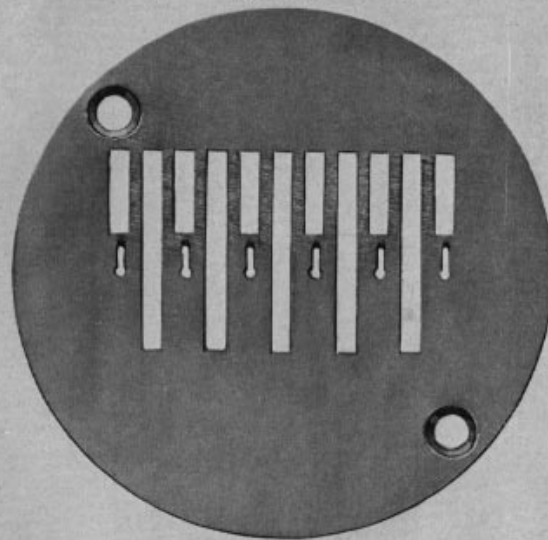
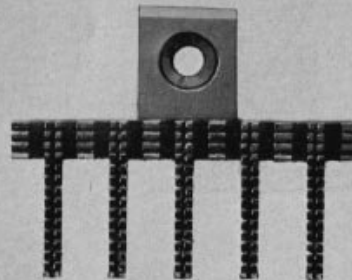


PLATE 5413—FULL SIZE

48145



48125



48138

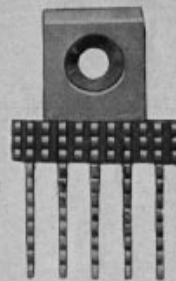
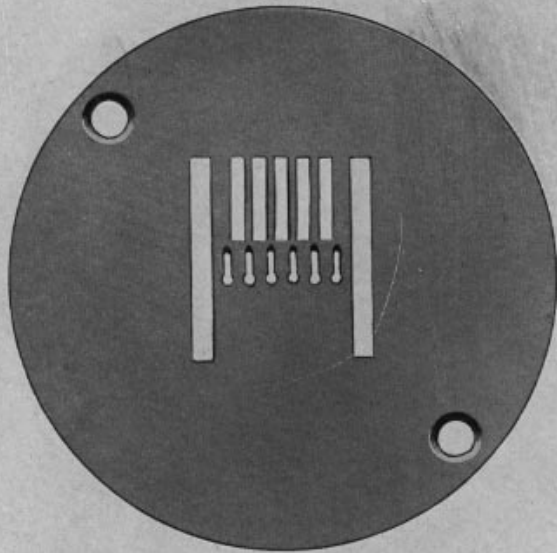


PLATE 5414—FULL SIZE

48146



48126

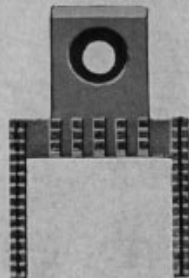
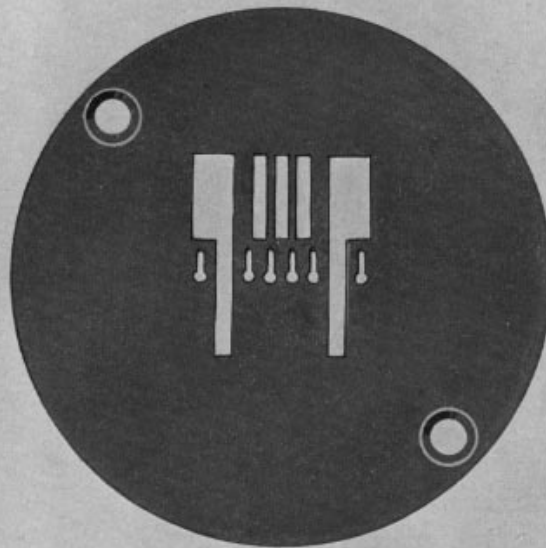


PLATE 5415—FULL SIZE

48147



48127

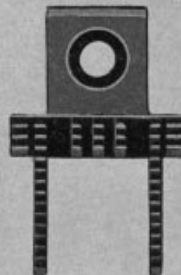
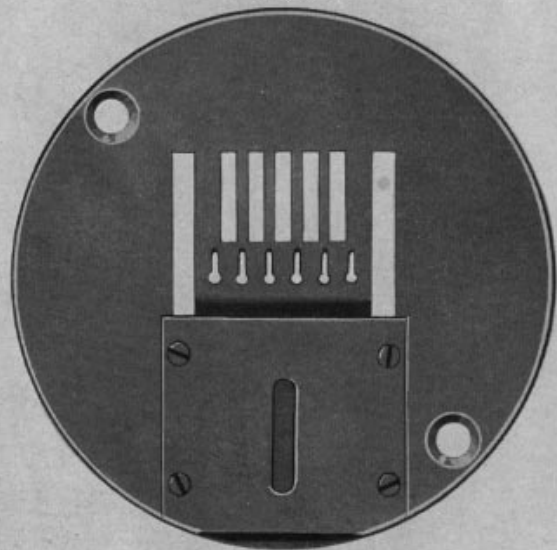


PLATE 5416—FULL SIZE

48148



48128

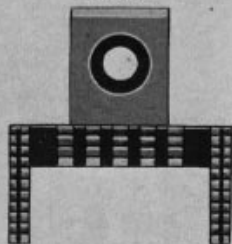
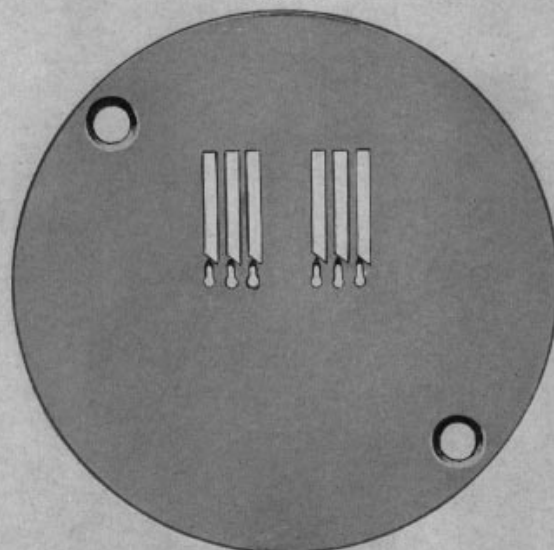


PLATE 5417—FULL SIZE

48547



48512

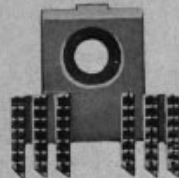
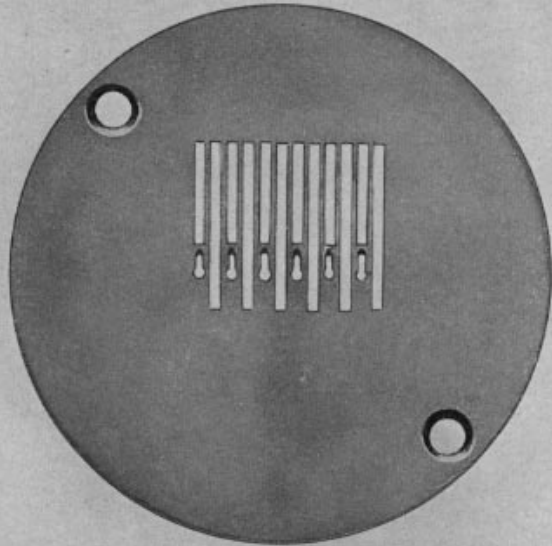


PLATE 5418—FULL SIZE

48548



48513

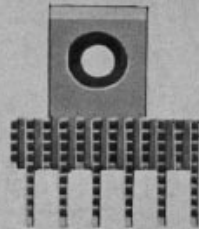
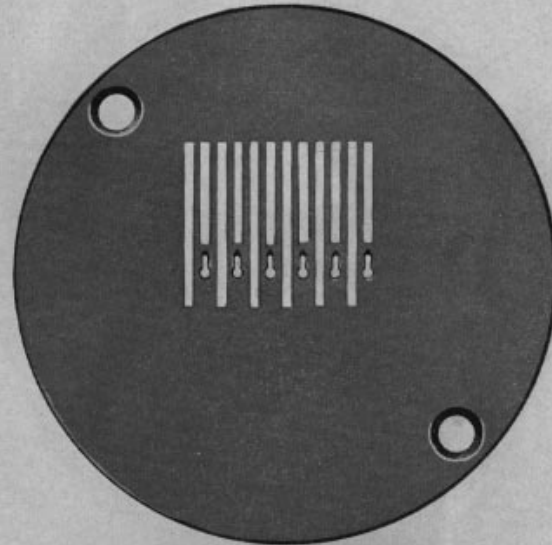


PLATE 5419—FULL SIZE

48549



48514

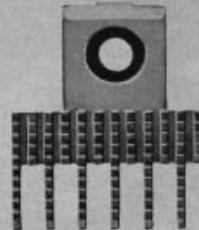
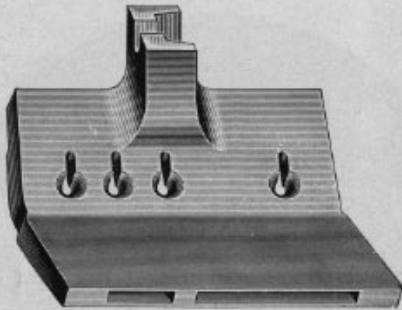


PLATE 5420—FULL SIZE

31198



31198

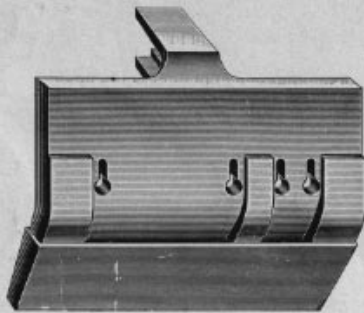
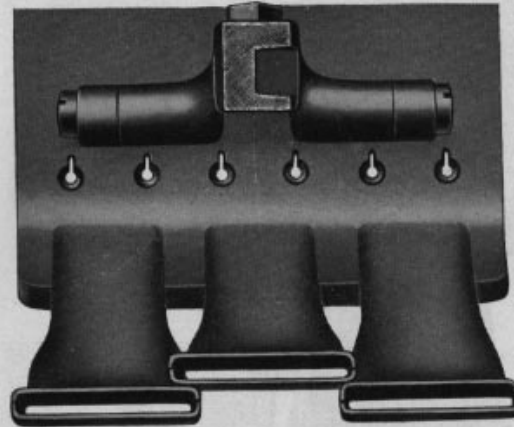


PLATE 5432—FULL SIZE

31199



31199

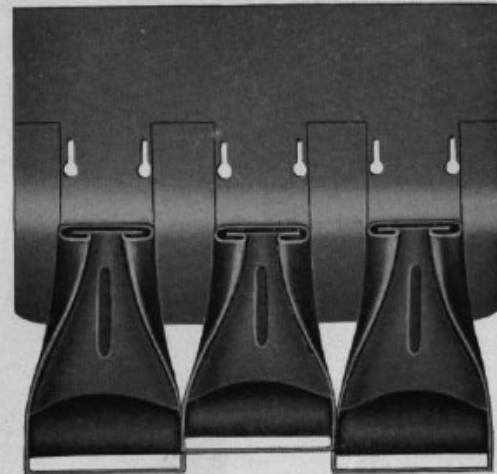
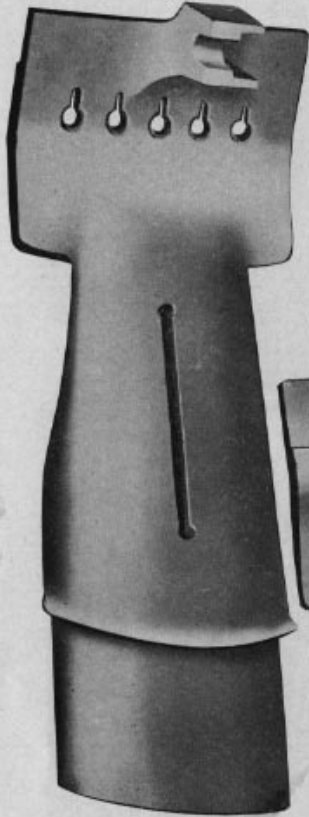


PLATE 5448—FULL SIZE

31200



31200

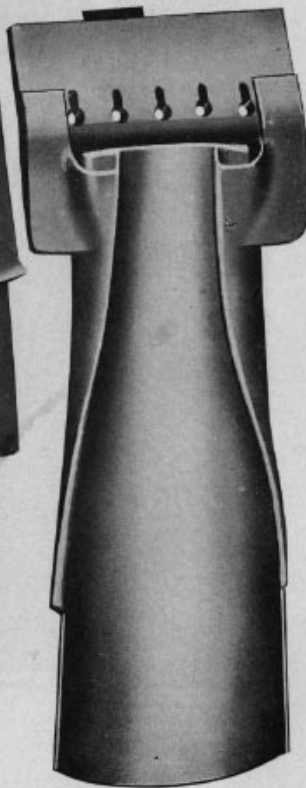
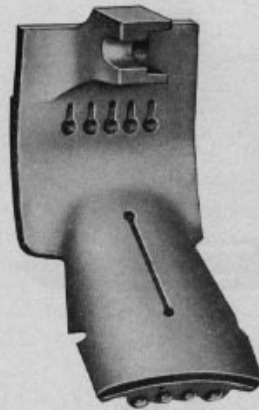


PLATE 5454—FULL SIZE

47289



47289

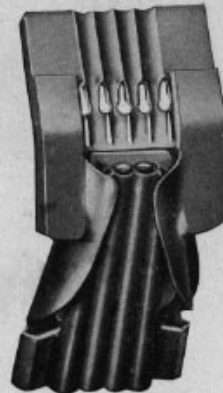
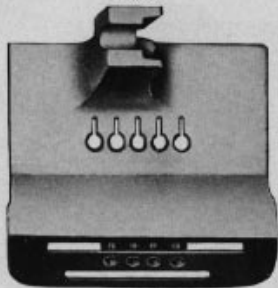


PLATE 5455—FULL SIZE

47290



47290

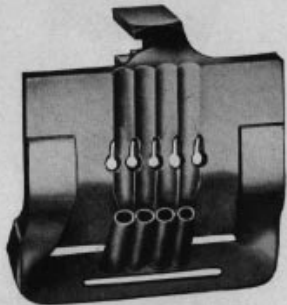
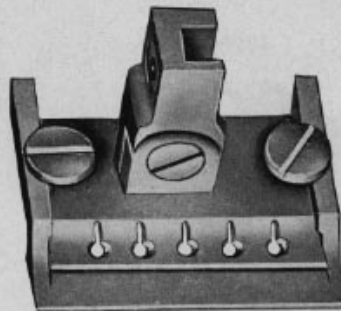


PLATE 5456—FULL SIZE

47291



47291

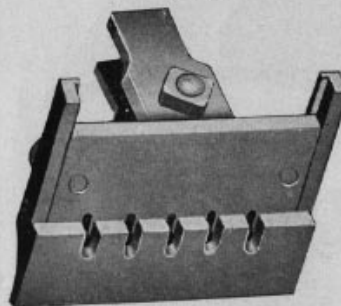


PLATE 5463—FULL SIZE

47292

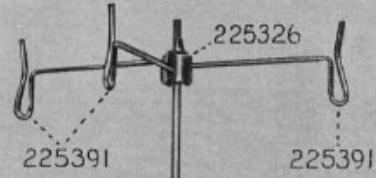


47292

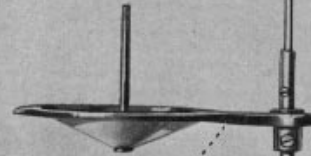


PLATE 7165—ONE-FOURTH SIZE

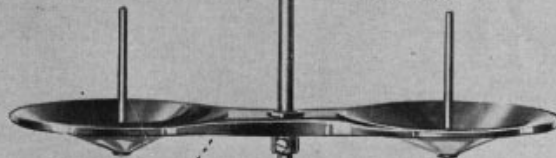
225397



225324



225388



202490



PLATE 7234—ONE-HALF SIZE

27739



225390

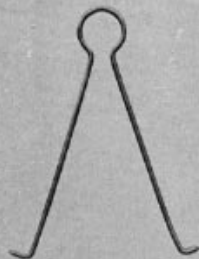
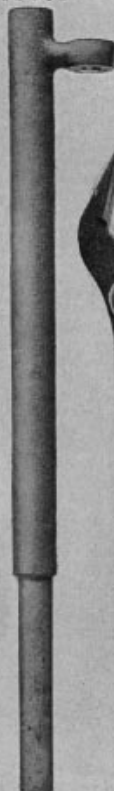


PLATE 7440—ONE-HALF SIZE

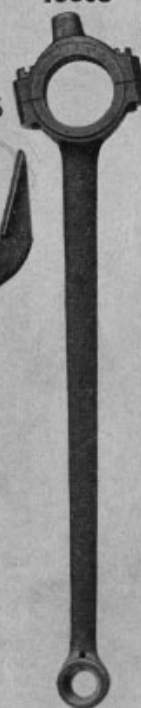
13793



13806



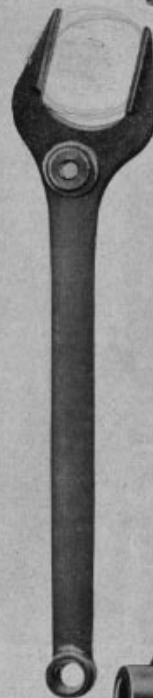
13808



2047



13805



13795



13816



13794



PLATE 7441—ONE-HALF SIZE

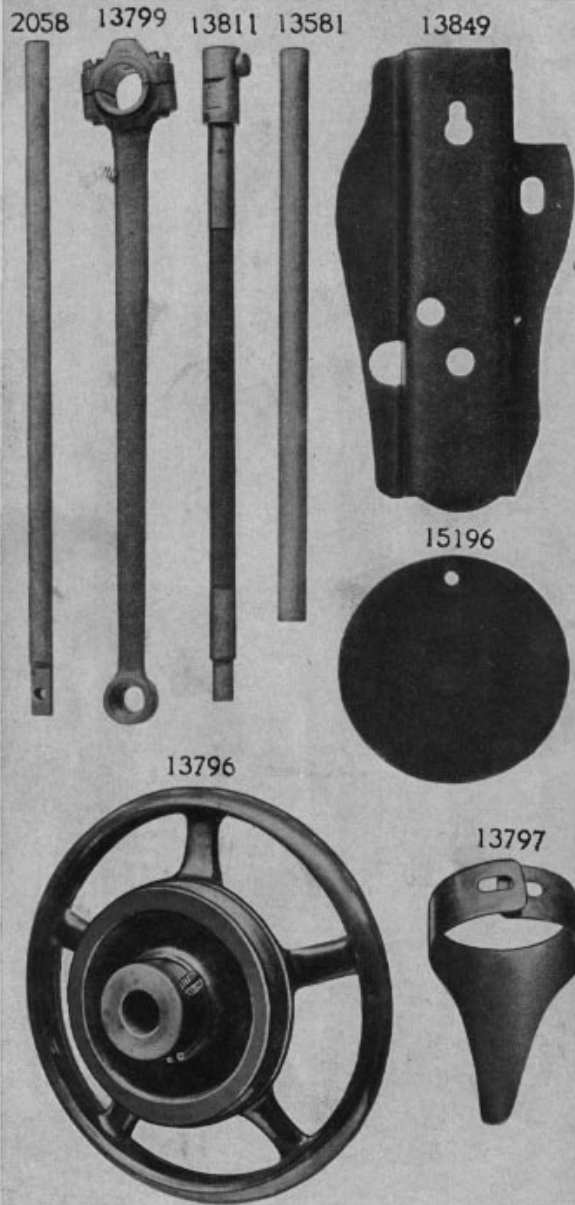


PLATE 7442—FULL SIZE

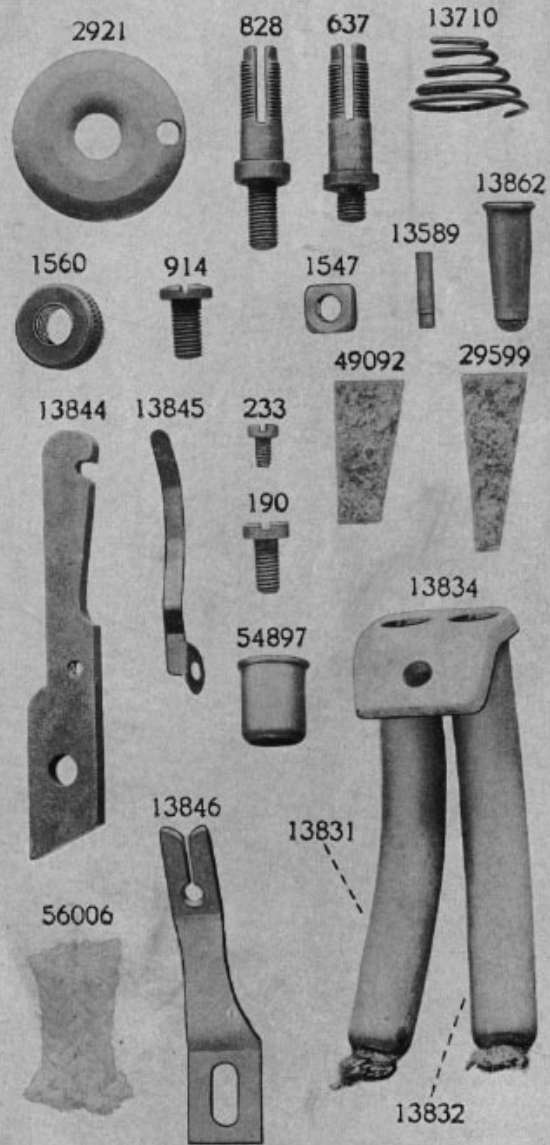


PLATE 7447—ONE-HALF SIZE

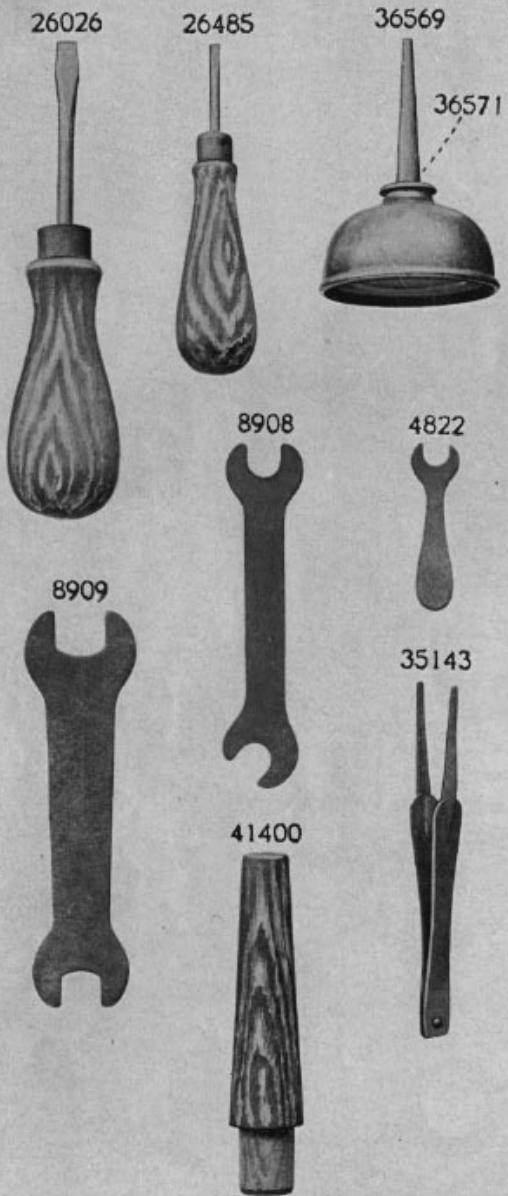


PLATE 7448—ONE-HALF SIZE

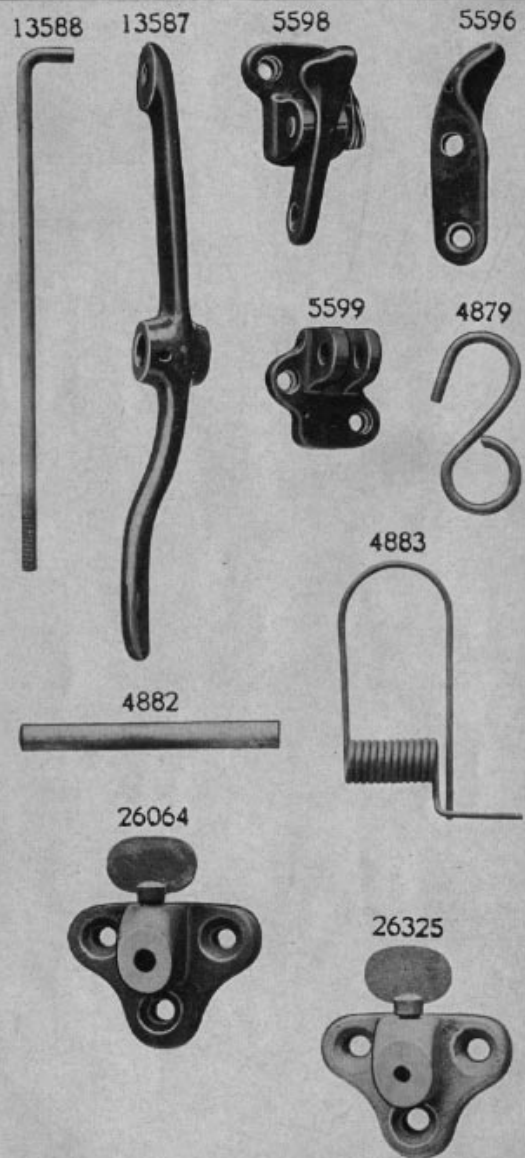


PLATE 7449—FULL SIZE

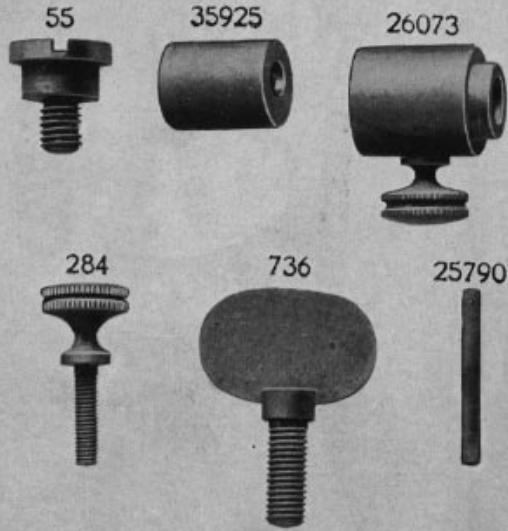


PLATE 7450—FULL SIZE

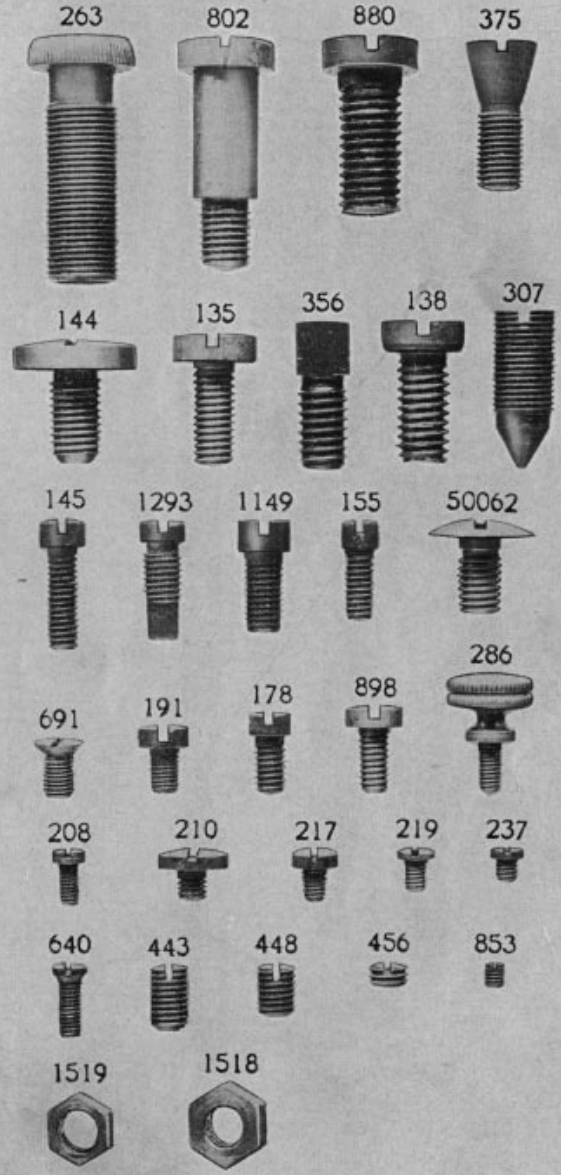


PLATE 7458—ONE-HALF SIZE

13801



13928



13835



120341



PLATE 7462—ONE-HALF SIZE

13840

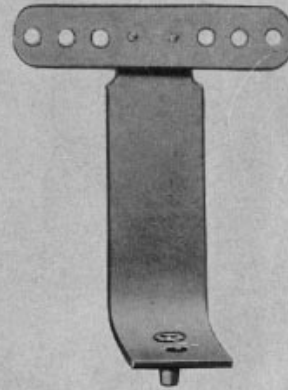


PLATE 7463—FULL SIZE

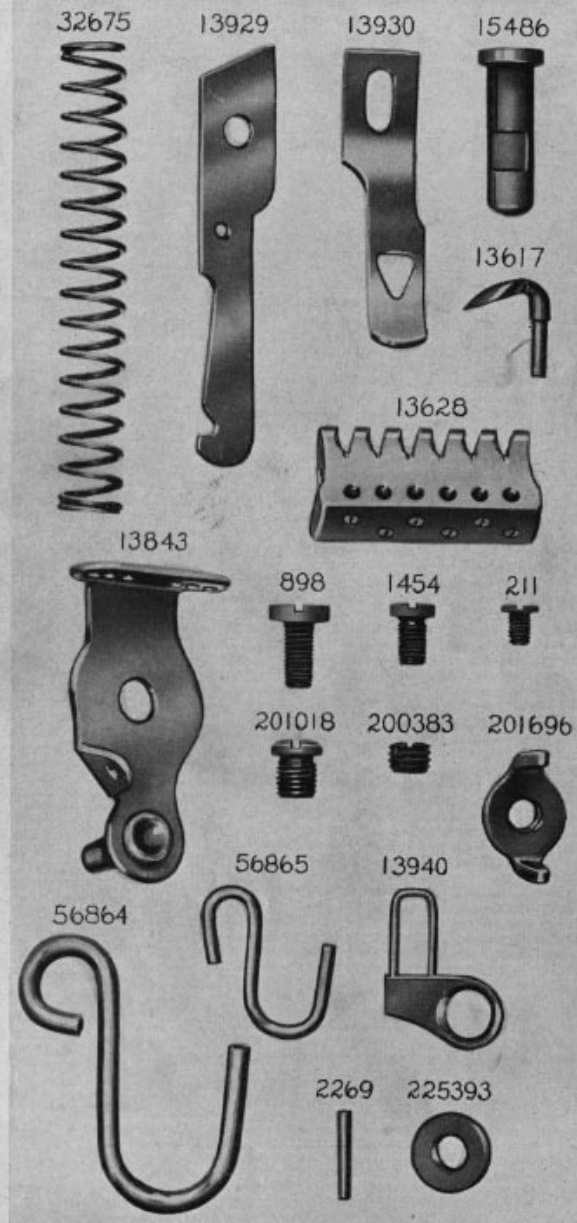


PLATE 7464—ONE-HALF SIZE

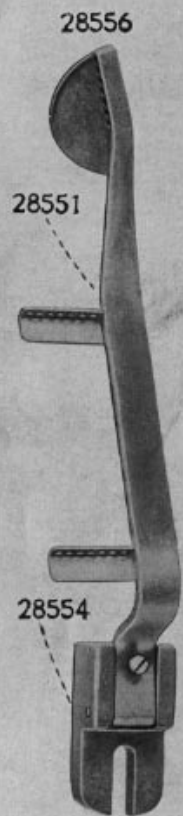
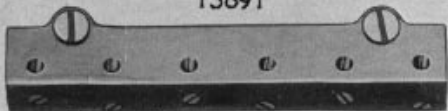
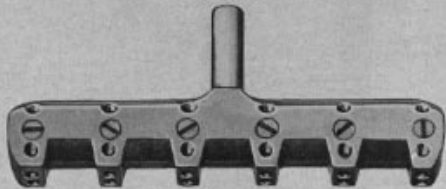


PLATE 7465—FULL SIZE

13891



13892



13895



13596

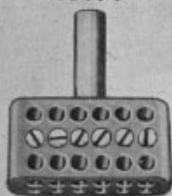


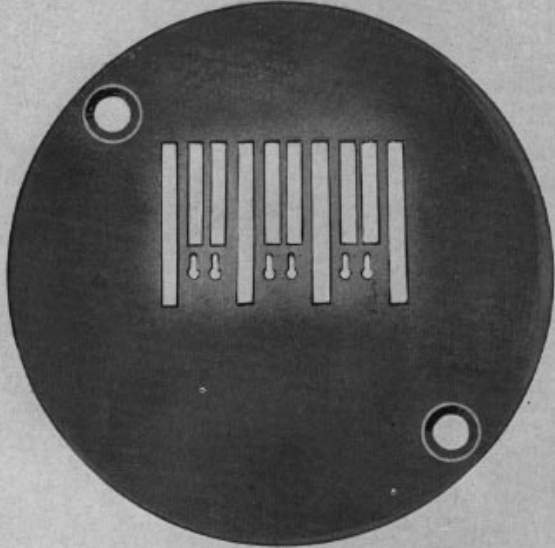
PLATE 7466—ONE-HALF SIZE

13893



PLATE 7480—FULL SIZE

48550



48515

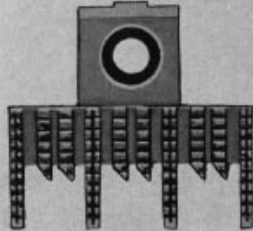
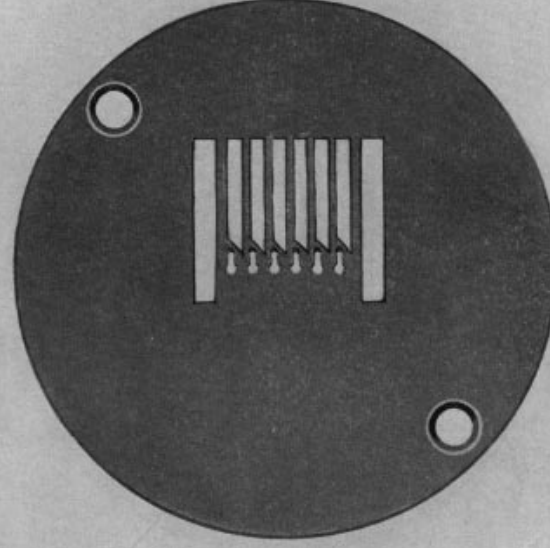


PLATE 7481—FULL SIZE

48551



48516

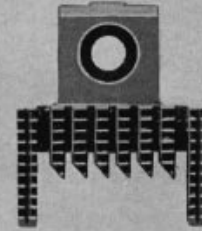
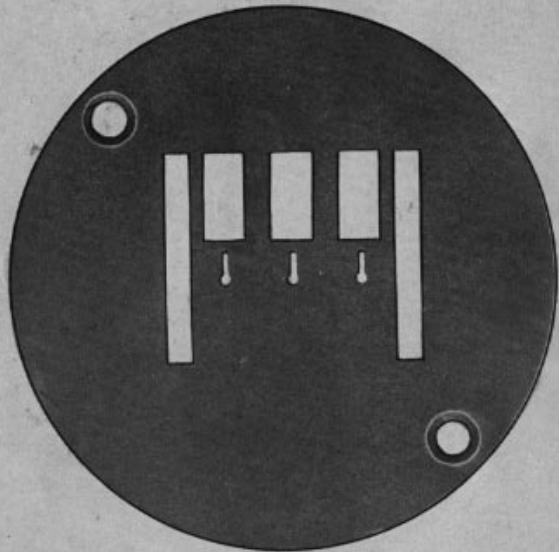


PLATE 7502—FULL SIZE

48149



48129

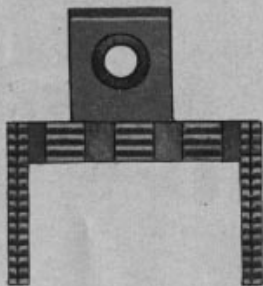
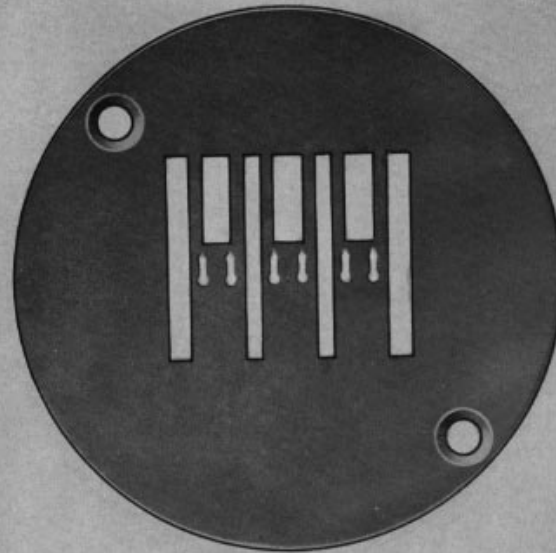


PLATE 7503—FULL SIZE

48150



48130

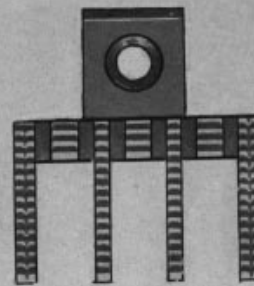
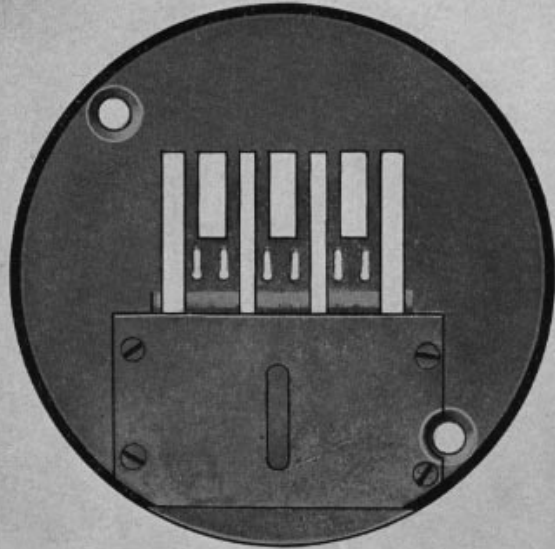


PLATE 7504—FULL SIZE

48151



48131

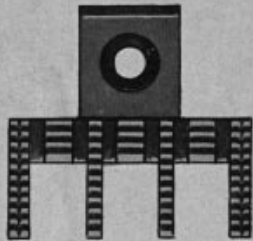
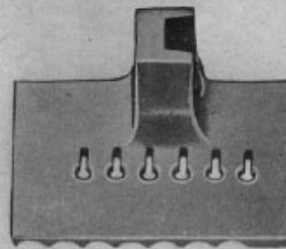
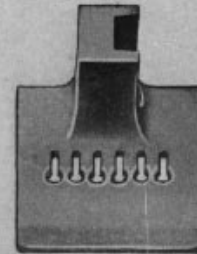


PLATE 7543—FULL SIZE

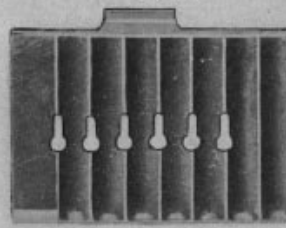
26212



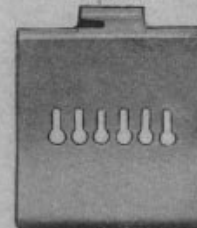
30358



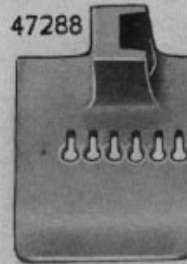
26212



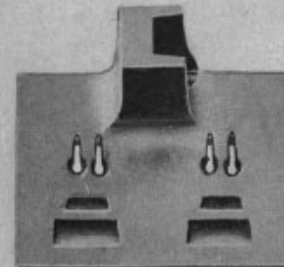
30358



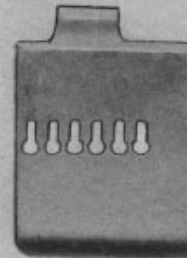
47288



47302



47288



47302

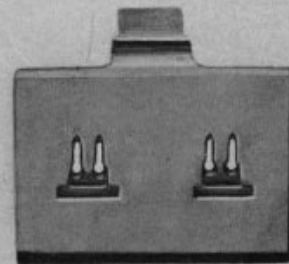


PLATE 7544-FULL SIZE

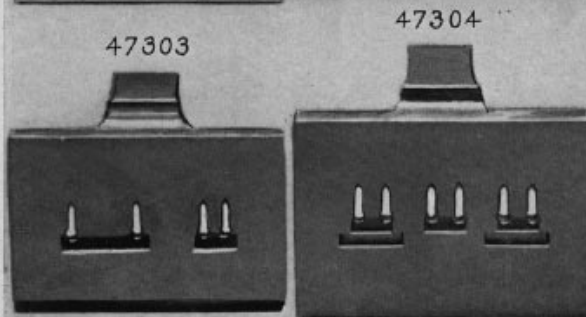
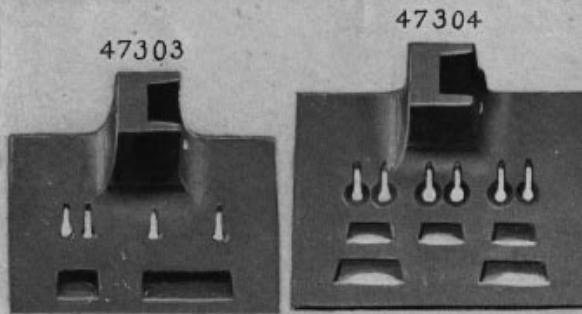
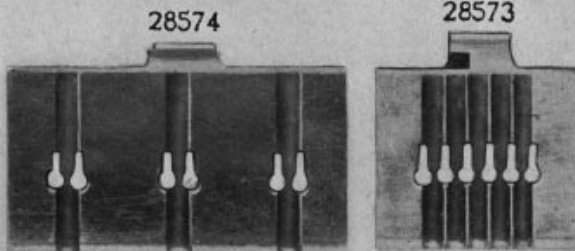
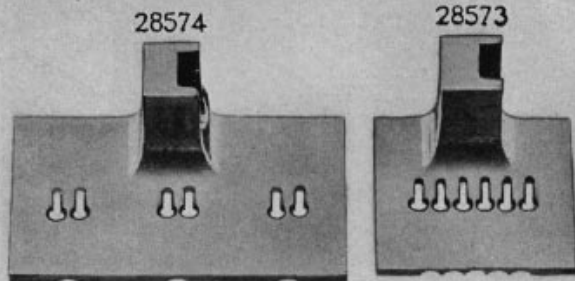


PLATE 7545-FULL SIZE

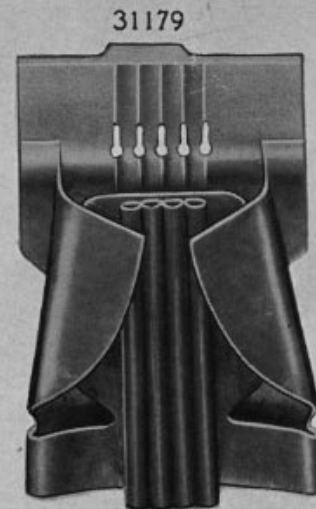
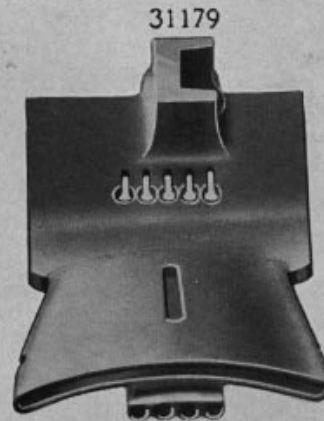
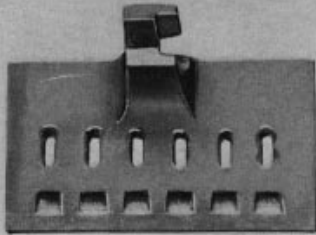
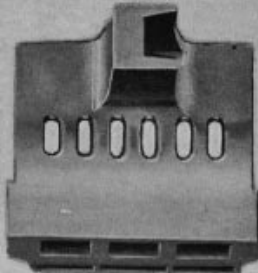


PLATE 7546—FULL SIZE

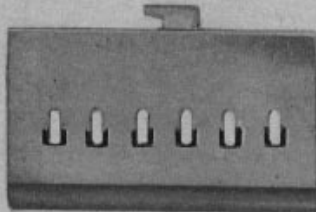
30359



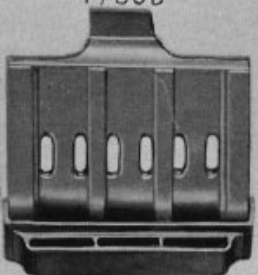
47305



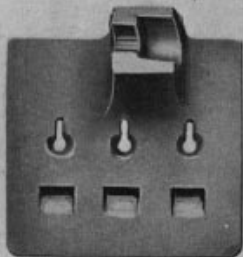
30359



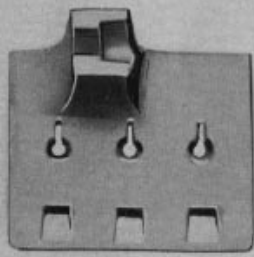
47305



31185



47299



31185



47299

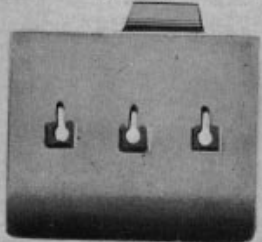
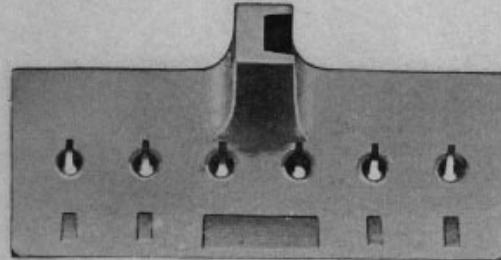
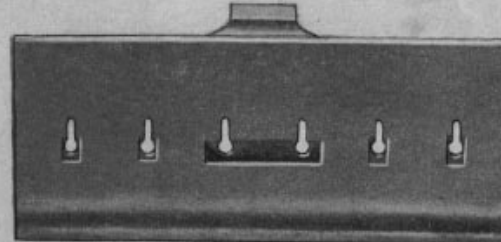


PLATE 7547—FULL SIZE

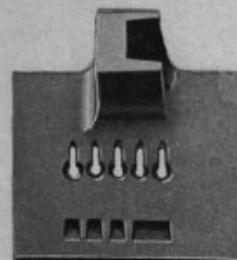
31191



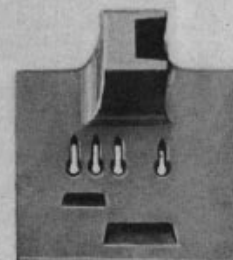
31191



47306



47307



47306



47307

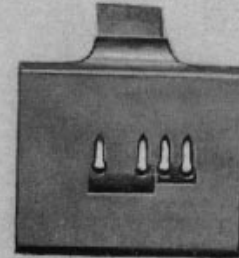
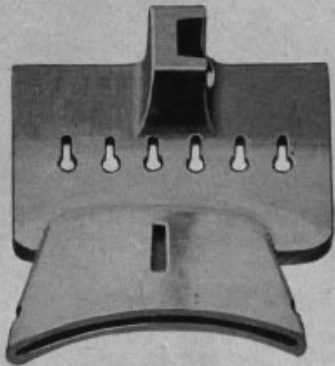


PLATE 7548—FULL SIZE

31184



31184

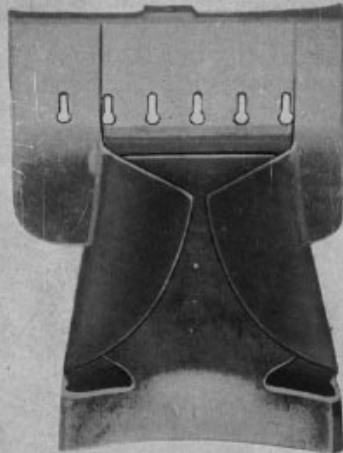
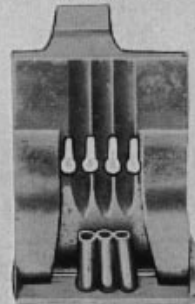


PLATE 7549—FULL SIZE

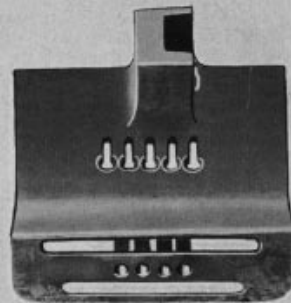
31196



31196



31180



31180

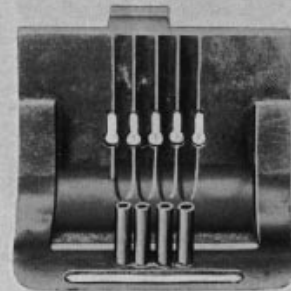
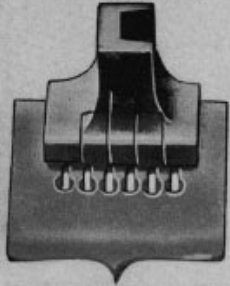
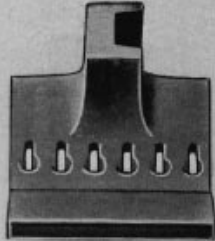


PLATE 7550—FULL SIZE

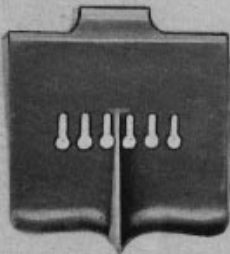
47294



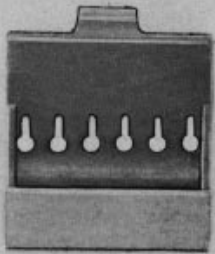
30360



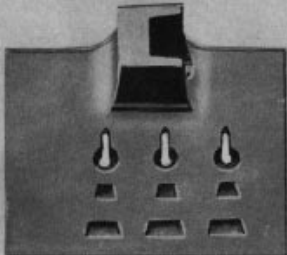
47294



30360



47311



47311

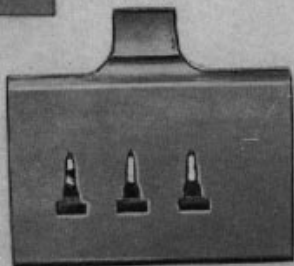
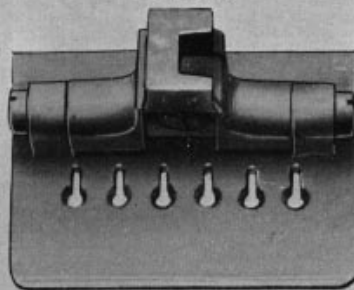
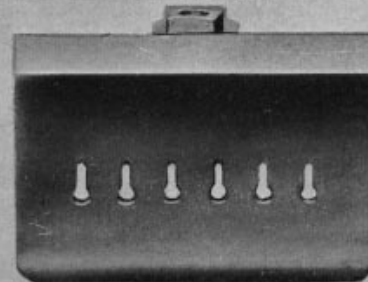


PLATE 7551—FULL SIZE

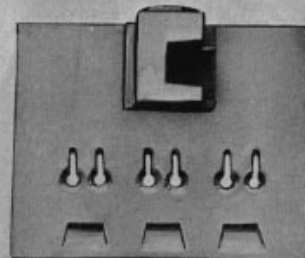
47293



47293



47300



47300

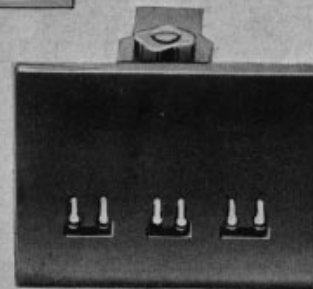
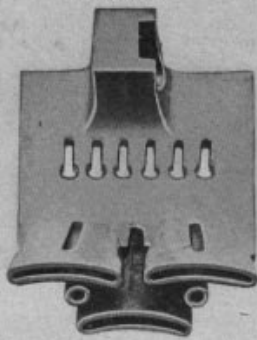
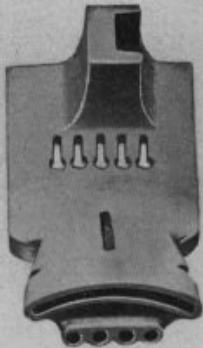


PLATE 7552—FULL SIZE

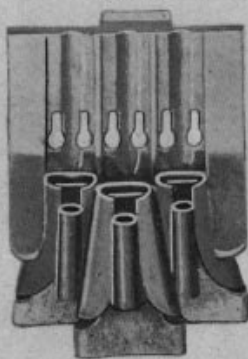
30356



31194



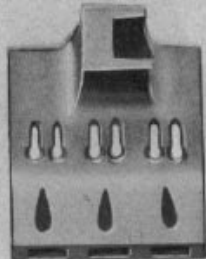
30356



31194



47310



47310

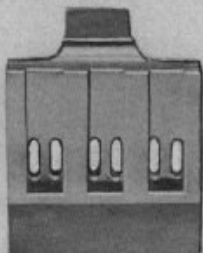
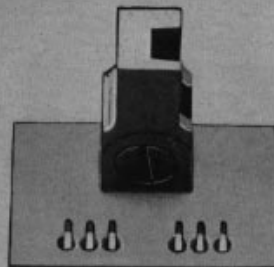
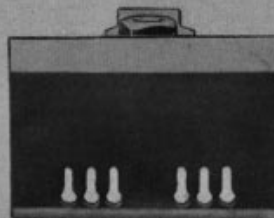


PLATE 7553—FULL SIZE

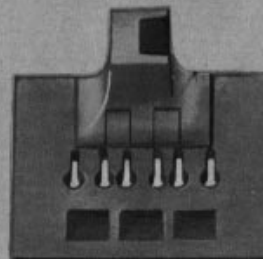
48527



48527



47301



47301

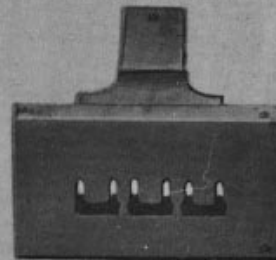
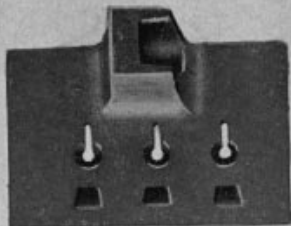
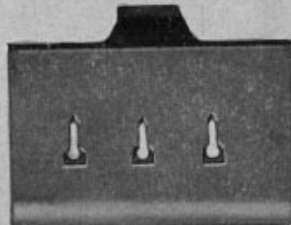


PLATE 7554—FULL SIZE

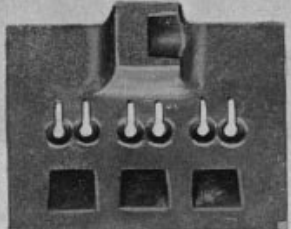
47295



47295



47296



47296

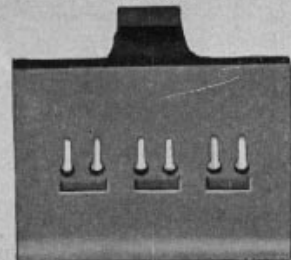
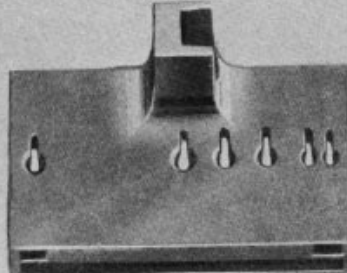
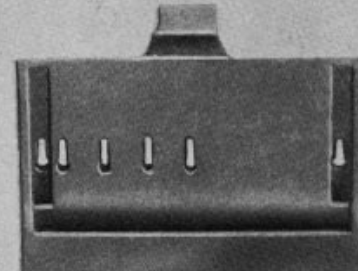


PLATE 7572—FULL SIZE

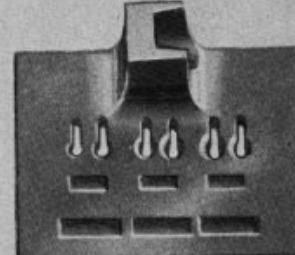
47297



47297



47312



47312

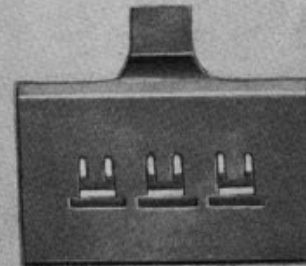
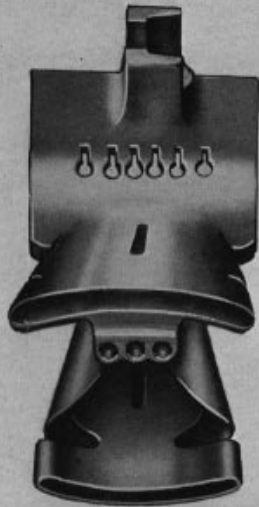


PLATE 7577—FULL SIZE

47298



47298

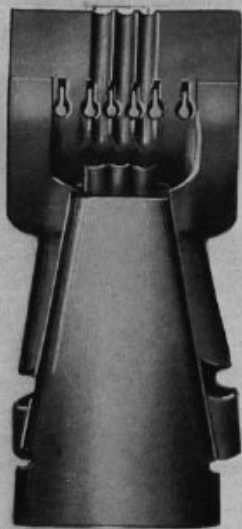
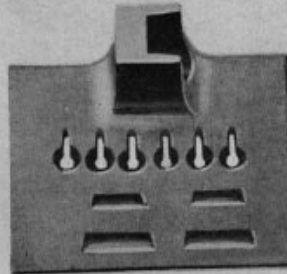
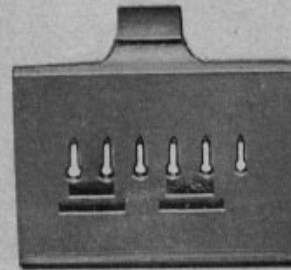


PLATE 7584—FULL SIZE

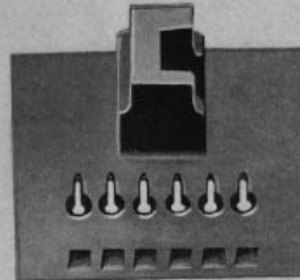
47308



47308



47309

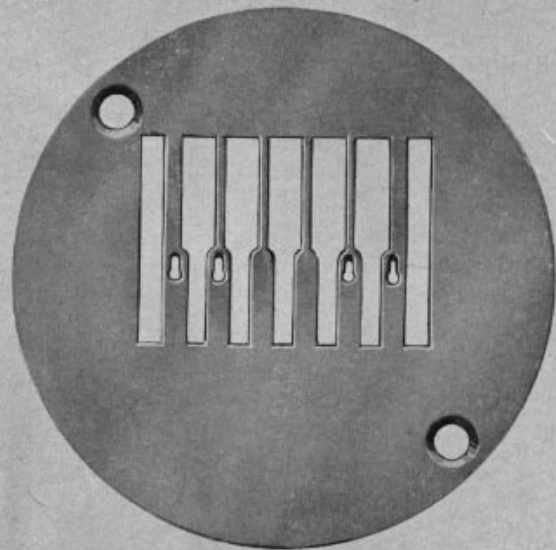


47309



PLATE 7609—FULL SIZE

48153



48122

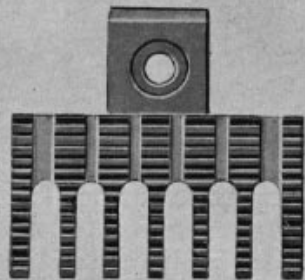
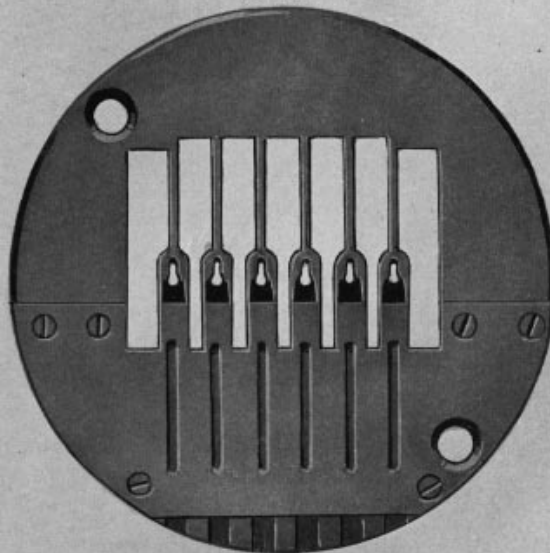


PLATE 7610—FULL SIZE

48152



48132

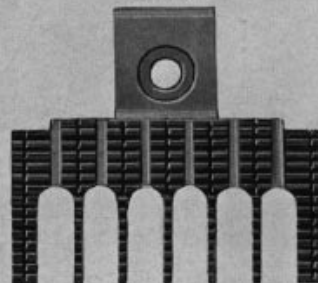
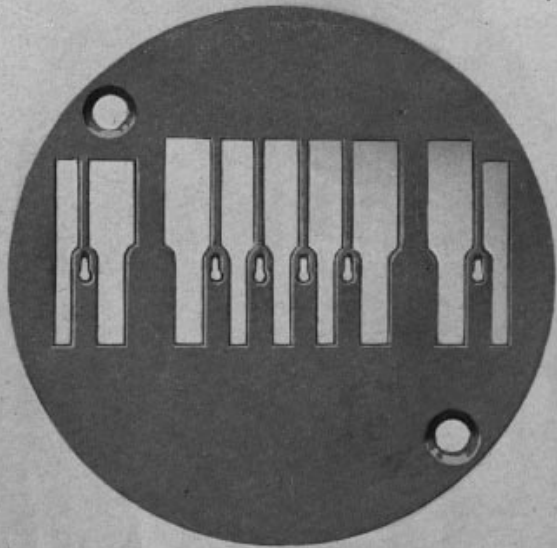


PLATE 7612—FULL SIZE

48154



48133

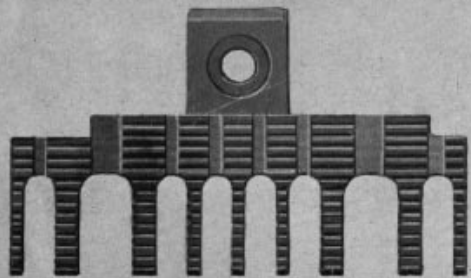
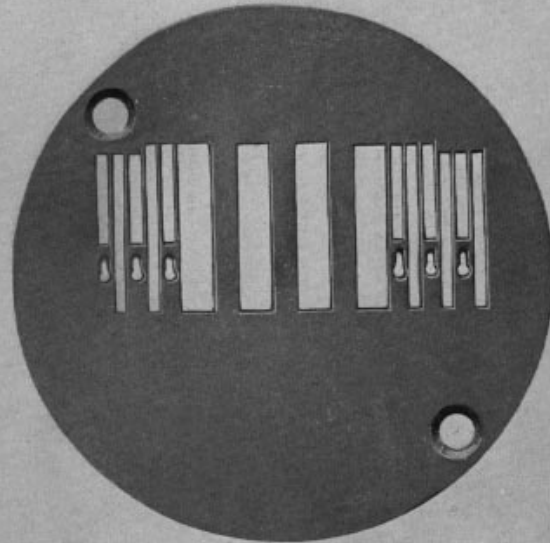


PLATE 7613—FULL SIZE

48552



48517

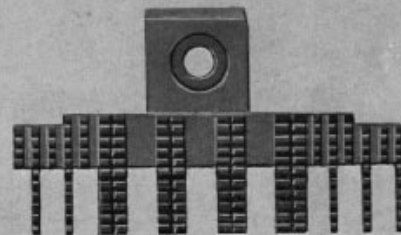
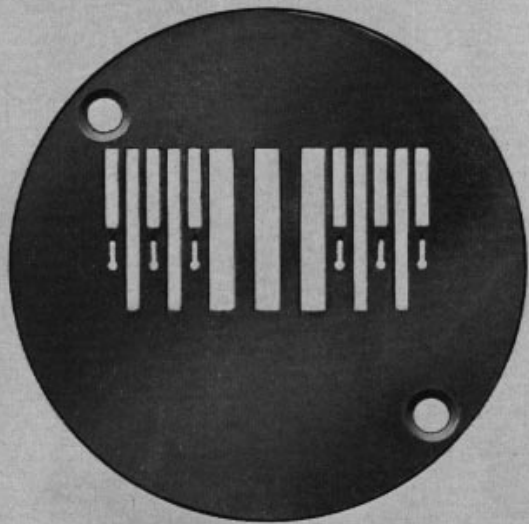


PLATE 8700—FULL SIZE

48155



48134

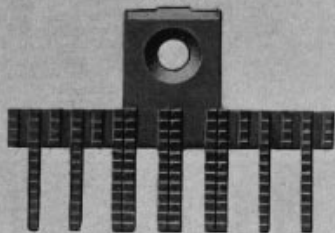
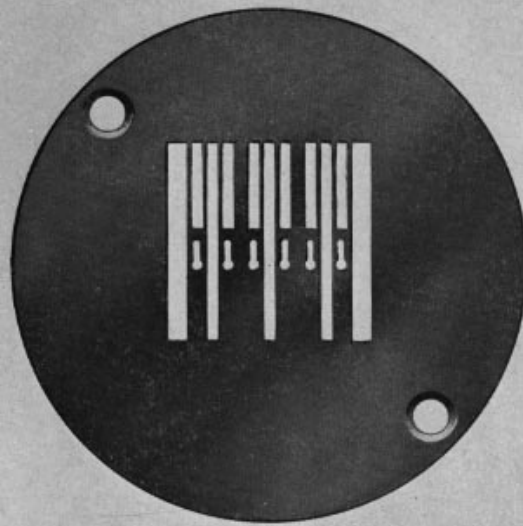


PLATE 8701—FULL SIZE

48156



48135

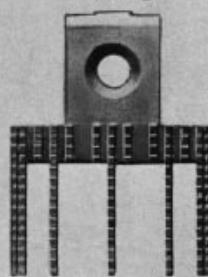
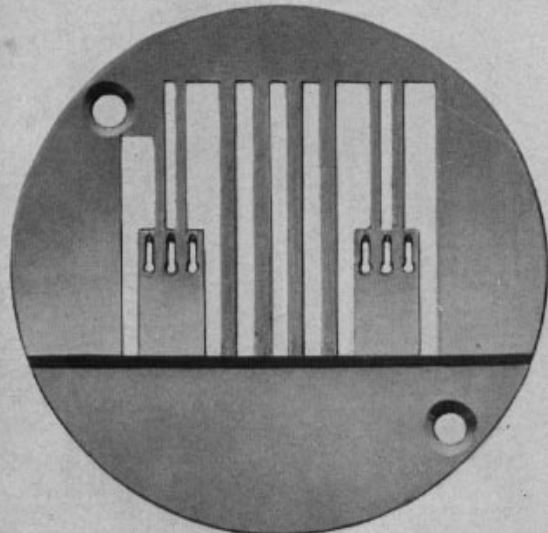


PLATE 8722—FULL SIZE

48157



48136

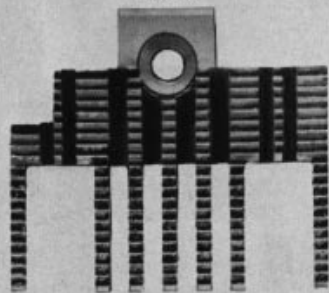
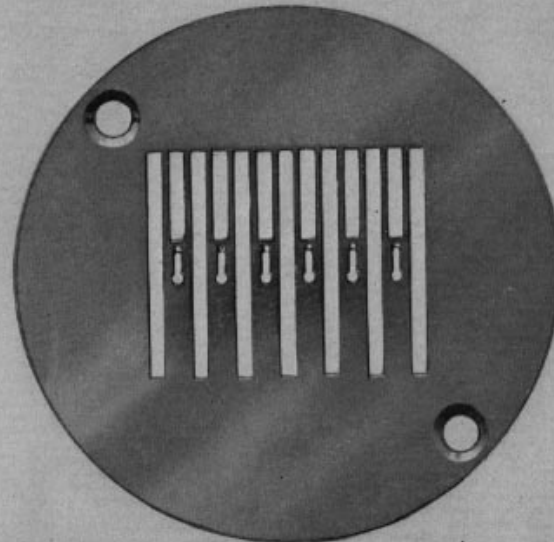


PLATE 8723—FULL SIZE

48158



48137

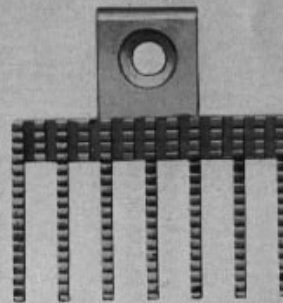
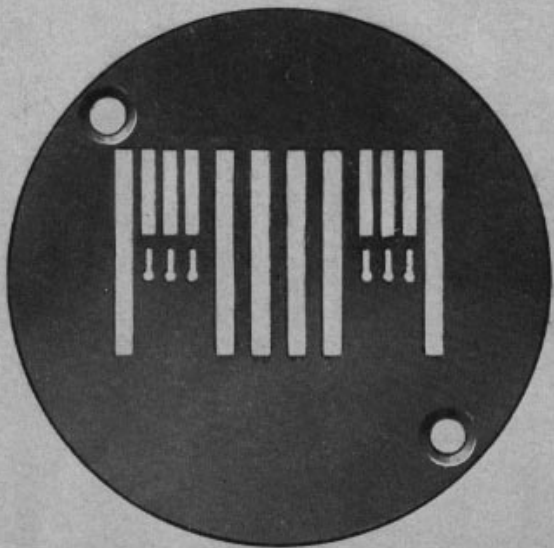


PLATE 8738—FULL SIZE

48159



48139

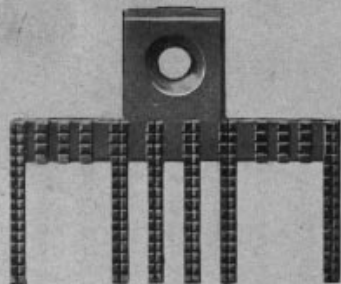
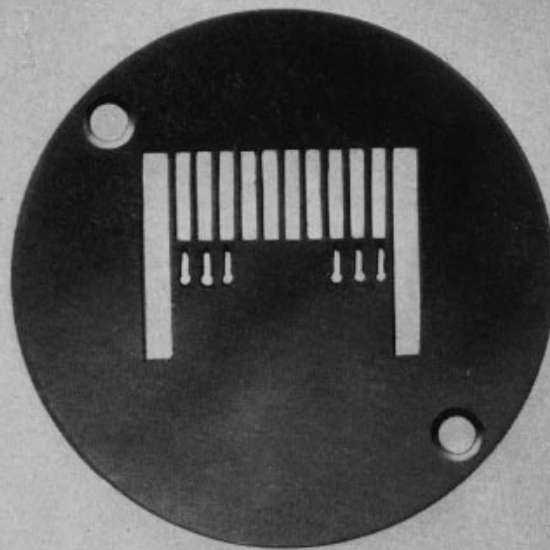


PLATE 8739—FULL SIZE

48160



48140

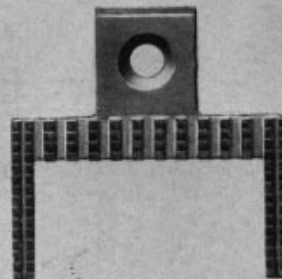
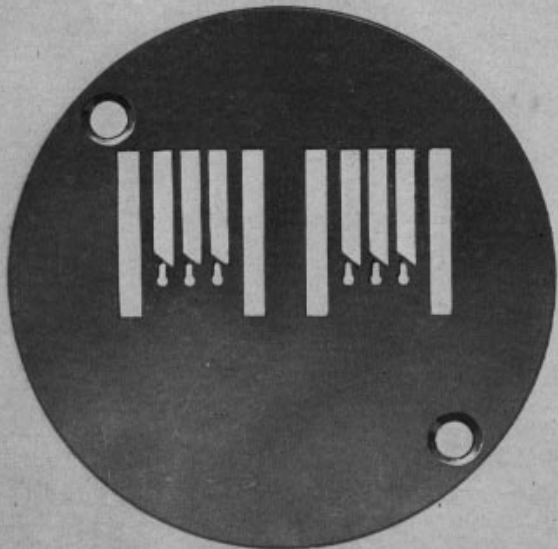


PLATE 8744—FULL SIZE

48553



48518

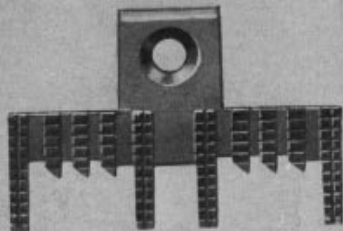
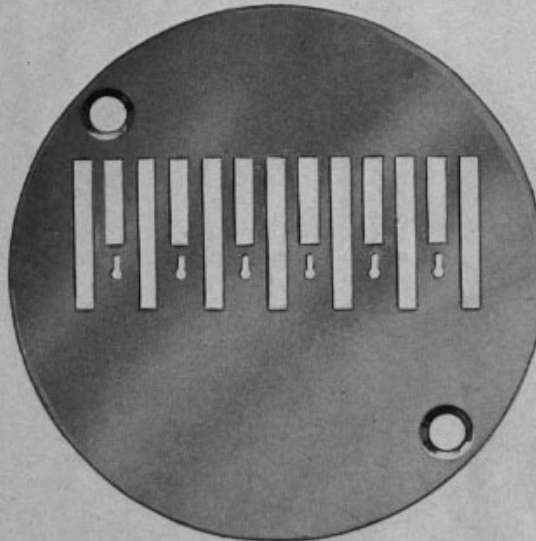


PLATE 8745—FULL SIZE

48554



48519

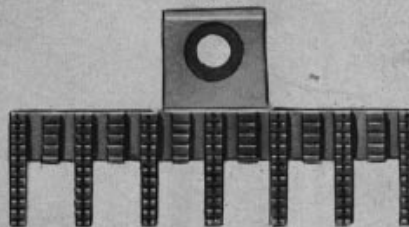
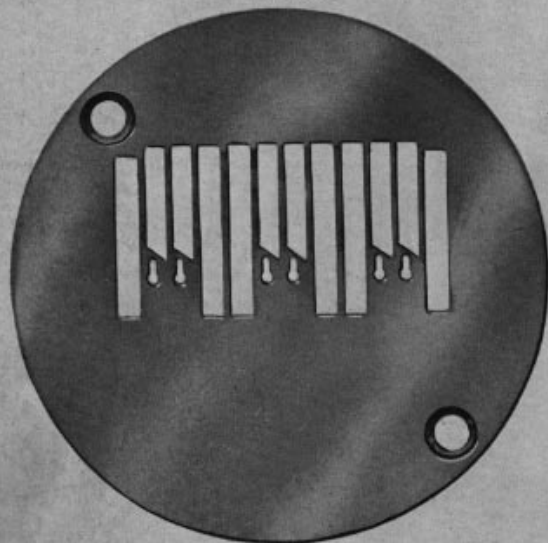


PLATE 8746—FULL SIZE

48555



48520

