

Singer 7-56

Singer 7-57

Form 18420
February, 1930
PRINTED IN U. S. A.

LIST OF PARTS



MACHINES

Nos. 7-56 and 7-57

** A TRADE MARK OF

THE SINGER MANUFACTURING COMPANY

INSTRUCTIONS FOR OILING

To ensure easy running and prevent unnecessary wear of the parts which are in movable contact, the machine requires oiling and when in continuous use, "TYPE B" or "TYPE D" OIL, sold only by Singer Sewing Machine Company, should be applied at least twice each day to all oil holes marked "OIL", as instructed in Forms 8183 and 8357.

"TYPE D" OIL is stainless.

COPYRIGHT, U. S. A.
1918, 1920, 1922, 1923, 1928 AND 1930
BY THE SINGER MANUFACTURING CO.
ALL RIGHTS RESERVED FOR ALL COUNTRIES

INDEX

	PAGE
ACCESSORIES.....	29
BOBBIN WINDER.....	29
DRIVING ATTACHMENT FOR No. 7-56 MACHINE.....	30
" " " No. 7-57 MACHINE.....	32
MACHINE No. 7-56.....	7
" " 7-57.....	18
NUMERICAL LIST OF PARTS.....	37
STEEL WORK.....	32
TABLE BELT GUIDE.....	34
THREAD UNWINDER.....	34
TRIMMINGS FOR TABLE No. 29716.....	35

INSTRUCTIONS FOR ORDERING

In ordering from this list, use **ONLY** the part NUMBER in the **FIRST** column.

The number stamped on a Sewing Machine part is in every case the number of the single part only.

Every combination of parts sent out as such has its specific number, which, although not stamped on the parts, must be used when ordering the combination.

Each number always indicates the **SAME PART** in whatever list it appears, or for whatever machine.

The letters after some of the numbers indicate the style of finish only, as follows:

- A—Hardened, Polished, Nickel Plated and Buffed
- B—Polished, Nickel Plated and Buffed
- C—Hardened Only
- D—Polished Only
- E—Soft, Not Polished
- F—Hardened and Polished
- H—Blued
- J—Nickel Plated Only
- K—Hardened and Nickel Plated
- L—Brass Plated
- M—Oxidized
- N—Japanned, Dull
- P—Japanned, Bright
- R—Merlized
- T—Copper Plated
- T. A.—Hardened, Polished, Copper and Nickel Plated and Buffed
- T. B.—Copper and Nickel Plated and Polished
- T. J.—Copper and Nickel Plated Only
- T. K.—Hardened, Copper and Nickel Plated
- T. M.—Copper Plated and Oxidized
- T. L.—Copper and Brass Plated
- U—Zinc Plated
- V—Silver Plated
- W—Polished and Nickel Plated
- Z—Chromium Plated
- Z. B.—Polished, Nickel Plated, Buffed and Chromium Plated
- Z. J.—Nickel and Chromium Plated

These letters **MUST BE USED** when they appear in the list; and **AFTER** the number as in the list.

In this series:

- 1 to 1500 and 50001 to 51500 are Screw Numbers
- 1501 to 1800 and 51501 to 51800 are Nut Numbers
- 1801 to 2000 and 51801 to 52000 are Roller Numbers
- 2001 to 50000 and 52001 and upward are numbers of Machine Parts

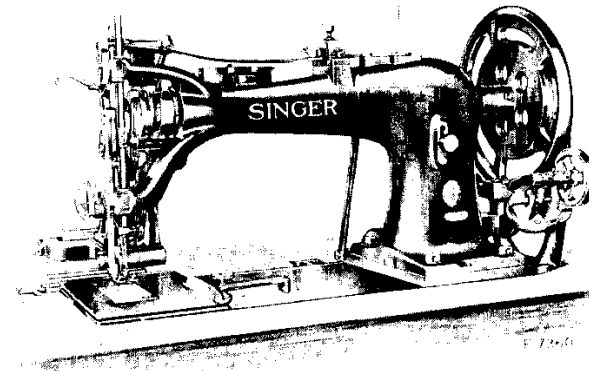
The figures in the second column refer only to the plates, illustrating the parts, and are **NOT TO BE USED** in ordering.

Parts marked with an asterisk (*) are furnished only when repairs are made at factory.

When ordering parts which differ as to **Gauge** (the distance between seams) the Gauge, as well as the **Number must be given** on order.

LIST OF PARTS COMPLETE

FOR



MACHINE No. 7-56

FOR TENT, AWNING AND OTHER WORK OF A SIMILAR NATURE. STITCH $\frac{1}{8}$ INCH TO $\frac{1}{2}$ INCH LONG. HAS 4 INCH HIGH POINT SHUTTLE NO. 58323, DROP FEED, ALTERNATING PRESSER, $\frac{5}{8}$ INCH PRESSER FOOT LIFT AND S. D. A. THE MACHINE IS FITTED WITH AN UPPER CORRUGATED FEED ROLL ATTACHED TO THE HEAD OF THE MACHINE AND A LOWER CORRUGATED FEED ROLL ATTACHED TO THE BED OF THE MACHINE TO ASSIST IN CARRYING THE MATERIAL FROM THE MACHINE AFTER BEING STITCHED. THE UNDER ROLL RECEIVES ITS MOTION FROM A CAM ON THE ARM SHAFT, AND IS INDEPENDENTLY ADJUSTABLE, SO AS TO BRING THE MOTION OF THE FEED ROLLS IN UNISON WITH THE FEEDING MECHANISM OF THE MACHINE.

FORMERLY 7 SV 56 MACHINE

NO.	PLATE	NAME
*58467	—	Arm.....
8702	4475	" Dowel Pin.....
872E	4479	" Screw.....
58334	7883	" Shaft.....
11354	4463	" " Bushing.....
437c	4478	" " " Set Screw.....

NO.	PLATE	NAME
58469	7884	Arm Side Cover and Feed Roll (lower) Regulator Supporting Bracket with 453c
1129d	7890	Arm Side Cover and Feed Roll (lower) Regulator Supporting Bracket Screw...
58335	9006	Balance Wheel with two 354c.....
58336	—	" " 58335 with 11442, 122307, two 1402d and four 401E.....
25362	9607	Balance Wheel Ball, size $\frac{1}{8}$ in.....
122303	—	" " " Ring.....
122304	9607	" " " " 122303 with eighteen 25362.....
122306	9607	Balance Wheel Ball Washer (left).....
122307	9607	" " " " (right).....
1402d	7871	" " " " " Screw
11442	7885	" " Friction Washer (paper)..
401E	4476	" " " " Screw...
354c	4479	" " Set Screw.....
*58470	—	Bed.....
58222	4462	Cloth Plate with two 58223 and four 58221
*58223	—	" " Packing.....
58221	—	" " " Rivet.....
389f	4476	" " Screw.....
19758	4462	Crank Connecting Rod with 19759 and two 575E.....
*19759	—	Crank Connecting Rod Cap.....
575E	4476	" " " " " Screw.....
1151c	4476	" " " " Hinge Screw.....
1646E	4479	" " " " " Nut
11365	4464	Feed Bar.....
50358c	4478	" " Screw Centre.....
1513j	4479	" " " " Nut.....
58472	7884	" Cam (double) with two 832c.....
832c	7890	" " Set Screw.....
11368	4465	" Connecting Link.....
565c	4476	" " " Hinge Screw.....
1513j	4479	" " " " " Nut.
19834	4436	" Dog (double).....
19835	4437	" " (single).....
166d	4476	" " Screw.....
19762	4461	" Forked Connection.....
565c	4476	" " " Hinge Screw...
1513j	4479	" " " " " Nut
9225	4461	" Lifting Rock Shaft with 134d, 2022 and 19967.....
58288	—	Feed Lifting Rock Shaft complete, Nos. 9225 and 19837.....

NO.	PLATE	NAME
19837	4463	Feed Lifting Rock Shaft Crank with 692d and 1801.....
692d	4479	Feed Lifting Rock Shaft Crank Clamping Screw.....
1861	4475	Feed Lifting Rock Shaft Crank Roller and Stud.....
1015c	4478	Feed Lifting Rock Shaft Screw Centre (left).....
1503E	4478	Feed Lifting Rock Shaft Screw Centre (left) Nut.....
294c	4478	Feed Lifting Rock Shaft Screw Centre (right).....
1503E	4478	Feed Lifting Rock Shaft Screw Centre (right) Nut.....
19967	4465	Feed Lifting Rock Shaft Wearing Block
2022	4465	" " " " " "
		Position Pin.....
134d	4465	Feed Lifting Rock Shaft Wearing Block Screw.....
11375	4464	Feed Regulator.....
568E	4477	" " Hinge Screw.....
50322d	4477	" " Thumb Screw.....
58243	4461	" Rock Shaft.....
58244	—	Feed Rock Shaft complete, Nos. 58235 and 58243.....
58235	4465	Feed Rock Shaft Crank with 346E.....
346E	4465	" " " " Clamping Screw.
294c	4478	" " " Screw Centre.....
1503E	4478	" " " " Nut.....
58473	7885	" Roll (lower) with two 840d (6 in. long).....
58474	7884	Feed Roll (lower) Regulator (forked)....
58475	7884	" " " " Connection
1487d	7890	" " " " "
		Hinge Screw (lower).....
51179E	7890	Feed Roll (lower) Regulator Connection Screw Stud (upper).....
1610c	7890	Feed Roll (lower) Regulator Connection Screw Stud (upper) Nut.....
14129	7890	Feed Roll (lower) Regulator Connection Screw Stud (upper) Nut Washer.....
58716	7890	Feed Roll (lower) Regulator Connection Screw Stud (upper) Sleeve.....
58476	7896	Feed Roll (lower) Regulator Hinge Pin
453c	4466	" " " " " "
		Set Screw.....

NO.	PLATE	NAME
58477	7886	Feed Roll (lower) Rock Shaft.....
840D	7890	" " " Set Screw.....
58478	7883	" " " Shaft.....
58479	9606	" " " " Bracket.....
58480	—	Feed Roll (lower) Shaft Bracket complete, Nos. 635c, 1513j, 21788, 58473, 58477 to 58479, 58481, 58482, 127526, four 227D, eight 127528, ten 27531 and thirty-six 127529.....
635c	7890	Feed Roll (lower) Shaft Bracket Adjusting Screw.....
1513j	4479	Feed Roll (lower) Shaft Bracket Adjusting Screw Nut.....
21788	7890	Feed Roll (lower) Shaft Bracket Adjusting Screw Spring.....
8582	7896	Feed Roll (lower) Shaft Bracket Dowel Pin.....
840D	7890	Feed Roll (lower) Shaft Bracket Screw...
58481	7886	" " " Wheel with two 448c..
127526	7886	" " " " Cover.....
227D	7896	" " " " " Screw....
58482	7886	" " " " Retaining Clutch
127528	7896	" " " " " " "
		Roller.....
127529	7896	Feed Roll (lower) Wheel Retaining Clutch Roller Spring.....
127531	7896	Feed Roll (lower) Wheel Roller.....
127529	7896	" " " " " Spring...
448c	4469	" " " " Set Screw.....
58483	7885	" " (upper) with two 155c (4 in. long).....
58485	7887	Feed Roll (upper) Lifting Lever with 1396D.....
1396D	7888	Feed Roll (upper) Lifting Lever Clamping Screw.....
58486	7887	Feed Roll (upper) Lifting Lever Shaft...
694D	7896	" " " " Screw.....
155c	7896	" " " Set Screw.....
58488	7887	" " " Shaft.....
58490	9603	" " " " Bracket.....
58492	—	Feed Roll (upper) Shaft Bracket complete, Nos. 649D, 694D, 1177D, 1401c, 1608c, 1681c, 58483, 58485, 58486, 58488, 58490, 58494, 58495, 58497, 58499, 58502 and two 162D.....
58494	7887	Feed Roll (upper) Shaft Bracket Hinge Pin.....

NO.	PLATE	NAME
445c	4478	Feed Roll (upper) Shaft Bracket Hinge Pin Set Screw.....
58495	7887	Feed Roll (upper) Spring.....
1401c	7896	" " " " Adjusting Screw
1681c	7896	" " " " " " "
		Nut.....
649D	7896	Feed Roll (upper) Spring Screw.....
58497	7887	" " " " Strap.....
162D	7896	" " " " " Screw...
58499	9603	" " " Supporting Bracket with 445c.....
2002	7896	Feed Roll (upper) Supporting Bracket Dowel Pin.....
58502	7898	Feed Roll (upper) Supporting Bracket Screw Stud.....
1177D	4476	Feed Roll (upper) Supporting Bracket Screw Stud Cap Screw.....
1608c	7896	Feed Roll (upper) Supporting Bracket Screw Stud Lock Nut.....
36114	4456	Guide (6 in. face) for 19855.....
26419	4463	" " " " 19858.....
885D	4477	" Thumb Screw.....
58258	4464	Lifting Presser Bar.....
11476	850	" " " Bell Crank.....
166D	4476	" " " " " Hinge Cap Screw.....
1851	4465	Lifting Presser Bar Bell Crank Lifting Roller with 610D.....
610D	4465	Lifting Presser Bar Bell Crank Lifting Roller Screw.....
1518E	4465	Lifting Presser Bar Bell Crank Lifting Roller Screw Nut.....
2718	4465	Lifting Presser Bar Bell Crank Lifting Roller Screw Nut Washer.....
11478	850	Lifting Presser Bar Bracket with two 145D
145D	4473	" " " " Clamping Screw.....
11909	4464	Lifting Presser Bar Lifter with 8761 and 8763.....
8760	4465	Lifting Presser Bar Lifter Friction Washer
16D	4477	" " " " Hinge Screw...
8761	4465	" " " " Stop Pin.....
11907	4463	" " " Lifting Link.....
166D	4476	" " " " Cap Screw
8763	4465	" " " " " Hinge Stud.....

NO.	PLATE	NAME
8973	4465	Lifting Presser Bar Lifting Link Hinge Stud Pin.....
43267	4465	Lifting Presser Bar Lifting Link Hinge Stud Washer.....
11479	4466	Lifting Presser Bar Rock Shaft.....
11480	850	" " " " " Adjusting Arm with 453c.....
2117	4475	Lifting Presser Bar Rock Shaft Adjusting Arm Pin.....
453c	4466	Lifting Presser Bar Rock Shaft Adjusting Arm Set Screw.....
11484	4466	Lifting Presser Bar Rock Shaft Crank with 453c and 1850.....
2117	4475	Lifting Presser Bar Rock Shaft Crank Pin.....
1850	4466	Lifting Presser Bar Rock Shaft Crank Roller and Stud.....
453c	4466	Lifting Presser Bar Rock Shaft Crank Set Screw.....
11486	850	Lifting Presser Bar Rock Shaft Eccentric Strap with two each 141F and 1528b...
141F	4476	Lifting Presser Bar Rock Shaft Eccentric Strap Adjusting Screw.....
1528b	4479	Lifting Presser Bar Rock Shaft Eccentric Strap Adjusting Screw Nut.....
608E	4466	Lifting Presser Bar Rock Shaft Eccentric Strap Hinge Screw.....
1518b	4465	Lifting Presser Bar Rock Shaft Eccentric Strap Hinge Screw Nut.....
11487	4466	Lifting Presser Bar Rock Shaft Eccentric Strap Hinge Screw Slide.....
58259	4466	Lifting Presser Bar Rock Shaft Eccentric Strap Hinge Screw Slide Stop.....
11488	4466	Lifting Presser Bar Rock Shaft Eccentric Strap Hinge Screw Slide Washer.....
258E	4477	Lifting Presser Bar Screw Bushing.....
11489	4466	" " " " Screw (lower).....
11490	4466	" " " " (upper).....
11491	—	" " " " " 11490 with 11492.....
11492	4466	Lifting Presser Bar Screw (upper) Cap...
11493	4461	" " " " Spring (flat).....
58252	4463	" " " " Bracket.....
1177D	4476	" " " " " Screw
11661	7888	" " " " Guide Pin.....
50323D	4479	" " " " Regulating Thumb Screw.....

NO.	PLATE	NAME
58260	4467	Lifting Presser Foot with 1259c, for 19834
58261	4467	" " " " 1259c, for 19835
1259c	4478	" " " " Set Screw.....
11538	4464	Needle Bar.....
11539	4468	" " Connecting Link.....
566c	4468	" " " " Hinge Screw
1513J	4479	" " " " " " " Nut.....
11383	4468	Needle Bar Connecting Stud with two 445F.....
19981	—	Needle Bar Connecting Stud 11383 with 11539.....
445F	4478	Needle Bar Connecting Stud Set Screw..
258E	4477	" " Screw Bushing.....
19702	4468	" Clamp with 680F and 11385.....
11385	4468	" " Gib.....
680F	4468	" " Thumb Screw.....
58253	—	Oil Cup.....
11917	—	" " Cover.....
9084	4468	" " " Hinge Pin.....
2205	4468	" " " Latch Spring.....
207F	4468	" " " " " Screw.....
8953	4468	" or Wax Stripper (felt).....
11918	4468	" " " " Washer (steel) for 11917.....
8482	4468	Oil or Wax Stripper Washer (steel) for 58253.....
207F	4468	Oil or Wax Stripper Washer Screw.....
58254	4462	Oil Cup complete, Nos. 2205, 8482, 9084, 11917, 11918, 58253, two 8953 and three 207F.....
134D	4465	Oil Cup Screw.....
19768	4461	Oscillating Rock Shaft.....
19790	—	Oscillating Rock Shaft complete, Nos. 654c, 9115, 11165, 19768 and two 1503E
9115	4461	Oscillating Rock Shaft Hinge Pin.....
1503E	4478	" " " " Nut
654c	4478	" " " " " Screw
		Bearing.....
1503E	4478	Oscillating Rock Shaft Hinge Pin Screw Bearing Nut.....
11165	4469	Oscillating Rock Shaft Oil Pad.....
19842	4461	Oscillating Shaft.....
9152	4469	" " Collar with 448c.....
448c	4469	" " " " Set Screw.....
19770	—	" " Crank with 445c.....

NO.	PLATE	NAME
19789	4469	Oscillating Shaft Crank complete, Nos. 1508E, 19770 and 19773.....
58277	7896	Oscillating Shaft Crank Pin.....
445c	4478	" " " Set Screw.....
19771	4469	" " " Slide Block.....
19773	4469	Oscillating Shaft Crank Slide Block complete, Nos. 164d, 1156c, 19771 and 19772.....
164d	4469	Oscillating Shaft Crank Slide Block Cap Screw.....
19772	4469	Oscillating Shaft Crank Slide Block Cap Screw Washer.....
1156c	4469	Oscillating Shaft Crank Slide Block Cap Screw Stud.....
1508E	4469	Oscillating Shaft Crank Slide Block Cap Screw Stud Nut.....
16901	7892	Shuttle Bobbin.....
43273	7871	" " Centre Pin.....
43284	7893	" Cylinder with 43273.....
43288	—	" " 43284 with 1323F and 58209.....
8777	7896	Shuttle Cylinder Hinge Pin.....
43235	7892	" " Latch.....
43236	7816	" " Hinge Pin.....
19869	7892	" " Spring.....
58208	7893	" Frame.....
58272	—	" " 58208 with 19869, 43235 and 43236.....
1323F	7892	Shuttle Tension Regulating Screw.....
58209	7892	" " Spring.....
58323	7893	Shuttle (cylinder) 4 in. diam. complete, Nos. 8777, 16901, 43288 and 58272....
19845	4472	Shuttle Driver with 445c.....
8873	4475	" " Pin.....
445c	4478	" " Set Screw.....
19846	4441	" Race Back.....
2049	4475	" " Position Pin.....
19847	4441	" " Spring.....
660D	4477	" " " Screw.....
19848	—	" " Body.....
19849	4441	Shuttle Race complete, Nos. 660D, 19846 to 19848 and two 2049.....
134D	4465	Shuttle Race Screw.....
19850	4462	" " Frame with 11838.....
116D	4476	" " Clamping Screw.....
11838	4475	" " Position Pin.....

NO.	PLATE	NAME
9121	4472	Shuttle Race Slide (left) for 19858.....
9122	4472	" " " (right) for 19858.....
58255	4472	Spool Holder Bracket.....
58256	4472	Spool Holder Bracket complete, Nos. 11881 and 58255.....
1177D	4476	Spool Holder Bracket Screw.....
851E	4473	" " Tension Spool Pin with fixed cone.....
8018	4473	Spool Holder Tension Spool Pin Cone....
1541E	4473	" " " " " Nut.....
8019	4473	" " " " " Spring..
11881	—	Spool Holder Tension Spool Pin complete, Nos. 851E, 1541E, 8018 and 8019.....
11502	4473	Tension Bracket and Vibrating Presser Bar Cap with 11424.....
11501	—	Tension Bracket and Vibrating Presser Bar complete, Nos. 122D, 9525, 11502, 11506, 11936, 11937, 12042 and two 190D.....
159F	4473	Tension Bracket and Vibrating Presser Bar Cap Screw (left).....
145F	4473	Tension Bracket and Vibrating Presser Bar Cap Screw (right).....
5983	4473	Tension Friction Washer (felt).....
11423	4473	" " " (steel).....
1560C	4473	" Regulating Thumb Nut.....
8905	4473	" " " Washer..
607E	4473	" Screw Stud.....
122D	4473	" " Clamping Screw....
8791	4474	" Spring.....
11044	4474	" Wheel.....
12042	—	Tension (wheel) complete, Nos. 607E, 1560C, 8791, 8905, 11044, 11423 and two 5983.....
11424	4474	Thread Eyelet for 11502.....
11950	4474	" " " 11503.....
11495	4468	" " (side of arm).....
190D	4468	" " " " " Screw.....
2102	4474	" Retaining Disc.....
1560C	4473	" " Regulating Thumb Nut
8905	4473	" " " " "
		Washer.....
606E	4474	Thread Retaining Screw Stud.....
2103	4474	" " Spring.....
11503	—	Thread Retainer complete, Nos. 606E, 1560C, 2103, 8905 and two 2102.....

NO.	PLATE	NAME
11505	4461	Thread Take-up Cam with two 434c....
8873	4475	" " " Pin.....
434c	4478	" " " Set Screw.....
58331	—	" " Lever.....
58332	7891	" " " 58331 with 1995 and 9219.....
58333	—	Thread Take-up Lever 58332 with 50437D
50437D	4477	" " " Hinge Screw.....
1995	4475	" " " Roller and Screw Stud with 1518E.....
1518E	4465	Thread Take-up Lever Roller and Screw Stud Nut.....
9219	7896	Thread Take-up Lever Thread Eyelet Bushing.....
11506	4474	Thread Take-up Spring.....
11936	4474	" " " Regulating Plate
190D	4468	" " " " " "
		Adjusting Screw.....
11937	4474	Thread Take-up Spring Staple.....
9525	4474	" " " " Washer...
19853	—	Throat Plate Body for 19855.....
19854	4436	" " Needle Hole Strip for 19855
389F	4476	" " " " " Screw...
19855	4436	Throat Plate complete for 19834, Nos. 19853, 19854 and two 389F.....
19856	—	Throat Plate Body for 19858.....
19857	4437	" " Needle Plate for 19858.....
231F	4476	" " " " Screw.....
19858	4437	Throat Plate complete for 19835, Nos. 231F, 19856 and 19857.....
381D	4476	Throat Plate Screw.....
11508	850	Vibrating Presser Bar.....
11509	4475	" " " Cushion (rawhide)..
233D	4475	" " " " Screw.....
11510	850	" " " Hinge Bracket with 145D.....
145D	4473	Vibrating Presser Bar Hinge Bracket Adjusting Screw.....
164D	4469	Vibrating Presser Bar Hinge Cap Screw
41544	4475	" " " " " "
		Washer.....
11512	4475	Vibrating Presser Bar Spring.....
11939	4475	" " " " Adjusting Staple.....
190D	4468	Vibrating Presser Bar Spring Adjusting Staple Screw.....

NO.	PLATE	NAME
233D	4475	Vibrating Presser Bar Spring Screw.....
19860	4467	" " Foot for 19834.....
58262	4467	" " " " 19835.....
898D	4476	" " " Screw.....
1547D	4479	" " " " Nut.....

SINGER Needles should be used
in **SINGER** Machines
These Needles and their Containers
are marked with the
Company's Trade Mark "SIMANCO.**" 1

Needles in Containers marked
"FOR SINGER MACHINES"
are NOT **SINGER** made needles. 2

**LIST OF PARTS COMPLETE
FOR
MACHINE No. 7-57**

FOR TENT, AWNING AND OTHER WORK OF A SIMILAR NATURE. TWO NEEDLES, TWO CYLINDER SHUTTLES. NOS. 43275 AND 43283, GAUGE 1 INCH, CAN BE FURNISHED IN GAUGES FROM 1 INCH TO 1½ INCHES AT ADDITIONAL SELLING PRICE.

DROP FEED, ADJUSTABLE PRESSER, EITHER VIBRATING OR STATIONARY AND S. D. A. THE MACHINE IS FITTED WITH AN UPPER CORRUGATED FEED ROLL ATTACHED TO THE HEAD OF THE MACHINE AND A LOWER CORRUGATED FEED ROLL ATTACHED TO THE BED OF THE MACHINE TO ASSIST IN CARRYING THE WORK FROM THE MACHINE AFTER BEING STITCHED. THE UNDER ROLL RECEIVES ITS MOTION FROM A CAM ON THE ARM SHAFT AND IS INDEPENDENTLY ADJUSTED, SO AS TO BRING THE MOTION OF THE FEED ROLLS IN UNISON WITH THE FEEDING MECHANISM OF THE MACHINE.

FORMERLY 7 SV 57 MACHINE

NO.	PLATE	NAME
*58468	—	Arm.....
8702	4475	" Dowel Pin.....
*19887	—	" Packing Plate.....
50349E	7890	" Screw.....
43263	9607	" " Washer.....
58444	7883	" Shaft.....
11354	4463	" " Bushing.....
437c	4478	" " " Set Screw.....
50372D	7890	" " Screw.....
9842	4475	" " " Washer.....
58469	7884	" Side Cover and Feed Roll (lower) Regulator Supporting Bracket with 453c
1129D	7890	Arm Side Cover and Feed Roll (lower) Regulator Supporting Bracket Screw..
58335	9606	Balance Wheel with two 354c.....
58336	—	" " 58335 with 11442, 122307, two 1402D and four 401E.....
25362	9607	Balance Wheel Ball, size 1/8 in.....
122303	—	" " " Ring.....
122304	9607	" " " " 122303 with eighteen 25362.....

NO.	PLATE	NAME
122306	9607	Balance Wheel Ball Washer (left).....
122307	9607	" " " " (right).....
1402D	7871	" " " " " Screw
11442	7885	" " Friction Washer (paper)..
401E	4476	" " " " " Screw....
354c	4479	" " Set Screw.....
*58471	—	Bed.....
58387	7885	Cloth Plate.....
145F	4473	" " Screw.....
19758	4462	Crank Connecting Rod with 19759 and two 575E.....
*19759	—	Crank Connecting Rod Cap.....
575E	4476	" " " " " Screw.....
1151c	4476	" " " " " Hinge Screw....
1646E	4479	" " " " " " Nut
58216	7885	Face Plate.....
58452	—	Face Plate complete, Nos. 910c, 11874, 11875, 19583, 19590, 19701, 19866, 19886, 41544, 58216, 58453 and three 164D.....
19583	7890	Face Plate Thread Eyelet.....
19590	7890	" " " " " Guard.....
164D	4469	" " " " " Screw.....
161D	7890	" " " " " " Screw.....
58446	7885	Feed Bar.....
307c	7890	" " " " " " Screw Centre.....
1513J	4479	" " " " " " Nut.....
58472	7884	" Cam (double) with two 832c.....
832c	7890	" " Set Screw.....
11368	4465	" Connecting Link.....
565c	4476	" " " " " Hinge Screw....
1513J	4479	" " " " " " Nut.
58389	7899	" Dog, for 1 in. gauge.....
58414	9601	" " " 1 1/8 in. and 1 1/4 in. gauges..
58415	9602	" " " 1 3/8 in. and 1 1/2 in. gauges..
177D	7890	" " " " " " Screw.....
19762	4461	" Forked Connection.....
565c	4476	" " " " " " Hinge Screw....
1513J	4479	" " " " " " " Nut
58390	7883	" Lifting Rock Shaft with 134D, 2022 and 19967.....
58391	—	Feed Lifting Rock Shaft complete, Nos. 58390 and two 19819.....
19819	7894	Feed Lifting Rock Shaft Crank with 346E and 1861.....
346E	4465	Feed Lifting Rock Shaft Crank Clamping Screw.....

NO.	PLATE	NAME
1861	4475	Feed Lifting Rock Shaft Crank Roller and Stud.....
1015c	4478	Feed Lifting Rock Shaft Screw Centre (left).....
1503E	4478	Feed Lifting Rock Shaft Screw Centre (left) Nut.....
294c	4478	Feed Lifting Rock Shaft Screw Centre (right).....
1503c	4478	Feed Lifting Rock Shaft Screw Centre (right) Nut.....
19967	4465	Feed Lifting Rock Shaft Wearing Block
2022	4465	" " " " " "
		Position Pin.....
134b	4465	Feed Lifting Rock Shaft Wearing Block Screw.....
11375	4464	Feed Regulator.....
568E	4477	" " Hinge Screw.....
50322D	4477	" " Thumb Screw.....
58392	7883	" Rock Shaft.....
58393	—	Feed Rock Shaft complete, Nos. 58235 and 58392.....
58235	4465	Feed Rock Shaft Crank with 346E.....
346E	4465	" " " " Clamping Screw.....
294c	4478	" " " Screw Centre.....
1503E	4478	" " " " Nut.....
58473	7885	" Roll (lower) with 840D.....
58474	7884	" " " Regulator (forked)....
58475	7884	" " " " Connection
1487D	7890	" " " " " "
		Hinge Screw (lower).....
51179E	7890	Feed Roll (lower) Regulator Connection Screw Stud (upper).....
1610c	7890	Feed Roll (lower) Regulator Connection Screw Stud (upper) Nut.....
14129	7890	Feed Roll (lower) Regulator Connection Screw Stud (upper) Nut Washer.....
58716	7890	Feed Roll (lower) Regulator Connection Screw Stud (upper) Sleeve.....
58476	7896	Feed Roll (lower) Regulator Hinge Pin
453c	4466	" " " " " "
		Set Screw.....
58477	7886	Feed Roll (lower) Rock Shaft.....
840D	7890	" " " Set Screw.....
58478	7883	" " " Shaft.....
58479	9606	" " " " Bracket.....

NO.	PLATE	NAME
58480	—	Feed Roll (lower) Shaft Bracket complete, Nos. 635c, 1513D, 21788, 58473, 58477 to 58479, 58481, 58482, 127526, four 227b, eight 127528, ten 127531 and thirty-six 127529.....
635c	7890	Feed Roll (lower) Shaft Bracket Adjusting Screw.....
1513J	4479	Feed Roll (lower) Shaft Bracket Adjusting Screw Nut.....
21788	7890	Feed Roll (lower) Shaft Bracket Adjusting Screw Spring.....
8582	7896	Feed Roll (lower) Shaft Bracket Dowel Pin.....
840D	7890	Feed Roll (lower) Shaft Bracket Screw...
58481	7886	" " Wheel with two 448c.....
127526	7886	" " (lower) Wheel Cover.....
227D	7896	" " " " " Screw....
58482	7886	" " " " Retaining Clutch
127528	7896	" Roll (lower) Wheel Retaining Clutch Roller.....
127529	7896	Feed Roll (lower) Wheel Retaining Clutch Roller Spring.....
127531	7896	Feed Roll (lower) Wheel Roller.....
127529	7896	" " " " " Spring...
448c	4469	" " " " Set Screw.....
58484	7885	" " (upper) with two 155c (6 in. long).....
58485	7887	Feed Roll (upper) Lifting Lever with 1396D.....
1396D	7888	Feed Roll (upper) Lifting Lever Clamping Screw.....
58487	7887	Feed Roll (upper) Lifting Lever Shaft...
694D	7896	" " " " Screw.....
155c	7896	" " " Set Screw.....
58489	7887	" " " Shaft.....
58491	9603	" " " " Bracket.....
58493	—	Feed Roll (upper) Shaft Bracket complete, Nos. 649D, 694D, 1401c, 1681c, 40063, 58484, 58485, 58487, 58489, 58491, 58496, 58498, 58500, 58501, 58504, 58505 and two each 162D, 178D and 1177D.....
40063	7887	Feed Roll (upper) Shaft Bracket Hinge Pin.....
448c	4469	Feed Roll (upper) Shaft Bracket Hinge Pin Set Screw.....
58496	7887	Feed Roll (upper) Spring.....

NO.	PLATE	NAME
1401c	7896	Feed Roll (upper) Spring Adjusting Screw
1681c	7896	" " " " " "
		Nut.....
649d	7896	Feed Roll (upper) Spring Screw.....
58498	7887	" " " " Strap.....
162d	7896	" " " " Screw....
58500	9603	" " " Supporting Bracket with 448c.....
58501	7891	Feed Roll (upper) Supporting Bracket Position Bracket.....
1177d	4476	Feed Roll (upper) Supporting Bracket Position Bracket Screw.....
130d	7896	Feed Roll (upper) Supporting Bracket Screw.....
26176	7894	Guide (6 in. face).....
885d	4477	" Thumb Screw.....
58236	7891	Lifting Presser Bar.....
11523	7894	" " " Bell Crank.....
11524	7894	" " " " Adjusting Link.....
11525	---	Lifting Presser Bar Bell Crank Adjusting Link complete, Nos. 1518E, 1828, 2718 and 11524.....
1828	7888	Lifting Presser Bar Bell Crank Adjusting Link Roller with 372c.....
372c	7888	Lifting Presser Bar Bell Crank Adjusting Link Roller Screw.....
1518E	4465	Lifting Presser Bar Bell Crank Adjusting Link Roller Screw Nut.....
2718	4465	Lifting Presser Bar Bell Crank Adjusting Link Roller Screw Nut Washer.....
611E	7888	Lifting Presser Bar Bell Crank Adjusting Link Screw.....
11526	7888	Lifting Presser Bar Bell Crank Connecting Stud with two 858c.....
11527	---	Lifting Presser Bar Bell Crank Connecting Stud complete, Nos. 164d, 11526 and 11528.....
164d	4469	Lifting Presser Bar Bell Crank Connecting Stud Cap Screw.....
11528	7888	Lifting Presser Bar Bell Crank Connecting Stud Cap Screw Washer.....
858c	7888	Lifting Presser Bar Bell Crank Connecting Stud Set Screw.....
50206d	7888	Lifting Presser Bar Bell Crank Hinge Screw.....

NO.	PLATE	NAME
1583E	7888	Lifting Presser Bar Bell Crank Hinge Screw Nut.....
58453	7884	Lifting Presser Bar Lifter.....
58237	7889	" " " " Bracket with 1497F and 58238.....
1497F	7888	Lifting Presser Bar Lifter Bracket Set Screw.....
58238	7888	Lifting Presser Bar Lifter Bracket Spring Bearing.....
19866	7888	Lifting Presser Bar Lifter Hinge Pin.....
910c	7888	" " " " " " Set Screw.....
11031	7883	Lifting Presser Bar Spring (flat).....
58252	4463	" " " " Bracket.....
1177d	4476	" " " " " Screw
11661	7888	" " " " Guide Pin....
50323d	4479	" " " " Regulating Thumb Screw.....
19732	7891	Needle Bar for 19735.....
58353	7842	" " " 58354.....
19735	---	Needle Bar complete, with adjustable clamps, for 1 in. and 1 1/8 in. gauges, Nos. 19732 to 19734 and two 898d.....
58354	---	Needle Bar complete, with adjustable clamps, for 1 1/4 in. to 1 1/2 in. gauges, Nos. 58353, 58355, 58356 and two 898d
19564	7889	Needle Bar Connecting Link.....
566c	4468	" " " " Hinge Screw
1513j	4479	" " " " " "
		Nut.....
19565	7889	Needle Bar Connecting Stud with 129d and 445F.....
58203	---	Needle Bar Connecting Stud 19565 with 19564.....
129d	7888	Needle Bar Connecting Stud Clamping Screw.....
445F	4478	Needle Bar Connecting Stud Set Screw..
257E	7889	" " Screw Bushing.....
19733	7889	" Clamp (left) with 191F, for 19735
58355	7889	" " " " " " 58354
19734	7889	" " (right) with 191F for 19735
58356	7889	" " " " " " 58354
898d	4476	" " Screw.....
191F	7888	" Set Screw.....
58253	---	Oil Cup.....
11917	---	" " Cover.....
9084	4468	" " " Hinge Pin.....

NO.	PLATE	NAME
2205	4468	Oil Cup Cover Latch Spring
207F	4468	" " " " " Screw
8953	4468	" or Wax Stripper (felt)
11918	4468	" " " " Washer (steel) for 11917
8482	4468	Oil or Wax Stripper Washer (steel) for 58253
207F	4468	Oil or Wax Stripper Washer Screw
58254	4462	Oil Cup complete, Nos. 2205, 8482, 9084, 11917, 11918, 58253, two 8953 and three 207F
134b	4465	Oil Cup Screw
*19768	4461	Oscillating Rock Shaft
19790	—	Oscillating Rock Shaft complete, Nos. 654c, 9115, 11165, 19768 and two 1503E
9115	4461	Oscillating Rock Shaft Hinge Pin
1503E	4478	" " " " " Nut
654c	4478	" " " " " Screw Bearing
1503E	4478	Oscillating Rock Shaft Hinge Pin Screw Bearing Nut
11165	4469	Oscillating Rock Shaft Oil Pad
19769	7883	" Shaft
9152	4469	" " Collar with two 448c
448c	4469	" " " " Set Screw
19770	—	" " Crank with 445c
19789	4469	Oscillating Shaft Crank complete, Nos. 1508E, 19770 and 19773
58277	7896	Oscillating Shaft Crank Pin
445c	4478	" " " " Set Screw
19771	4469	" " " " Slide Block
19773	4469	Oscillating Shaft Crank Slide Block com- plete, Nos. 164b, 1156c, 19771 and 19772
164b	4469	Oscillating Shaft Crank Slide Block Cap Screw
19772	4469	Oscillating Shaft Crank Slide Block Cap Screw Washer
1156c	4469	Oscillating Shaft Crank Slide Block Screw Stud
1508E	4469	Oscillating Shaft Crank Slide Block Screw Stud Nut
16901	7892	Shuttle (inside) Bobbin
43273	7871	" " " " Centre Pin
43274	7817	" " " " Cylinder with 43273
43286	—	" " " " 43274 with 1323F and 8895

NO.	PLATE	NAME
8777	7896	Shuttle (inside) Cylinder Hinge Pin
43239	7816	" " " " Latch
43236	7816	" " " " Hinge Pin
19869	7892	" " " " Spring
43240	7817	" " " " Frame
43255	—	" " " " 43240 with 19869, 43236 and 43239
1323F	7892	Shuttle (inside) Tension Regulating Screw
8895	7892	" " " " Spring
43275	7816	Shuttle (inside cylinder) 4 in. diam., com- plete, for 1 in. and 1½ in. gauges, Nos. 8777, 16901, 43255 and 43286
16901	7892	Shuttle (inside) Bobbin
43273	7871	" " " " Centre Pin
58357	7843	" " " " Cylinder with 43273
58405	—	" " " " 58357 with 1323F and 8895
8777	7896	Shuttle (inside) Cylinder Hinge Pin
8893	7892	" " " " Latch Spring
330b	4478	" " " " " " " Screw
8894	7893	Shuttle (inside) Frame
43250	—	" " " " 8894 with 330b and 8893
1323F	7892	Shuttle (inside) Tension Regulating Screw
8895	7892	" " " " Spring
58358	7843	Shuttle (inside, cylinder) 4 in. diam., com- plete, for 1¼ in. to 1½ in. gauges, Nos. 8777, 16901, 43250 and 58405
16901	7892	Shuttle (outside) Bobbin
43273	7871	" " " " Centre Pin
43282	7818	" " " " Cylinder with 43273
43287	—	" " " " 43282 with 1323F and 8900
8777	7896	Shuttle (outside) Cylinder Hinge Pin
43235	7818	" " " " Latch
43236	7816	" " " " " " " Pin
19869	7892	Shuttle (outside) Cylinder Latch Spring
43242	7819	" " " " Frame
1323F	7892	" " " " Tension Regulating Screw
8900	7892	Shuttle (outside) Tension Spring
43283	7818	Shuttle (outside, cylinder) 4 in. diam., complete, for 1 in. and 1½ in. gauges, Nos. 8777, 16901, 19869, 43235, 43236, 43242 and 43287

NO.	PLATE	NAME
16901	7892	Shuttle (outside) Bobbin.....
43273	7871	" " " Centre Pin.....
58359	7844	" " " Cylinder with 43273....
58403	—	" " " " 58359 with 1323F and 8780.....
8777	7896	Shuttle (outside) Cylinder Hinge Pin....
8778	7892	" " " " Latch Spring
330D	4478	" " " " " "
		Screw.....
8779	7893	Shuttle (outside) Frame.....
43249	—	" " " " 8779 with 330D and 8778.....
1323F	7892	Shuttle (outside) Tension Regulating Screw.....
8780	7892	Shuttle (outside) Tension Spring.....
58360	7844	Shuttle (outside, cylinder) 4 in. diam., complete, for 1¼ in. to 1½ in. gauges, Nos. 8777, 16901, 43249 and 58403....
19774	7894	Shuttle Driver with 445c for 1 in. and 1½ in. gauges.....
58361	7845	Shuttle Driver with 445c, for 1¼ in., 1½ in. and 1½ in. gauges.....
8055	7892	Shuttle Driver Pin.....
445C	4478	" " " Set Screw.....
19775	—	" " " Race Body.....
19776	4408	" " " " Ring (inside).....
19777	4408	" " " " " (outside).....
134D	4465	" " " " " Screw.....
19778	—	Shuttle Race complete, for 1 in. and 1½ in. gauges, Nos. 19775 to 19777 and six 134c.....
58362	—	Shuttle Race Body.....
58363	7842	" " " " Ring (inside).....
58364	7842	" " " " " (outside).....
134D	4465	" " " " " Screw.....
58365	7845	Shuttle Race complete, for 1¼ in. to 1½ in. gauges, Nos. 58362 to 58364 and six 134d.....
58277	7896	Shuttle Race Dowel Pin.....
123D	7896	" " " " " Screw.....
11241	7895	Tension Friction Washer (cloth) large....
8879	7895	" " " " " small....
19684	7895	" " " " " (steel).....
1535E	7895	" " " " " Regulating Thumb Nut.....
8787	7895	" " " " " " Washer.....
709D	7895	" " " " " " Screw Stud.....
19685	7895	" " " " " " Flange.....

NO.	PLATE	NAME
19686	7895	Tension Spring.....
58795	7895	" " " Wheel.....
19701	—	Tension (wheel) complete, Nos. 709D, 1535E, 8787, 11241, 19684 to 19686 and two each 8879 and 58795.....
19584	7895	Thread Eyelet (double) top of arm.....
166D	4476	" " " " " Screw.....
58503	7898	" " " " " Retaining Bracket.....
178D	7888	" " " " " " Screw.....
2102	4474	" " " " " Disc.....
1560C	4473	" " " " " Regulating Thumb Nut
637C	7889	" " " " " " Screw Stud.....
11422	7896	" " " " " " Spring.....
58504	—	Thread Retainer complete, Nos. 58503, two each 637c, 1560c, 11422 and four 2102.....
58505	7898	Thread Retainer Thread Guide.....
58412	7894	" " " " " Take-up Cam with two 434c....
8873	4475	" " " " " " Pin.....
434C	4478	" " " " " " Set Screw.....
58319	7890	" " " " " " Washer.....
58303	—	" " " " " " Lever with two 9219....
58304	7891	" " " " " " " 58303 with 1995..
58312	—	" " " " " " " 58304 with 50437D
50437D	4477	" " " " " " " Hinge Screw....
1995	4475	" " " " " " " Roller and Screw Stud with 1518E.....
1518E	4465	Thread Take-up Lever Roller and Screw Stud Nut.....
9219	7896	Thread Take-up Lever Thread Eyelet Bushing.....
11874	7897	Thread Take-up Spring.....
11875	7897	" " " " " " Regulator.....
164D	4469	" " " " " " " Screw.
164D	4469	" " " " " " " Screw.....
41544	4475	" " " " " " " Washer...
19886	7897	" " " " " " " Thread Guard...
58435	—	Throat Plate Body for 58438.....
58416	—	" " " " " " " 58421.....
58422	—	" " " " " " " 58425.....
58426	—	" " " " " " " 58429.....
58454	—	" " " " " " " 58457.....
58420	9601	" " " " " " " Needle Hole Strip for 58421
58436	7899	" " " " " " " " (left) for 58438.....
58455	9601	Throat Plate Needle Hole Strip (left) for 58457.....

NO.	PLATE	NAME
58423	9602	Throat Plate Needle Hole Strip (left) for 58425.....
58427	9602	Throat Plate Needle Hole Strip (left) for 58429.....
58437	7899	Throat Plate Needle Hole Strip (right) for 58438.....
58456	9601	Throat Plate Needle Hole Strip (right) for 58457.....
58424	9602	Throat Plate Needle Hole Strip (right) for 58425.....
58428	9602	Throat Plate Needle Hole Strip (right) for 58429.....
742F	7888	Throat Plate Needle Hole Strip Screw for 58438 and 58457.....
691F	7888	Throat Plate Needle Hole Strip Screw for 58421, 58425 and 58429.....
58438	7899	Throat Plate complete for 1 in. gauge, for 58389, Nos. 58435 to 58437 and four 742F.....
58457	9601	Throat Plate complete, for 1½ in. gauge, for 58414, Nos. 58454 to 58456 and four 742F.....
58421	9601	Throat Plate complete, for 1¼ in. gauge, for 58414, Nos. 58416, two 58420 and four 691F.....
58425	9602	Throat Plate complete, for 1¾ in. gauge, for 58415, Nos. 58422 to 58424 and four 691F.....
58429	9602	Throat Plate complete, for 1½ in. gauge, for 58415, Nos. 58426 to 58428 and four 691F.....
51062D	7888	Throat Plate Screw.....
58506	7891	Vibrating Presser Bar.....
19888	7897	" " " " Cap Bracket (lower)
11559	7897	" " " " " (upper)
612E	7897	" " " " " Screw (long).....
128E	7897	Vibrating Presser Bar Cap Bracket Screw (short).....
11509	4475	Vibrating Presser Bar Cushion (rawhide).
233D	4475	" " " " " Screw.....
681D	7897	" " " " " Hinge Screw.....
58507	7898	" " " " " Spring.....
1497D	7888	" " " " " Screw.....
19595	7899	" " " " " Foot.....
690D	7897	" " " " " Screw.....
1654C	7897	" " " " " Nut.....

ACCESSORIES

NO.	PLATE	NAME
11361	4482	Bed Bracket (left) with wood screw 1 in. No. 16.....
11360	4482	Bed Bracket (right) with wood screw 1 in. No. 16.....
507E	4476	Bed Bracket Bolt with 1515E.....
1515E	4479	" " " " Nut.....
120344	4484	Oiler (copper plated) with 120345.....
120345	4484	" Spout, 5 in. long.....
11831	4484	Screw Driver (large).....
26026	4484	" " (small).....
8908	4484	Wrench for 1520.....
8909	4484	" " " 1513, 1518, 1608, 1610 and 50323.....
8910	4484	Wrench for 1508.....
8911	4484	" " " 1503.....
23535	4484	" " " 1528 and 1547.....
25200	9604	" " " 354.....
21874	9604	" " " 50124.....
21875	9604	" " " 1646.....
17905	9604	" " " 1681.....

BOBBIN WINDER

(SWINGING AUTOMATIC, LEFT HAND)

NO.	PLATE	NAME
41894	4485	Base with 449c.....
894D	4476	" Screw.....
60213	4483	Bobbin Position Pin.....
41896	4485	Frame.....
41441	4485	" Hinge Pin.....
449C	4478	" " " Set Screw.....
4784	7896	" Oil Pad (felt).....
41897	4485	" Spring.....
43270	4486	Friction Pulley with 43271, two 448c and ten 15405.....
43271	4486	Friction Pulley Ring (leather).....
15405	7871	" " " Rivet.....
448C	4469	" " " Set Screw.....
60214	4486	Spindle.....
454C	4478	" Set Screw.....
60215	4486	" Shaft with 454c and 60213.....
60216	4486	Stop Latch.....
11107	4486	" " Hinge Pin.....
2269	4483	" " Pin.....

BOBBIN WINDER

NO.	PLATE	NAME
41899	4486	Tripping Arm with 176D.....
176D	4476	" " Clamping Screw.....
60217	4485	Bobbin Winder, Nos. 2269, 11107, 41441, 41894, 41896, 41897, 41899, 43270, 60214 to 60216 and two 4784.....
60218	7883	Bracket.....
50124D	4479	" Screw.....
9842	4475	" " Washer.....

THREAD UNWINDER PARTS

NO.	PLATE	NAME
27555	7285	Spool Pin.....
27583	7285	" Rest.....
27556	—	" " 27583 with 138B and two 27555
138B	4476	" " Set Screw.....
27557	7285	" Stand with 138B.....
2102	4474	Tension Disc.....
1560C	4473	" Regulating Thumb Nut.....
828C	4474	" Screw Stud.....
2103	4474	" Spring.....
5769	4474	" Thread Eyelet.....
17547	4474	" " Guard.....
60608	7285	Thread Guard.....
27560	7285	" " Rod, 26 in. long.....
138B	4476	" " Set Screw.....
330D	4478	" " Set Screw.....
60609	—	Thread Guard complete, Nos. 330D, 828C, 1560C, 2103, 5769, 17547, 60608 and two 2102.....
41823	7285	Thread Unwinder complete, for two large spools, Nos. 27556, 27557, 27560, 60609 and three wood screws 1½ in. No. 12..
60219	—	Bobbin Winder complete, Nos. 9842, 41823, 50124D, 60217, 60218 and three 894D.....

DRIVING ATTACHMENT

FOR 7-56 MACHINE

NO.	PLATE	NAME
58335	9606	Balance Wheel with two 354C.....
58336	—	" " 58335 with 11442, 122307, two 1402D and four 401E.....
25362	9607	Balance Wheel Ball, size ⅜ in.....
122303	—	" " " Ring.....
122304	9607	" " " 122303 with eighteen 25362.....

DRIVING ATTACHMENT

NO.	PLATE	NAME
122306	9607	Balance Wheel Ball Washer (left).....
122307	9607	" " " " (right).....
1402D	7871	" " " " " Screw
11442	7885	" " Friction Washer (paper)..
401E	4476	" " " " Screw...
354C	4479	" " Set Screw.....
8984	4482	Brake Block (wood).....
58458	9607	" " Stud.....
1036C	9607	" " " Set Screw.....
11440	9606	Friction Pulley, 7 in. diam., 1½ in. face, with 448C and 11441.....
11441	4483	Friction Pulley Centre Bearing.....
448C	4469	" " Set Screw.....
58459	9606	Lever with 1036C.....
58460	—	" 58459 with 134D, 8984, 8991, 8992, 58458, 58462 and two 497E.....
58462	9605	Lever Bracket.....
497E	4479	" " Bolt with 1522E.....
1522E	4479	" " " Nut.....
134D	4465	" Screw.....
8991	4482	" " Washer.....
8992	4482	" Spring.....
14785	4482	" " Hook (for machine on top of table).....
19863	4482	Lever Spring Hook (for machine flush with table).....
1520E	4479	Lever Spring Hook Nut.....
6055	4483	" " " " Washer.....
9091	9606	Shaft Driving Pulley (sectional) 10 in. diam. 1½ in. face, 1⅜ in. bore, with two 597C.....
597C	4479	Shaft Driving Pulley Clamping Screw....
126036	9606	Treadle.....
126037	—	" 126036 with 2718R, 50581R and 126038.....
126205	9604	Treadle Bracket (left).....
126207	7871	" " " Hook.....
23258	7871	" " " " Friction Washer.....
126208	7871	Treadle Bracket (left) Hook Rivet.....
126206	—	Treadle Bracket (left) complete, Nos. 23258, 126205, 126207, 126208 and two wood screws 1 in. No. 14.....
46681	9604	Treadle Bracket (right).....
60502	—	" " " 46681 with two wood screws 1 in. No. 14.....
126038	9605	Treadle Extension.....

DRIVING ATTACHMENT

NO.	PLATE	NAME
50581R	7896	Treadle Extension Screw.....
2718R	4465	" " " Washer.....
60858	9604	" Hanging Hook.....
27639	9605	Treadle Pitman Rod.....
9079	4483	" " " Clamp with 354C....
354C	4479	" " " " Screw.....
60626	9605	Treadle Pitman complete, Nos. two each 9079 and 27639.....
126211	—	Treadle complete, Nos. 60502, 126037 and 126206.....
126212	—	Treadle and Pitman complete, Nos. 60626, 60858 and 126211.....
58509	—	Driving Attachment complete, Nos. 1520E, 6055, 9091, 11440, 14785, 58336, 58460, 122304, 122306 and 126212.....

DRIVING ATTACHMENT

FOR 7-57 MACHINE

This Driving Attachment is the same as No.
58380, with the following exceptions:

NO.	PLATE	NAME
58461	—	Lever 58459 with 134B, 8984, 8991, 8992, 58458, 58465 and two 497E, in place of 58460.....
58465	9605	Lever Bracket, in place of 58462.....
58510	—	Driving Attachment complete, Nos. 1520E, 6055, 9091, 11440, 14785, 58336, 58461, 122304, 122306 and 126212, in place of 58380.....

STEEL WORK

FOR TABLE NO. 29716

NO.	PLATE	NAME
126611	7880	Brace (table) with 1¼ in. No. 12 F. H. B. wood screw.....
27022	9605	Journal Box with 27029, 27030, 41157, 41158 and two 121E.....
*41157	—	Journal Box Bottom.....
*41158	—	" " Top.....
27121	9606	" " Bracket, 6 in. drop, with 421E and 1507J.....
839R	7873	Journal Box Bracket Bolt with 1522E....
1522E	4479	" " " " Nut.....

STEEL WORK

NO.	PLATE	NAME
12620	7888	Journal Box Bracket Bolt Nut Washer..
126504	9605	" " Hanger Bracket.....
51057R	7873	" " " " Bolt with 1522E.....
1522E	4479	Journal Box Hanger Bracket Bolt Nut
12620	7888	" " " " " "
		Washer.....
126509	7871	Journal Box Hanger Bracket Bolt Socket Washer.....
126917	9604	Journal Box Hanger Bracket Reinforcing Plate.....
126505	—	Journal Box Hanger Bracket complete, Nos. 839R, 27022, 27121, 51057R, 126504, 126509, 126917 and two 12620.....
27029	4483	Journal Box Oil Feeder (felt).....
27030	9605	" " " Reservoir.....
121E	7898	" " Screw.....
421E	7898	" " Set Screw.....
1507J	7888	" " " " Nut.....
126508	7880	Leg.....
51057	7873	" Bolt with 1522E.....
1522E	4479	" " Nut.....
12620	7888	" " " Washer.....
126509	7871	" " " Socket Washer.....
126512	7880	" Cross Member, 25¼ in. long.....
51057	7873	" " " Bolt with 1522E.....
1522E	4479	" " " " Nut.....
12620	7888	" " " " " Washer....
126509	7871	" " " " " Socket Washer.....
51038R	7873	Leg Foot Screw.....
9842R	4475	" " " Washer.....
126514	—	Leg with Rail complete, Nos. 126512, 126516, two 126508 and four each 9842R, 12620, 51038R, 51057 and 126509.....
27061	9605	Pulley (sectional) 6 in. diam., 1¼ in. face, 1⅜ in. bore, with two 597C.....
597C	4479	Pulley Clamping Screw.....
126516	7880	Rail, 32½ in. long.....
27108	9604	Shaft Collar with 432C.....
432C	7888	" " Set Screw.....
—	—	Four feet two inches of 1⅜ in. shafting..
—	—	Thirteen feet of 1 in. flat belting.....
126620	—	Steel Work complete, Nos. 27061, two each 27108, 126505, 126514, 126611, four feet two inches of 1⅜ in. shafting and thirteen feet of 1 in. flat belting...

TABLE BELT GUIDE

FOR FLAT BELT FOR NO. 29716 TABLE

NO.	PLATE	NAME
58263	9605	Bracket with 448c.....
58264	9605	Pulley.....
58265	9604	" Shaft with 58266 and 58267.....
58266	—	" " Oil Hole Plug.....
58267	—	" " Packing Wick.....
448c	4469	" " Set Screw.....
58268	—	Table Belt Guide complete, Nos. 58264, 58265, two 58263 and eight wood screws 1½ in. No. 14 R. H. B.....

THREAD UNWINDER

FOR THREE SPOOLS FOR 7-57 MACHINE

NO.	PLATE	NAME
225389	7165	Spool Rest (for one spool) with 201018c..
225395	7165	" " (for two spools) with 201018c
225388	7165	" " Rod.....
200383c	7898	" " Set Screw.....
201018c	7898	" " Set Screw.....
202490	7165	" Stand with 200383c.....
225391	7165	Thread Guide.....
201696j	7898	" " Lock Nut.....
225392	7165	" " Rod with 208e and 225393
208e	7898	" " Screw.....
225393	7898	" " Washer.....
225397	7165	Thread Unwinder complete, Nos. 201696j, 202490, 225388, 225389, 225392, 225395, three each 225391 and wood screws ¾ in. No. 12.....
27739	7234	Thread Cone (wood) for large cones.
225390	7234	" " Holder, for inverted cones..

NOTE: Nos. 27739 and 225390 are used with,
but not included in 225397

TRIMMINGS FOR TABLE No. 29716

NO.	PLATE	NAME
126447	9606	Bridle Iron (left) with four each 41125 and 51080e.....
126448	9606	Bridle Iron (right) with four each 41125 and 51080e.....
51080e	7873	Bridle Iron Bolt with 51578e.....
51578e	7873	" " " Nut.....
41125	4483	" " " Washer.....
120501	7871	Table Clamp.....
51092p	7873	" " Bolt with 1600e.....
126612	—	" " " 51092p with 126079 and 126501.....
1600e	7873	Table Clamp Bolt Nut.....
126079	7871	" " " " Lock Washer....

SINGER Needles should be used
in **SINGER** Machines
These Needles and their Containers
are marked with the
Company's Trade Mark "SIMANCO.***" 1

Needles in Containers marked
"FOR SINGER MACHINES"
are **NOT SINGER** made needles. 2

NUMERICAL LIST OF PARTS

NO. PLATE	NAME
16D 4477	Lifting Presser Bar Lifter Hinge Screw for 7-56 Machine.....
116D 4476	Shuttle Race Frame Clamping Screw for 7-56 Machine.....
121E 7898	Journal Box Screw for 27022.....
122D 4473	Tension Screw Stud Clamping Screw for 11501.....
123D 7896	Shuttle Race Screw for 7-57 Machine....
128E 7897	Vibrating Presser Bar Cap Bracket Screw (short) for 7-57 Machine.....
129D 7888	Needle Bar Connecting Stud Clamping Screw for 19565.....
130D 7896	Feed Roll (upper) Supporting Bracket Screw for 7-57 Machine.....
134D 4465	Feed Lifting Rock Shaft Wearing Block Screw for 9225 and 58390.....
134D 4465	Oil Cup Screw.....
134D 4465	Shuttle Race Screw for 7-56 Machine....
134D 4465	“ “ Ring Screw for 19778 and 58365.....
134D 4465	Driving Attachment Lever Screw for 58460 and 58461.....
138B 4476	Thread Unwinder Spool Rest Set Screw for 27556.....
138B 4476	Thread Unwinder Thread Guard Set Screw for 27557.....
141F 4476	Lifting Presser Bar Rock Shaft Eccentric Strap Adjusting Screw for 11486.....
145F 4473	Cloth Plate Screw for 7-57 Machine.....
145D 4473	Lifting Presser Bar Bracket Clamping Screw for 11478.....
145F 4473	Tension Bracket and Vibrating Presser Bar Cap Screw (right) for 7-56 Machine
145D 4473	Vibrating Presser Bar Hinge Bracket Adjusting Screw for 11510.....
155C 7896	Feed Roll (upper) Set Screw for 58483 and 58484.....
159F 4473	Tension Bracket and Vibrating Presser Bar Cap Screw (left) for 7-56 Machine
161D 7890	Face Plate Screw for 7-57 Machine.....
162D 7896	Feed Roll (upper) Spring Strap Screw for 58492 and 58493.....
164D 4469	Face Plate Thread Guard Screw for 58452

NUMERICAL LIST OF PARTS

NO. PLATE	NAME
164D 4469	Lifting Presser Bar Bell Crank Connecting Stud Cap Screw for 11527.....
164D 4469	Oscillating Shaft Crank Slide Block Cap Screw for 19773.....
164D 4469	Thread Take-up Spring Regulator Screw for 58452.....
164D 4469	Thread Take-up Spring Screw for 58452.....
164D 4469	Vibrating Presser Bar Hinge Cap Screw for 7-56 Machine.....
166D 4476	Feed Dog Screw for 7-56 Machine.....
166D 4476	Lifting Presser Bar Bell Crank Hinge Cap Screw for 7-56 Machine.....
166D 4476	Lifting Presser Bar Lifting Link Cap Screw for 7-56 Machine.....
166D 4476	Thread Eyelet Screw for 7-57 Machine...
176D 4476	Bobbin Winder Tripping Arm Clamping Screw for 41899.....
177D 7890	Feed Dog Screw for 7-57 Machine.....
178D 7888	Thread Retaining Bracket Screw for 58493
190D 4468	" Eyelet (side of arm) Screw for 7-56 Machine.....
190D 4468	Thread Take-up Spring Regulating Plate Adjusting Screw for 11501.....
190D 4468	Vibrating Presser Bar Spring Adjusting Staple Screw for 7-56 Machine.....
191F 7888	Needle Set Screw for 19733, 19734, 58355 and 58356.....
207F 4468	Oil Cup Cover Latch Spring Screw for 58254.....
207F 4468	Oil or Wax Stripper Washer Screw for 58254.....
208E 7898	Thread Unwinder Thread Guide Rod Screw for 225392.....
223D 4475	Vibrating Presser Bar Spring Screw for 7-56 Machine.....
227D 7896	Feed Roll (lower) Wheel Cover Screw for 58480.....
231F 4476	Throat Plate Needle Plate Screw for 19858
233D 4475	Vibrating Presser Bar Cushion Screw....
257E 7889	Needle Bar Screw Bushing for 7-57 Machine.....
258E 4477	Lifting Presser Bar Screw Bushing for 7-56 Machine.....
258E 4477	Needle Bar Screw Bushing for 7-56 Machine.....
294c 4478	Feed Lifting Rock Shaft Screw Centre (right).....

NUMERICAL LIST OF PARTS

NO. PLATE	NAME
294c 4478	Feed Rock Shaft Screw Centre.....
307c 7890	" Bar Screw Centre for 7-57 Machine
330D 4478	Shuttle (inside) Cylinder Latch Spring Screw for 43250.....
330D 4478	Shuttle (outside) Cylinder Latch Spring Screw for 43249.....
330D 4478	Thread Unwinder Thread Guard Set Screw for 60609.....
346E 4465	Feed Lifting Rock Shaft Crank Clamping Screw for 19819.....
346E 4465	Feed Rock Shaft Crank Clamping Screw for 58235.....
354c 4479	Balance Wheel Set Screw for 58335.....
354c 4479	Driving Attachment Balance Wheel Set Screw for 58335.....
354c 4479	Driving Attachment Treadle Pitman Rod Clamp Screw for 9079.....
372c 7888	Lifting Presser Bar Bell Crank Adjusting Link Roller Screw for 1828.....
381D 4476	Throat Plate Screw for 7-56 Machine....
389F 4476	Cloth Plate Screw for 7-56 Machine....
389F 4476	Throat Plate Needle Hole Strip Screw for 19855.....
401E 4476	Balance Wheel Friction Washer Screw for 58336.....
401E 4476	Driving Attachment Balance Wheel Friction Washer Screw for 58336.....
421E 7898	Journal Box Set Screw for 27121.....
432c 7888	Shaft Collar Set Screw for 27108.....
434c 4478	Thread Take-up Cam Set Screw for 11505 and 58412.....
437c 4478	Arm Shaft Bushing Set Screw.....
445c 4478	Feed Roll (upper) Shaft Bracket Hinge Pin Set Screw for 58499.....
445F 4478	Needle Bar Connecting Stud Set Screw for 11383 and 19565.....
445c 4478	Oscillating Shaft Crank Set Screw for 19770.....
445c 4478	Shuttle Driver Set Screw for 19774, 19845 and 58361.....
448c 4469	Bobbin Winder Friction Pulley Set Screw for 43270.....
448c 4469	Driving Attachment Friction Pulley Set Screw for 11440.....
448c 4469	Feed Roll (lower) Wheel Set Screw for 58481.....

NO. PLATE	NAME
448c 4469	Feed Roll (upper) Shaft Bracket Hinge Pin Set Screw for 58500.....
448c 4469	Oscillating Shaft Collar Set Screw for 9152
448c 4469	Table Belt Guide Pulley Shaft Set Screw for 58263.....
449c 4478	Bobbin Winder Frame Hinge Pin Set Screw for 41894.....
453c 4466	Feed Roll (lower) Regulator Hinge Pin Set Screw for 58469.....
453c 4466	Lifting Presser Bar Rock Shaft Adjusting Arm Set Screw for 11480.....
453c 4466	Lifting Presser Bar Rock Shaft Crank Set Screw for 11484.....
454c 4478	Bobbin Winder Spindle Set Screw for 60215.....
497E 4479	Driving Attachment Lever Bracket Bolt with 1522E, for 58460 and 58461.....
507E 4476	Bed Bracket Bolt with 1515E (Accessories)
565c 4476	Feed Connecting Link Hinge Screw.....
565c 4476	“ Forked Connection Hinge Screw....
566c 4468	Needle Bar Connecting Link Hinge Screw
568E 4477	Feed Regulator Hinge Screw.....
575E 4476	Crank Connecting Rod Cap Screw for 19758.....
597c 4479	Driving Attachment Shaft Driving Pulley Clamping Screw for 9091.....
597c 4479	Pulley Clamping Screw for 27061.....
606E 4474	Thread Retaining Screw Stud for 11503..
607E 4473	Tension Screw Stud for 12042.....
608E 4466	Lifting Presser Bar Rock Shaft Eccentric Strap Hinge Screw for 7-56 Machine...
610D 4465	Lifting Presser Bar Bell Crank Lifting Roller Screw for 1851.....
611E 7888	Lifting Presser Bar Bell Crank Adjusting Link Screw for 7-57 Machine.....
612E 7897	Vibrating Presser Bar Cap Bracket Screw (long) for 7-57 Machine.....
635c 7890	Feed Roll (lower) Shaft Bracket Adjusting Screw for 58480.....
637c 7889	Thread Retaining Screw Stud for 58504..
649D 7896	Feed Roll (upper) Spring Screw for 58492 and 58493.....
654c 4478	Oscillating Rock Shaft Hinge Pin Screw Bearing for 19790.....
660D 4477	Shuttle Race Back Spring Screw for 19849
680F 4468	Needle Clamp Thumb Screw for 19702...

NO. PLATE	NAME
681D 7897	Vibrating Presser Bar Hinge Screw for 7-57 Machine.....
690D 7897	Vibrating Presser Foot Screw for 7-57 Machine.....
691F 7888	Throat Plate Needle Hole Strip Screw for 58421, 58425 and 58429.....
692D 4479	Feed Lifting Rock Shaft Crank Clamping Screw for 19837.....
694D 7896	Feed Roll (upper) Lifting Screw for 58492 and 58493.....
709D 7895	Tension Screw Stud for 19701.....
742F 7888	Throat Plate Needle Hole Strip Screw for 58438 and 58457.....
828F 4474	Thread Unwinder Tension Screw Stud for 60609.....
832c 7890	Feed Cam Set Screw for 58472.....
839R 7873	Journal Box Bracket Bolt with 1522E, for 126505.....
840D 7890	Feed Roll (lower) Set Screw for 58473...
840D 7890	“ “ “ Shaft Bracket Screw....
851E 4473	Spool Holder Tension Spool Pin with fixed cone, for 11881.....
858c 7888	Lifting Presser Bar Bell Crank Connecting Stud Set Screw for 11526.....
872E 4479	Arm Screw for 7-56 Machine.....
885D 4477	Guide Thumb Screw.....
894D 4476	Bobbin Winder Base Screw for 60219....
898D 4476	Needle Clamp Screw for 19735 and 58354
898D 4476	Vibrating Presser Foot Screw for 7-56 Machine.....
910c 7888	Lifting Presser Bar Lifter Hinge Pin Set Screw for 58452.....
1015c 4478	Feed Lifting Rock Shaft Screw Centre (left).....
1036c 9607	Driving Attachment Brake Block Stud Set Screw for 58459.....
1129D 7890	Arm Side Cover and Feed Roll (lower) Regulator Supporting Bracket Screw...
1151c 4476	Crank Connecting Rod Hinge Screw.....
1156c 4469	Oscillating Shaft Crank Slide Block Cap Screw Stud for 19773.....
1177D 4476	Feed Roll (upper) Supporting Bracket Position Bracket Screw for 58493.....
1177D 4476	Feed Roll (upper) Supporting Bracket Screw Stud Cap Screw for 58492.....
1177D 4476	Lifting Presser Bar Spring Bracket Screw

NO.	PLATE	NAME
1177D	4476	Spool Holder Bracket Screw for 7-56 Machine
1259c	4478	Lifting Presser Foot Set Screw for 58260 and 58261
1323F	7892	Shuttle Tension Regulating Screw for 43288
1323F	7892	Shuttle (inside) Tension Regulating Screw for 43286 and 58405
1323F	7892	Shuttle (outside) Tension Regulating Screw for 43287 and 58403
1396D	7888	Feed Roll (upper) Lifting Lever Clamping Screw for 58485
1401c	7896	Feed Roll (upper) Spring Adjusting Screw for 58492 and 58493
1402D	7871	Balance Wheel Ball Washer (right) Screw for 58336
1402D	7871	Driving Attachment Balance Wheel Ball Washer (right) Screw for 58336
1487D	7890	Feed Roll (lower) Regulator Connection Hinge Screw (lower)
1497F	7888	Lifting Presser Bar Lifter Bracket Set Screw for 58237
1497D	7888	Vibrating Presser Bar Spring Screw for 7-57 Machine
1503E	4478	Feed Lifting Rock Shaft Screw Centre (left) Nut
1503E	4478	Feed Lifting Rock Shaft Screw Centre (right) Nut
1503E	4478	Feed Rock Shaft Screw Centre Nut
1503E	4478	Oscillating Rock Shaft Hinge Pin Nut for 19790
1503E	4478	Oscillating Rock Shaft Hinge Pin Screw Bearing Nut for 19790
1507J	7888	Journal Box Set Screw Nut for 27121
1508E	4469	Oscillating Shaft Crank Slide Block Cap Screw Stud Nut for 19789
1513J	4479	Feed Bar Screw Centre Nut
1513J	4479	" Connecting Link Hinge Screw Nut
1513J	4479	" Forked Connection Hinge Screw Nut
1513c	4479	" Roll (lower) Shaft Bracket Adjusting Screw Nut for 58480
1513J	4479	Needle Bar Connecting Link Hinge Screw Nut
1515E	4479	Bed Bracket Bolt Nut for 507
1518E	4465	Lifting Presser Bar Bell Crank Adjusting Link Roller Screw Nut for 11525

NO.	PLATE	NAME
1518E	4465	Lifting Presser Bar Bell Crank Lifting Roller Screw Nut for 7-56 Machine
1518D	4465	Lifting Presser Bar Rock Shaft Eccentric Strap Hinge Screw Nut for 7-56 Machine
1518E	4465	Thread Take-up Lever Roller and Screw Stud Nut for 1995
1520E	4479	Driving Attachment Spring Hook Nut for 58509 and 58510
1522E	4479	Driving Attachment Lever Bracket Bolt Nut for 497
1522E	4479	Journal Box Bracket Bolt Nut for 839
1522E	4479	" " Hanger Bracket Bolt Nut for 51057
1522E	4479	Leg Bolt Nut for 51057
1522E	4479	" Cross Member Bolt Nut for 51057
1528D	4479	Lifting Presser Bar Rock Shaft Eccentric Strap Adjusting Screw Nut for 11486
1535E	7895	Tension Regulating Thumb Nut for 19701
1541E	4473	Spool Holder Tension Spool Pin Nut for 11881
1547D	4479	Vibrating Presser Foot Screw Nut for 7-56 Machine
1560c	4473	Tension Regulating Thumb Nut for 12042
1560c	4473	Thread Retaining Regulating Thumb Nut for 11503 and 58504
1560c	4473	Thread Unwinder Tension Regulating Thumb Nut for 60609
1583E	7888	Lifting Presser Bar Bell Crank Hinge Screw Nut for 7-57 Machine
1600E	7873	Table Clamp Bolt Nut for 51092
1608c	7896	Feed Roll (upper) Supporting Bracket Screw Stud Lock Nut for 58492
1610c	7890	Feed Roll (lower) Regulator Connection Screw Stud (upper) Nut
1646E	4479	Crank Connecting Rod Hinge Screw Nut
1654c	7897	Vibrating Presser Foot Screw Nut for 7-57 Machine
1681c	7896	Feed Roll (upper) Spring Adjusting Screw Nut for 58492 and 58493
1828	7888	Lifting Presser Bar Bell Crank Adjusting Link Roller with 372c, for 11525
1850	4466	Lifting Presser Bar Rock Shaft Crank Roller and Stud for 11484
1851	4465	Lifting Presser Bar Bell Crank Lifting Roller with 610D, for 7-56 Machine

NUMERICAL LIST OF PARTS

NO.	PLATE	NAME
1861	4475	Feed Lifting Rock Shaft Crank Roller and Stud for 19819 and 19837.....
1995	4475	Thread Take-up Lever Roller and Screw Stud with 1518e, for 58304 and 58332.
2002	7896	Feed Roll (upper) Supporting Bracket Dowel Pin for 7-56 Machine.....
2022	4465	Feed Lifting Rock Shaft Wearing Block Position Pin for 9225 and 58390.....
2049	4475	Shuttle Race Back Position Pin for 19849
2102	4474	Thread Retaining Disc for 11503 and 58504.....
2102	4474	Thread Unwinder Tension Disc for 60609
2103	4474	" Retaining Spring for 11503.....
2103	4474	" Unwinder Tension Spring for 60609.....
2117	4475	Lifting Presser Bar Rock Shaft Adjusting Arm Pin for 7-56 Machine.....
2117	4475	Lifting Presser Bar Rock Shaft Crank Pin for 7-56 Machine.....
2205	4468	Oil Cup Cover Latch Spring for 58254....
2269	4483	Bobbin Winder Stop Latch Pin for 60217
2718r	4465	Driving Attachment Treadle Extension Screw Washer for 126037.....
2718	4465	Lifting Presser Bar Bell Crank Adjusting Link Roller Screw Nut Washer for 11525
2718	4465	Lifting Presser Bar Bell Crank Lifting Roller Screw Nut Washer for 7-56 Machine.....
4784	7896	Bobbin Winder Frame Oil Pad (felt) for 60217.....
5769	4474	Thread Unwinder Tension Thread Eyelet for 60609.....
5983	4473	Tension Friction Washer (felt) for 12042.
6055	4483	Driving Attachment Lever Spring Hook Nut Washer for 58509 and 58510.....
8018	4473	Spool Holder Tension Spool Pin Cone for 11881.....
8019	4473	Spool Holder Tension Spool Pin Spring for 11881.....
8055	7892	Shuttle Driver Pin for 7-57 Machine.....
8482	4468	Oil or Wax Stripper Washer (steel) for 58253, for 58254.....
8582	7896	Feed Roll (lower) Shaft Bracket Dowel Pin.....
8702	4475	Arm Dowel Pin.....
8760	4465	Lifting Presser Bar Lifter Friction Washer for 7-56 Machine.....

NUMERICAL LIST OF PARTS

NO.	PLATE	NAME
8761	4465	Lifting Presser Bar Lifter Stop Pin for 11909.....
8763	4465	Lifting Presser Bar Lifting Link Hinge Stud for 11909.....
8777	7896	Shuttle Cylinder Hinge Pin for 58323....
8777	7896	" (inside) Cylinder Hinge Pin for 43275 and 58358.....
8777	7896	Shuttle (outside) Cylinder Hinge Pin for 43283 and 58360.....
8778	7892	Shuttle (outside) Cylinder Latch Spring for 43249.....
8779	7893	Shuttle (outside) Frame for 43249.....
8780	7892	" " Tension Spring for 58403
8787	7895	Tension Regulating Thumb Nut Washer for 19701.....
8791	4474	Tension Spring for 12042.....
8873	4475	Shuttle Driver Pin for 7-56 Machine.....
8873	4475	Thread Take-up Cam Pin.....
8879	7895	Tension Friction Washer (cloth) small, for 19701.....
8893	7892	Shuttle (inside) Cylinder Latch Spring for 43250.....
8894	7893	Shuttle (inside) Frame for 43250.....
8895	7892	" " Tension Spring for 43286 and 58405.....
8900	7892	Shuttle (outside) Tension Spring for 43287
8905	4473	Tension Regulating Thumb Nut Washer for 12042.....
8905	4473	Thread Retaining Regulating Thumb Nut Washer for 11503.....
8908	4484	Wrench for 1520 (Accessories).....
8909	4484	" " 1513, 1518, 1608, 1610 and 50323 (Accessories).....
8910	4484	Wrench for 1508 (Accessories).....
8911	4484	" " 1503 (Accessories).....
8953	4468	Oil or Wax Stripper (felt) for 58254.....
8973	4465	Lifting Presser Bar Lifting Link Hinge Stud Pin for 7-56 Machine.....
8984	4482	Driving Attachment Brake Block (wood) for 58460 and 58461.....
8991	4482	Driving Attachment Lever Screw Washer for 58460 and 58461.....
8992	4482	Driving Attachment Lever Spring for 58460 and 58461.....
9079	4483	Driving Attachment Treadle Pitman Rod Clamp with 354c, for 60626.....
9084	4468	Oil Cup Cover Hinge Pin for 58254.....

NO.	PLATE	NAME
9091	9606	Driving Attachment Shaft Driving Pulley (sectional) 10 in. diam., 1½ in. face, 1⅞ in. bore, with two 597c, for 58509 and 58510.
9115	4461	Oscillating Rock Shaft Hinge Pin for 19790.
9121	4472	Shuttle Race Slide (left) for 19858, for 7-56 Machine.
9122	4472	Shuttle Race Slide (right) for 19858, for 7-56 Machine.
9152	4469	Oscillating Shaft Collar with 448c.
9219	7896	Thread Take-up Lever Thread Eyelet Bushing for 58303 and 58332.
9225	4461	Feed Lifting Rock Shaft with 134d, 2022 and 19967, for 58288.
9525	4474	Thread Take-up Spring Staple Washer for 11501.
9842	4475	Arm Shaft Screw Washer for 7-57 Machine
9842	4475	Bobbin Winder Bracket Screw Washer for 60219.
9842R	4475	Leg Foot Screw Washer for 126514.
11031	7883	Lifting Presser Bar Spring (flat) for 7-57 Machine.
11044	4474	Tension Wheel for 12042.
11107	4486	Bobbin Winder Stop Latch Hinge Pin for 60217.
11165	4469	Oscillating Rock Shaft Oil Pad for 19790.
11241	7895	Tension Friction Washer (cloth) large, for 19701.
11354	4463	Arm Shaft Bushing.
11360	4482	Bed Bracket (right) with wood screws 1 in. No. 16 (Accessories).
11361	4482	Bed Bracket (left) with wood screw 1 in. No. 16 (Accessories).
11365	4464	Feed Bar for 7-56 Machine.
11368	4465	" Connecting Link.
11375	4464	" Regulator.
11383	4468	Needle Bar Connecting Stud with two 445r, for 19981.
11385	4468	Needle Clamp Gib for 19702.
11422	7896	Thread Retaining Spring for 58504.
11423	4473	Tension Friction Washer (steel) for 12042
11424	4474	Thread Eyelet for 11502.
11440	9606	Driving Attachment Friction Pulley, 7 in. diam., 1½ in. face, with 448c and 11441, for 58509 and 58510.

NO.	PLATE	NAME
11441	4483	Driving Attachment Friction Pulley Centre Bearing for 11440.
11442	7885	Balance Wheel Friction Washer (paper) for 58336.
11442	7885	Driving Attachment Balance Wheel Friction Washer (paper) for 58336.
11476	850	Lifting Presser Bar Bell Crank for 7-56 Machine.
Nos. 11478 TO 11480 FOR 7-56 MACHINE		
11478	850	Lifting Presser Bar Bracket with two 145d
11479	4466	" " " Rock Shaft.
11480	850	" " " " " Adjusting Arm with 453c.
11484	4466	Lifting Presser Bar Rock Shaft Crank with 453c and 1850, for 7-56 Machine.
Nos. 11486 TO 11493 FOR 7-56 MACHINE		
11486	850	Lifting Presser Bar Rock Shaft Eccentric Strap with two each 141f and 1528d.
11487	4466	Lifting Presser Bar Rock Shaft Eccentric Strap Hinge Screw Slide.
11488	4466	Lifting Presser Bar Rock Shaft Eccentric Strap Hinge Screw Slide Washer.
11489	4466	Lifting Presser Bar Sleeve (lower).
11490	4466	" " " " (upper) for 11491.
11491	---	Lifting Presser Bar Sleeve (upper) 11490 with 11492.
11492	4466	Lifting Presser Bar Sleeve (upper) Cap for 11491.
11493	4461	Lifting Presser Bar Spring (flat).
11495	4468	Thread Eyelet (side of arm) for 7-56 Machine.
11501	---	Tension Bracket and Vibrating Presser Bar complete for 7-56 Machine, Nos. 122d, 9525, 11502, 11506, 11936, 11937, 12042 and two 190d.
11502	4473	Tension Bracket and Vibrating Presser Bar Cap with 11424, for 11501.
11503	---	Thread Retainer complete for 7-56 Machine, Nos. 606r, 1560c, 2103, 8905 and two 2102.
11505	4461	Thread Take-up Cam with two 434c, for 7-56 Machine.
11506	4474	Thread Take-up Spring for 11501.

NUMERICAL LIST OF PARTS

NO.	PLATE	NAME
11508	850	Vibrating Presser Bar for 7-56 Machine..
11509	4475	“ “ “ Cushion (rawhide)
11510	850	“ “ “ Hinge Bracket with 145D, for 7-56 Machine.....
11512	4475	Vibrating Presser Bar Spring for 7-56 Machine.....
11523	7894	Lifting Presser Bar Bell Crank for 7-57 Machine.....
11524	7894	Lifting Presser Bar Bell Crank Adjusting Link for 11525.....
11525	—	Lifting Presser Bar Bell Crank Adjusting Link complete, for 7-57 Machine, Nos. 1518E, 1828, 2718 and 11524.....
11526	7888	Lifting Presser Bar Bell Crank Connecting Stud with two 858c, for 11527.....
11527	—	Lifting Presser Bar Bell Crank Connecting Stud complete for 7-57 Machine, Nos. 164D, 11526 and 11528.....
11528	7888	Lifting Presser Bar Bell Crank Connecting Stud Cap Screw Washer for 11527.....
11538	4464	Needle Bar for 7-56 Machine.....
11539	4468	“ “ Connecting Link for 19981...
11559	7897	Vibrating Presser Bar Cap Bracket (upper) for 7-57 Machine.....
11661	7888	Lifting Presser Bar Spring Guide Pin....
11831	4484	Screw Driver, large (Accessories).....
11838	4475	Shuttle Race Frame Position Pin for 19850
11874	7897	Thread Take-up Spring for 58452.....
11875	7897	“ “ “ Regulator for 58452.....
11881	—	Spool Holder Tension Spool Pin complete for 58256, Nos. 851E, 1541E, 8018 and 8019.....
11907	4463	Lifting Presser Bar Lifting Link for 7-56 Machine.....
11909	4464	Lifting Presser Bar Lifter with 8761 and 8763, for 7-56 Machine.....
11917	—	Oil Cup Cover for 58254.....
11918	4468	“ or Wax Stripper Washer (steel) for 11917, for 58254.....
11936	4474	Thread Take-up Spring Regulating Plate for 11501.....
11937	4474	Thread Take-up Spring Staple for 11501.
11939	4475	Vibrating Presser Bar Spring Adjusting Staple for 7-56 Machine.....
11950	4474	Thread Eyelet for 11503, for 7-56 Machine

NUMERICAL LIST OF PARTS

NO.	PLATE	NAME
12042	—	Tension Wheel complete for 11501, Nos. 607E, 1560c, 8791, 8905, 11044, 11423 and two 5983.....
12620	7888	Journal Box Bracket Bolt Nut Washer for 126505.....
12620	7888	Journal Box Hanger Bracket Bolt Nut Washer for 126505.....
12620	7888	Leg Bolt Nut Washer for 126514.....
12620	7888	Leg Cross Member Bolt Nut Washer for 126514.....
14129	7890	Feed Roll (lower) Regulator Connection Screw Stud (upper) Nut Washer.....
14785	4482	Driving Attachment Lever Spring Hook (for machine on top of table) for 58509 and 58510.....
15405	7871	Bobbin Winder Friction Pulley Ring Rivet for 43270.....
16901	7892	Shuttle Bobbin for 58323.....
16901	7892	“ (inside) Bobbin for 43275 and 58358.....
16901	7892	Shuttle (outside) Bobbin for 43283 and 58360.....
17547	4474	Thread Unwinder Tension Thread Guard for 60609.....
17905	9604	Wrench for 1681 (Accessories).....
19564	7889	Needle Bar Connecting Link for 58203...
19565	7889	Needle Bar Connecting Stud with 129D and 445F, for 58203.....
19583	7890	Face Plate Thread Eyelet for 58452.....
19584	7895	Thread Eyelet (double) top of arm, for 7-57 Machine.....
19590	7890	Face Plate Thread Guard for 58452.....
19595	7899	Vibrating Presser Foot for 7-57 Machine Nos. 19684 to 19686 for 19701
19684	7895	Tension Friction Washer (steel).....
19685	7895	“ Screw Stud Flange.....
19686	7895	“ Spring.....
19701	—	Tension (wheel) complete for 58452, Nos. 709D, 1535E, 8787, 11241, 19684 to 19686 and two each 8879 and 58795...
19702	4468	Needle Clamp with 680F and 11385, for 7-56 Machine.....
Nos. 19732 to 19734 for 19735		
19732	7891	Needle Bar.....
19733	7889	“ Clamp (left) with 191F.....

NO.	PLATE	NAME
19734	7889	Needle Clamp (right) with 191F.....
19735	—	Needle Bar complete with adjustable clamps, for 1 in. and 1½ in. gauges, for 7-57 Machine, Nos. 19732 to 19734 and two 898D.....
19758	4462	Crank Connecting Rod with 19759 and two 575E.....
*19759	—	Crank Connecting Rod Cap for 19758...
19762	4461	Feed Forked Connection.....
19768	4461	Oscillating Rock Shaft for 19790.....
19769	7883	" Shaft for 7-57 Machine.....
19770	—	" " Crank with 445c, for 19789.....
19771	4469	Oscillating Shaft Crank Slide Block for 19773.....
19772	4469	Oscillating Shaft Crank Slide Block Cap Screw Washer for 19773.....
19773	4469	Oscillating Shaft Crank Slide Block complete for 19789, Nos. 164D, 1156c, 19771 and 19772.....
19774	7894	Shuttle Driver with 445c, for 1 in. and 1½ in. gauges, for 7-57 Machine.....
Nos. 19775 to 19777 FOR 19778		
19775	—	Shuttle Race Body.....
19776	4408	" " Ring (inside).....
19777	4408	" " " (outside).....
19778	—	Shuttle Race complete, for 1 in. and 1½ in. gauges, for 7-57 Machine, Nos. 19775 to 19777 and six 134D.....
19789	4469	Oscillating Shaft Crank complete, Nos. 1508E, 19770 and 19773.....
19790	—	Oscillating Rock Shaft complete, Nos. 654c, 9115, 11165, 19768 and two 1503E.....
19819	7894	Feed Lifting Rock Shaft Crank with 346E and 1861, for 58391.....
19834	4436	Feed Dog (double) for 7-56 Machine.....
19835	4437	" " (single) for 7-56 Machine.....
19837	4463	" Lifting Rock Shaft Crank with 692D and 1861, for 58288.....
19842	4461	Oscillating Shaft for 7-56 Machine.....
19845	4472	Shuttle Driver with 445c, for 7-56 Machine
Nos. 19846 to 19848 FOR 19849		
19846	4441	Shuttle Race Back.....
19847	4441	" " " Spring.....

NO.	PLATE	NAME
19848	—	Shuttle Race Back Body.....
19849	4441	Shuttle Race complete for 7-56 Machine, Nos. 660D, 19846 to 19848 and two 2049
19850	4462	Shuttle Race Frame with 11838, for 7-56 Machine.....
19853	—	Throat Plate Body for 19855.....
19854	4436	" " Needle Hole Strip for 19855
19855	4436	Throat Plate complete for 19834, for 7-56 Machine, Nos. 19853, 19854 and two 389F.....
19856	—	Throat Plate Body for 19858.....
19857	4437	" " Needle Plate for 19858.....
19858	4437	Throat Plate complete for 19835, for 7-56 Machine, Nos. 231F, 19856 and 19857
19860	4467	Vibrating Presser Foot for 19834, for 7-56 Machine.....
19863	4482	Driving Attachment Lever Spring Hook (for machine flush with table) for 58380 and 58443.....
19866	7888	Lifting Presser Bar Lifting Hinge Pin for 58452.....
19869	7892	Shuttle Cylinder Latch Spring for 58272.
19869	7892	" (inside) Cylinder Latch Spring for 43255 and 43283.....
19869	7892	Shuttle (outside) Cylinder Latch Spring for 43283.....
19886	7897	Thread Take-up Spring Thread Guard for 58452.....
*19887	—	Arm Packing Plate for 7-57 Machine....
19888	7897	Vibrating Presser Bar Cap Bracket (lower) for 7-57 Machine.....
19981	—	Needle Bar Connecting Stud 11383 with 11539, for 7-56 Machine.....
19967	4465	Feed Lifting Rock Shaft Wearing Block for 9225 and 58390.....
21788	7890	Feed Roll (lower) Shaft Bracket Adjusting Screw Spring for 58480.....
21874	9604	Wrench for 50124 (Accessories).....
21875	9604	" " 1646 (Accessories).....
23258	7871	Driving Attachment Treadle Bracket (left) Hook Friction Washer for 126206.....
23535	4484	Wrench for 1528 and 1547 (Accessories)..
25200	9604	" " 354 (Accessories).....
25362	9607	Balance Wheel Ball, size ⅜ in., for 122304
25362	9607	Driving Attachment Balance Wheel Ball, size ⅜ in., for 122304.....
26026	4484	Screw Driver, small (Accessories).....

NUMERICAL LIST OF PARTS

NO.	PLATE	NAME
26176	7894	Guide (6 in. face) for 7-57 Machine.....
26419	4463	" " " " " 19858, for 7-56 Machine.....
27022	9605	Journal Box with 27029, 27030, 41157, 41158 and two 121E, for 126505.....
27029	4483	Journal Box Oil Feeder (felt) for 27022..
27030	9605	" " " Reservoir for 27022.....
27061	9605	Pulley (sectional) 6 in. diam., 1¼ in. face, 1⅜ in. bore, with two 597c, for 126620
27108	9604	Shaft Collar with 432c, for 126620.....
27121	9606	Journal Box Bracket, 6 in. drop, with 421E and 1507r, for 126505.....
27555	7285	Thread Unwinder Spool Pin for 27556...
27556	—	" " " Rest 27583 with 138B and two 27555, for 41823.....
27557	7285	Thread Unwinder Spool Stand with 138B, for 41823.....
27560	7285	Thread Unwinder Thread Guard Rod, 26 in. long, for 41823.....
27583	7285	Thread Unwinder Spool Rest for 27556..
27639	9605	Driving Attachment Treadle Pitman Rod for 60626.....
27739	7234	Thread Unwinder Thread Cone (wood) for large cones, for 225397.....
36114	4456	Guide (6 in. face) for 19855, for 7-56 Machine.....
40063	7887	Feed Roll (upper) Shaft Bracket Hinge Pin for 58493.....
41125	4483	Bridle Iron Bolt Washer for 126447 and 126448.....
*41157	—	Journal Box Bottom for 27022.....
*41158	—	" " Top for 27022.....
41441	4485	Bobbin Winder Frame Hinge Pin for 60217
41544	4475	Thread Take-up Spring Screw Washer for 58452.....
41544	4475	Vibrating Presser Bar Hinge Cap Screw Washer for 7-56 Machine.....
41823	7285	Thread Unwinder complete, for two large spools, for 60219, Nos. 27556, 27557, 27560, 60609 and three wood screws 1¼ in. No. 12.....
41894	4485	Bobbin Winder Base with 449c, for 60217
41896	4485	" " Frame for 60217.....
41897	4485	" " " Spring for 60217..
41899	4486	" " Tripping Arm with 176D, for 60217.....

NUMERICAL LIST OF PARTS

NO.	PLATE	NAME
43235	7892	Shuttle Cylinder Latch for 58272.....
43235	7892	" (outside) Cylinder Latch for 43283
43236	7816	" Cylinder Latch Hinge for 58272..
43236	7816	" (inside) Cylinder Latch Hinge Pin for 43255.....
43236	7816	Shuttle (outside) Cylinder Latch Hinge Pin for 43283.....
43239	7816	Shuttle (inside) Cylinder Latch for 43255
43240	7817	" " Frame for 43255.....
43242	7819	" (outside) Frame for 43283.....
43249	—	" " " 8779 with 330D and 8778, for 58360.....
43250	—	Shuttle (inside) Frame 8894 with 330D and 8893, for 58358.....
43255	—	Shuttle (inside) Frame 43240 with 19869, 43236 and 43239, for 43275.....
43263	9607	Arm Screw Washer for 7-57 Machine....
43267	4465	Lifting Presser Bar Lifting Link Hinge Stud Washer for 7-56 Machine.....
43270	4486	Bobbin Winder Friction Pulley with 43271, two 448c and ten 15405, for 60217....
43271	4486	Bobbin Winder Friction Pulley Ring (leather) for 43270.....
43273	7871	Shuttle Bobbin Centre Pin for 43284.....
43273	7871	" (inside) Bobbin Centre Pin for 43274 and 58357.....
43273	7871	Shuttle (outside) Bobbin Centre Pin for 43282 and 58359.....
43274	7817	Shuttle (inside) Cylinder with 43273, for 43286.....
43275	7816	Shuttle (inside) Cylinder, 4 in. diam., complete, for 1 in. and 1¼ in. gauges, for 7-57 Machine, Nos. 8777, 16901, 43255 and 43286.....
43282	7818	Shuttle (outside) Cylinder with 43273, for 43287.....
43283	7818	Shuttle (outside, cylinder) 4 in. diam., complete, for 1 in. and 1¼ in. gauges, for 7-57 Machine, Nos. 8777, 16901, 19869, 43235, 43236, 43242 and 43287.
43284	7893	Shuttle Cylinder with 43273, for 43288...
43286	—	" (inside) Cylinder 43274 with 1323F and 8895, for 43275.....
43287	—	Shuttle (outside) Cylinder 43282 with 1323F and 8900, for 43283.....
43288	—	Shuttle Cylinder 43284 with 1323F and 58209, for 58323.....

NO.	PLATE	NAME
46681	9604	Driving Attachment Treadle Bracket (right) for 60502.....
50124D	4479	Bobbin Winder Bracket Screw for 60219.
50206D	7888	Lifting Presser Bar Bell Crank Hinge Screw for 7-57 Machine.....
50322D	4477	Feed Regulator Thumb Screw.....
50323D	4479	Lifting Presser Bar Spring Regulating Thumb Screw.....
50349E	7890	Arm Screw for 7-57 Machine.....
50358C	4478	Feed Bar Screw Centre for 7-56 Machine
50372D	7890	Arm Shaft Screw for 7-57 Machine.....
50437D	4477	Thread Take-up Lever Hinge Screw for 58312 and 58333.....
50581R	7896	Driving Attachment Treadle Extension Screw for 126037.....
51038R	7873	Leg Foot Screw for 126514.....
51057R	7873	Journal Box Hanger Bracket Bolt with 1522E, for 126505.....
51057P	7873	Leg Bolt with 1522E, for 126514.....
51057P	7873	" Cross Member Bolt with 1522E, for 126514.....
51062D	7888	Throat Plate Screw for 7-57 Machine....
51080E	7873	Bridle Iron Bolt with 51578E, for 126447 and 126448.....
51092P	7873	Table Clamp Bolt with 1600E, for 126612
51179E	7890	Feed Roll (lower) Regulator Connection Screw Stud (upper).....
51578E	7873	Bridle Iron Bolt Nut for 51080.....
58203	—	Needle Bar Connecting Stud 19565 with 19564, for 7-57 Machine.....
58208	7893	Shuttle Frame for 58272.....
58209	7892	" Tension Spring for 43288.....
58216	7885	Face Plate for 58452.....
58221	—	Cloth Plate Packing Rivet for 58222.....
58222	4462	Cloth Plate with two 58223 and four 58221, for 7-56 Machine.....
*58223	—	Cloth Plate Packing for 58222.....
58235	4465	Feed Rock Shaft Crank with 346E, for 58244 and 58393.....
58236	7891	Lifting Presser Bar for 7-57 Machine..
58237	7889	" " " Lifter Bracket with 1497F and 58238, for 7-57 Machine....
58238	7888	Lifting Presser Bar Lifter Bracket Spring Bearing for 58237.....
58243	4461	Feed Rock Shaft for 58244.....
58244	—	Feed Rock Shaft complete for 7-56 Machine, Nos. 58235 and 58243.....

NO.	PLATE	NAME
58252	4463	Lifting Presser Bar Spring Bracket.....
58253	—	Oil Cup for 58254.....
58254	4462	Oil Cup complete, Nos. 2205, 8482, 9084, 11917, 11918, 58253, two 8953 and three 207F.....
58255	4472	Spool Holder Bracket for 58256.....
58256	4472	Spool Holder Bracket complete for 7-56 Machine, Nos. 11881 and 58255.....
58258	4464	Lifting Presser Bar for 7-56 Machine....
58259	4466	" " " Rock Shaft Eccentric Strap Hinge Screw Slide Stop for 7-56 Machine.....
58260	4467	Lifting Presser Foot with 1259c, for 19834, for 7-56 Machine.....
58261	4467	Lifting Presser Foot with 1259c, for 19835, for 7-56 Machine.....
58262	4467	Vibrating Presser Foot for 19835, for 7-56 Machine.....
Nos. 58263 to 58265 FOR 58268		
58263	9605	Table Belt Guide Bracket with 448c....
58264	9605	" " " Pulley.....
58265	9604	" " " " Shaft with 58266 and 58267.....
58266	—	Table Belt Guide Pulley Shaft Oil Hole Plug for 58265.....
58267	—	Table Belt Guide Pulley Shaft Packing Wick for 58265.....
58268	—	Table Belt Guide complete, for flat belt, for No. 29716 Table, Nos. 58264, 58265, two 58263 and eight wood screws 1½ in. No. 14 R. H. B.....
58272	—	Shuttle Frame 58208 with 19869, 43235 and 43236, for 58323.....
58277	7896	Oscillating Shaft Crank Pin.....
58277	7896	Shuttle Race Dowel Pin for 7-57 Machine
58288	—	Feed Lifting Rock Shaft complete for 7-56 Machine, Nos. 9225 and 19837.....
58303	—	Thread Take-up Lever with two 9219, for 58304.....
58304	7891	Thread Take-up Lever 58303 with 1995, for 58312.....
58312	—	Thread Take-up Lever 58304 with 50437D, for 7-57 Machine.....
58319	7890	Thread Take-up Cam Washer for 7-57 Machine.....

NO.	PLATE	NAME
58323	7893	Shuttle (cylinder) 4 in. diam., complete for 7-56 Machine, Nos. 8777, 16901, 43288 and 58272.
58331	—	Thread Take-up Lever for 58332.
58332	7891	" " " 58331 with 1995 and 9219, for 58333.
58333	—	Thread Take-up Lever 58332 with 50437D, for 7-56 Machine.
58334	7883	Arm Shaft for 7-56 Machine.
58335	9606	Balance Wheel with two 354c, for 58336.
58335	9606	Driving Attachment Balance Wheel with two 354c, for 58336.
58336	—	Balance Wheel 58335 with 11442, 122307, two 1402D and four 401E.
58336	—	Driving Attachment Balance Wheel 58335 with 11442, 122307, two 1402D and four 401E, for 58509 and 58510.
58353	7842	Needle Bar for 58354.
58354	—	Needle Bar complete with adjustable clamps, for 1¼ in. to 1½ in. gauges, for 7-57 Machine, Nos. 58353, 58355, 58356 and two 898D.
58355	7889	Needle Clamp (left) with 191F, for 58354.
58356	7889	" " (right) with 191F, for 58354.
58357	7843	Shuttle (inside) Cylinder with 43273, for 58405.
58358	7843	Shuttle (inside, cylinder) 4 in. diam., complete for 1¼ in. and 1½ in. gauges, for 7-57 Machine, Nos. 8777, 16901, 43250 and 58405.
58359	7844	Shuttle (outside) Cylinder with 43273, for 58403.
58360	7844	Shuttle (outside, cylinder) 4 in. diam., complete, for 1¼ in. to 1½ in. gauges, for 7-57 Machine, Nos. 8777, 16901, 43249 and 58403.
58361	7845	Shuttle Driver with 445c, for 1¼ in., 1¾ in. and 1½ in. gauges, for 7-57 Machine, Nos. 58362 to 58364, for 58365.
58362	—	Shuttle Race Body.
58363	7842	" " Ring (inside).
58364	7842	" " " (outside).
58365	7845	Shuttle Race complete, for 1¼ in. to 1½ in. gauges, for 7-57 Machine, Nos. 58362 to 58364 and six 134D.
58387	7885	Cloth Plate for 7-57 Machine.
58389	7899	Feed Dog, for 1 in. gauge, for 7-57 Machine.

NO.	PLATE	NAME
58390	7883	Feed Lifting Rock Shaft with 134D, 2022 and 19967, for 58391.
58391	—	Feed Lifting Rock Shaft complete for 7-57 Machine, Nos. 58390 and two 19819.
58392	7883	Feed Rock Shaft for 58393.
58393	—	Feed Rock Shaft complete for 7-57 Machine, Nos. 58235 and 58392.
58403	—	Shuttle (outside) Cylinder 58359 with 1323F and 8780, for 58360.
58405	—	Shuttle (inside) Cylinder 58357 with 1323F and 8895, for 58358.
58412	7894	Thread Take-up Cam with two 434c, for 7-57 Machine.
58414	9601	Feed Dog, for 1½ in. and 1¼ in. gauges, for 7-57 Machine.
58415	9602	Feed Dog, for 1¾ in. and 1½ in. gauges, for 7-57 Machine.
58416	—	Throat Plate Body for 58421.
58420	9601	" " Needle Hole Strip for 58421.
58421	9601	Throat Plate complete, for 1¼ in. gauge, for 58414, for 7-57 Machine, Nos. 58416, two 58420 and four 691F.
Nos. 58422 to 58424 for 58425		
58422	—	Throat Plate Body.
58423	9602	" " Needle Hole Strip (left).
58424	9602	" " " " (right).
58425	9602	Throat Plate complete, for 1¾ in. gauge, for 58415, for 7-57 Machine, Nos. 58422 to 58424 and four 691F.
Nos. 58426 to 58428 for 58429		
58426	—	Throat Plate Body.
58427	9602	" " Needle Hole Strip (left).
58428	9602	" " " " (right).
58429	9602	Throat Plate complete, for 1½ in. gauge, for 58415, for 7-57 Machine, Nos. 58426 to 58428 and four 691F.
Nos. 58435 to 58437 for 58438		
58435	—	Throat Plate Body.
58436	7899	" " Needle Hole Strip (left).
58437	7899	" " " " (right).
58438	7899	Throat Plate complete, for 1 in. gauge, for 58389, for 7-57 Machine, Nos. 58435 to 58437 and four 742F.
58444	7883	Arm Shaft for 7-57 Machine.

NO.	PLATE	NAME
58446	7885	Feed Bar for 7-57 Machine.....
58452	—	Face Plate complete for 7-57 Machine, Nos. 910c, 11874, 11875, 19583, 19590, 19701, 19866, 19886, 41544, 58216, 58453 and three 164d.....
58453	7884	Lifting Presser Bar Lifter for 58452.....
Nos. 58454 to 58456 FOR 58457		
58454	—	Throat Plate Body.....
58455	9601	" " Needle Hole Strip (left)....
58456	9601	" " " " " (right) ..
58457	9601	Throat Plate complete, for 1½ in. gauge, for 58414, for 7-57 Machine, Nos. 58454 to 58456 and four 742f.....
58458	9607	Driving Attachment Brake Block Stud for 58460 and 58461.....
58459	9606	Driving Attachment Lever with 1036c, for 58460 and 58461.....
58460	—	Driving Attachment Lever 58459 with 134d, 8984, 8991, 8992, 58458, 58462, and two 497e, for 58509.....
58461	—	Driving Attachment Lever 58459 with 134d, 8984, 8991, 8992, 58458, 58465 and two 497e, for 58510.....
58462	9605	Driving Attachment Lever Bracket for 58460.....
58465	9605	Driving Attachment Lever Bracket for 58461.....
*58467	—	Arm for 7-56 Machine.....
*58468	—	" " 7-57 Machine.....
58469	7884	" Side Cover and Feed (lower) Regu- lator Supporting Bracket with 453c....
*58470	—	Bed for 7-56 Machine.....
*58471	—	" " 7-57 Machine.....
58472	7884	Feed Cam (double) with two 832c.....
58473	7885	" Roll (lower) with two 840d (6 in. long) for 58480.....
58474	7884	Feed Roll (lower) Regulator (forked)....
58475	7884	" " " " Connection..
58476	7896	" " " " Hinge Pin..
Nos. 58477 to 58479 FOR 58480		
58477	7886	Feed Roll (lower) Rock Shaft.....
58478	7883	" " " Shaft.....
58479	9606	" " " Bracket.....

NO.	PLATE	NAME
58480	—	Feed Roll (lower) Shaft Bracket complete, Nos. 635c, 1513i, 21788, 58473, 58477 to 58479, 58481, 58482, 127526, four 227d, eight 127528, ten 127531 and thirty-six 127529.....
58481	7886	Feed Roll (lower) Wheel with two 448c, for 58480.....
58482	7886	Feed Roll (lower) Wheel Retaining Clutch for 58480.....
58483	7885	Feed Roll (upper) with two 155c (4 in. long) for 58492.....
58484	7885	Feed Roll (upper) with two 155c (6 in. long) for 58493.....
58485	7887	Feed Roll (upper) Lifting Lever with 1396d, for 58492 and 58493.....
58486	7887	Feed Roll (upper) Lifting Lever Shaft for 58492.....
58487	7887	Feed Roll (upper) Lifting Lever Shaft for 58493.....
58488	7887	Feed Roll (upper) Shaft for 58492.....
58489	7887	" " " " " 58493.....
58490	9603	" " " " Bracket for 58492
58491	9603	" " " " " " 58493
58492	—	Feed Roll (upper) Shaft Bracket complete for 7-56 Machine, Nos. 649d, 694d, 1177d, 1401c, 1608c, 1681c, 58483, 58485, 58486, 58488, 58490, 58494, 58495, 58497, 58499, 58502 and two 162d.....
58493	—	Feed Roll (upper) Shaft Bracket complete for 7-57 Machine, Nos. 649d, 694d, 1401c, 1618c, 40063, 58484, 58485, 58487, 58489, 58491, 58496, 58498, 58500, 58501, 58504, 58505 and two each 162d, 178d and 1177d.....
58494	7887	Feed Roll (upper) Shaft Bracket Hinge Pin for 58492.....
58495	7887	Feed Roll (upper) Spring for 58492.....
58496	7887	" " " " " 58493.....
58497	7887	" " " " Strap for 58492
58498	7887	" " " " " " 58493
58499	9603	" " " Supporting Bracket with 445c, for 58492.....
58500	9603	Feed Roll (upper) Supporting Bracket with 448c, for 58493.....
58501	7891	Feed Roll (upper) Supporting Bracket Position Bracket for 58493.....

NUMERICAL LIST OF PARTS

NO.	PLATE	NAME
58502	7898	Feed Roll (upper) Supporting Bracket Screw Stud for 58492.....
58503	7898	Thread Retaining Bracket for 58504.....
58504	—	Thread Retainer complete for 58493, Nos. 58503, two each 637c, 1560c, 11422 and four 2102.....
58505	7898	Thread Retainer Thread Guide for 58493
58506	7891	Vibrating Presser Bar for 7-57 Machine..
58507	7898	" " " Spring for 7-57 Machine.....
58509	—	Driving Attachment complete for 7-56 Machine, Nos. 1520E, 6055, 9091, 11440, 14185, 58336, 58460, 122304, 122306 and 126212.....
58510	—	Driving Attachment complete for 7-57 Machine, Nos. 1520E, 6055, 9091, 11440, 14185, 58336, 58461, 122304, 122306 and 126212.....
58716	7890	Feed Roll (lower) Regulator Connection Screw Stud (upper) Sleeve.....
58795	7895	Tension Wheel for 19701.....
60213	4483	Bobbin Winder Bobbin Position Pin for 60215.....
Nos. 60214 to 60216 for 60217		
60214	4486	Bobbin Winder Spindle.....
60215	4486	" " " Shaft with 454c and 60213.....
60216	4486	Bobbin Winder Stop Latch.....
60217	4485	Bobbin Winder for 60219, Nos. 2289, 11107, 41441, 41894, 41896, 41897, 41899, 43270, 60214 to 60216 and two 4784.....
60218	7883	Bobbin Winder Bracket for 60219.....
60219	—	Bobbin Winder (swinging automatic, left hand) complete, Nos. 9842, 41823, 50124b, 60217, 60218 and three 894b..
60502	—	Driving Attachment Treadle Bracket (right) 46681 with two wood screws 1 in. No. 14, for 126211.....
60608	7285	Thread Unwinder Thread Guard for 60609
60609	—	Thread Unwinder Thread Guard complete for 41823, Nos. 330b, 828c, 1560c, 2103, 5769, 17547, 60608 and two 2102.....
60626	9605	Driving Attachment Treadle Pitman complete for 126212, Nos. two each 9079 and 27639.....

NUMERICAL LIST OF PARTS

NO.	PLATE	NAME
60858	9604	Driving Attachment Treadle Hanging Hook for 126212.....
120344	4484	Oiler (copper plated) with 120345 (Accessories).....
120345	4484	Oiler Spout, 5 in. long, for 120344.....
122303	—	Balance Wheel Ball Ring for 122304.....
122303	—	Driving Attachment Balance Wheel Ball Ring for 122304.....
122304	9607	Balance Wheel Ball Ring 122303 with eighteen 25362.....
122304	9607	Driving Attachment Balance Wheel Ball Ring 122303 with eighteen 25362, for 58509 and 58510.....
122306	9607	Balance Wheel Ball Washer (left).....
122306	9607	Driving Attachment Balance Wheel Ball Washer (left) for 58509 and 58510.....
122307	9607	Balance Wheel Ball Washer (right) for 58336.....
122307	9607	Driving Attachment Balance Wheel Ball Washer (right) for 58336.....
126036	9606	Driving Attachment Treadle for 126037..
126037	—	" " " 126036 with 2718R, 50581R and 126038, for 126211.
126038	9605	Driving Attachment Treadle Extension for 126037.....
126079	7871	Table Clamp Bolt Nut Lock Washer for 126612.....
126205	9604	Driving Attachment Treadle Bracket (left) for 126206.....
126206	—	Driving Attachment Treadle Bracket (left) complete for 126211, Nos. 23258, 126205, 126207, 126208 and two wood screws 1 in. No. 14.....
126207	7871	Driving Attachment Treadle Bracket (left) Hook for 126206.....
126208	7871	Driving Attachment Treadle Bracket (left) Hook Rivet for 126206.....
126211	—	Driving Attachment Treadle complete for 126212, Nos. 60502, 126037 and 126206
126212	—	Driving Attachment Treadle and Pitman complete for 58509 and 58510, Nos. 60626, 60858 and 126211.....
126447	9606	Bridle Iron (left) with four each 41125 and 51080E, (Trimnings for Table No. 29716).....

NUMERICAL LIST OF PARTS

NO.	PLATE	NAME
126448	9606	Bridle Iron (right) with four each 41125 and 51080E (Trimnings for Table No. 29716).....
126501	7871	Table Clamp for 126612.....
126504	9605	Journal Box Hanger Bracket for 126505.
126505	—	Journal Box Hanger Bracket complete for 126620, Nos. 839R, 27022, 27121, 51057R, 126504, 126509, 126917 and two 12620.....
126508	7880	Leg for 126514.....
126509	7871	Journal Box Hanger Bracket Bolt Socket Washer for 126505.....
126509	7871	Leg Bolt Nut Socket Washer for 126514.
126509	7871	" Cross Member Bolt Nut Socket Washer for 126514.....
126512	7880	Leg Cross Member 25 1/4 in. long, for 126514
126514	—	Leg with Rail complete for 126620, Nos. 126512, 126516, two 126508 and four each 9842R, 12620, 51038R, 51057R and 126509.....
126516	7880	Rail, 32 1/2 in. long, for 126514.....
126611	7880	Brace (table) with 1 1/4 in. No. 12 F. H. B. wood screw, for 126620.....
126612	—	Table Clamp Bolt 51092R with 126079 and 126501 (Trimnings for Table No. 29716)
126620	—	Steel Work complete for No. 29716 Table, Nos. 27061 two each 27108, 126505, 126514, 126611, four feet two inches of 1 1/8 in. shafting and thirteen feet of 1 in. flat belting.....
126917	9604	Journal Box Hanger Bracket Reinforcing Plate for 126505.....
127526	7886	Feed Roll (lower) Wheel Cover for 58480
127528	7896	" " " " Retaining Clutch Roller for 58480.....
127529	7896	Feed Roll (lower) Wheel Retaining Clutch Roller Spring for 58480.....
127529	7896	Feed Roll (lower) Wheel Roller Spring for 58480.....
127531	7896	Feed Roll (lower) Wheel Roller for 58480
200383c	7898	Thread Unwinder Spool Rest Rod Set Screw for 202490.....
201018c	7898	Thread Unwinder Spool Rest Set Screw for 225389 and 225395.....
201696j	7898	Thread Unwinder Thread Guide Lock Nut for 225397.....

NUMERICAL LIST OF PARTS

NO.	PLATE	NAME
202490	7165	Thread Unwinder Spool Stand with 200383c, for 225397.....
Nos. 225388 TO 225392 FOR 225397		
225388	7165	Thread Unwinder Spool Rest Rod.....
225389	7165	" " " " (for one spool) with 201018c.....
225390	7234	Thread Unwinder Thread Cone Holder, for inverted cones.....
225391	7165	Thread Unwinder Thread Guide.....
225392	7165	" " " " Rod with 208E and 225393.....
225393	7898	Thread Unwinder Thread Guide Rod Washer for 225392.....
225395	7165	Thread Unwinder Spool Rest (for two spools) with 201018c, for 225397.....
225397	7165	Thread Unwinder complete, for three spools, for 7-57 Machine, Nos. 201696j, 202490, 225388, 225389, 225392, 225395, three each 225391 and wood screws 3/8 in. No. 12.....

SINGER Needles should be used
in **SINGER** Machines
These Needles and their Containers
are marked with the
Company's Trade Mark "SIMANCO.**" 1

Needles in Containers marked
"FOR SINGER MACHINES"
are NOT **SINGER** made needles. 2

PLATE 850—ONE-HALF SIZE

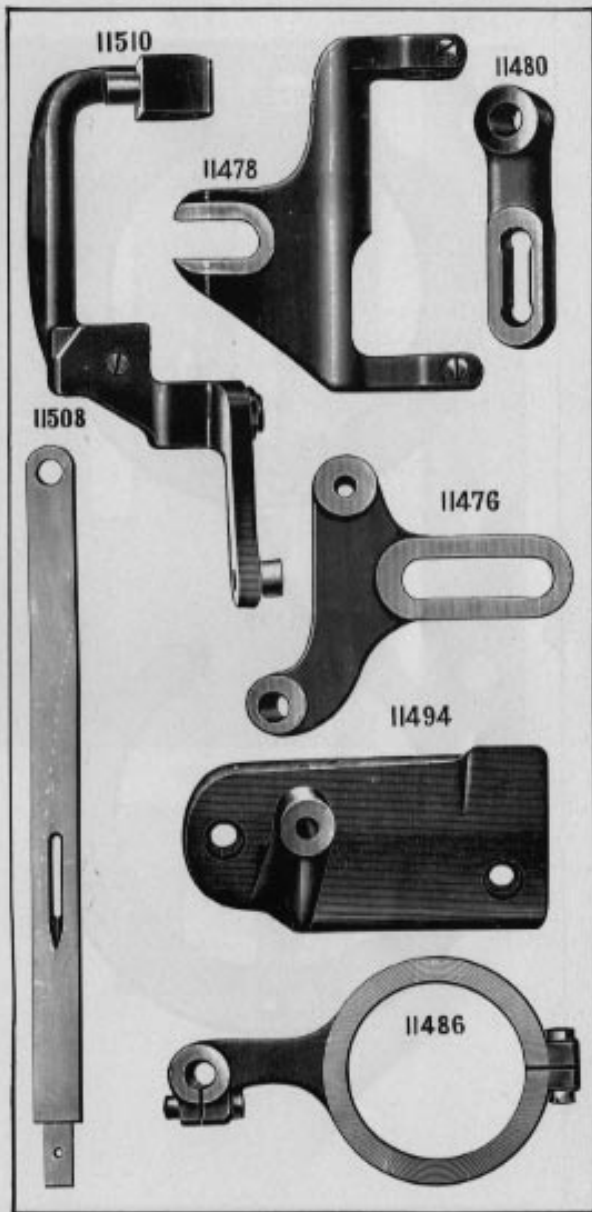


PLATE 4408—ONE-HALF SIZE

19776



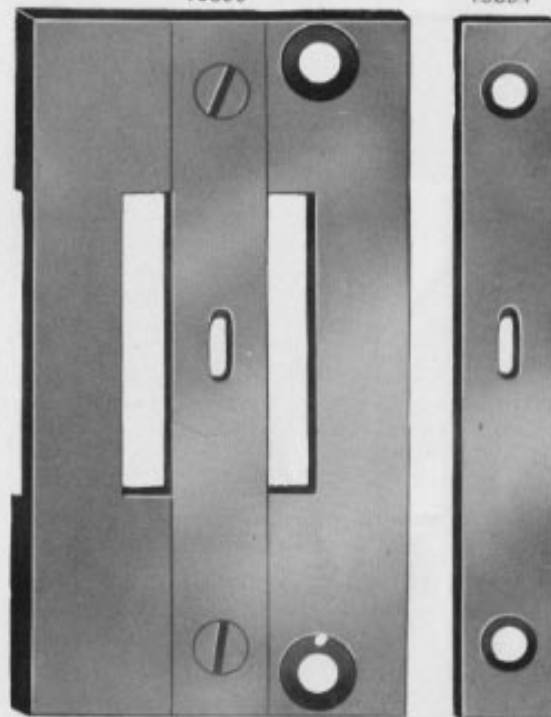
19777



PLATE 4436—FULL SIZE

19855

19854



19834

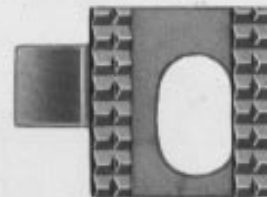
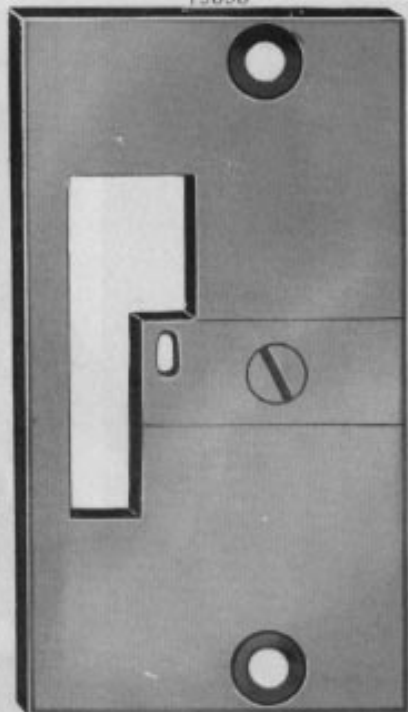
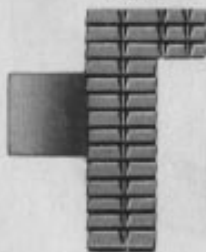


PLATE 4437—FULL SIZE

19858



19835

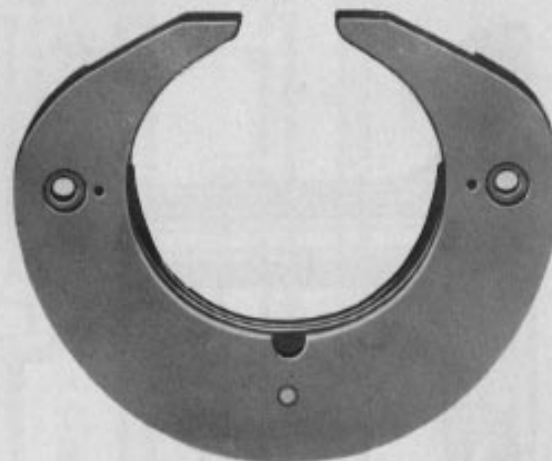


19857

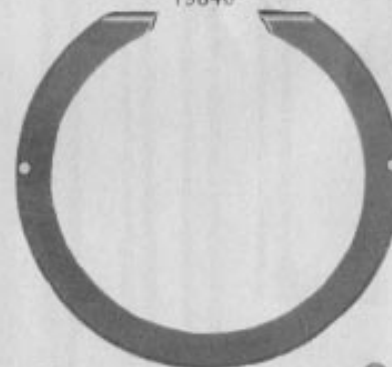


PLATE 4441—ONE-HALF SIZE

19849



19846



19847



PLATE 4456—ONE-HALF SIZE

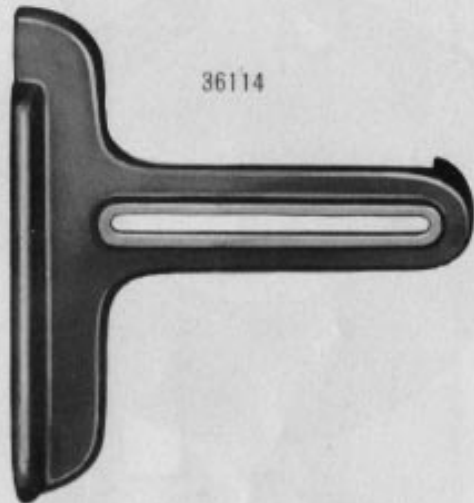


PLATE 4461—ONE-FOURTH SIZE

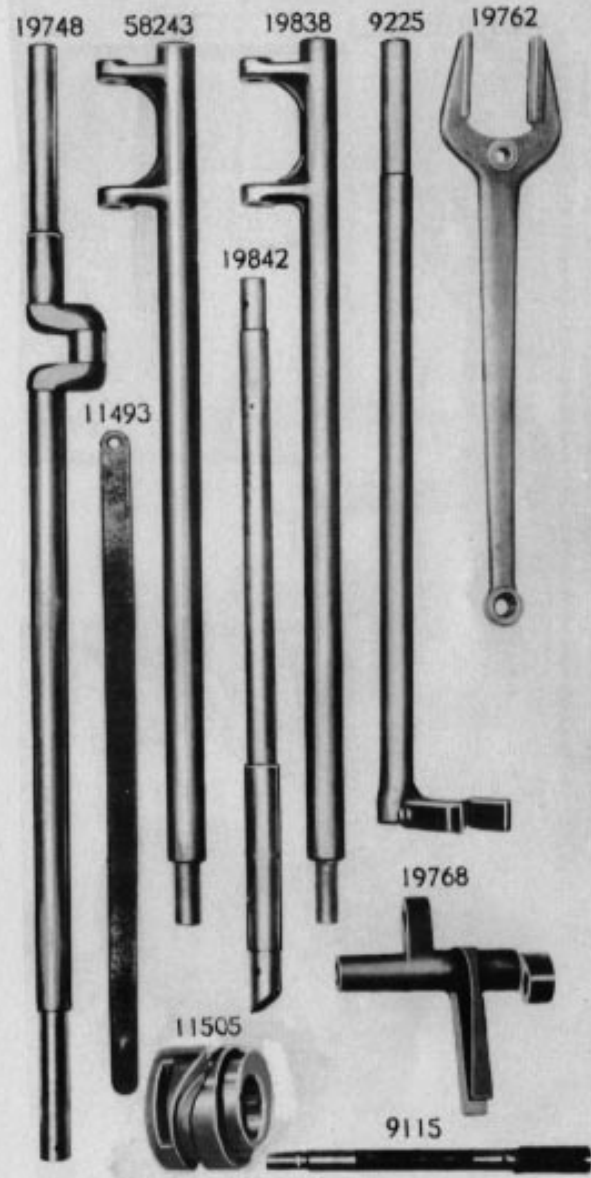


PLATE 4462—ONE-FOURTH SIZE

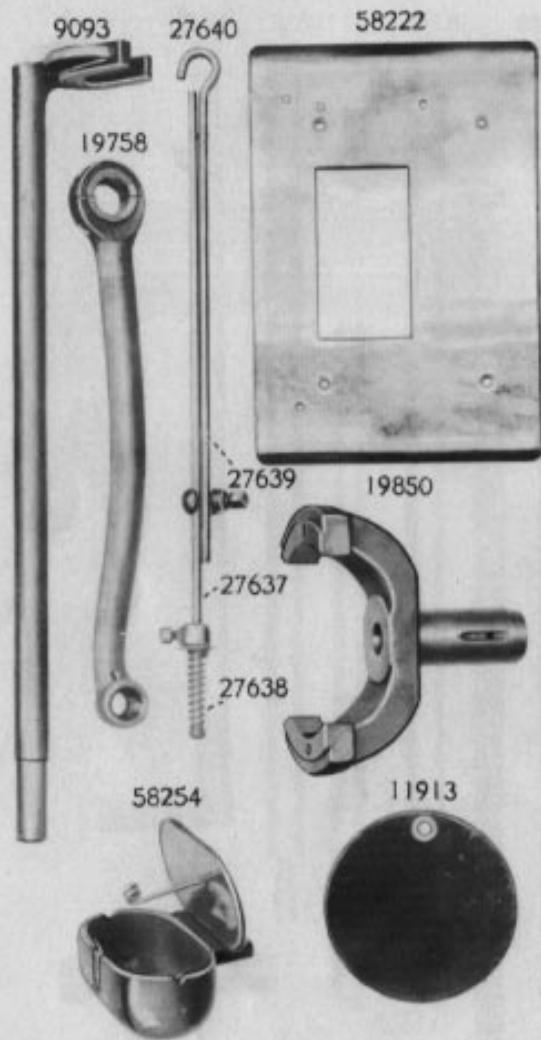


PLATE 4463—ONE-HALF SIZE

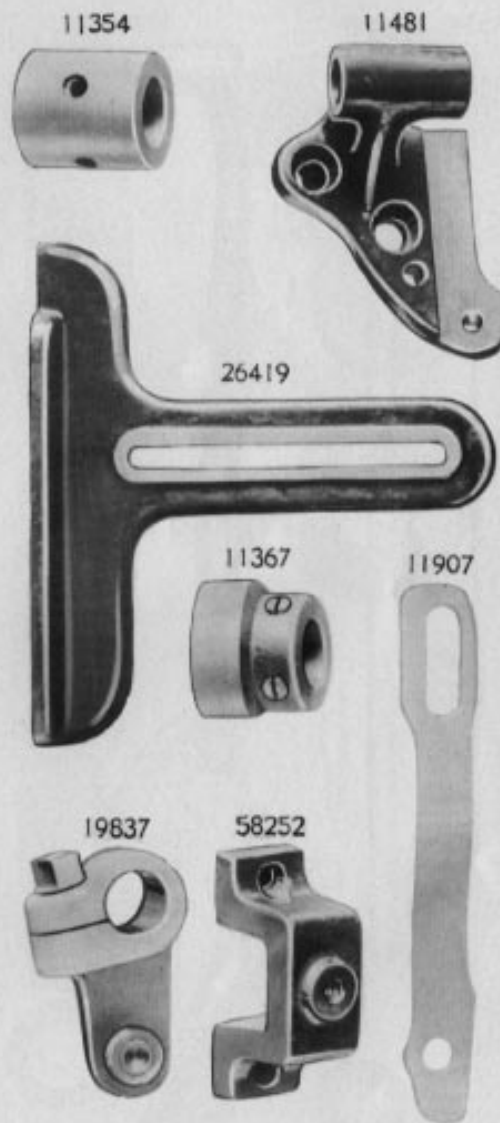


PLATE 4464—ONE-HALF SIZE

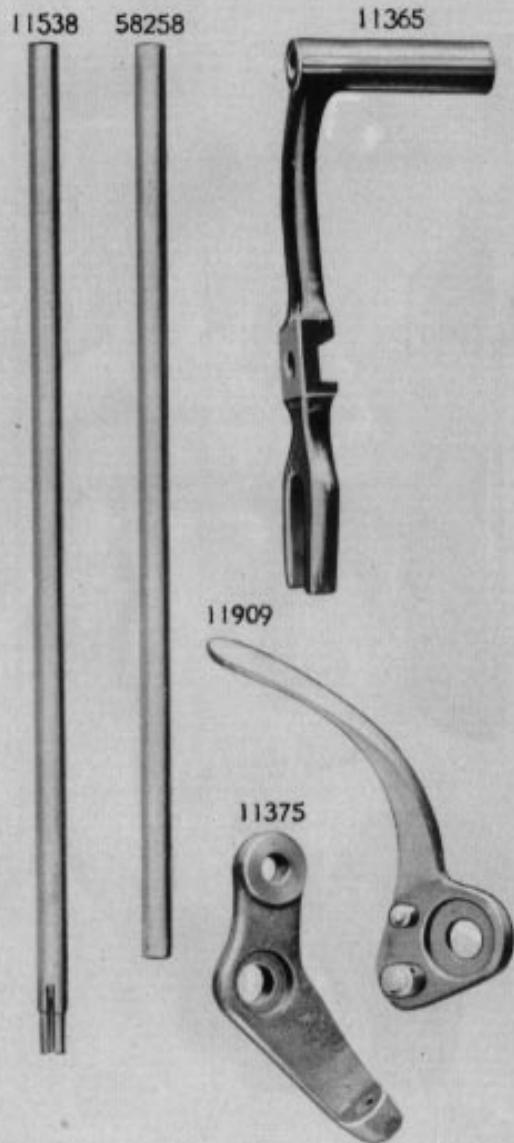


PLATE 4465—FULL SIZE

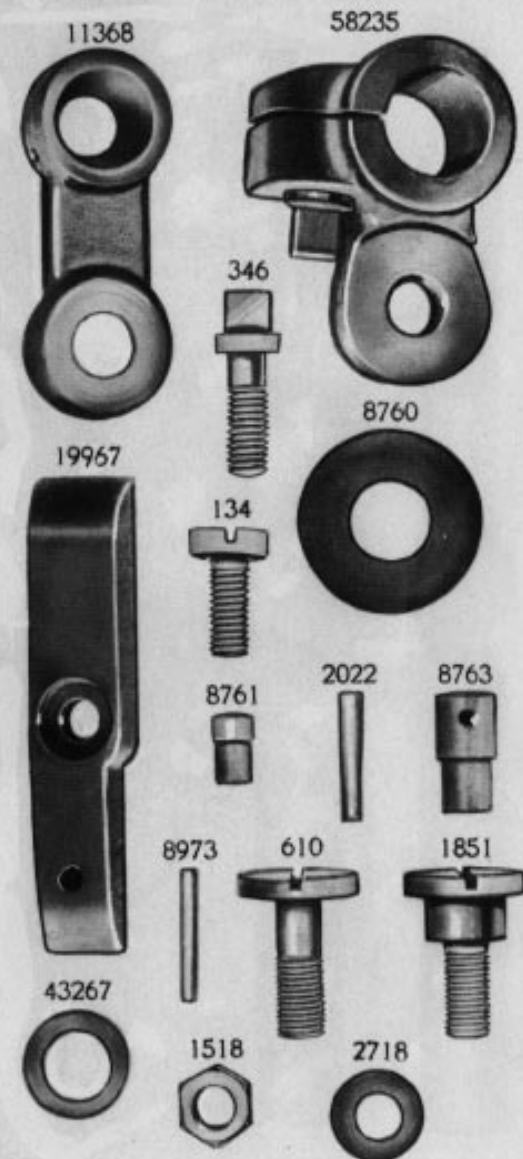


PLATE 4466—FULL SIZE

11479



11484



1850



453



608



58259



11487



11489



11490



11488

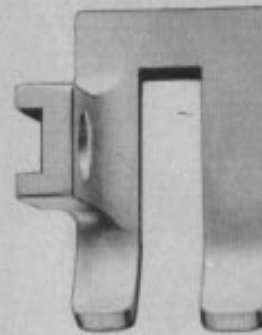


11492



PLATE 4467—FULL SIZE

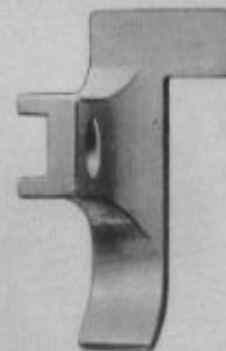
19860



58260



58262



58261



PLATE 4468—FULL SIZE

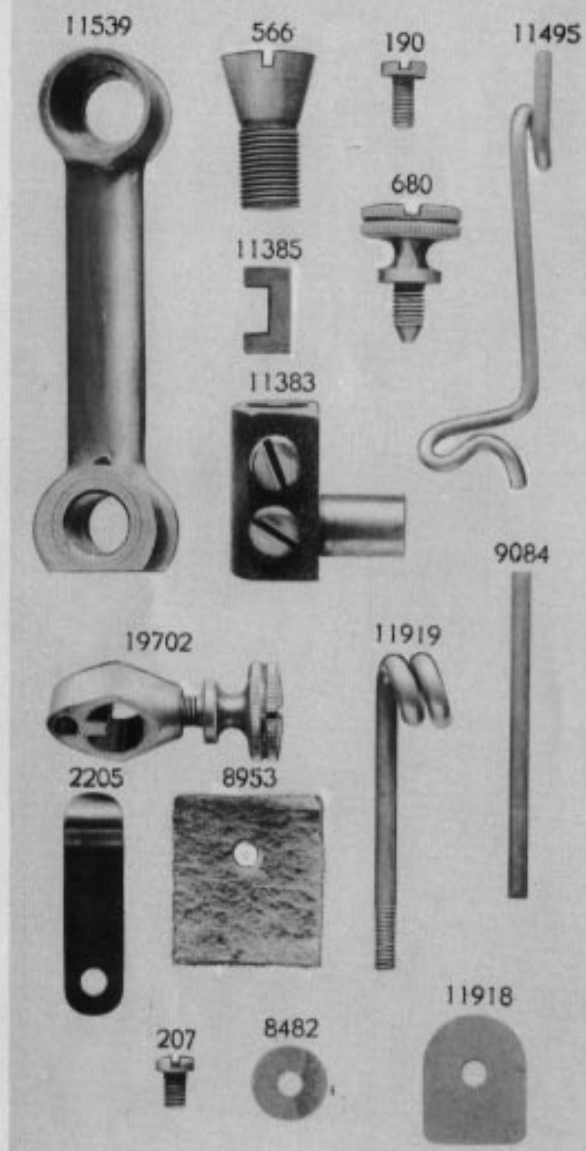


PLATE 4469—FULL SIZE



PLATE 4472—ONE-HALF SIZE

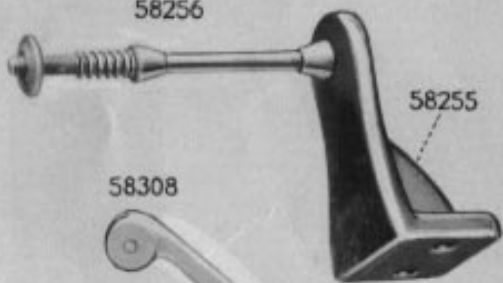
9121



9122



58256



58255

58308



19845

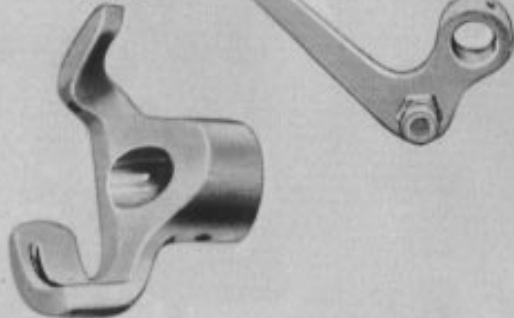


PLATE 4473—FULL SIZE

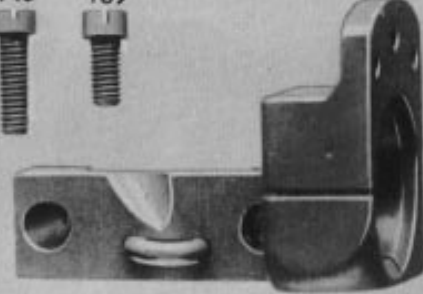
145



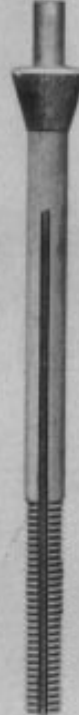
159



11502



851



8018



5983



8019



607



122



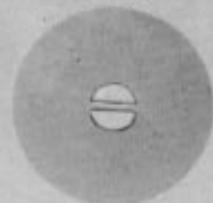
1541



8905



11423



1560



PLATE 4474—FULL SIZE

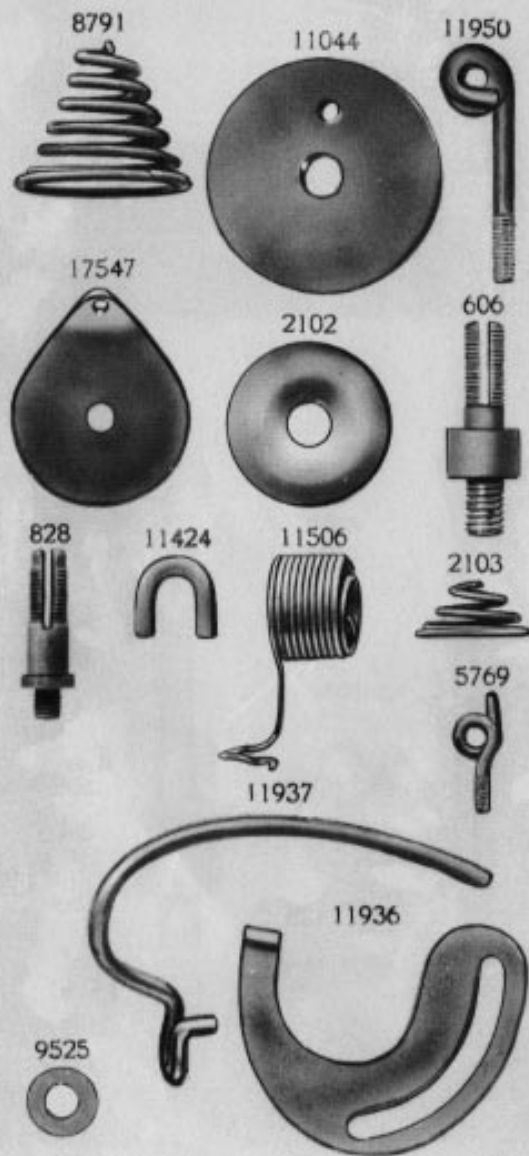


PLATE 4475—FULL SIZE

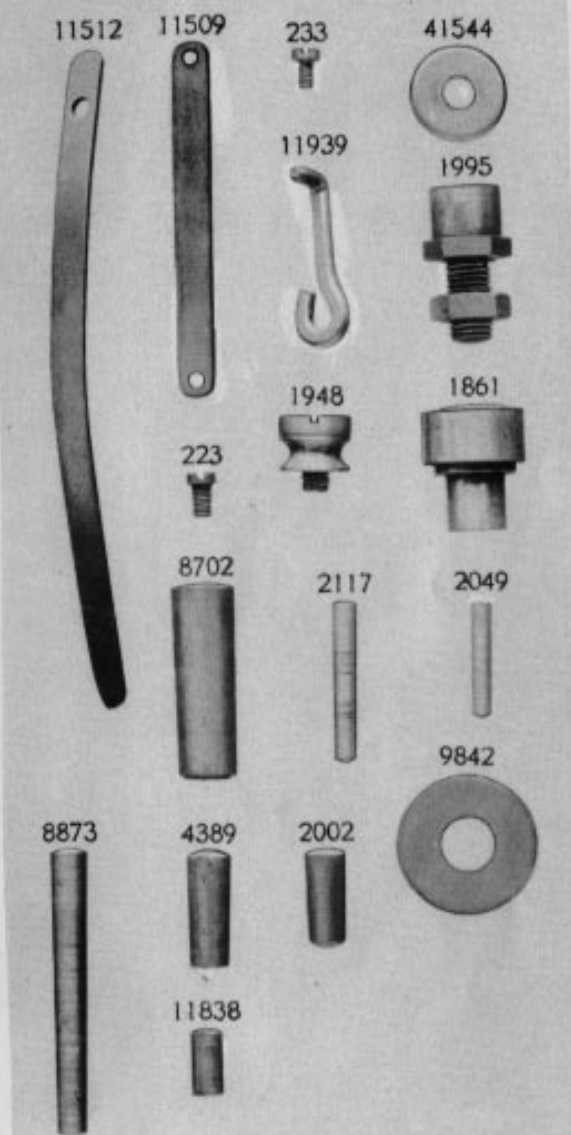


PLATE 4476—FULL SIZE

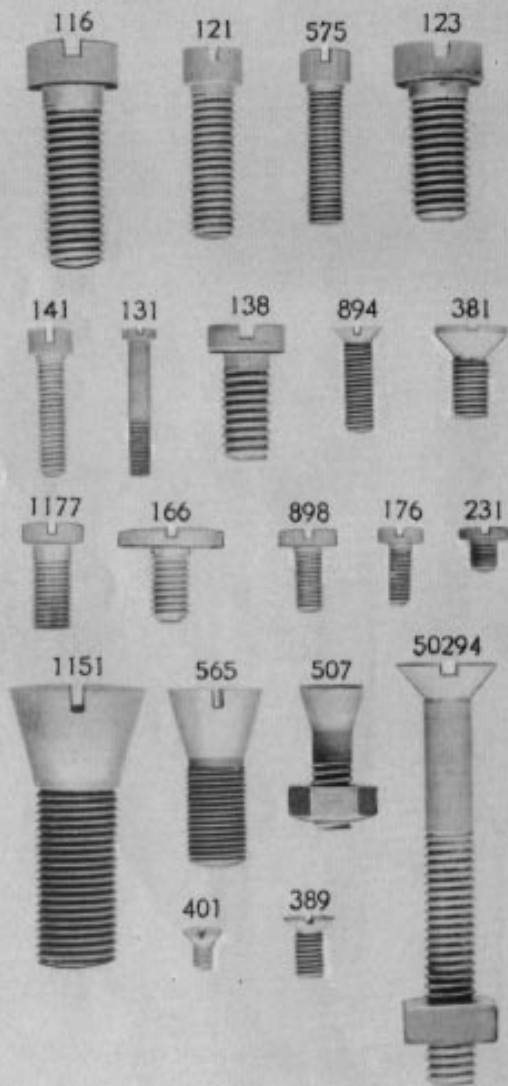


PLATE 4477—FULL SIZE

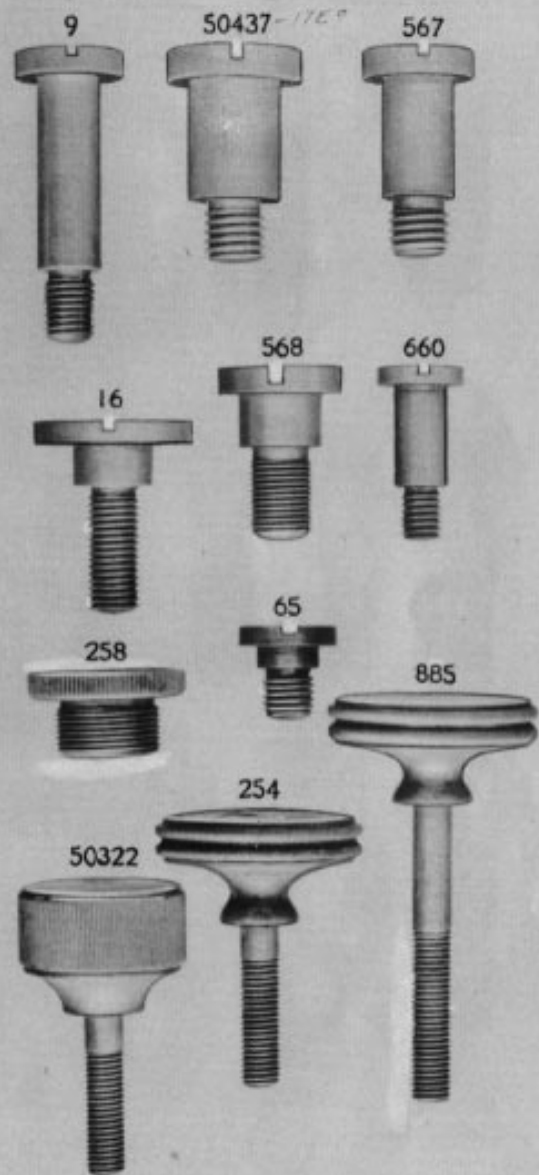


PLATE 4478—FULL SIZE

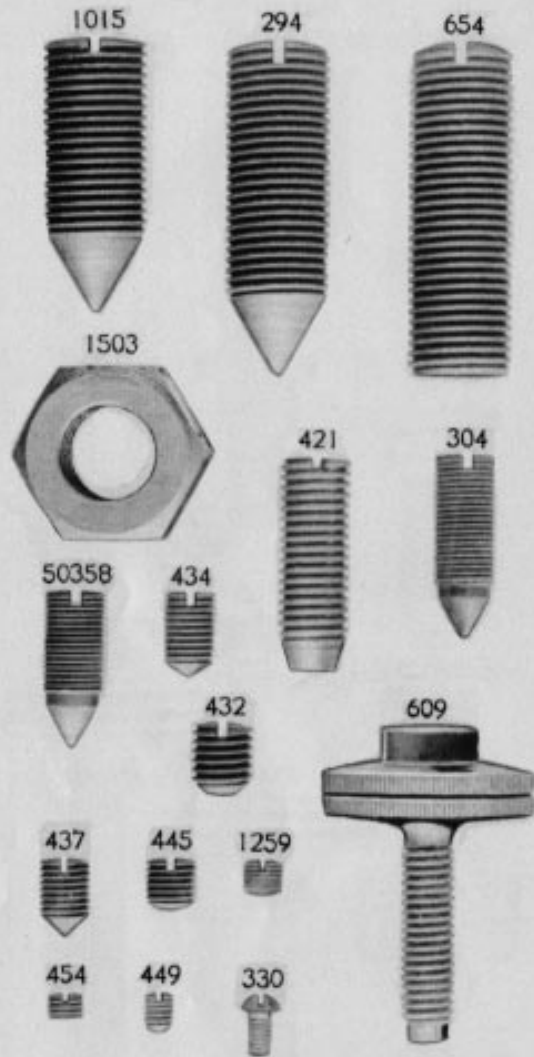


PLATE 4479—FULL SIZE

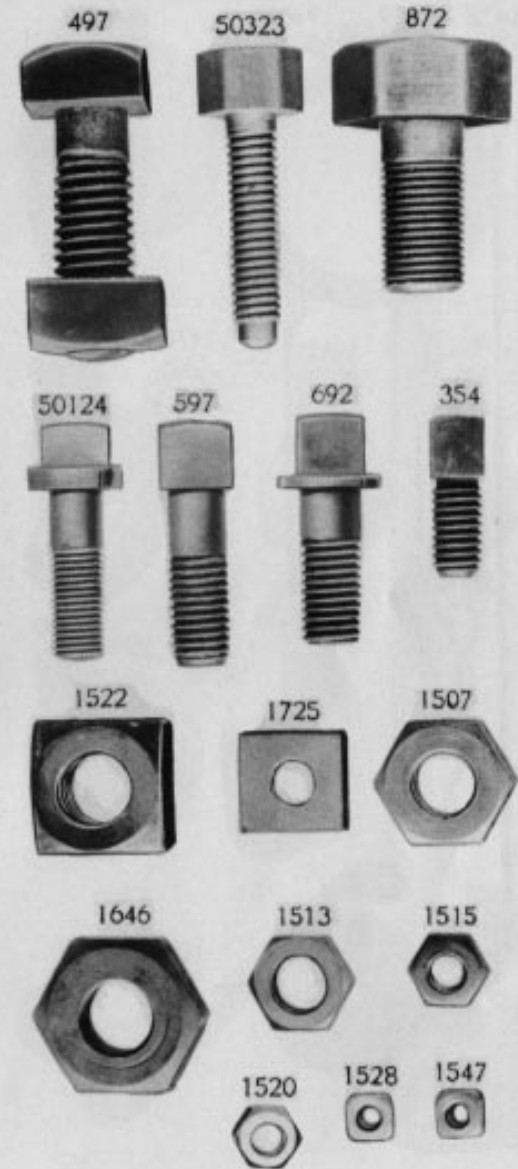


PLATE 4482—ONE-HALF SIZE

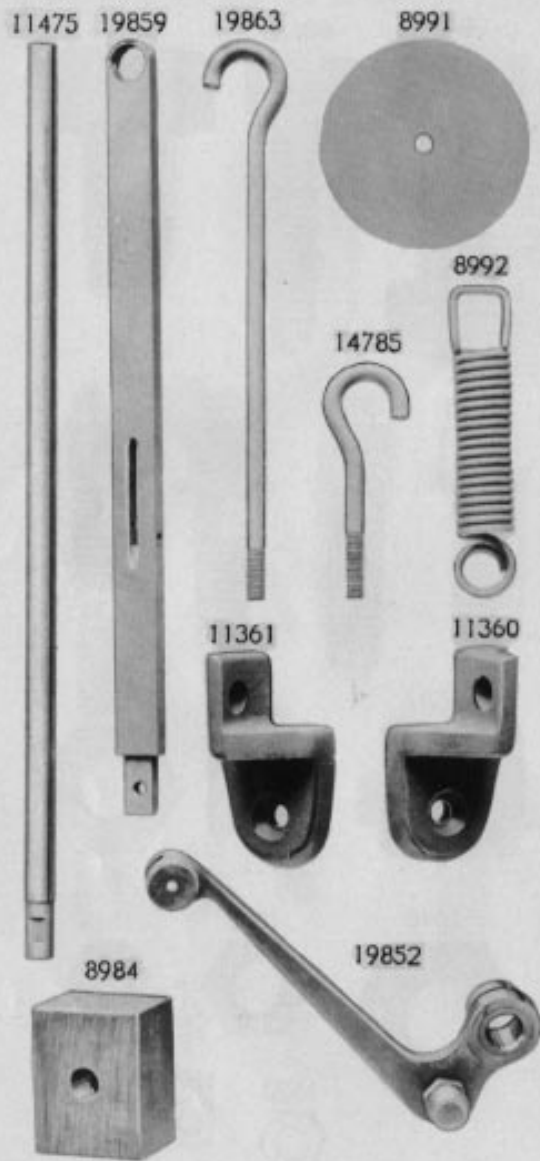


PLATE 4483—FULL SIZE



PLATE 4484—ONE-HALF SIZE



PLATE 4485—ONE-HALF SIZE

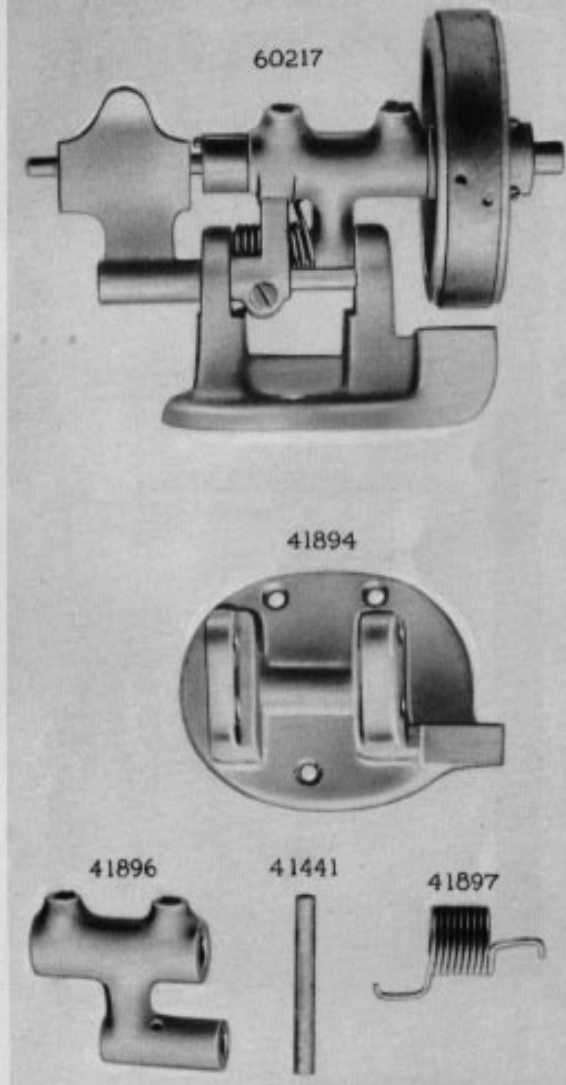


PLATE 4486—ONE-HALF SIZE

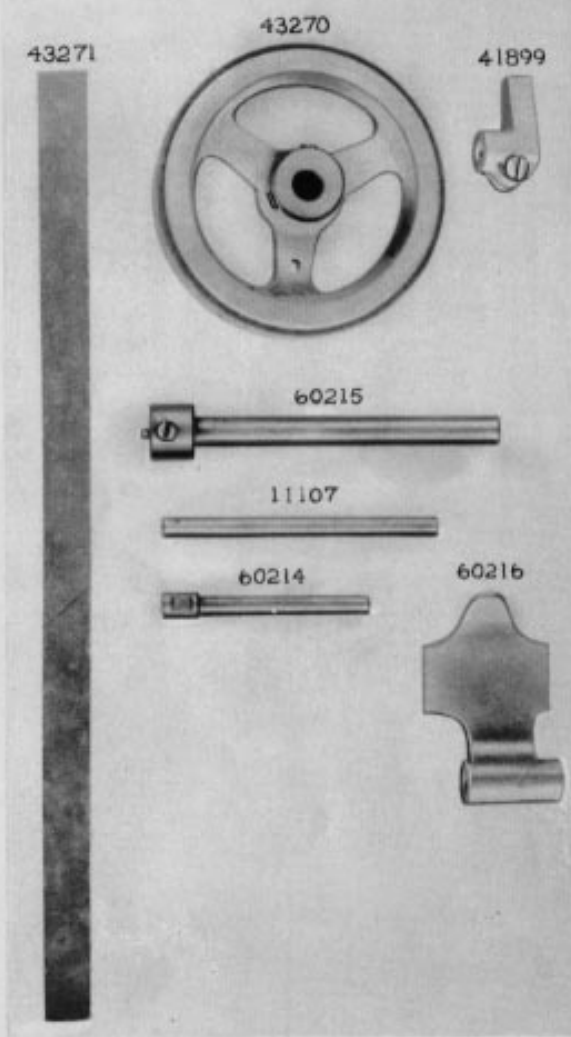


PLATE 7165—ONE-FOURTH SIZE

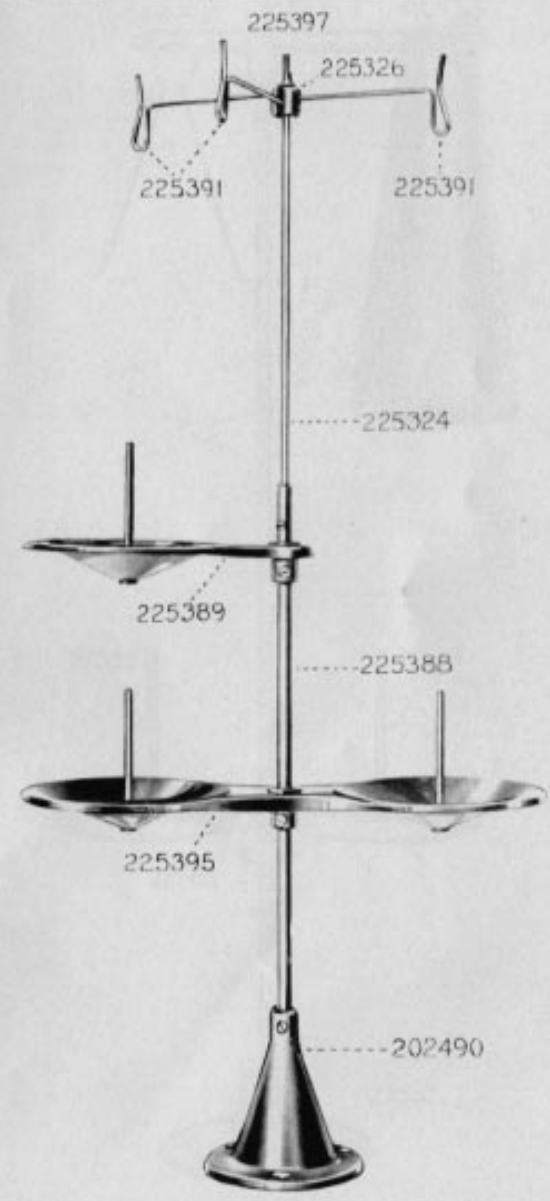


PLATE 7234—ONE-HALF SIZE

27739

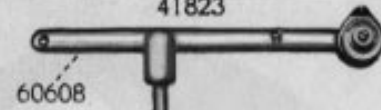


225390



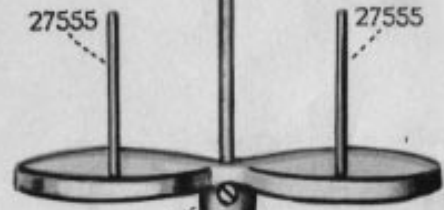
PLATE 7285—ONE-FOURTH SIZE

41823



60608

27560



27555

27555

27583



27557

PLATE 7816—FULL SIZE

43275



43273



43239



43236



PLATE 7817—FULL SIZE

43240



43274



PLATE 7818—FULL SIZE

43283



43282



43235



PLATE 7819—FULL SIZE

43242

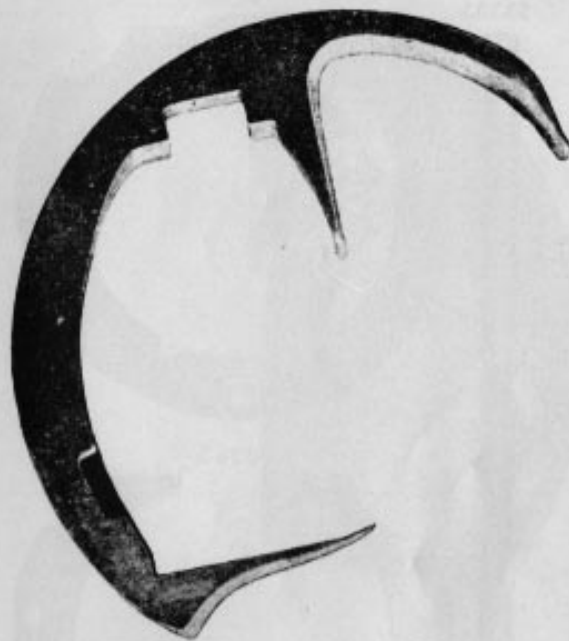
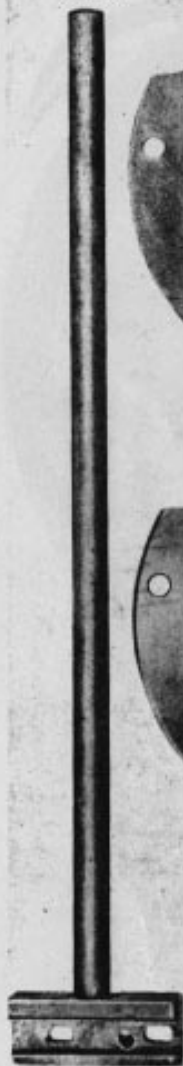


PLATE 7842—ONE-HALF SIZE

58353



58364



58363

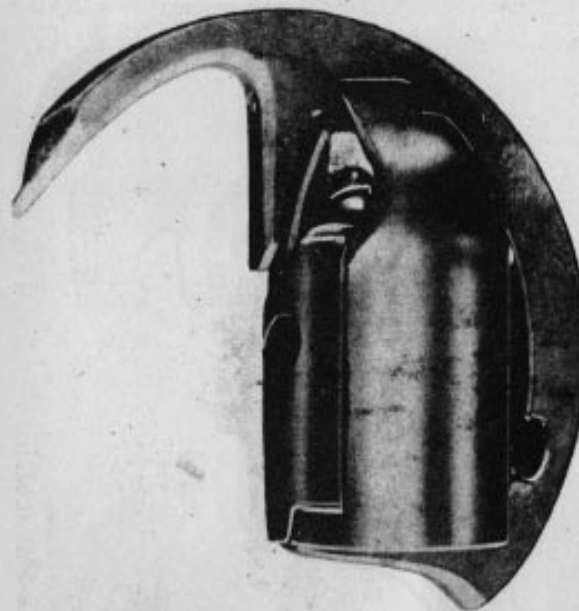


58351



PLATE 7843—FULL SIZE

58358



58357



PLATE 7844—FULL SIZE

58360



58359

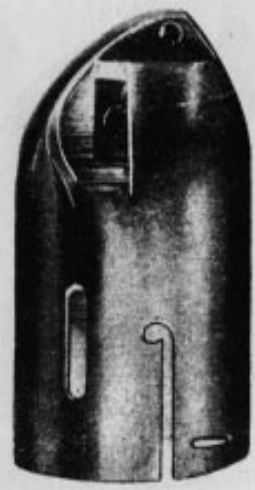
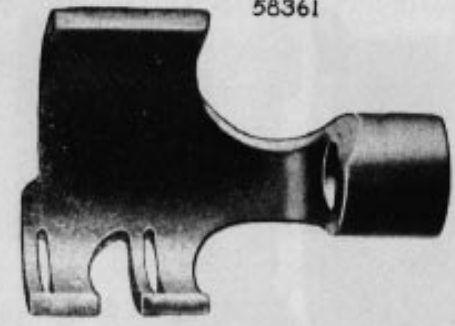


PLATE 7845—ONE-HALF SIZE

58361



58365

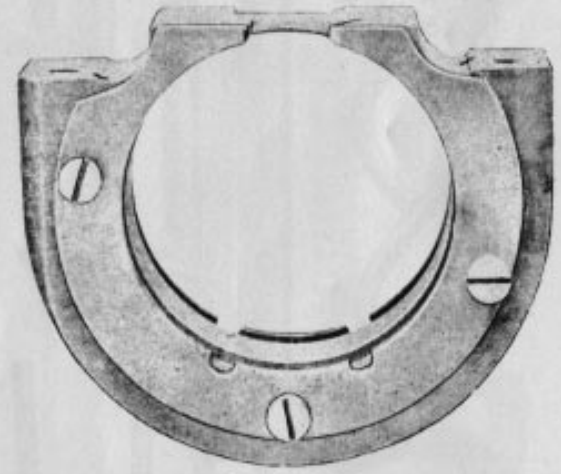


PLATE 7871—FULL SIZE

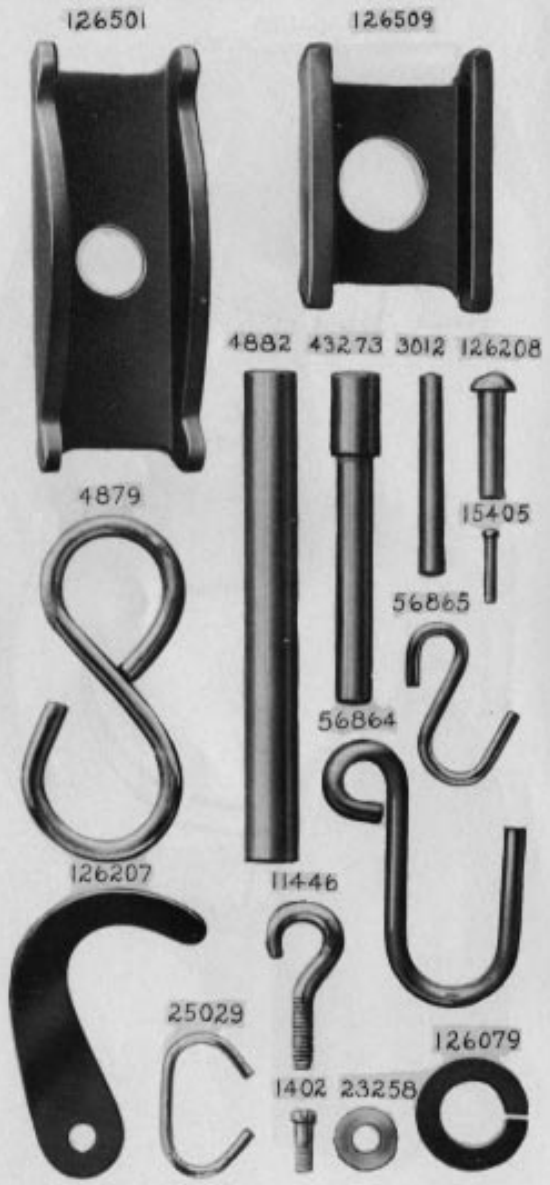


PLATE 7873—FULL SIZE

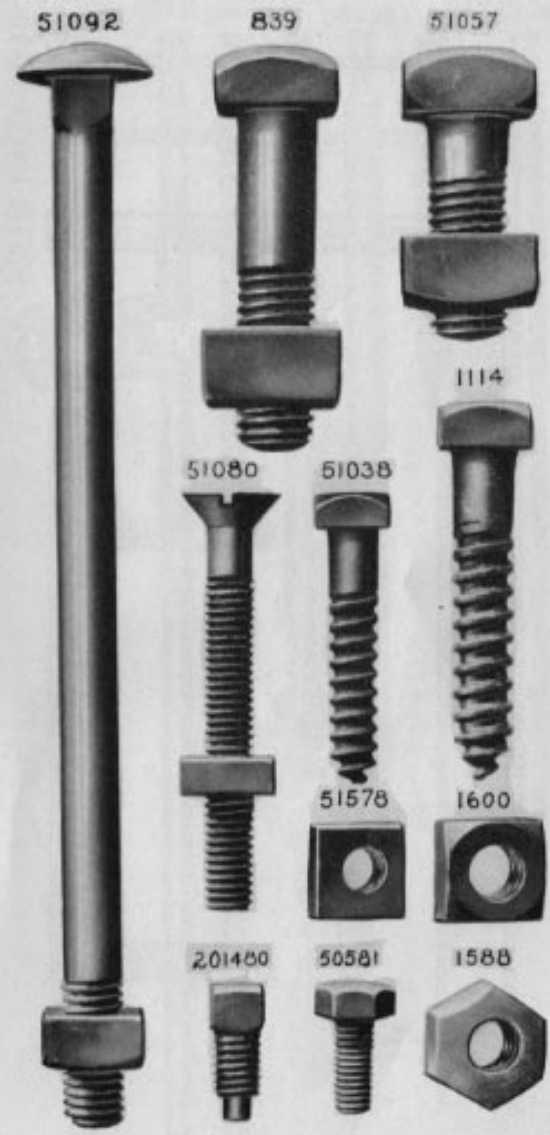


PLATE 7880—ONE-NINTH SIZE

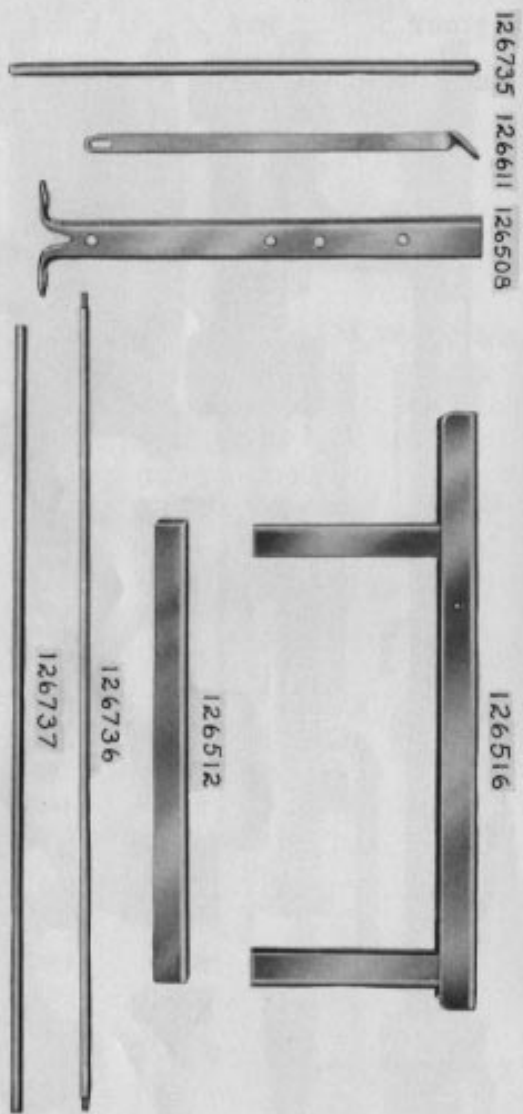


PLATE 7883—ONE-FOURTH SIZE

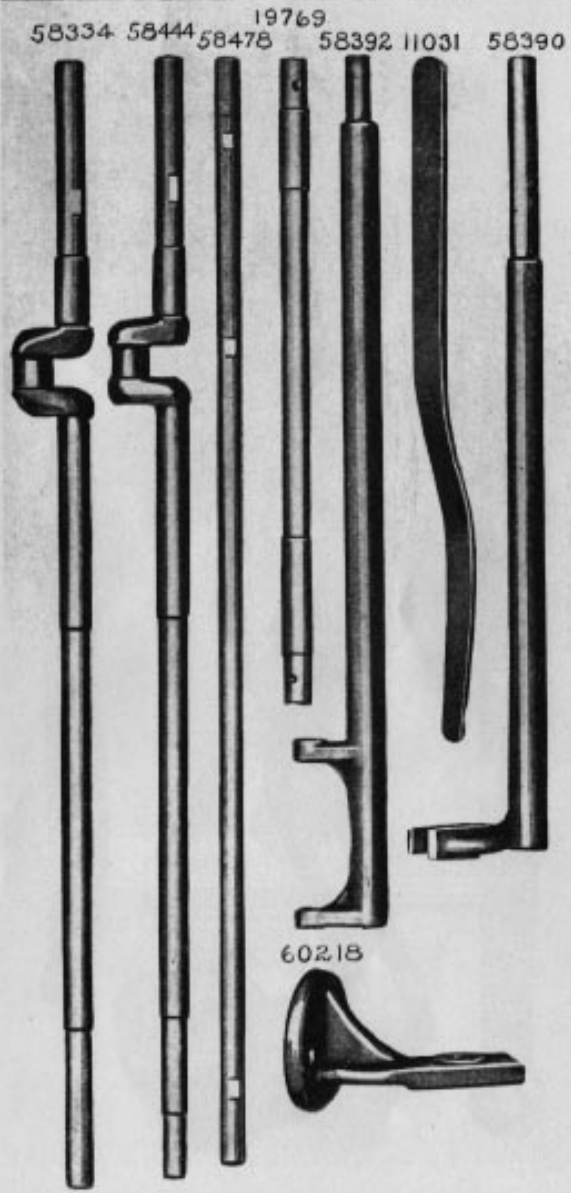
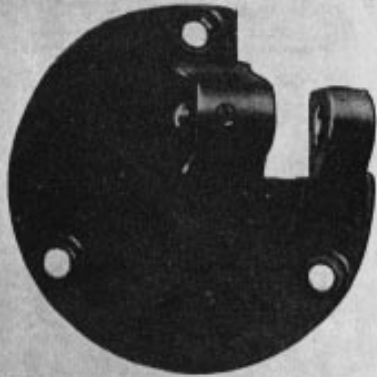


PLATE 7884—ONE-HALF SIZE

58475



58469



58474



58453

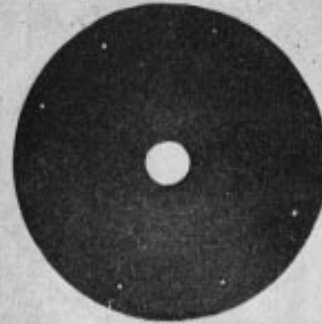


58472



PLATE 7885—ONE-FOURTH SIZE

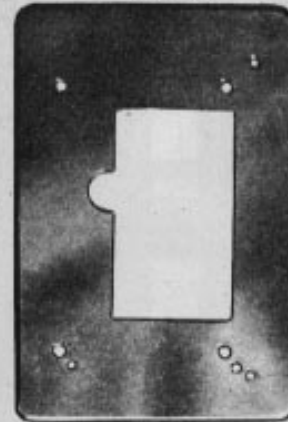
11442



58216



58387



58446



58483



58484



58473

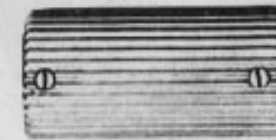


PLATE 7886—ONE-HALF SIZE

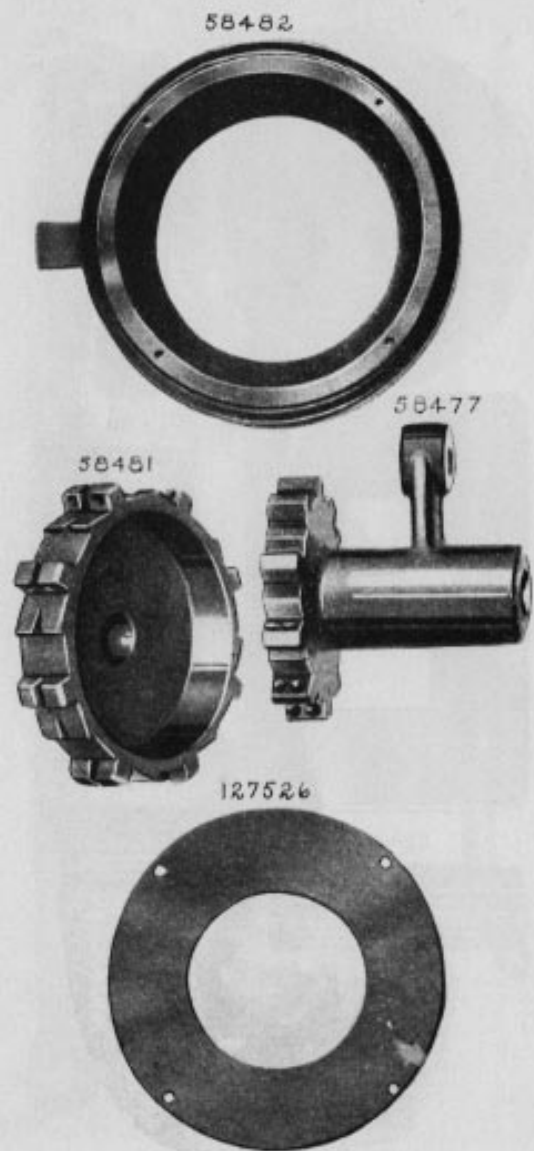


PLATE 7887—ONE-HALF SIZE

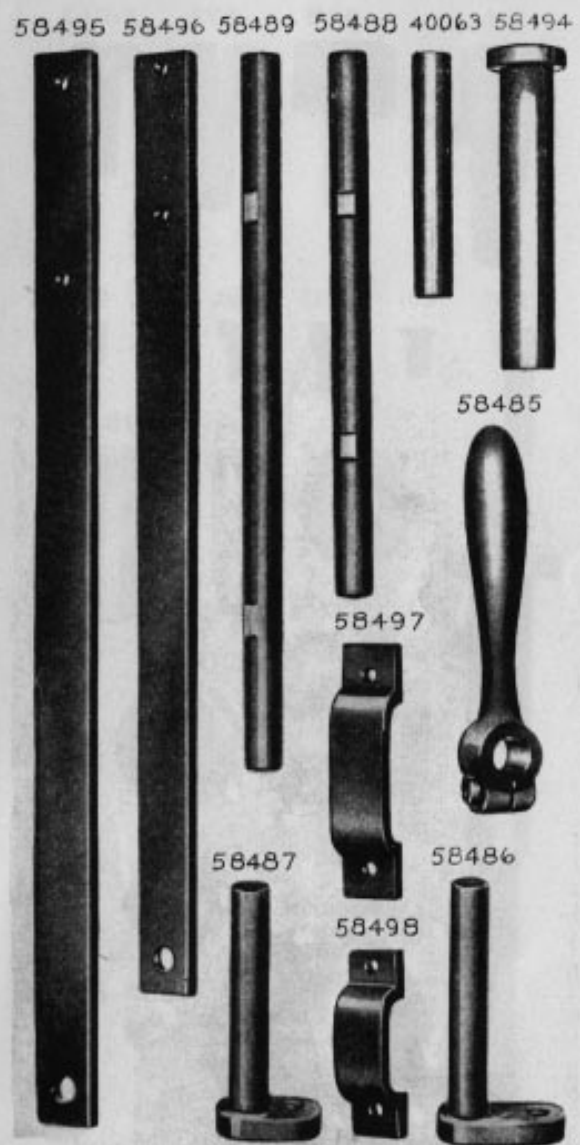


PLATE 7888—FULL SIZE

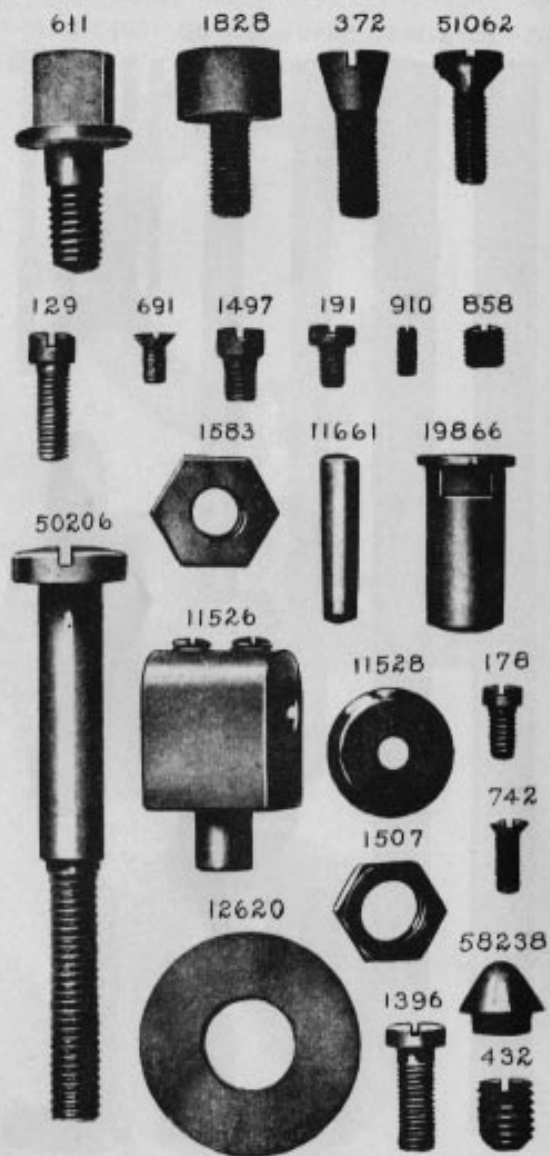


PLATE 7889—FULL SIZE

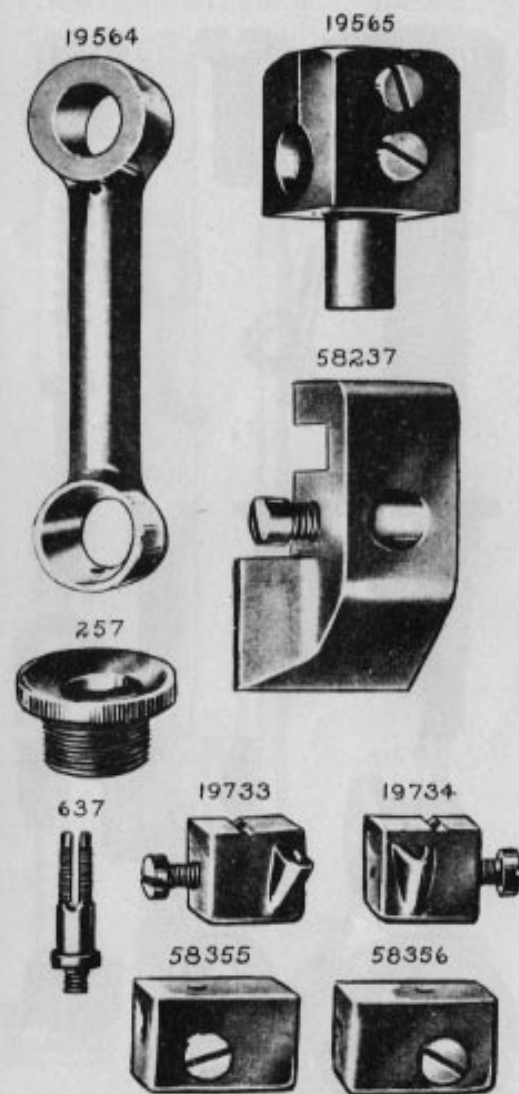


PLATE 7890—FULL SIZE

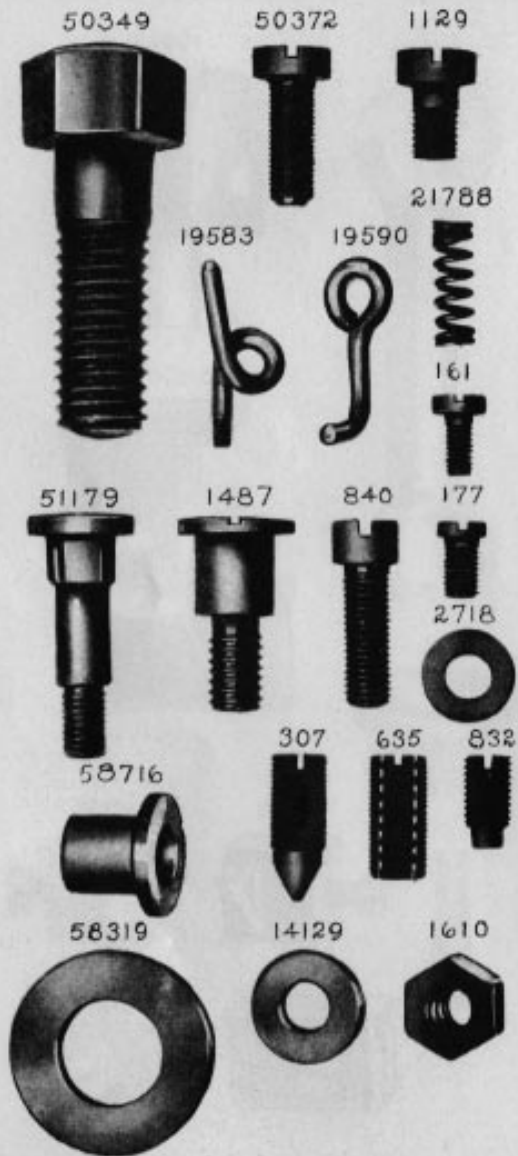


PLATE 7891—ONE-HALF SIZE

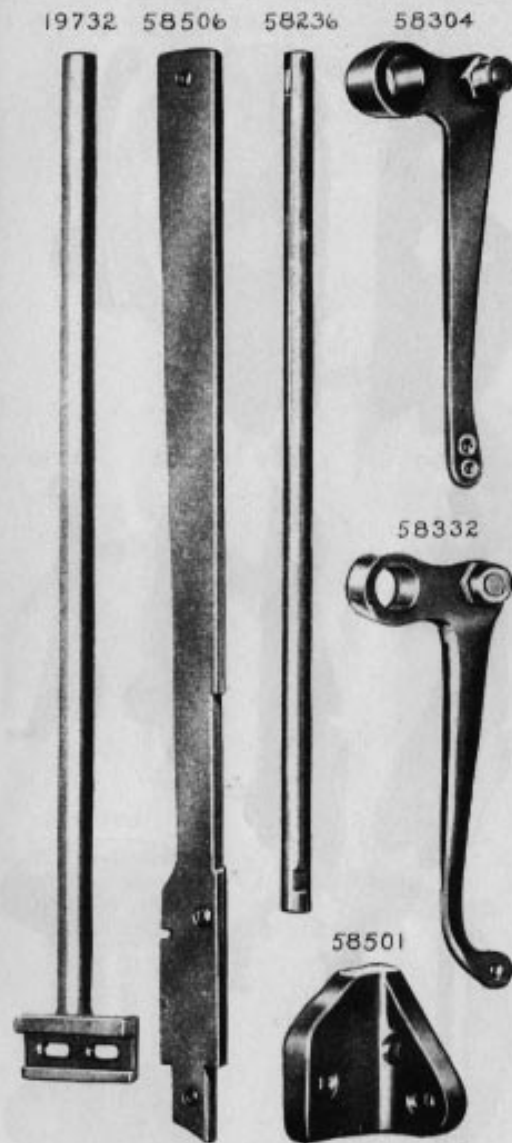


PLATE 7892—FULL SIZE

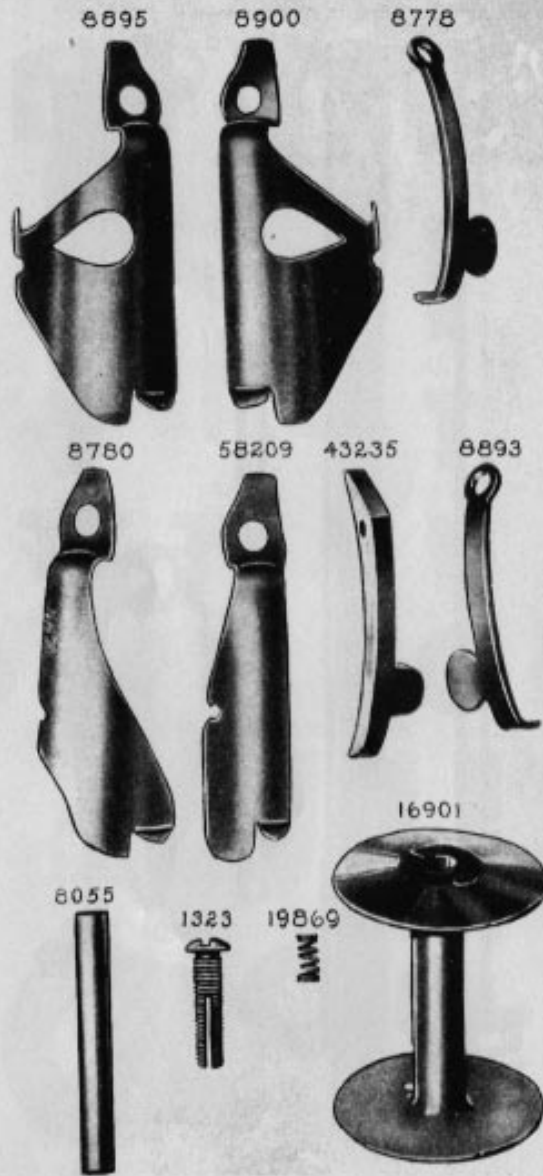


PLATE 7893—ONE-HALF SIZE

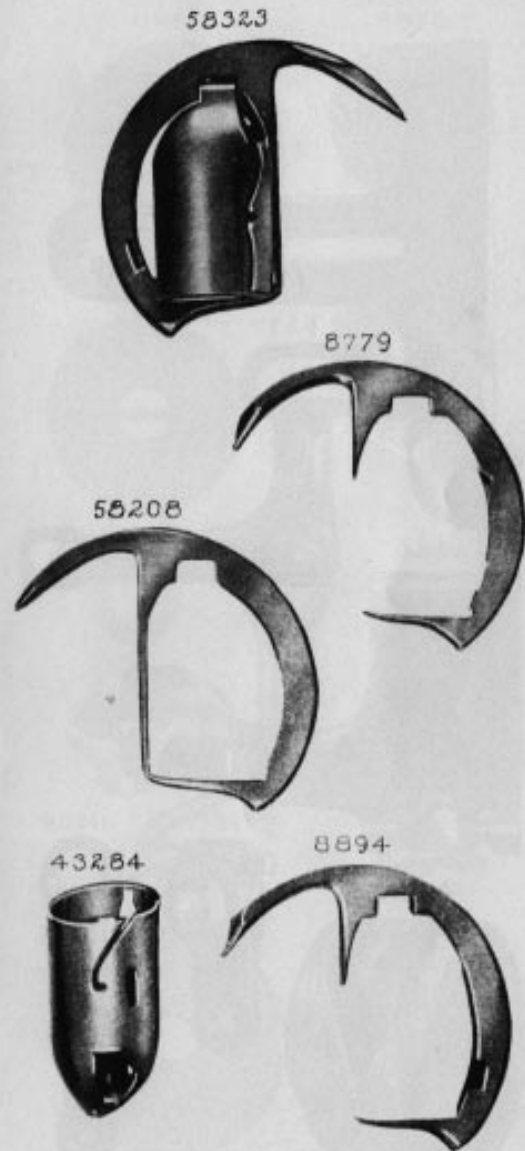


PLATE 7894—ONE-HALF SIZE

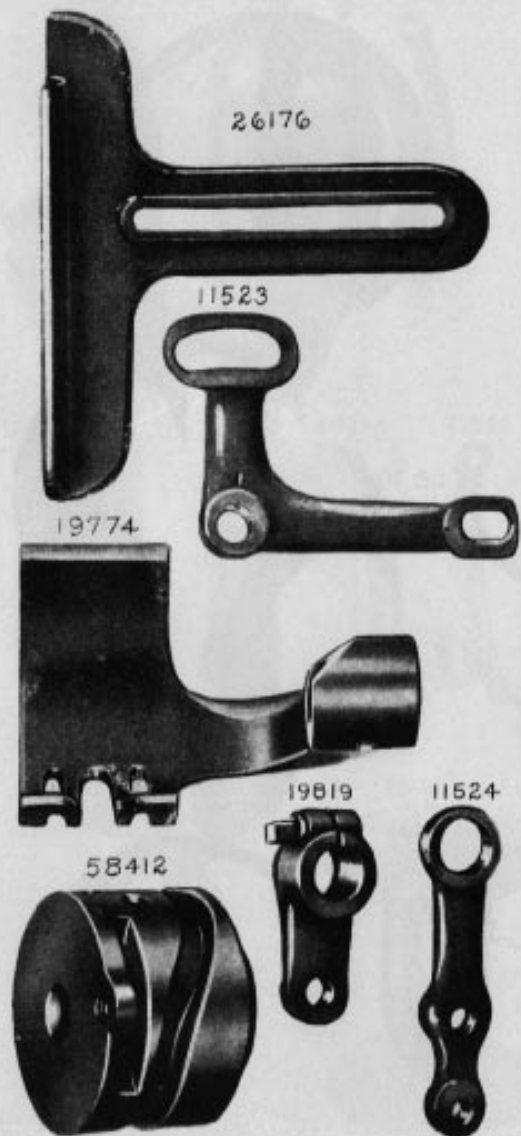


PLATE 7895—FULL SIZE

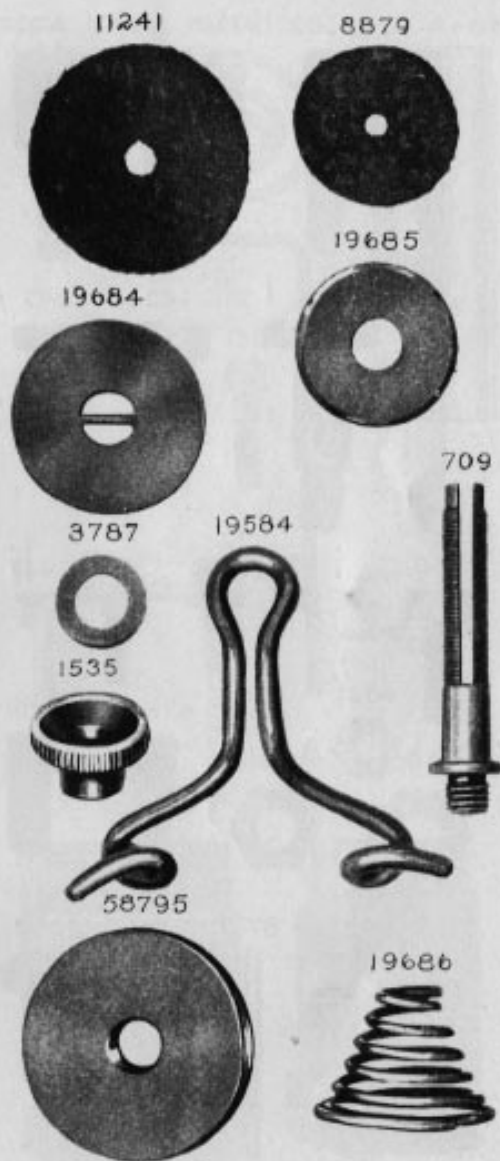
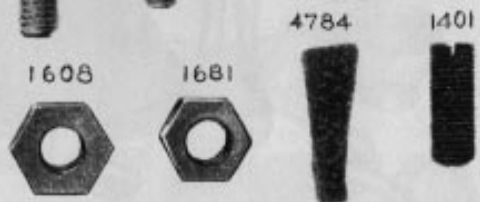
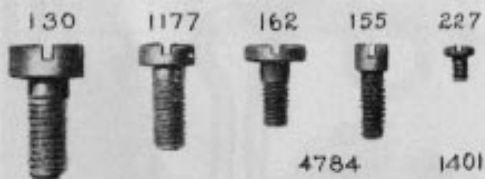
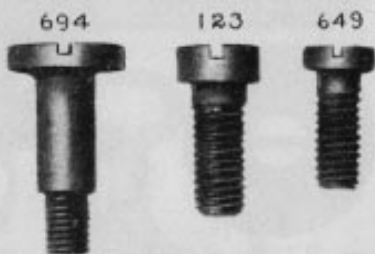


PLATE 7896—FULL SIZE

58476 8582 127525 127531 2002



9219 127529 8777 58277 50581

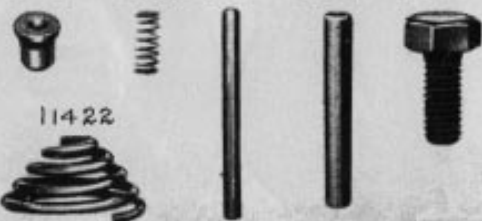


PLATE 7897—FULL SIZE

612 11874 11875

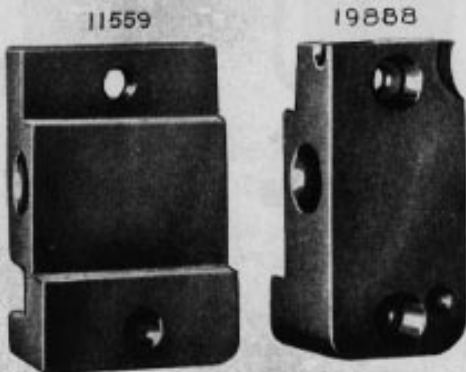


PLATE 7898—FULL SIZE

58502



58507



58505



58503



421



121



126207



201018 208 200383



225393

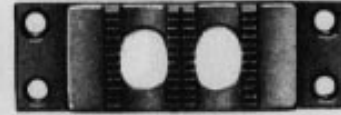


201696

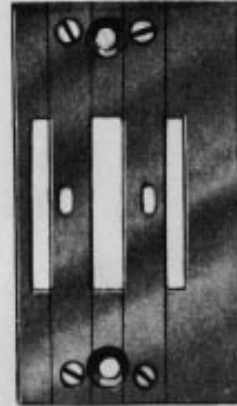


PLATE 7899—ONE-HALF SIZE

58389



58438



58436



58437



19595

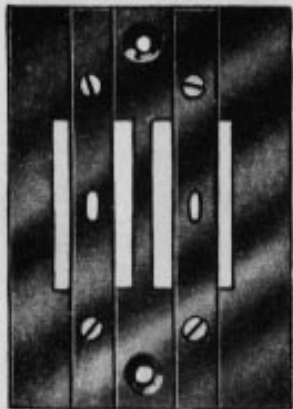


PLATE 9601—ONE-HALF SIZE

58414



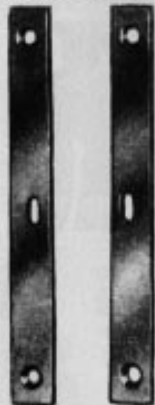
58421



58420



58455 58456



58457

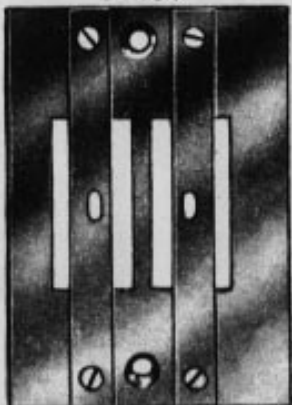


PLATE 9602—ONE-HALF SIZE

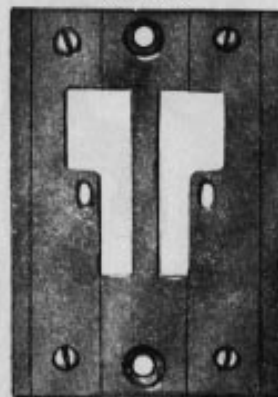
58427



58428



58429



58415



58425



58423 58424



PLATE 9603—ONE-FOURTH SIZE

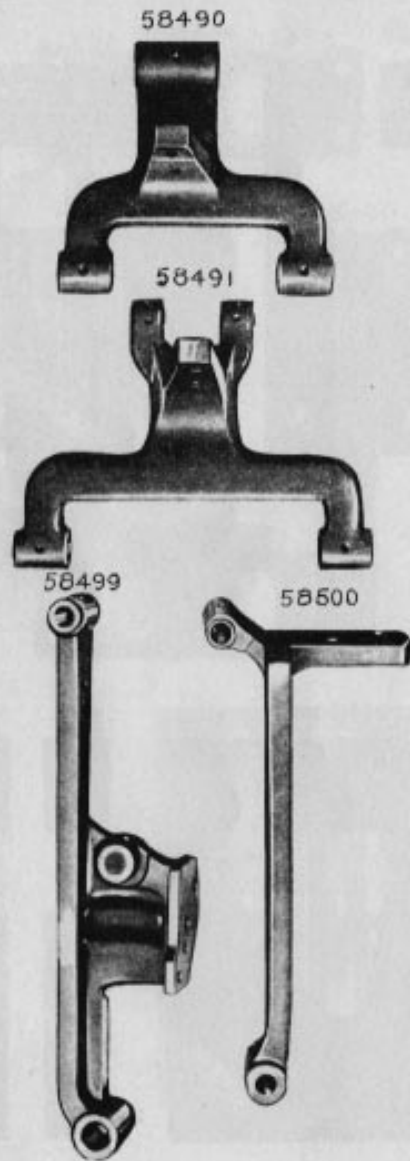


PLATE 9604—ONE-HALF SIZE

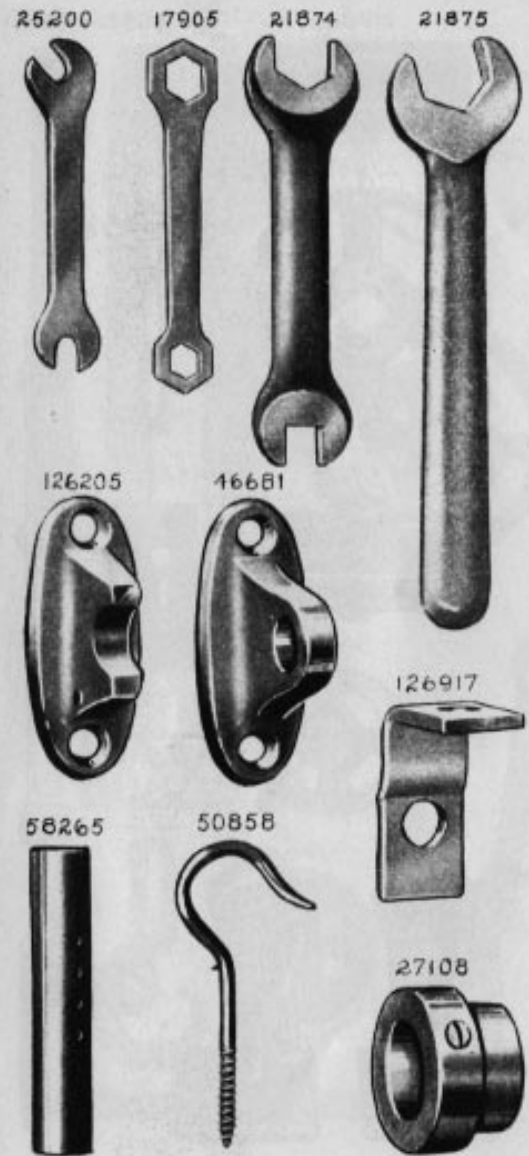


PLATE 9605—ONE-FOURTH SIZE

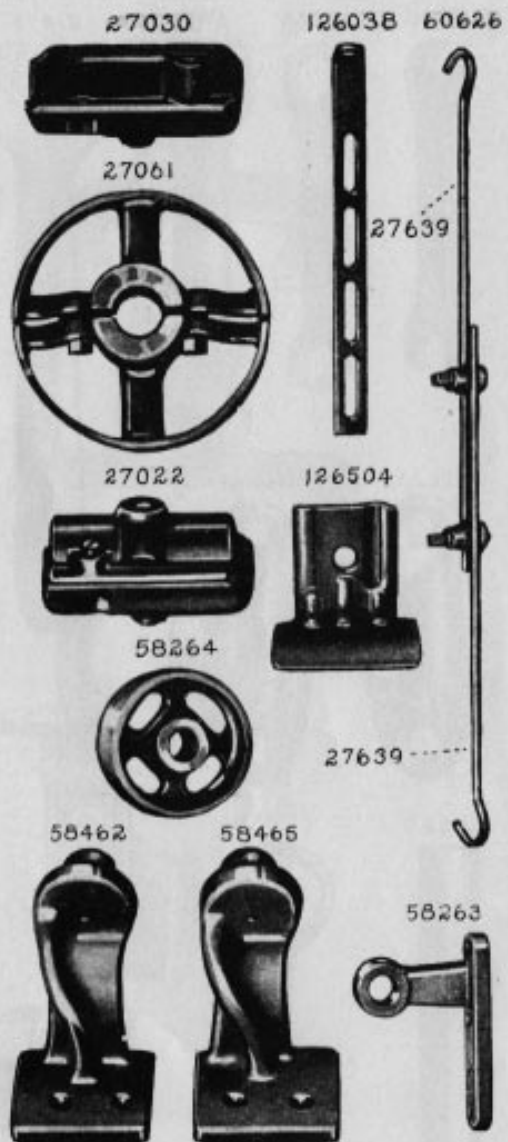


PLATE 9606—ONE-EIGHTH SIZE

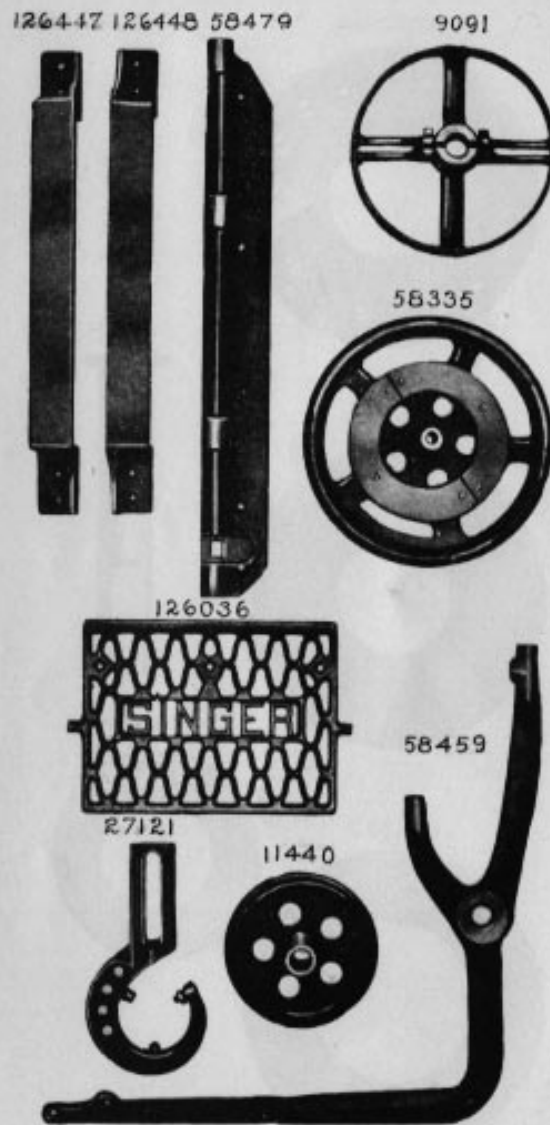
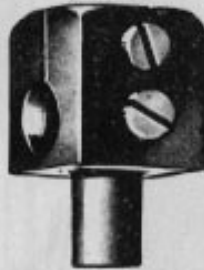


PLATE 7889—FULL SIZE

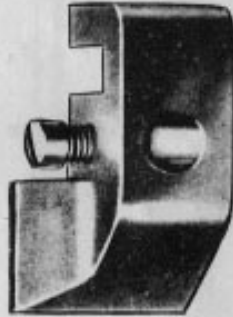
19564



19565



58237



257



637



19733



19734



58355



58356

