

HISTORICAL COPY

Form 8427, Revised
(437)

DO NOT REMOVE

Printed in U. S. A.

LIST
OF
PARTS



MACHINE No. 24-56

THE SINGER MANUFACTURING COMPANY

INSTRUCTIONS FOR OILING

To ensure easy running and prevent unnecessary wear of the parts which are in movable contact, the machine requires oiling and when in continuous use, it should be oiled at least twice each day with Singer Manufacturing Sewing Machine Oil (Cloth and Leather).

"Do not oil the automatic tension".

Copyright, U. S. A., 1915, 1917, 1935 and 1937,
by The Singer Manufacturing Co.
All Rights Reserved for all Countries

INDEX

	Page
Accessories.....	10
Foot Lifter Parts.....	10
Knee Lifter Parts.....	11
Machine Base.....	10
Machine No. 24-56.....	5
Numerical List of Parts.....	13
Obsolete Parts.....	13
Thread Unwinder.....	11

INSTRUCTIONS FOR ORDERING

In ordering from this list, use ONLY the part NUMBER in the FIRST column.

The number stamped on a Sewing Machine Part is in every case the number of the single part only.

Every combination of parts sent out as such has its specific number, which, although not stamped on the parts, must be used when ordering the combination.

Each number always indicates the SAME PART in whatever list it appears, or for whatever machine.

The letters after some of the numbers indicate the style of finish only, as follows:

- A-Hardened, Polished, Nickel Plated and Buffed
- B-Polished, Nickel Plated and Buffed
- C-Hardened Only
- D-Polished Only
- E-Soft, Not Polished
- F-Hardened and Polished
- F.J-Hardened, Polished and Nickel Plated
- G-Bright Rumbled and Nickel Plated
- H-Blued
- J-Nickel Plated Only
- K-Hardened and Nickel Plated
- L-Brass Plated
- M-Oxidized
- N-Japanned, Dull
- P-Japanned, Bright
- R-Merlized
- S-Cadmium Plating
- T-Copper Plated
- T.A-Hardened, Polished, Copper and Nickel Plated and Buffed
- T.B-Copper and Nickel Plated and Polished
- T.J-Copper and Nickel Plated Only
- T.K-Hardened, Copper and Nickel Plated
- T.M-Copper Plated and Oxidized
- T.L-Copper and Brass Plated
- U-Zinc Plated
- V-Silver Plated
- W-Polished and Nickel Plated
- Y-Black Nickel Plated Only
- Z-Chromium Plated
- Z.B-Polished, Nickel Plated, Buffed and Chromium Plated
- Z.J-Nickel and Chromium Plated

These letters MUST BE USED when they appear in the list; and AFTER the number as in the list.

In this series:

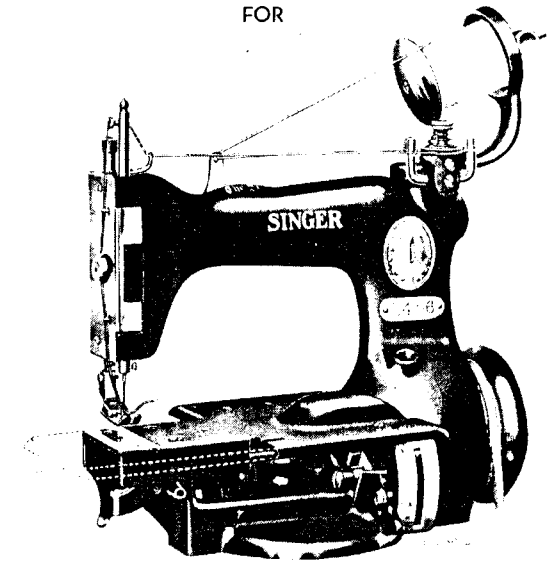
- 1 to 1500, 50001 to 51500 and 140001 to 142000 are Screw Numbers
- 1501 to 1800 and 51501 to 51800 are Nut Numbers
- 1801 to 2000 and 51801 to 52000 are Roller Numbers
- 2001 to 50000 and 52001 to 140000 and 142001 to 190000 are Sewing Machine Parts, 190001 and upward are numbers of Electrical Parts.

The figures in the second column refer only to the plates, illustrating the parts, and are NOT TO BE USED in ordering.

Parts marked with an asterisk (*) are furnished only when repairs are made at factory.

LIST OF PARTS COMPLETE

FOR



MACHINE No. 24-56

For Caps and Similar Articles. Makes 4 to 12 stitches to the inch. Has plain tension; disc spool holder. The cloth plate is arranged so that the left hand end can be removed, giving a 2 1/2 inch bearing at the front of the machine, so that it can be used as a cylinder machine. Speed 3200 R. P. M.

No.	Plate	Name
*34359	----	Arm, upper and lower (solid) with 15404, 34381 and two each 130E and 15405..
34461	7173	Arm End Cover and Belt Guard.....
	219F 7169	" " " " " " Screw.....
34360	7172	" Rock Shaft.....
34361	4298	" " " Bushing (back).....
	457C 4298	" " " " " Set Screw..
34362	4298	" " " " (front).....
	447C 4298	" " " " " Set Screw..
32034	4298	" " " Crank (back) with 1259C and 1439C.....
1439C	4298	Arm Rock Shaft Crank (back) Position Screw.....
1259C	4298	Arm Rock Shaft Crank (back) Set Screw...

PARTS FOR MACHINE No. 24-56

No.	Plate	Name
34363	4298	Arm Rock Shaft Crank (front) with two 1259C.....
1259C	4298	Arm Rock Shaft Crank (front) Position Screw.....
1259C	4298	Arm Rock Shaft Crank (front) Set Screw.
32149	7172	" Rotary Shaft with 1019C.....
34364	4298	" " " Bushing (back) bronze.
440C	4298	" " " " " Set Screw
34427	4298	" " " " (front) bronze.
624C	4298	" " " " " Set Screw
34462	7171	Balance Wheel and Connecting Rod Eccentric, 2 3/8 in. diam. with 1354C...
34574	----	Balance Wheel and Connecting Rod Eccentric 34462 with 34573.....
32225	7171	Balance Wheel and Connecting Rod Eccentric Oil Pad (felt).....
32228	4298	Balance Wheel and Connecting Rod Eccentric Oil Pad Oil Hole Packing (braided cotton).....
1354C	7167	Balance Wheel and Connecting Rod Eccentric Set Screw.....
34366	7173	Cloth Plate with two 1602E.....
34448	----	" " 34366 with 34370 and two 228D
34367	----	Cloth Plate complete, Nos. 111D, 1423D, 34368, 34369, 34371, 34394, 34448 and two each 228D and 934D.....
1602E	4298	Cloth Plate Bushing.....
34368	7171	" " Extension.....
34369	4298	" " " Position Plate....
228D	4298	" " " " " Screw
34370	4298	" " " " " Support.....
228D	4298	Cloth Plate Extension Position Plate Support Screw.....
1423D	7167	Cloth Plate Extension Screw.....
34371	4298	" " " Oil Hole Cover.....
111D	4298	" " " " " Hinge Screw..
691F	7169	" " " Screw (left).....
219F	7169	" " " (right).....
34463	7172	Connecting Rod with two 1057E.....
34573	----	" " 34463 with 1139C and 1520E
1057E	7168	" " Cap Screw.....
1139C	4298	" " Hinge Screw.....
1520E	4298	" " " " " Nut.....
34311	7167	Face Plate with two 2827.....
337D	7167	" " Screw.....
2827	7167	" " Thread Guard with 8505.....
8505	7167	" " " " Rivet.....
34373	7171	Feed Bar.....
34374	7168	" " Hinge Pin.....

PARTS FOR MACHINE No. 24-56

No.	Plate	Name
457C	4298	Feed Bar Hinge Pin Set Screw.....
34375	7168	" Dog for 34394 and 34414.....
190D	7166	" " Screw.....
34188	7167	" Eccentric with two 1259C.....
34572	----	" " 34188 with 34157.....
34090	7167	" " Collar with 452C.....
452C	7167	" " " Set Screw.....
1259C	4298	" " Position Screw.....
1259C	4298	" " Set Screw.....
34157	7167	" " Sleeve.....
34158	7167	" Forked Connection.....
378C	7167	" " " Hinge Screw.....
1520E	4298	" " " " " Nut...
1832	7167	" " " " Roller with 1085E.
1085E	7167	" " " " " Screw Stud.
34189	7151	" Lifting Eccentric with two 1259C...
34093	7151	" " " Connection.....
34348	----	" " " " " 34093 with 34189.....
1259C	4298	Feed Lifting Eccentric Position Screw...
1259C	4298	" " " Set Screw.....
34206	7151	" Regulator.....
34095	7151	" " Crank with 230F and 34096
34096	7151	" " " Pin.....
230F	7151	" " " Set Screw.....
1215E	7151	" " Hinge Screw.....
34097	7151	" " Indicator.....
34211	7151	" " " Hinge Pin.....
34377	7151	" " " Plate.....
34378	7151	" " " " Extension
810D	7151	" " " " " Screw.....
335D	7151	Feed Regulator Indicator Plate Screw....
1083C	7151	" " Locking Screw.....
34099	7151	" " " " Washer.....
34379	7168	" Rock Shaft with two 457C.....
34380	----	Feed Rock Shaft complete, Nos. 635C, 34379 34382, 34384 and two 1513J.....
34381	7172	Feed Rock Shaft Bracket.....
130E	7168	" " " " Screw.....
34382	7168	" " " Crank with two 1057E....
1057E	7168	" " " Cap Screw.....
34384	7168	" " " Hinge Pin.....
1513J	7168	" " " " " Nut.....
635C	7168	" " " " " Screw Bearing.
1513J	7168	" " " " " " " Nut
36747	7173	Guide.....
50190B	7169	" Thumb Screw.....
34436	7168	Looper with 34418.....
34530	7169	" Gate.....

No.	Plate	Name
1105D	7168	Looper Gate Hinge Screw.....
22350	7168	" " Spring.....
1019C	7168	" Set Screw.....
34418	7168	" Washer.....
34386	7153	Needle Bar with 9611 and 50138F.....
34387	7153	" " Bushing (lower).....
465C	7153	" " " " Set Screw.....
9830	7153	" " " (upper).....
465C	7153	" " " " Set Screw.....
34170	7153	" " Connecting Link with two 1313E
1313E	7153	" " " " Adjusting Screw
9570	7153	" " " Stud with 207E.....
207E	7153	" " " " Clamping Screw
9611	7153	" " Thread Tube.....
50138F	7153	" Set Screw.....
34103	7153	Presser Bar.....
34104	7153	" " Guide Bracket with 223E.....
223E	7153	" " " " Adjusting Screw
34388	7153	" " " " Guide.....
457C	4298	" " " " Set Screw
999F	7153	" " " " Set Screw.....
34389	7153	" " Lifter.....
50293E	7153	" " Hinge Screw.....
1521E	7153	" " " " Nut.....
38617	7153	" " Spring.....
22405	7153	" " Washer.....
26276	4298	" Foot Hinge Pin.....
34390	----	" " Plate.....
34391	----	" " Shank.....
34392	7166	Presser Foot (hinged) complete, Nos. 26276 34390 and 34391.....
34440	7166	Presser Foot.....
34441	7166	" Foot.....
185H	7166	" " Screw.....
1121D	7153	Pressure Regulating Thumb Screw.....
19064	7171	Spool Bracket with 1009C.....
29627	7168	" " Dowel Pin.....
1008D	7168	" " Screw.....
19066	7168	" Spindle.....
1009C	7168	" " Set Screw.....
19067	7169	" Thread Guiding Disc.....
691A	7169	" " " " Screw.....
32012	7169	Tension Disc.....
1560C	7169	" Regulating Thumb Nut.....
13710	7169	" Spring.....
1084C	7169	" Stud.....
34540	----	" " 1084C with 1560C.....
219F	7169	" " Set Screw.....
34393	7169	" Thread Guard (left).....
32065	7169	" " " (right).....

No.	Plate	Name
219F	7169	Tension Thread Guard Set Screw.....
22375	7169	Thread Eyelet (side of arm).....
701D	7169	" " " " " Screw.....
19074	7169	" " (top of arm).....
330D	7169	" " " " Screw.....
9543	7169	" Nipper Disc.....
9544	7169	" " " Cover.....
228D	4298	" " " " Screw.....
9545	7169	" " " Spring (light).....
34394	7166	Throat Plate, large needle hole, for 34375.....
34414	7166	Throat Plate, small needle hole, for 34375.....
934D	7166	Throat Plate Screw.....
*15404	----	Trade Mark.....
15405	----	" " Rivet.....

Genuine Singer Needles should be used
in Singer Machines.
These Needles and their Containers
are marked with the
Company's Trade Mark "SIMANCO." 1

Needles in Containers marked
"For Singer Machines"
are not Singer made needles. 2

MACHINE BASE

No.	Plate	Name
34207	7173	Machine Base with three wood screws 1 1/4 in. No. 12.....
544J	7171	Machine Thumb Screw.....
9842	7170	" " " Washer.....

ACCESSORIES

No.	Plate	Name
34420	7173	Machine Cushion (felt).....
474J	7171	" Thumb Screw.....
2015	7170	" " " Cushion (rubber)....
9842	7170	" " " Washer.....
36569	7171	Oiler with 36571.....
36570	----	" 36569 filled with oil.....
36571	7171	" Spout, 1 3/4 in. long with 36807..
36807	7170	" " Washer (leather).....
26026	7172	Screw Driver (machine).....
26485	7172	" " (shuttle tension).....
25539	7172	Stiletto.....
8908	7172	Wrench for 1520.....
8909	7172	" " 1513.....
19079	7172	" " 1083 and 1521.....

FOOT LIFTER PARTS

No.	Plate	Name
6439	----	Chain, 36 in. to 45 in. long, with 56864 and 56865.....
Note: When ordering No. 6439, give length required.		
4879	7170	Chain Connecting Link.....
56864	7170	" Hook (large).....
56865	7170	" " (small).....
34449	7172	Lifting Lever.....
21D	7170	" " Hinge Screw.....
34450	7170	" " Link.....
766D	7170	" " " Hinge Screw.....
19081	7170	" " Spring.....
184D	7170	" " Stop Screw.....
59082	7173	Treadle.....
17881	7172	" Shaft.....
14369	7173	" Stand.....

FOOT LIFTER PARTS

No.	Plate	Name
59083	7173	Treadle complete, Nos. 4879, 14369, 17881, 59083 and two wood screws 1 1/4 in. No. 12.....
34451	----	Foot Lifter complete, Nos. 21D, 184D, 766D 8439, 19081, 34449, 34450 and 59083...

KNEE LIFTER PARTS

No.	Plate	Name
14224	----	Chain, length 10 1/4 in. with 56864.....
56864	7170	" Hook (large).....
34449	7172	Lifting Lever.....
21D	7170	" " Hinge Screw.....
34450	7170	" " Link.....
766D	7170	" " " Hinge Screw.....
19081	7170	" " Spring.....
184D	7170	" " Stop Screw.....
7124	7174	Rock Shaft.....
2764	7174	" " Hanger with two wood screws 1 in. No. 10.....
16846	7174	Rock Shaft Knee Arm.....
16847	7174	Rock Shaft Knee Arm complete, Nos. 2766, 2767 and 16846.....
2766	7174	Rock Shaft Knee Arm Hub with 356C.....
356C	7170	" " " " Set Screw.....
2767	7174	" " " " Plate with 356C.....
356C	7170	" " " " Set Screw.....
6337	7174	" " " " Lifting Bracket with two 356C Hook.....
7125	7174	" " " " " Set Screw....
356C	7170	" " " " " Set Screw....
356C	7170	" " " " " Set Screw....
2770	7174	" " " " Stop Dog with 356C.....
356C	7170	" " " " " Set Screw.....
34569	7174	Rock Shaft complete, Nos. 2770, 6337, 7124 7125, 16847 and two 2764.....
34452	----	Knee Lifter complete (power table) Nos. 21D, 184D, 766D, 14224, 19081, 34449, 34450 and 34569.....

THREAD UNWINDER

FOR ONE LARGE SPOOL OR ONE LARGE CONE OF THREAD

No.	Plate	Name
225259	8405	Spool Rest with 201018C.....
150203	8405	" " Cushion (felt).....
225388	8405	" " Rod.....

THREAD UNWINDER

No.	Plate	Name
200383C	7170	Spool Rest Rod Set Screw.....
201018C	7170	" " Set Screw.....
202490	8405	" Stand with 200383C.....
225391	8405	Thread Guide.....
201696J	7170	" " Lock Nut.....
225326	7170	" " Position Cup.....
225324	8405	" " Rod with 208E and 225322...
208E	7170	" " " Screw.....
225322	7170	" " " Washer.....
225260	8405	Thread Unwinder complete, Nos. 150203, 201696J, 202490, 225259, 225324, 225326 225388, 225391 and three wood screws 7/8 in. No. 12.....
27739	8405	Thread Cone (wood) for large cones.....
225390	8405	" " Holder, for inverted cones..

Note: Nos. 27739 and 225390 are used with, but not included in 225260.

OBSOLETE PARTS

No.	Plate	Name
32091	7173	Arm End Cover.....
32092	7172	" Rotary Shaft with 1019C, use 32149..
34365	7171	Balance Wheel and Connecting Rod Eccen- tric with 1354C, use 34462.....
34372	7172	Connecting Rod with 32096 and two 1057E.
34385	7170	Looper Gate, use 34530.....
50280J	7171	Machine Thumb Screw, use 474J.....
6335	7174	Rock Shaft Knee Arm.....
6336	7174	Rock Shaft Knee Arm complete, Nos. 2766, 2767 and 6335.....
7126	7174	Rock Shaft complete, Nos. 2770, 6336, 6337 7124, 7125 and two 2764.....
59051	7173	Treadle, obsolete, superseded by 59082, not interchangeable.....
7585	7172	Treadle Shaft.....
14210	7173	" Stand.....
59052	7173	Treadle complete, Nos. 4879, 7585, 14210, 59051 and four wood screws 1 1/4 in. No. 12, use 59083.....

NUMERICAL
LIST
OF PARTS

NUMERICAL LIST OF PARTS

No.	Plate	Name
21D	7170	Lifting Lever Hinge Screw, for 34451 and 34452.....
111D	4298	Cloth Plate Oil Hole Cover Hinge Screw, for 34367.....
130E	7168	Feed Rock Shaft Bracket Screw, for 34359
184D	7170	Lifting Lever Stop Screw, for 34451 and 34452.....
185H	7166	Presser Foot Screw.....
190D	7166	Feed Dog Screw.....
207E	7153	Needle Bar Connecting Stud Clamping Screw, for 9570.....
208E	7170	Thread Unwinder Thread Guide Rod Screw, for 225324.....
219F	7169	Arm End Cover and Belt Guard Screw.....
219F	7169	Cloth Plate Screw (right).....
219F	7169	Tension Stud Set Screw.....
219F	7169	" Thread Guard Set Screw.....
223E	7153	Presser Bar Guide Bracket Adjusting Screw, for 34104.....
228D	4298	Cloth Plate Extension Position Plate Screw, for 34367 and 34448.....
228D	4298	Cloth Plate Extension Position Plate Support Screw, for 34367 and 34448.
228D	4298	Thread Nipper Disc Cover Screw.....
230F	7151	Feed Regulator Crank Set Screw, for 34095
330D	7169	Thread Eyelet (top of arm) Screw.....
335D	7151	Feed Regulator Indicator Plate Screw....
337D	7167	Face Plate Screw.....
356C	7170	Rock Shaft Knee Arm Hub Set Screw, for 2766.....
356C	7170	Rock Shaft Knee Plate Set Screw, for 2767
356C	7170	" " Lifting Bracket Hook Set Screw, for 6337.....
356C	7170	Rock Shaft Lifting Bracket Set Screw, for 6337.....
356C	7170	Rock Shaft Stop Dog Set Screw, for 2770..
378C	7167	Feed Forked Connection Hinge Screw.....
440C	4298	Arm Rotary Shaft Bushing (back) Set Screw.....
447C	4298	Arm Rock Shaft Bushing (front) Set Screw
452C	7167	Feed Eccentric Collar Set Screw, for 34090.....
457C	4298	Arm Rock Shaft Bushing (back) Set Screw.
457C	4298	Feed Bar Hinge Pin Set Screw, for 34379.
457C	4298	Presser Bar Guide Bracket Guide Set Screw.....
465C	7153	Needle Bar Bushing (lower) Set Screw....
465C	7153	" " " (upper) Set Screw....

NUMERICAL LIST OF PARTS

No.	Plate	Name
474J	7171	Machine Thumb Screw (Accessories).....
544J	7171	" " Screw.....
624C	4298	Arm Rotary Shaft Bushing (front) Set Screw.....
635C	7168	Feed Rock Shaft Hinge Pin Screw Bearing, for 34380.....
691F	7169	Cloth Plate Screw (left).....
691A	7169	Spool Thread Guiding Disc Screw.....
701D	7169	Thread Eyelet (side of arm) Screw.....
766D	7170	Lifting Lever Link Hinge Screw, for 34451 and 34452.....
810D	7151	Feed Regulator Indicator Plate Extension Screw.....
934D	7166	Throat Plate Screw, for 34367.....
999F	7153	Presser Bar Guide Bracket Set Screw....
1008D	7168	Spool Bracket Screw.....
1009C	7168	" Spindle Set Screw, for 19064.....
1019C	7168	Looper Set Screw, for 32149.....
1057E	7168	Connecting Rod Cap Screw, for 34463.....
1057E	7168	Feed Rock Shaft Crank Cap Screw, for 34382.....
1083C	7151	Feed Regulating Locking Screw.....
1084C	7169	Tension Stud, for 34540.....
1085E	7167	Feed Forked Connection Roller Screw Stud for 1832.....
1105D	7168	Looper Gate Hinge Screw.....
1121D	7153	Pressure Regulating Thumb Screw.....
1139C	4298	Connecting Rod Hinge Screw, for 34573...
1215E	7151	Feed Regulator Hinge Screw.....
1259C	4298	Arm Rock Shaft Crank (back) Set Screw, for 32034.....
1259C	4298	Arm Rock Shaft Crank (front) Position Screw, for 34363.....
1259C	4298	Arm Rock Shaft Crank (front) Set Screw, for 34363.....
1259C	4298	Feed Eccentric Position Screw, for 34188.
1259C	4298	" " Set Screw, for 34188.....
1259C	4298	" Lifting Eccentric Position Screw, for 34189.....
1259C	4298	Feed Lifting Eccentric Set Screw, for 34189.....
1313F	7153	Needle Bar Connecting Link Adjusting Screw, for 34170.....
1354C	7167	Balance Wheel and Connecting Rod Eccentric Set Screw, for 34462.....
1423D	7167	Cloth Plate Extension Screw, for 34367..
1439C	4298	Arm Rock Shaft Crank (back) Position Screw, for 32034.....
1513J	7168	Feed Rock Shaft Hinge Pin Nut, for 34380.

NUMERICAL LIST OF PARTS

No.	Plate	Name
1513J	7168	Feed Rock Shaft Hinge Pin Screw Bearing Nut, for 34380.....
1520E	4298	Connecting Rod Hinge Screw Nut, for 34573
1520F	4298	Feed Forked Connection Hinge Screw Nut..
1521E	7153	Presser Bar Lifter Hinge Screw Nut.....
1560C	7169	Tension Regulating Thumb Nut, for 34540.
1602E	4298	Cloth Plate Bushing, for 34366.....
1832	7167	Feed Forked Connection Roller with 1085E
2015	7170	Machine Thumb Screw Cushion (rubber) Accessories.....
2764	7174	Rock Shaft Hanger with two wood screws 1 in. No. 10, for 34569.....
2766	7174	Rock Shaft Knee Arm Hub with 356C, for 16647.....
2767	7174	Rock Shaft Knee Plate with 356C, for 16647.....
2770	7174	Rock Shaft Stop Dog with 356C, for 34569
2827	7167	Face Plate Thread Guard with 8505, for 34311.....
4879	7170	Chain Connecting Link, for 59083.....
6335	7174	Rock Shaft Knee Arm, obsolete.....
6336	7174	Rock Shaft Knee Arm complete, Nos. 2766, 2767 and 6335, obsolete.....
6337	7174	Rock Shaft Lifting Bracket with two 356C for 34569.....
6439	----	Chain, 36 in. to 45 in. long with 58864 and 58865, for 34451.....
7124	7174	Rock Shaft, for 34569.....
7125	7174	" " Lifting Bracket Hook, for 34569.....
7126	7174	Rock Shaft complete, Nos. 2770, 6336, 6337 7124, 7125 and two 2764, obsolete...
7585	7172	Treadle Shaft, obsolete.....
8505	7167	Face Plate Thread Guard Rivet, for 2827.
8908	7172	Wrench for 1520 (Accessories).....
8909	7172	" " 1513 (Accessories).....
9543	7169	Thread Nipper Disc.....
9544	7169	" " " Cover.....
9545	7169	" " " Spring (light).....
9570	7153	Needle Bar Connecting Stud with 307E....
9611	7153	" " Thread Tube, for 34386.....
9830	7153	" " Bushing (upper).....
9842	7170	Machine Thumb Screw Washer.....
9842	7170	" " " " (Accessories).
13710	7169	Tension Spring.....
14210	7173	Treadle Stand, obsolete.....
14224	----	Chain, length 10 1/4 in. with 58864, for 34452.....
14369	7173	Treadle Stand, for 59083.....

No.	Plate	Name
*15404	----	Trade Mark, for 34359.....
15405	----	" " Rivet, for 34359.....
16646	7174	Rock Shaft Knee Arm, for 16647.....
16647	7174	Rock Shaft Knee Arm complete for 34569, Nos. 2766,2767 and 16648.....
17881	7172	Treadle Shaft, for 59083.....
19064	7171	Spool Bracket with 1009C.....
19066	7168	" Spindle.....
19067	7169	" Thread Guiding Disc.....
19074	7169	Thread Eyelet (top of arm).....
19079	7172	Wrench for 1083 and 1521 (Accessories)..
19081	7170	Lifting Lever Spring, for 34451 and 34452.....
22350	7168	Looper Gate Spring.....
22375	7169	Thread Eyelet (side of arm).....
22405	7153	Presser Bar Spring Washer.....
25539	7172	Stiletto (Accessories).....
26026	7172	Screw Driver (machine) Accessories.....
26276	4298	Presser Foot Hinge Pin, for 34392.....
26485	7172	Screw Driver (shuttle tension) Accessor- ies.....
27739	8405	Thread Unwinder Thread Cone (wood) for large cones.....
29627	7168	Spool Bracket Dowel Pin.....
32012	7169	Tension Disc.....
32034	4298	Arm Rock Shaft Crank (back) with 1259C and 1439C.....
32065	7169	Tension Thread Guard (right).....
32091	7173	Arm End Cover, obsolete.....
32092	7172	" Rotary Shaft with 1019C, obsolete, use 32149.....
32149	7172	Arm Rotary Shaft with 1019C.....
32225	7171	Balance Wheel and Connecting Rod Eccen- tric Oil Pad (felt).....
32226	4298	Balance Wheel and Connecting Rod Eccen- tric Oil Pad Oil Hole Packing (braided cotton).....
34090	7167	Feed Eccentric Collar with 452C.....
34093	7151	" Lifting Eccentric Connection, for 34348.....
34095	7151	Feed Regulator Crank with 230F and 34096
34096	7151	" " " Pin, for 34095.....
34097	7151	" " Indicator.....
34099	7151	" " Locking Screw Washer.....
34103	7153	Presser Bar.....
34104	7153	" " Guide Bracket with 223E.....
34157	7167	Feed Eccentric Sleeve, for 34572.....
34158	7167	" Forked Connection.....
34170	7153	Needle Bar Connecting Link with two 1313E.....

No.	Plate	Name
34188	7167	Feed Eccentric with two 1259C, for 34572.
34189	7151	" Lifting Eccentric with two 1259C, for 34348.....
34206	7151	Feed Regulator.....
34207	7173	Machine Base with three wood screws 1 1/4 in. No. 12.....
34211	7151	Feed Regulator Indicator Hinge Pin.....
34311	7167	Face Plate with two 2827.....
34348	----	Feed Lifting Eccentric Connection 34093 with 34189.....
*34359	----	Arm, upper and lower (solid) with 15404, 34381 and two each 130E and 15405..
34360	7172	Arm Rock Shaft.....
34361	4298	" " " Bushing (back).....
34362	4298	" " " " (front).....
34363	4298	" " " Crank (front) with two 1259C.....
34364	4298	Arm Rotary Shaft Bushing (back) bronze..
34365	7171	Balance Wheel and Connecting Rod Eccen- tric with 1354C, obsolete, use 34462
34366	7173	Cloth Plate with two 1602E, for 34448..
34367	----	Cloth Plate complete, Nos. 111D,1423D, 34368,34369,34371,34394,34448 and two each 228D and 934D.....
34368	7171	Cloth Plate Extension, for 34367.....
34369	4298	" " " Position Plate, for 34367.....
34370	4298	Cloth Plate Extension Position Plate Support, for 34448.....
34371	4298	Cloth Plate Oil Hole Cover, for 34367..
34372	7172	Connecting Rod with 32096 and two 1057E, obsolete.....
34373	7171	Feed Bar.....
34374	7168	" " Hinge Pin.....
34375	7166	" Dog for 34394 and 34414.....
34377	7151	" Regulator Indicator Plate.....
34378	7151	" " " Extension.
34379	7168	" Rock Shaft with two 457C, for 34380.
34380	----	Feed Rock Shaft complete, Nos. 635C, 34379,34382,34384 and two 1513J....
34381	7172	Feed Rock Shaft Bracket, for 34359.....
34382	7168	" " " Crank with two 1057E, for 34380.....
34384	7168	Feed Rock Shaft Hinge Pin, for 34380....
34385	7170	Looper Gate, obsolete, use 34530.....
34386	7153	Needle Bar with 9611 and 50138F.....
34387	7153	" " Bushing (lower).....
34388	7153	Presser Bar Guide Bracket Guide.....
34389	7153	" " Lifter.....

NUMERICAL LIST OF PARTS

No.	Plate	Name
34390	----	Presser Foot Plate, for 34392.....
34391	----	" " Shank, for 34392.....
34392	7166	Presser Foot (hinged) complete, Nos. 26276,34390 and 34391.....
34393	7169	Tension Thread Guard (left).....
34394	7166	Throat Plate, large needle hole, for 34375.....
34414	7166	Throat Plate, small needle hole, for 34375.....
34418	7168	Looper Washer, for 34438.....
34420	7173	Machine Cushion (felt) Accessories.....
34427	4298	Arm Rotary Shaft Bushing (front) bronze.
34436	7168	Looper with 34418.....
34440	7166	Presser Foot.....
34441	7166	" Foot.....
*34448	----	Cloth Plate 34366 with 34370 and two 228D, for 34367.....
34449	7172	Lifting Lever, for 34451 and 34452.....
34450	7170	" " Link, for 34451 and 34452.
34451	----	Foot Lifter complete, Nos. 21D,184D,768D 6439,19081,34449,34450 and 59083...
34452	----	Knee Lifter complete (power table) Nos. 21D,184D,768D,14224,19081,34449, 34450 and 34569.....
34461	7173	Arm End Cover and Belt Guard.....
34462	7171	Balance Wheel and Connecting Rod Eccen- tric, 2 3/8 in. diam. with 1354C, for 34574.....
34463	7172	Connecting Rod with two 1057E, for 34573.
34530	7169	Looper Gate.....
34540	----	Tension Stud 1084C with 1560C.....
34569	7174	Rock Shaft complete for 34452, Nos. 2770, 6337,7124,7125,16647 and two 2764..
34572	----	Feed Eccentric 34188 with 34157.....
34573	----	Connecting Rod 34463 with 1139C and 1520E, for 34574.....
34574	----	Balance Wheel and Connecting Rod Eccen- tric 34462 with 34573.....
36569	7171	Oiler with 36571 (Accessories).....
36570	----	" 36569, filled with oil (Accessories)
36571	7171	" Spout, 1 3/4 in. long with 36807, for 36569 (Accessories).....
36747	7173	Guide.....
36807	7170	Oiler Spout Washer (leather) for 36571 (Accessories).....
38617	7153	Presser Bar Spring.....
50138F	7153	Needle Set Screw, for 34386.....
50190B	7169	Guide Thumb Screw.....
50280J	7171	Machine Thumb Screw, obsolete, use 474J.

NUMERICAL LIST OF PARTS

No.	Plate	Name
50293E	7153	Presser Bar Lifter Hinge Screw.....
56864	7170	Chain Hook (large) for 6439 and 14224...
56865	7170	" " (small) for 6439.....
59051	7173	Treadle, obsolete, superseded by 59082, not interchangeable.....
59052	7173	Treadle complete, Nos. 4879,7585,14210, 59051 and four wood screws 1 1/4 in. No. 12, obsolete, use 59083....
59082	7173	Treadle, for 59083.....
59083	7173	Treadle complete for 34451, Nos. 4879, 14369,17881,59082 and two wood screws 1 1/4 in. No. 12.....
150203	8405	Thread Unwinder Spool Rest Cushion (felt) for 225260.....
200383C	7170	Thread Unwinder Spool Rest Rod Set Screw for 202490.....
201018C	7170	Thread Unwinder Spool Rest Set Screw, for 225259.....
201696J	7170	Thread Unwinder Thread Guide Lock Nut, for 225260.....
202490	8405	Thread Unwinder Spool Stand with 200383C for 225260.....
225259	8405	Thread Unwinder Spool Rest with 201018C, for 225260.....
225260	8405	Thread Unwinder complete, for one large spool, Nos. 150203,201696J,202490, 225259,225324,225326,225388,225391 and three wood screws 7/8 in. No. 12.
225322	7170	Thread Unwinder Thread Guide Rod Washer, for 225324.....
225324	8405	Thread Unwinder Thread Guide Rod with 208E and 225322, for 225260.....
225326	7170	Thread Unwinder Thread Guide Position Cup, for 225260.....
225388	8405	Thread Unwinder Spool Rest Rod, for 225260.....
225390	8405	Thread Unwinder Thread Cone Holder, for inverted cones.....
225391	8405	Thread Unwinder Thread Guide, for 225260

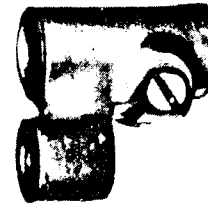
Genuine Singer Needles should be used
in Singer Machines.
These Needles and their Containers
are marked with the
Company's Trade Mark "SIMANCO." 1

Needles in Containers marked
"For Singer Machines"
are not Singer made needles. 2

ILLUSTRATIONS
OF
PARTS

PLATE 4298 - FULL SIZE

32034



34362



457



624



1259



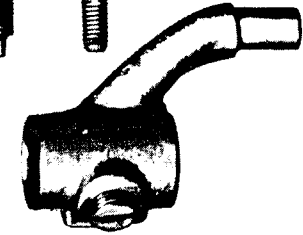
1439



447



34363



34361



34364



34427



440



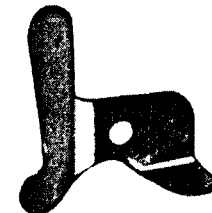
34370



34369



34371



1139



1602



228



26276



111



1520



32226



PLATE 7151 - FULL SIZE

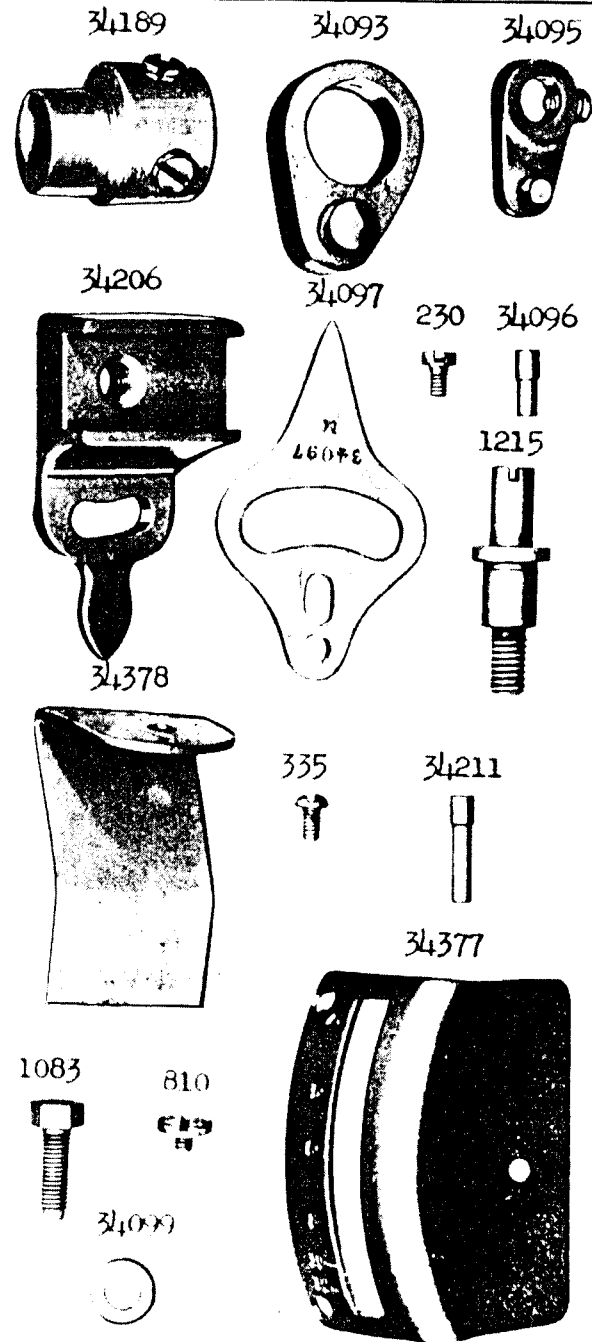


PLATE 7153 - FULL SIZE

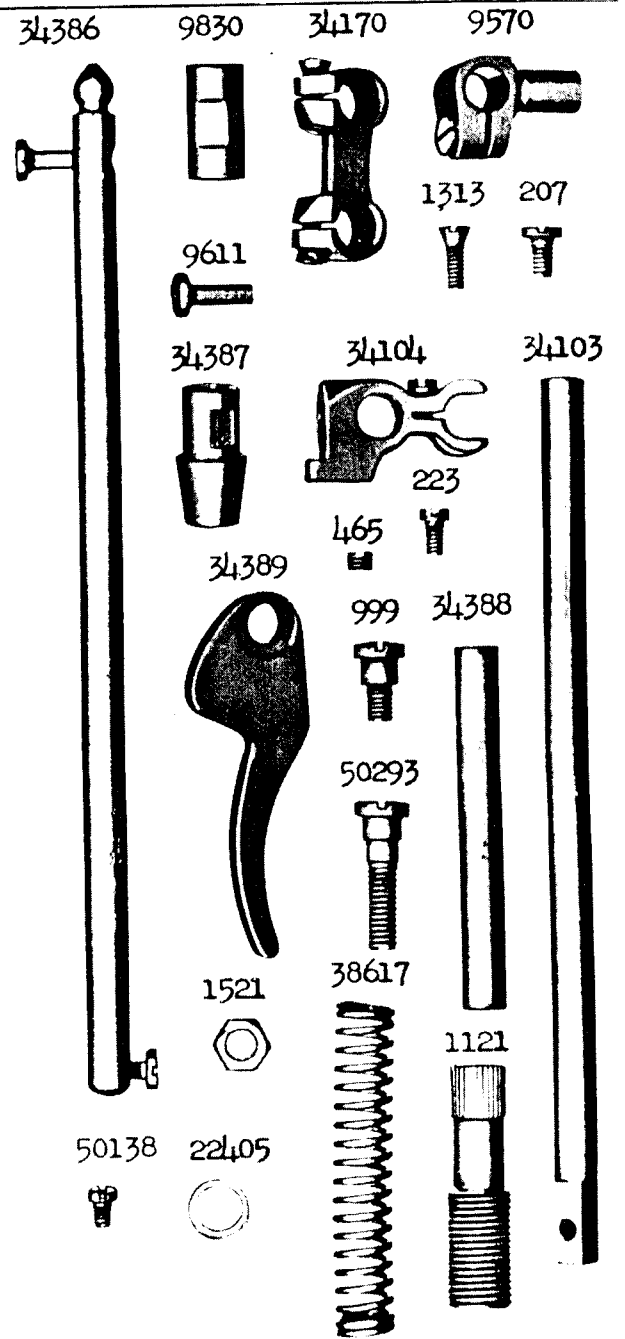
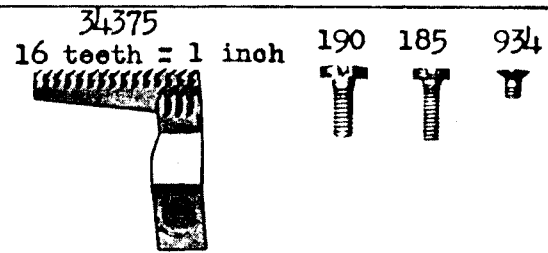


PLATE 7166 - FULL SIZE



34392



34440



34441



34394

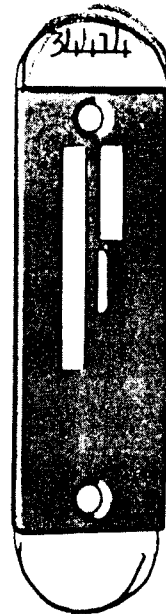
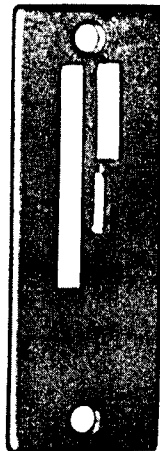


PLATE 7167 - FULL SIZE

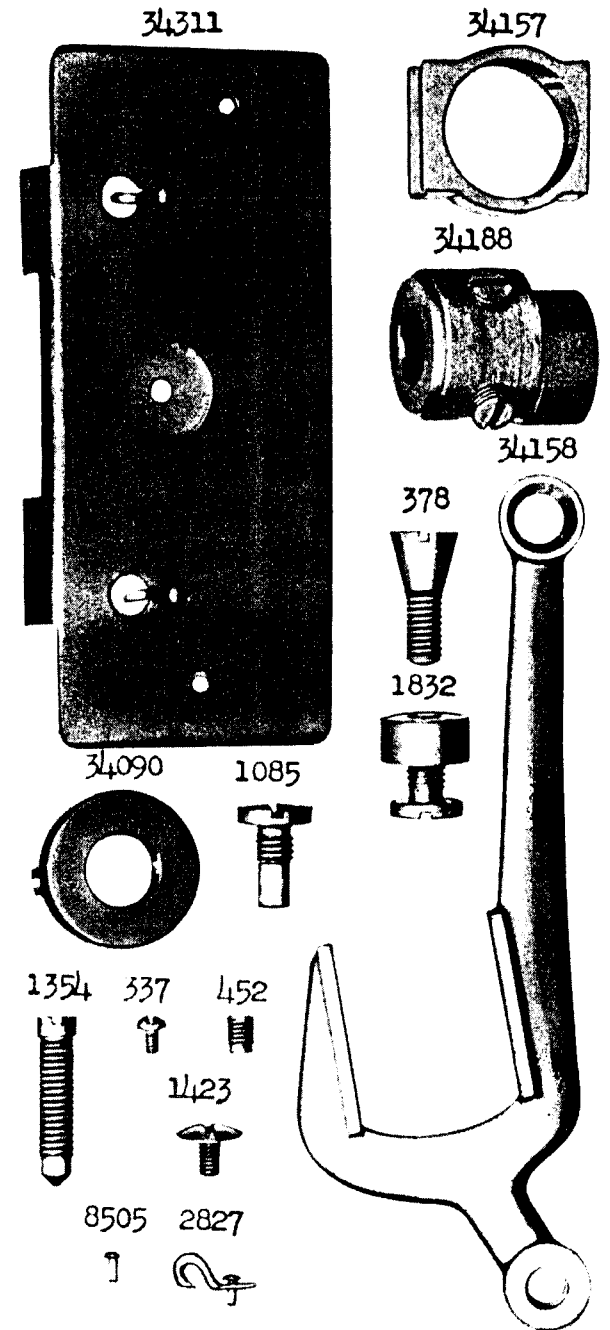


PLATE 7168 - FULL SIZE

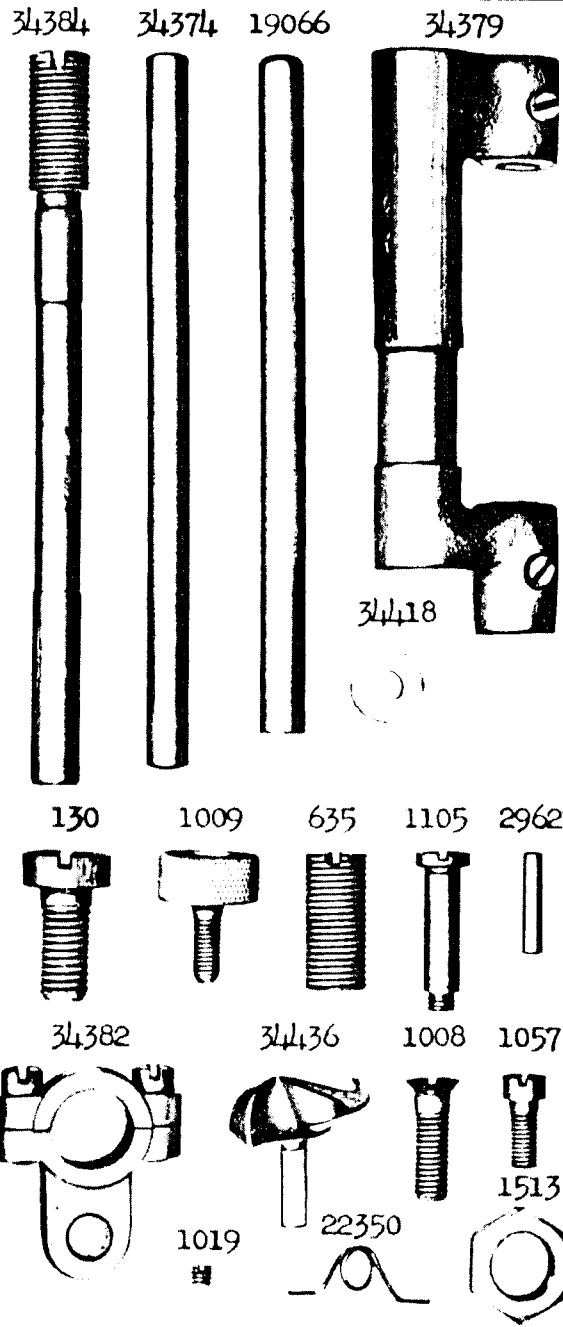


PLATE 7169 - FULL SIZE

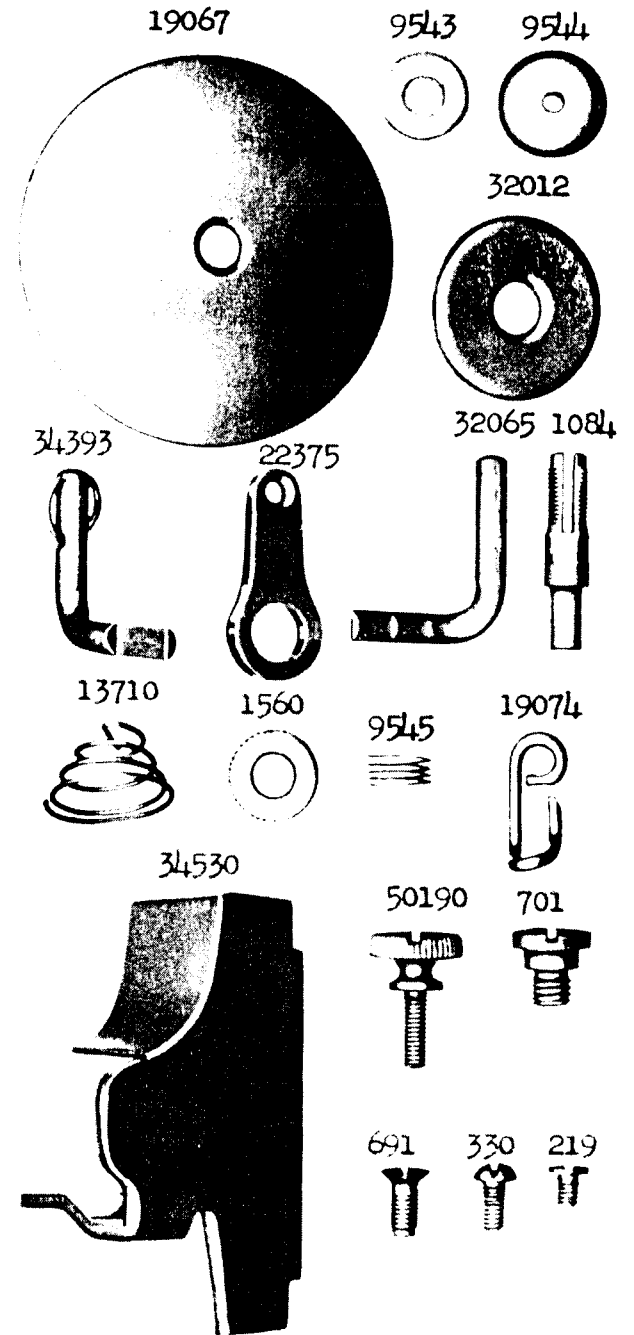


PLATE 7170 - FULL SIZE

34450



34385



356



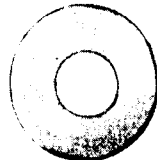
201018



21



9842



2015



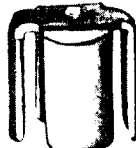
225322



36807



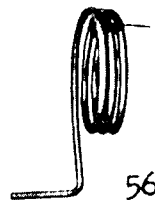
225326



4879



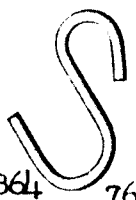
19081



56864



56865



766



201696



208



184

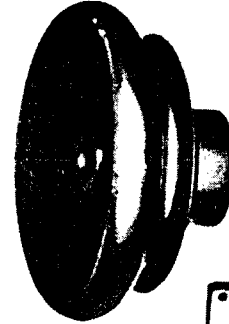


200383

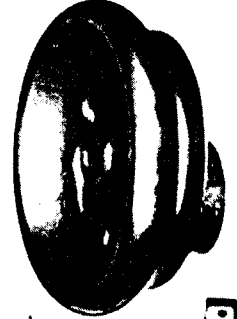


PLATE 7171 - ONE-HALF SIZE

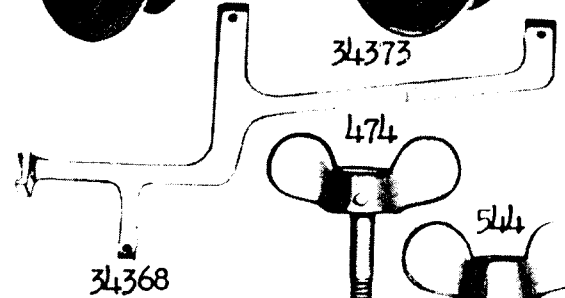
34365



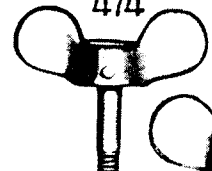
34462



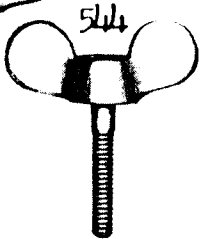
34373



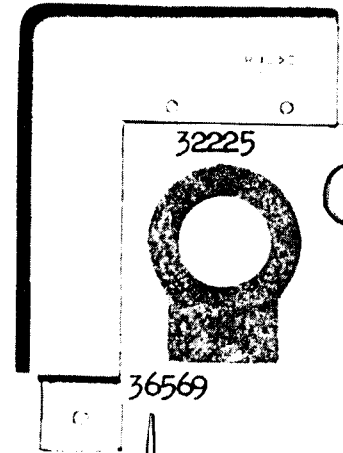
474



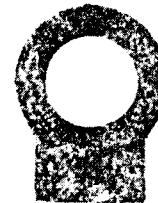
544



34368



32225



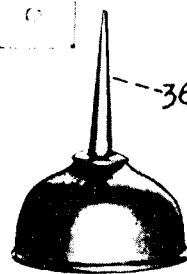
50280



19064



36569



36571

PLATE 7172 - ONE-HALF SIZE

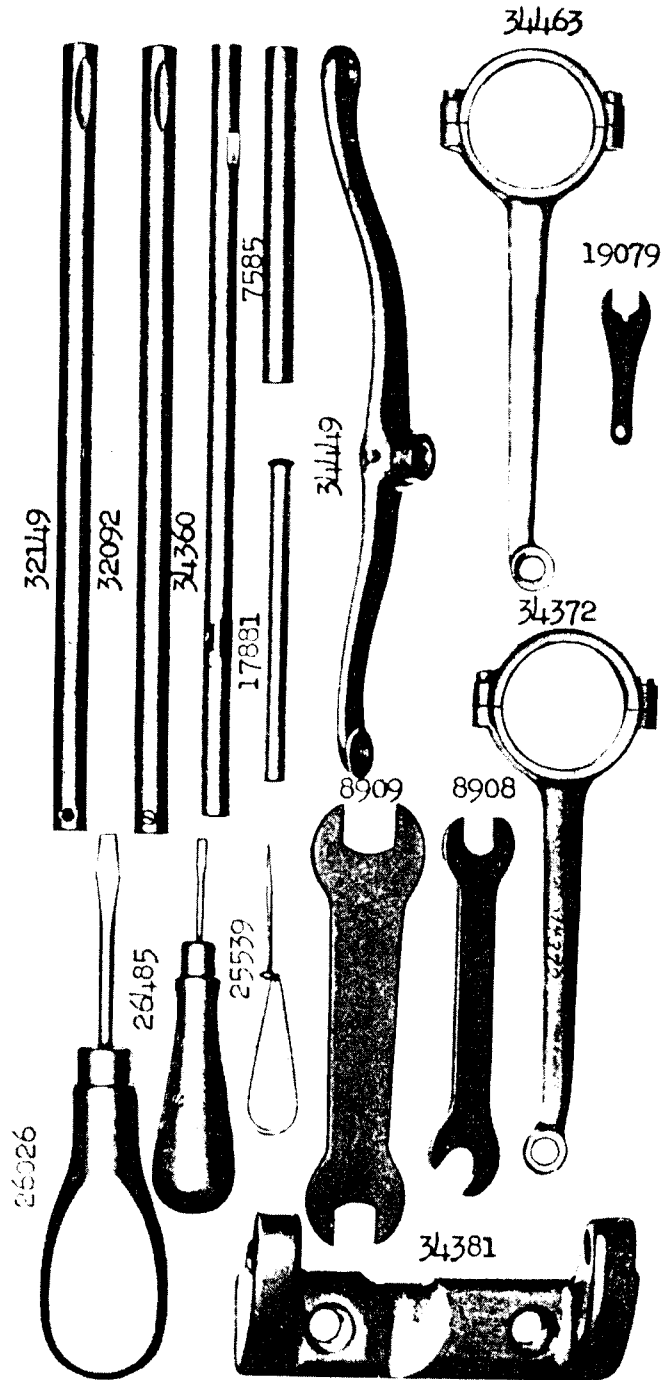


PLATE 7173 - ONE-FOURTH SIZE

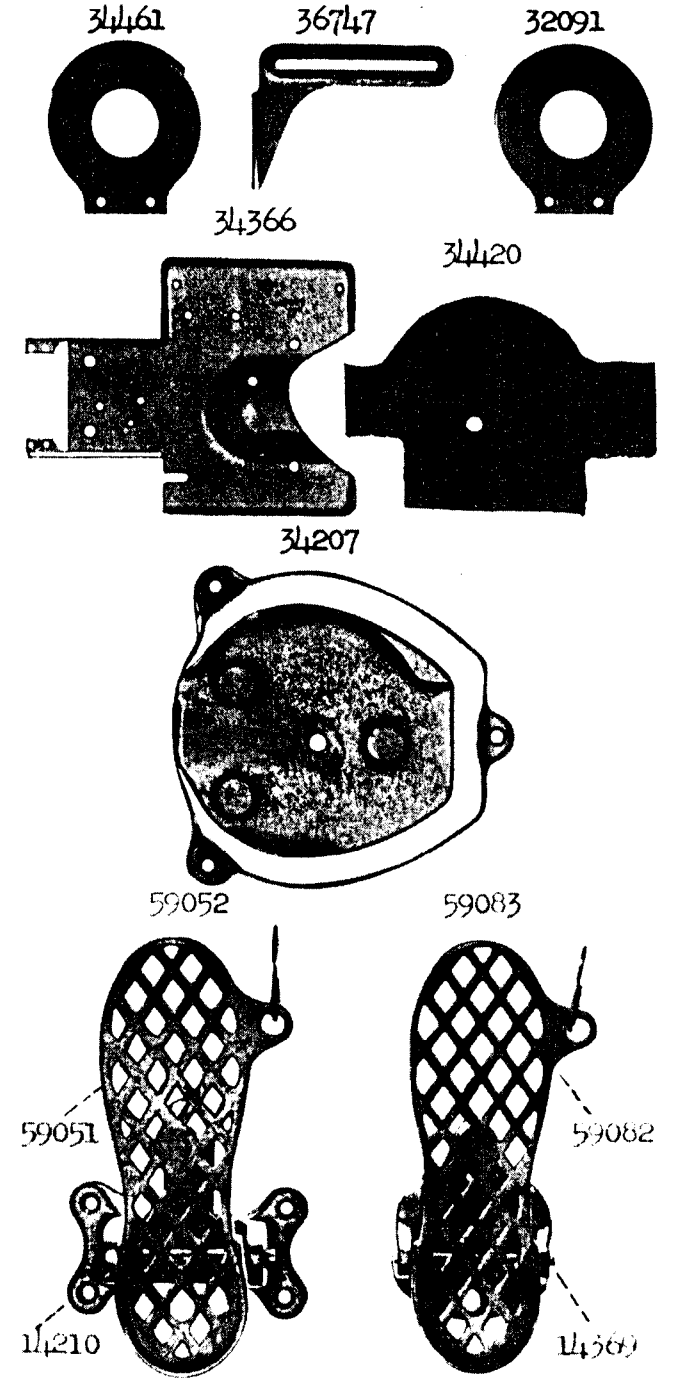


PLATE 7174 - ONE-FOURTH SIZE

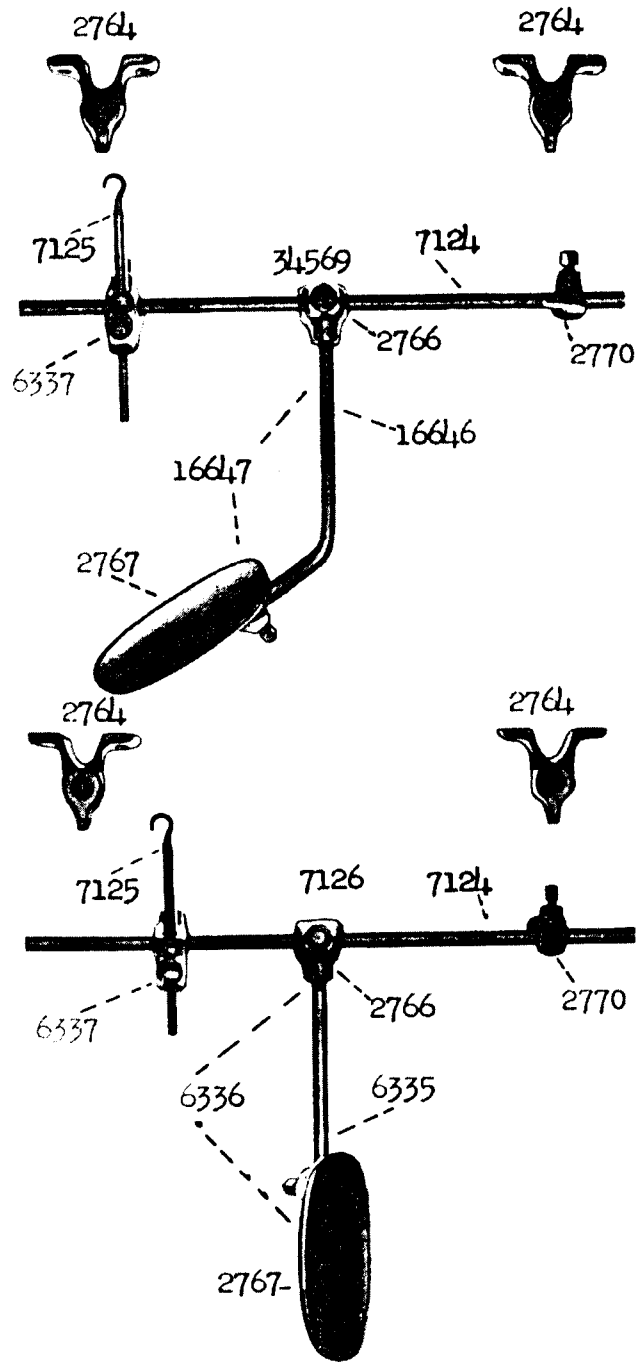
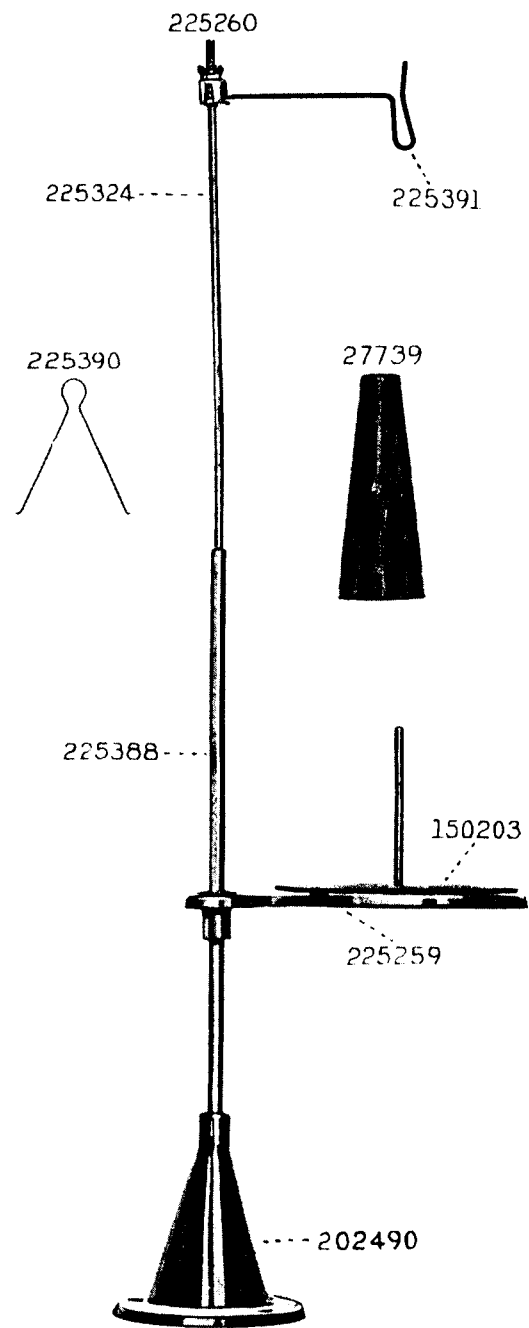


PLATE 8405—ONE-FOURTH SIZE



Genuine Singer Needles should be used
in Singer Machines.
These Needles and their Containers
are marked with the
Company's Trade Mark "SIMANCO." 1

Needles in Containers marked
"For Singer Machines"
are not Singer made needles. 2