

**SINGER**  
**61W18,W106**

# LIST OF PARTS



## MACHINES Nos. 61w18 and 61w106

THE SINGER MANUFACTURING COMPANY

### INDEX

---

|                               | PAGE   |
|-------------------------------|--------|
| ACCESSORIES .....             | 15     |
| BINDERS .....                 | 20     |
| BOBBIN WINDER .....           | 15     |
| FEED DOGS .....               | 18     |
| KNEE LIFTER PARTS .....       | 16, 17 |
| MACHINE No. 61w18 .....       | 7      |
| "    "    61w106 .....        | 14     |
| NUMERICAL LIST OF PARTS ..... | 23     |
| OBSOLETE PARTS .....          | 22     |
| PRESSER FEET .....            | 18     |
| RIBBON REELS .....            | 21     |
| THROAT PLATES .....           | 19     |

# Instructions for Ordering

In ordering from this list, use **ONLY** the **PART** number in the **FIRST** column.

The number stamped on a Sewing Machine Part is the number of the Single Part only, except when the part includes Set Screws, Clamping Screws, Studs and Rollers Spun on, Small Wires riveted, or Parts soldered together, etc., which it is necessary to furnish in combination.

Every combination of parts sent out has its specific number which, although not stamped on Parts (except in above cases) must be used when ordering the combination.

Each number always indicates the **SAME PART** in whatever list it appears, or for whatever Machine.

The letters after some of the numbers indicate the style of finish only, as follows:

- A. Hardened, Polished and Plated.
- B. Polished and Plated.
- C. Hardened only.
- D. Polished only.
- E. Soft, not polished.
- F. Hardened and Polished.
- H. Blued.

These letters **MUST BE USED** when they appear in the list and **AFTER** the number, as in the list.

In this series

200001 to 201500 are Screw Numbers.

201501 to 201800 are Nut Numbers.

201801 to 202000 are Roller Numbers.

202001 and upward are numbers of Machine Parts.

The figures in the second column refer only to the plate in which the illustration of the part is shown and are **NOT TO BE USED** in ordering.

Two or more numbers over a cut indicate that the difference between such parts is not visible in an illustration.

Parts marked with an asterisk (\*) are furnished only when repairs are made at the factory.

## LIST OF PARTS COMPLETE

FOR

## MACHINE No. 61w18

For Overalls, Tailoring, Canvas, Tennis Shoes, Etc.

| No.     | Plate | Name                              |
|---------|-------|-----------------------------------|
| *202242 | - -   | Arm .....                         |
| 202247  | 10667 | " Cap .....                       |
| 200278H | 10244 | " " Screw .....                   |
| 202248  | 10244 | " " " Washer .....                |
| 204235  | 10668 | " Position Pin (2) .....          |
| 200010E | 10245 | " Screw (3) .....                 |
| 202005  | 10245 | " " Washer (3) .....              |
| 202249  | 13351 | " Shaft with 200357E and 203100   |
| 202243  | 13351 | " " Bushing (back) with           |
|         |       | 202244 .....                      |
| 202244  | - -   | Arm Shaft Bushing (back) Oil      |
|         |       | Packing (wick) .....              |
| 200338C | 10244 | Arm Shaft Bushing (back) Set      |
|         |       | Screw .....                       |
| 202245  | 10667 | Arm Shaft Bushing (front) with    |
|         |       | 202036 and 202260 .....           |
| 202260  |       | Arm Shaft Bushing (front) Oil     |
|         |       | Packing (wick) .....              |
| 200502B | 10246 | Arm Shaft Bushing (front) Oil     |
|         |       | Packing Thumb Screw .....         |
| 202036  | 10668 | Arm Shaft Bushing (front) Posi-   |
|         |       | tion Pin .....                    |
| 200338C | 10244 | Arm Shaft Bushing (front) Set     |
|         |       | Screw .....                       |
| 202530  | 13351 | Arm Shaft Connection Belt .....   |
| 202252  | 10244 | " " " " Pulley                    |
|         |       | with 200327C, 200602E and two     |
|         |       | 202253 .....                      |
| 200602E | 10244 | Arm Shaft Connection Belt Pulley  |
|         |       | Position Screw .....              |
| 200327C | 10244 | Arm Shaft Connection Belt Pulley  |
|         |       | Set Screw .....                   |
| 202253  | 10244 | Arm Shaft Connection Belt Pulley  |
|         |       | Spring Flange .....               |
| 203100  | - - - | Arm Shaft Oil Packing (wick) .... |
| 200357E | 10244 | " " " " Stop Screw                |
| 202255  | 13351 | Balance Wheel (belt groove 2½ in. |
|         |       | diam.) with 200328C and 200335C   |

| No.     | Plate | Name   |
|---------|-------|--|
| 200328c | 10244 | Balance Wheel Position Screw   |
| 200335c | 10244 | " " Set Screw  |
| *202532 |       | Bed with 202872  |
| 202258  | 12153 | " Hinge Connection (2)   |
| 200570E | 10245 | " " " Screw (4)  |
| 206879  | 13351 | " Plate (back)   |
| 200577H | 10245 | " " " Screw  |
| 210616  | 10667 | " Slide (front)  |
| 202265  | 11671 | Bobbin   |
| *202806 |       | " Case   |
| 202267  | 11671 | " " Latch  |
| *202056 |       | " " " Pin  |
| 202269  | 11671 | " " " Plunger  |
| 202270  | 11671 | " " " Spring   |
| 202716  | 11671 | " " Tension Spring   |
| 200984c | 11671 | " " " " Regulat-<br>ing Screw  |
| 200594c | 11671 | Bobbin Case Tension Spring Screw   |
| 202533  | 11671 | Bobbin Case complete, Nos. 200594c,<br>200984c, 202056, 202267, 202269,<br>202270, 202716 and 202806 |
| 200459B | 13353 | Cloth Guide Thumb Screw  |
| 202274  | 10667 | Face Plate   |
| 202135  | 10245 | " " Position Pin   |
| 200462B | 10245 | " " Thumb Screw  |
| 202275  | 10667 | Feed Bar   |
| 200641c | 10246 | " " Hinge Screw (driving)  |
| 201522c | 10246 | " " " " Nut  |
| 202276  | 10245 | " " Slide Block  |
| 202298  | 10245 | " " " " Crank with<br>200038c  |
| 203124  |       | Feed Bar Slide Block Crank 202298<br>with 200205E, 201518E and 202276                                |
| 200038c | 10245 | Feed Bar Slide Block Crank Pinch<br>Screw  |
| 200205E | 10245 | Feed Bar Slide Block Hinge Screw   |
| 201518E | 10245 | " " " " " "  |
|         |       | Nut  |
| 202288  | 13367 | Feed Dog   |
| 200106E | 10245 | " " Screw (2)  |
| 202297  | 10667 | " Driving Connection with<br>200054E and 202277  |
| 202298  | 10245 | Feed Driving Connection Crank<br>with 200038c  |
| 200038c | 10245 | Feed Driving Connection Crank<br>Pinch Screw   |
| 200545c | 10245 | Feed Driving Connection Hinge<br>Screw   |

| No.     | Plate | Name   |
|---------|-------|--|
| 201518E | 10245 | Feed Driving Connection Hinge<br>Screw Nut   |
| 202277  |       | Feed Driving Connection Oil Pack-<br>ing (wick)  |
| 200054E | 10246 | Feed Driving Connection Pinch<br>Screw   |
| 202300  | 10246 | Feed Driving Eccentric Regulating<br>Bracket   |
| 203134  |       | Feed Driving Eccentric Regulating<br>Bracket 202300 with 202252, two<br>each 201014c and 201525E |
| 201014c | 10245 | Feed Driving Eccentric Regulating<br>Bracket Hinge Screw   |
| 201525E | 10245 | Feed Driving Eccentric Regulating<br>Bracket Hinge Screw Nut                                     |
| 202301  | 10246 | Feed Driving Eccentric Regulating<br>Bracket Plunger   |
| 202595  | 10246 | Feed Driving Eccentric Regulating<br>Bracket Plunger Spring                                      |
| 200607c | 10246 | Feed Driving Eccentric Regulating<br>Bracket Plunger Spring Stop<br>Screw                        |
| 201014c | 10245 | Feed Driving Eccentric Regulating<br>Bracket Stop Screw  |
| 201525E | 10245 | Feed Driving Eccentric Regulating<br>Bracket Stop Screw Nut                                      |
| 200429c | 10246 | Feed Driving Eccentric Regulating<br>Screw   |
| 200383c | 10246 | Feed Driving Eccentric Regulating<br>Screw Check Screw   |
| 202303  | 13352 | Feed Driving Rock Shaft  |
| 206860  |       | " " " " 202303<br>with 200641c, 201522c and 202275   |
| 202305  | 10245 | Feed Driving Rock Shaft Center<br>(2)  |
| 200043c | 10246 | Feed Driving Rock Shaft Center<br>Set Screw (2)  |
| 202306  | 10667 | Feed Lifting Connection with<br>200054E and 202277   |
| 202307  | 10246 | Feed Lifting Connection Eccentric<br>with 200382c and 200437c                                    |
| 200437c | 10246 | Feed Lifting Connection Eccentric<br>Position Screw  |
| 200382c | 13366 | Feed Lifting Connection Eccentric<br>Set Screw   |
| 200545c | 10245 | Feed Lifting Connection Hinge<br>Screw   |
| 201518E | 10245 | Feed Lifting Connection Hinge<br>Screw Nut   |

| No.     | Plate | Name   |
|---------|-------|--|
| 202277  | —     | Feed Lifting Connection Oil Packing (wick) .....   |
| 200054e | 10246 | Feed Lifting Connection Pinch Screw .....  |
| 202308  | 13352 | Feed Lifting Rock Shaft .....  |
| 202305  | 10245 | " " " " Center (2)   |
| 200043c | 10246 | " " " " " Set Screw (2) .....  |
| 207070  | 13352 | Feed Regulating Spindle with 202311, 202443, 202619 and 210554                           |
| *202311 | —     | Feed Regulating Spindle Head ...   |
| 202443  | 10244 | " " " " Pin  |
| 202619  | 10668 | " " " " Position Pin .....   |
| 210554  | 10668 | Feed Regulating Spindle Spring (flat) .....  |
| *206776 | —     | Hook (sewing) .....  |
| 206777  | 13352 | " 206776 with 200145n, 200596e, 200614c, 202320, 203101, 206751, 206775 and 206852 ..... |
| 206740  | 13352 | Hook and Bobbin Case complete, Nos. 202533 and 206777 .....                              |
| 206852  | 13353 | Hook Gib .....   |
| 200614c | 11671 | " " Hinge Screw .....  |
| 200596e | 11671 | " " Screw .....  |
| 203101  | —     | " Oil Wick .....   |
| *202320 | —     | " Shaft, 11 $\frac{1}{2}$ in. long .....   |
| 202321  | 10245 | " " Bushing (back) .....   |
| 200346c | 10245 | " " " " Set Screw  |
| 202322  | 10245 | " " " (front) .....  |
| 200346c | 10245 | " " " " Set Screw ..   |
| 202323  | 10244 | " " Connection Belt Pulley with 202324 and two 201018c .....                             |
| 201018c | 13353 | Hook Shaft Connection Belt Pulley Set Screw .....  |
| 202324  | 10244 | Hook Shaft Connection Belt Pulley Spring Flange .....                                    |
| 202260  | —     | Hook Shaft Oil Packing (wick) (2)  |
| 206775  | 11671 | " " Pin .....  |
| 206751  | 11671 | " Washer .....   |
| 200145n | 11671 | " " Screw .....  |
| 202445  | 10936 | Knee Lifter Connection Lever with 202446 .....   |
| 202786  | —     | Knee Lifter Connection Lever 202445 with 200224n, 200262n, 202447 and 202449 .....       |
| 200224n | 10248 | Knee Lifter Connection Lever Hinge Screw .....   |
| 202447  | 10936 | Knee Lifter Connection Lever Lifting Rod with 202302 .....                               |

| No.     | Plate | Name  |
|---------|-------|---|
| 202302  | 10248 | Knee Lifter Connection Lever Lifting Rod Cotter Pin .....                 |
| 202446  | 10246 | Knee Lifter Connection Lever Pin  |
| 202449  | 10936 | " " Lifting Lever (short) ..  |
| 200262n | 10248 | " " " " Hinge Screw .....   |
| 202326  | 10248 | Needle Bar with 200141e .....   |
| 202550  | 10283 | " " Bushing .....   |
| 206880  | —     | " " " 202550 with 202326  |
| 200352c | 10248 | " " " Set Screw .....   |
| 202552  | 10283 | " " Connecting Link .....   |
| 202332  | 10668 | " " " " Oil Guard .....   |
| 200161b | 10247 | Needle Bar Connecting Link Oil Guard Screw .....                          |
| 202333  | 10248 | Needle Bar Connecting Link Stud with 202254 .....                         |
| 202254  | —     | Needle Bar Connecting Link Stud Oil Packing (wick) .....                  |
| 200374c | 10668 | Needle Bar Connecting Link Stud Set Screw .....                           |
| 200383c | 10246 | Needle Bar Connecting Link Stud Set Screw .....                           |
| *206891 | —     | Needle Bar Connecting Stud .....  |
| 202329  | 10248 | " " " " 206891 with 200086c and 202330 .....                              |
| 202330  | —     | Needle Bar Connecting Stud Oil Packing (wick) .....                       |
| 200086c | 10248 | Needle Bar Connecting Stud Pinch Screw .....                              |
| 202551  | 13351 | Needle Bar Crank with 200335c, 200374c, 200383c, 200428c and 202333 ..... |
| 203771  | —     | Needle Bar Crank 202551 with 202329, 202398 to 202400 and 202552 .....    |
| 203172  | 10248 | Needle Bar Crank Friction Washer  |
| 200428c | 10248 | " " " Position Screw  |
| 200335c | 10244 | " " " Set Screw .....   |
| 200141e | 10248 | " Set Screw .....   |
| 202335  | 10667 | Presser Bar (hollow) with 200074e   |
| 207072  | 10249 | " " Bushing .....   |
| 200352c | 10248 | " " " Set Screw .....   |
| 202554  | 10283 | " " Lifter .....  |
| 200653c | 10249 | " " " Hinge Screw ..  |
| 202553  | 10283 | " " Lifting Releasing Lever Bracket .....                                 |
| 200260b | 10249 | Presser Bar Lifting Releasing Lever Bracket Guide Screw .....             |

| No.     | Plate | Name  |
|---------|-------|---|
| 202342  | 10249 | Presser Bar Lifting Releasing Lever Bracket Spring (spiral) ..... |
| 202337  | 10249 | Presser Bar Position Guide .....                                  |
| 202338  | 10249 | " " " " Lever with 200086f .....                                  |
| 200086f | 10248 | Presser Bar Position Guide Lever Pinch Screw .....                |
| 200352c | 10248 | Presser Bar Position Guide Set Screw .....                        |
| 202378  | 13366 | Presser Bar Spring (heavy) .....                                  |
| 202346  | 10249 | " " " Stop Rod .....  |
| 200492b | 10249 | " " Thumb Screw (pressure regulating) .....                       |
| 200475b | 10668 | Presser Bar Thumb Screw Thumb Set Screw .....                     |
| 202355  | 10668 | Presser Bar Thumb Screw Thumb Set Screw Packing (brass) .....     |
| 202090  | 13366 | Presser Foot Hinge Pin .....                                      |
| 203011  | -     | " " Plate .....   |
| 202924  | -     | " " Shank .....   |
| 229867  | 13369 | Presser Foot (hinged) complete, Nos. 202090, 202924 and 203611 .. |
| 200074f | 10249 | Presser Foot Screw .....  |
| 226057  | 13366 | Quilter Bracket with 200481b .....                                |
| 200118e | 13366 | " " Screw .....   |
| 200481b | 13366 | " Thumb Screw .....   |
| 202068  | 13153 | Spool Holder Base .....   |
| 200575b | 10668 | " " " Screw .....   |
| 204296  | 12153 | " " Wire .....  |
| 200079b | 10668 | " " " Hinge Screw .....   |
| 204297  | 12153 | Spool Holder complete, Nos. 200079b, 202068 and 204296 .....      |
| 202397  | 10668 | Take-up (auxiliary) .....   |
| 200842f | 10668 | " " Screw .....   |
| 202398  | 10247 | " Lever .....   |
| 202399  | 10247 | " " Driving Stud with 202277 .....                                |
| 202277  | -     | " " " " Oil Packing (wick) .....                                  |
| 202400  | 10247 | Take-up Lever Hinge Stud with 202423 .....                        |
| 202423  | -     | Take-up Lever Hinge Stud Oil Packing (wick) .....                 |
| 200383c | 10246 | Take-up Lever Hinge Stud Set Screw .....                          |
| 202401  | 10247 | Take-up Lever Oiling Felt .....                                   |
| 200132e | 10247 | " " " " Screw .....   |
| 202402  | 10247 | Tension Disc (back) .....   |
| 202403  | 10247 | " " (front) .....   |
| 202404  | 10247 | " Release Plunger .....   |
| 202405  | 10247 | " " Washer .....  |

| No.     | Plate | Name  |
|---------|-------|---|
| 202407  | 10881 | Tension Spring .....  |
| 200625f | 10247 | " Stud with 204925 .....  |
| 200084f | -     | " " Set Screw .....   |
| 204925  | 10668 | " " Washer .....  |
| 201572b | 10881 | " Thumb Nut .....   |
| 202409  | 10252 | Tension complete, Nos. 200625f, 201572b, 202402, 202403, 202405, 202407 and 202410 .....                      |
| 202110  | 10252 | Thread Controller Spring .....  |
| 202411  | 10252 | " " " Stop .....  |
| 200132e | 10247 | " " " " Screw .....   |
| 202413  | 10252 | " Guide .....   |
| 202414  | 10252 | " " .....   |
| 202415  | 10252 | " " .....   |
| 202417  | 10252 | " " .....   |
| 200582b | 10252 | " " Screw .....   |
| 200355b | 10272 | " " Set Screw .....   |
| 200368b | 10668 | " " " " .....   |
| 202091  | 10252 | " Retainer Sleeve .....   |
| 202092  | 10252 | " " Spring .....  |
| 204058  | 10252 | " " Stud .....  |
| 200368b | 10668 | " " " Set Screw .....   |
| 204059  | 10668 | Thread Retainer complete, Nos. 202091, 202092 and 204058 .....  |
| 202826  | 13368 | Throat Plate, 46 elongated needle hole, for needle sizes 20 and 22, with 202534, 202619 and two 200583b ..... |
| 202534  | 10668 | Throat Plate Bobbin Case Stop .....   |
| 202619  | 10668 | " " " " " " Position Pin .....  |
| 200583b | 10668 | Throat Plate Bobbin Case Stop Screw .....   |
| 202872  | 10668 | Throat Plate Position Pin .....   |
| 200577b | 10245 | " " Screw (2) .....   |

## MACHINE No. 61w106

For Tailoring, Overalls, Canvas, Tennis Shoes, Etc.

This Machine is the same as No. 61w18 with the following exceptions:

| No.     | Plate | Name   |
|---------|-------|--|
| *202241 | ---   | Arm, in place of 202242 .....  |
| 202250  | 13365 | " Shaft with 200357E and 203100,<br>in place of 202249 .....   |
| *206897 | ----  | Bed with 202872, in place of 202532  |
| 202304  | 13365 | Feed Driving Rock Shaft, in place<br>of 202303 .....   |
| 203122  | ----  | Feed Driving Rock Shaft 202304<br>with 200641c, 201522E and 202275,<br>in place of 206860 .....                          |
| 202654  | 13365 | Feed Lifting Rock Shaft, in place of<br>202308 .....   |
| 206754  | 13365 | Hook 206776 with 200145a, 200596c,<br>200614c, 202319, 203101, 206751,<br>206775 and 206852, in place of<br>206777 ..... |
| 206743  | --    | Hook and Bobbin Case complete,<br>Nos. 202533 and 206754, in place<br>of 206740 .....                                    |
| *202319 | ----  | Hook Shaft, 13 $\frac{3}{16}$ in. long, in place<br>of 202320 .....  |
| 202732  | ----  | Knee Lifter Connection Lever<br>202445 with 200224a, 200262a,<br>202447 and 202448, in place of<br>202786 .....          |
| 202448  | 10936 | Knee Lifter Lifting Lever, in place<br>of 202449 .....   |

## ACCESSORIES

| No.     | Plate | Name  |
|---------|-------|---|
| 200157B | 13353 | Attachment Screw .....  |
| 202265  | 11671 | Bobbin (5) .....  |
| *225482 | ---   | Bobbin Case Screw Driver Blade ..   |
| *225483 | ---   | " " " " Handle  |
| 225497  | 12153 | Bobbin Case Screw Driver com-<br>plete, Nos. 225482 and 225483 ..                 |
| 231337  | 13353 | Cloth Guide .....   |
| 226056  | 13366 | Quilter .....   |
| 135 x 5 | ----  | Needles, three each, sizes 16 and 18  |
| 225180  | ----  | Drip Pan (short) with four wood<br>screws $\frac{1}{2}$ in., No. 5 .....          |
| 41400   | 12153 | Machine Rest Pin (wood) .....   |
| 36578   | 12153 | Oiler with 36579 .....  |
| 36579   | 12153 | " Spout, 3 $\frac{1}{2}$ in. long, with 120117                                    |
| 120117  | ----  | " " Washer .....  |
| *225484 | ---   | Screw Driver Blade .....  |
| *225485 | ---   | " " Handle .....  |
| 225498  | 12153 | Screw Driver complete (7 $\frac{1}{2}$ in. long),<br>Nos. 225484 and 225485 ..... |
| 225554  | 12153 | Wrench (steel) .....  |

**BOBBIN WINDER**

Swing Automatic, Right Hand.

|         |       |                                   |
|---------|-------|-----------------------------------|
| *225451 | ---   | Bobbin Holder .....               |
| 225453  | 10882 | Frame with 202277 and 225438 .... |
| 225454  | 10882 | " Hinge Pin .....                 |
| 202277  | ----  | " Oil Packing (wick) .....        |
| 225438  | 10882 | " " Well Cap .....                |
| 225455  | 10882 | " Spring .....                    |
| 225456  | 10882 | " " Plunger .....                 |
| 202473  | 10883 | Pulley with 200105c .....         |
| 200105c | ----  | " Set Screw .....                 |
| *225443 | ----  | Spindle .....                     |
| 225452  | 10882 | " 225443 with 225451 .....        |
| 225444  | 10882 | Stop Latch .....                  |
| 200056E | 10882 | " " Screw .....                   |
| 225458  | 10882 | " " Thumb Lever .....             |
| 225459  | 10882 | " " " " Hinge Stud                |
| 225460  | 10882 | " " " " Joint Stud                |
| 202478  | 10882 | " " Trip Lever .....              |
| 200299a | 10882 | " " " " Hinge Screw               |
| 225461  | 10881 | Tension Bracket with 201499b .... |
| 200082b | 10881 | " " Screw .....                   |
| 228026  | ---   | " " " Washer .....                |

| No.     | Plate | Name   |
|---------|-------|--|
| 2102    | 10881 | Tension Disc .....   |
| 202407  | 10881 | " Spring .....   |
| 201499B | 10881 | " Stud .....   |
| 201572B | 10881 | " " Thumb Nut .....  |
| 225462  | 10881 | Bobbin Winder Tension Bracket<br>complete, Nos. 201572B, 202407,<br>225461 and two 2102 .....  |
| 225433  | 10883 | Bobbin Winder and Tension<br>Bracket Base .....  |
| 225436  | 10883 | Universal Bobbin Winder complete,<br>Nos. 200056E, 200082B, 200299B,<br>202473, 202478, 225433, 225444,<br>225452 to 225456, 225458 to 225460,<br>225462, 228026 and two wood<br>screws $\frac{3}{4}$ in., No. 13, R.H.B. .... |

**KNEE LIFTER PARTS**

|         |       |  |
|---------|-------|--|
| 227781  | 10936 | Knee Lifter Rock Lever with<br>200522C and 200529C .....                         |
| 227782  | -     | Knee Lifter Rock Lever 227781 with<br>two each 202451 and 202452 ....            |
| 227783  | -     | Knee Lifter Rock Lever 227782 with<br>202985 and 227784 .....                    |
| 202453  | 10936 | Knee Lifter Rock Lever Knee Plate<br>with 200526C .....                          |
| 202985  | -     | Knee Lifter Rock Lever Knee Plate<br>202453 with 202455 .....                    |
| 202455  | 10936 | Knee Lifter Rock Lever Knee Plate<br>Arm (short) .....                           |
| 200522C | 13353 | Knee Lifter Rock Lever Knee Plate<br>Arm Set Screw .....                         |
| 200526C | 13353 | Knee Lifter Rock Lever Knee Plate<br>Set Screw .....                             |
| 202451  | 10936 | Knee Lifter Rock Lever Lug with<br>two wood screws $\frac{3}{4}$ in., No. 13U .. |
| 202452  | 13353 | Knee Lifter Rock Lever Lug Hinge<br>Pin .....                                    |
| 227784  | 10936 | Knee Lifter Rock Lever Rod, 3 in.<br>long, with 227785 .....                     |
| *227785 | -     | Knee Lifter Rock Lever Rod Cap or<br>Oil Guard .....                             |
| 200529C | 13353 | Knee Lifter Rock Lever Rod Set<br>Screw .....                                    |

(Other Knee Lifter Parts are listed with  
parts of machine head).

**FOR MACHINE No. 61w106**

Same as for No. 61w18 with the following exceptions:

| No.                      | Plate | Name   |
|--------------------------|-------|--|
| 225191                   | -     | Drip Pan (long) with four wood<br>screws $\frac{1}{2}$ in., No. 5, in place of<br>225180 ..... |
| <b>KNEE LIFTER PARTS</b> |       |  |
| 227781                   | 10936 | Knee Lifter Rock Lever with<br>200522C and 200529C .....                                       |
| 227782                   | -     | Knee Lifter Rock Lever 227781 with<br>two each 202451 and 202452 ....                          |
| 227787                   | -     | Knee Lifter Rock Lever 227782 with<br>202203 and 227784 .....                                  |
| 202453                   | 10936 | Knee Lifter Rock Lever Knee Plate<br>with 200526C .....  |
| 202203                   | -     | Knee Lifter Rock Lever Knee Plate<br>202453 with 202454 .....                                  |
| 202454                   | 10936 | Knee Lifter Rock Lever Knee Plate<br>Arm (long) .....  |
| 200522C                  | 13353 | Knee Lifter Rock Lever Knee Plate<br>Arm Set Screw .....                                       |
| 200526C                  | 13353 | Knee Lifter Rock Lever Knee Plate<br>Set Screw .....   |
| 202451                   | 10936 | Knee Lifter Rock Lever Lug with<br>two wood screws $\frac{3}{4}$ in., No. 13U ..               |
| 202452                   | 13353 | Knee Lifter Rock Lever Lug Hinge<br>Pin .....  |
| 227784                   | 10936 | Knee Lifter Rock Lever Rod, 3 in.<br>long, with 227785 .....                                   |
| *227785                  | -     | Knee Lifter Rock Lever Rod Cap<br>or Oil Guard .....   |
| 200529C                  | 13353 | Knee Lifter Rock Lever Rod Set<br>Screw .....  |

(Other Knee Lifter Parts are listed with  
parts of machine head).



## FEED DOGS

| No.    | Plate | Name  |
|--------|-------|---|
| 202284 | 13367 | Feed Dog, for binding dress shields, for 202812 .....               |
| 202286 | 13367 | Feed Dog, for mattress binding, for 202821 .....                    |
| 202288 | 13367 | Feed Dog, for overalls and tailoring, for 202823, 202826 and 203193 |
| 226171 | 13367 | Feed Dog, for 226175 and 226190 ..                                  |
| 230598 | 13367 | " " " 203102 .....  |

## PRESSER FEET

|         |       |  |
|---------|-------|--|
| 203767  | 10921 | Presser Foot with 202108, for clamping tailoring guide .....   |
| 206830  | 13369 | Presser Foot .....   |
| 206832  | 13369 | " " .....  |
| 207024  | 13369 | " " for binding cardigan jackets .....   |
| 202379  | 10921 | Presser Foot Guide .....   |
| 202392  | 10921 | " " " (auxiliary foot)   |
| 202393  | 10921 | " " " for thick goods  |
| 202394  | 10921 | " " " " tucks .....  |
| 202395  | 10921 | " " " " .....  |
| 202396  | 10921 | " " " at left for tucks  |
| 202808  | 10921 | " " " Clamp .....  |
| 202799  | 10921 | " " " Hinge Pin  |
| 202763  | 10921 | " " " " Spring   |
| 202108  | 10921 | " " " " " "  |
|         |       | Pin .....  |
| 203768  | 10921 | Presser Foot complete, Nos. 202379, 202392 to 202396, 202763, 202799, 202808 and 203767, for tailoring..       |
| 206998  | 13369 | Presser Foot Holder with 200543n, for Presser Bar 202335 as a substitute for Compound Presser Bar 202514 ..... |
| 200543H | 13369 | Presser Foot Screw .....   |
| 206842  | ----- | Presser Foot Cleft Holder, for Hemmers .....   |

## THROAT PLATES

| No.    | Plate | Name   |
|--------|-------|--|
| 202812 | 13368 | Throat Plate, 46 needle hole, for needle sizes 16 and 18, with 202534, 202619 and two 200583n, for 202284 .....  |
| 202821 | 13368 | Throat Plate, 50 needle hole, for needle sizes 14 and 15, with 202534, 202619 and two 200582n, for 202286 .....  |
| 202823 | 13368 | Throat Plate, 50 needle hole, for needle sizes 14 and 15, with 202534, 202619 and two 200583n, for overall and tailoring work, for 202288 .....        |
| 202826 | 13368 | Throat Plate, 46 elongated needle hole, for needle sizes 20 and 22, with 202534, 202619 and two 200583n, for 202288 .....                              |
| 203102 | 13368 | Throat Plate, 50 needle hole, for needle sizes 14 and 15, with 202534, 202619 and two 200583n, for mattress binding and similar work, for 230598 ..... |
| 203193 | 13368 | Throat Plate, 40 needle hole, for needle sizes 20 and 22, with 202534, 202619 and two 200583n, for 202288 .....  |
| 226190 | 13367 | Throat Plate, 50 needle hole, for needle sizes 14 and 15, with 202534, 202619 and two 200583n, for 226171 and 226175 .....                             |

**BINDERS****BINDER****For Skirts.**

| No.    | Plate | Name  |
|--------|-------|---|
| 225636 | 13366 | Bias Binder on Shank, folds binding of the following widths: $\frac{3}{8}$ , $\frac{1}{2}$ , $\frac{3}{4}$ , $\frac{11}{8}$ , $\frac{7}{8}$ , $\frac{15}{8}$ and 1 inch ..... |
|        |       | Note: Specify width wanted on order.  |

**ENGLISH BINDER****For Binding Cardigan Jackets with Elastic or Bias Braid.**

|         |       |   |
|---------|-------|---|
| 226171  | 13367 | Feed Dog .....  |
| 226172  | 13366 | Binder Head, for tapes or folded strips $\frac{3}{8}$ , $\frac{1}{2}$ , $\frac{3}{4}$ , $\frac{11}{8}$ and $\frac{7}{8}$ inch ..... |
| 200896B | 13366 | Binder Thumb Screw .....  |
|         |       | Note: State width required, send samples of material to be folded and sufficient material to test Binder.                           |
| 226173  | 13370 | Binder complete, Nos. 226172, 230650 and two 200896B .....  |
| 230650  | 13370 | Binder Plate with two 226174 and seven 225648 .....   |
| 200577H | 10245 | Binder Plate Screw .....  |
| 225648  | 13366 | " Tape Tension Pin .....  |
| 226174  | 13366 | " " " " (guard) .....   |
| 226175  |       | Binder complete, Nos. 200577H, 226171, 226173 and 226190 .....  |
| 207024  | 13369 | Presser Foot .....  |
| 226190  | 13367 | Throat Plate, 50 needle hole, for needle sizes 14 and 15, with 202534, 202619 and two 200583H .....                                 |

**RIBBON REELS**

| No.    | Plate | Name  |
|--------|-------|---|
| 226200 |       | Ribbon Reel (6 in. diam.) with 225666 .....   |
| 226211 |       | Ribbon Reel (holding projection $\frac{6}{8}$ in. diam.) with 226212 and 226213 ..... |
| 225663 | 13365 | Ribbon Reel (9 in. diam.) with 225666 .....   |
| 226212 | 13366 | Ribbon Reel Center Pin .....  |
| 226213 | 13366 | " " " " Washer .....  |
| 225664 | 13366 | " " Supporting Spindle .....  |
| 225665 |       | " " " " Base with 225664 and two wood screws $\frac{7}{8}$ in., No. 7 .....           |
| 230471 |       | Ribbon Reel Supporting Spindle Hub .....  |
| 225666 |       | Ribbon Reel Supporting Spindle Hub 230471 with 225980 .....                           |
| 225980 |       | Ribbon Reel Supporting Spindle Hub Base .....   |
| 226201 |       | Ribbon Reel (6 in. diam.) complete, Nos. 225665 and 226200 .....                      |
| 225976 |       | Ribbon Reel (9 in. diam.) complete, Nos. 225663 and 225665 .....                      |

**OBSOLETE PARTS**

| No.    | Plate | Name  |
|--------|-------|---|
| 202470 | 10271 | Bobbin Winder Base .....  |
| 202471 | 10271 | "    "    Frame .....   |
| 202472 | 10271 | "    "    Spring .....  |
| 202474 | 10271 | "    "    Spindle .....   |
| 202475 | 10271 | "    "    Stop Latch .....  |
| 202477 | 10272 | "    "    "    "    Thumb<br>Lever .....  |
| 202479 | 10271 | Bobbin Winder complete, Nos.<br>200056e, 200161r, 200221r, 201537u,<br>202470 to 202475, 202477, 202478,<br>three 200299u and two round head<br>wood screws 1 in., No. 13 ..... |
| 202480 | 10271 | Bobbin Winder Spool Holder Base<br>with 200355u and 202481 .....  |
| 202481 | 10271 | Bobbin Winder Spool Holder Base<br>Spool Pin .....  |
| 202482 | 10272 | Bobbin Winder Spool Holder Ten-<br>sion Disc (lower or upper) ....  |
| 202483 | 10272 | Bobbin Winder Spool Holder Ten-<br>sion Disc Spring (brass) .....   |
| 202484 | 10272 | Bobbin Winder Spool Holder Ten-<br>sion Disc Thread Guide .....   |
| 202485 | 10271 | Bobbin Winder Spool Holder com-<br>plete, Nos. 200011e, 202480, 202481,<br>202483, two 202482 and one wood<br>screw 1 in., No. 13 .....   |
| 206780 | 13353 | Hook Washer .....   |

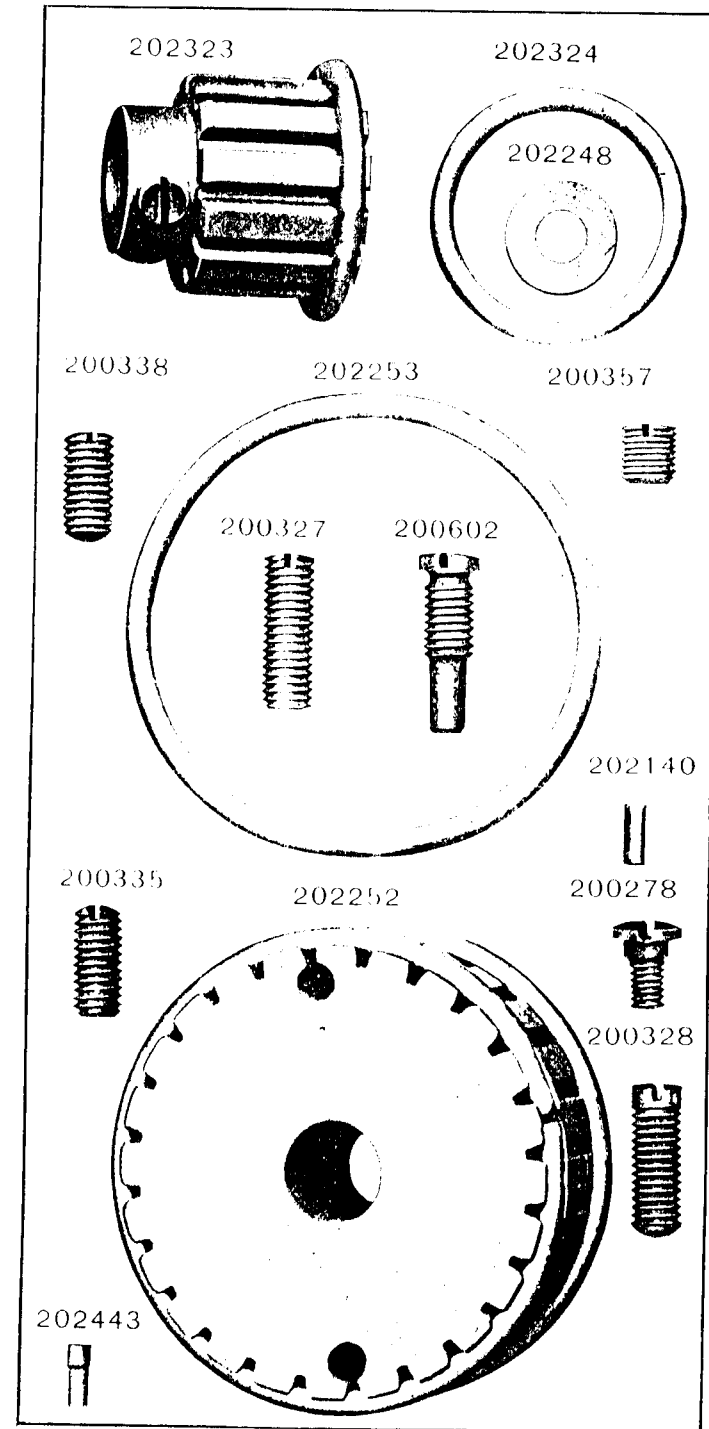

PLATE 10245—FULL SIZE

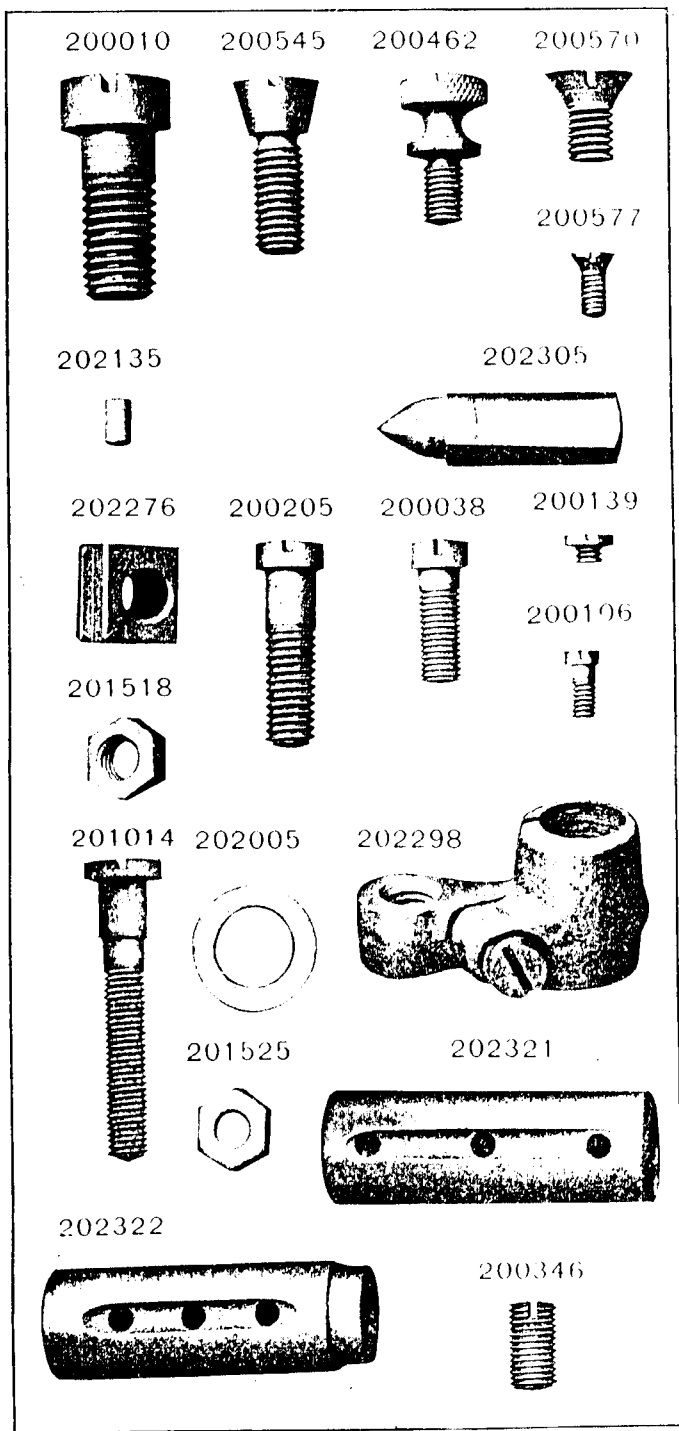

PLATE 10246—FULL SIZE

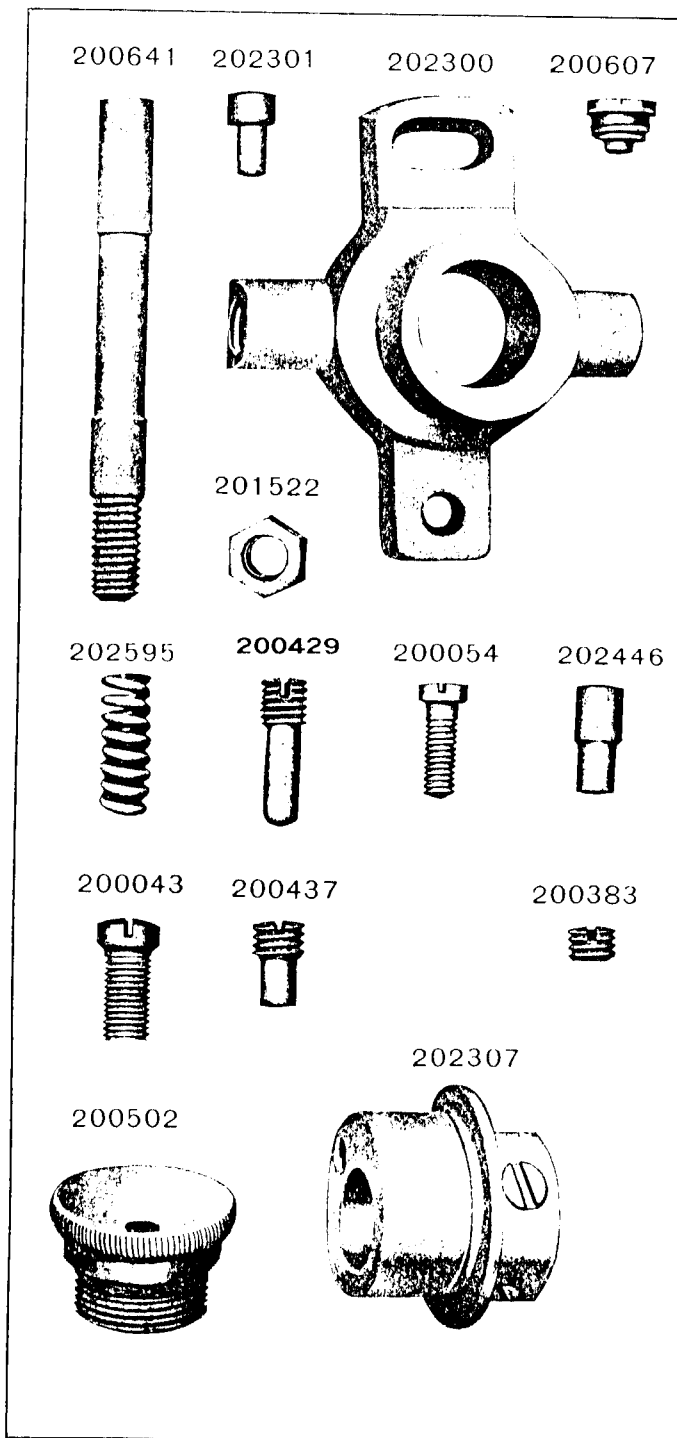

PLATE 10247—FULL SIZE

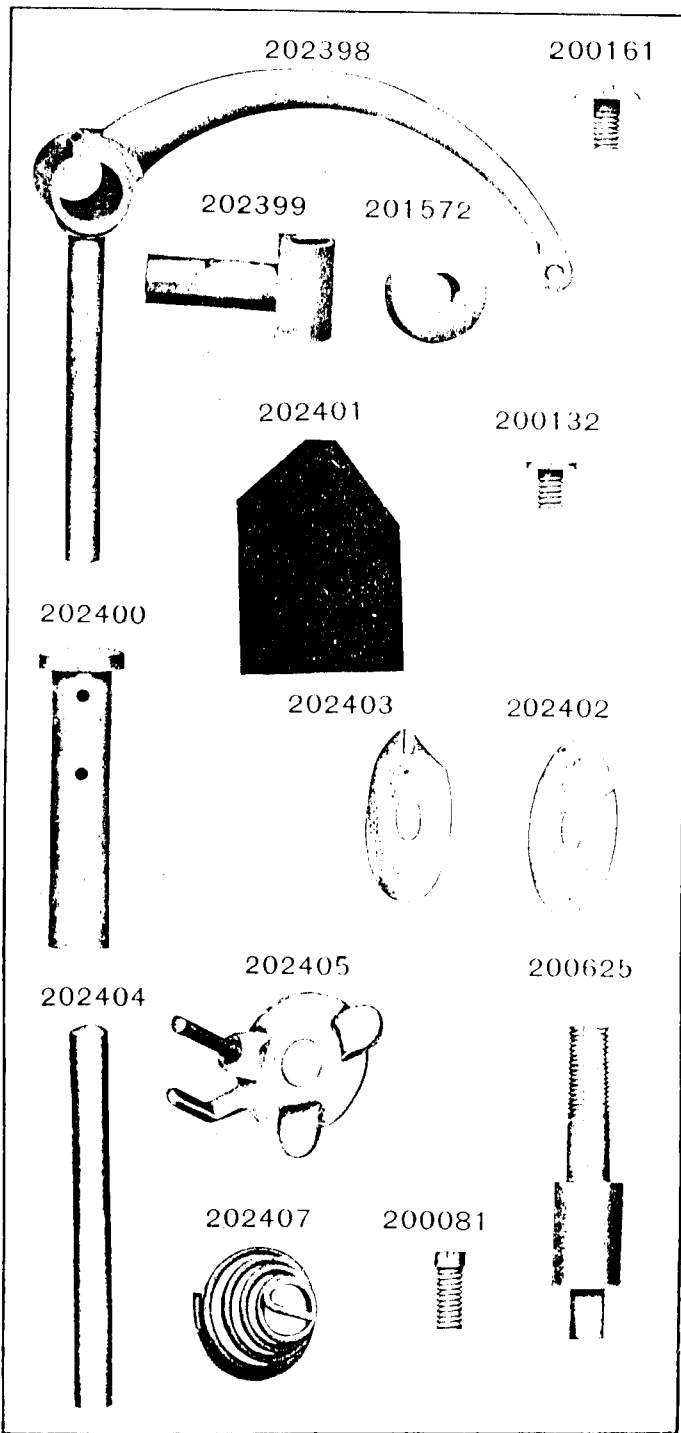

PLATE 10248—FULL SIZE

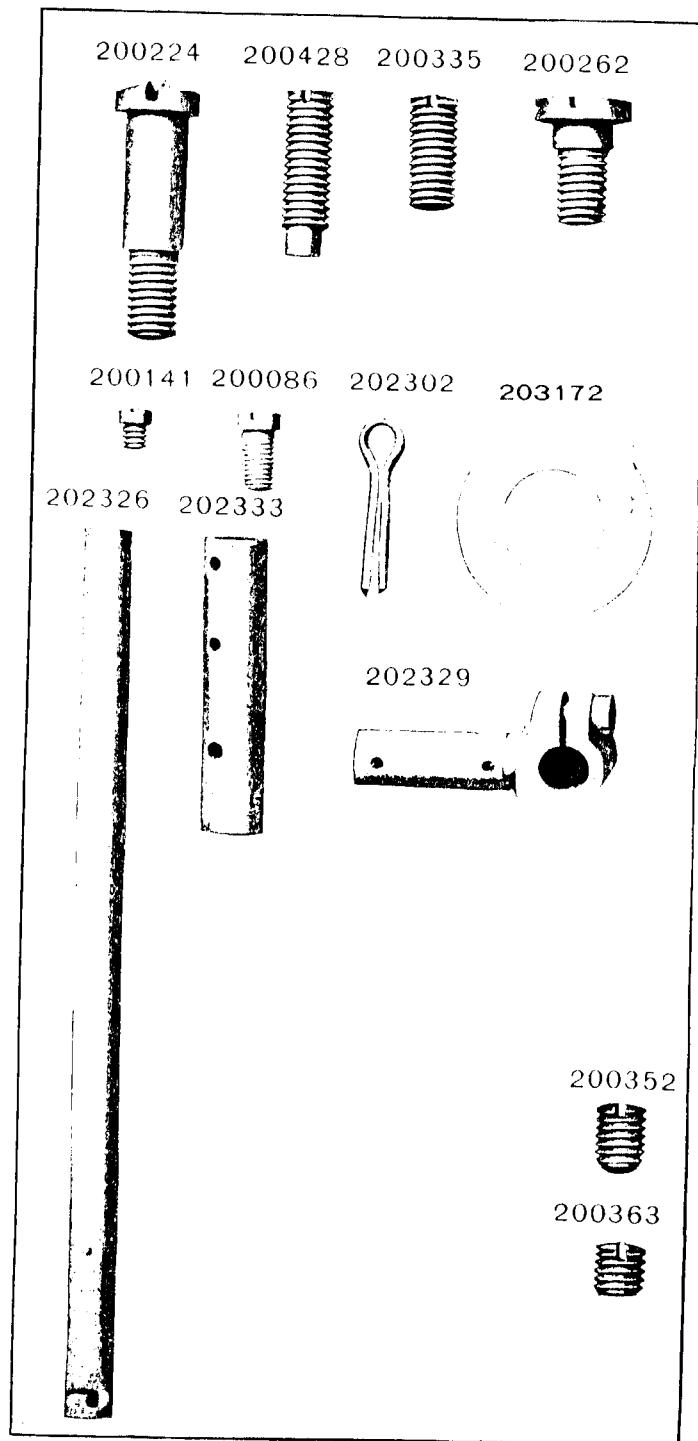

PLATE 10249—FULL SIZE

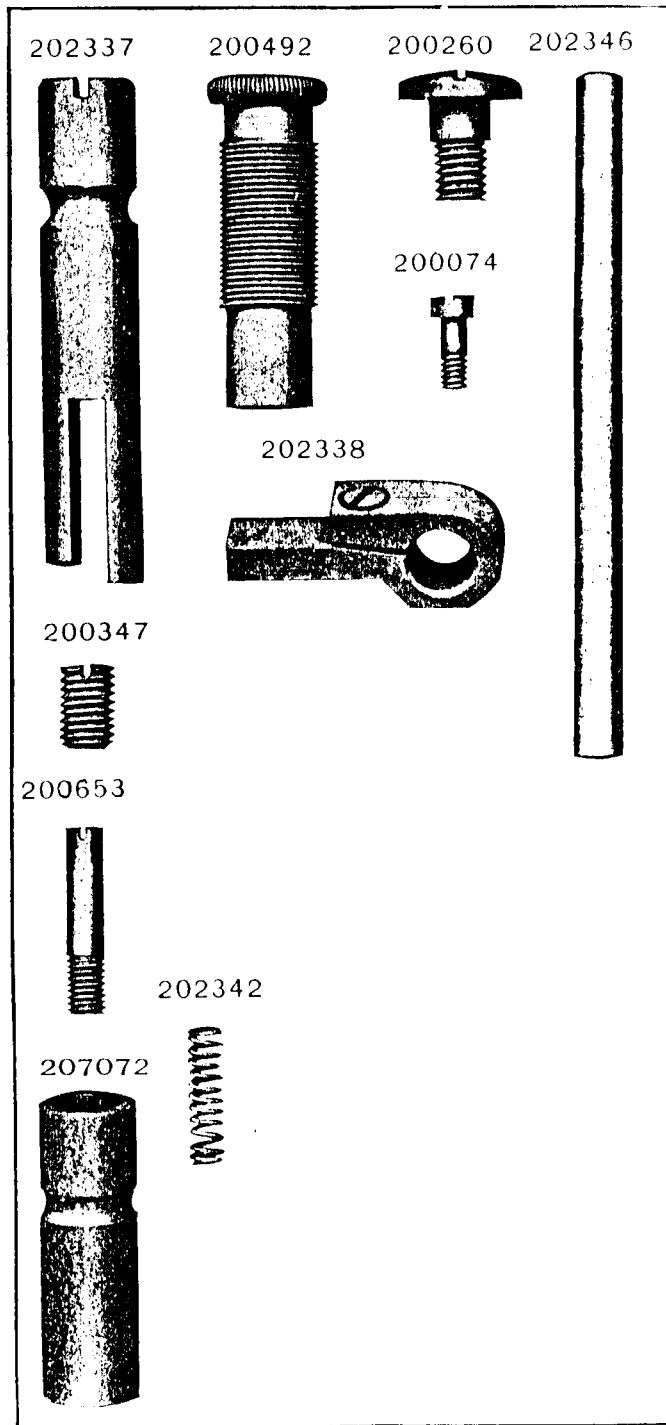

PLATE 10252—FULL SIZE

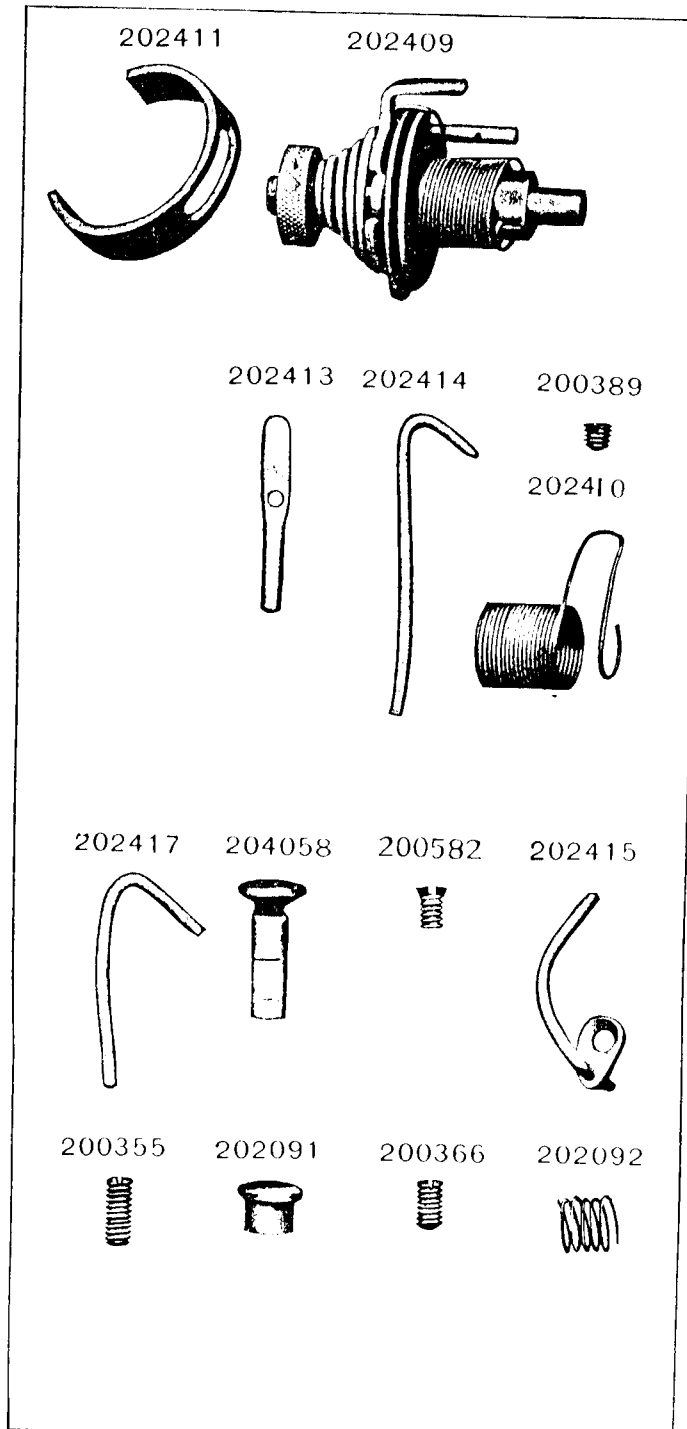

PLATE 10271—ONE-HALF SIZE

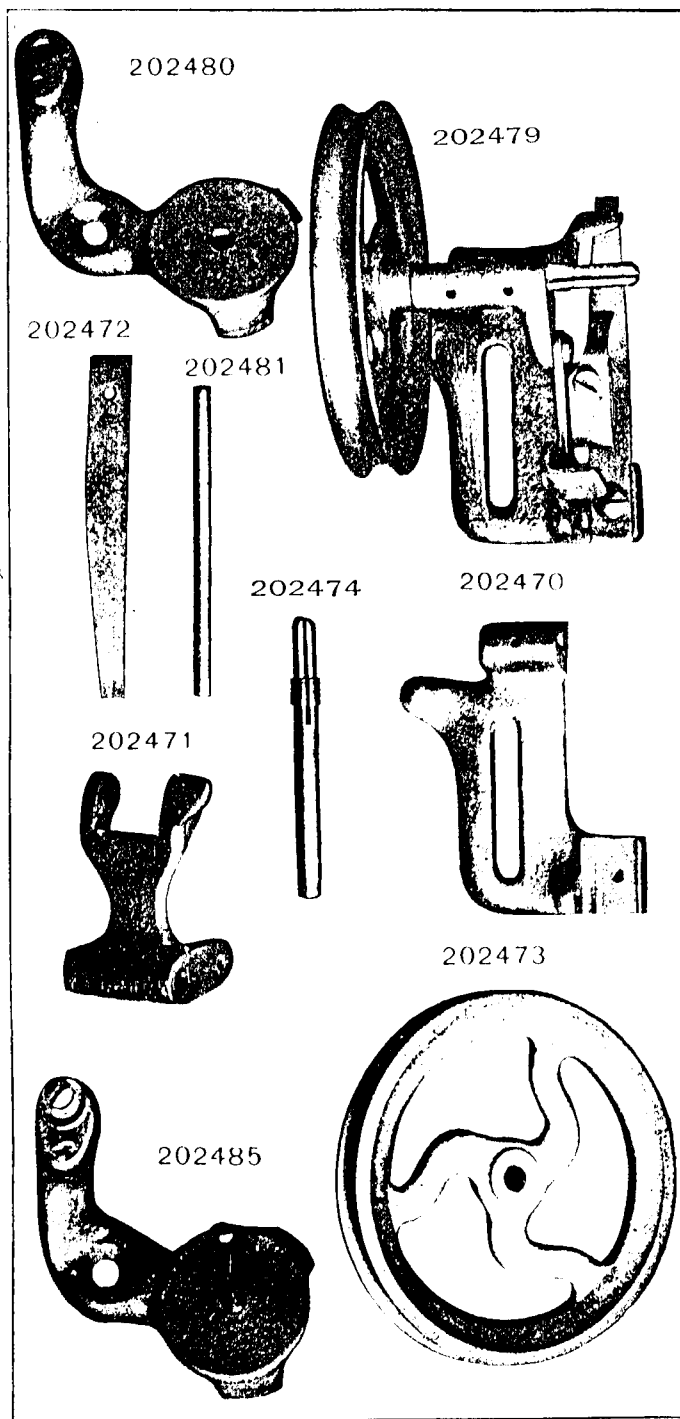

PLATE 10272—FULL SIZE

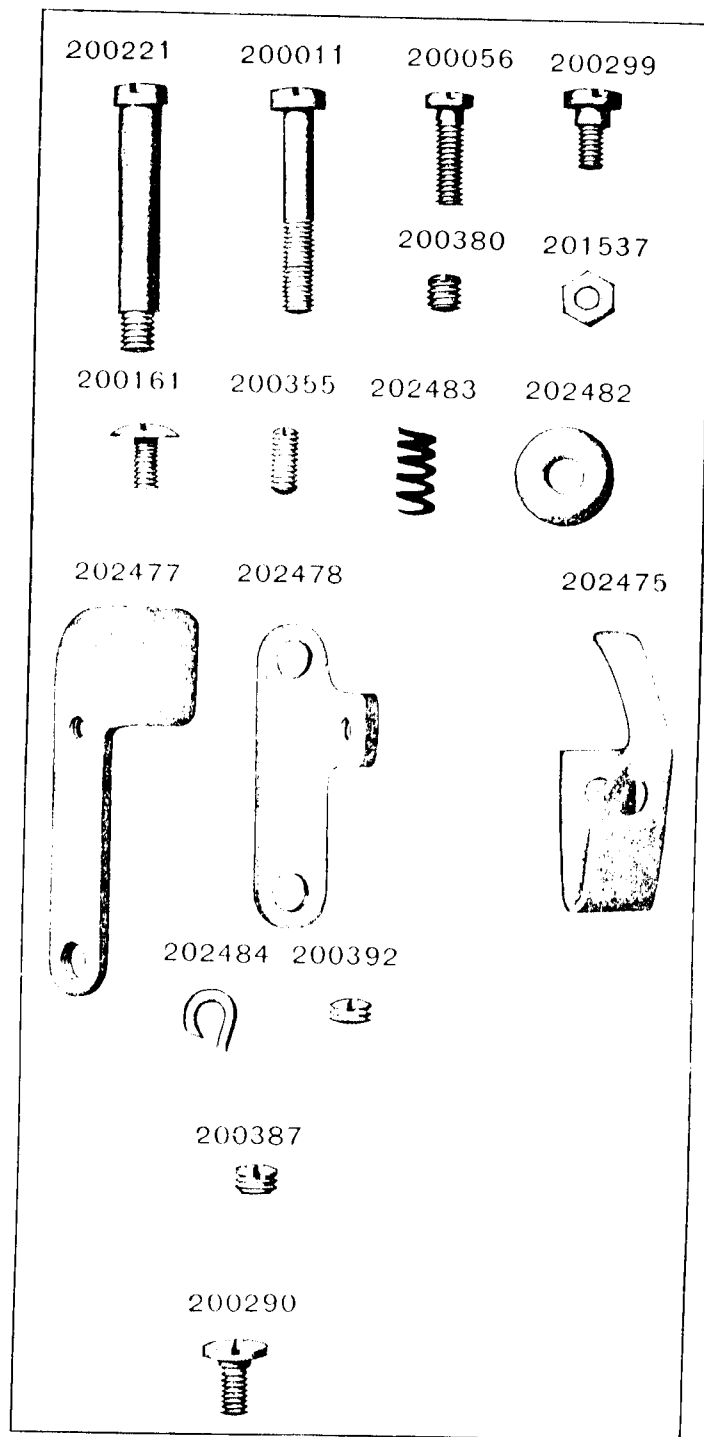

PLATE 10283-FULL SIZE

202550



202552



202554



202553

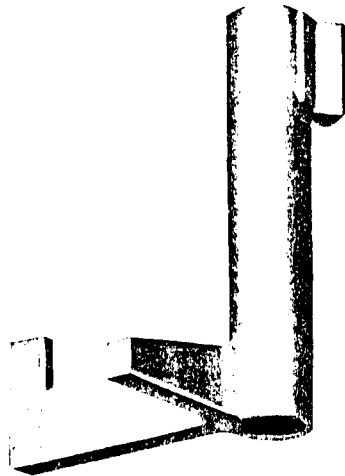
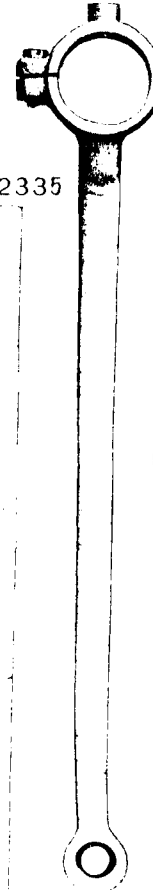

PLATE 10667 -ONE - HALF SIZE

202297



202306



202274

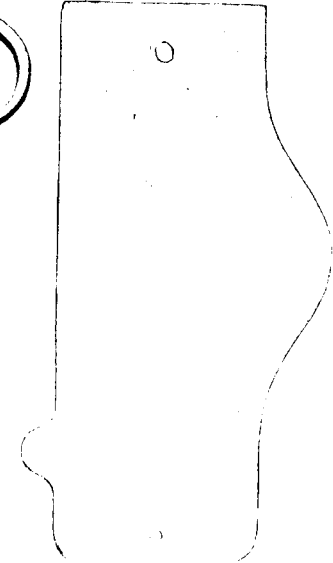

202335



202247

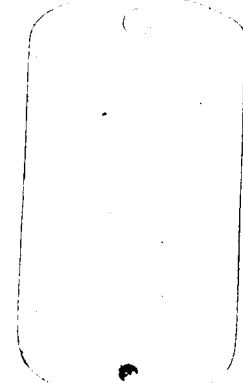

202275



202245



210616

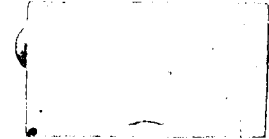



PLATE 10668—FULL SIZE

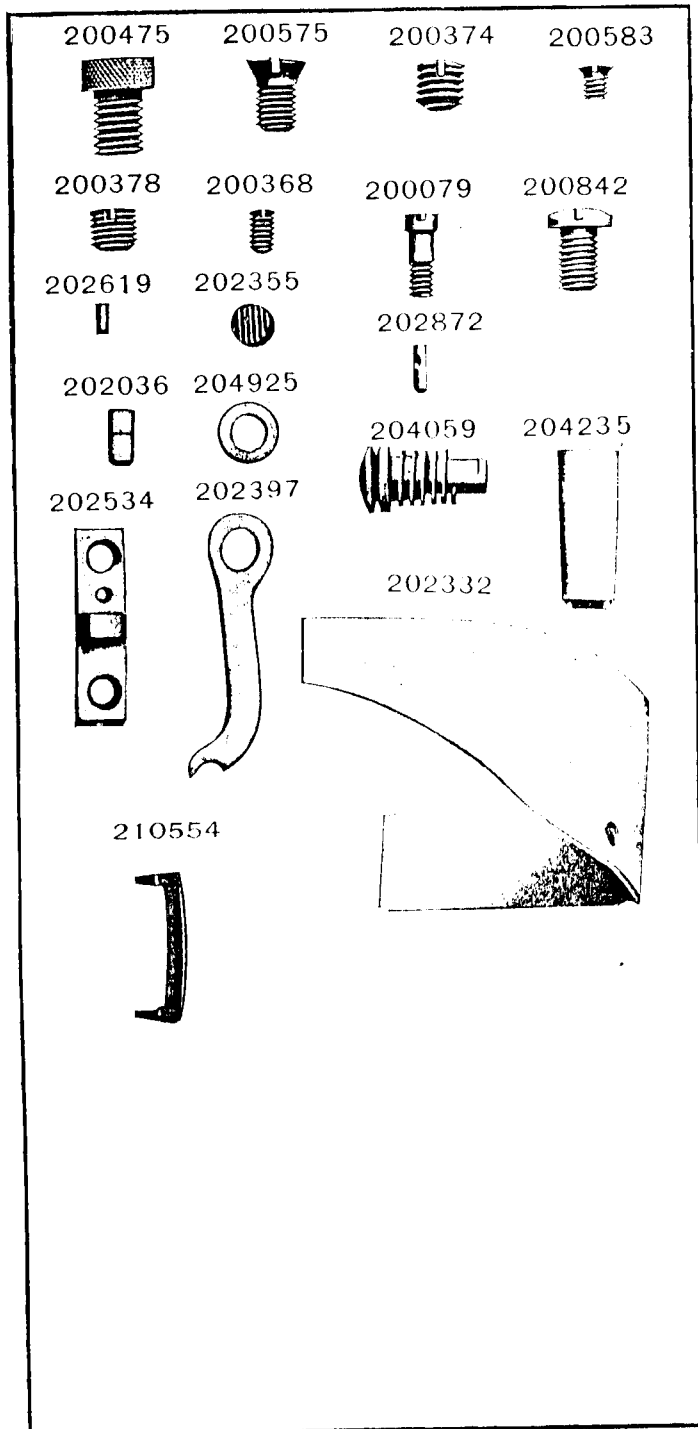

PLATE 10881—FULL SIZE

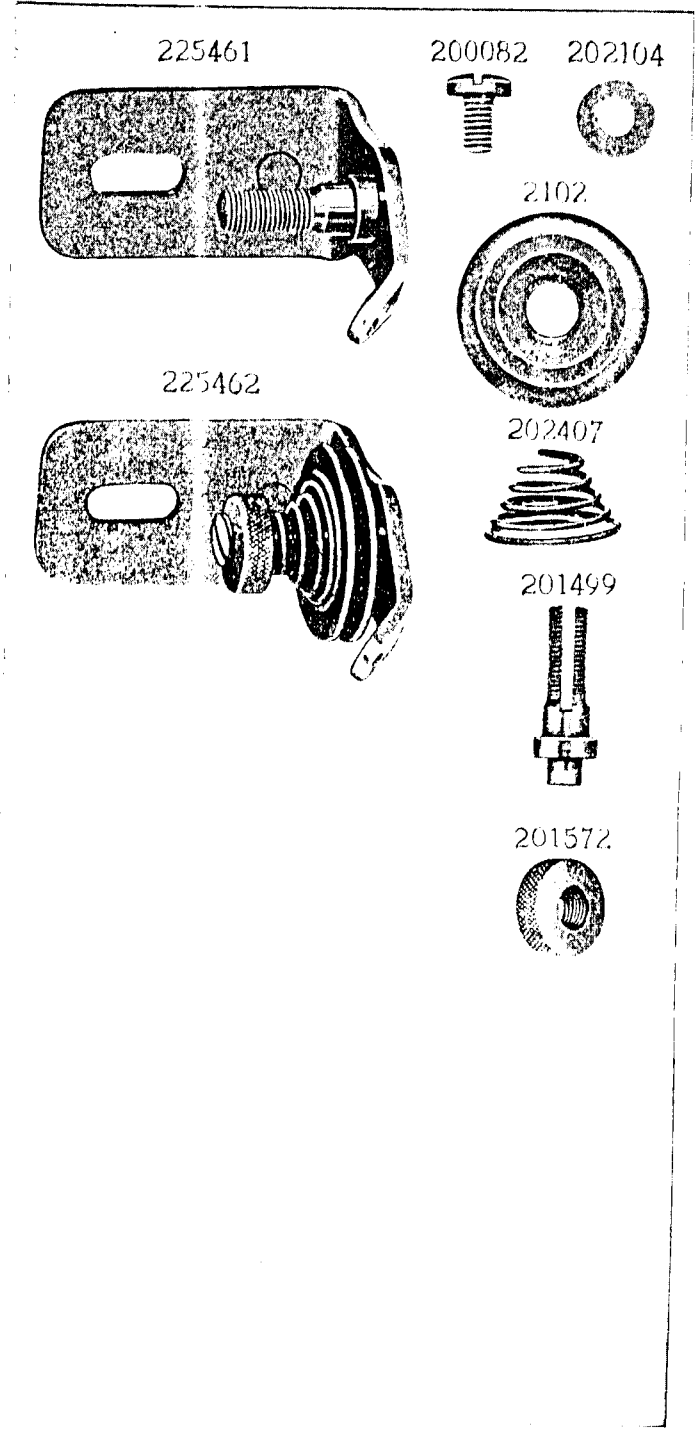

PLATE 10882—FULL SIZE

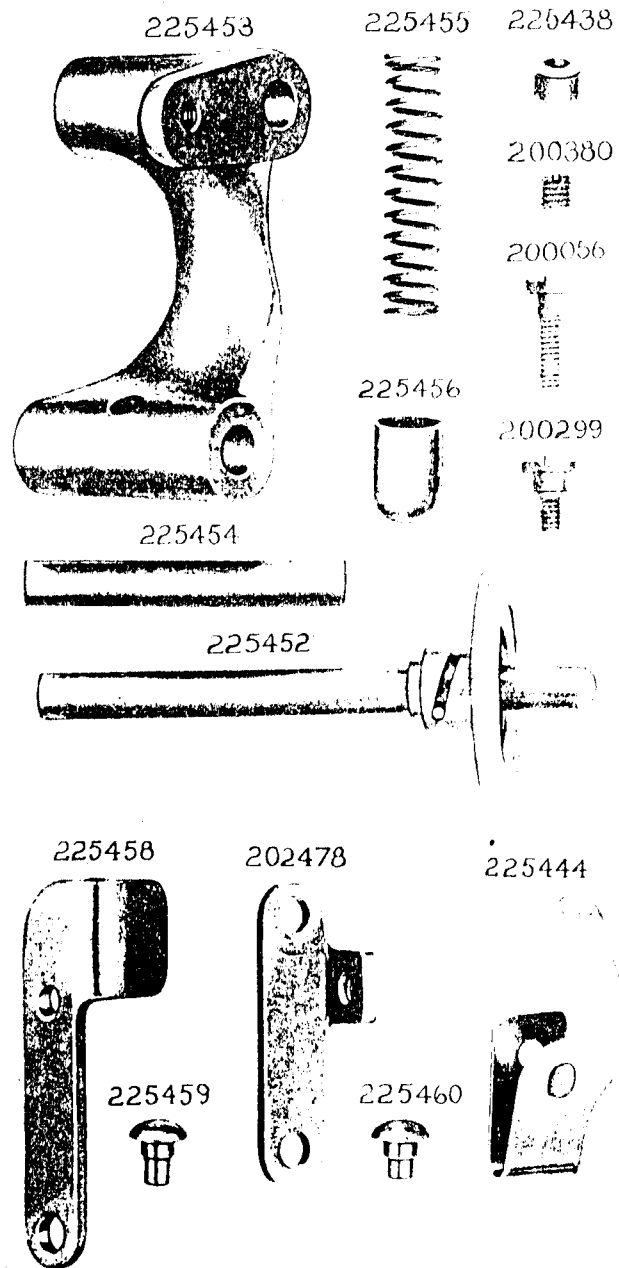

PLATE 10883 ONE-FOURTH SIZE

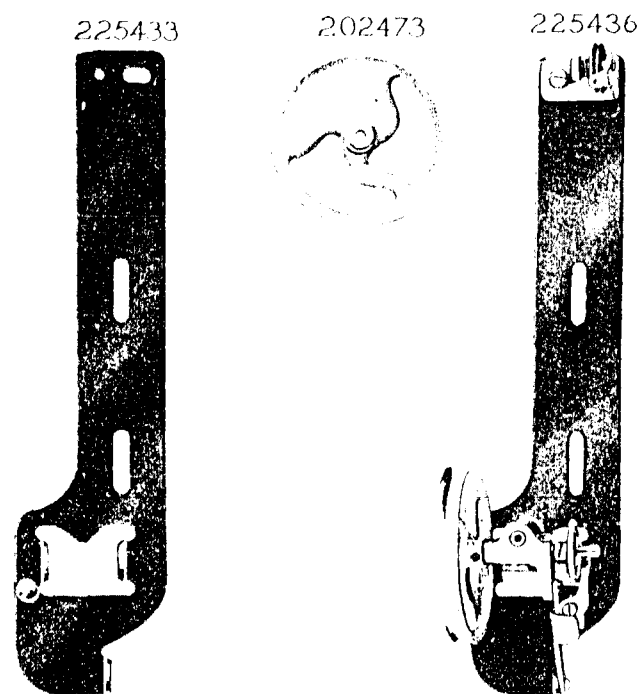

PLATE 10921 -FULL SIZE

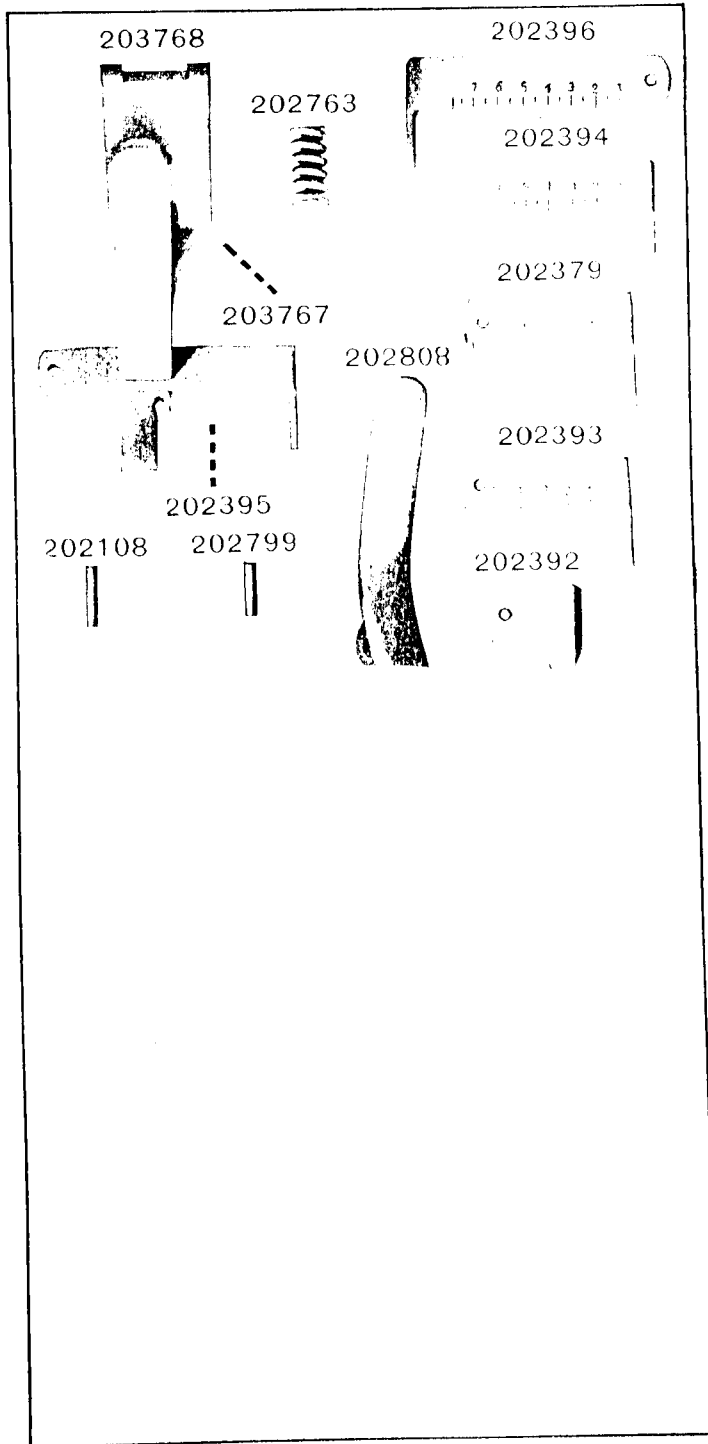

PLATE 10936 -ONE-FOURTH SIZE

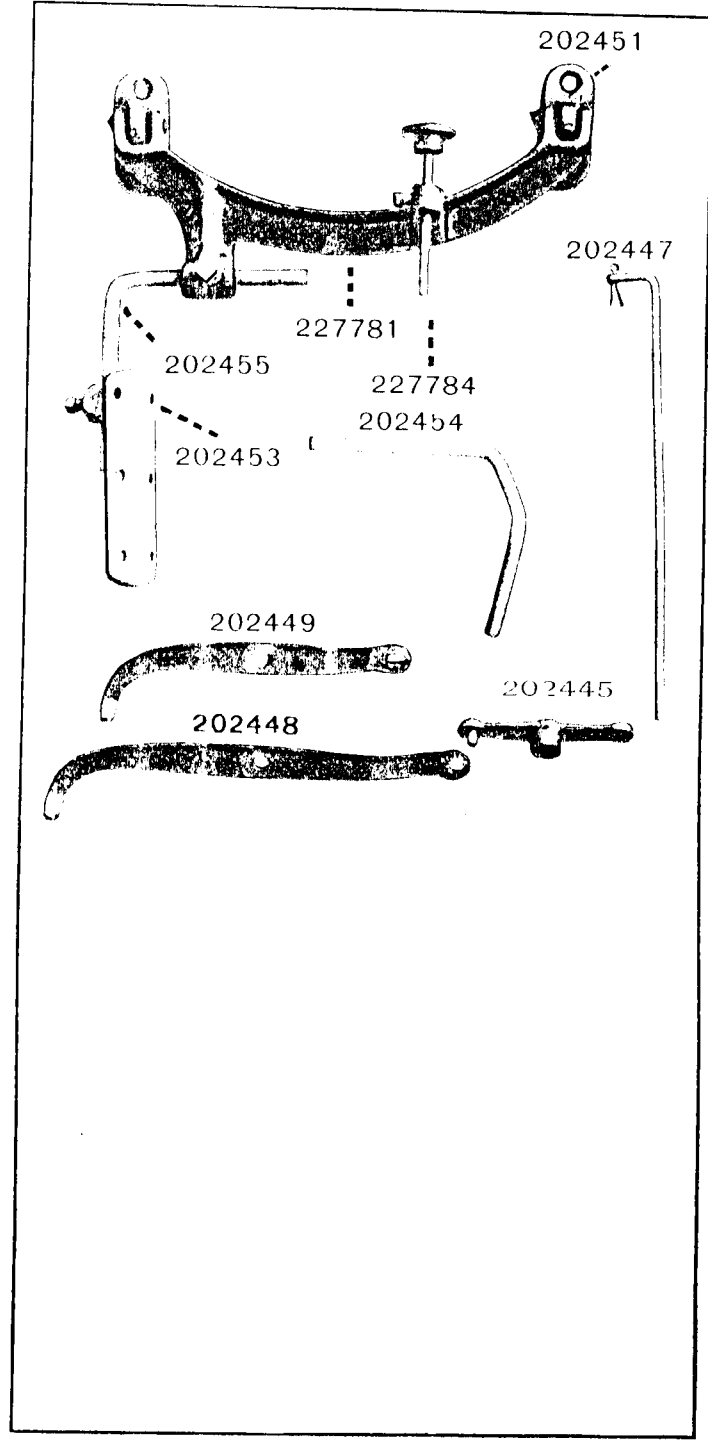

PLATE 11671-FULL SIZE

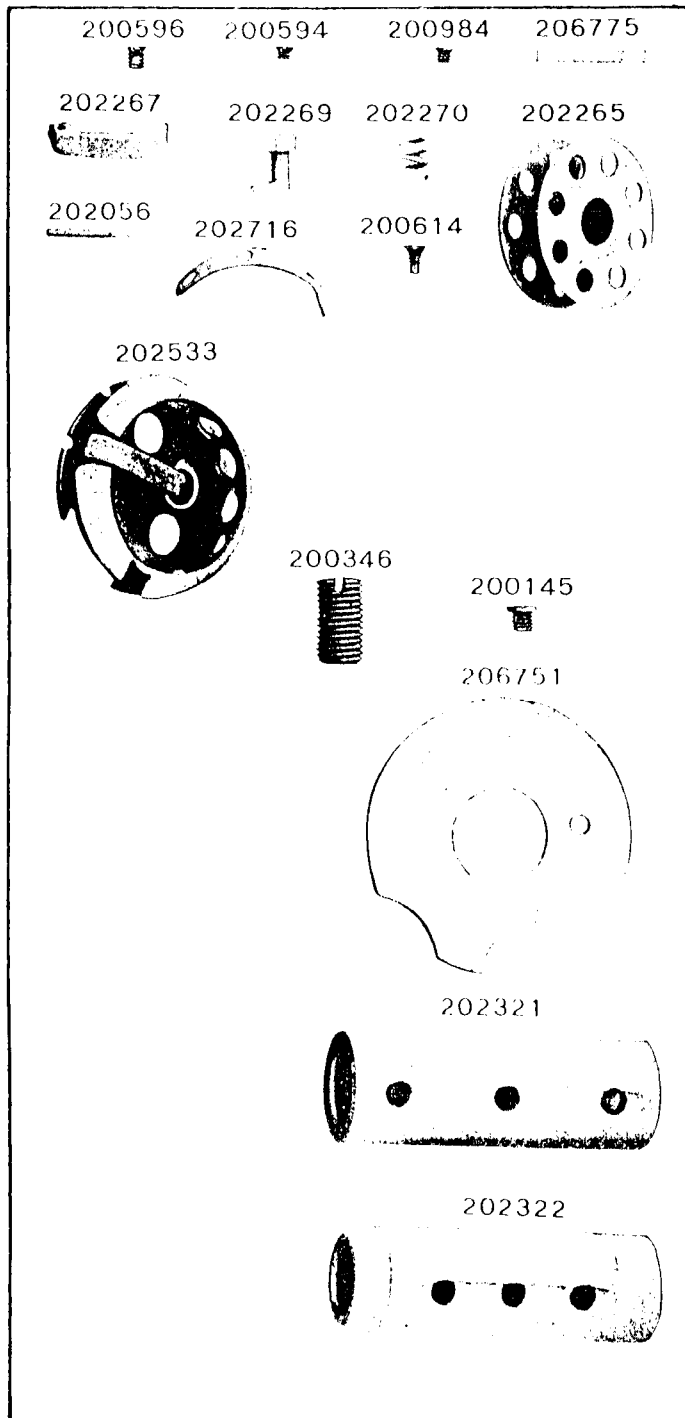

PLATE 12153-ONE-HALF SIZE

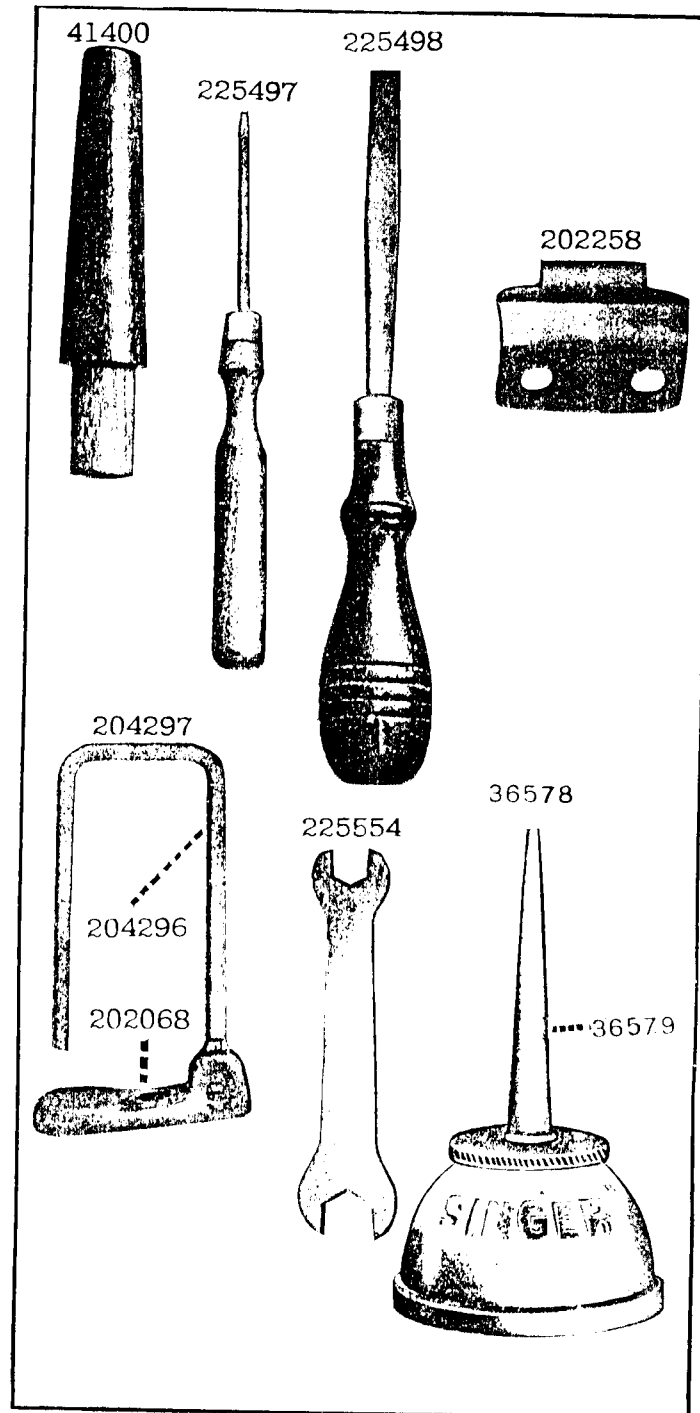

PLATE 13351—ONE-HALF SIZE

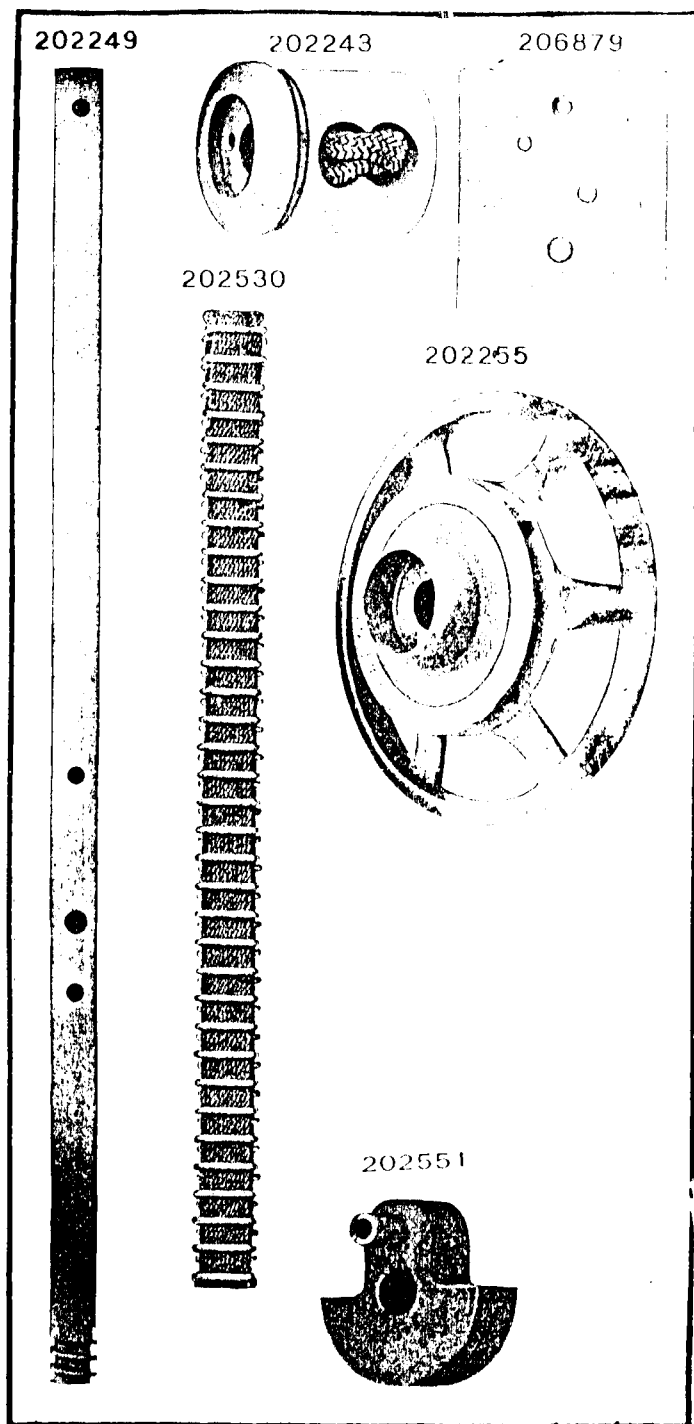

PLATE 13352—ONE-HALF SIZE

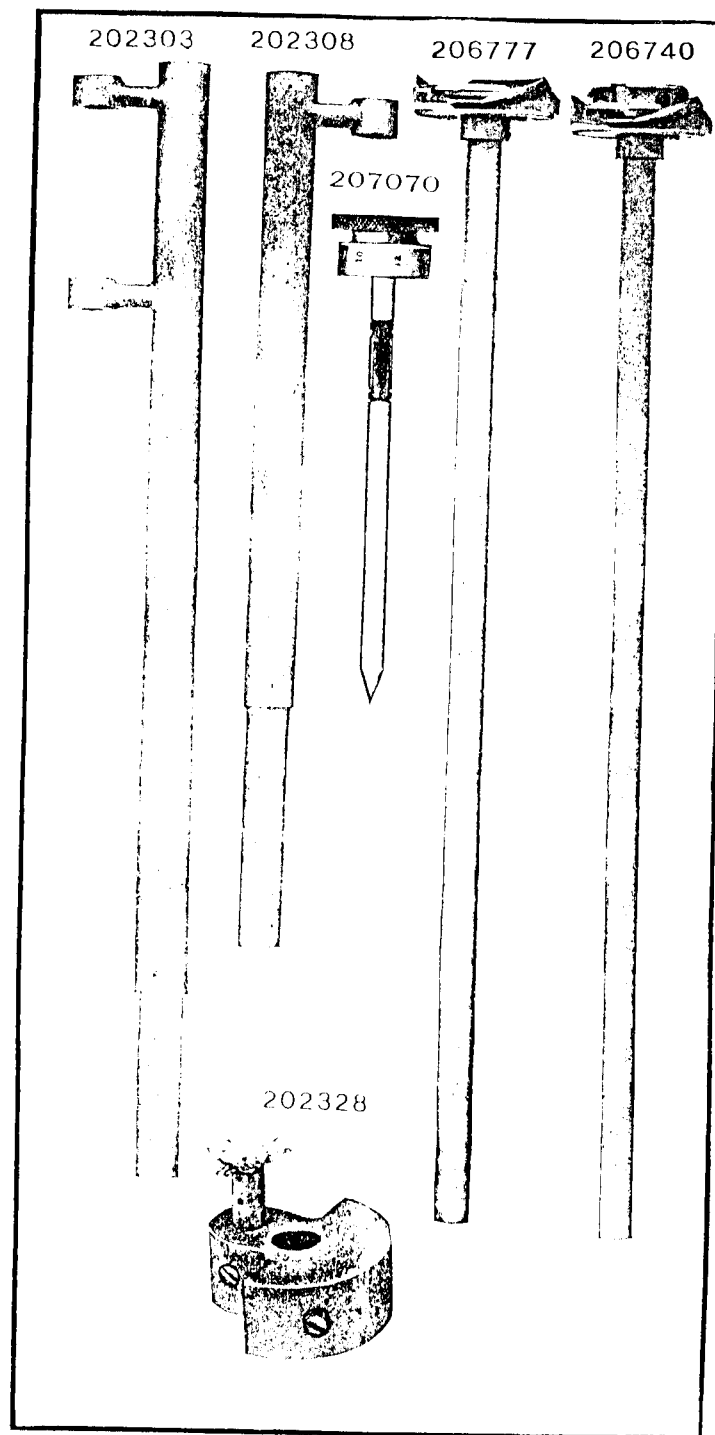

PLATE 13353-FULL SIZE

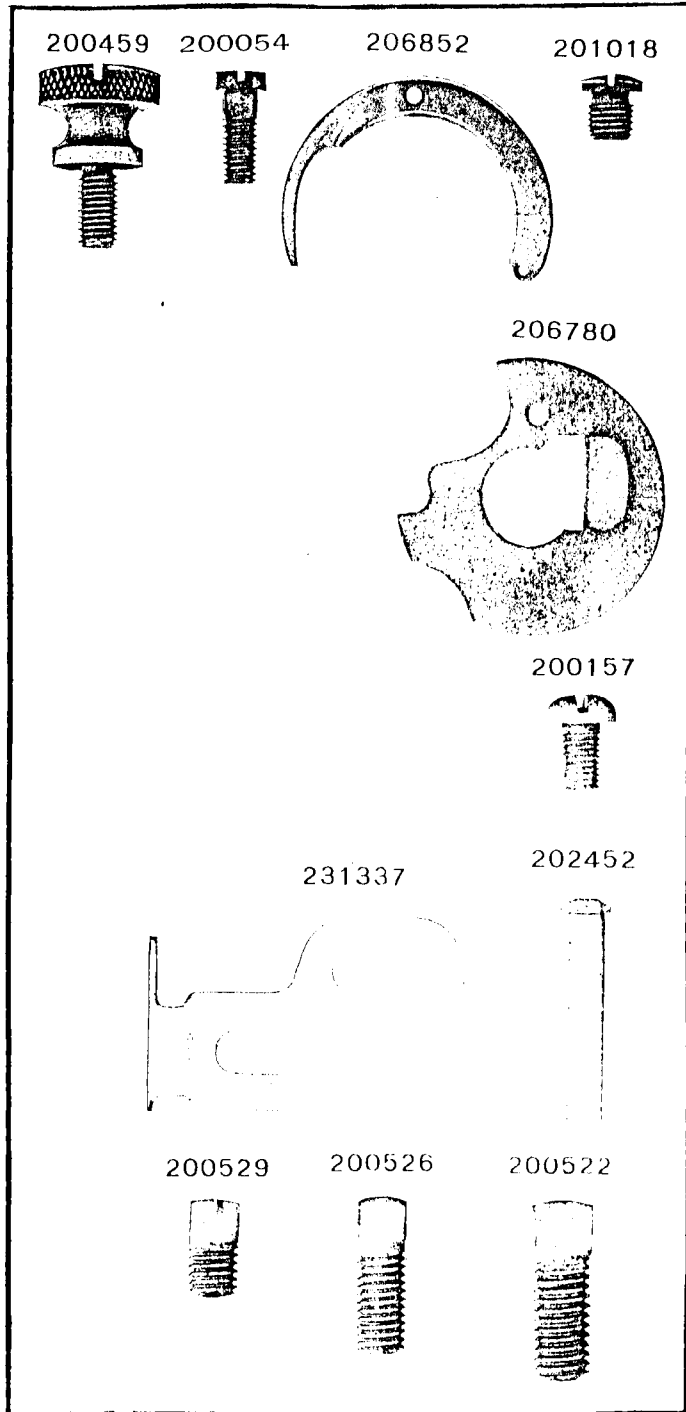

PLATE 13365-ONE-FOURTH SIZE

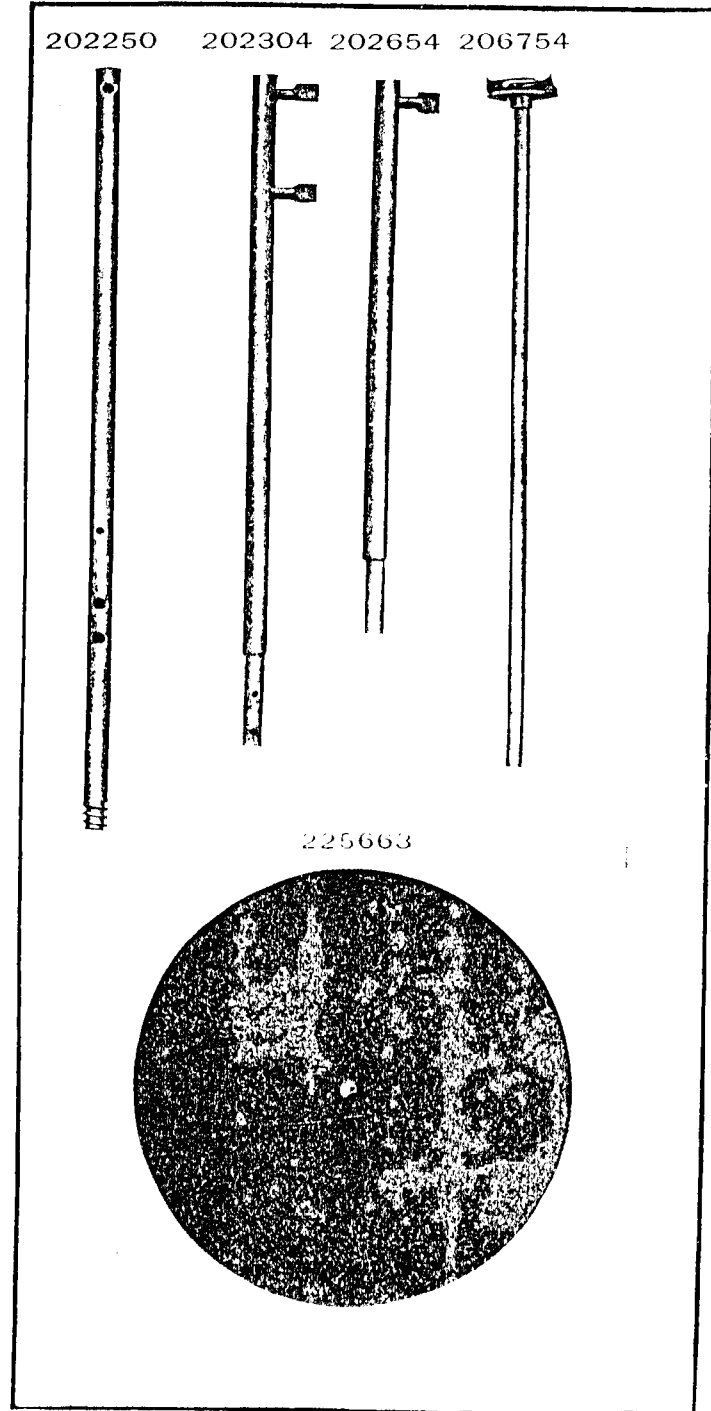

PLATE 13366-FULL SIZE

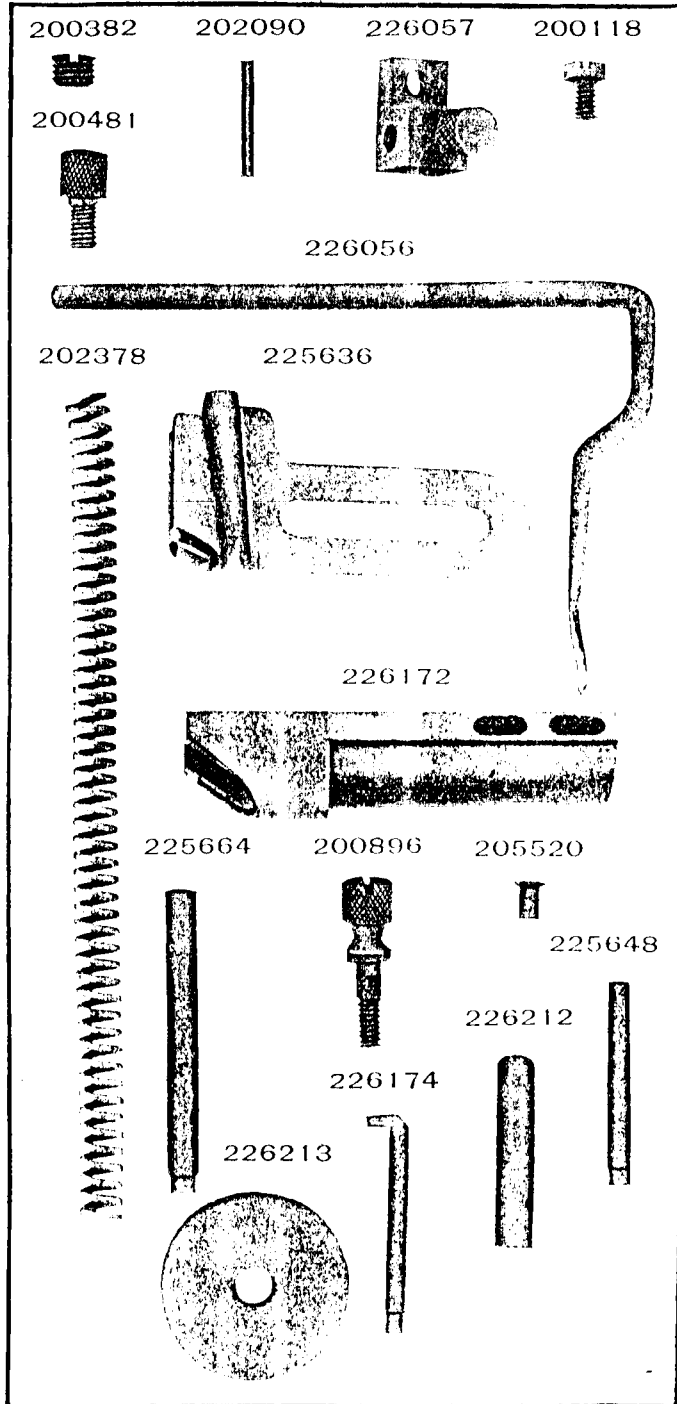

PLATE 13367-FULL SIZE

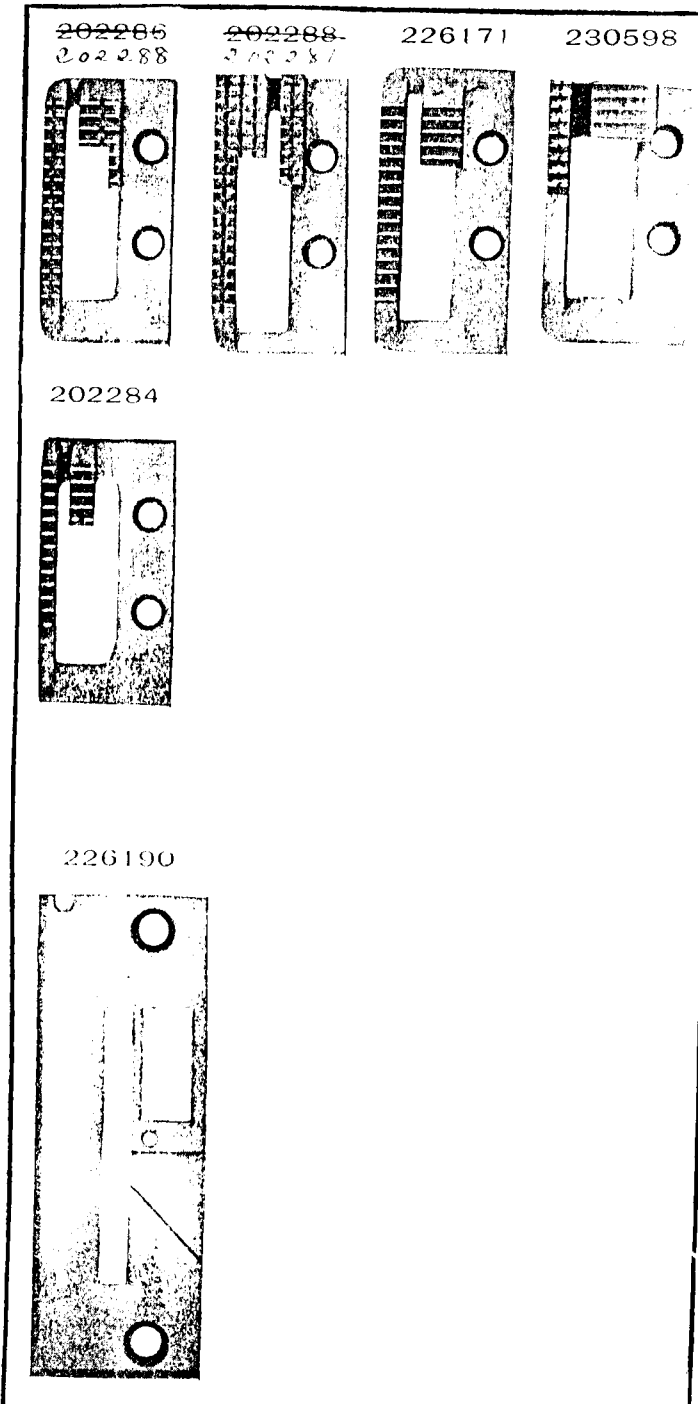
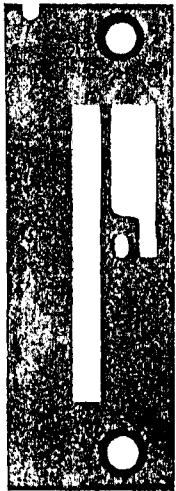
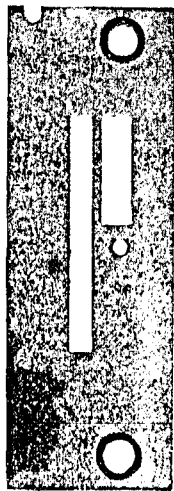

PLATE 13368-FULL SIZE

202826



202812



202821

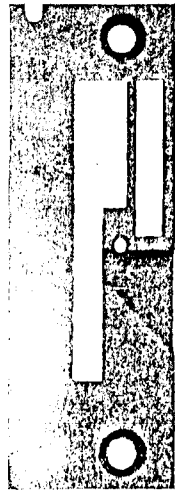

202823

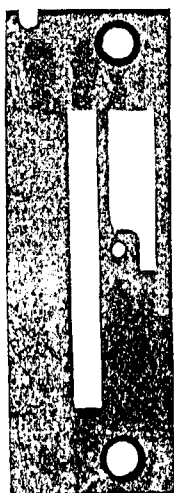

203102

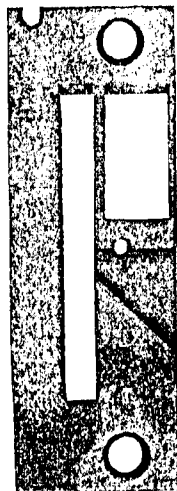

203193

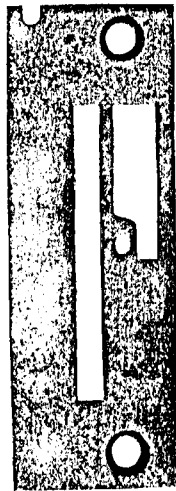
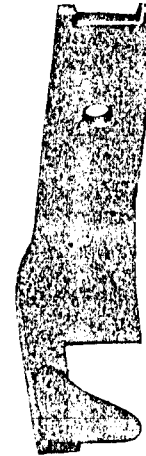

PLATE 13369-FULL SIZE

229867



207024



206830

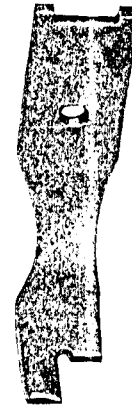

206832



206998



200543





PLATE 13370-ONE-HALF SIZE

226173

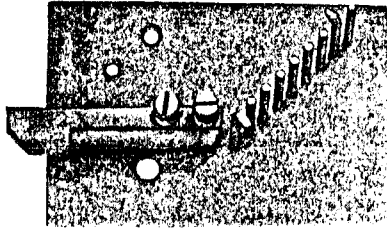

230650

